

6399 + 6347 A

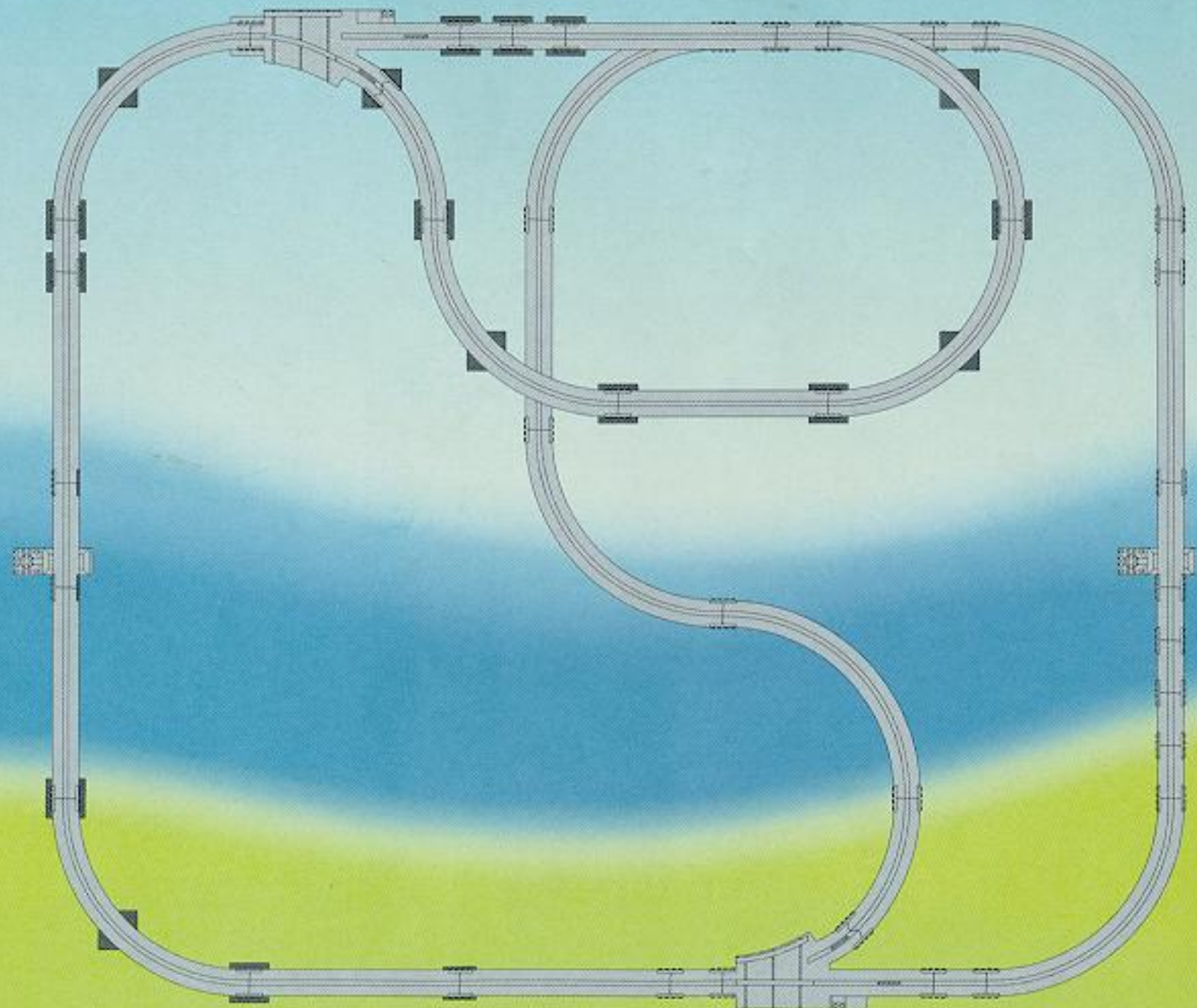

6399 + 6347

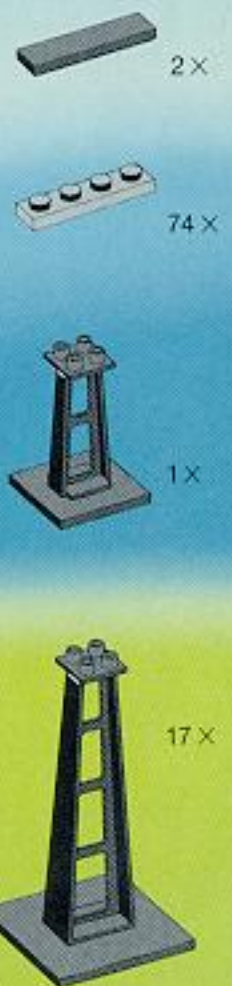
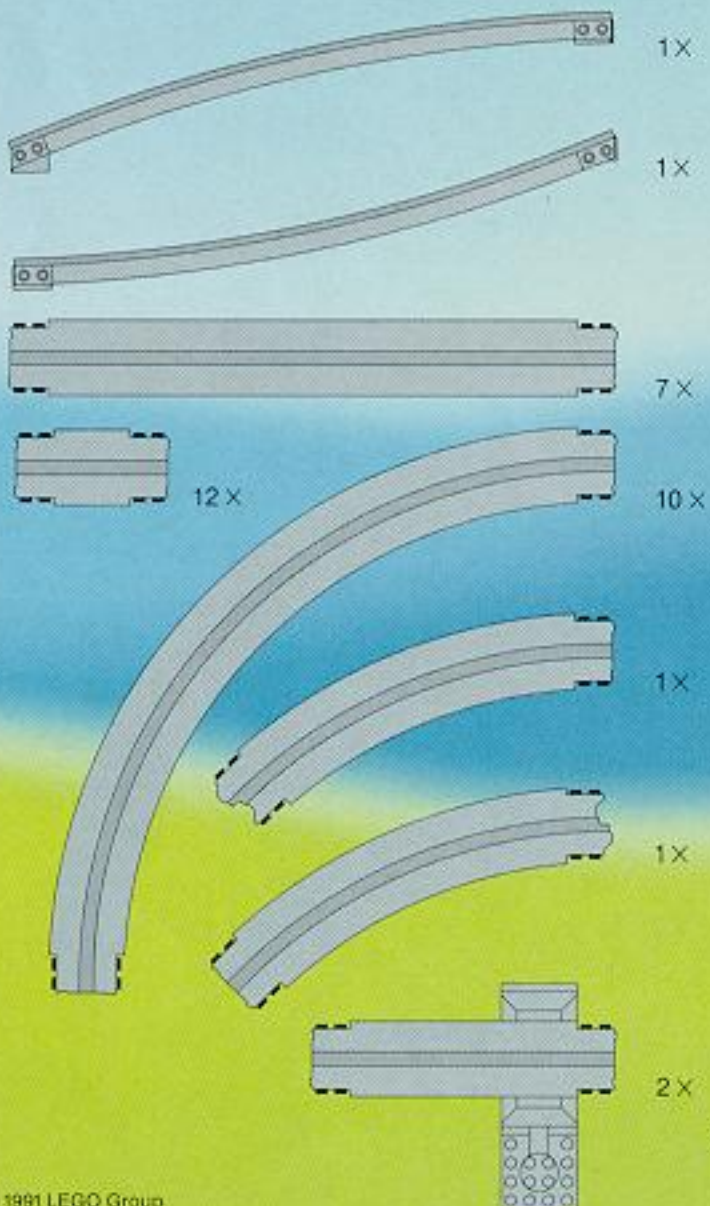
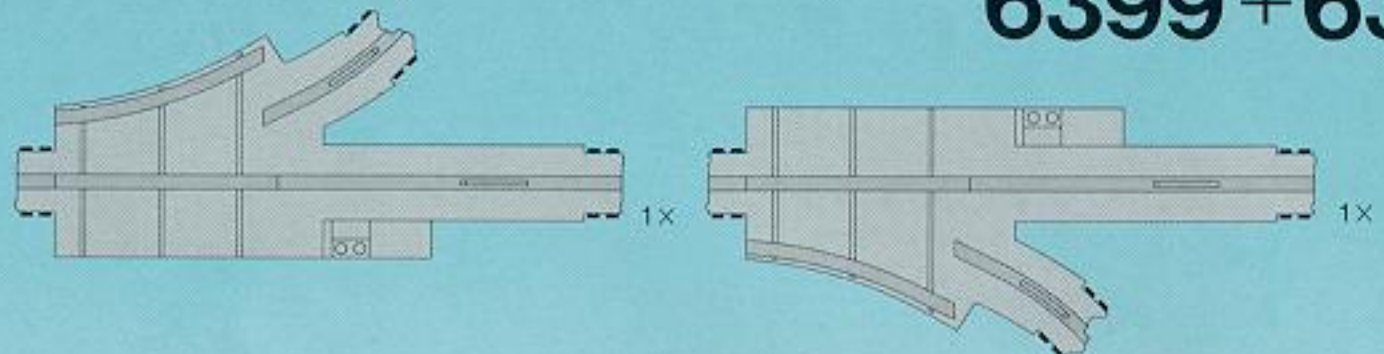

B

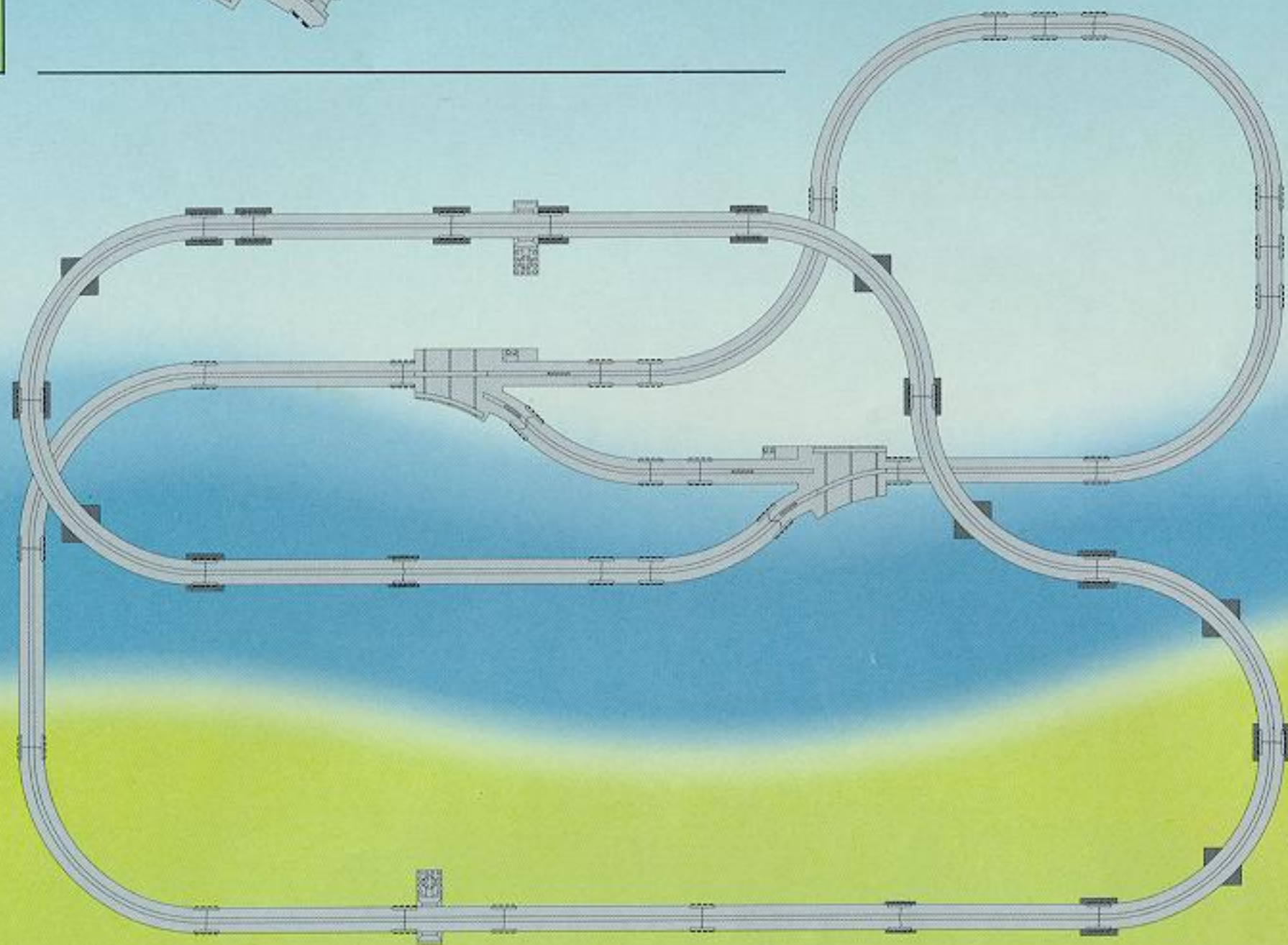
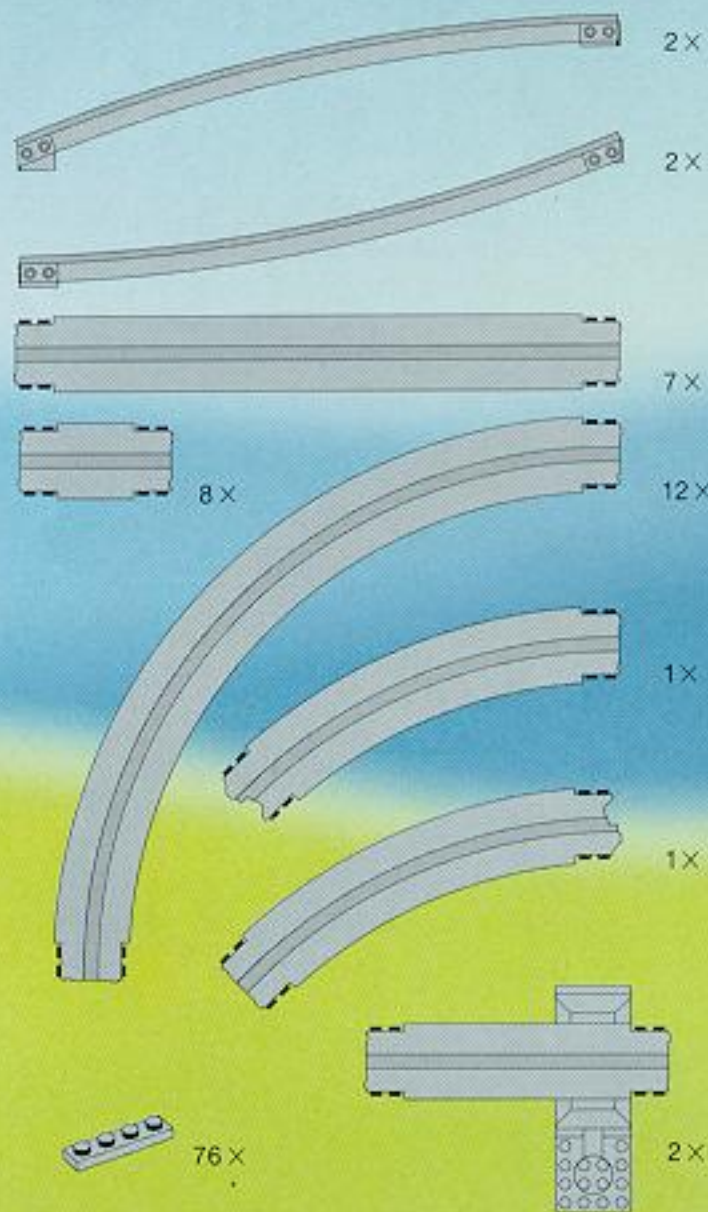
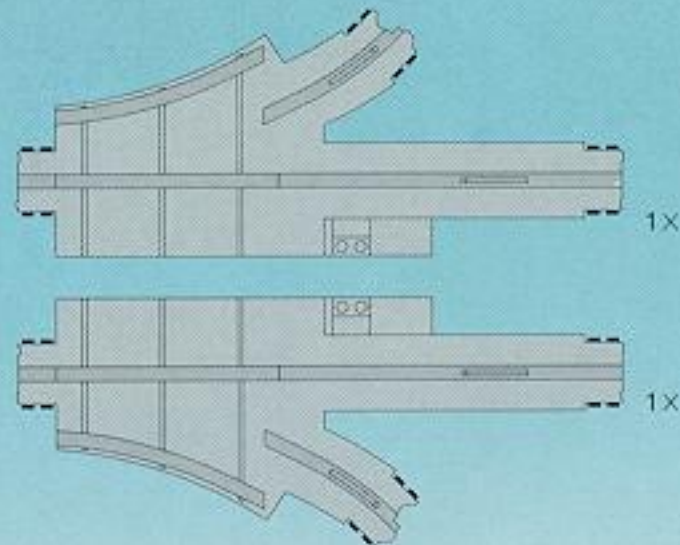
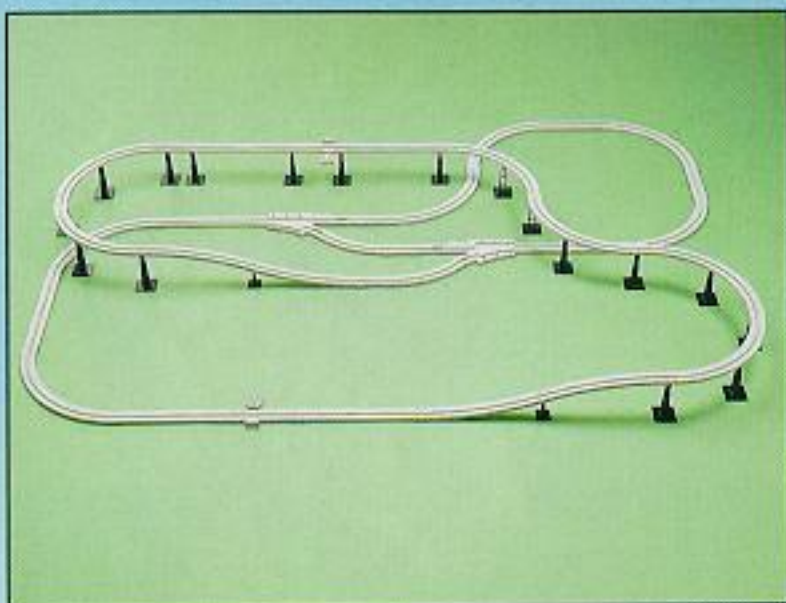



C

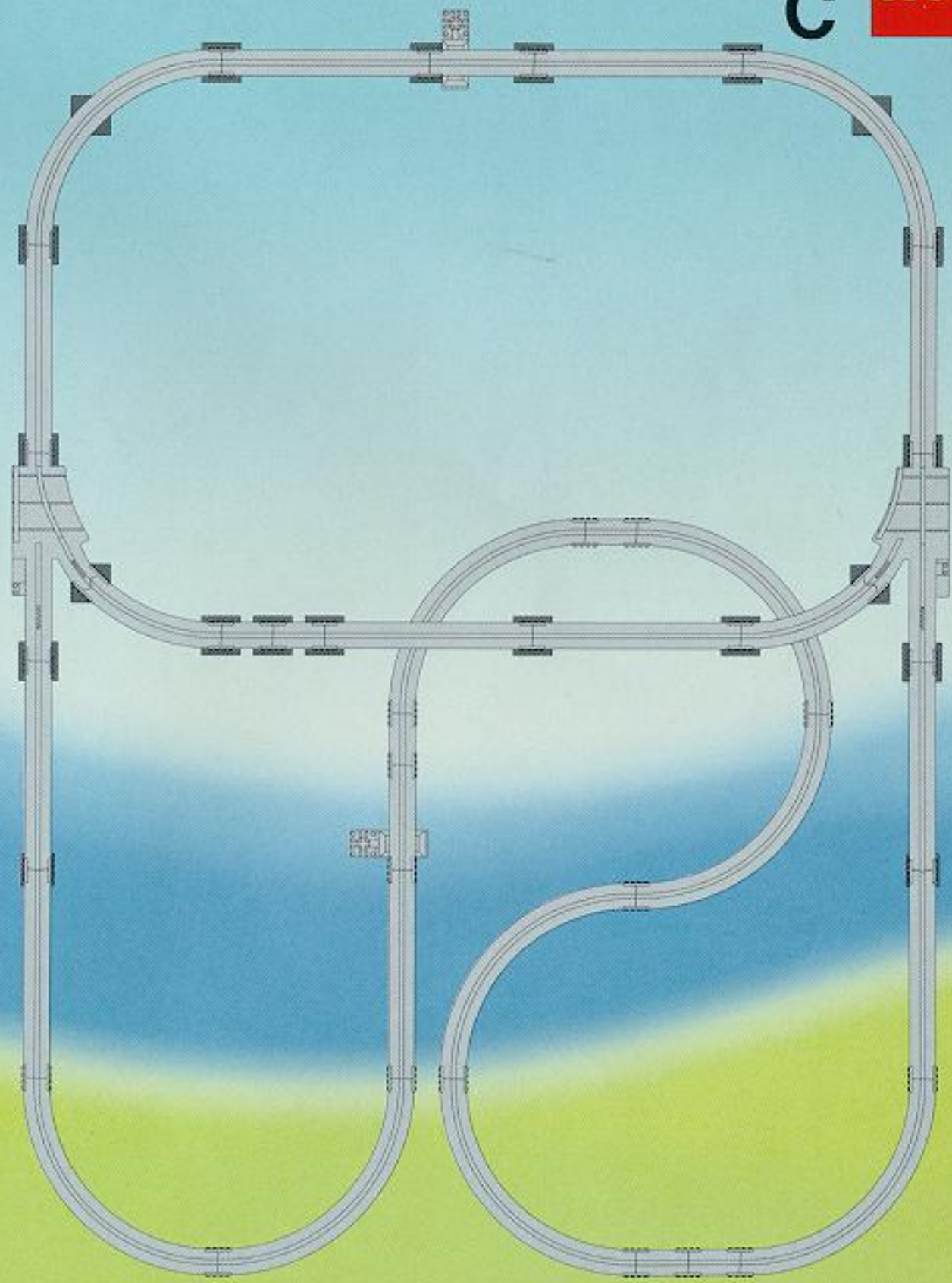
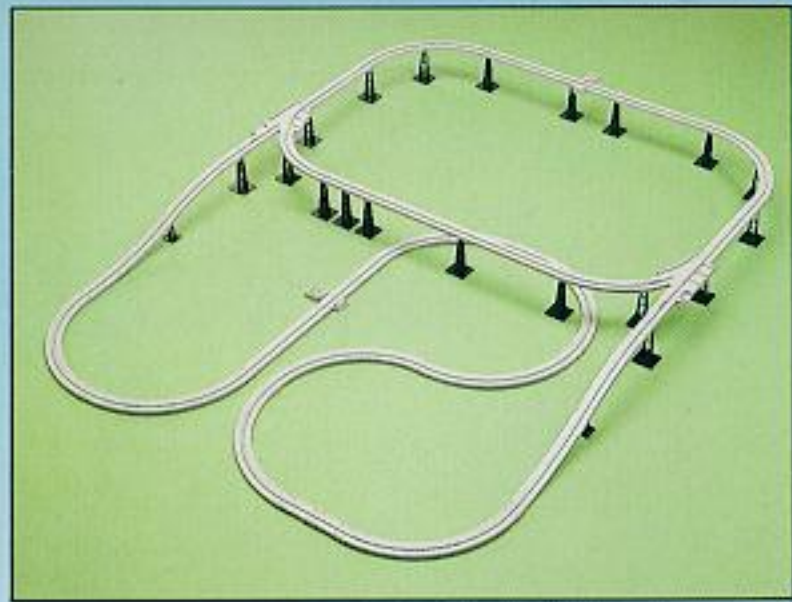

- 2x [curved track piece]
- 2x [curved track piece]
- 7x [straight track piece]
- 6x [short straight track piece]
- 10x [curved track piece]
- 1x [curved track piece]
- 1x [curved track piece]
- 2x [T-junction piece]
- 68x [1x4 Technic brick]

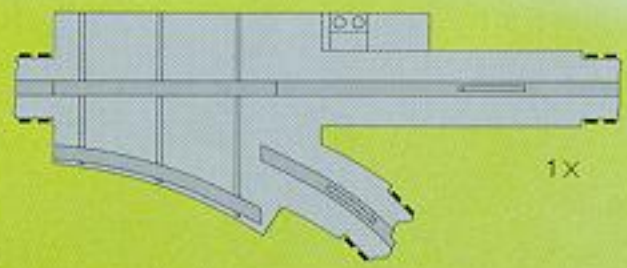
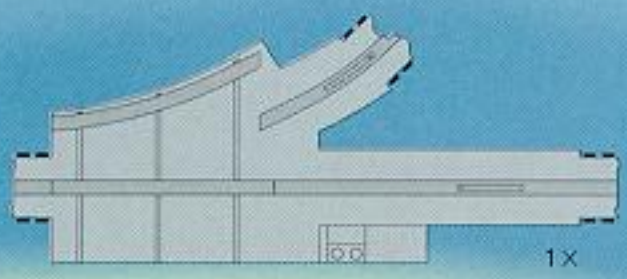
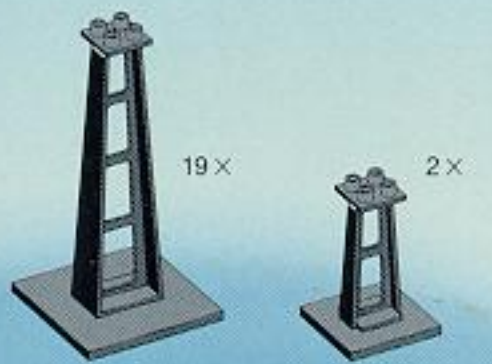



D

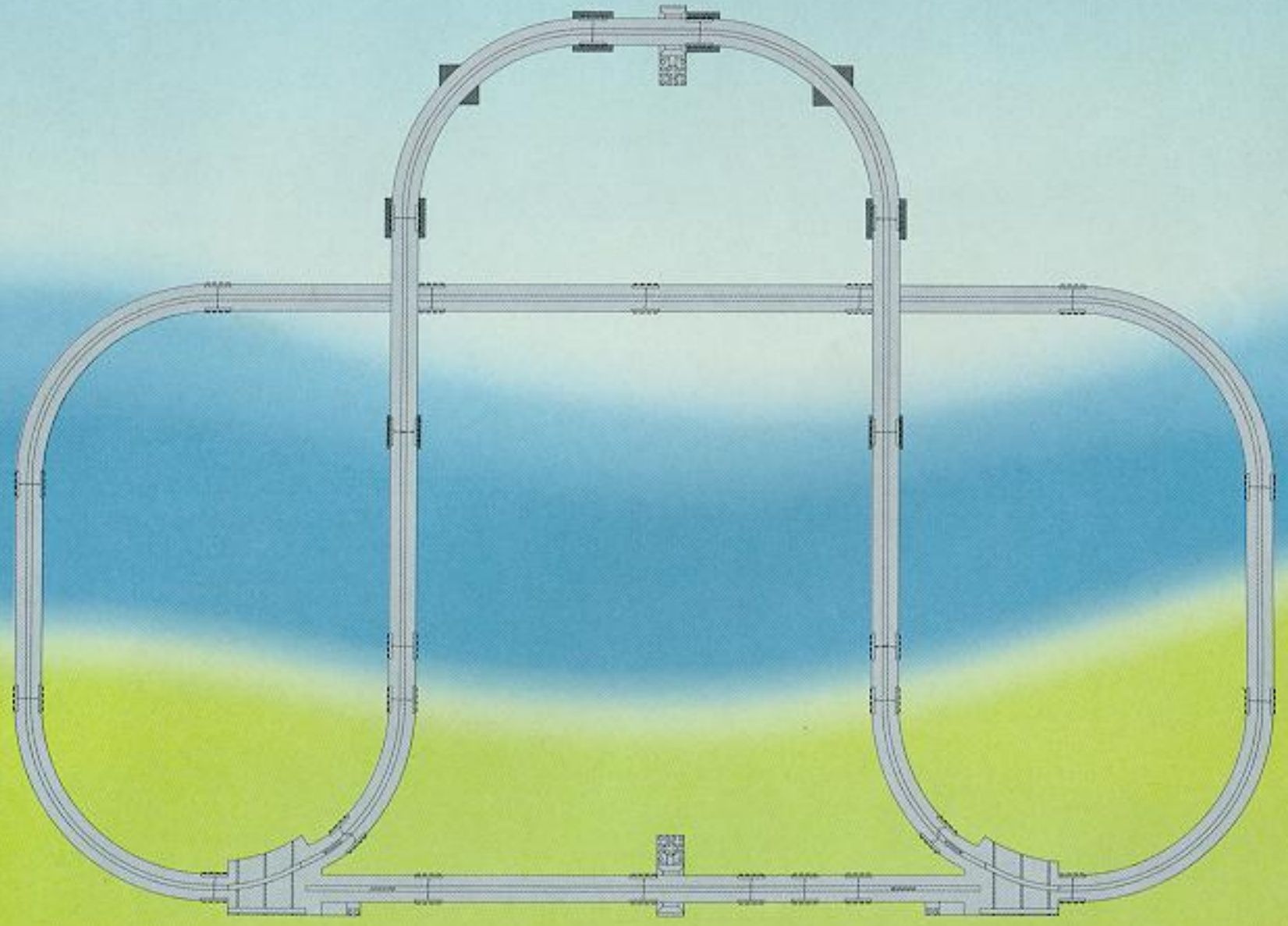
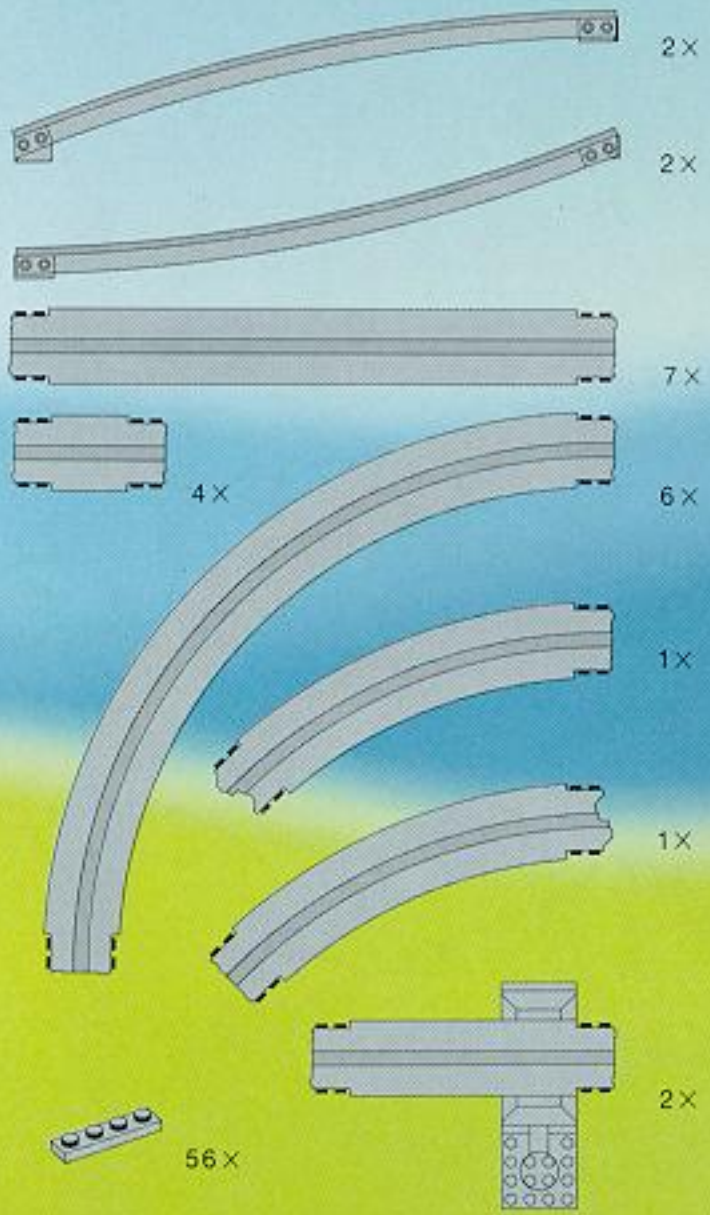
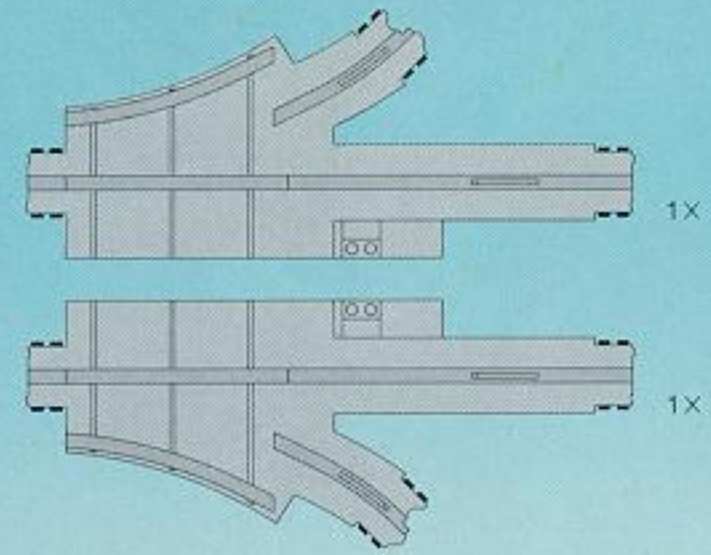
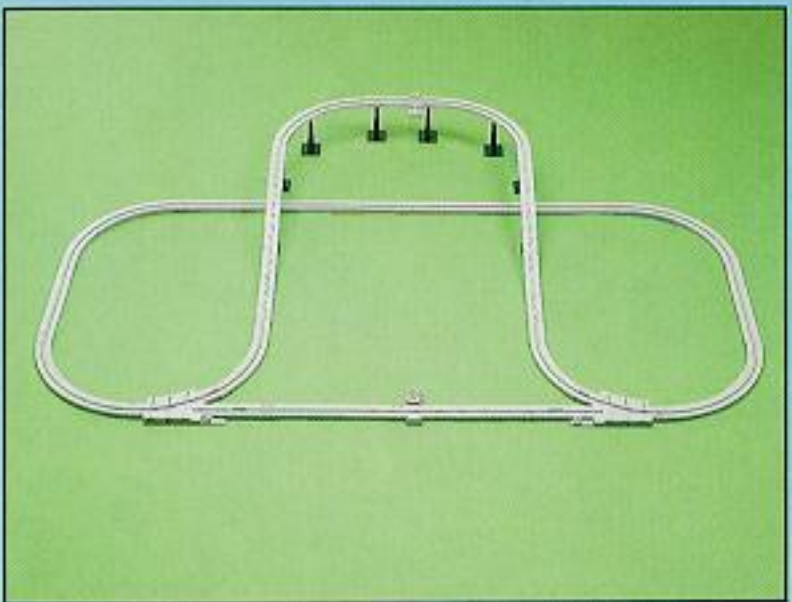

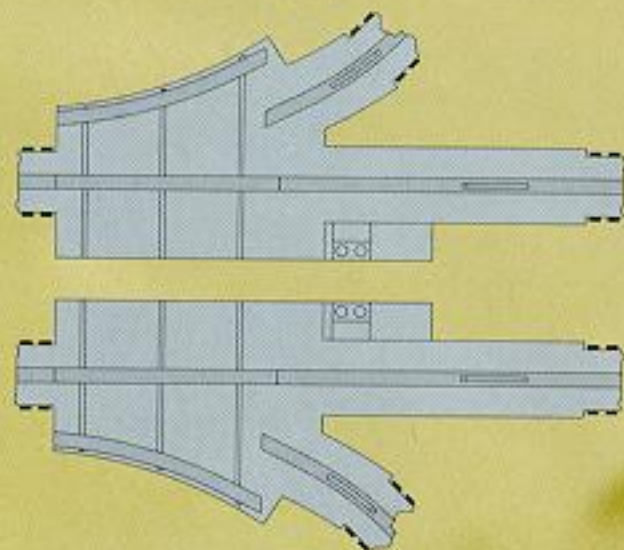
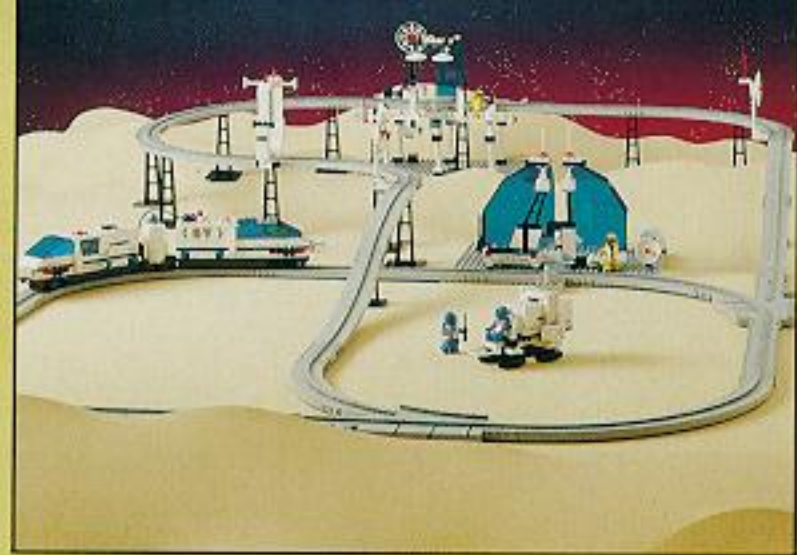

1X

1X



52X

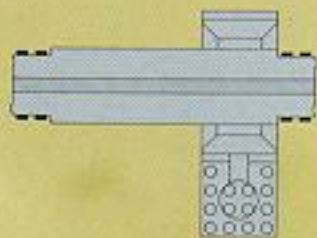

2X



10X



2X

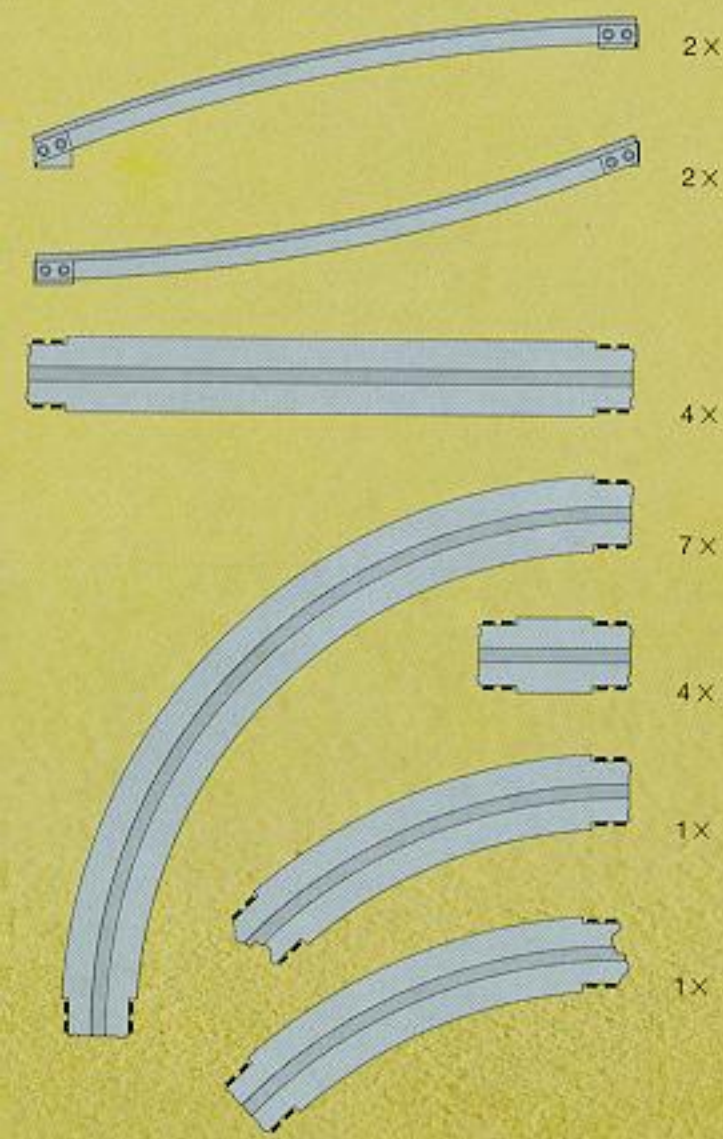

2X

2X

4X

7X

4X

1X

1X

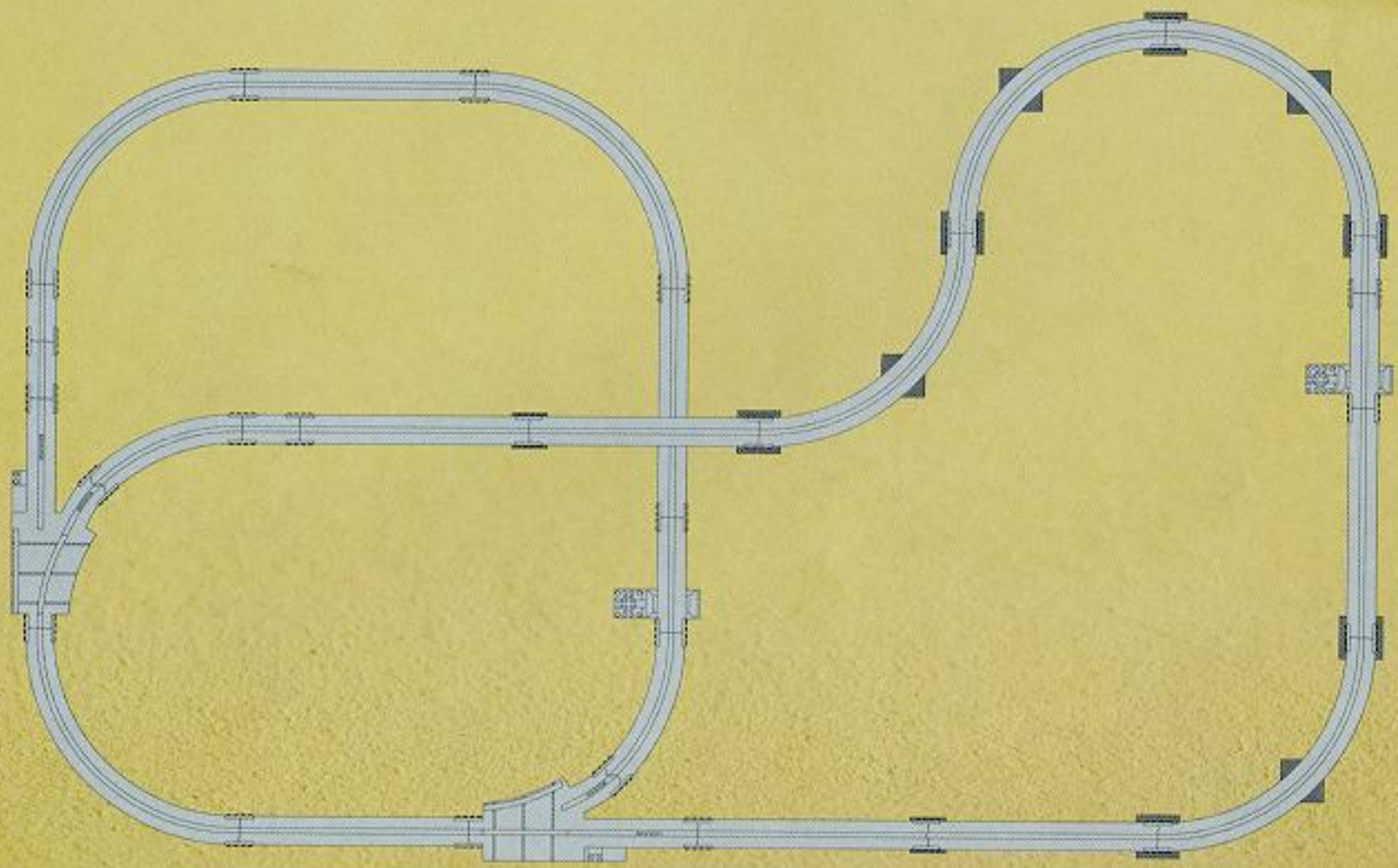



B

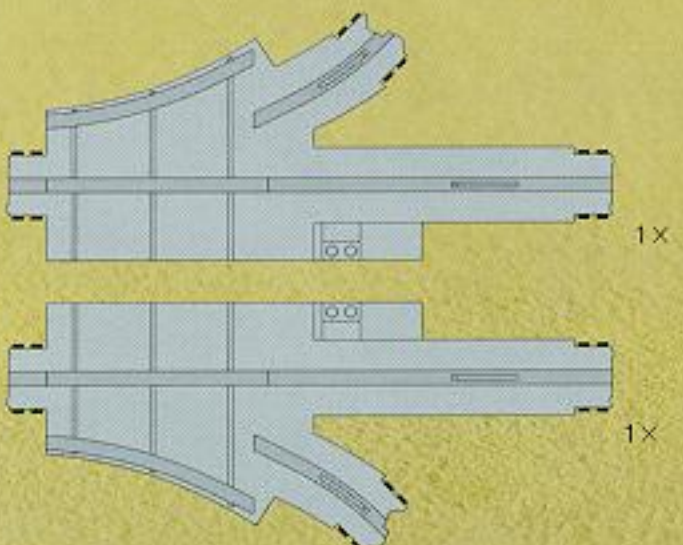
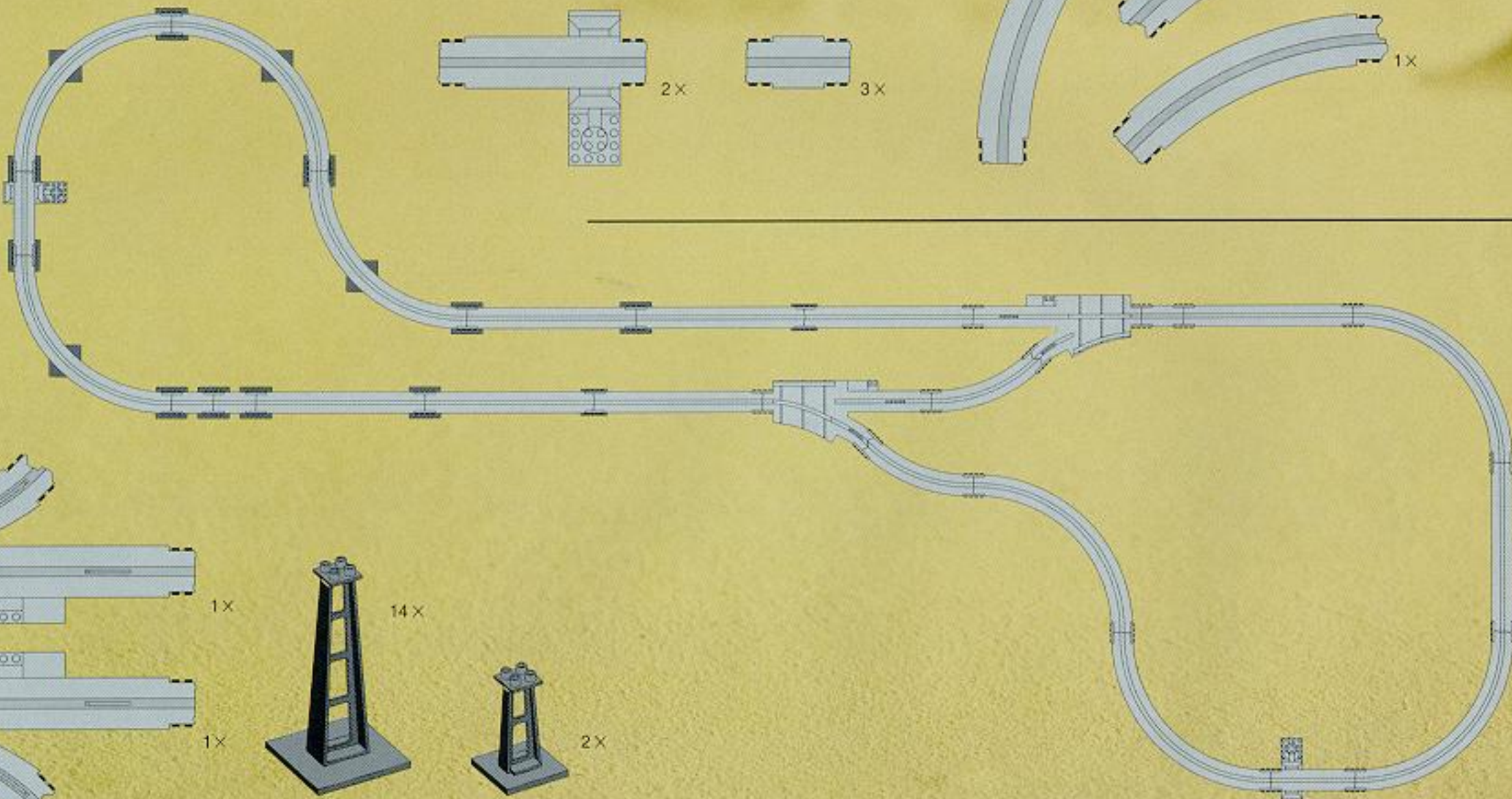
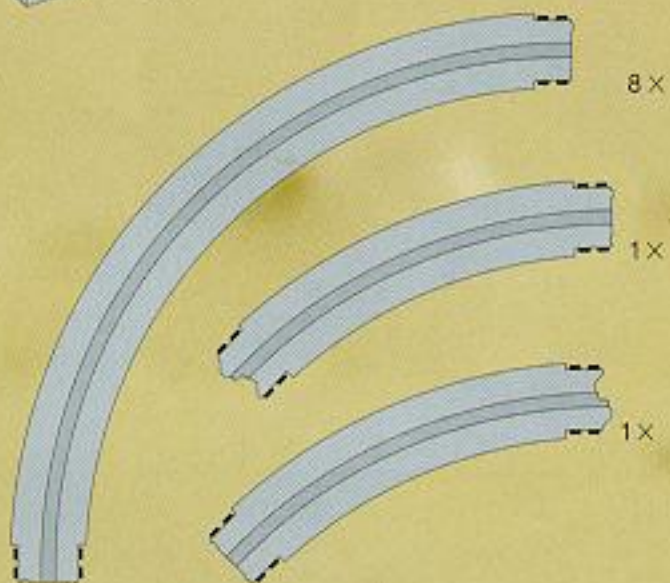
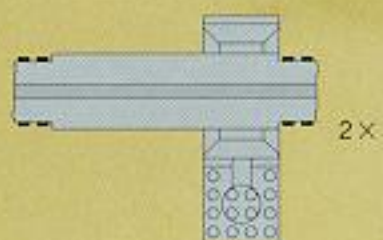
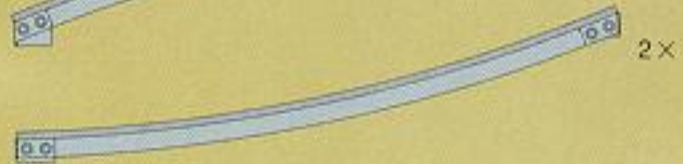
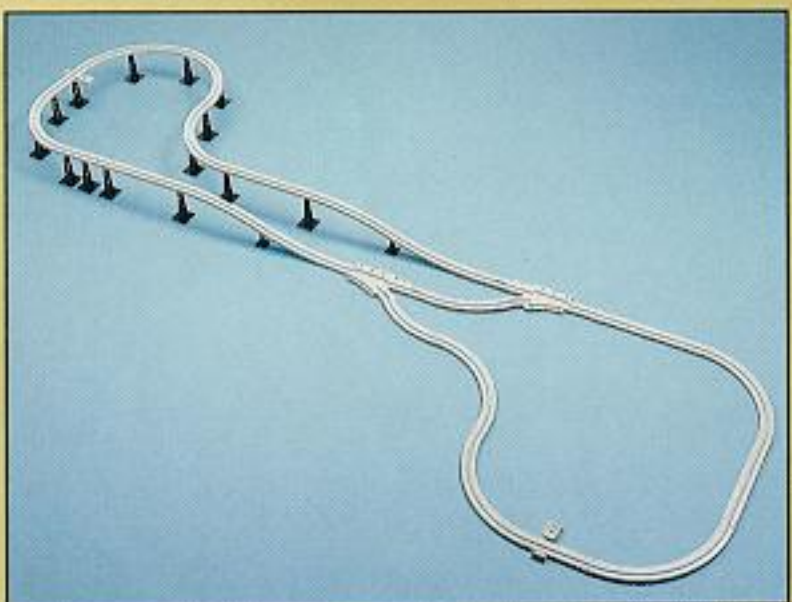

6990+6347



C

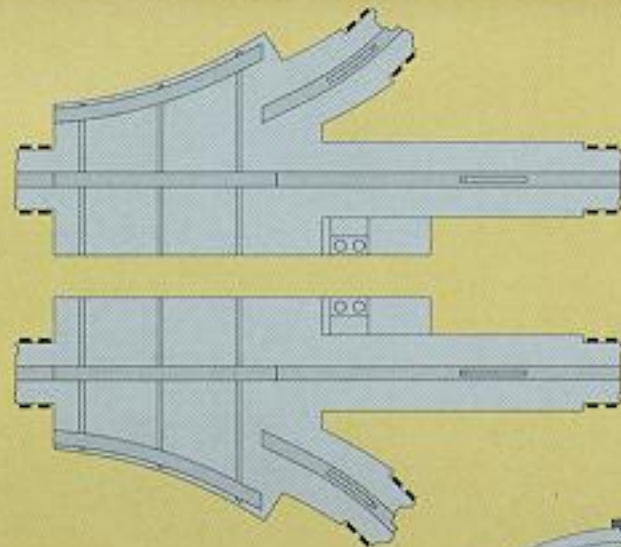
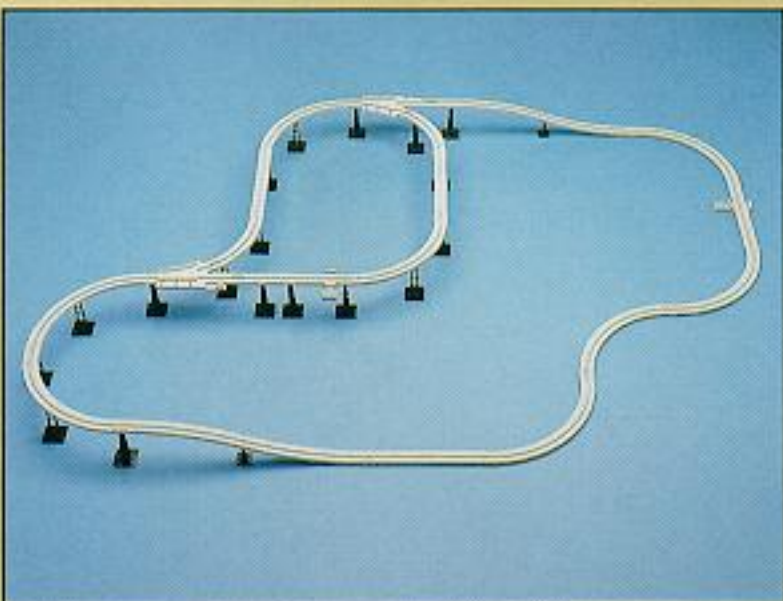

1X

1X



18X



2X

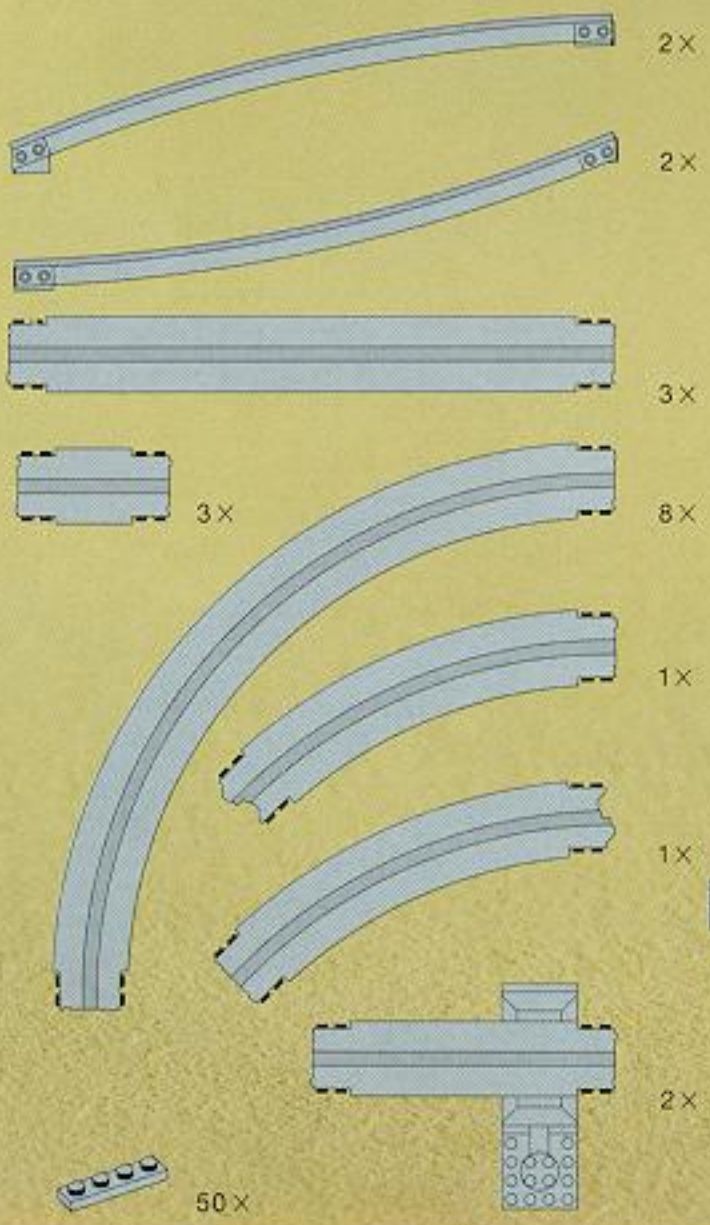

2X

2X

3X

3X

8X

1X

1X

2X

50X

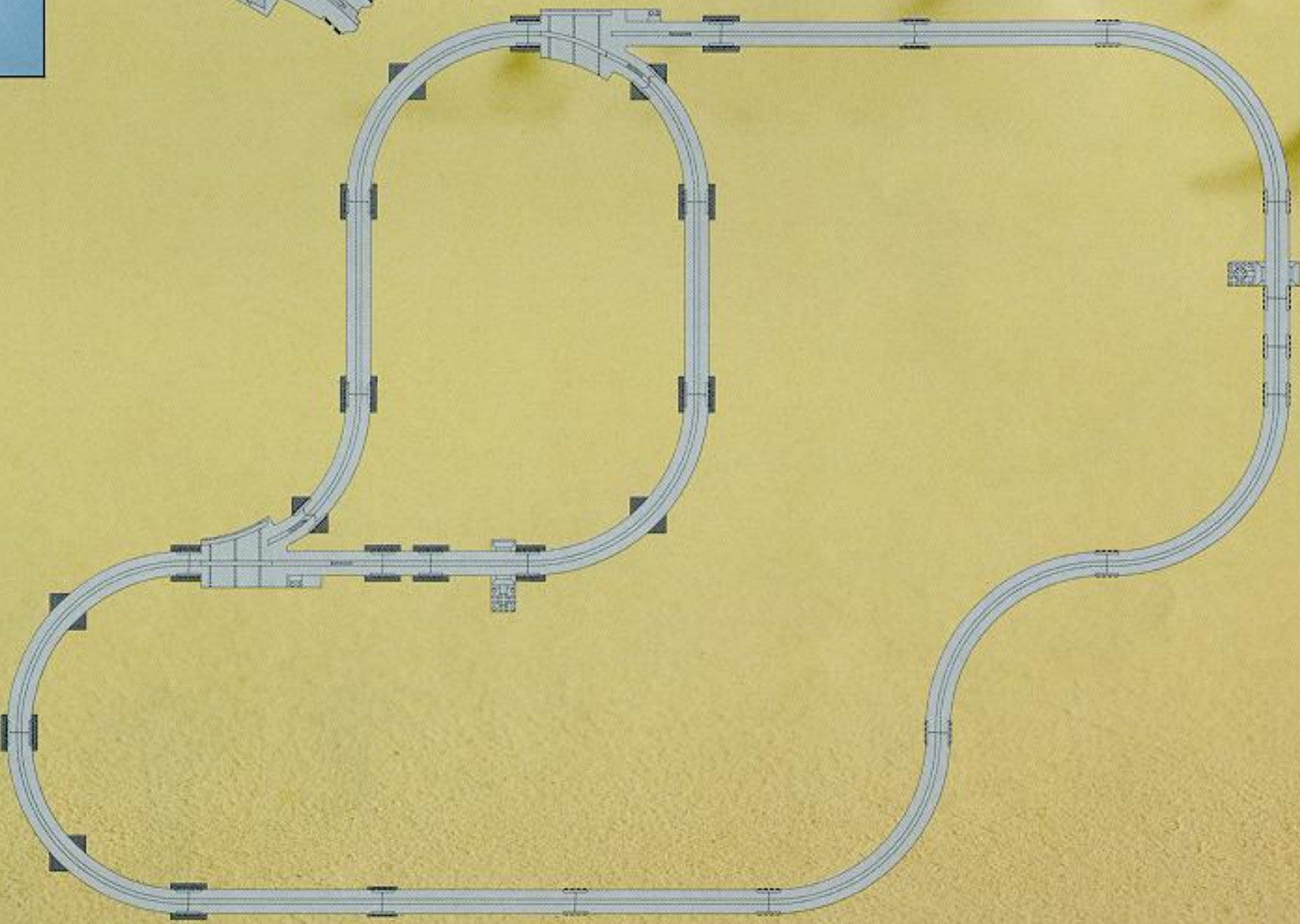

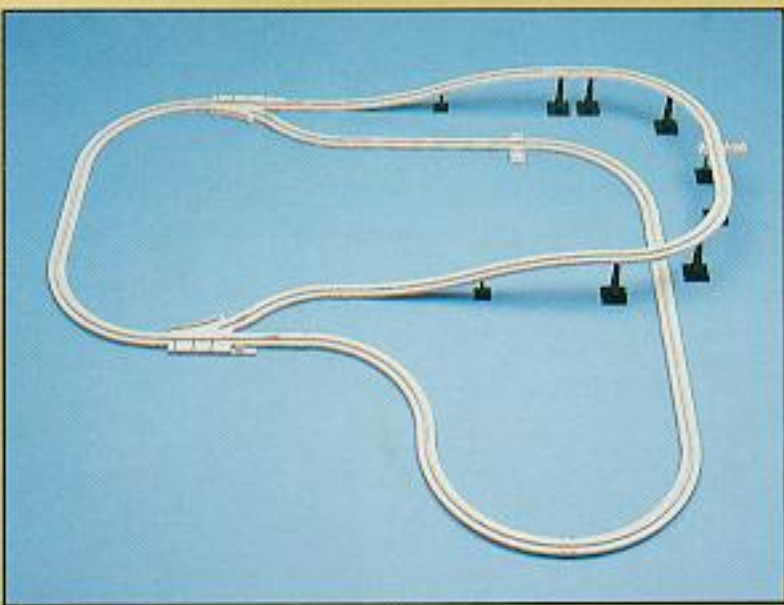





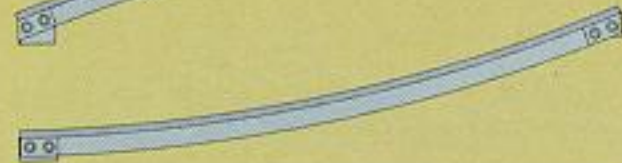

7x

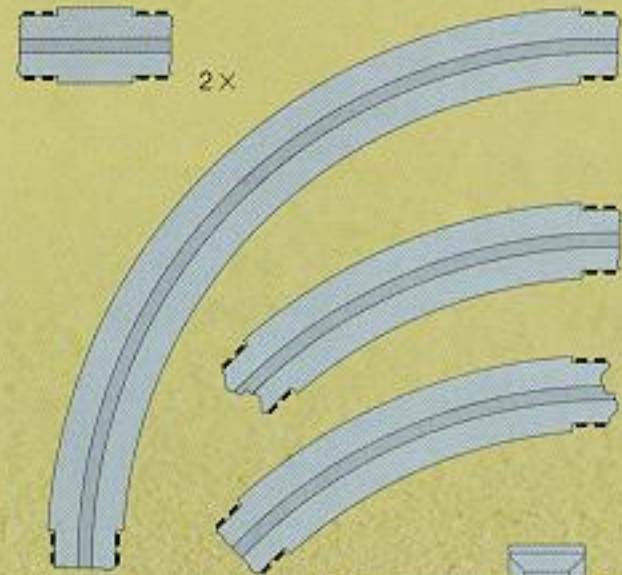

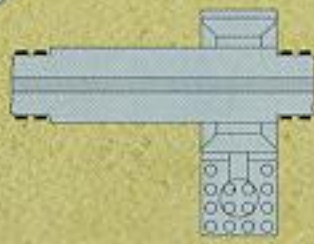
2x

-  2x
-  2x
-  4x
-  2x
-  8x
-  1x
-  1x
-  2x
-  50x

