



KNIGHTS' KINGDOM

8802





1x



2x



1x



1x



2x



2x



2x



1x



1x



3x



1x



2x



2x



5x



2x



1x



1x



16x



2x



2x



2x



2x



1x



1x



4x



3x

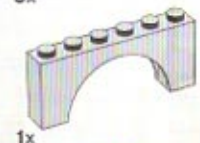

1x

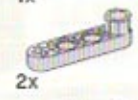

2x



2x

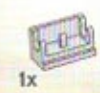

1x



2x



4x



3x



2x



1x

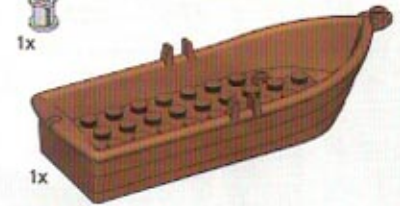

1x



1x

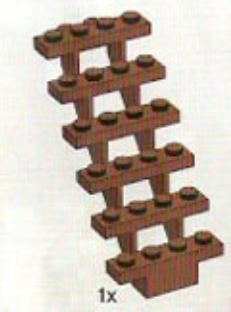

1x

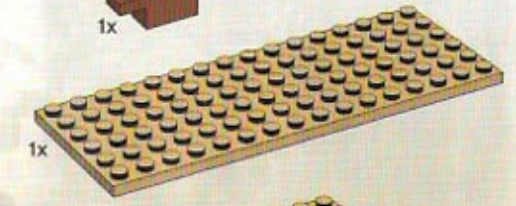

1x

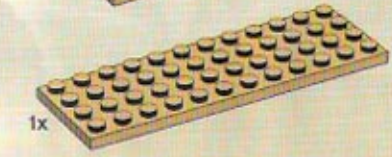

1x

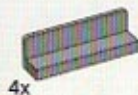
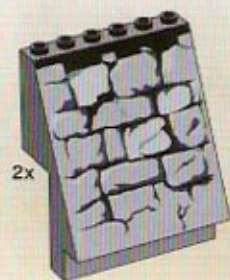
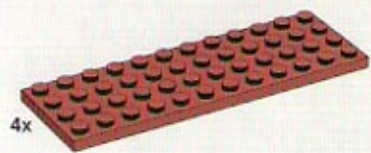

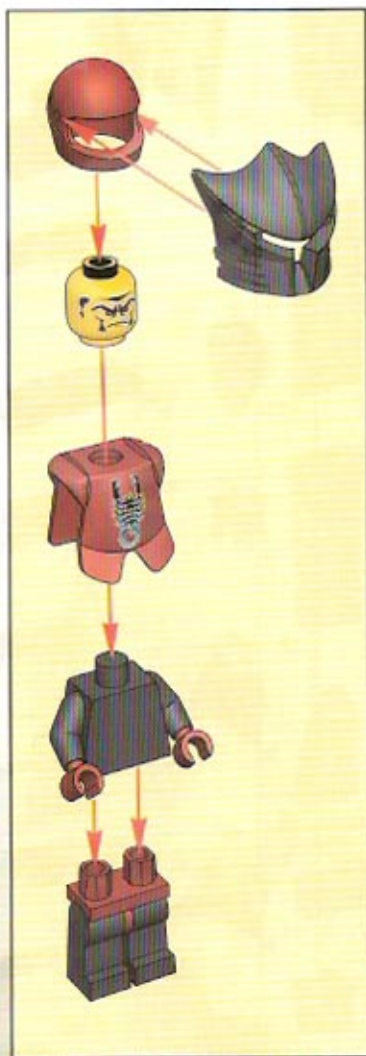



1

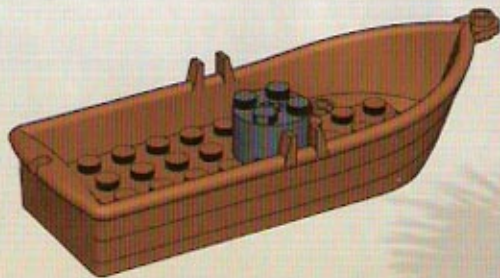

2

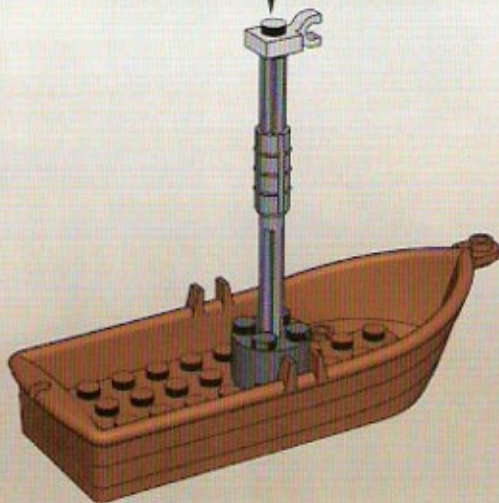
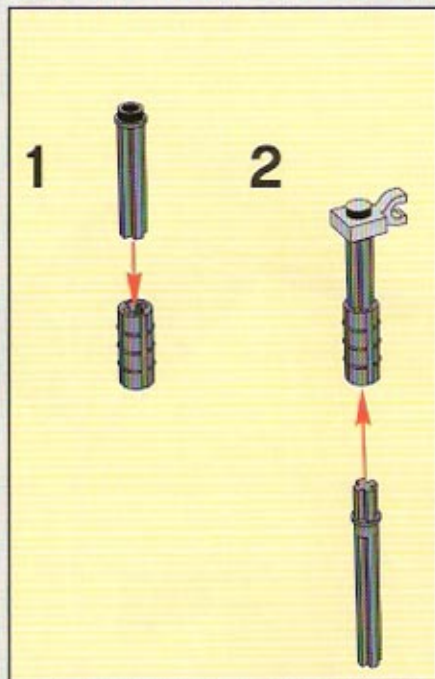



3



1

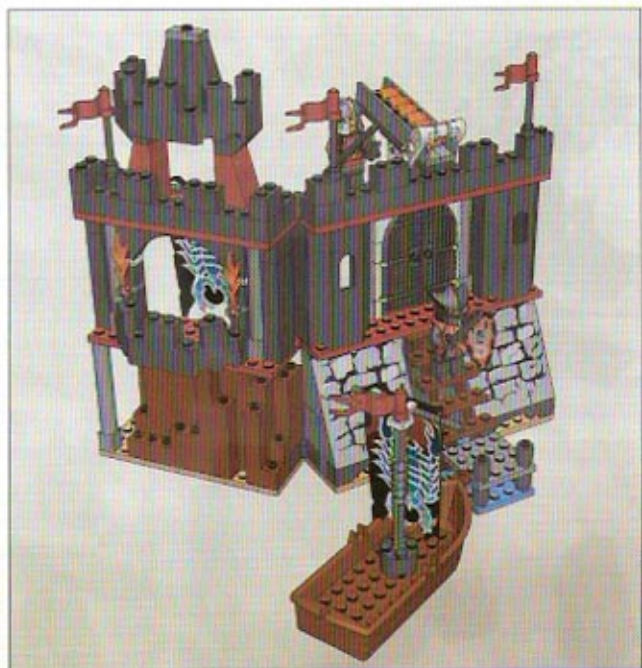
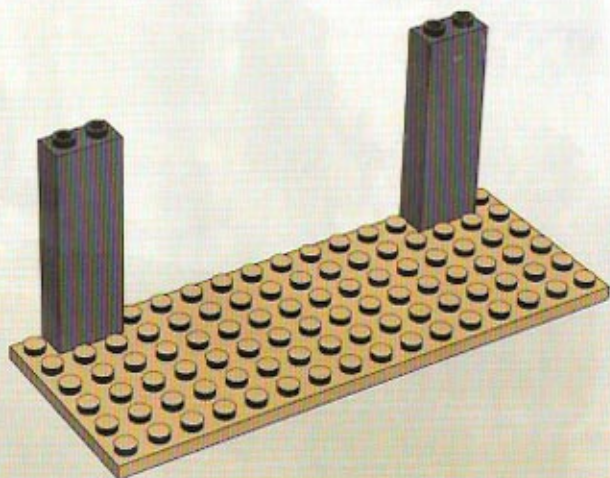

2

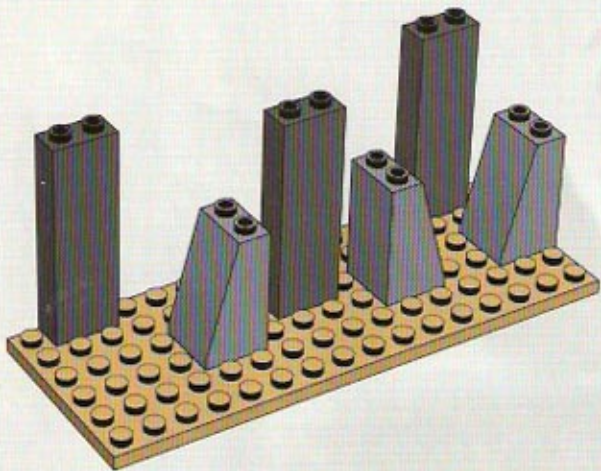

3

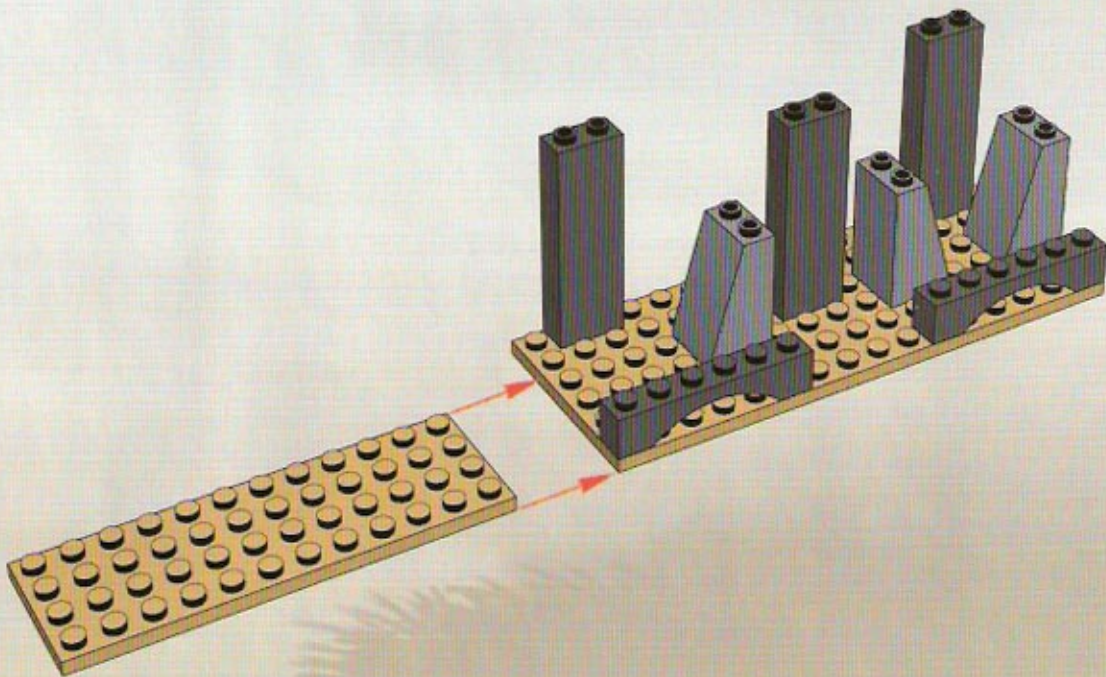

4

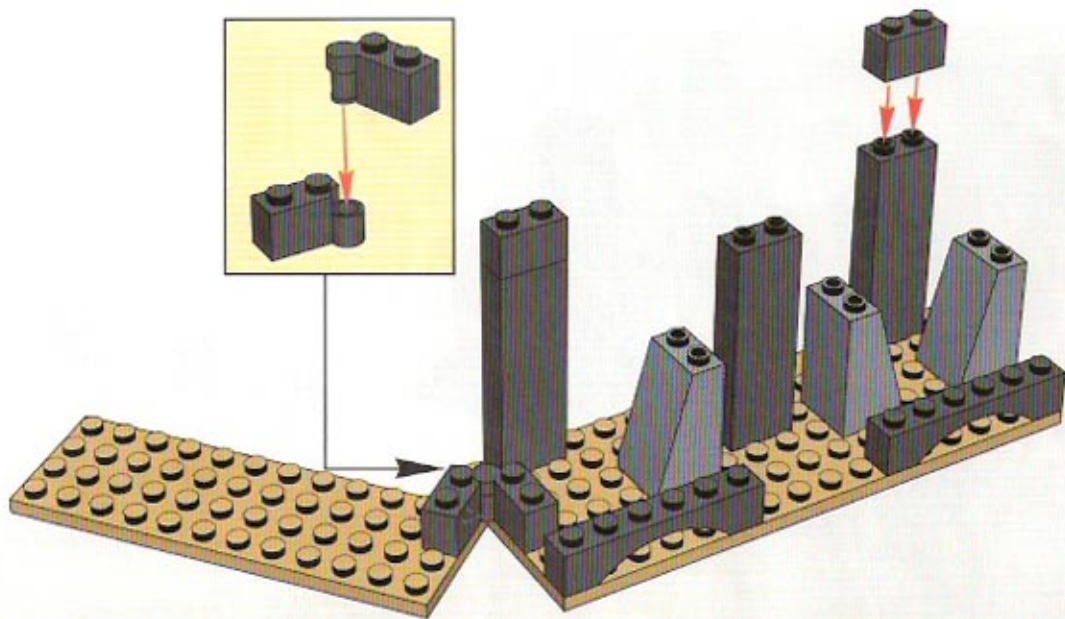

5

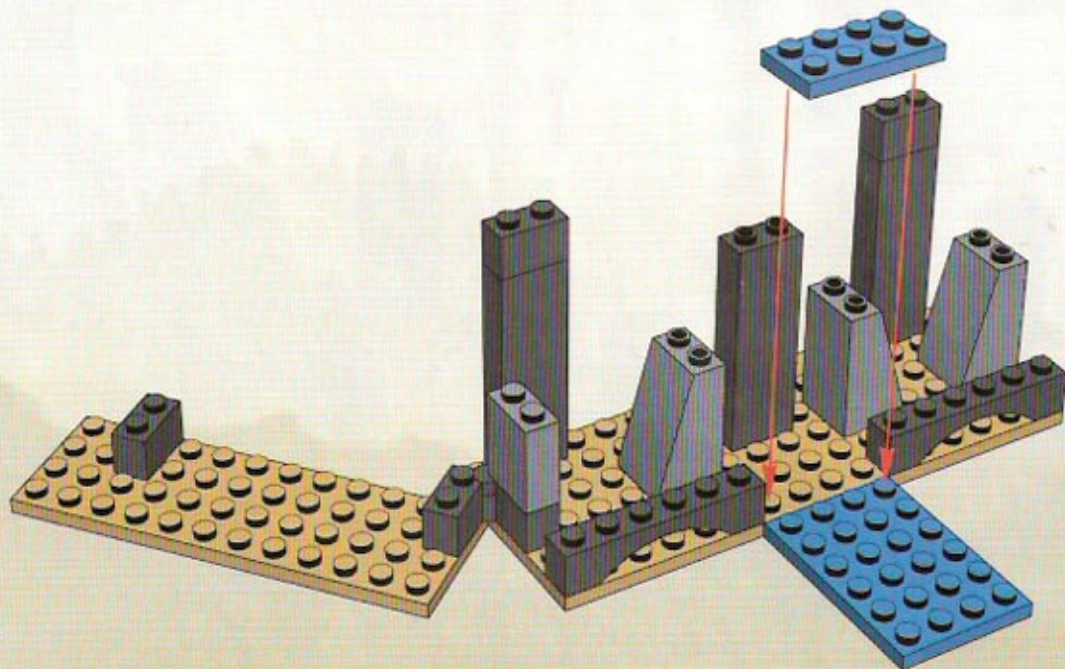

6

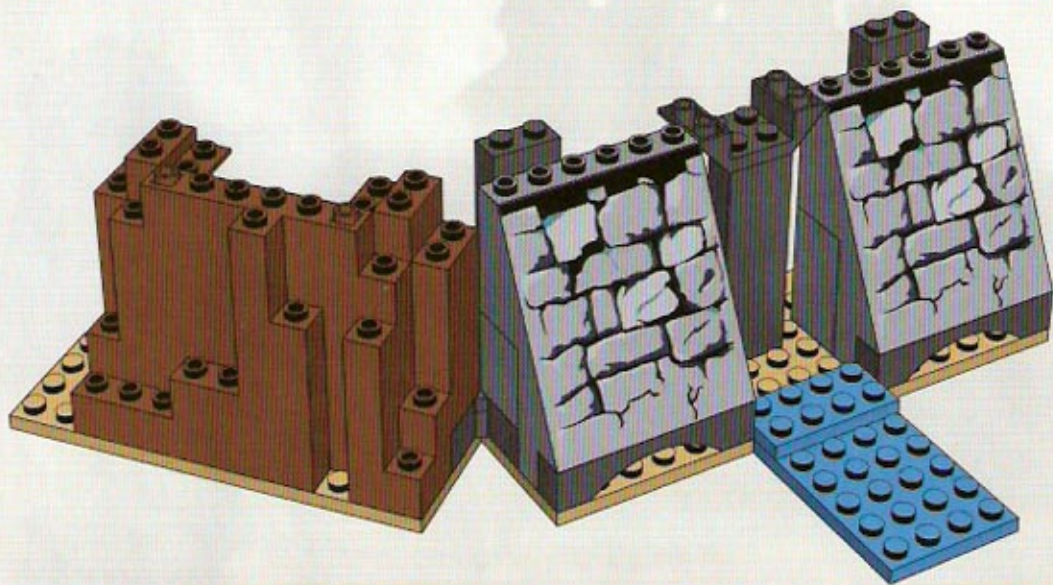

7

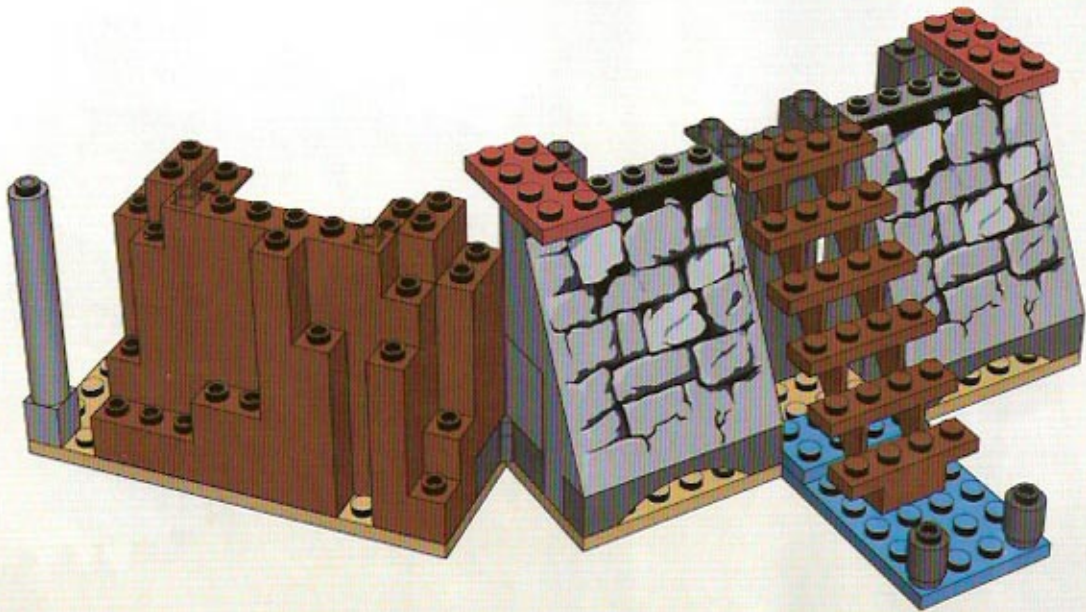

8

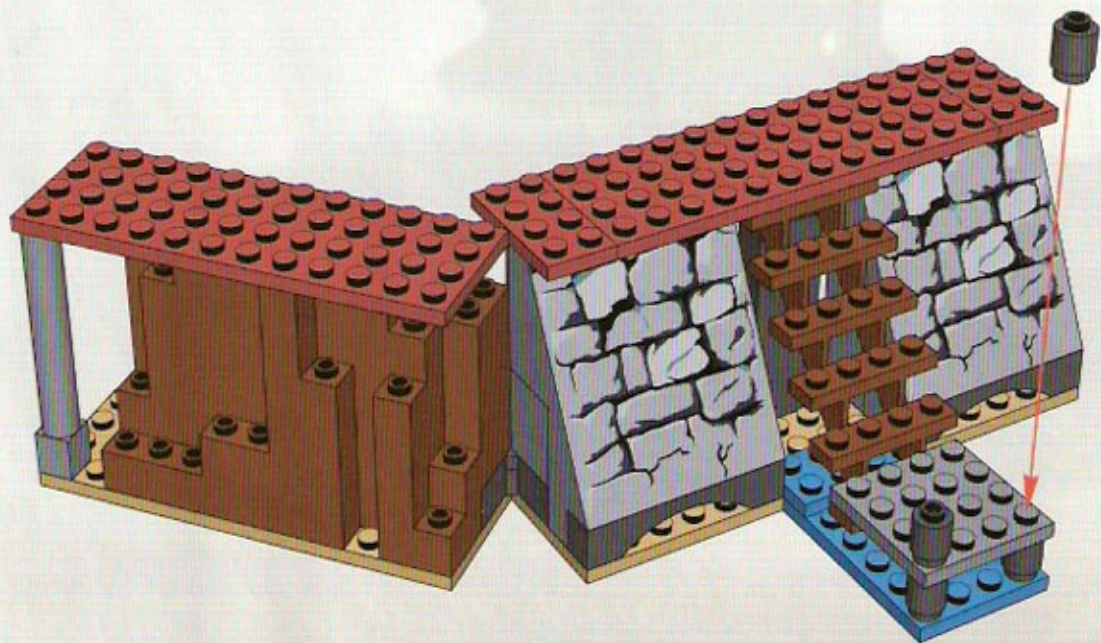

9

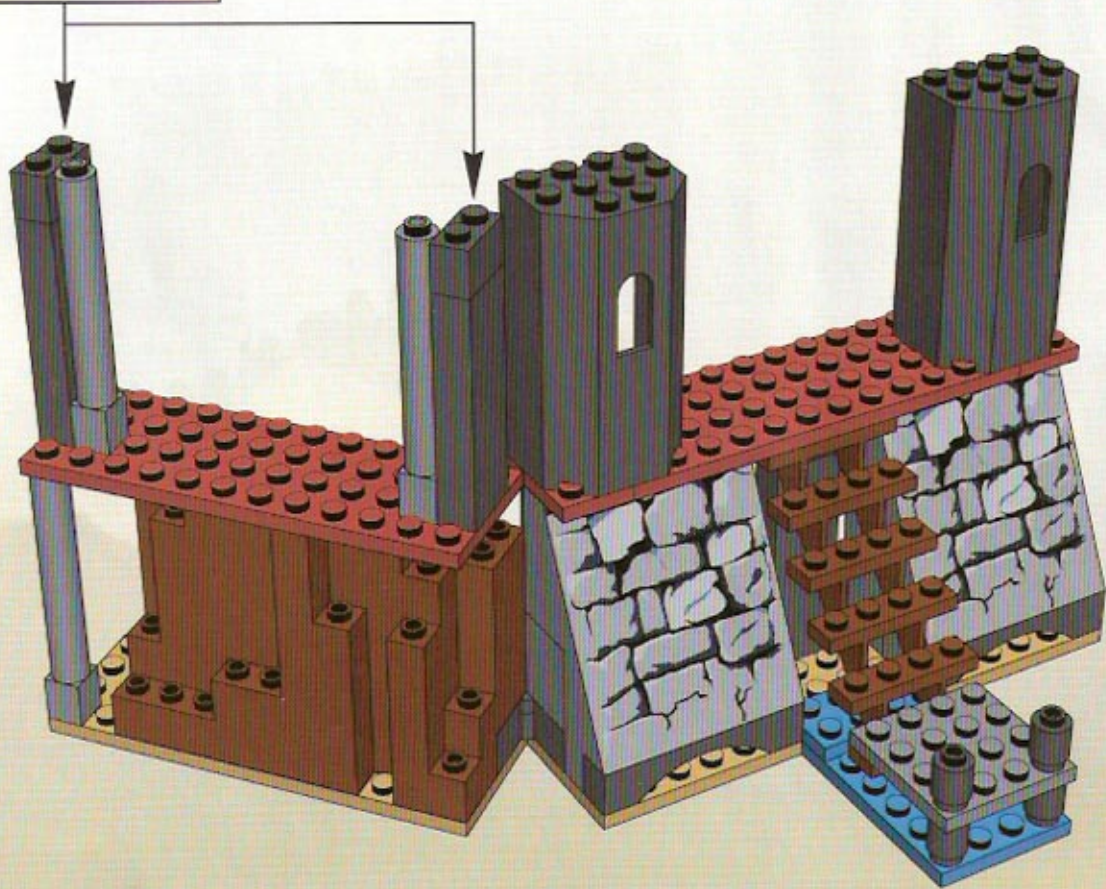
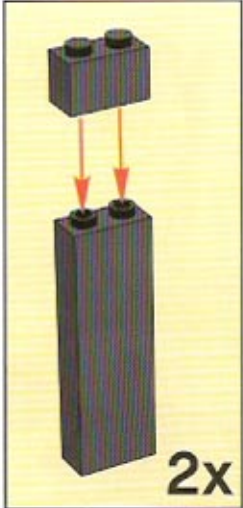

10

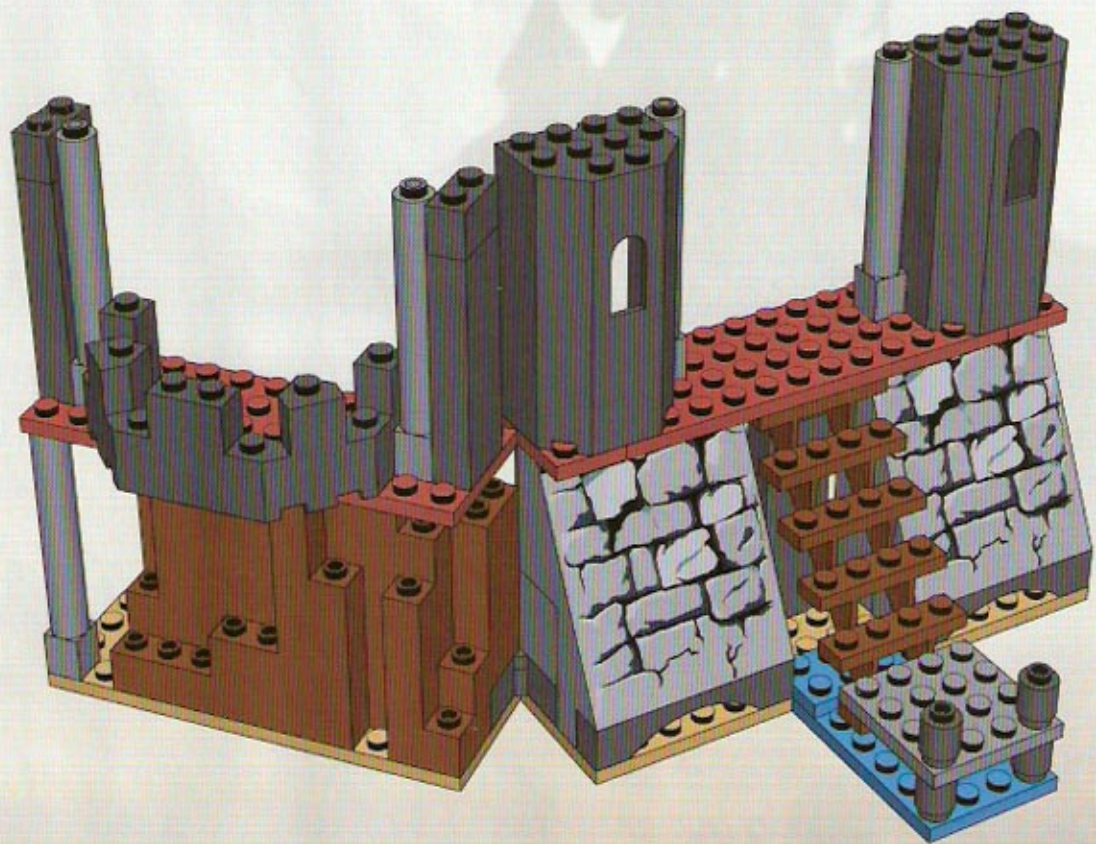

11

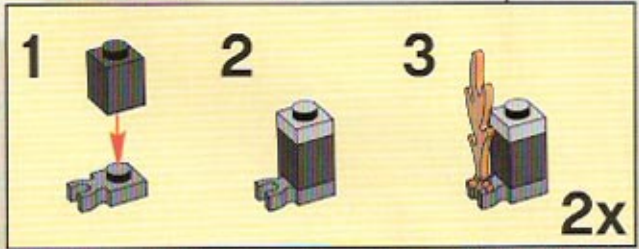
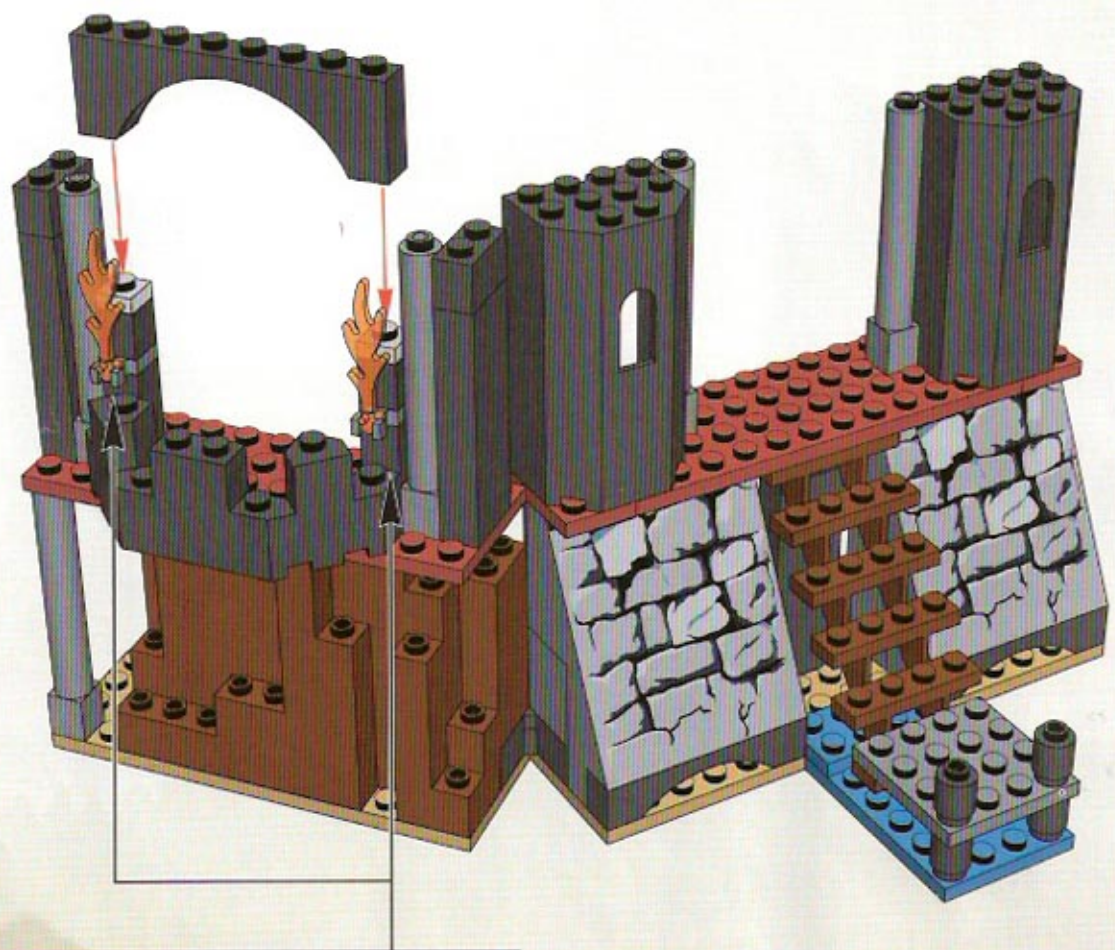

12

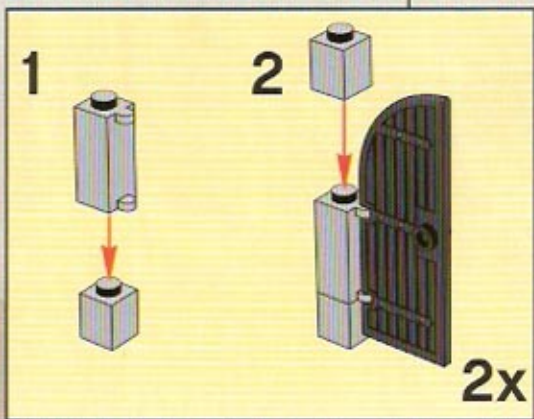
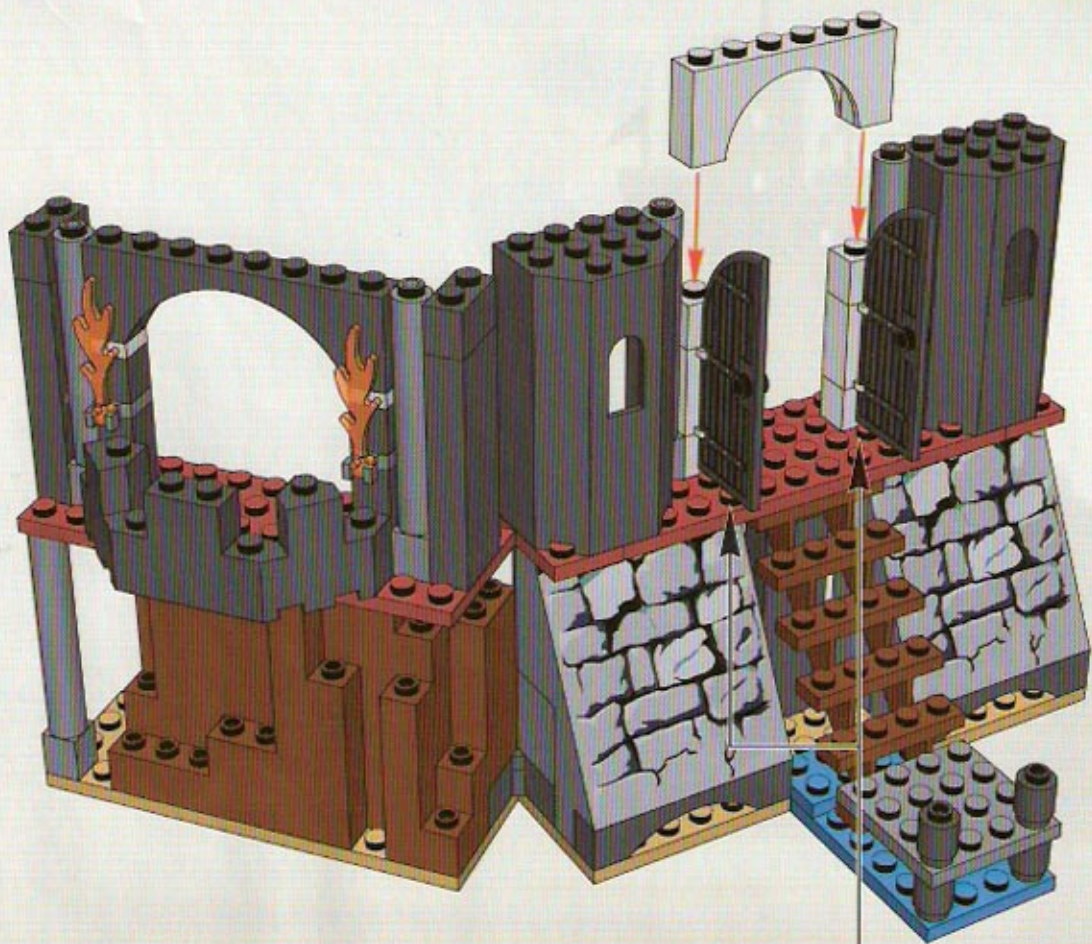

13

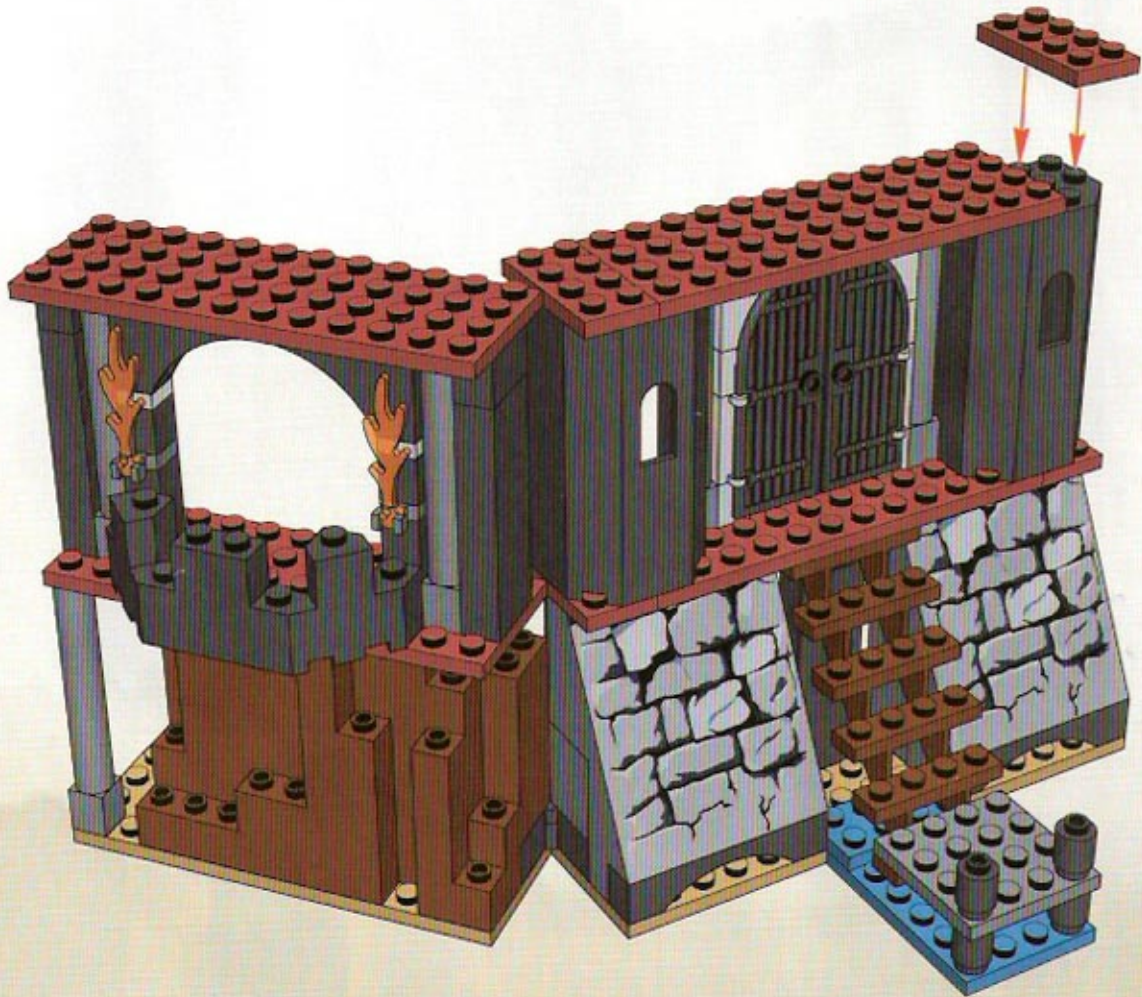

14

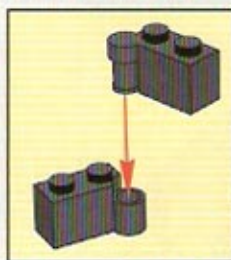

15



16

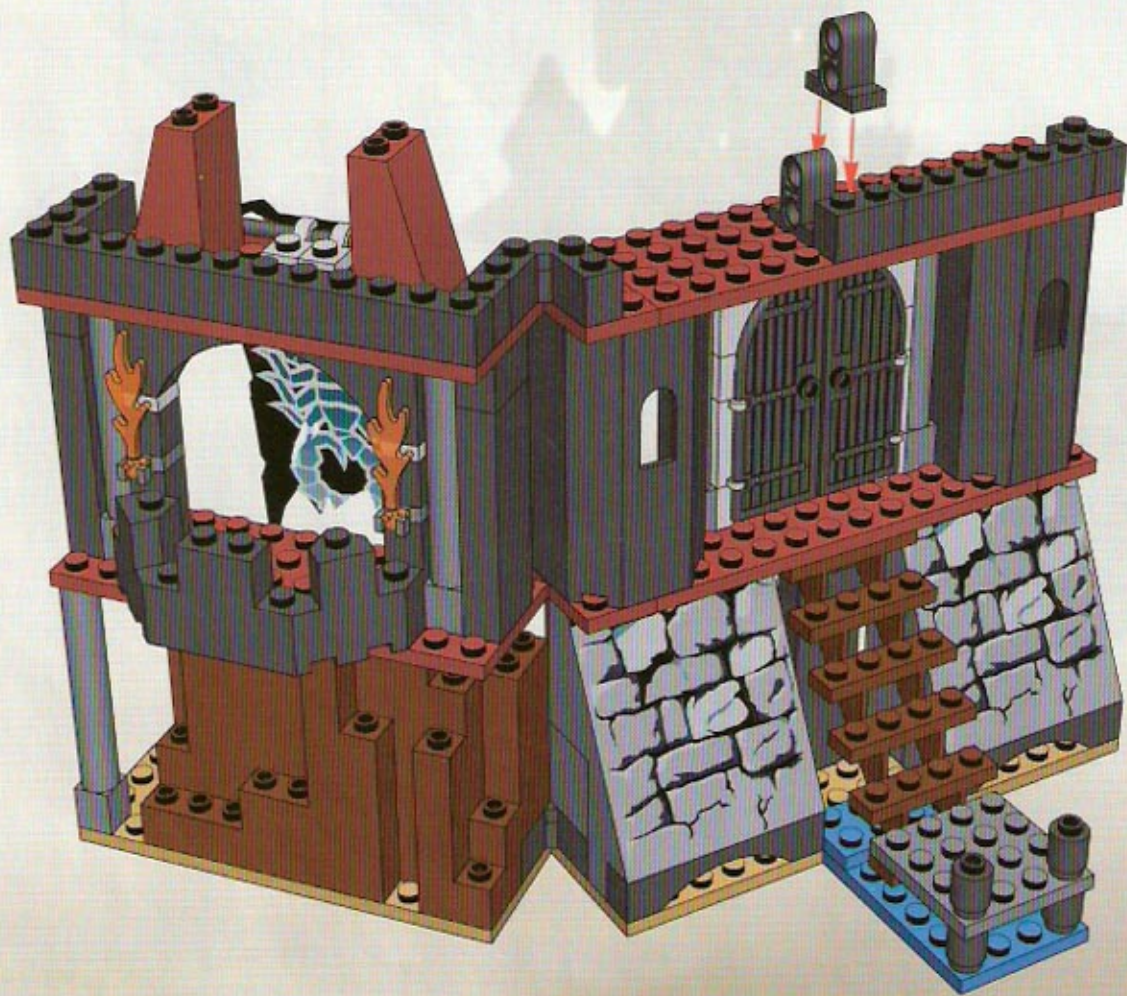

17

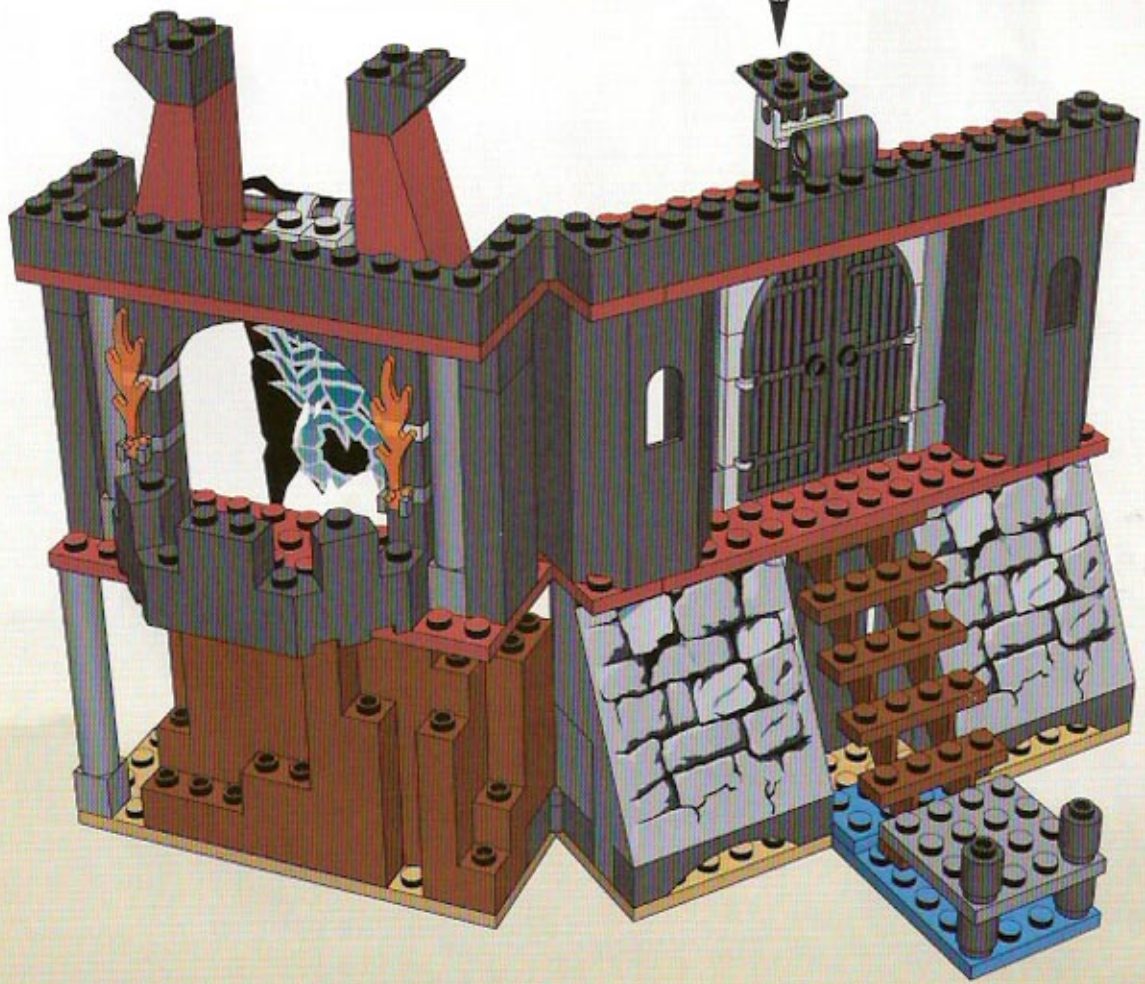
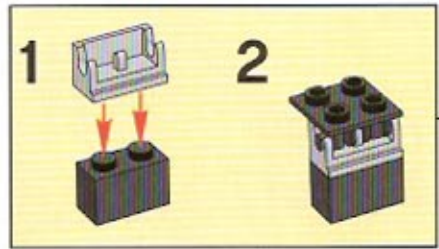

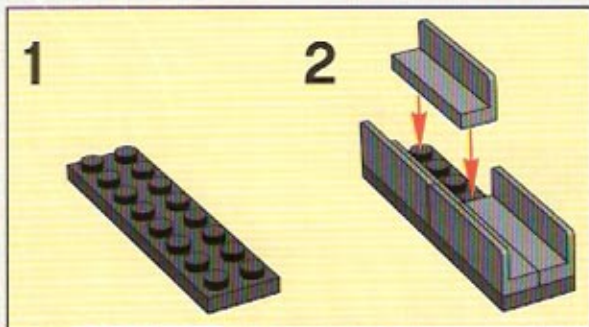

18

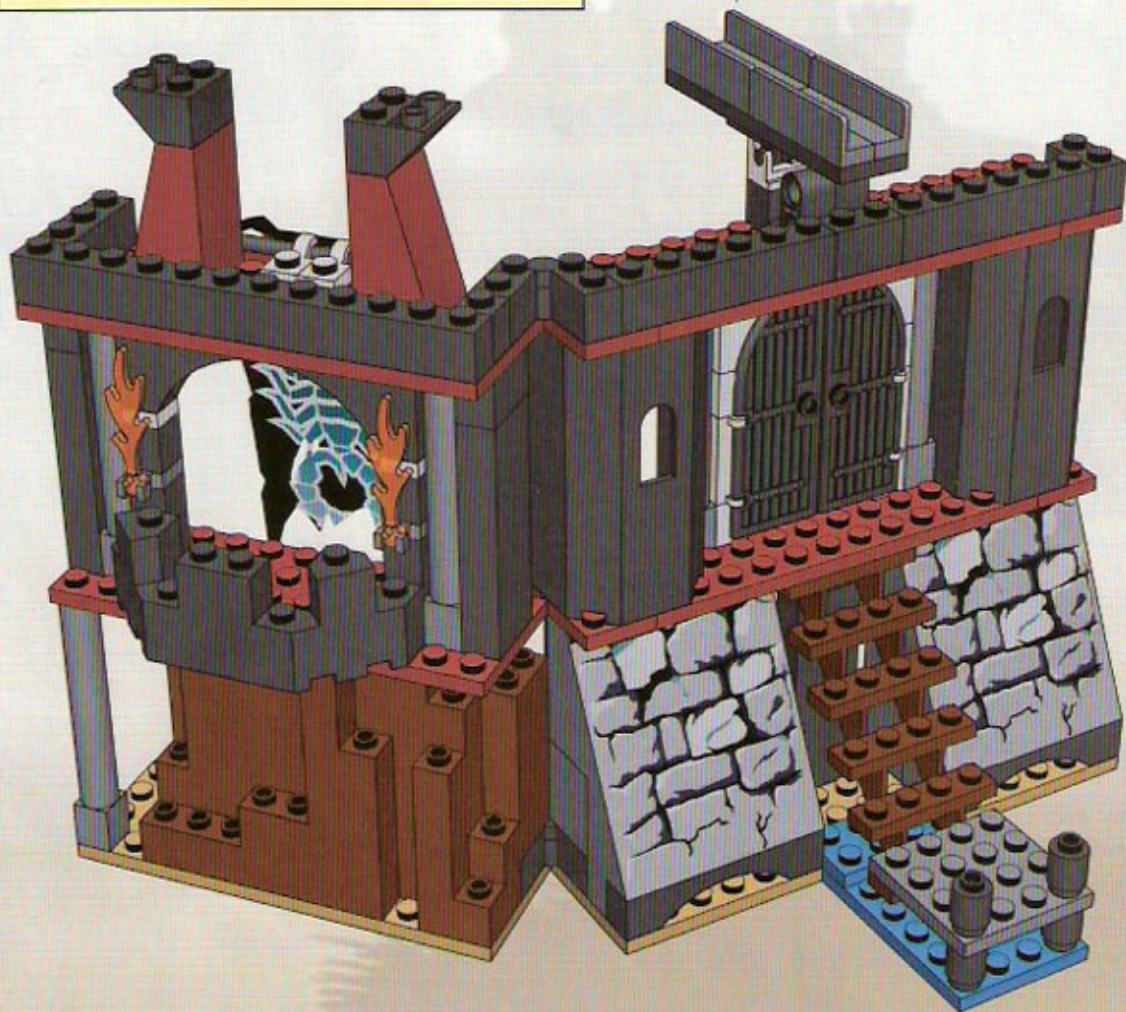

1



2

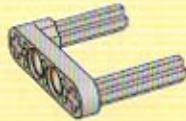

3

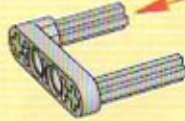

19

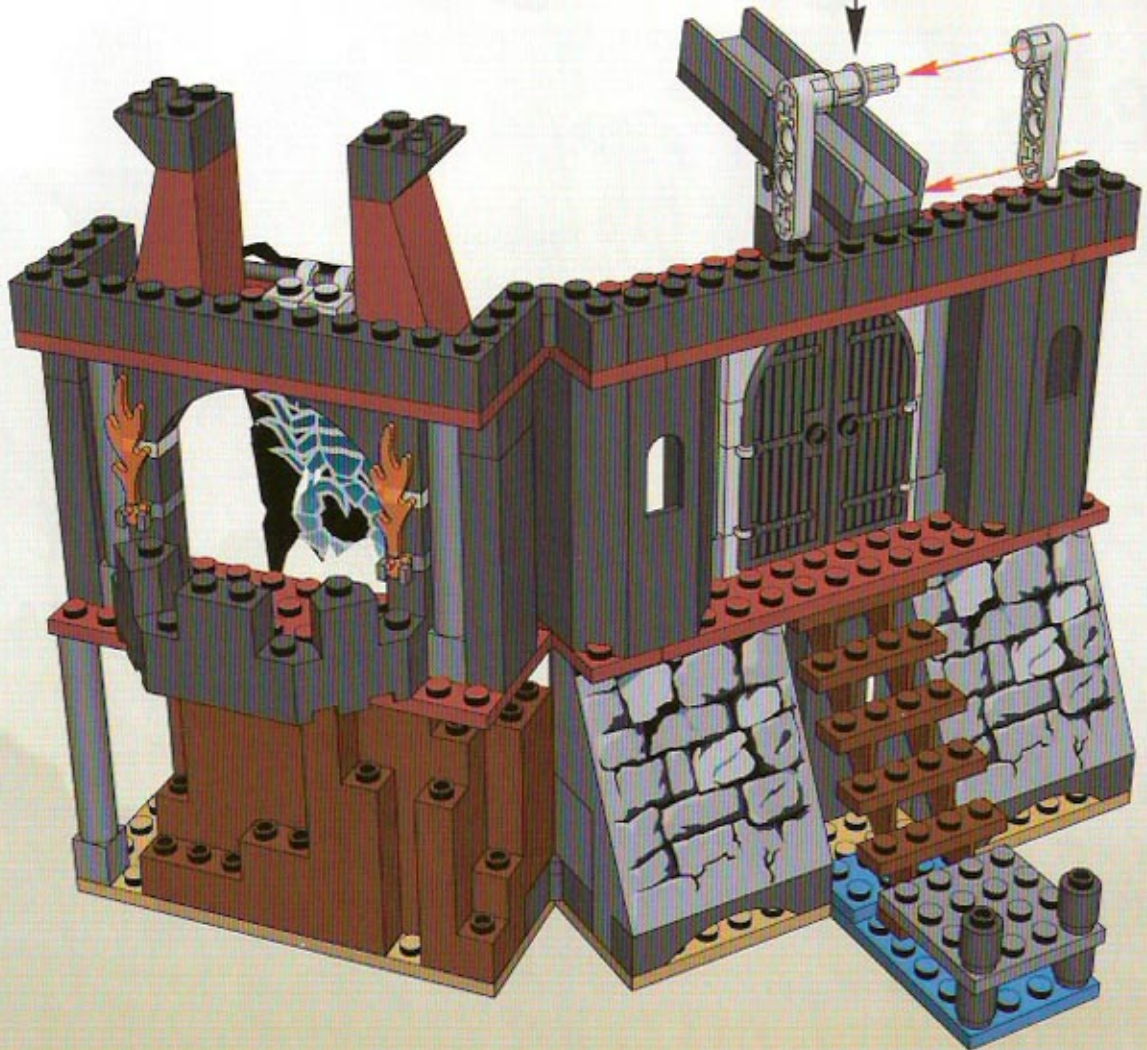

20

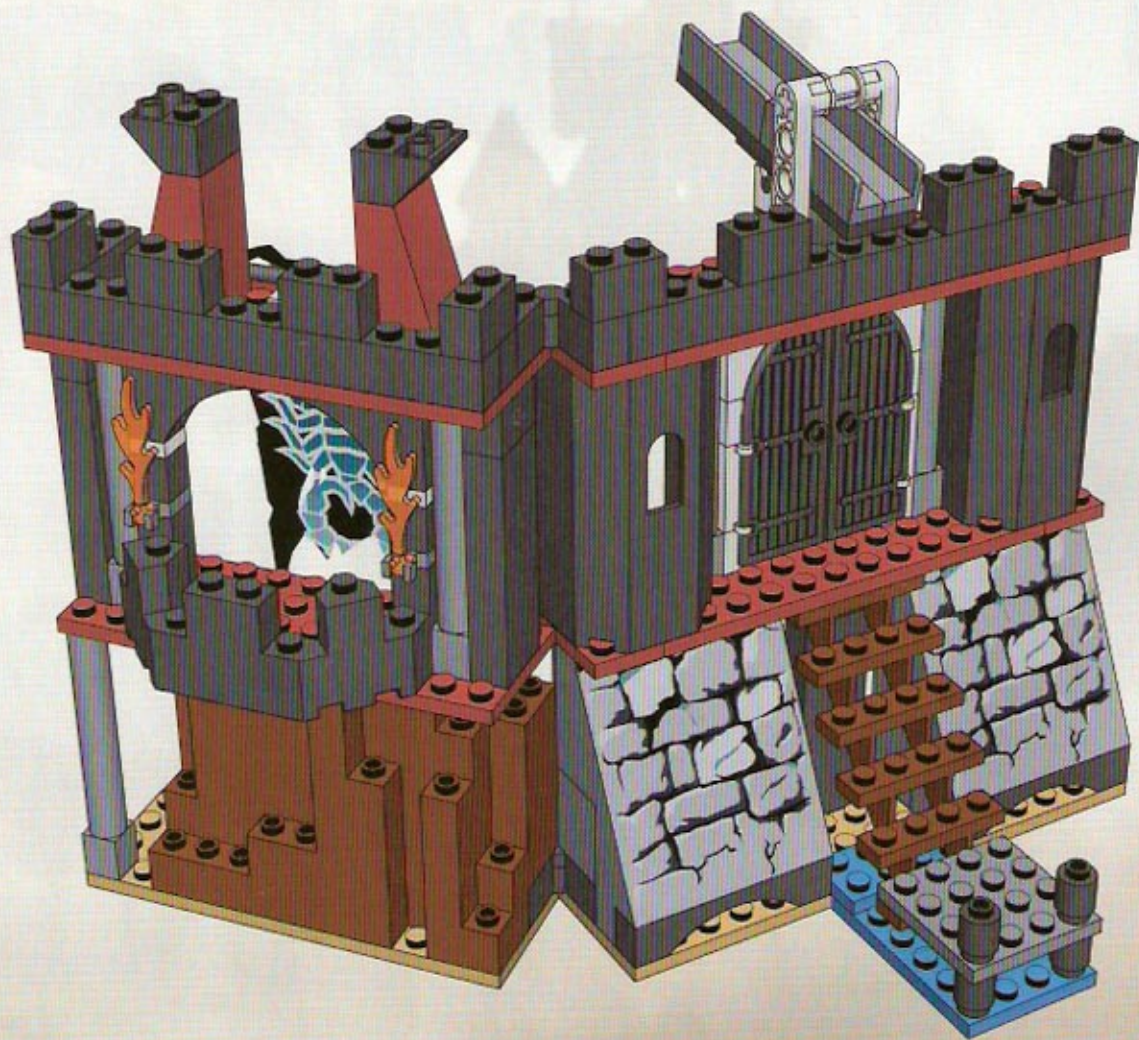

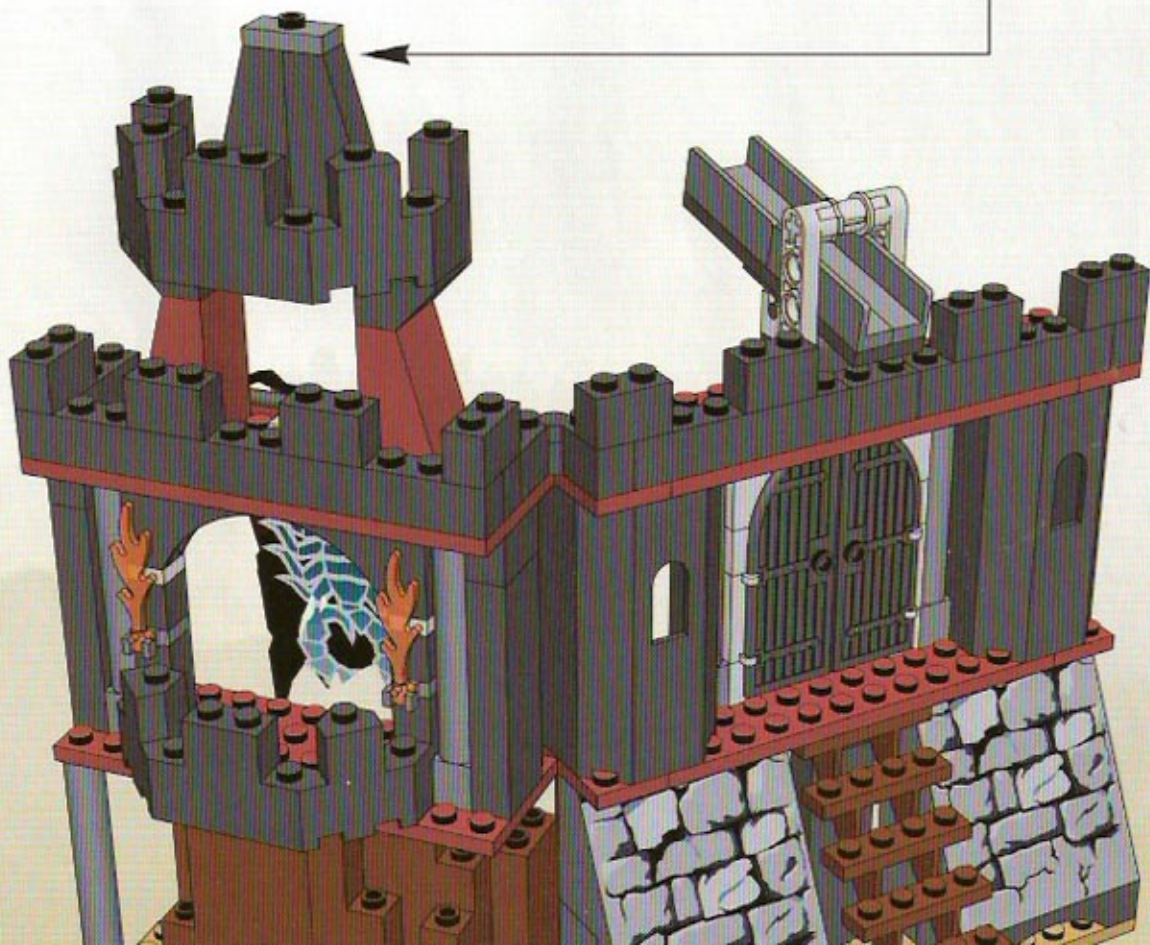
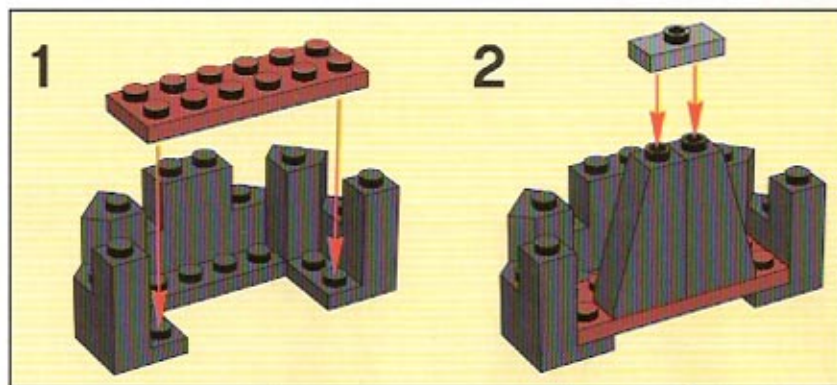

22



LEGO

Knights' Kingdom





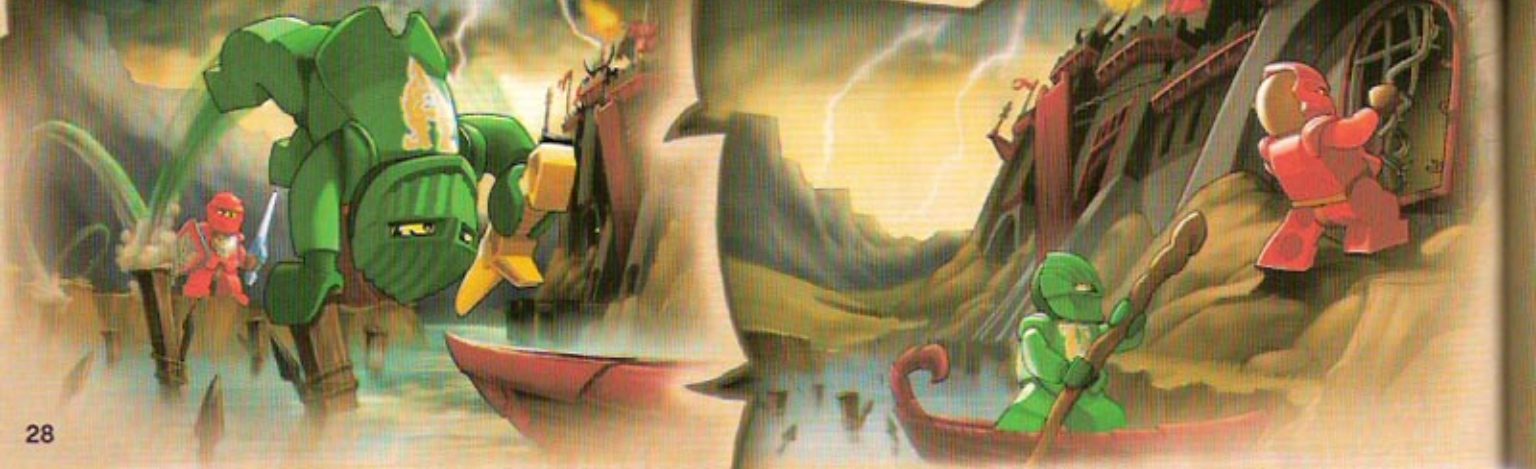









Knights Kingdom



8791

Sir Danju



8792

Sir Jayko



8793

Sir Rasous



8794

Sir Santis



8795

Lord Udek



8796

King Aladras



8873



8874



8875



8876



8877

Discover the LEGO® UNIVERSE!

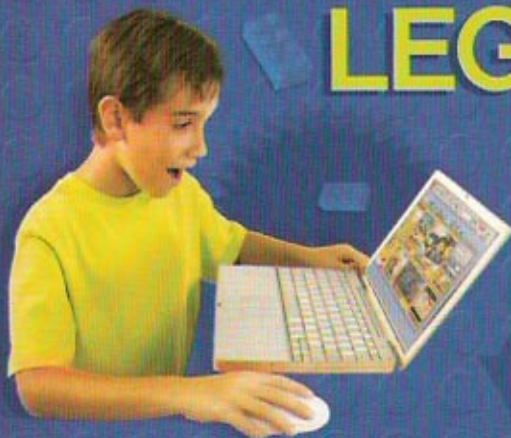

LEGO SHOP at HOME



The
World's
Biggest
LEGO
Shop!



LEGO club



Win! Gagne! Gewinne! 当たります



WIN LEGO® PRODUCTS

We would like to know what you think about our new LEGO® product. If you could help us by answering a few questions you are in with a chance of winning an exciting LEGO prize. It will only take you about 3 minutes! Log on to the web address below for further instructions.

We would really like to hear what you think about your new LEGO product. If you'd like to help us, go to the web address below for further instructions.



Estimado usuario LEGO®

Al contestar algunas preguntas en Inglés, francés, alemán o japonés, en el sitio www.acnielsen.aim.dk/lego, podrás participar en el sorteo de algunos valiosos premios LEGO®.



推選でレゴ®製品が当たります

本では、皆さんが買っているレゴ®製品についてどんな感想をお聞かせ、知りたいと思っています。同時に答えて、美しいレゴ®製品の抽選にも参加できます。アンケートの回答には、ほんの3分ほどしかかからないので、ぜひレゴ®のウェブアドレスまでアクセスしてください。



GAGNE DES PRODUITS LEGO®

Nous aimerions savoir ce que tu penses de ton nouveau produit LEGO®. Si tu veux bien nous aider en répondant à quelques questions, tu recevras peut-être bientôt un fantastique prix LEGO. Et cela ne te prendra que 3 minutes environ ! Tu obtiendras davantage d'informations en visitant le site Internet indiqué ci-dessous.

Nous aimerions savoir ce que tu penses de ton nouveau produit LEGO. Si tu souhaites nous aider, rends-toi à l'adresse Internet ci-dessous où tu trouveras des instructions supplémentaires.



Caro Consumidor da LEGO®

Ao responder a algumas perguntas em Inglês, Francês, Alemão ou Japonês no endereço www.acnielsen.aim.dk/lego irá participar num concurso para ganhar valiosos prémios da LEGO®.



GEWINNE LEGO® PRODUKTE

Wir sind sehr an deiner Meinung über dein neues LEGO® Produkt interessiert. Wenn du uns den Gefallen tust und ein paar Fragen beantwortest, kannst du einen tollen LEGO Preis gewinnen. Das Ganze dauert nur etwa 3 Minuten! Gehe einfach zu der unten angegebenen Webadresse - dort findest du weitere Informationen.

Wir möchten gerne wissen, was Sie von Ihrem neuen LEGO Produkt halten. Wenn Sie uns helfen möchten, besuchen Sie bitte die u.a. Website, auf der Sie alles Weitere erfahren.



Kedves Ifjú LEGO® Vásárló

Ha ellátogatsz a www.acnielsen.aim.dk/lego honlapra és ott angol, francia, német vagy japán nyelven megválaszolod néhány kérdést, akkor részt veszel egy versenyben, amelyben értékes LEGO® díjakat nyerhetsz.

LEGO, the LEGO logo, the CLUTTS logo and BIONICLE are trademarks of the LEGO Group. ©2005 The LEGO Group.

www.acnielsen.aim.dk/LEGO





Knights' Kingdom

CAPTURE THE FORTRESS. SAVE THE KINGDOM



25 26 27 28 29 30 31 32 33



©2005 The LEGO Group