

**LEGO**

# Technic

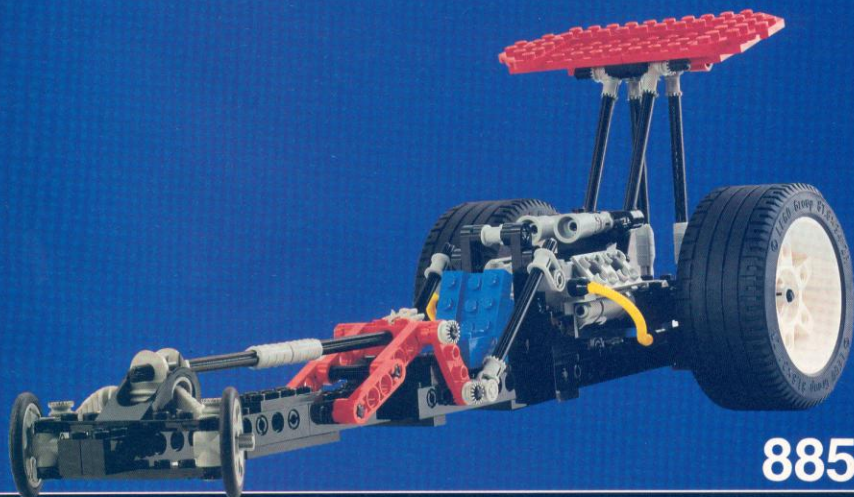

**8857**

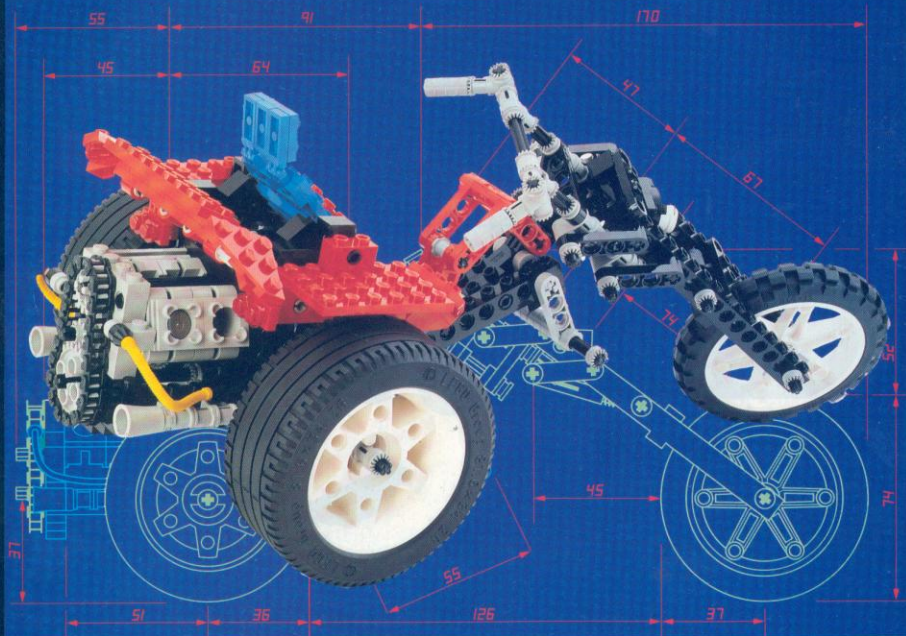
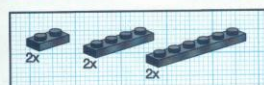
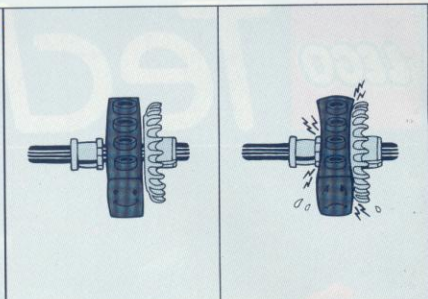
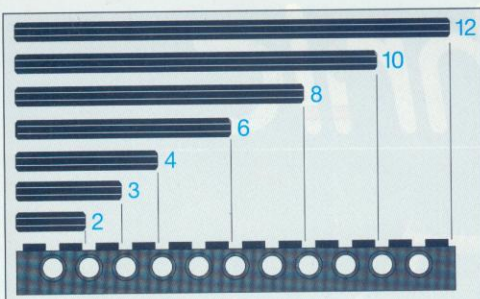

1

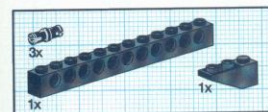
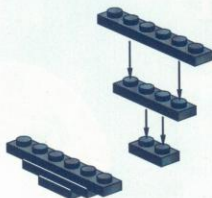

2

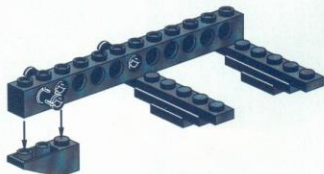

3

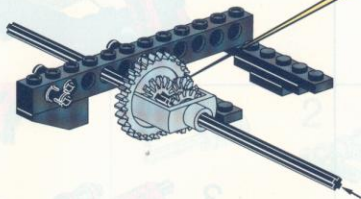
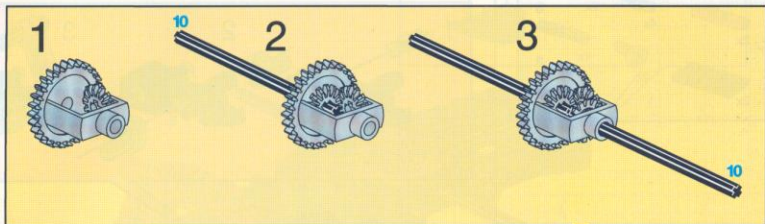
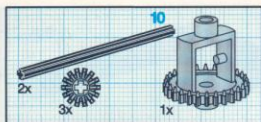

4

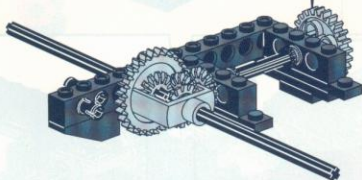
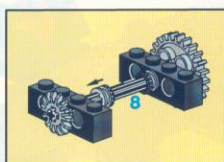
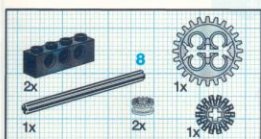



# 5

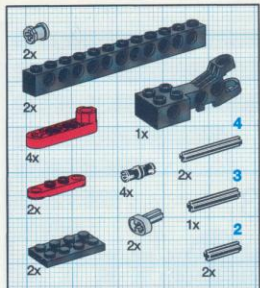

1

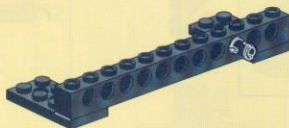

1



2

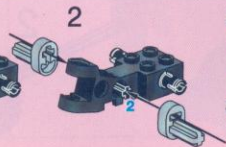

3

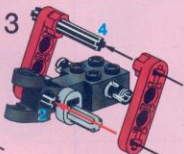

2

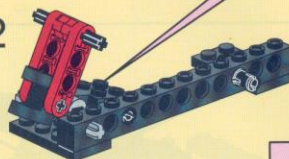

3

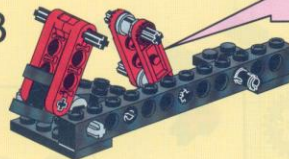

4

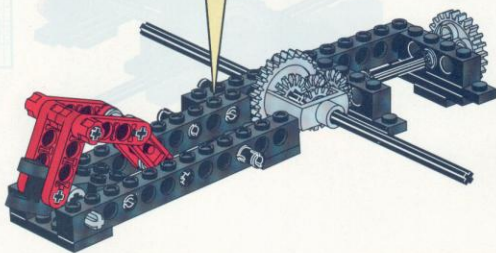
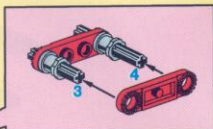
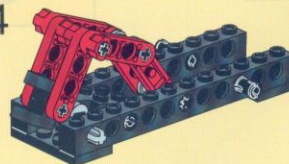

# 6

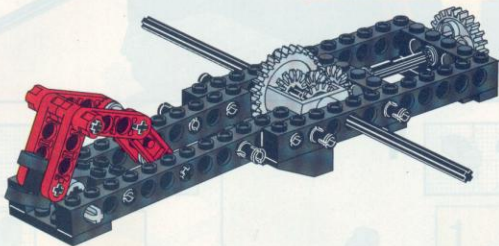
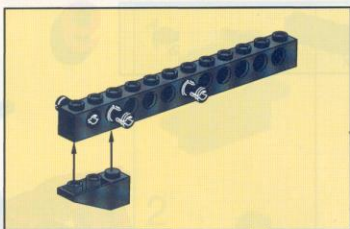
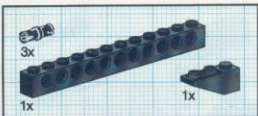

# 7

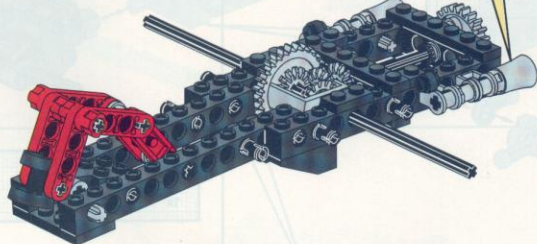
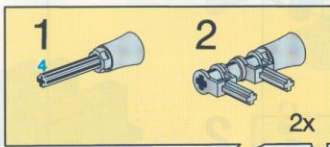
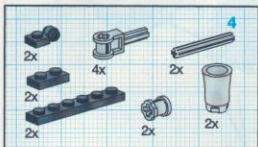

# 8

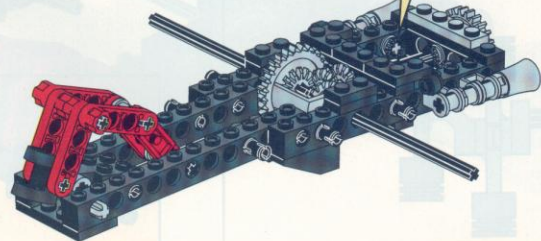
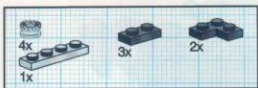

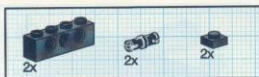

9

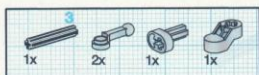
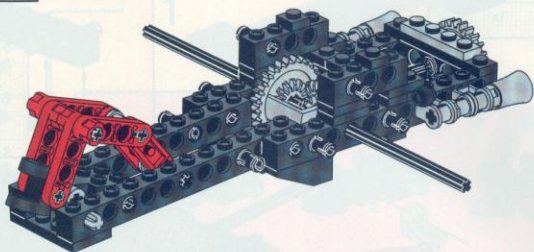

1

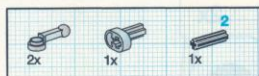
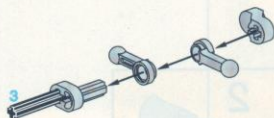

2

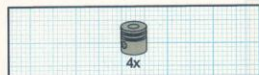
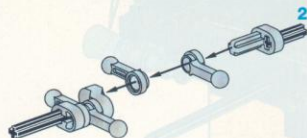

3

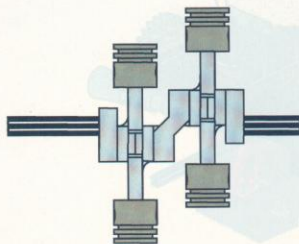

4

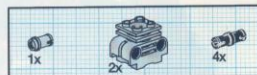
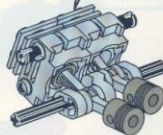
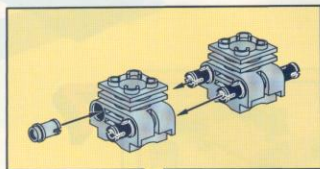

5

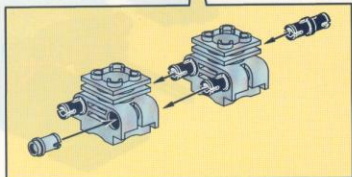
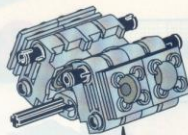



6

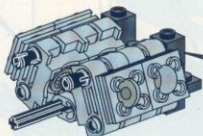
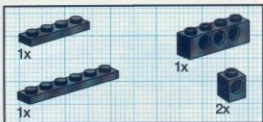

1

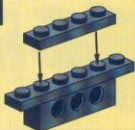

2



7

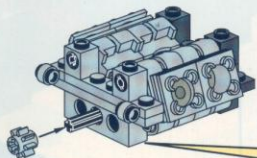
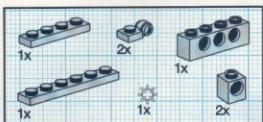

1

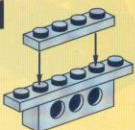

2

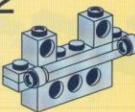

10

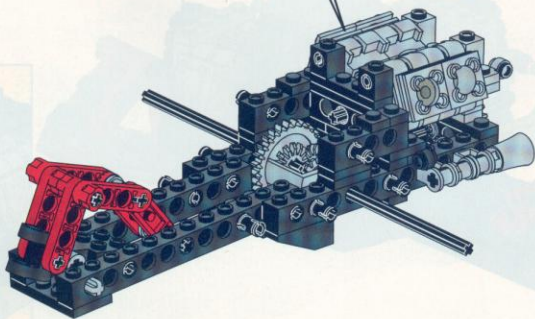

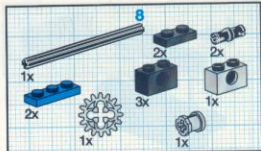

**11**

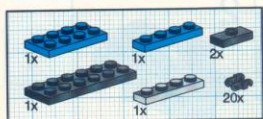
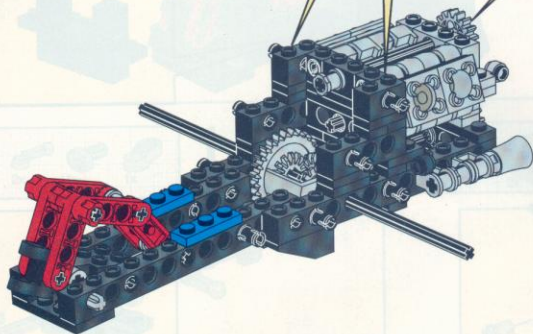
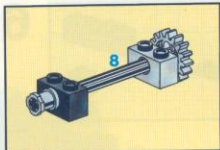

**12**

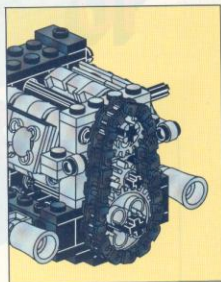
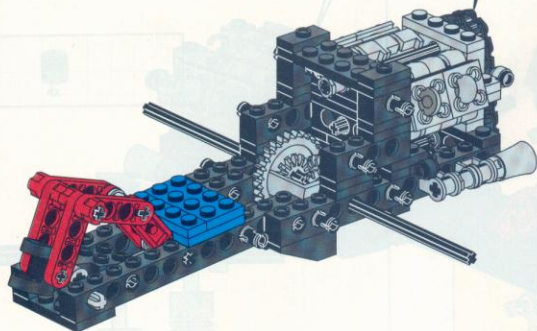
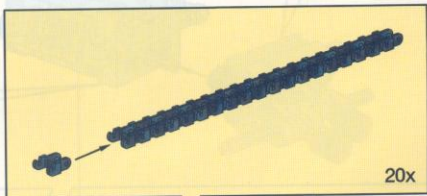



# 13

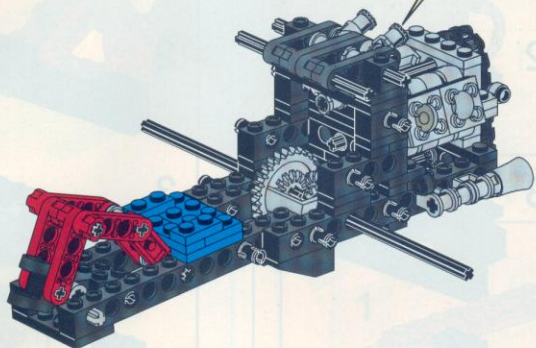
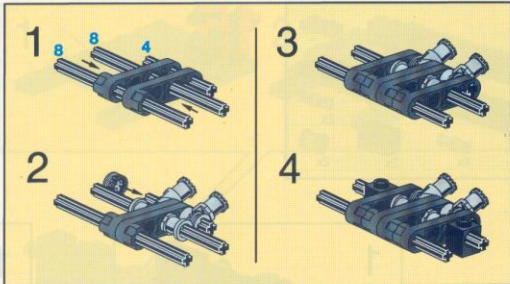
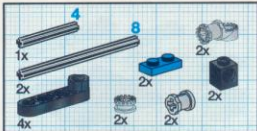

# 14

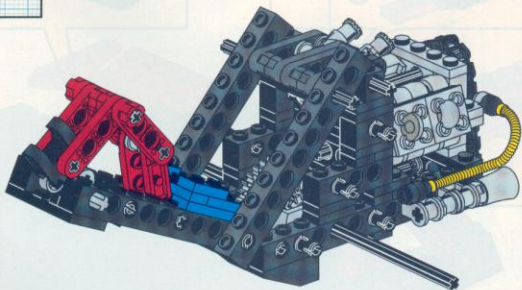

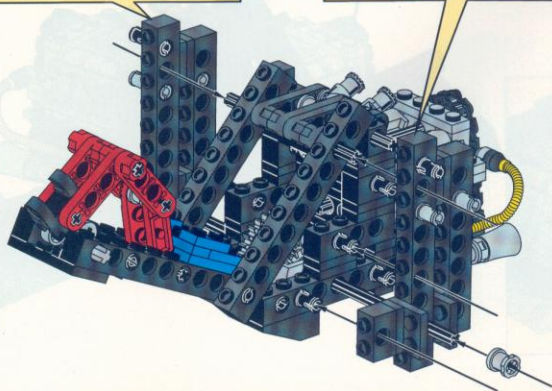
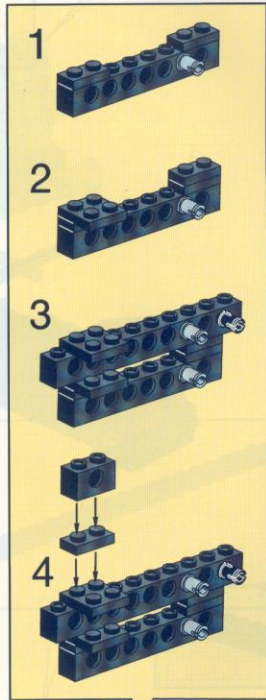
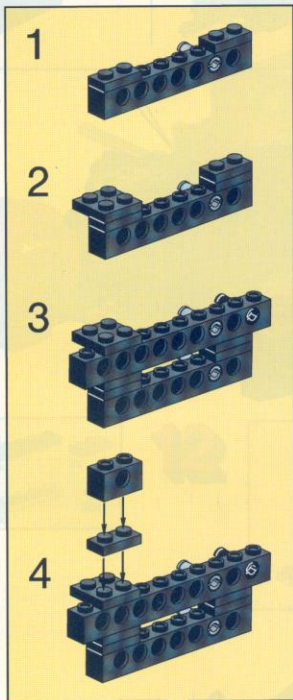
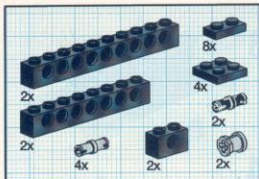



# 16

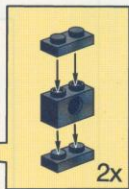
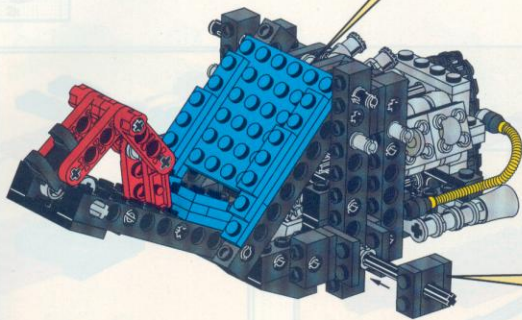
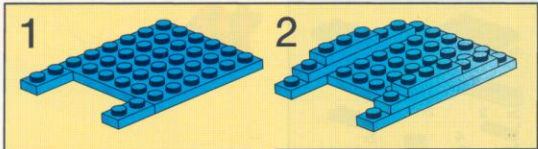
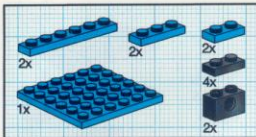

# 17

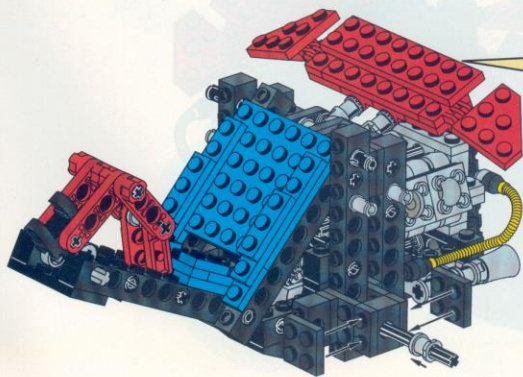
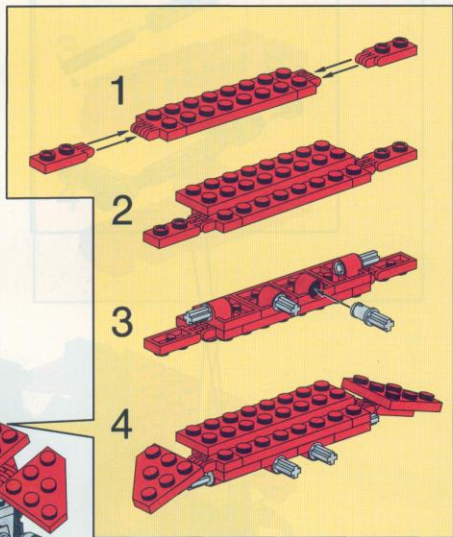
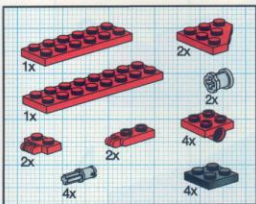





# 19

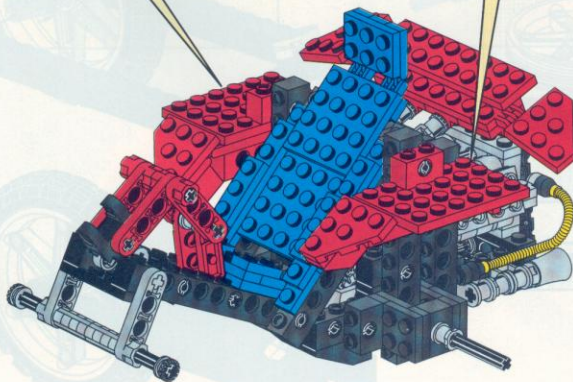
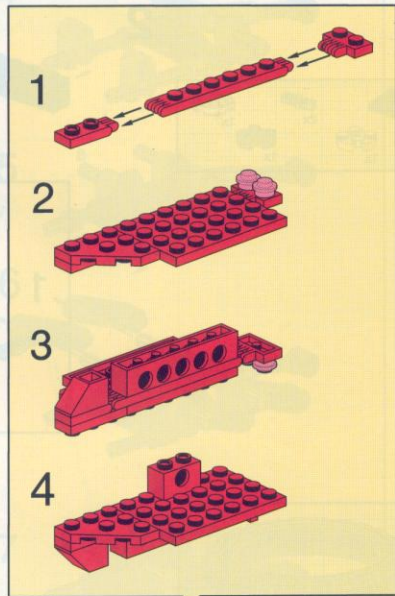
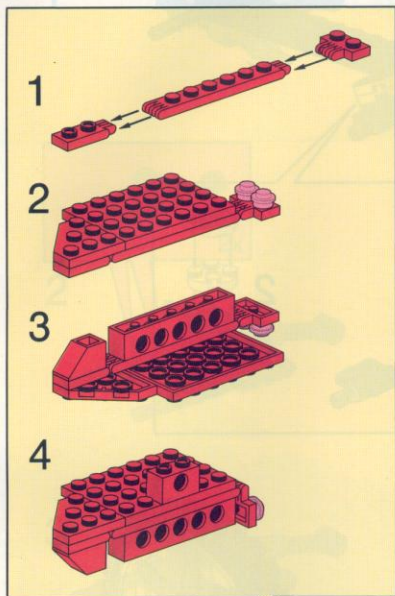
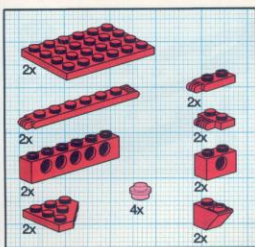

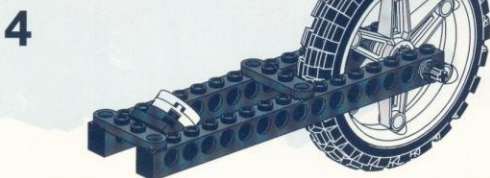
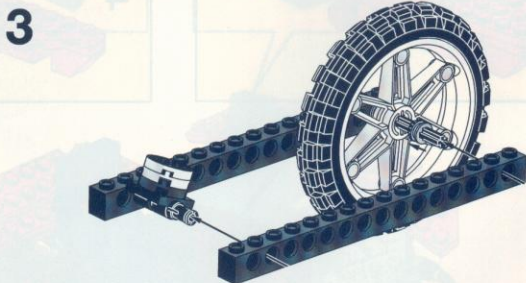
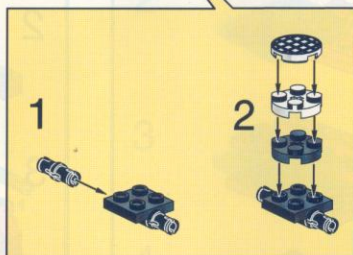
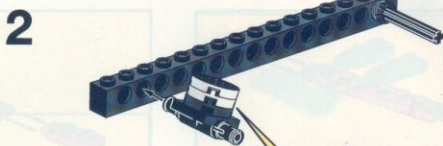
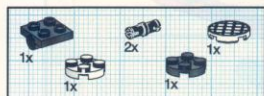



# 5

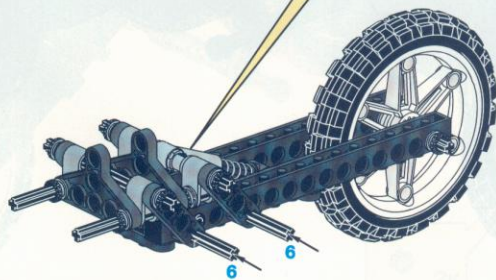
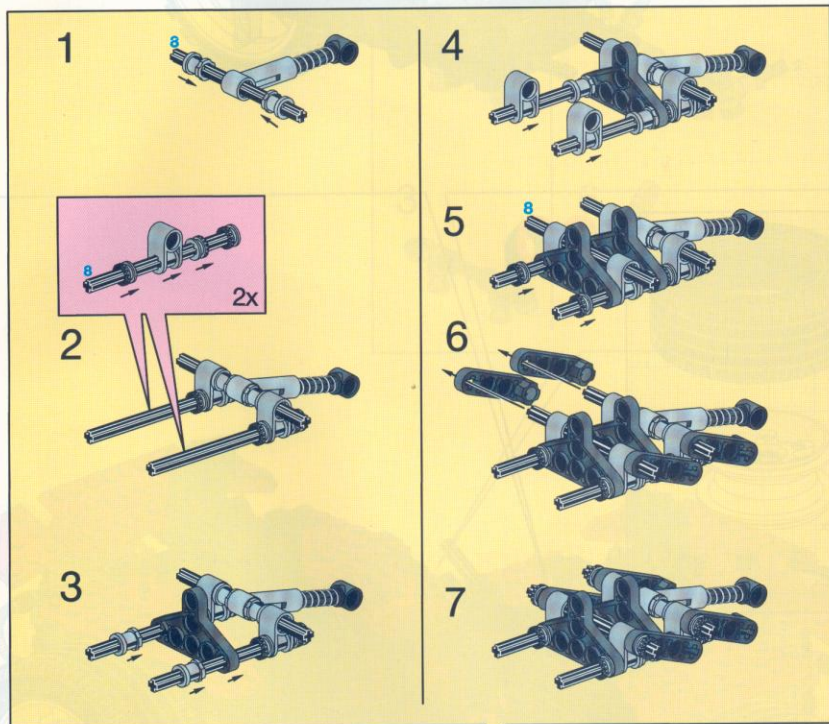
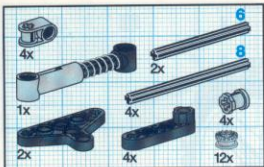

6

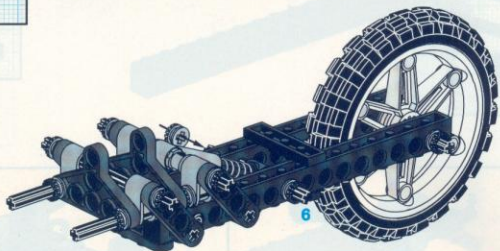

20

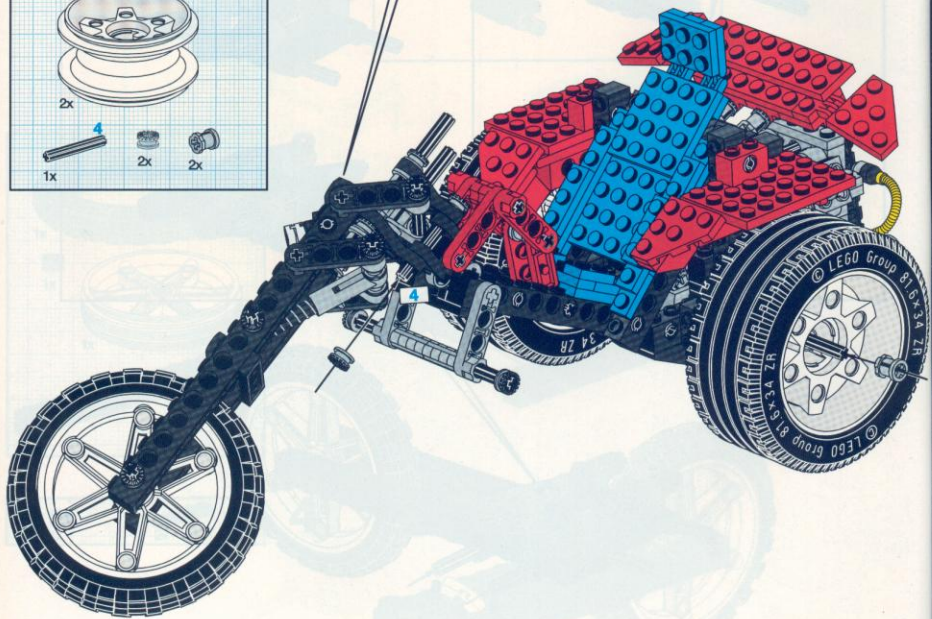
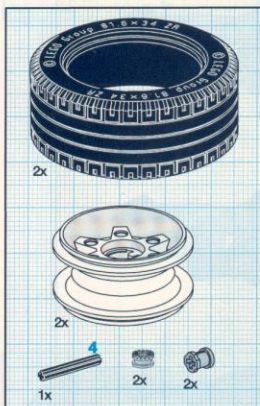



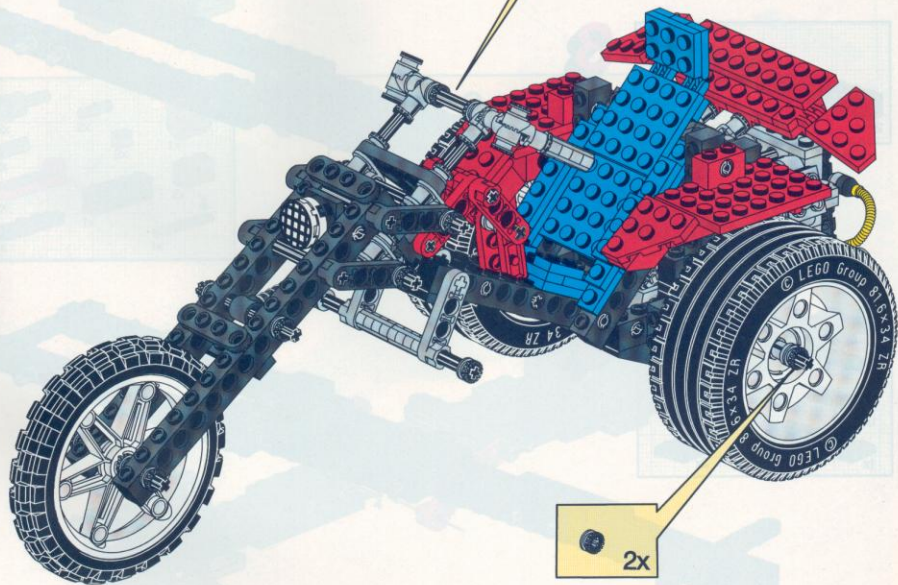
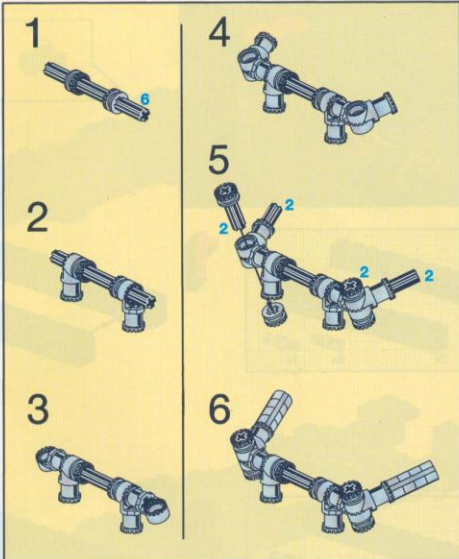
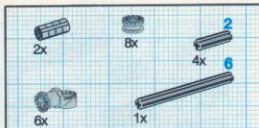



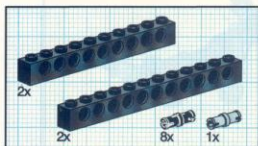

1

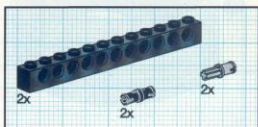
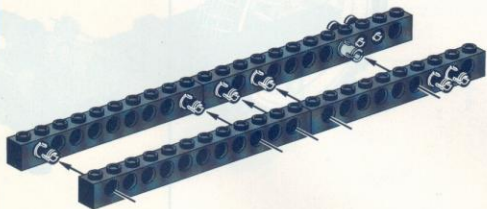

2

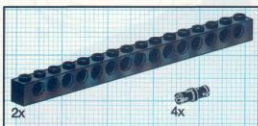
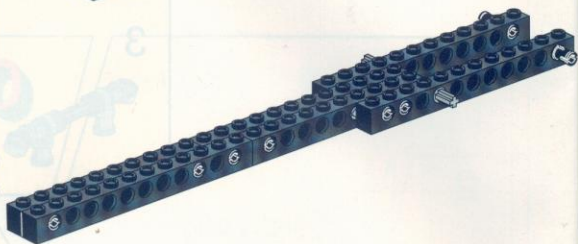

3

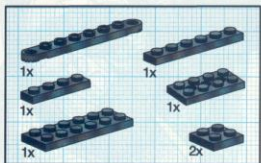
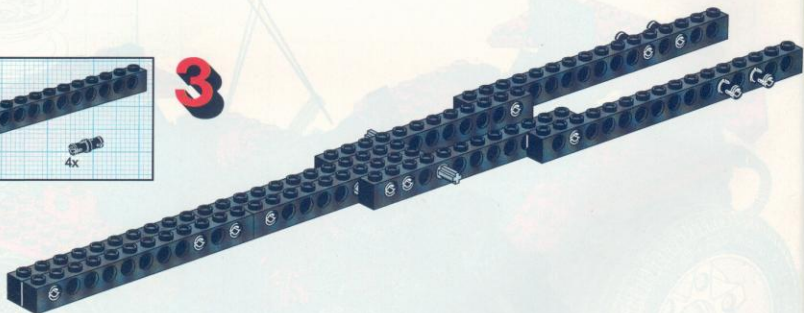

4

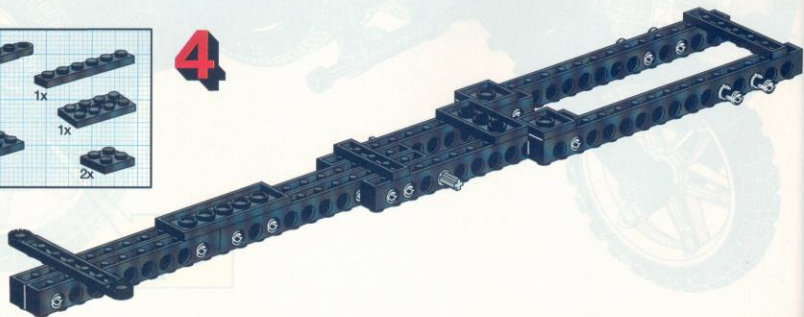

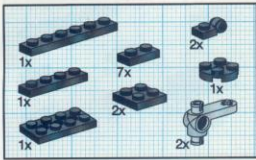

5

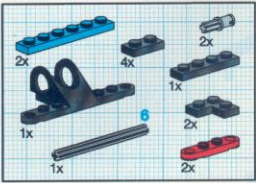
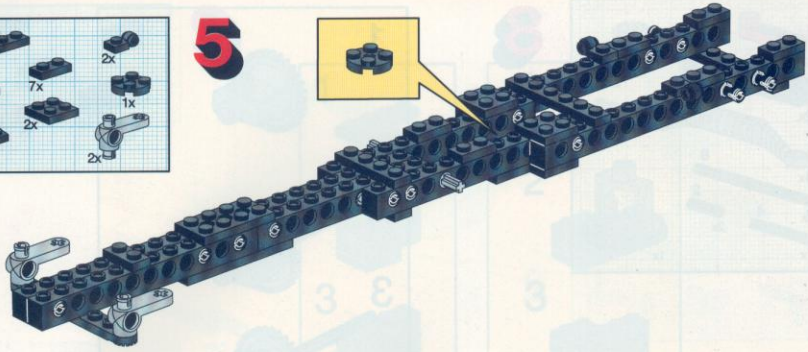

6

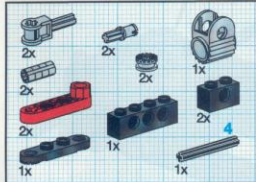
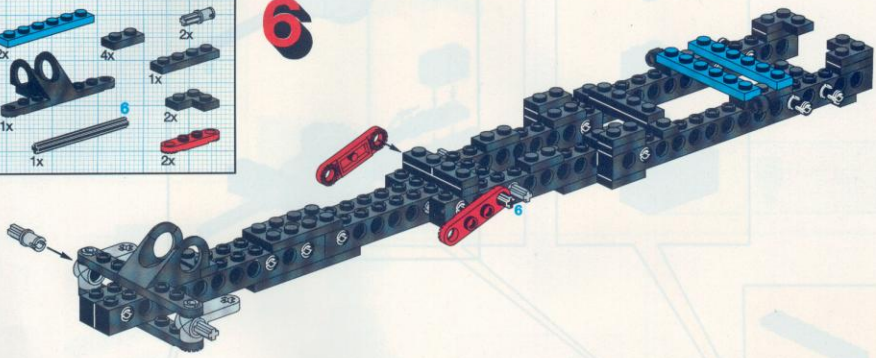

7

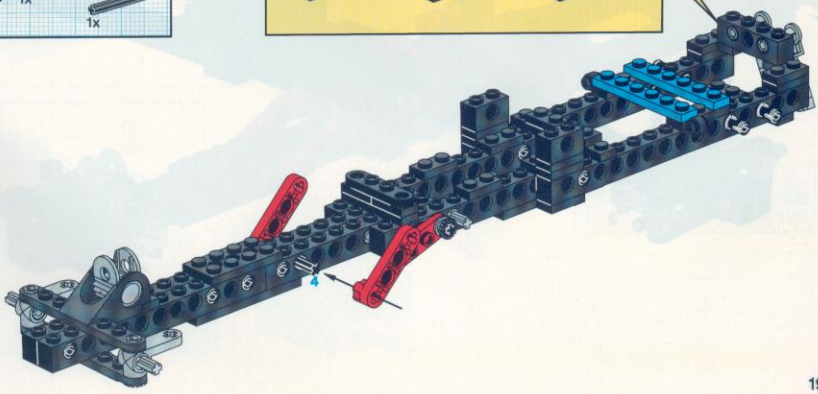
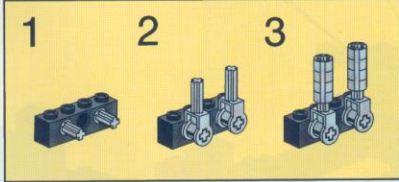







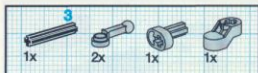

1

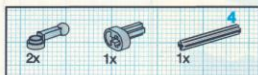
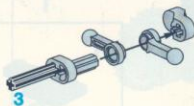

2

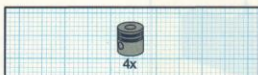
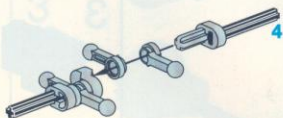

3

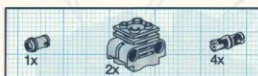
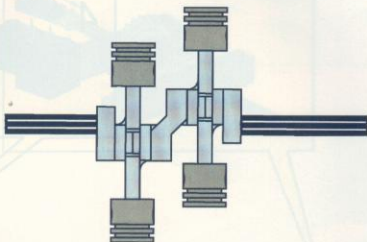

4

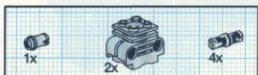
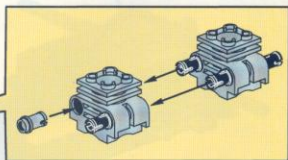
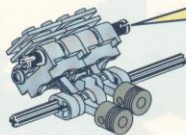

5

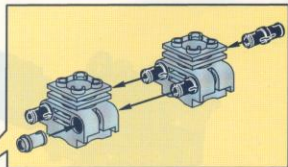
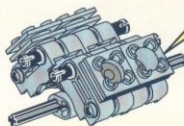





8

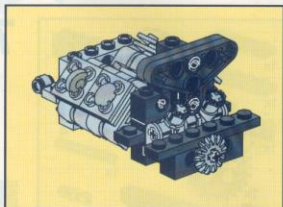
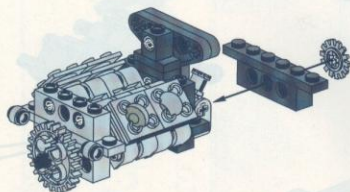

10

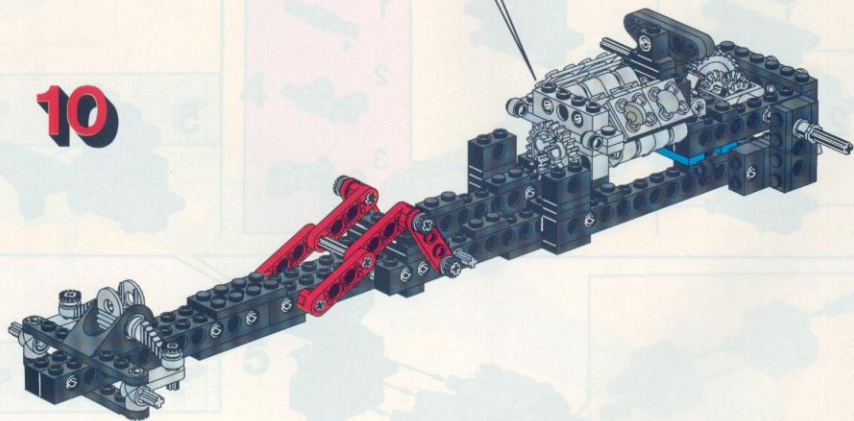

# 11

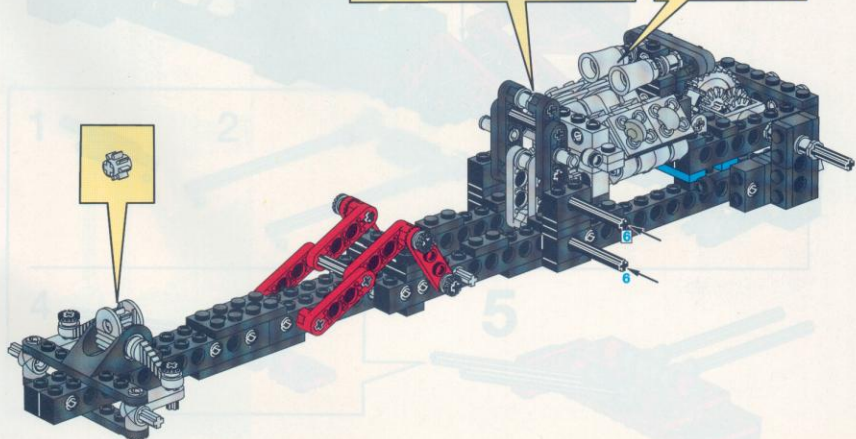
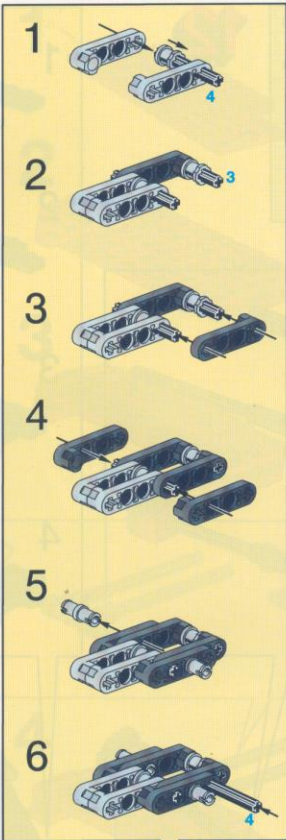
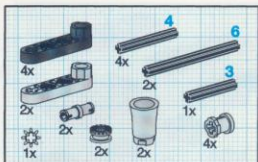





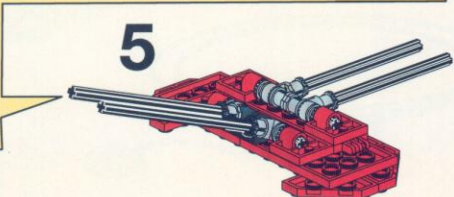
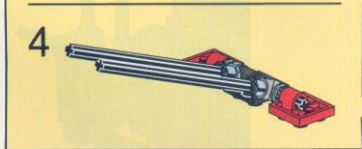
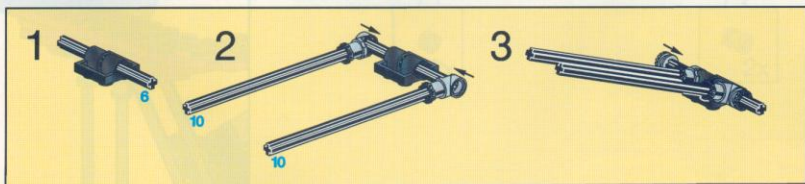
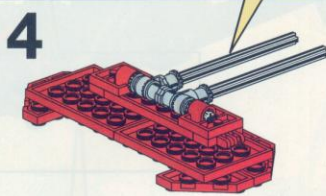
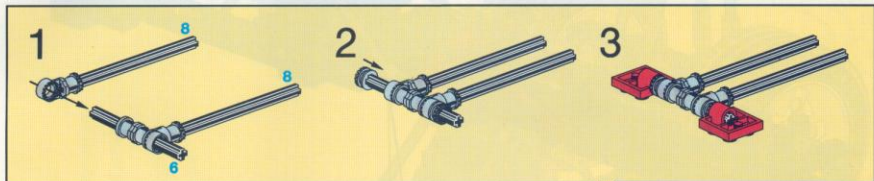
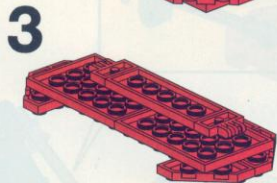
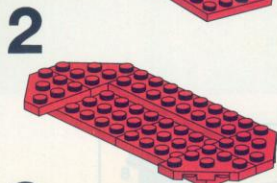
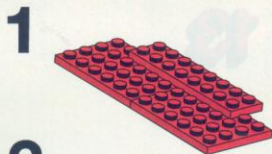
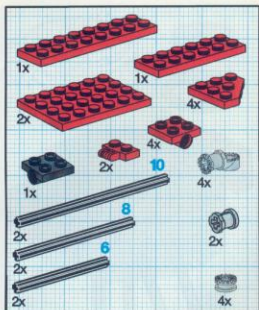

# 13

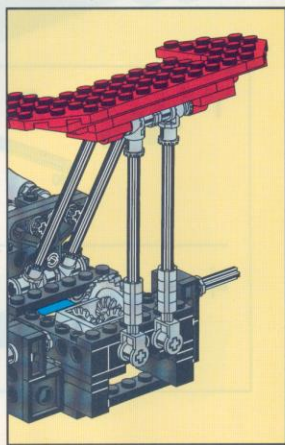
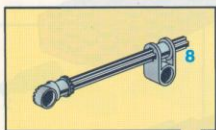
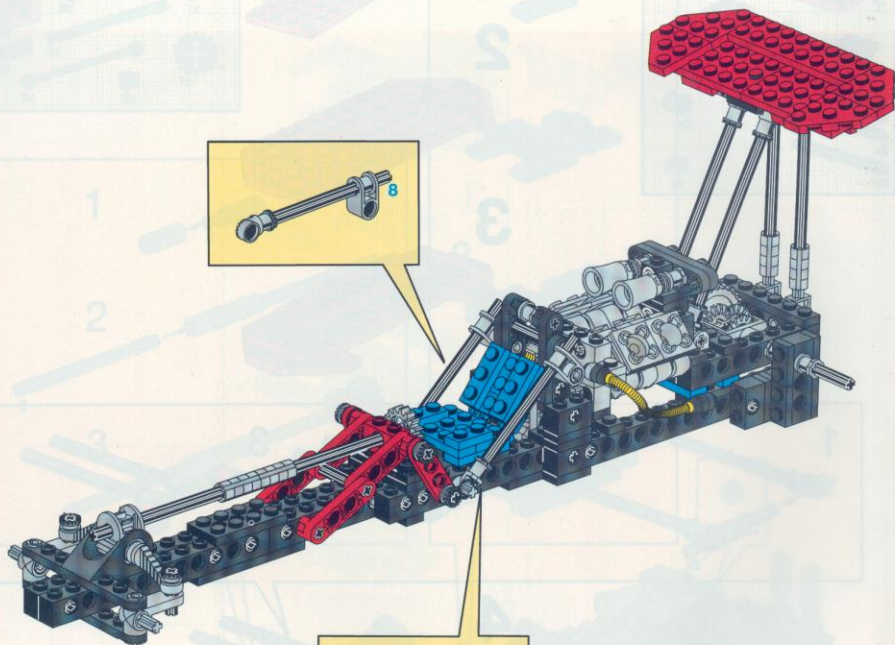

# 14

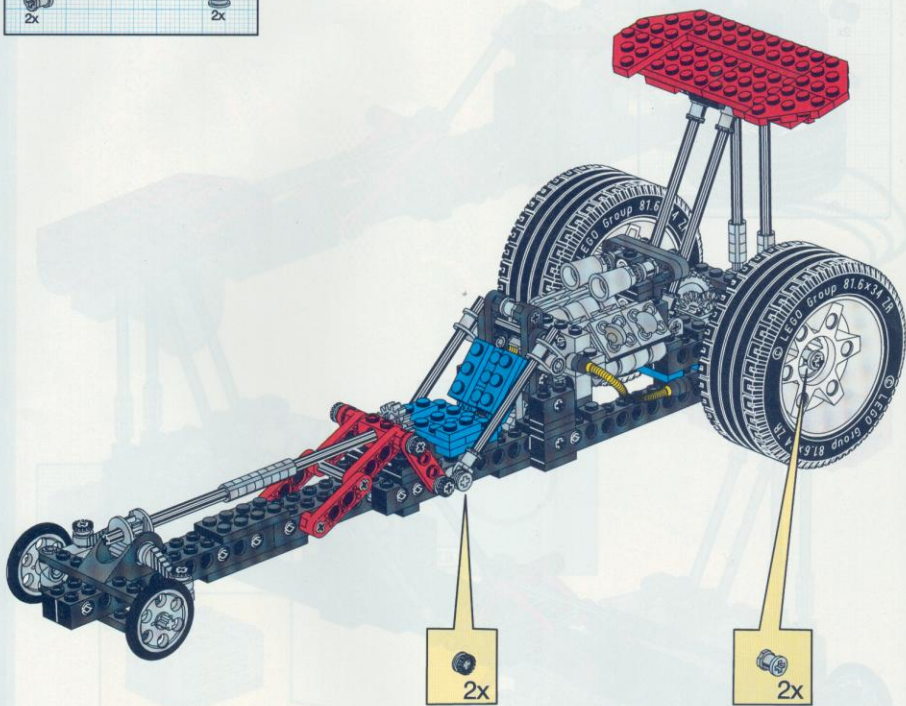



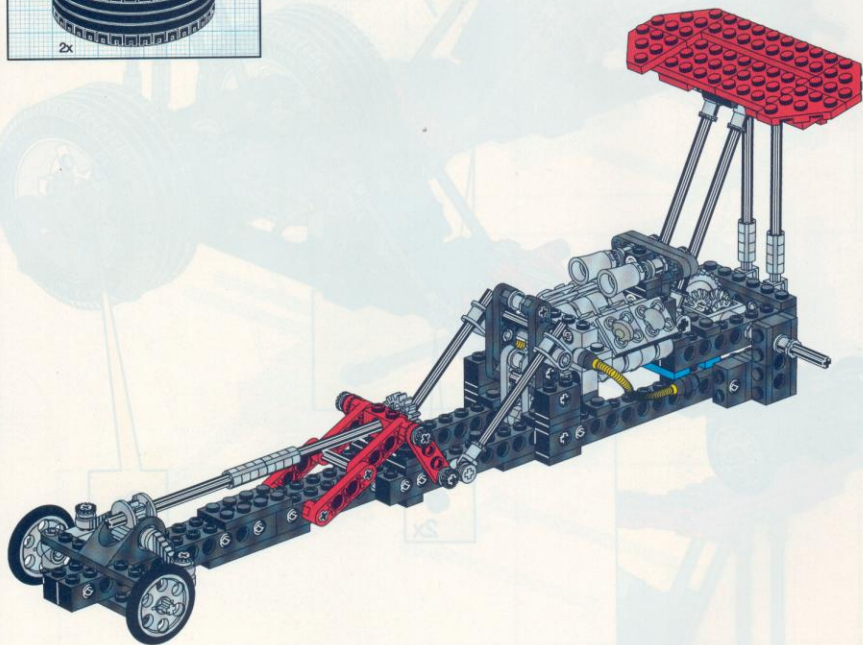
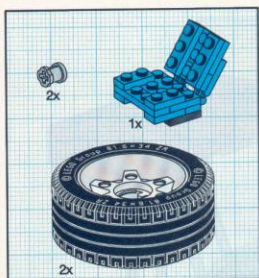

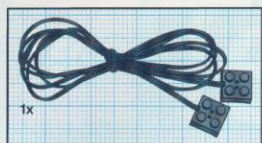

**2**  
→

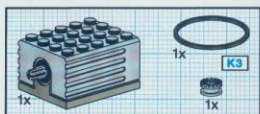
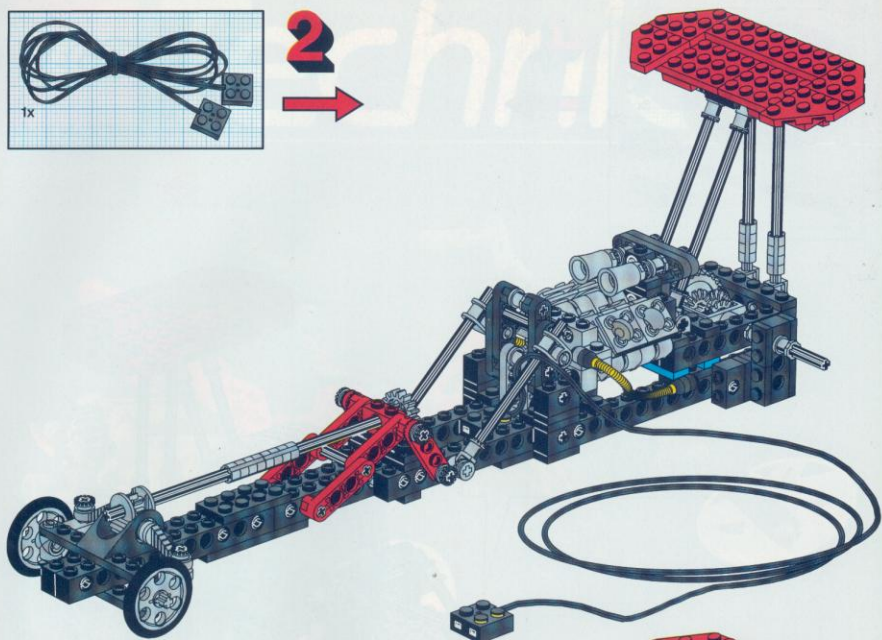

**3**  
→

