

1092 A

Technic

LEGO

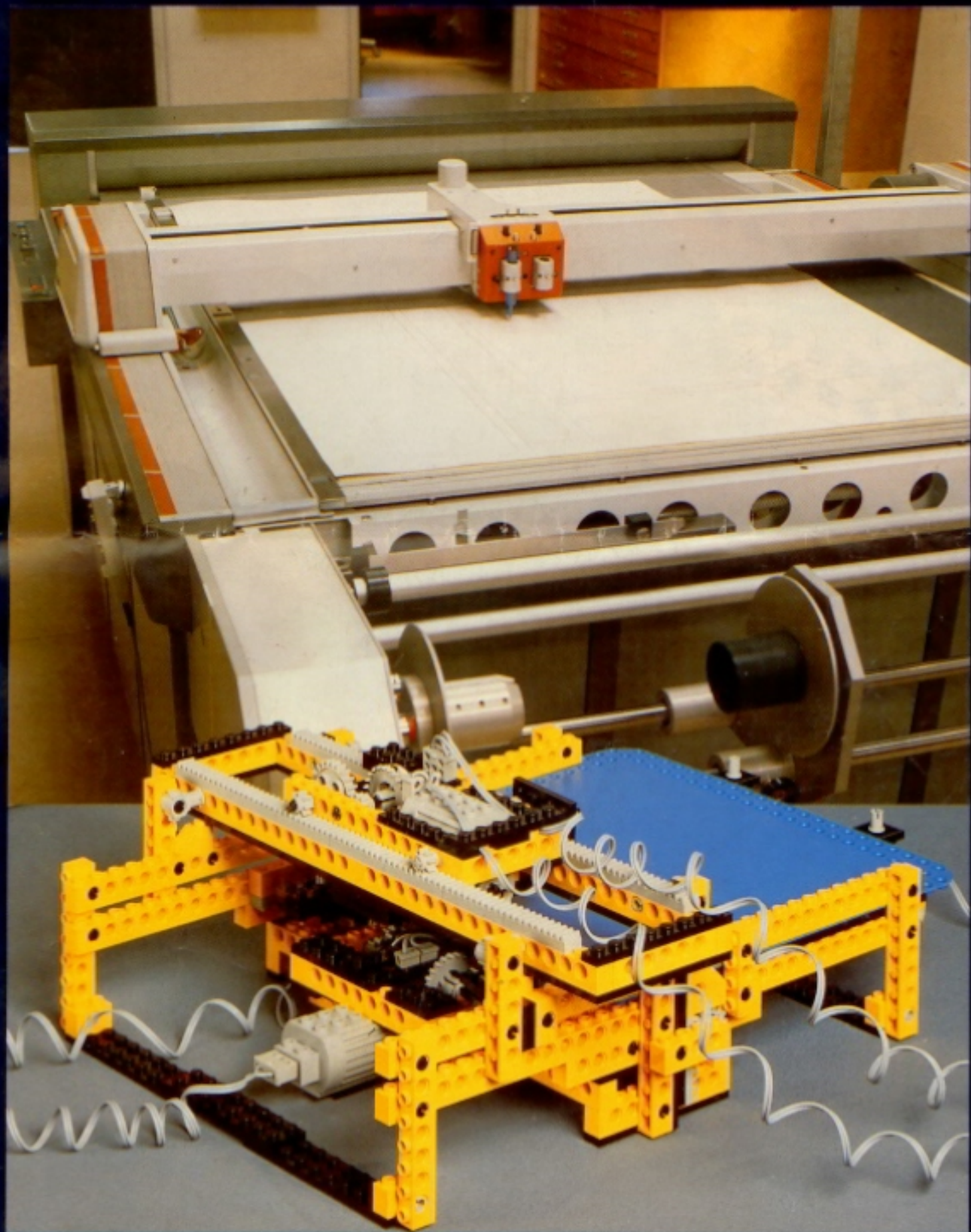



10x

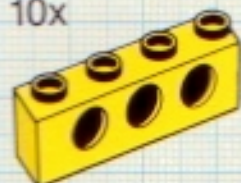

9x

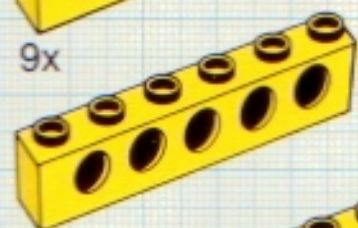

11x

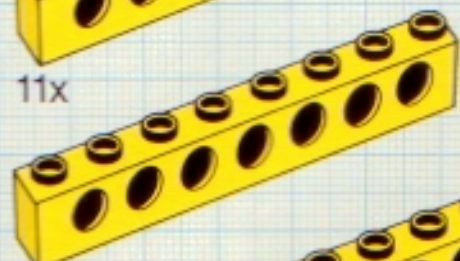

14x

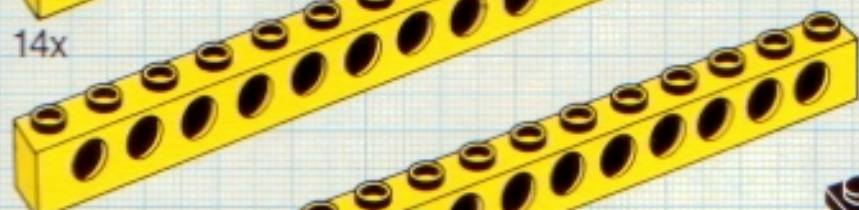

9x



14x



21x

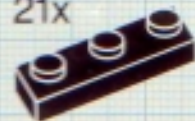

4x



12x



8x



6x

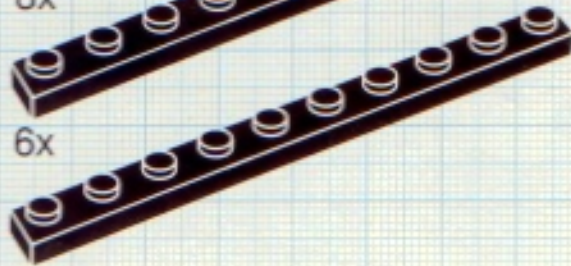

8x

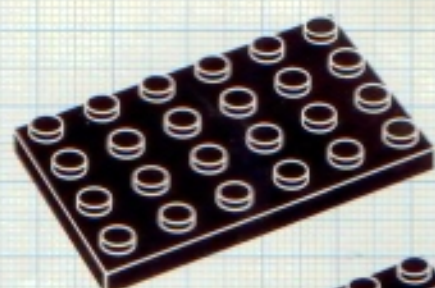

2x

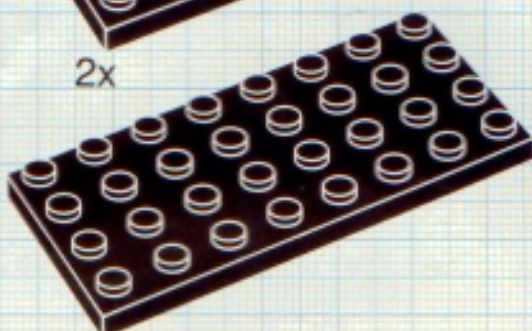

1x



8x

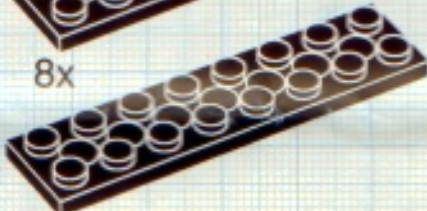

4x



3x

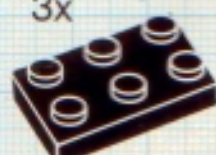

6x

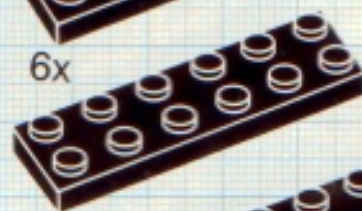

4x

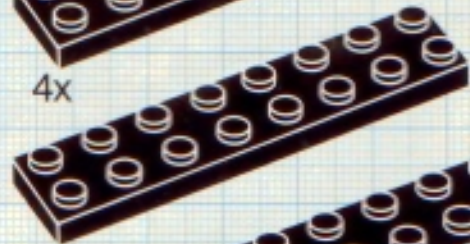

2x

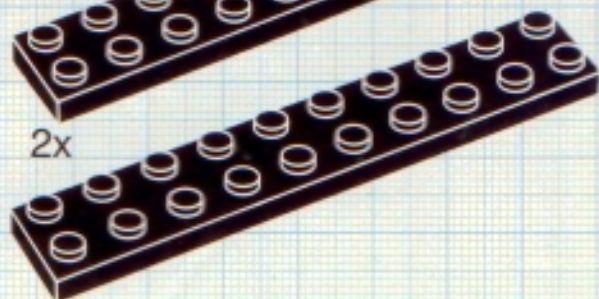

8x



6x



3x



2x



12x



6x



6x



2x



4x



7x



2x



7x



6x

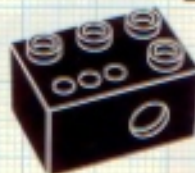

2x



2x



2x



28x



6x



6x

1x

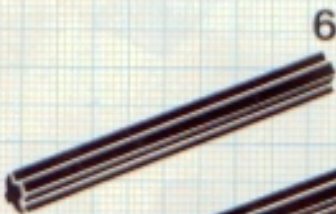

6



8



10



12

1x



2x



2x



4x



6x



3x

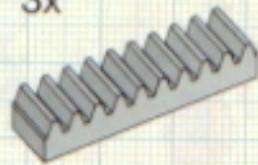

28x

4



2x



1x

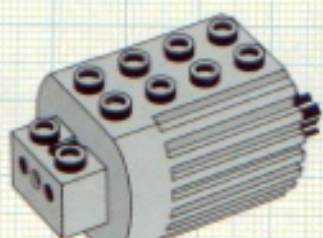

3x

1

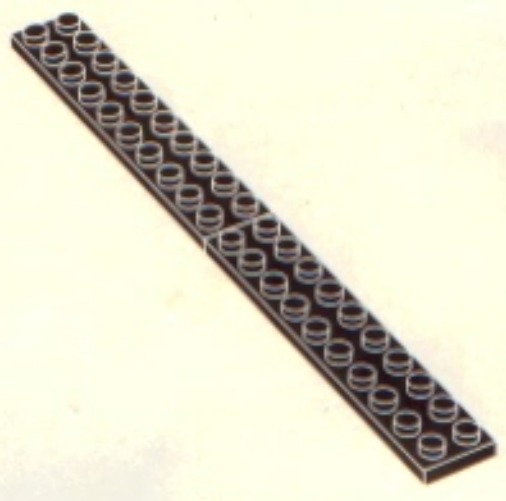

2

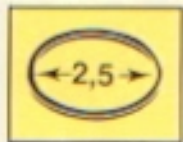
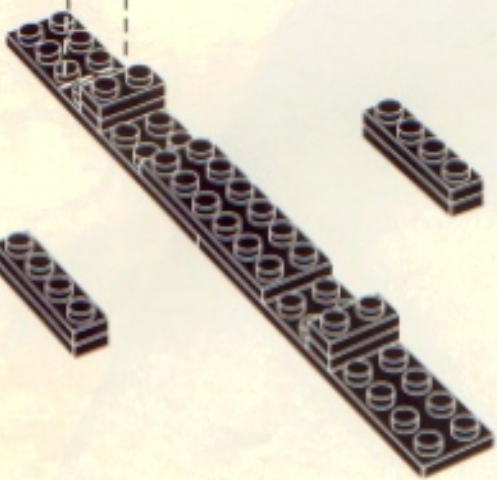

3

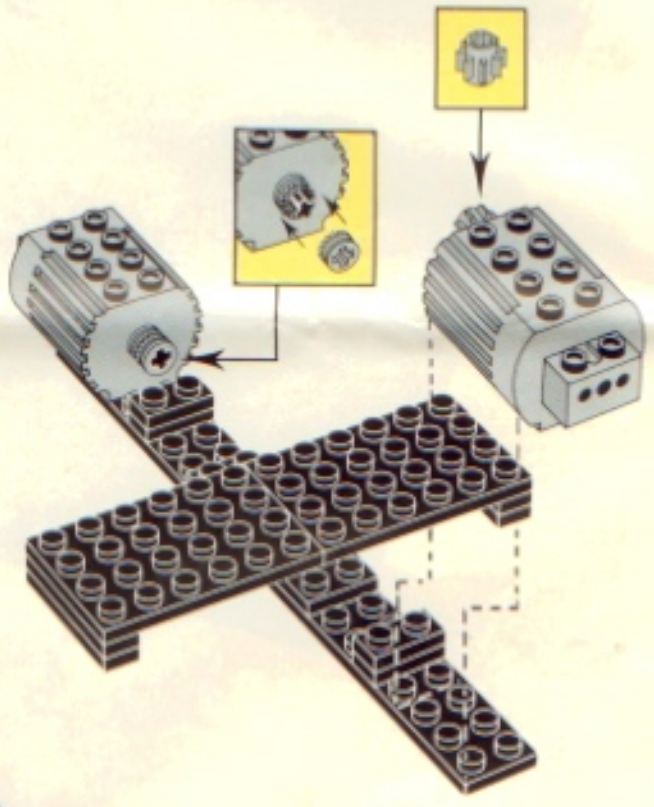

4

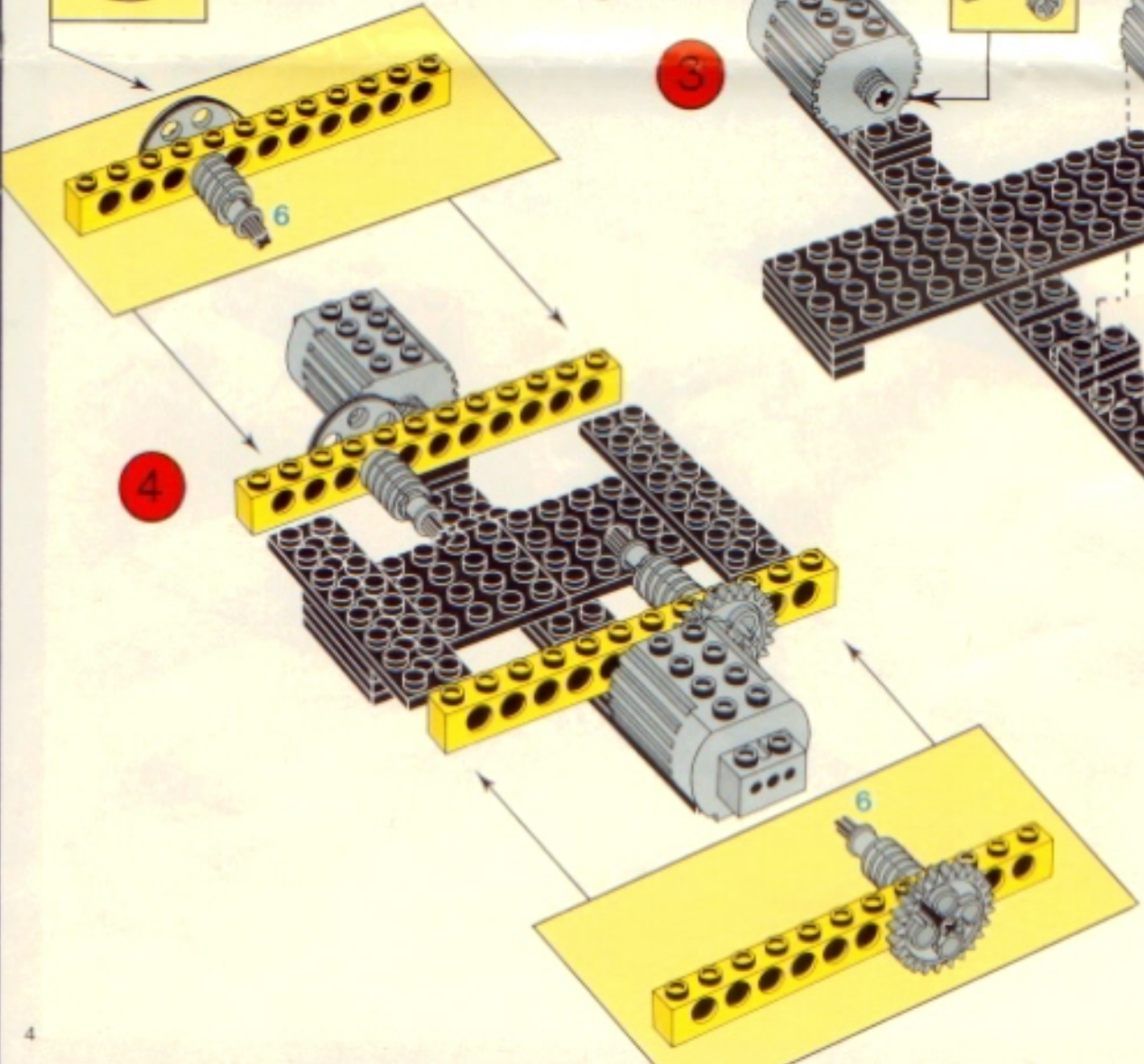

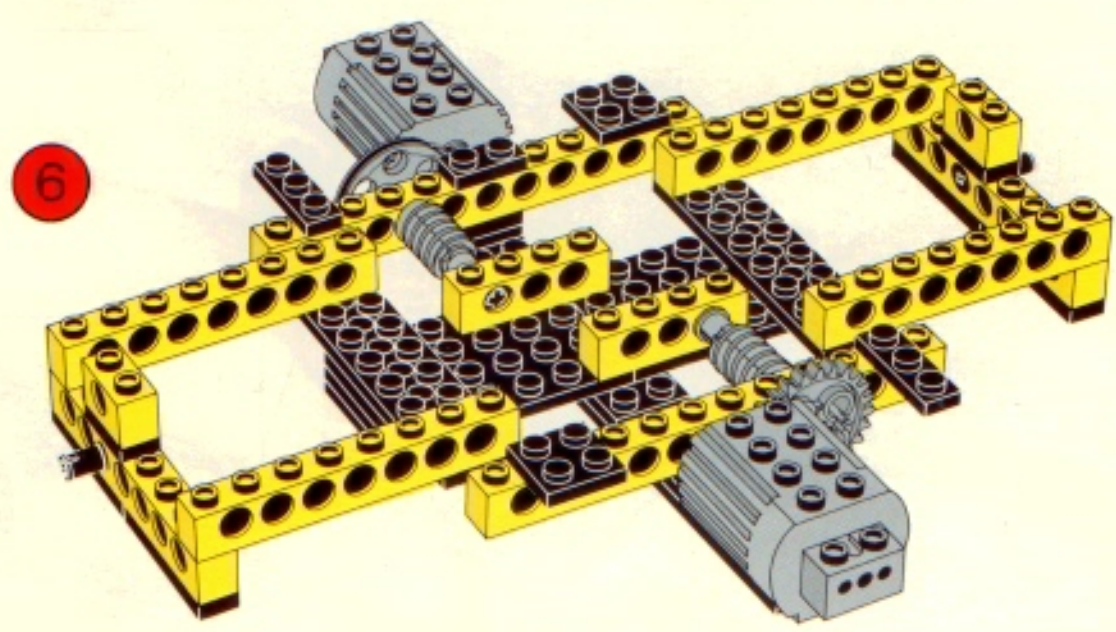
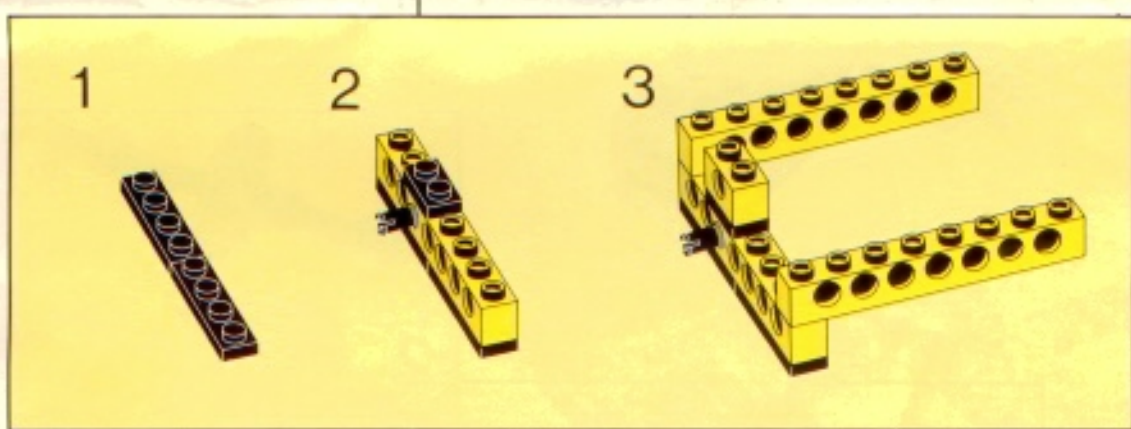
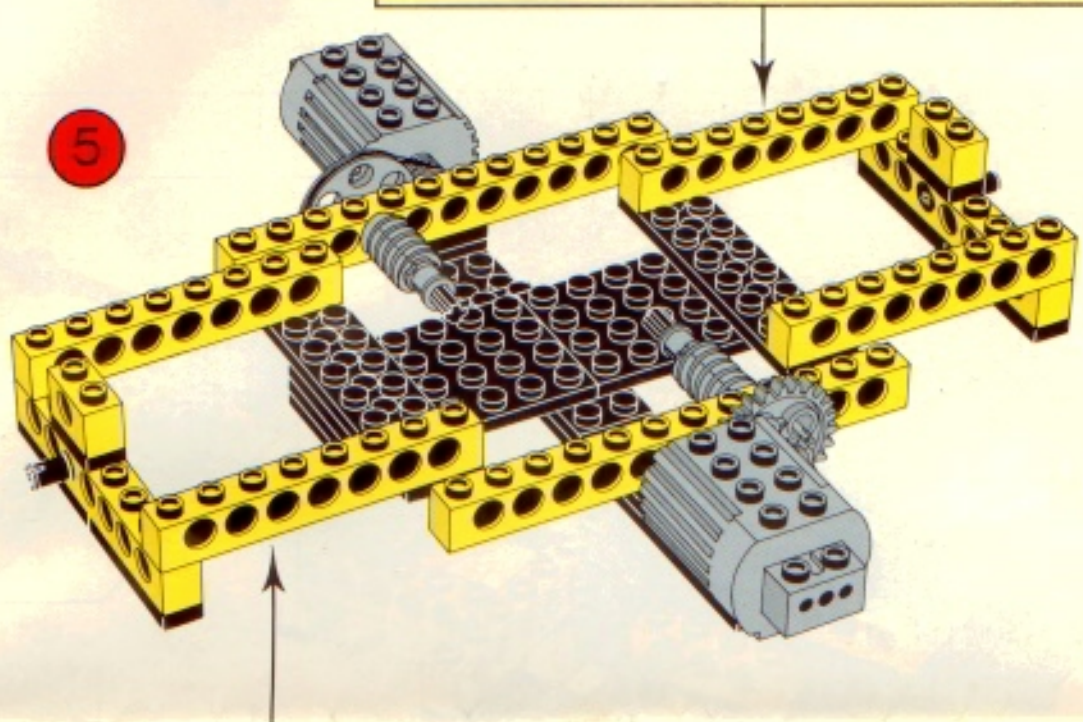
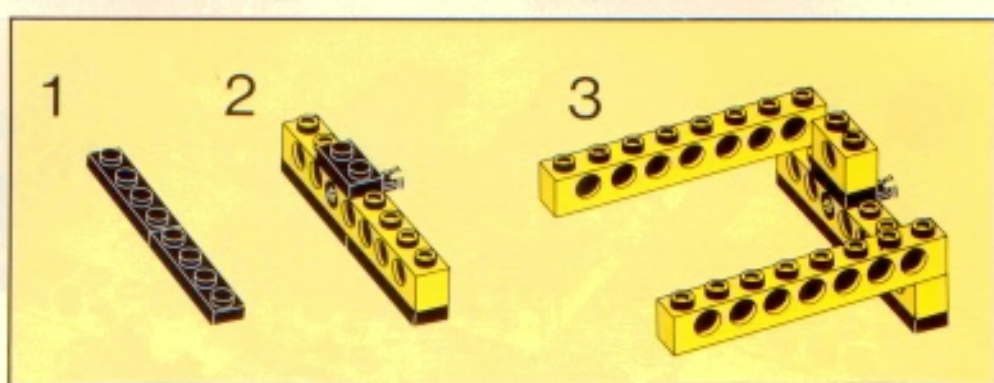

7

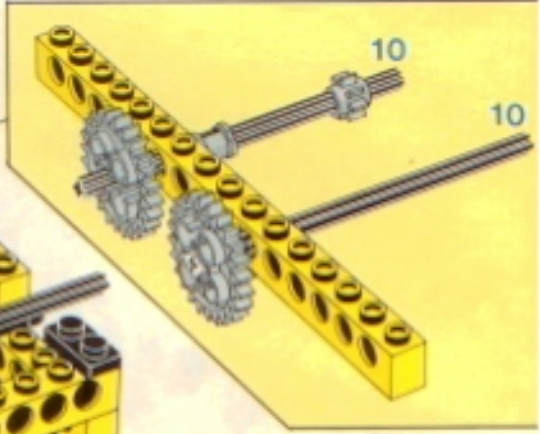
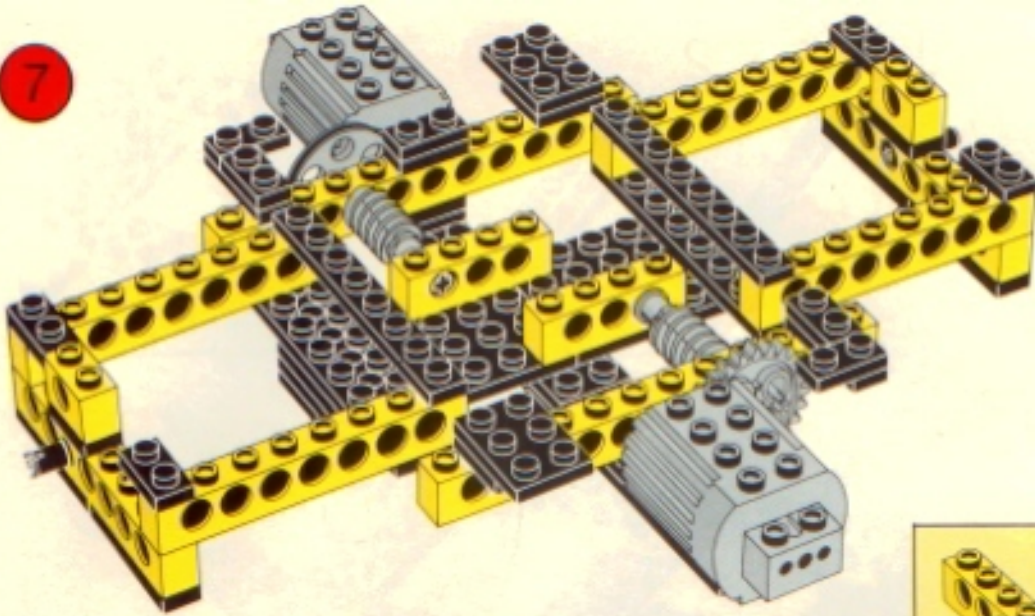

8

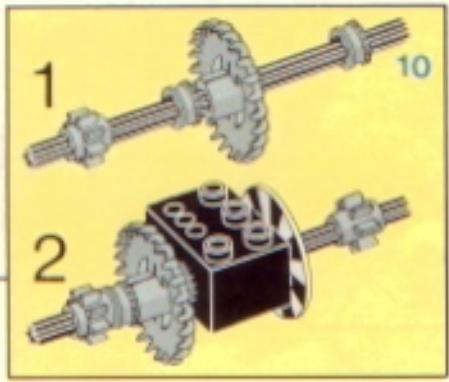
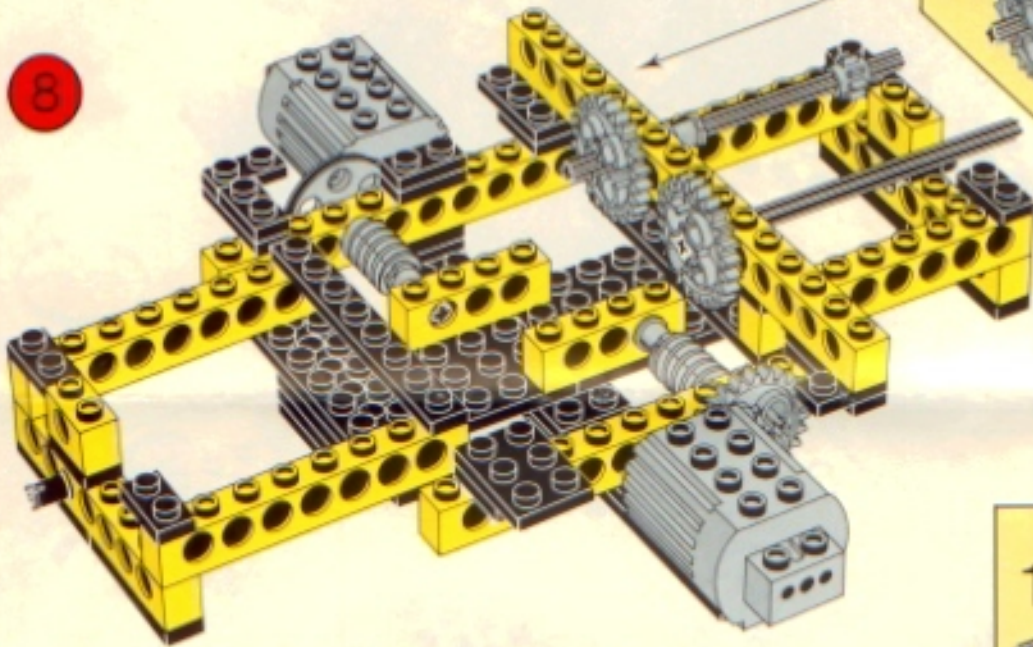

9

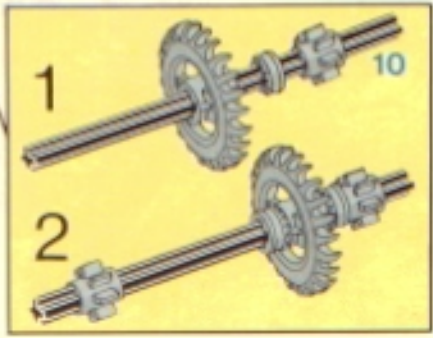
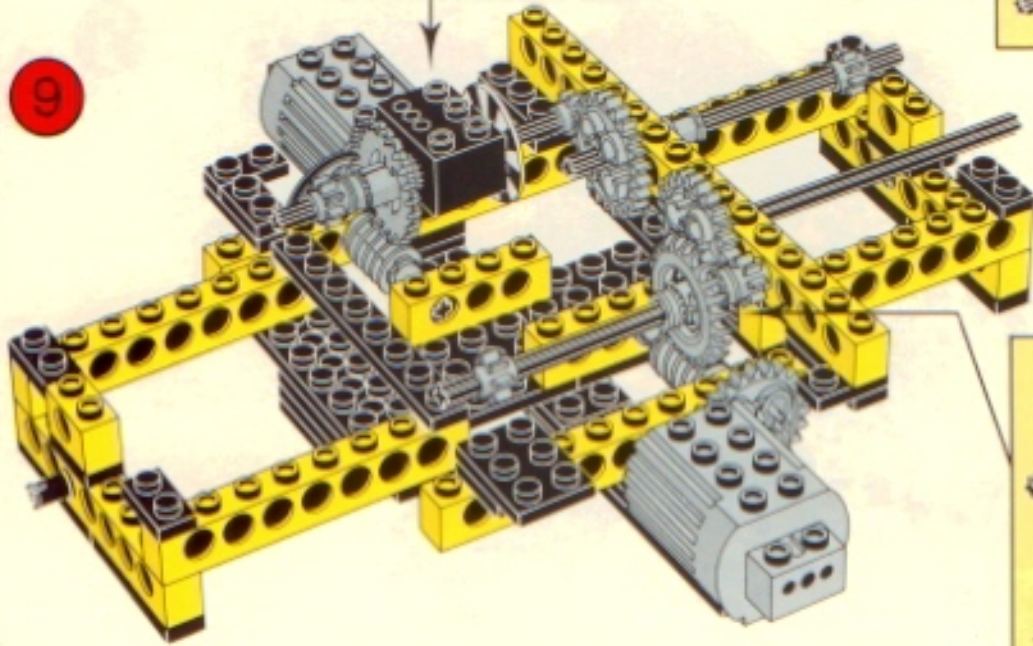

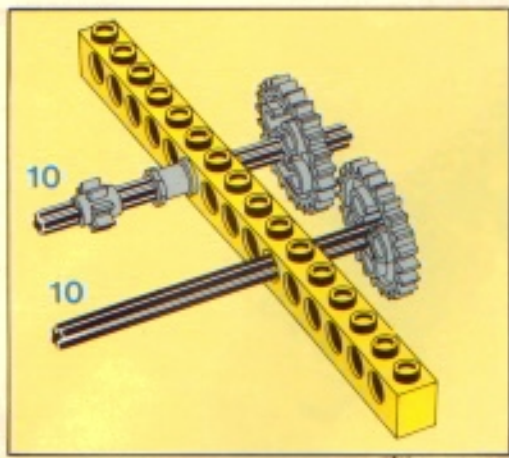

10

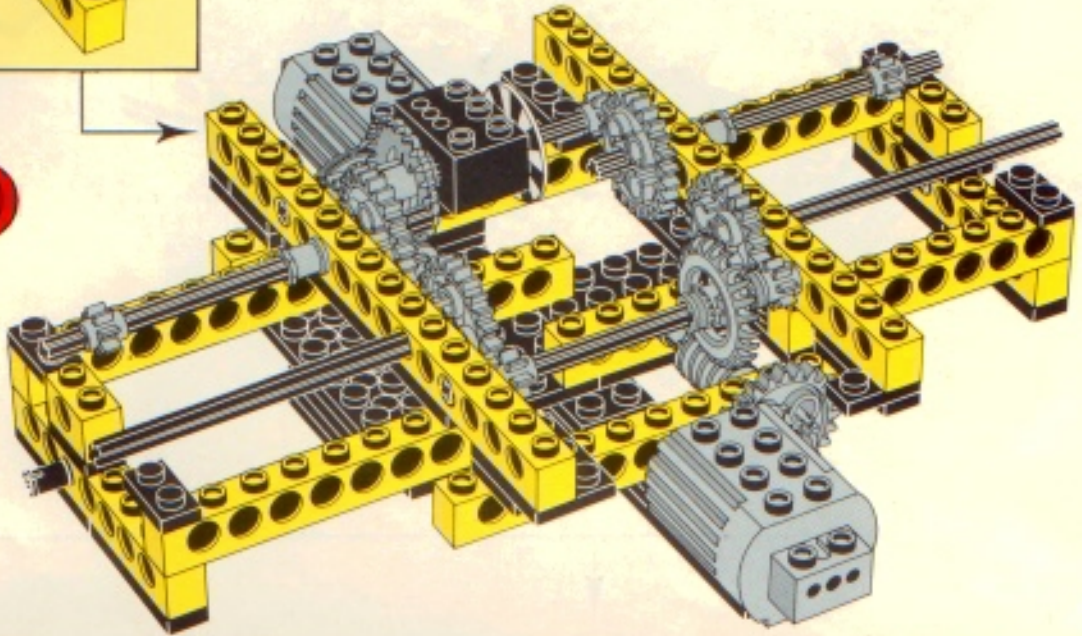

11

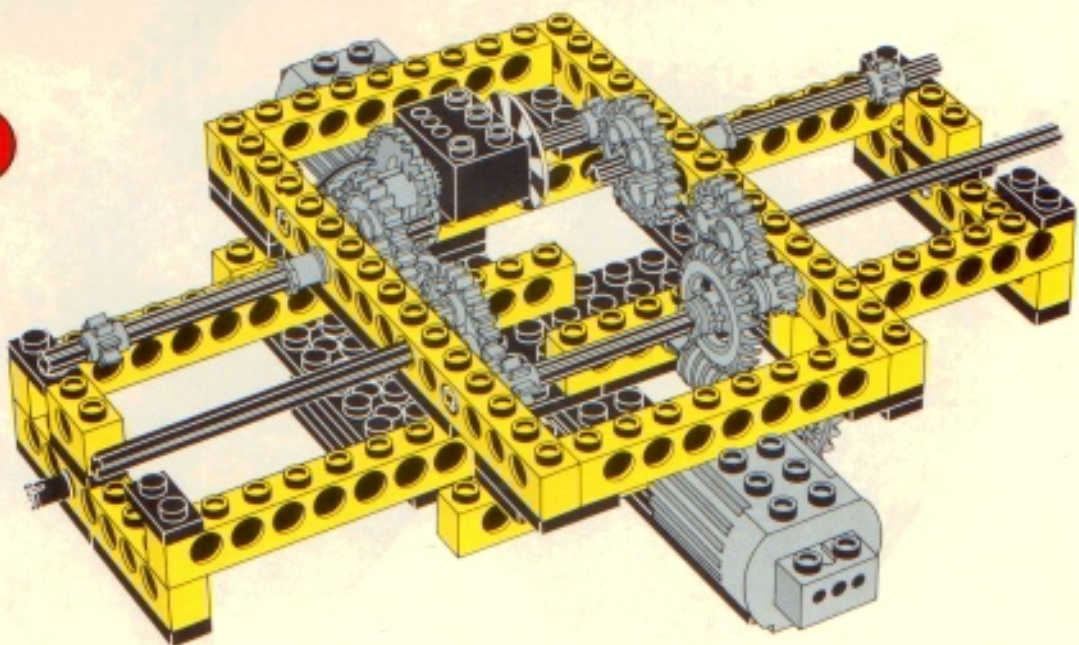

12

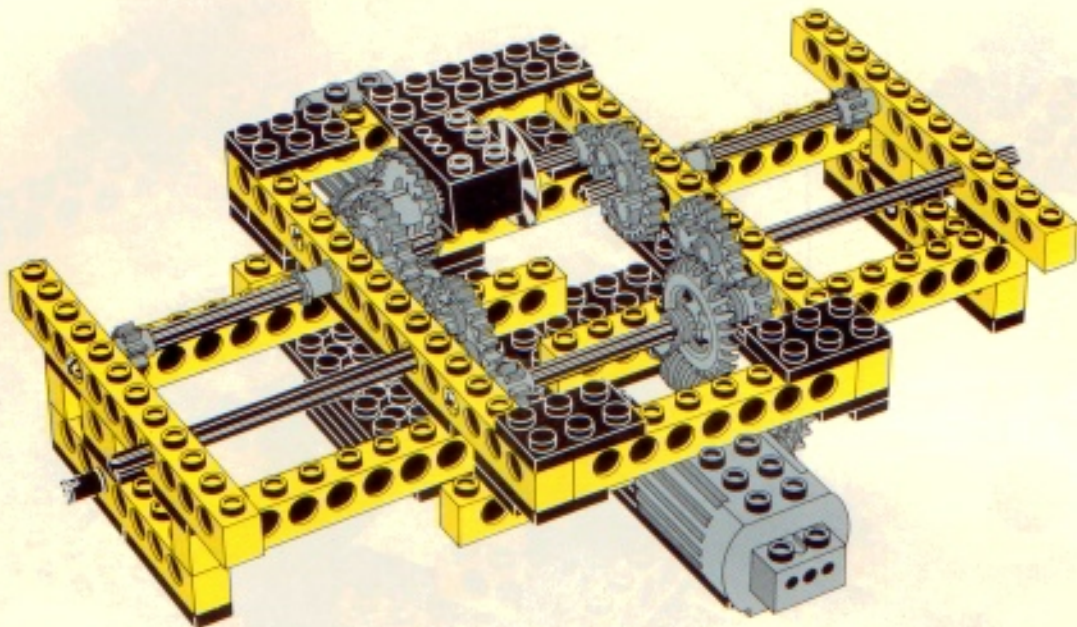

13

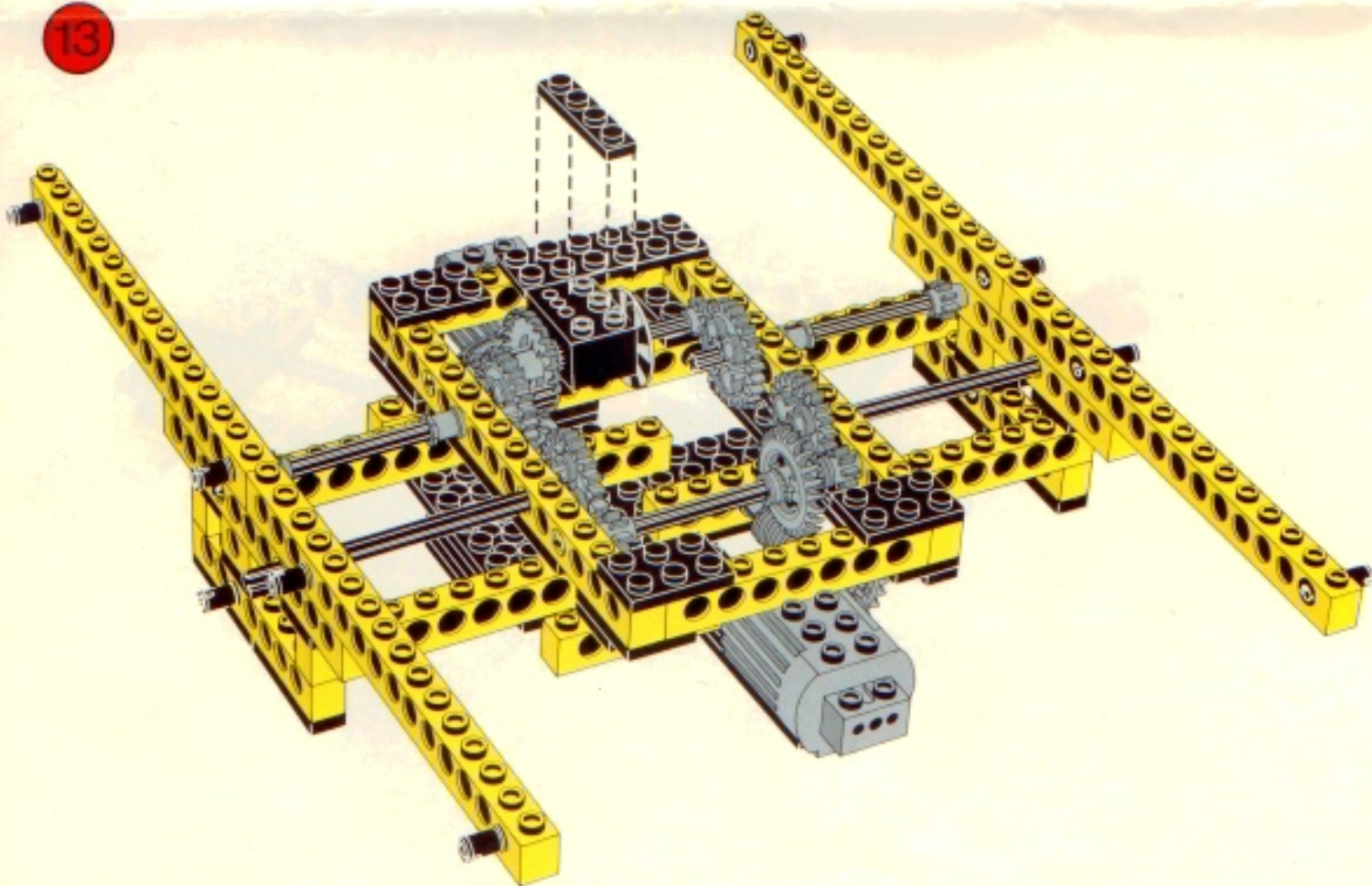



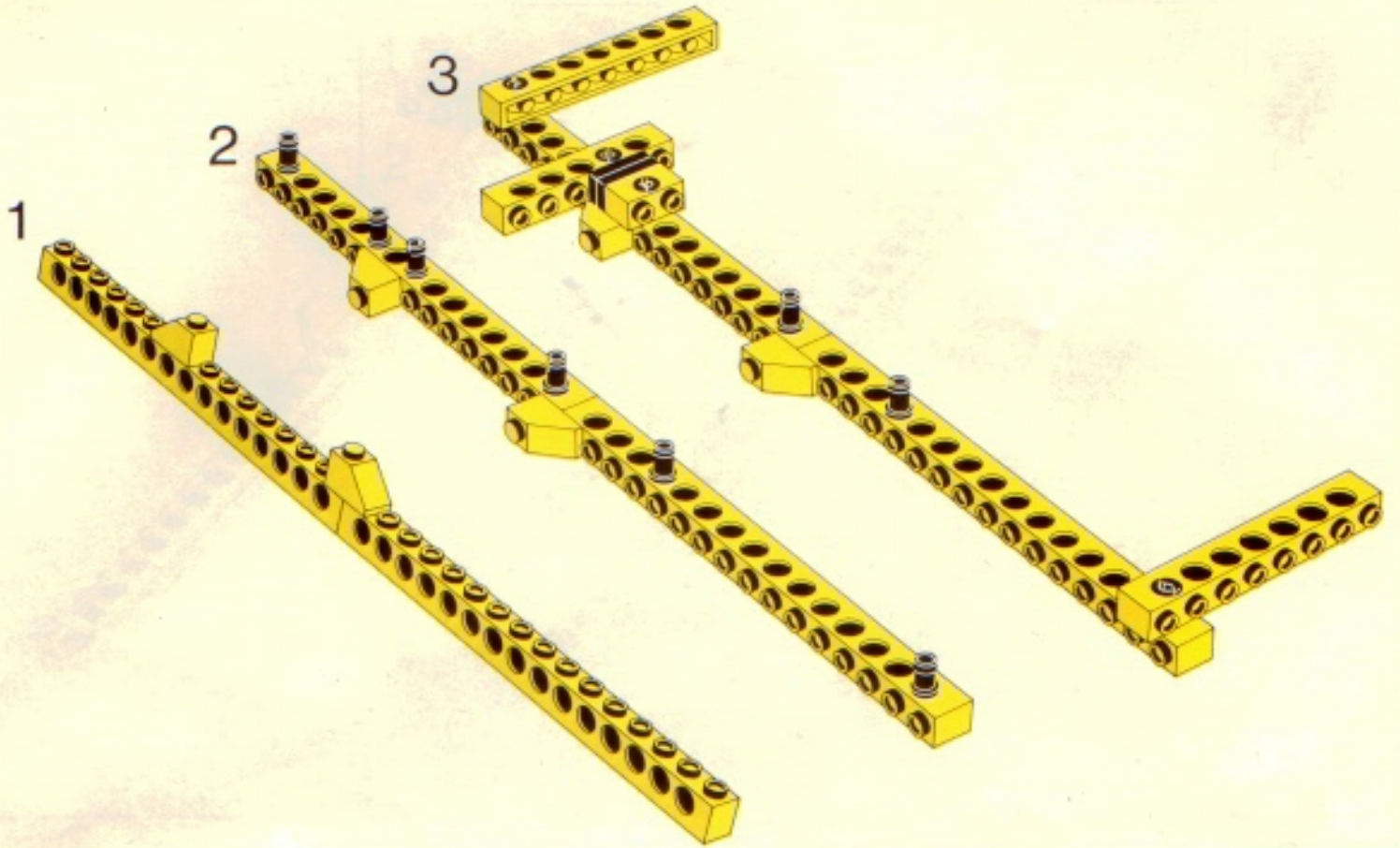

14

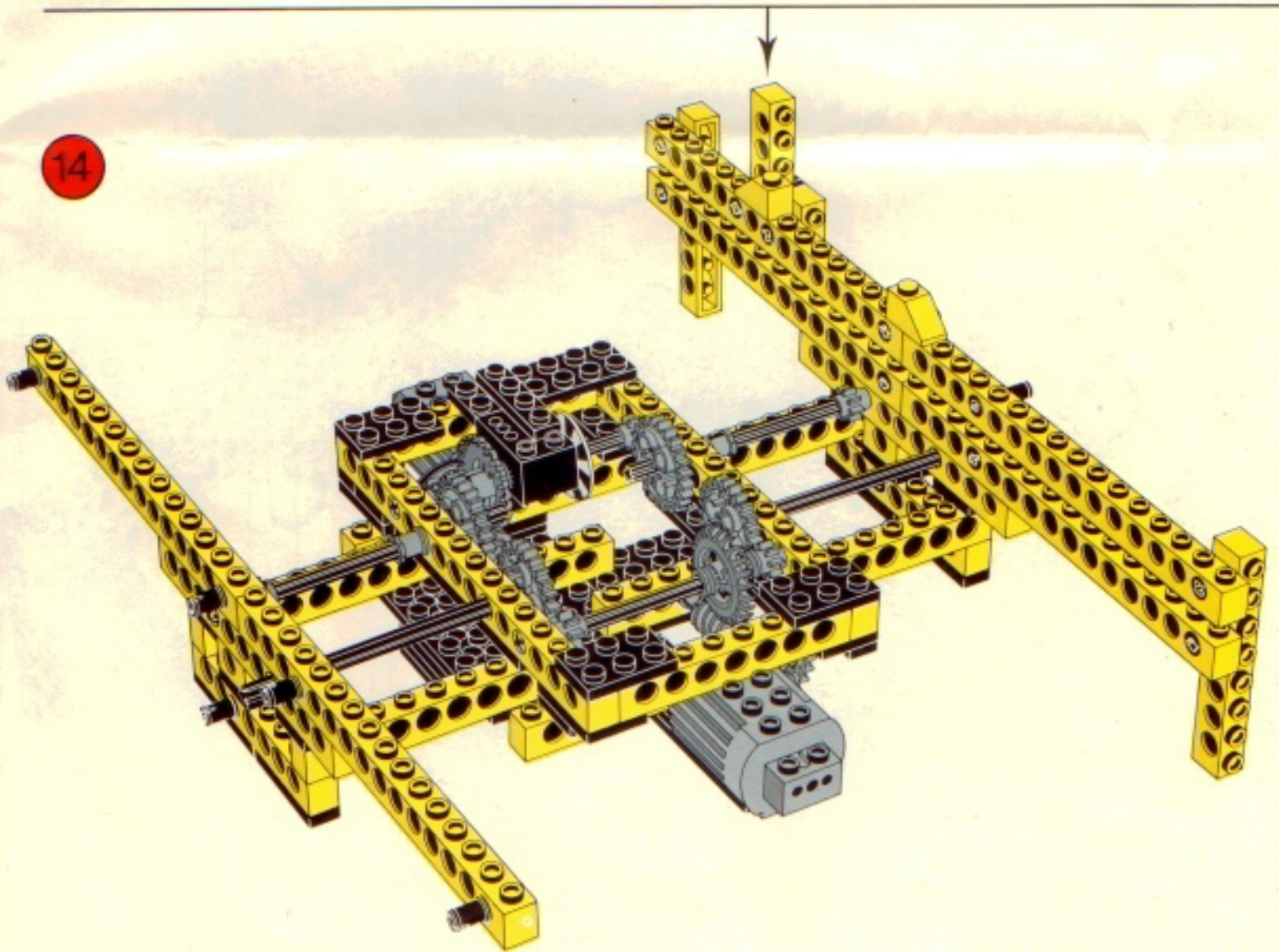

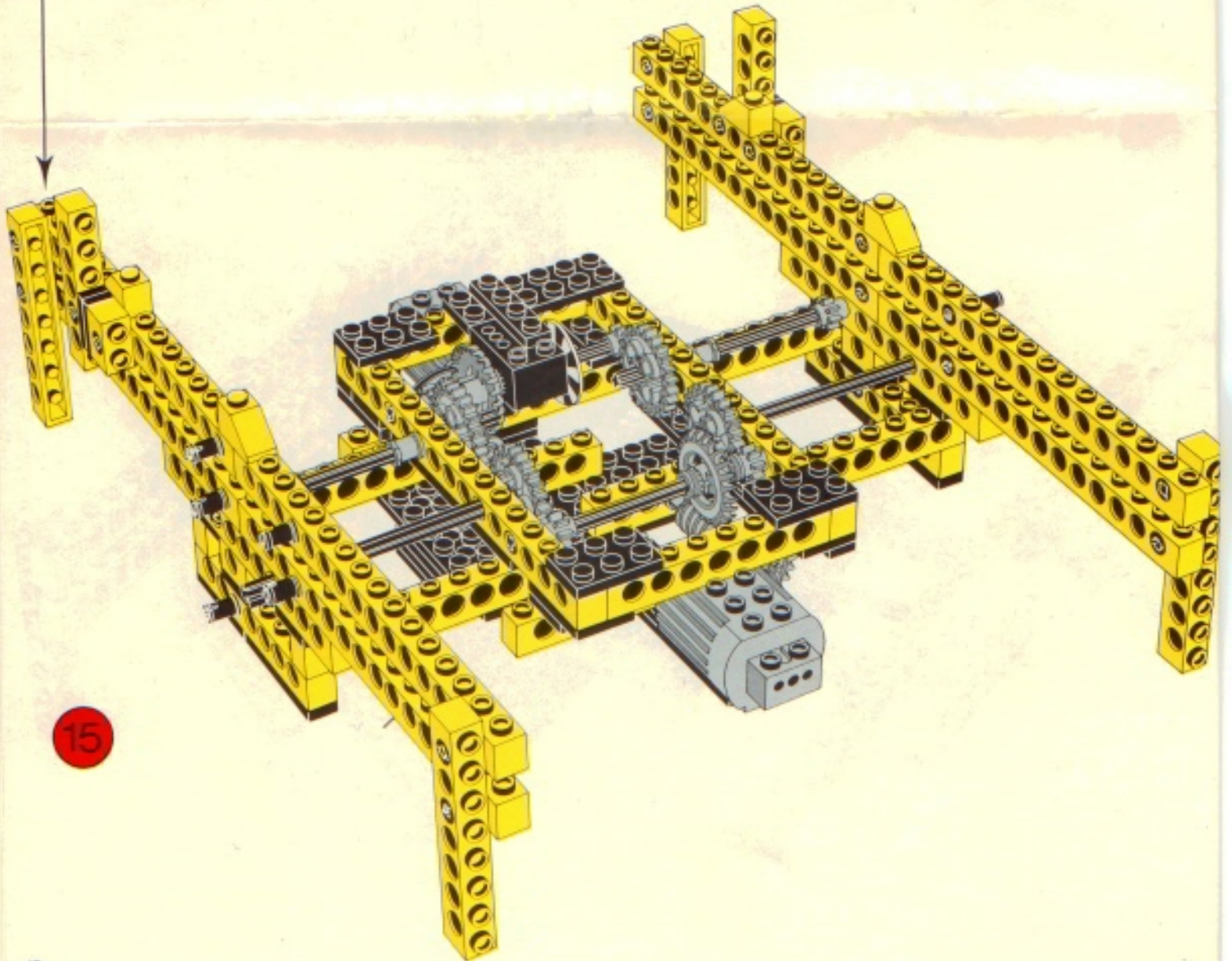
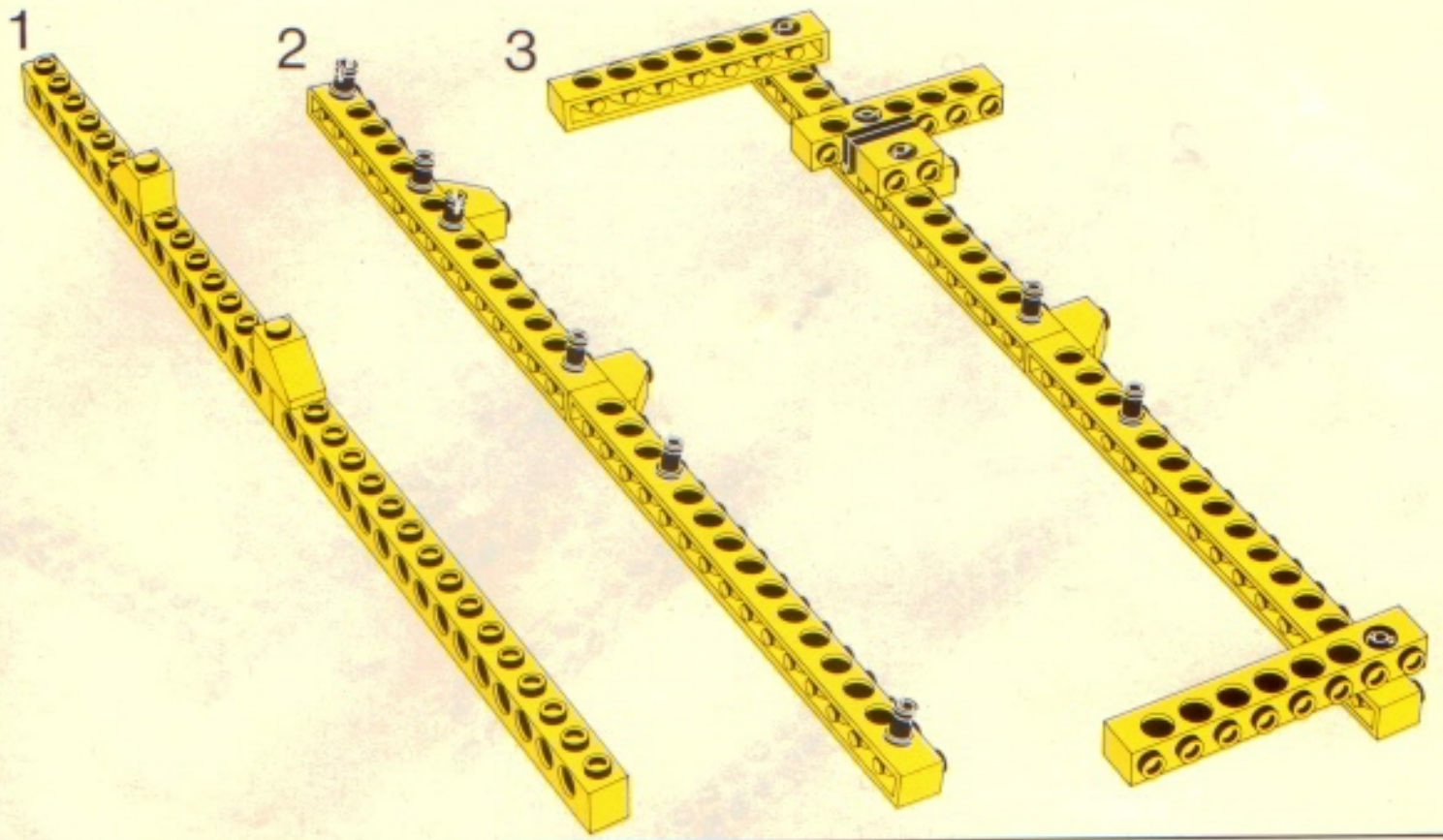

15

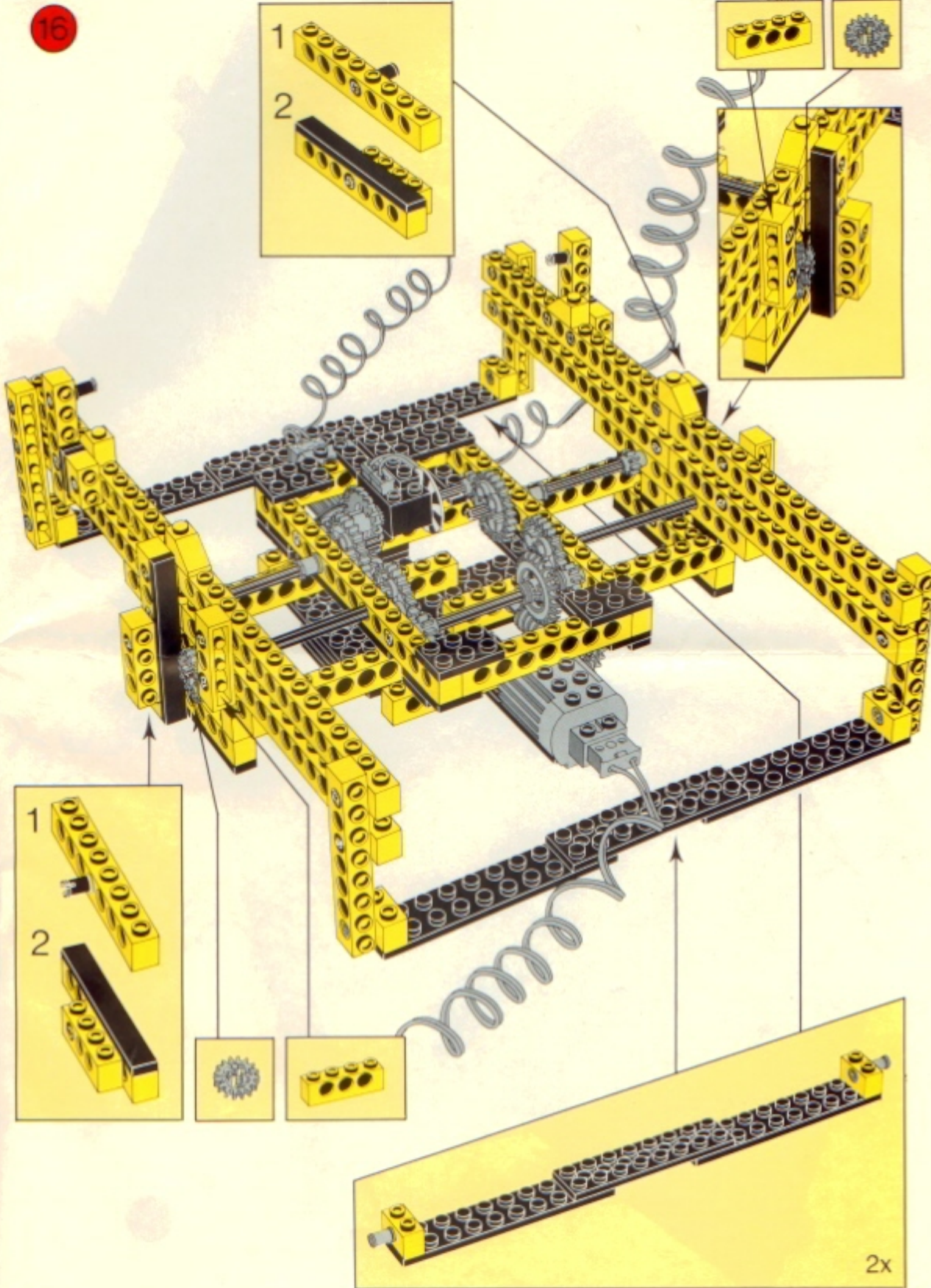



1

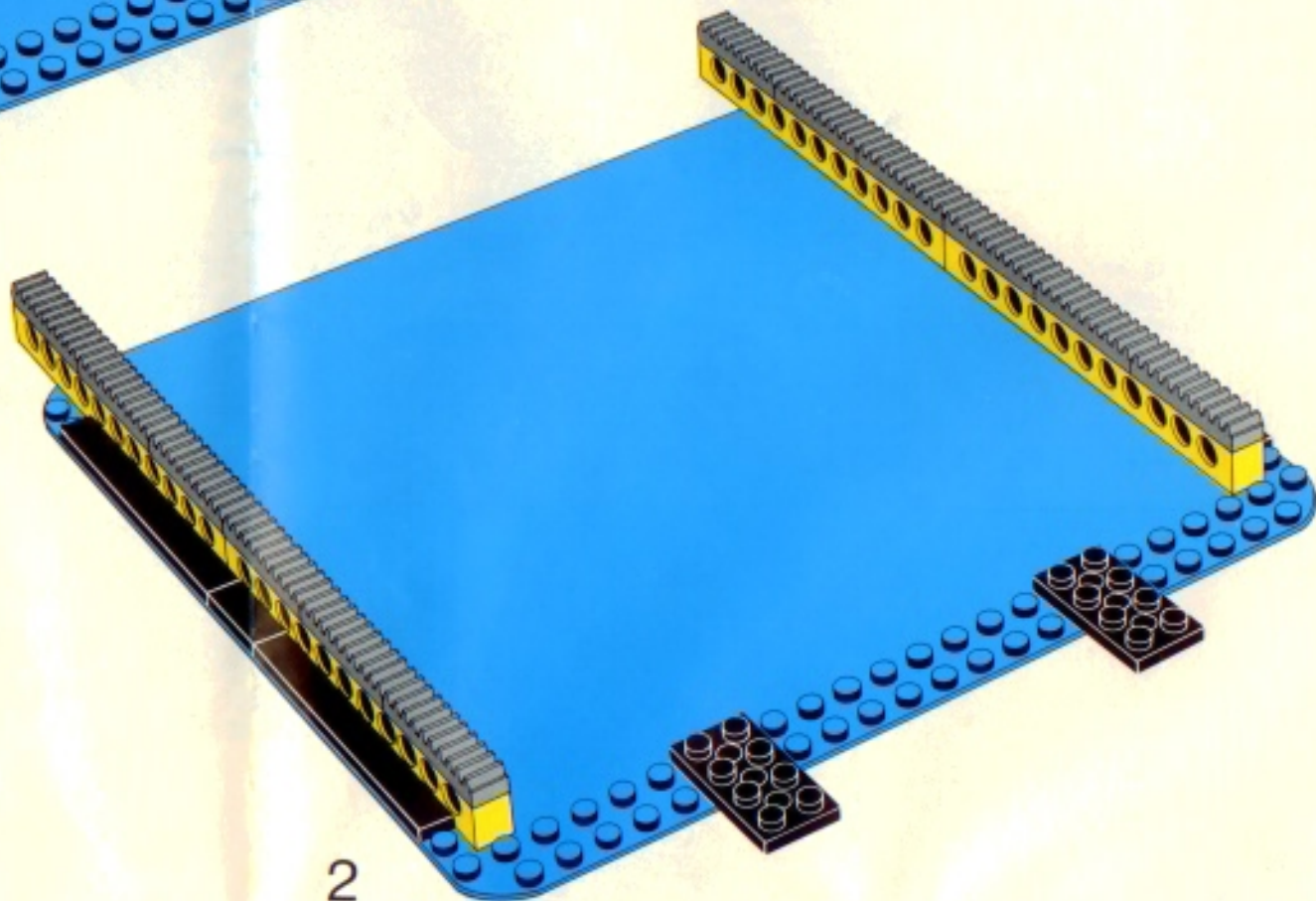

2

17

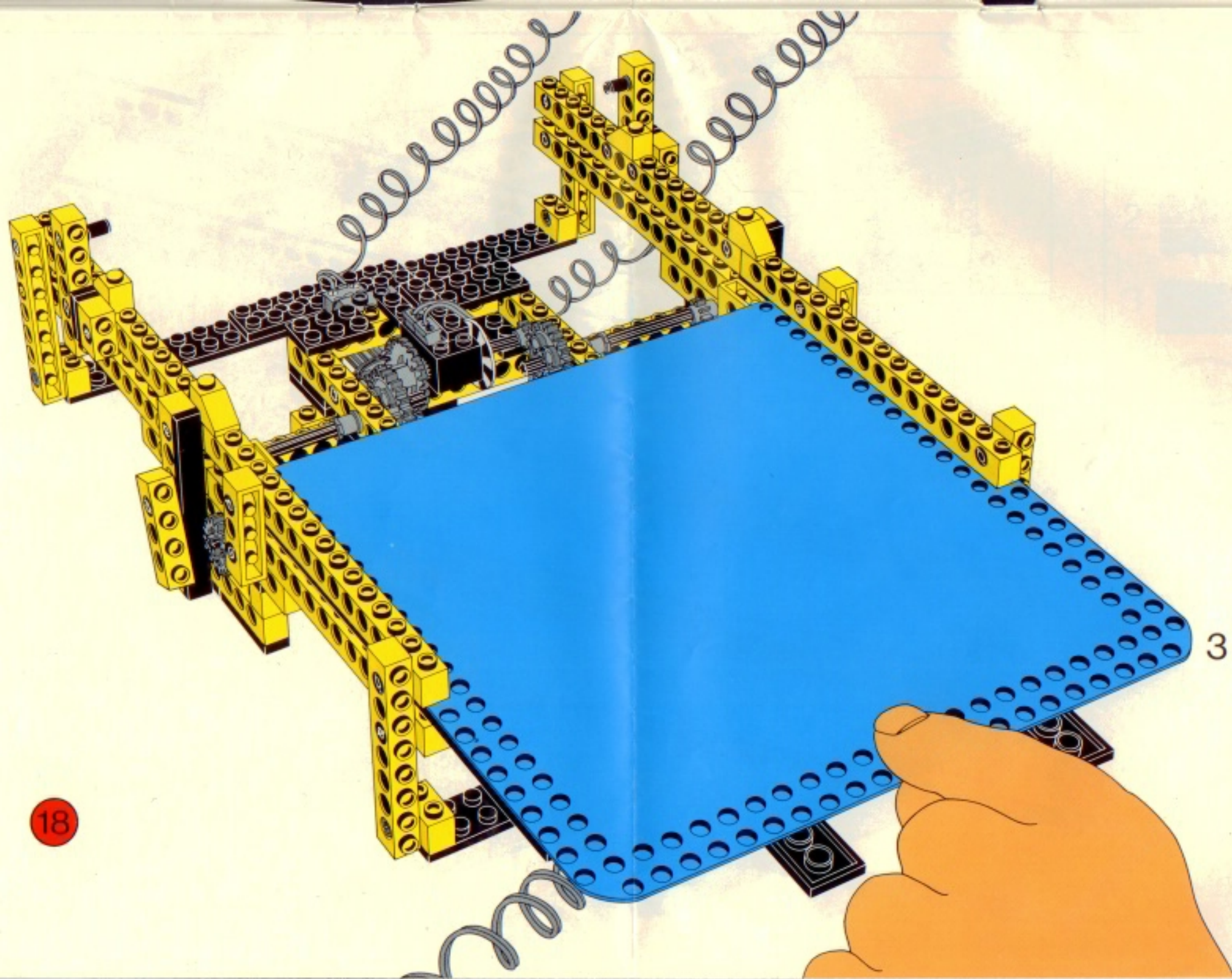

18

3

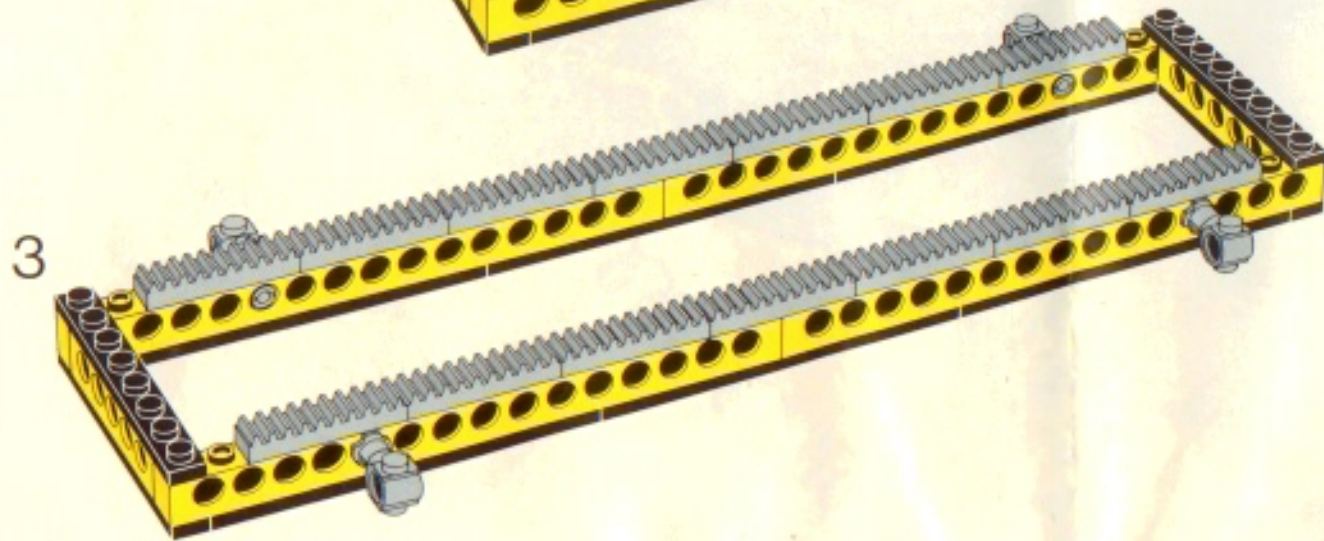
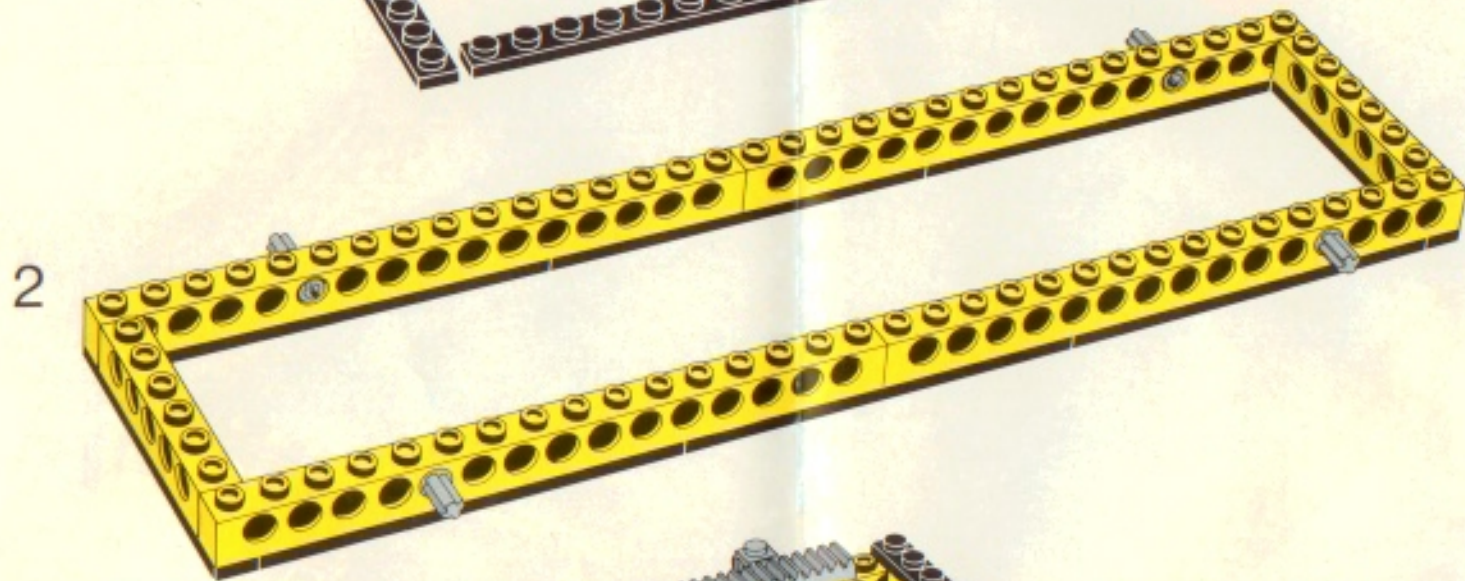
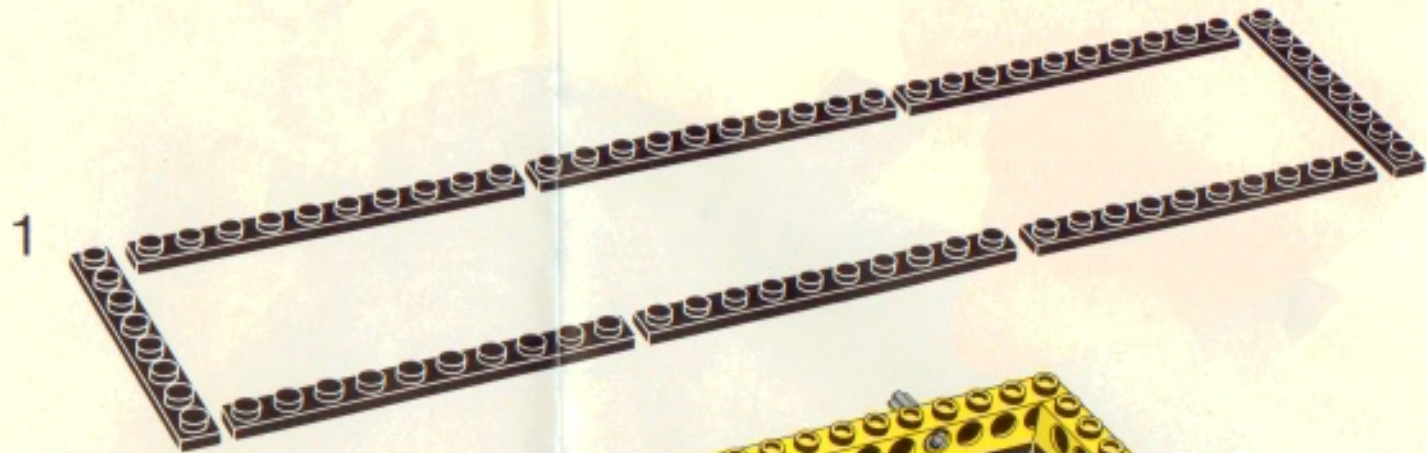

19

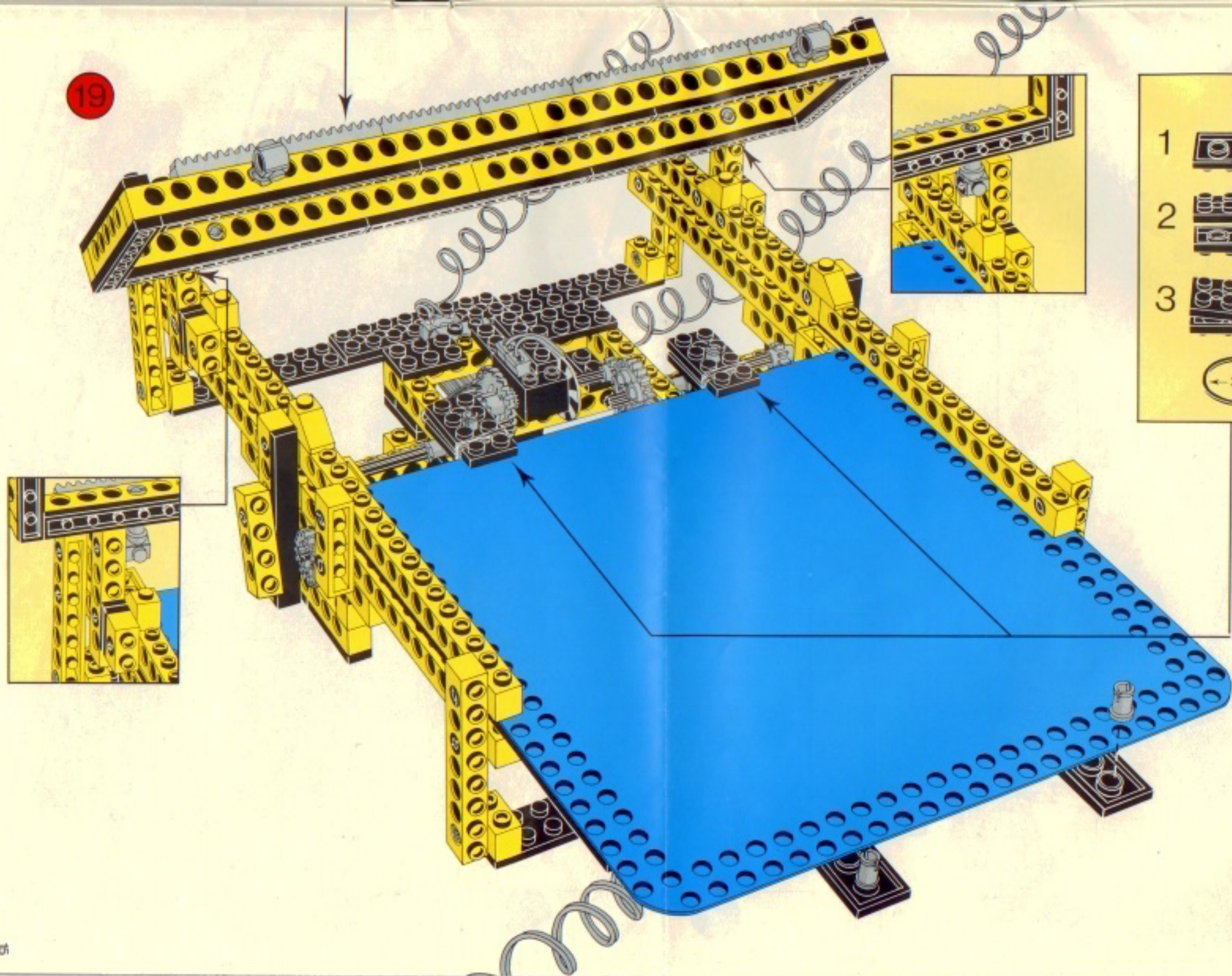

1

2

3

1

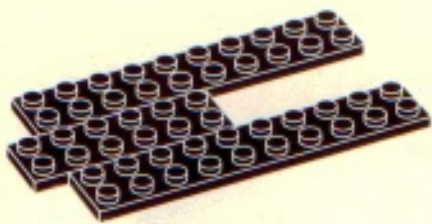

2

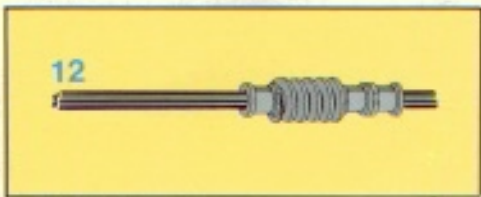
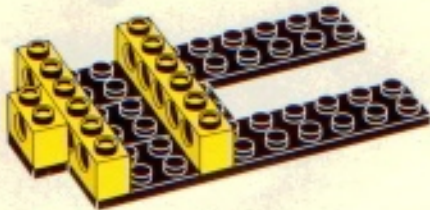

3

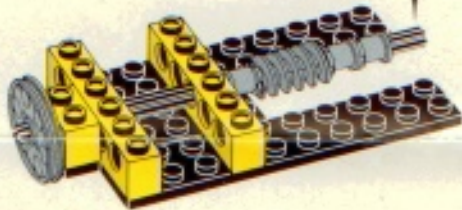

4

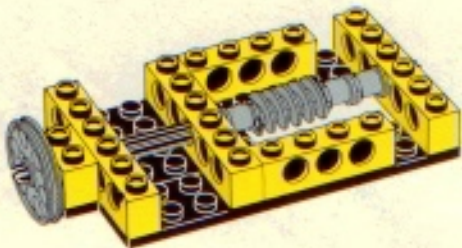

5

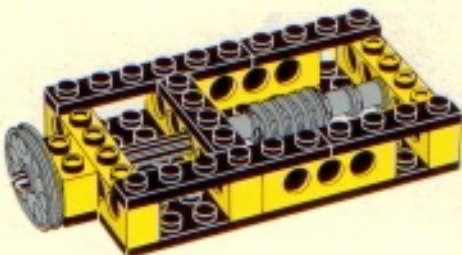

6

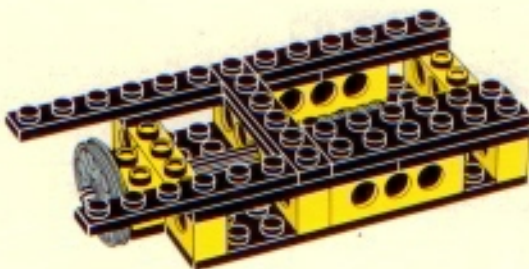

1

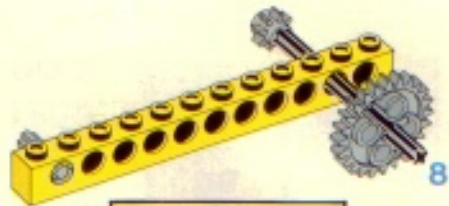

2



7

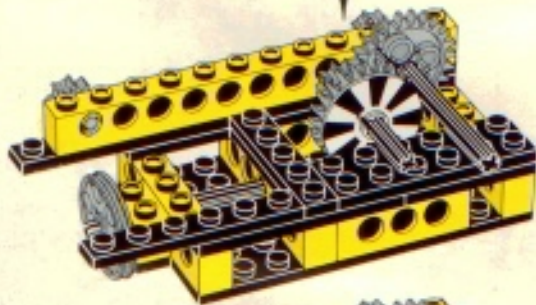

8

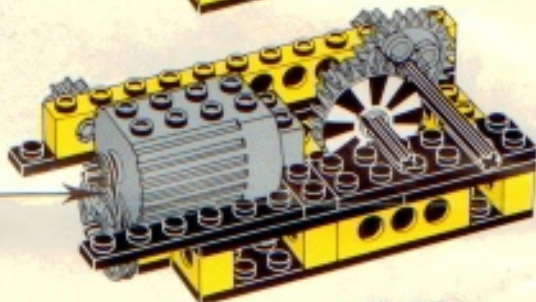
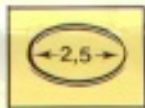

9

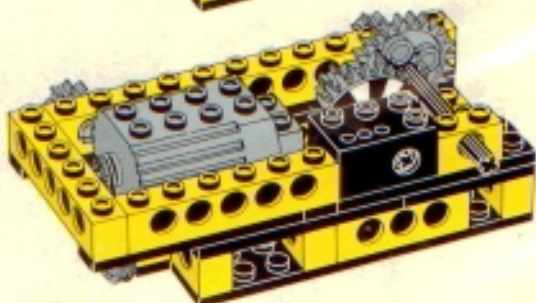

10

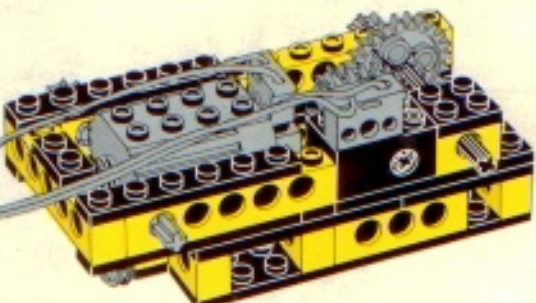

11

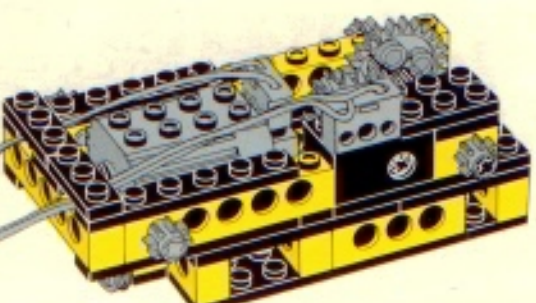



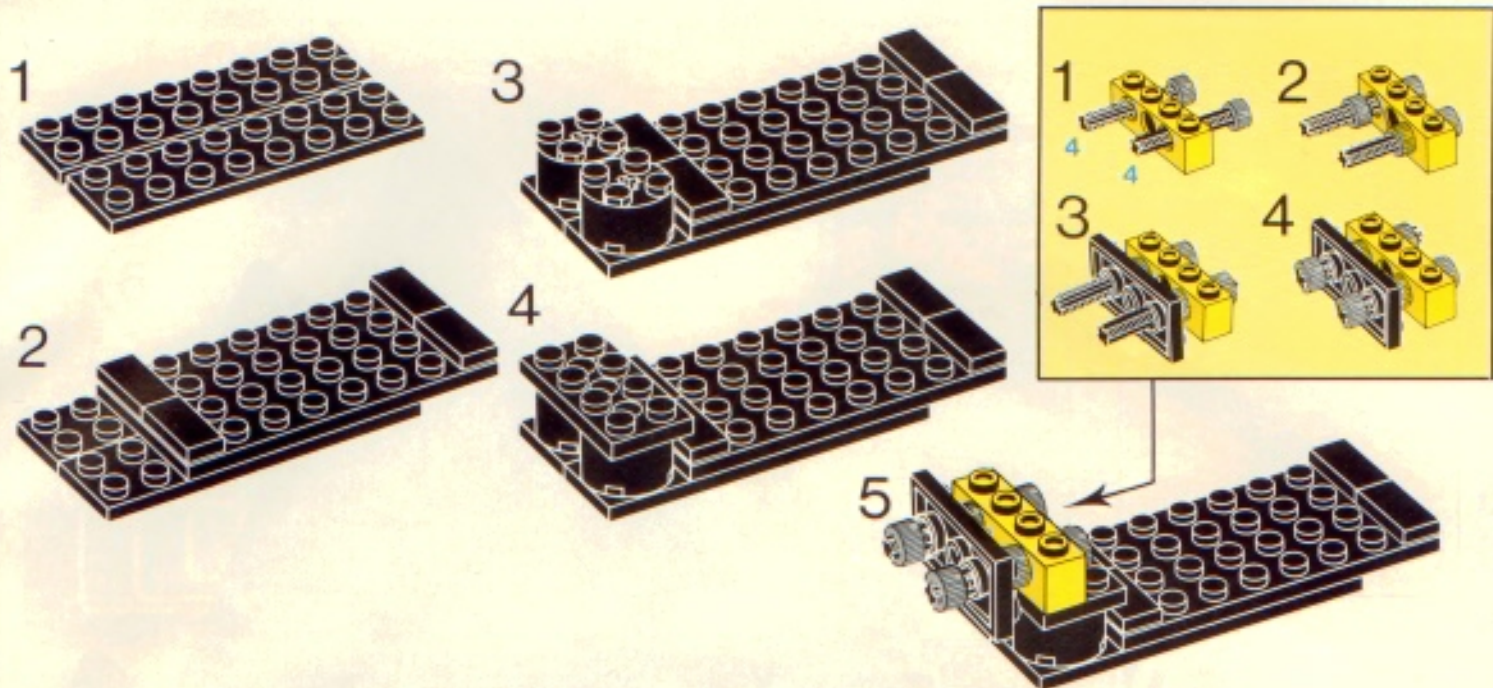

20

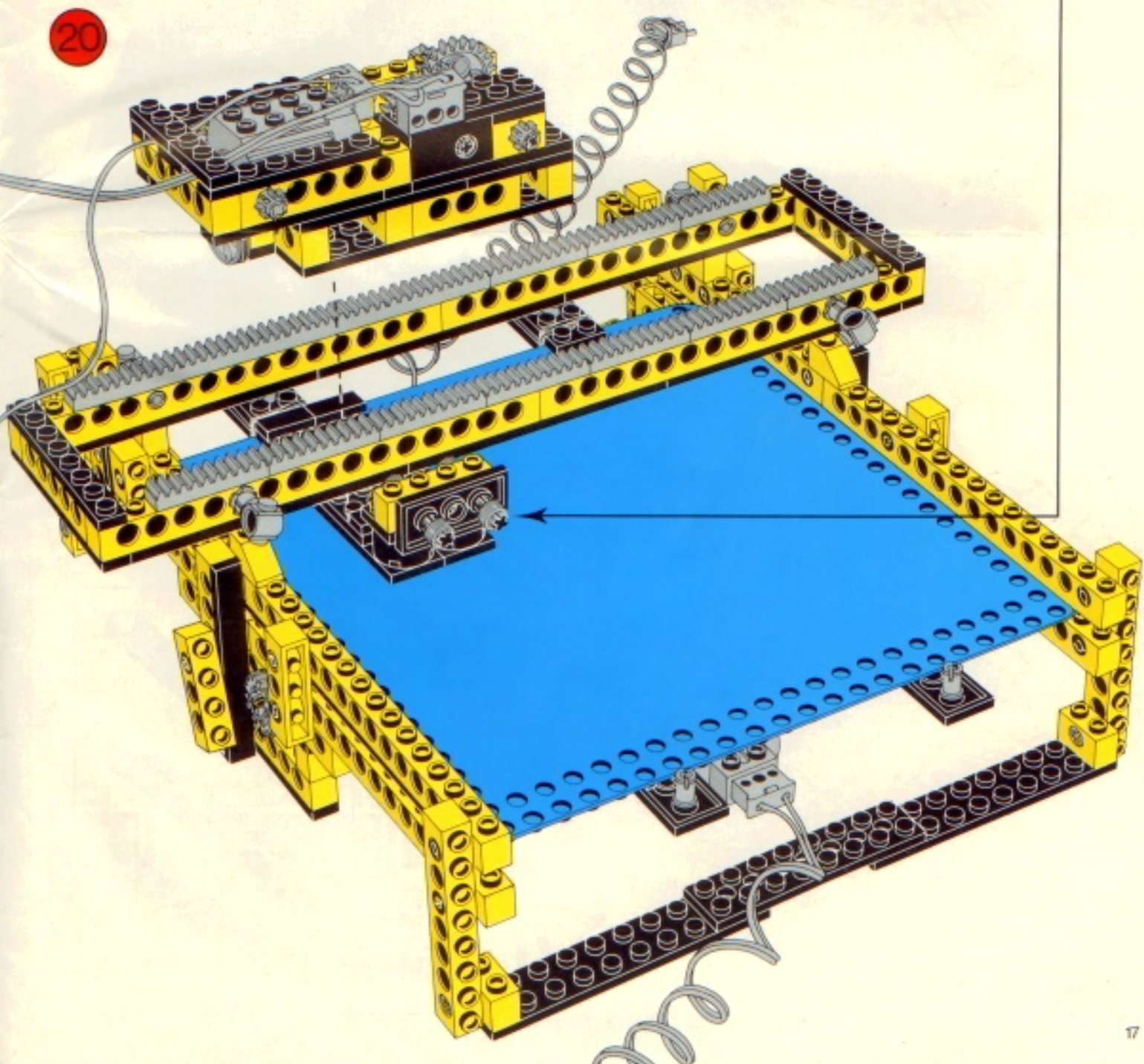

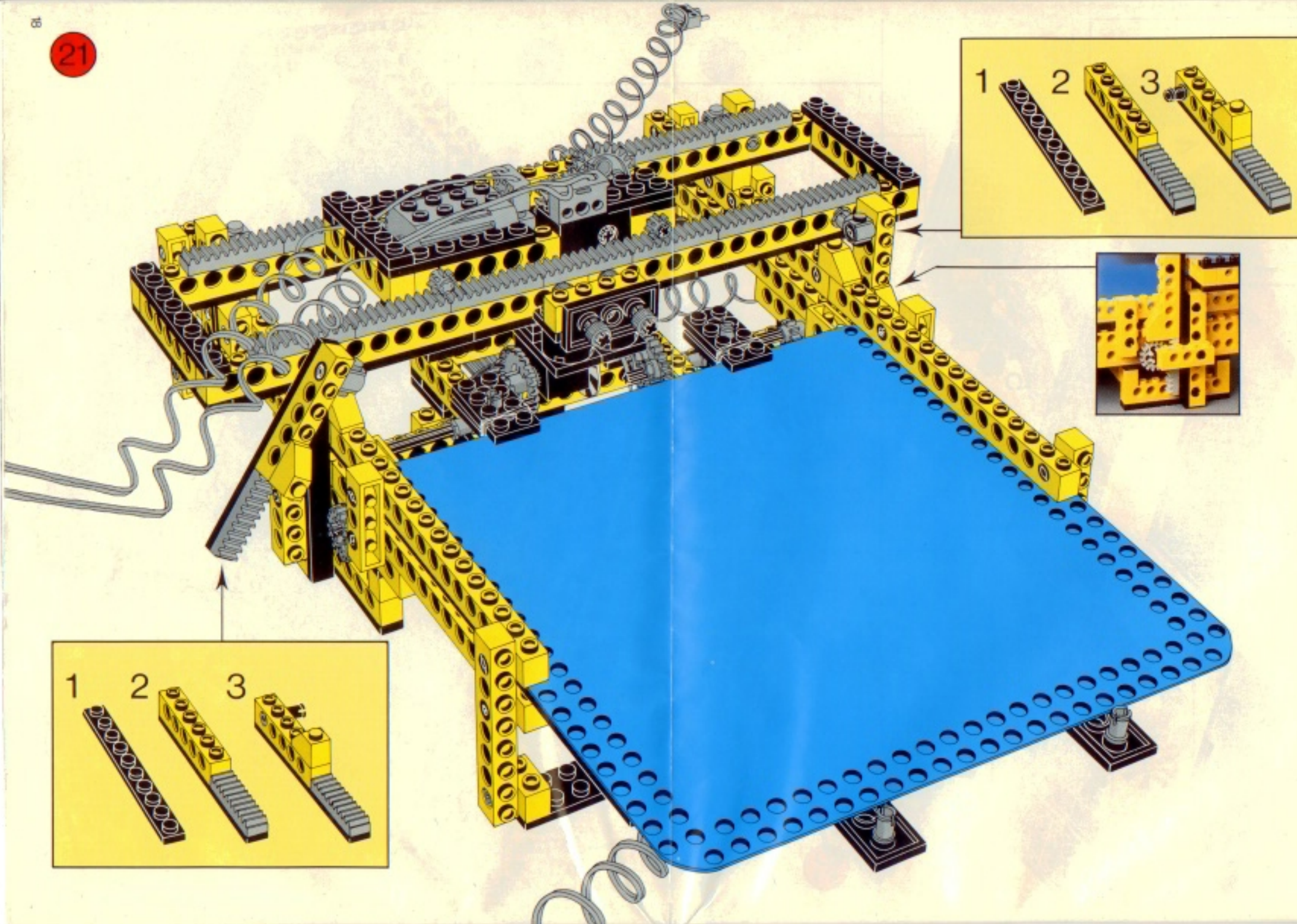

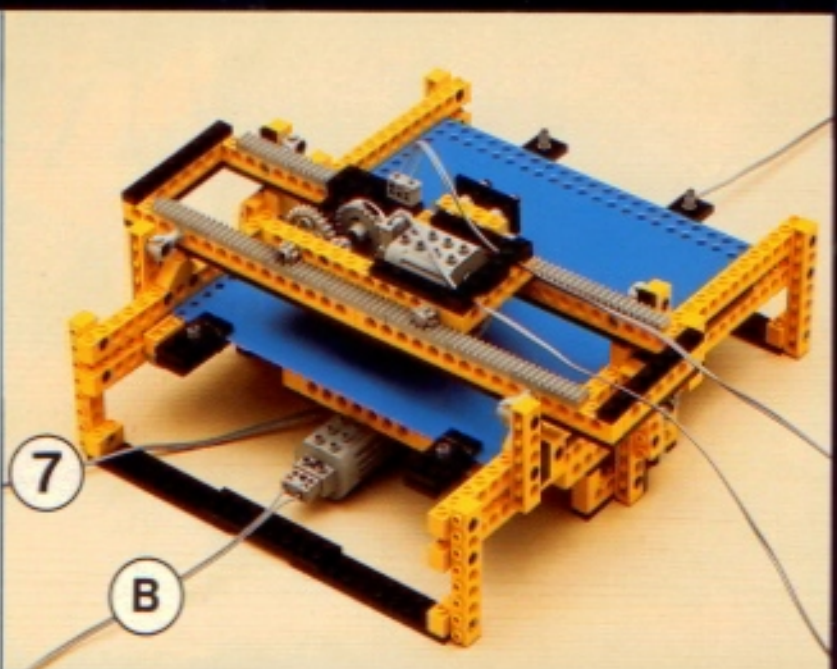
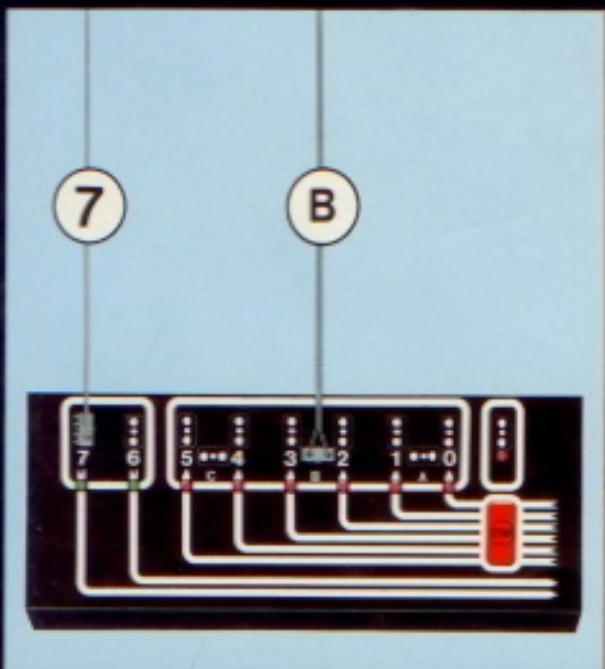
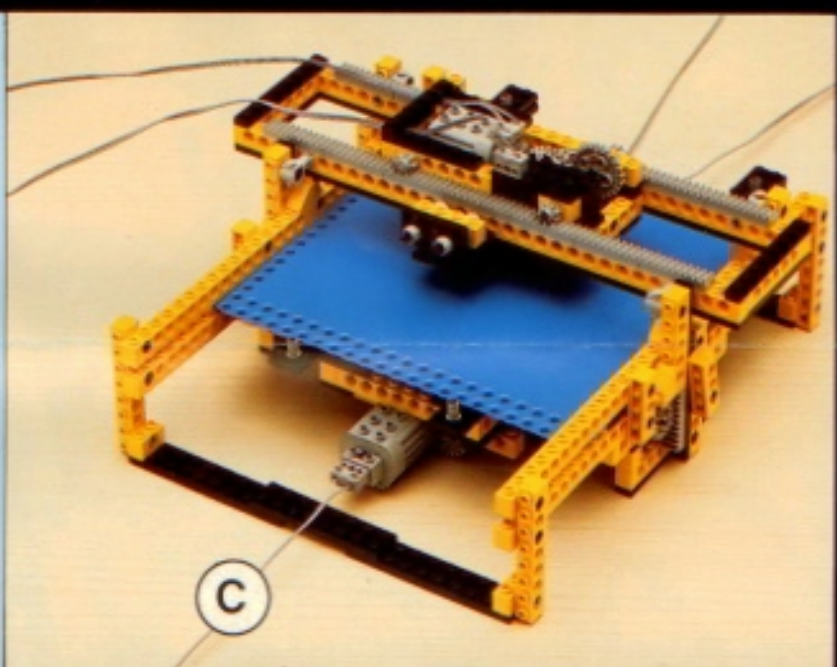
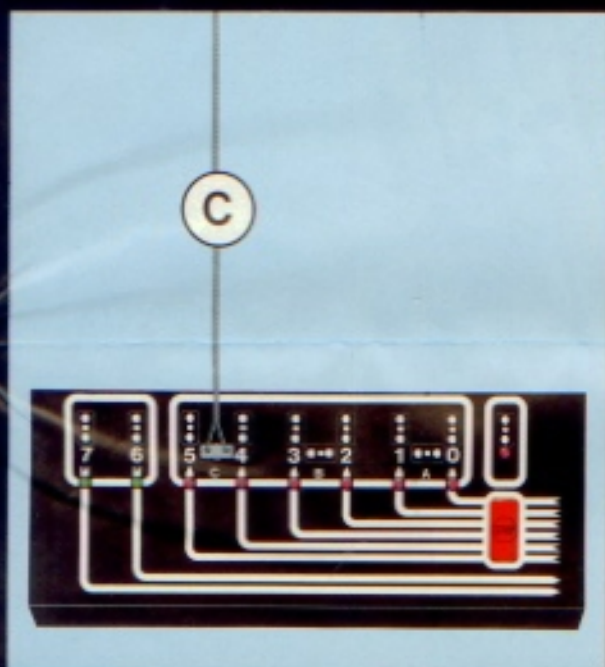
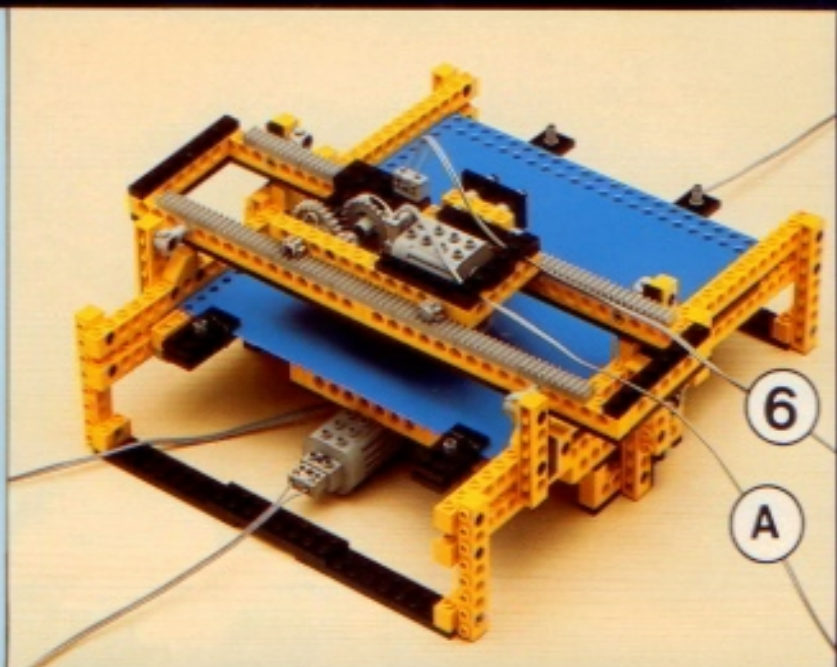
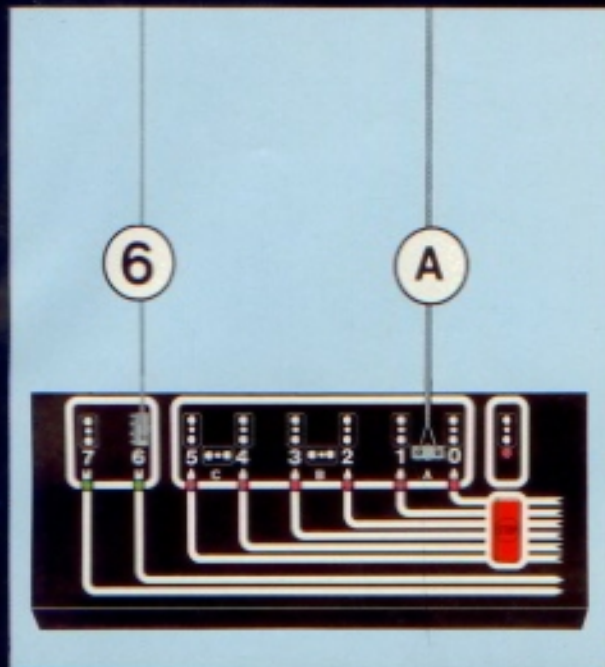

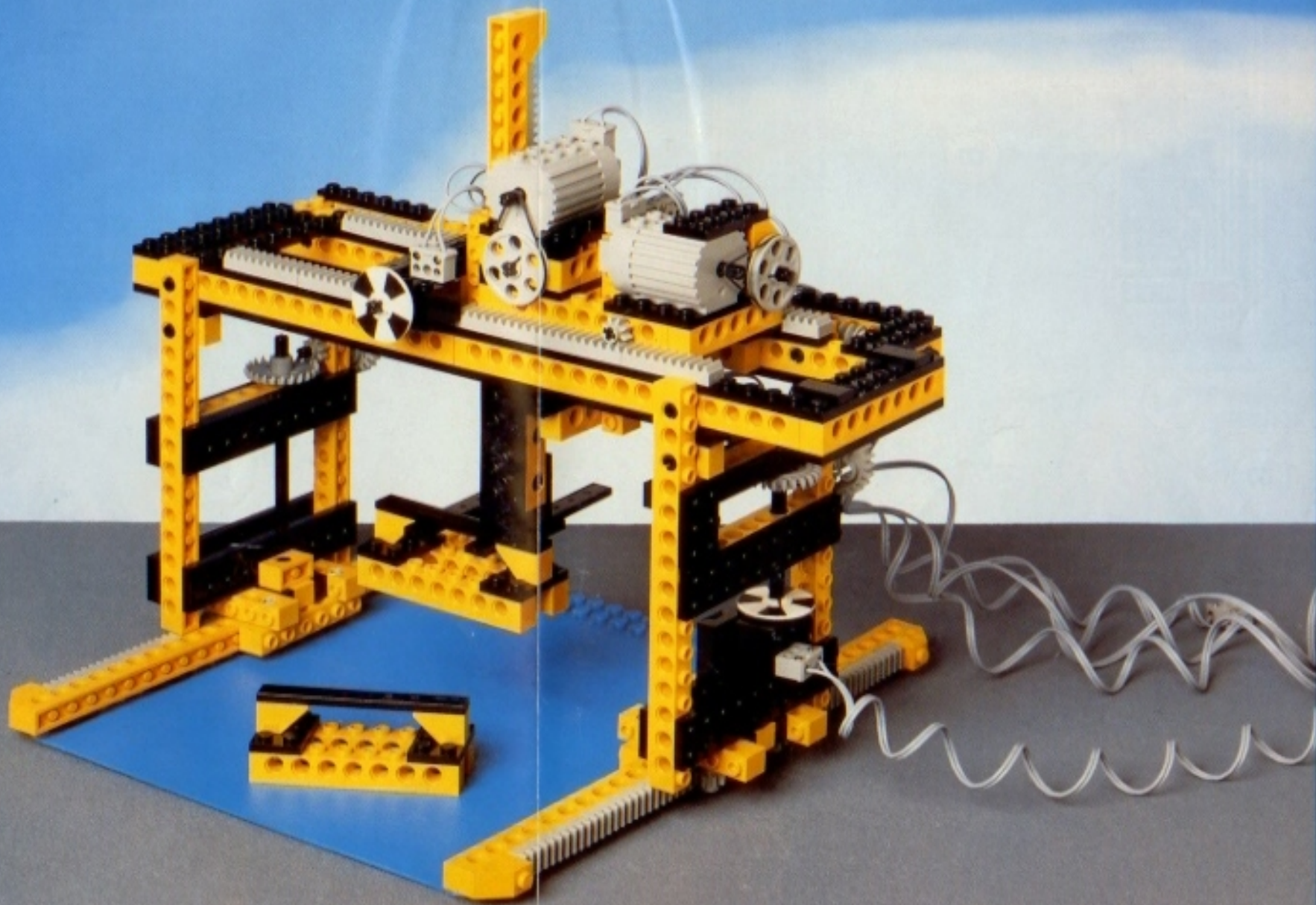

1092 E

Technic

LEGO

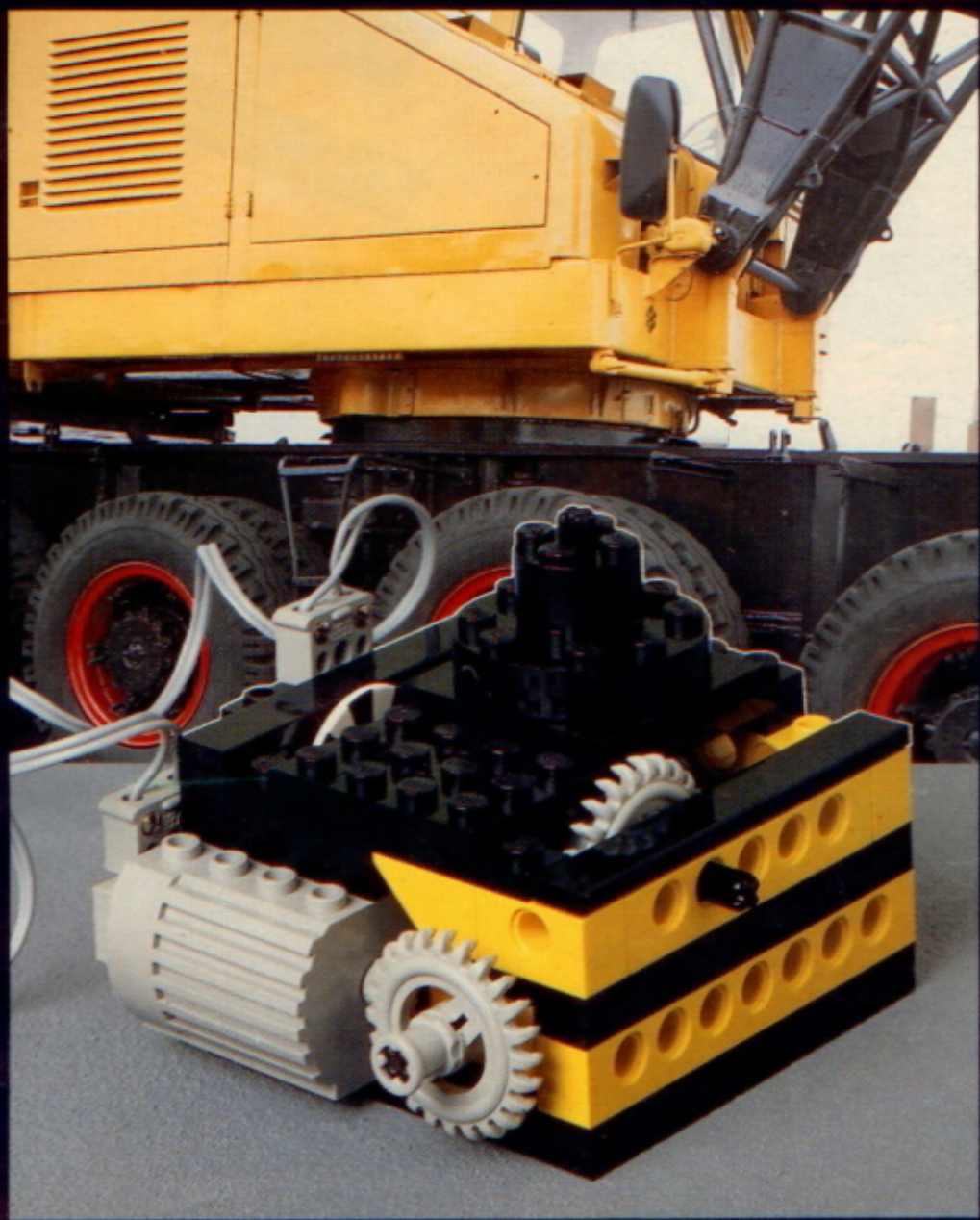



3x

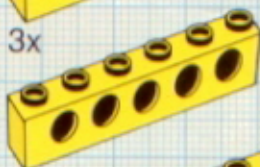

2x

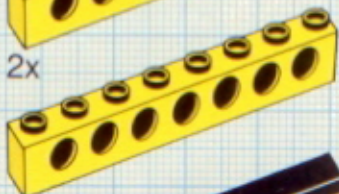

2x



2x

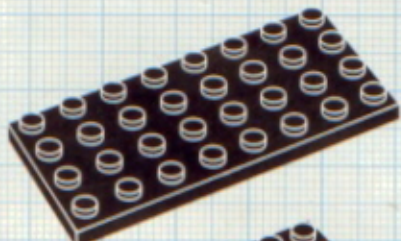

1x

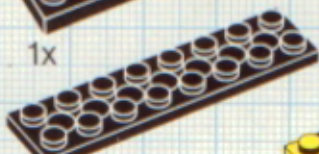

3x

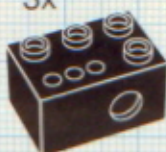

1x



1x

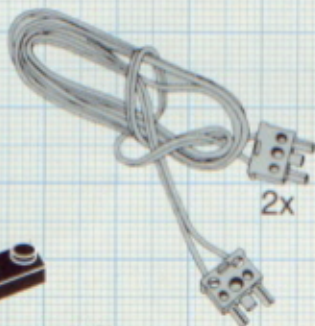

2x



7x



2x



5x

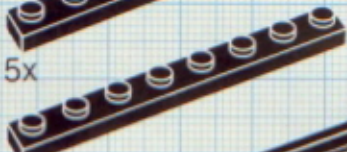

5x



1x



2x



1x



7x



2x



3x



1x

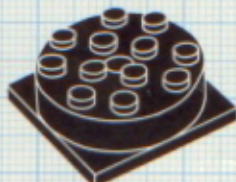

1x



2x



1x

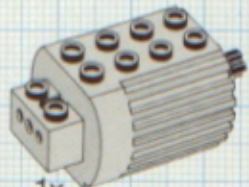

1x

1

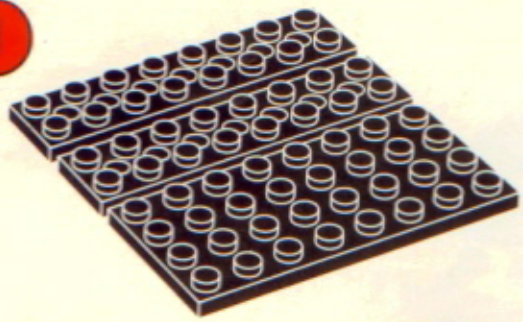

2

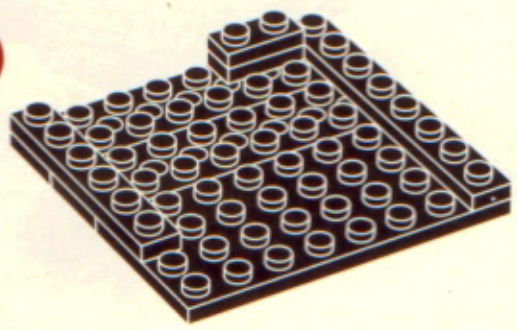

3

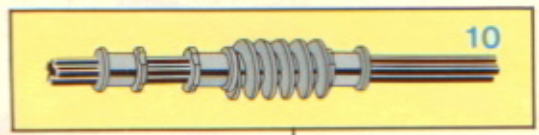
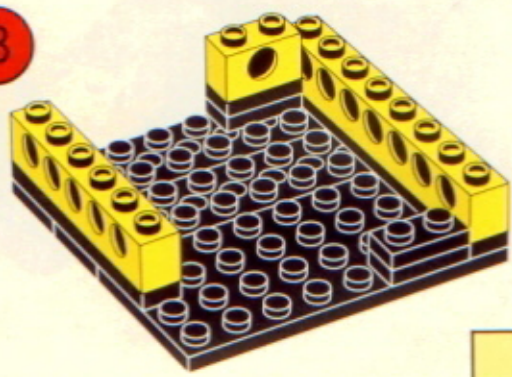

4

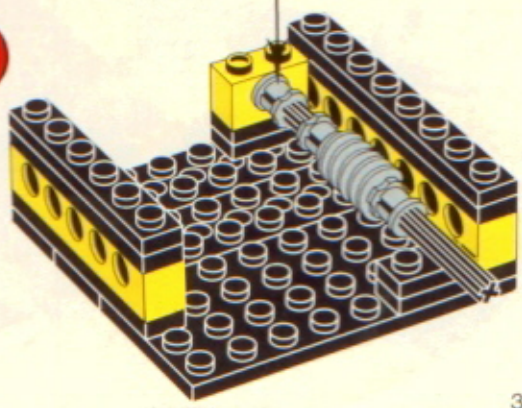

5

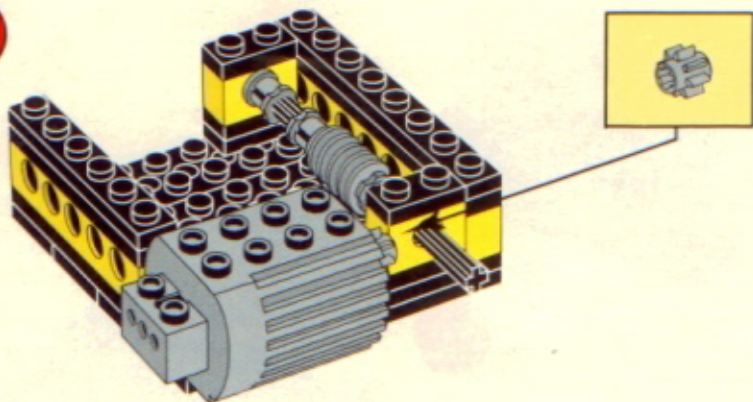

6

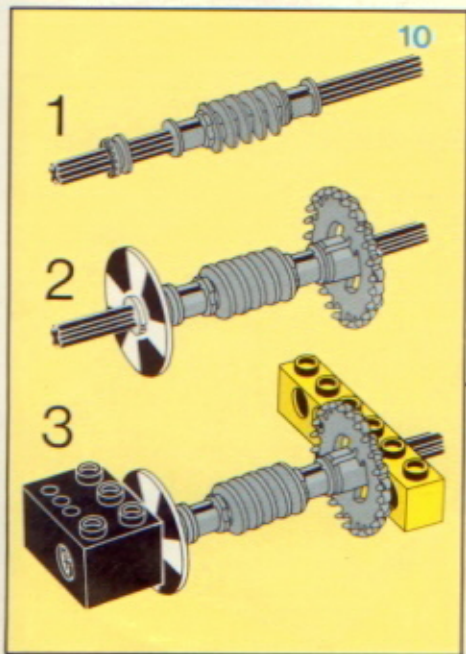
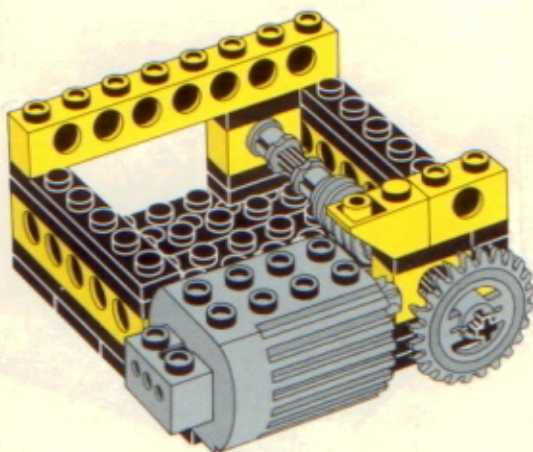

7

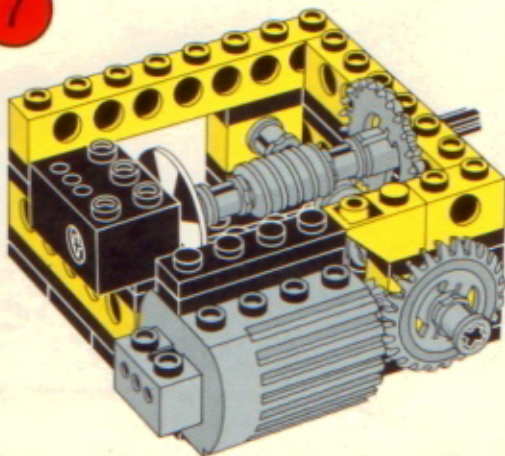



8

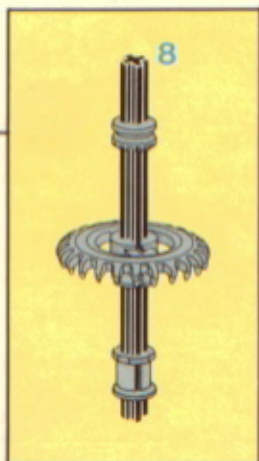
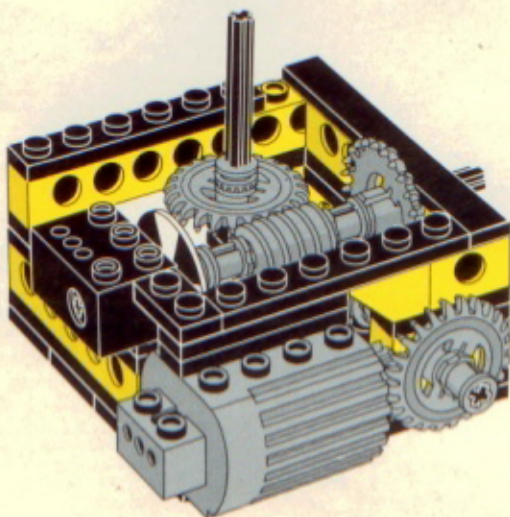

9

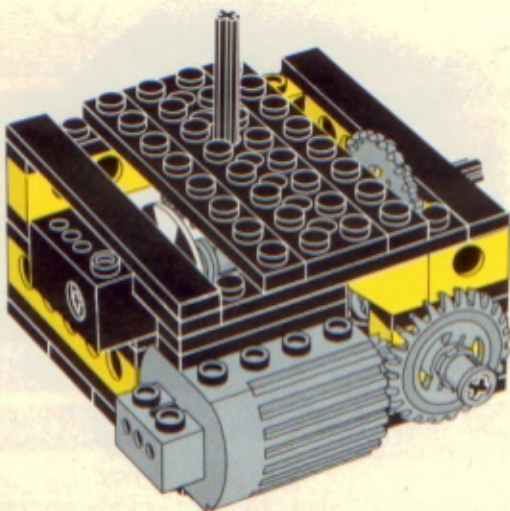

10

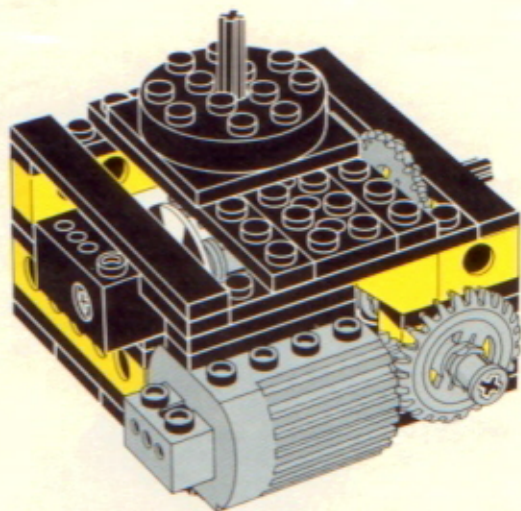

11

