

9688

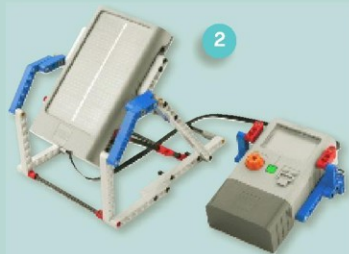

1A

2A

3A





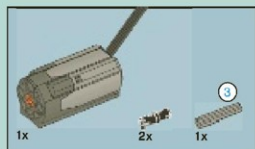

1

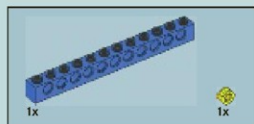
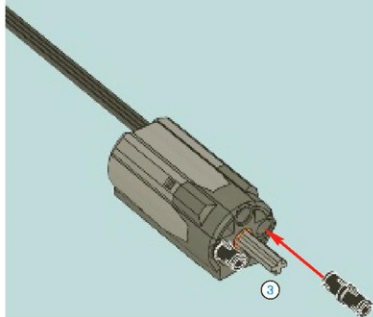

2

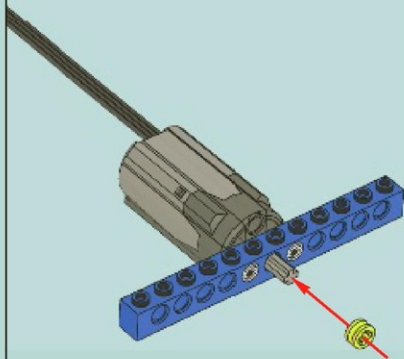

4



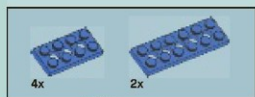

3

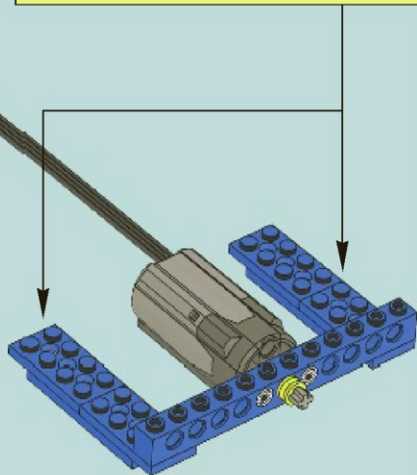
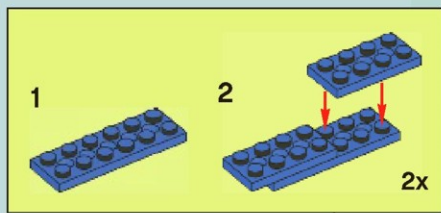

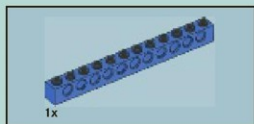

4

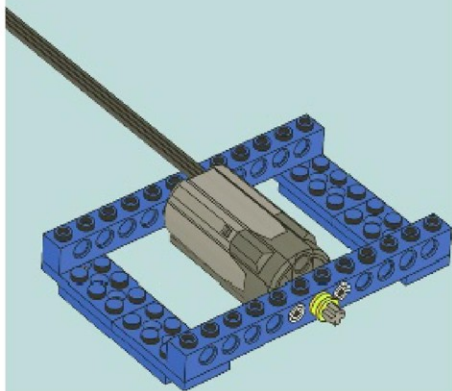

5

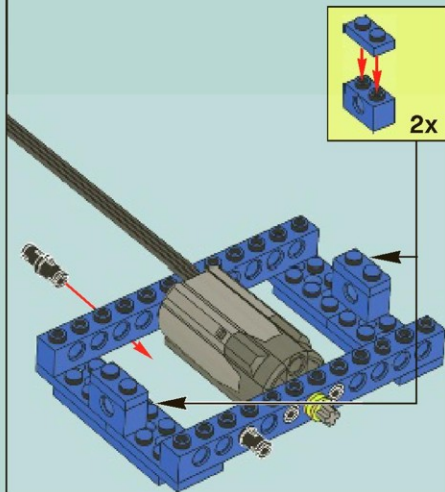



6

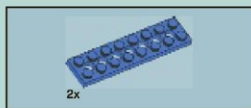
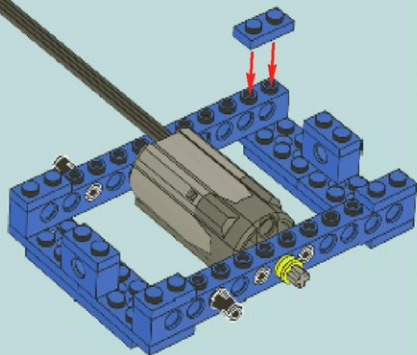

7

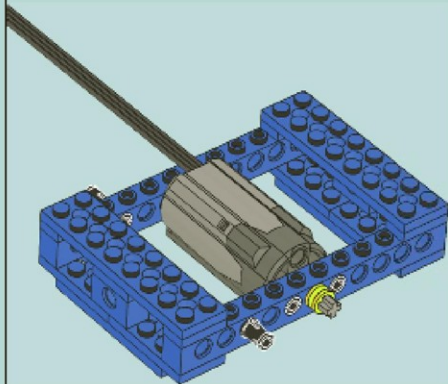

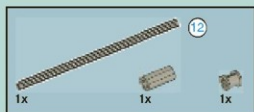

8

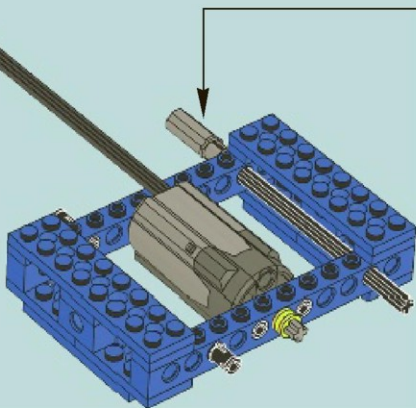
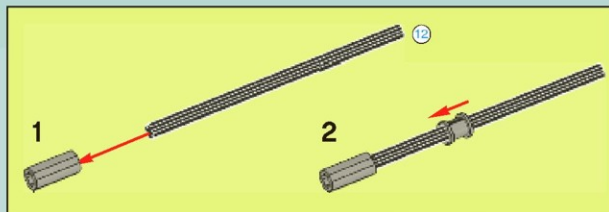

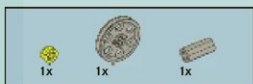

9

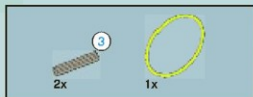
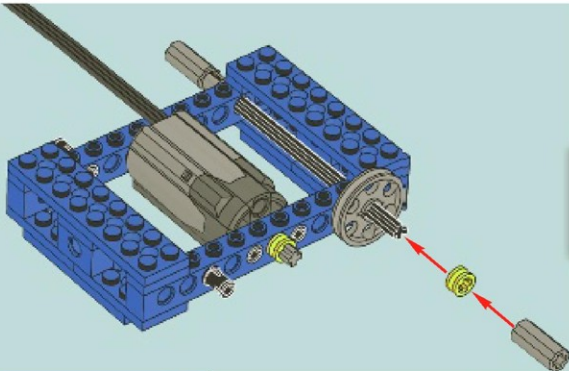

10

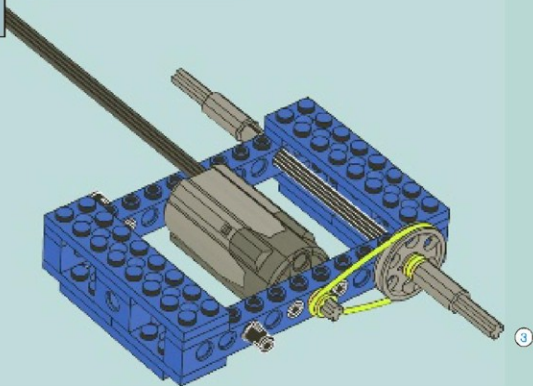

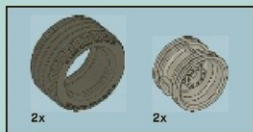

11

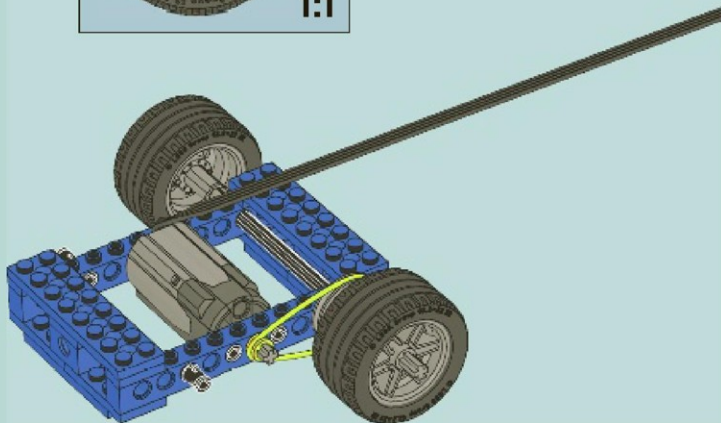

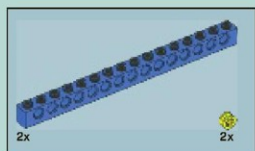

12

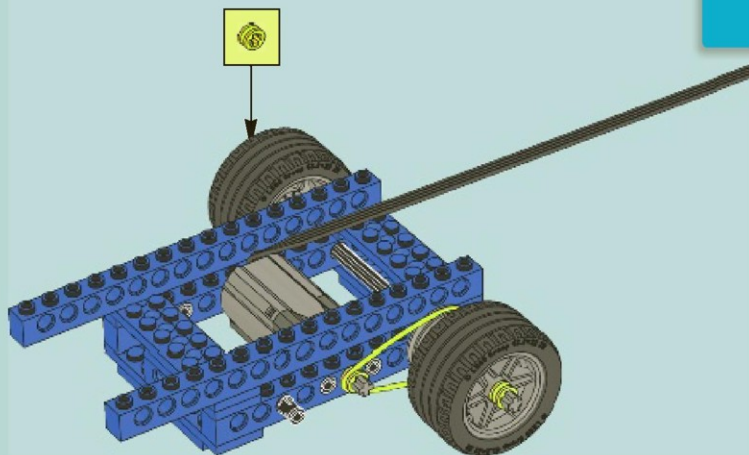

2x

4x

13

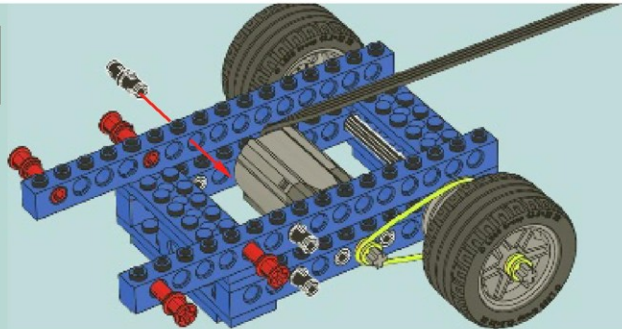

2x

2x

14

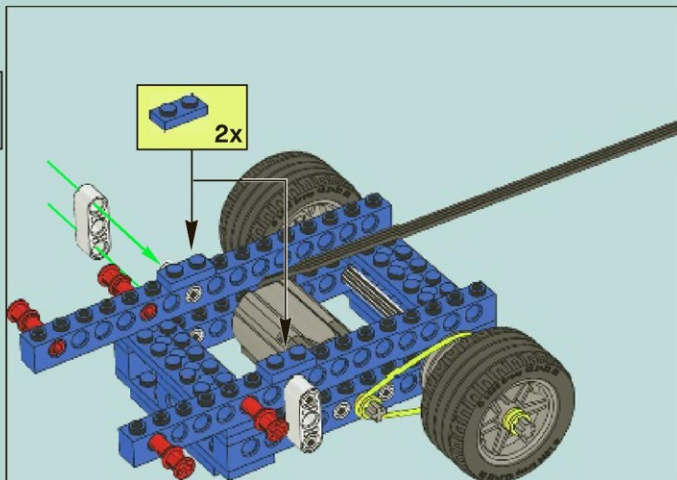

2x



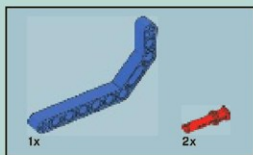

15

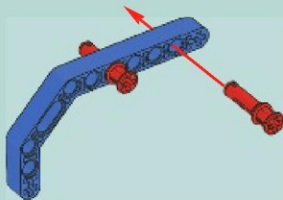

16

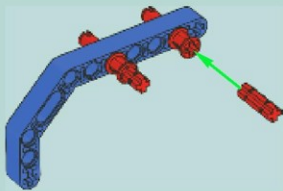

17

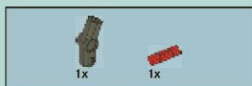
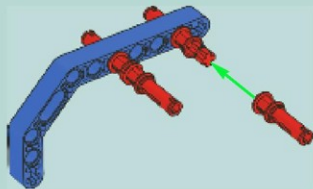

18

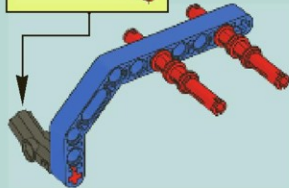
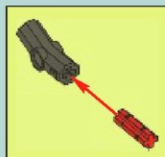

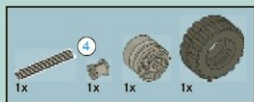

19

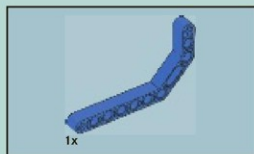
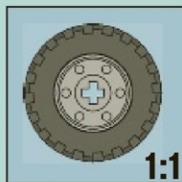
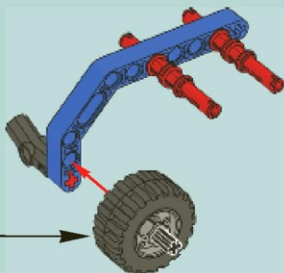
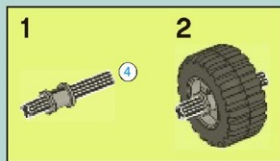

20

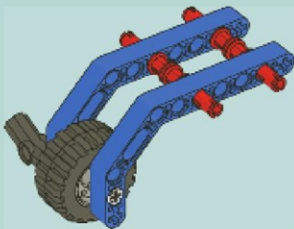

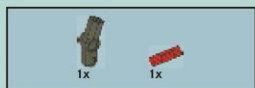

21

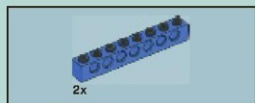
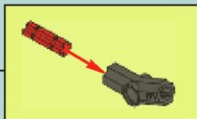
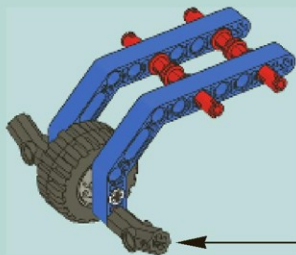

22

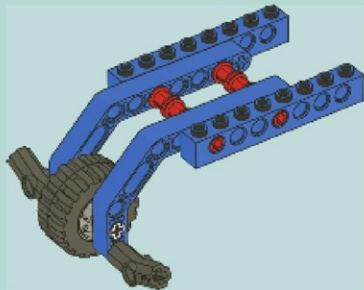

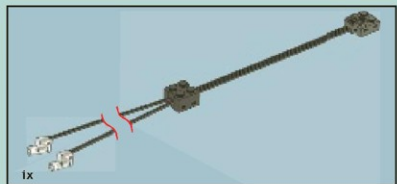

23

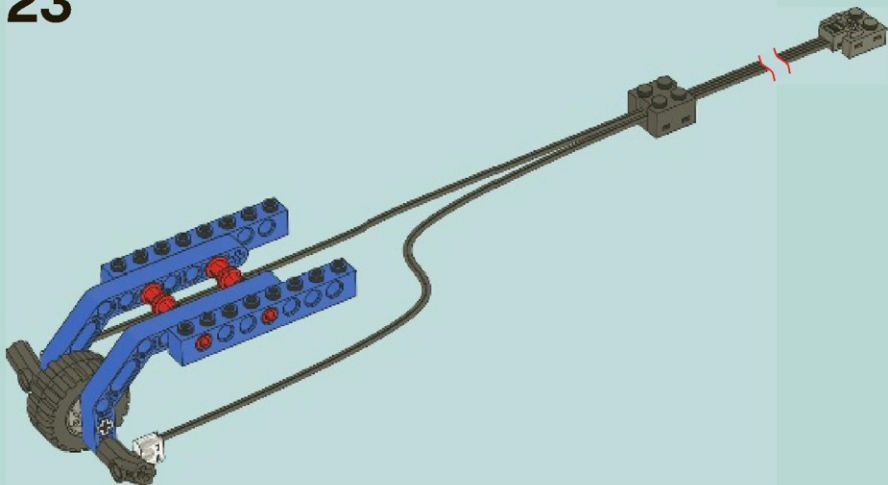

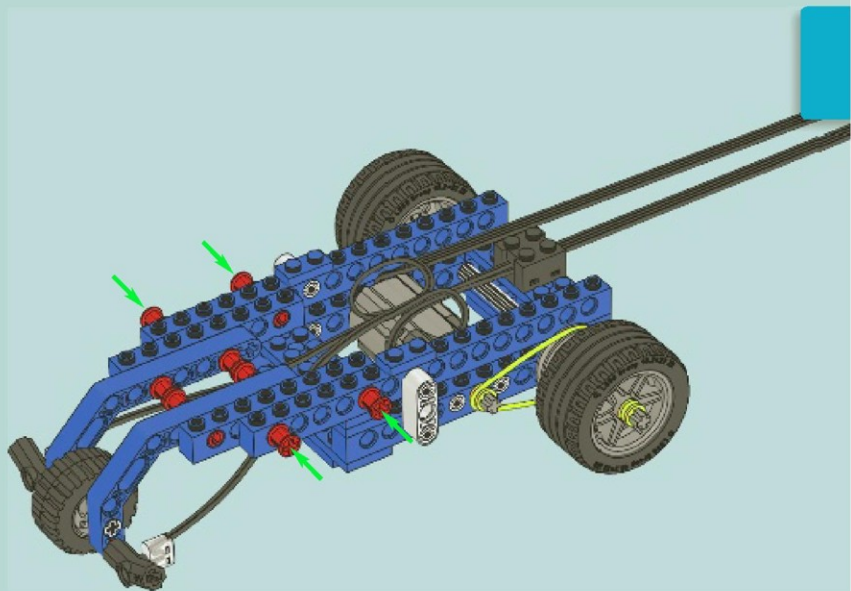

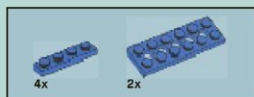

25

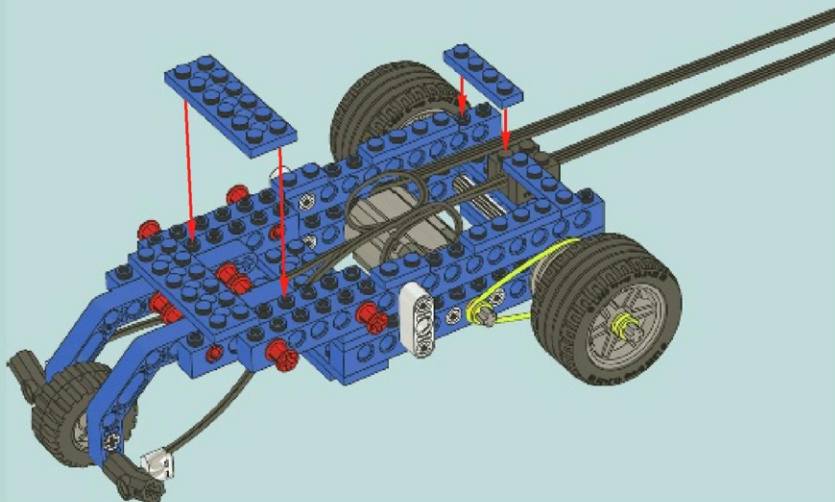

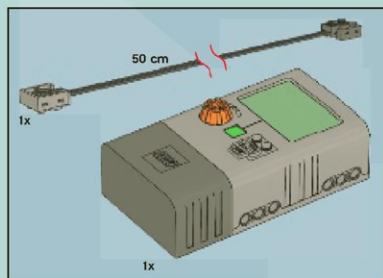

26

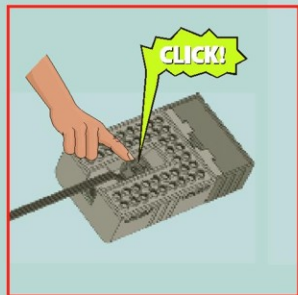
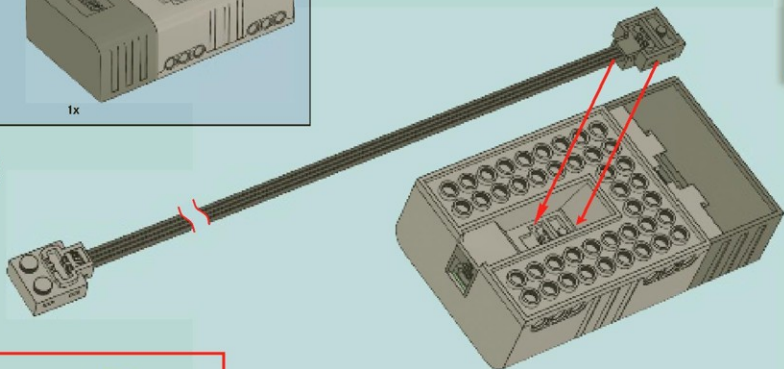

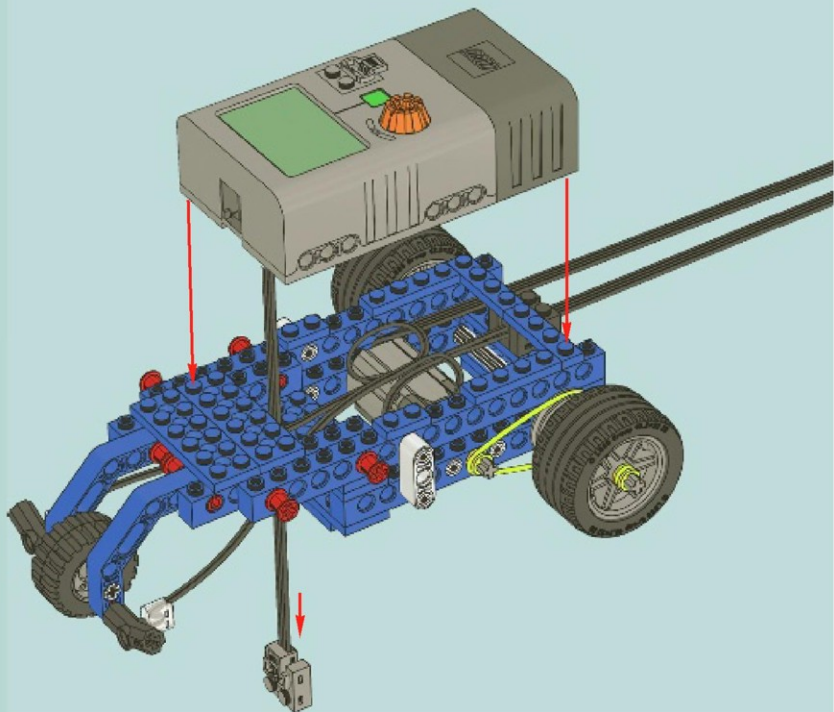



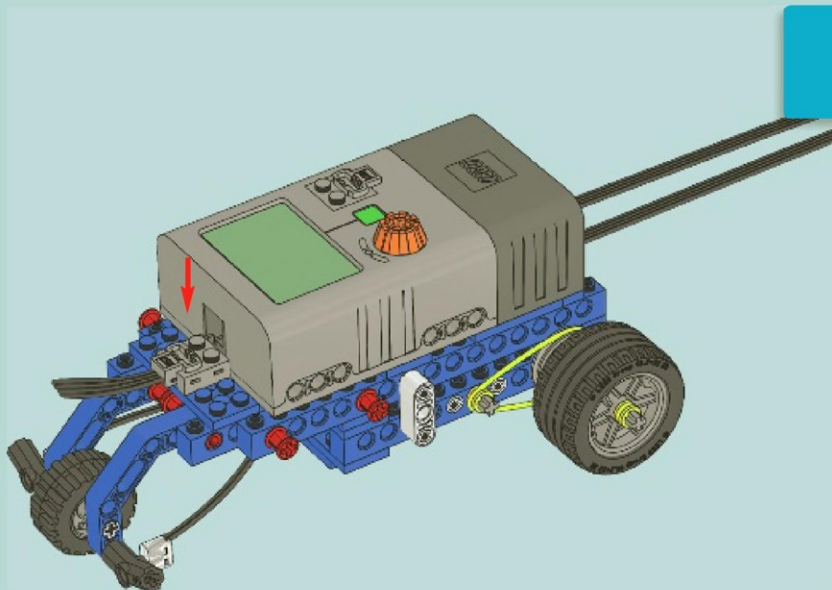

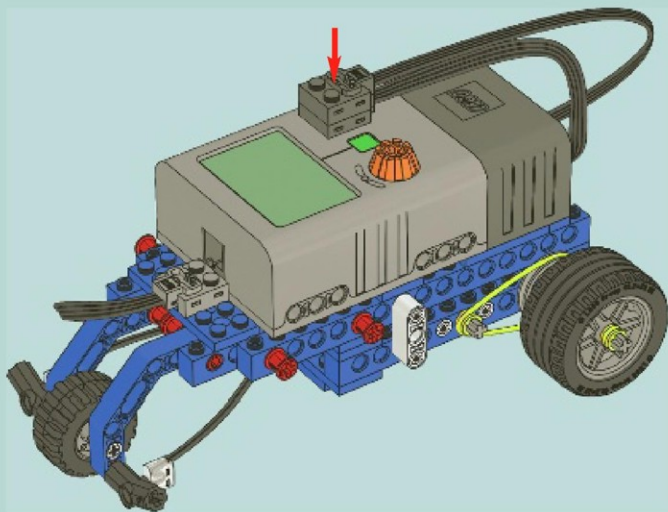

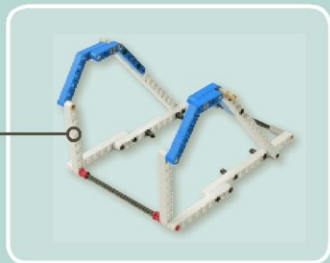

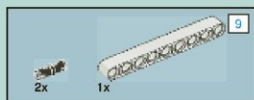

1

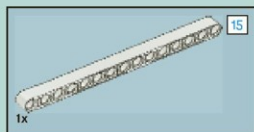
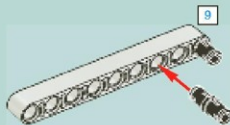

2

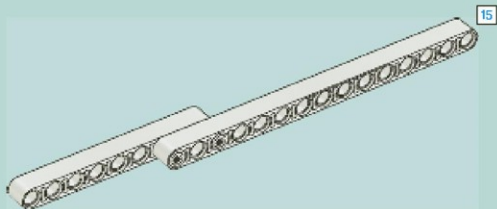

3

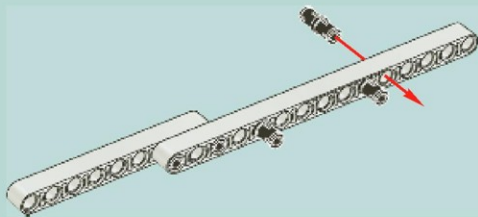

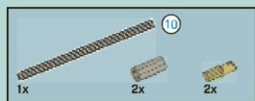

4

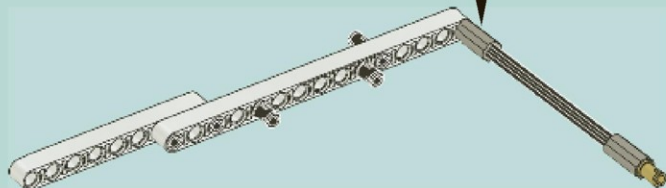
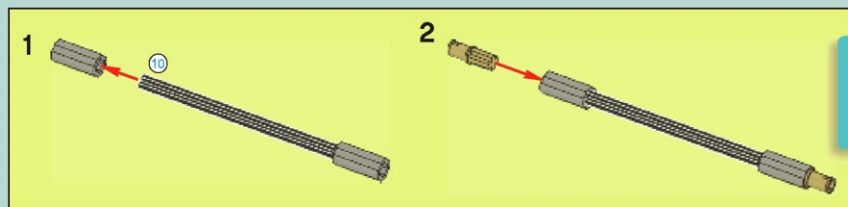

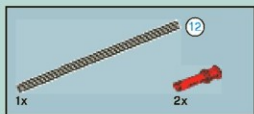

5

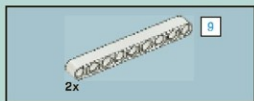
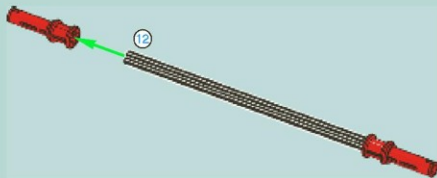

6

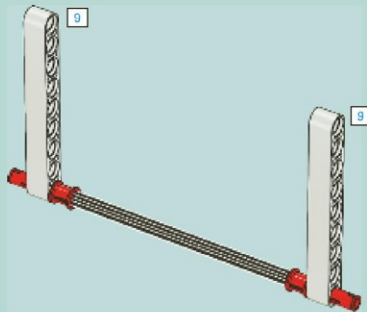

7

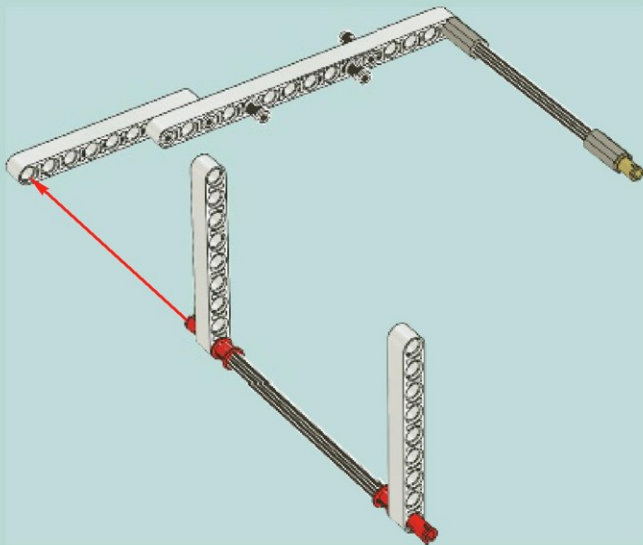

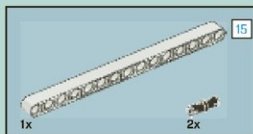

8

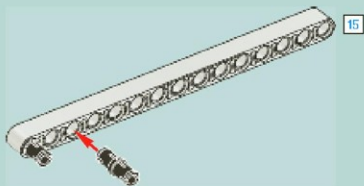

9

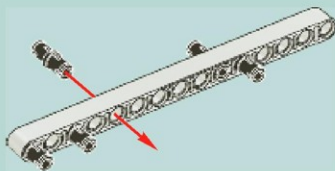



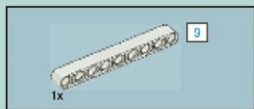

10

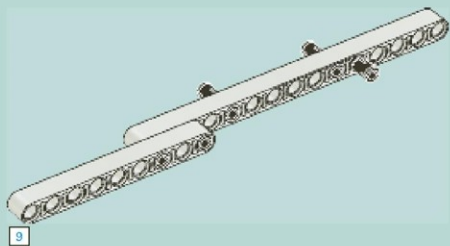

11

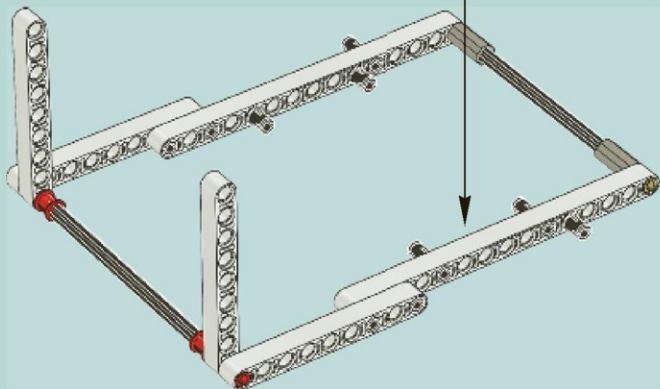

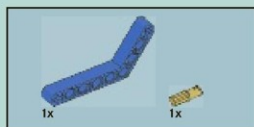

12

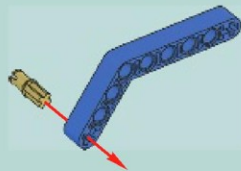

13

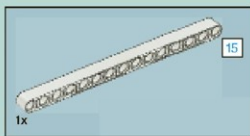
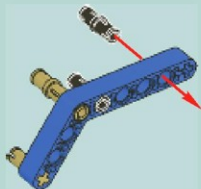

14

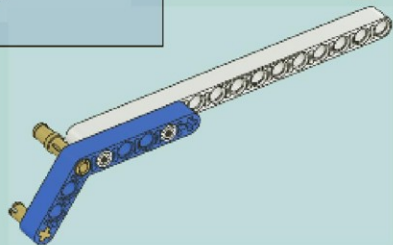

15

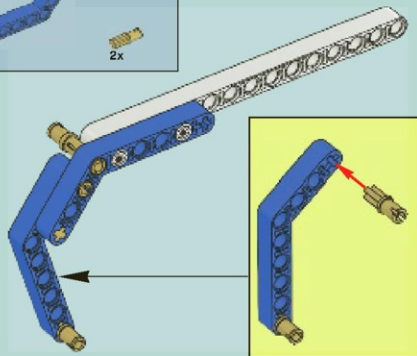

16

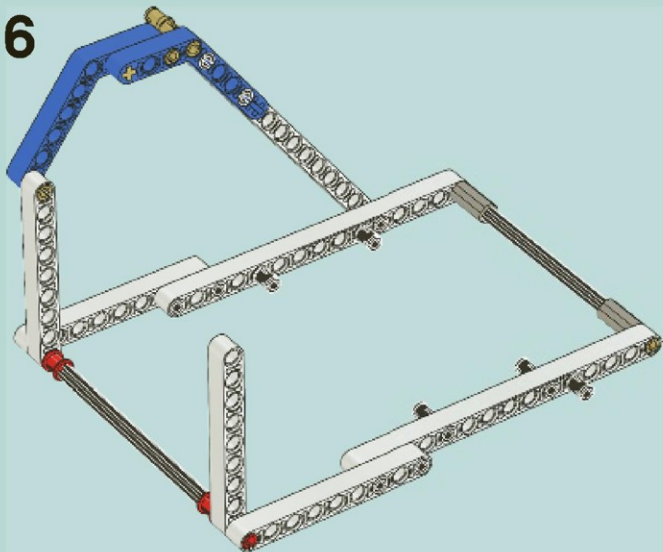



17

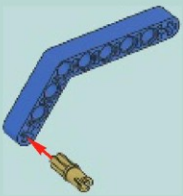

18

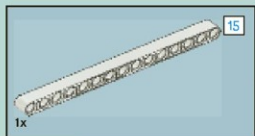
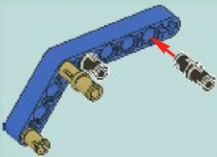

19

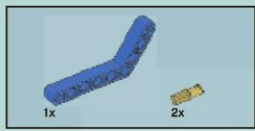
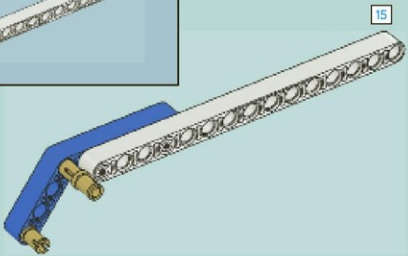

20

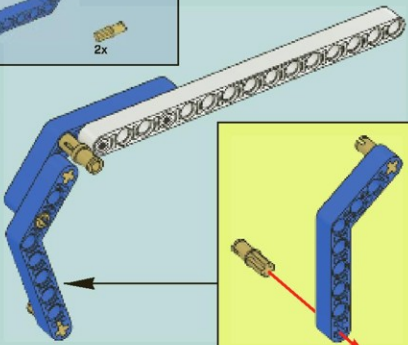

21

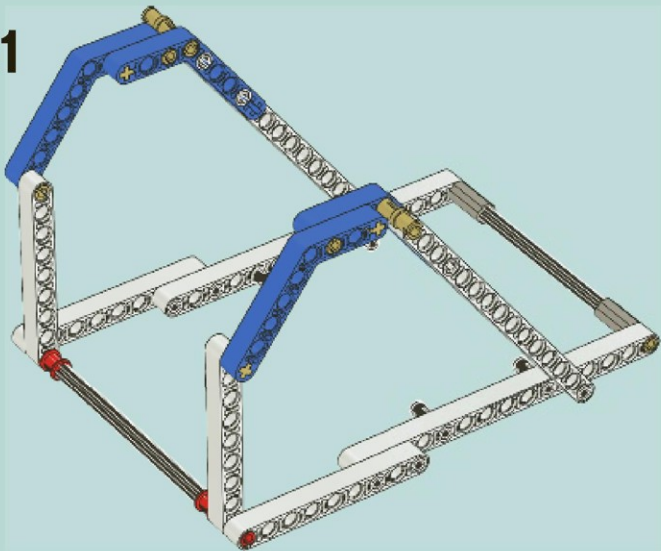



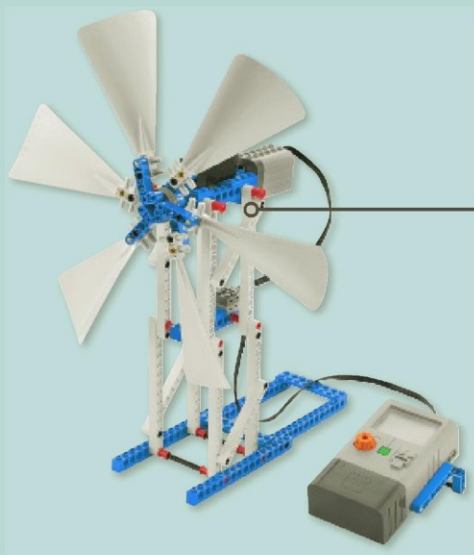

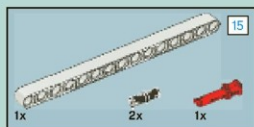

1

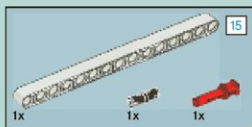
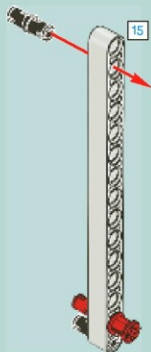

2

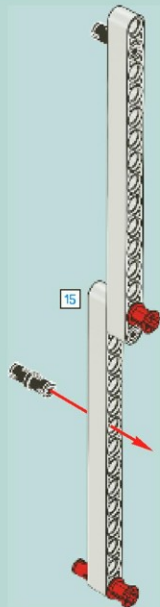



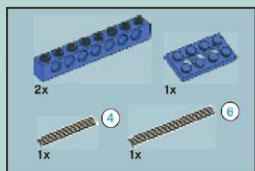

3

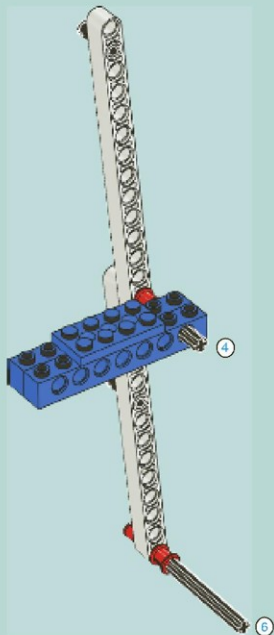
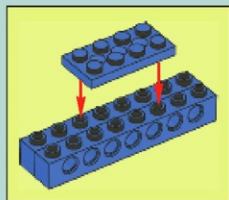

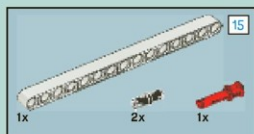

4

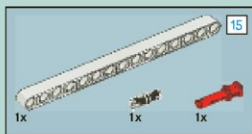

5

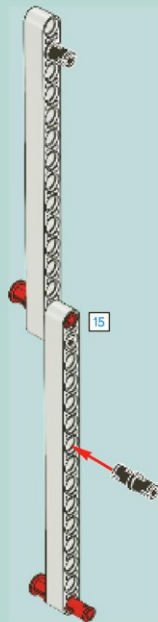

6

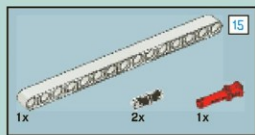
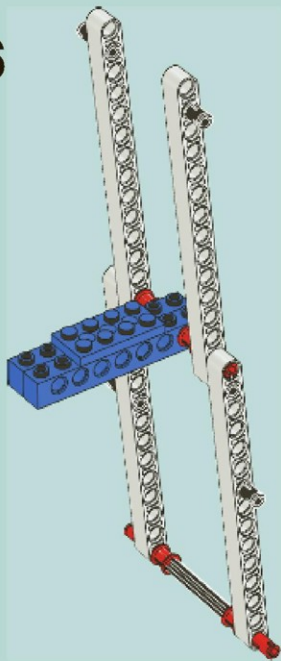

7

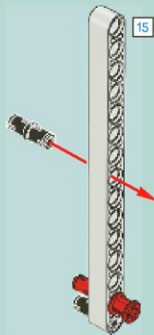

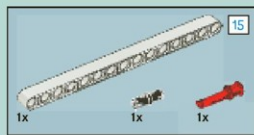

8

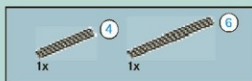
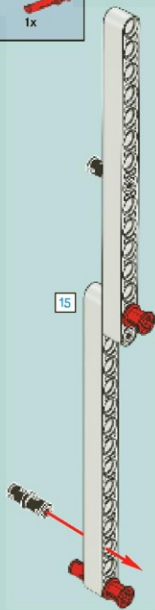

9

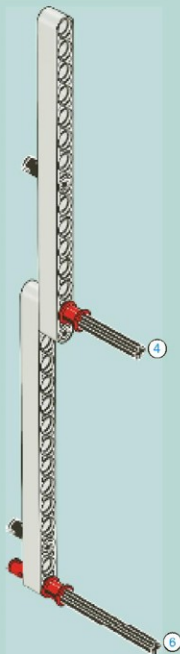

10

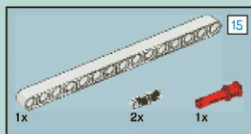
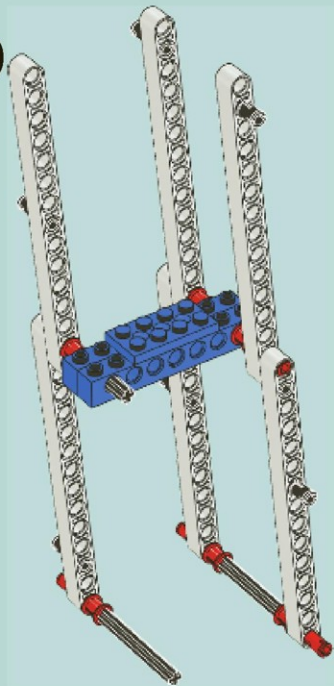

11

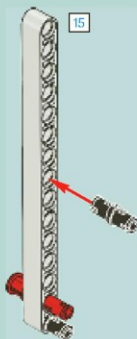

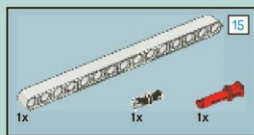

12

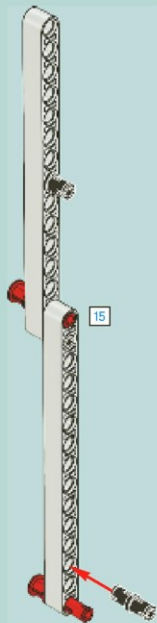

13

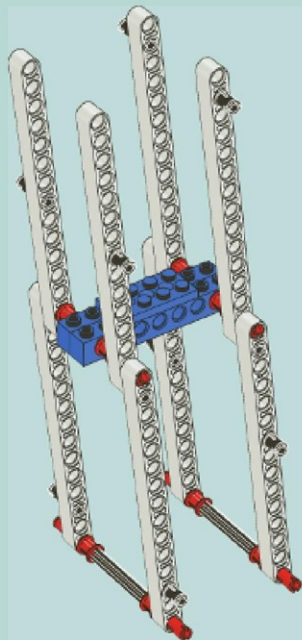

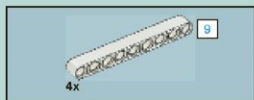

14

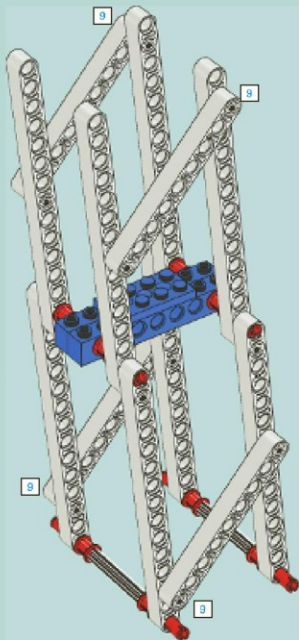

15

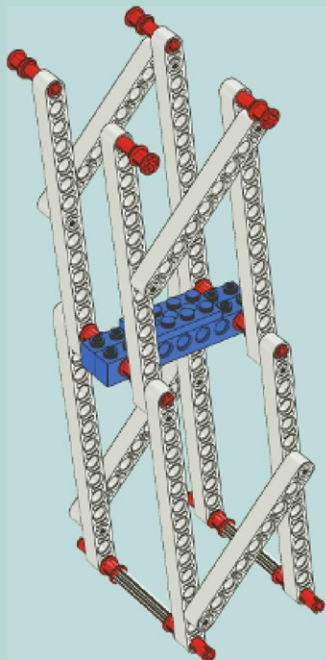

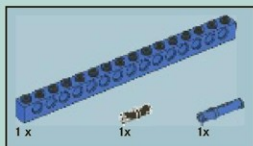

16

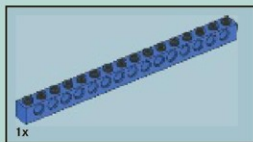
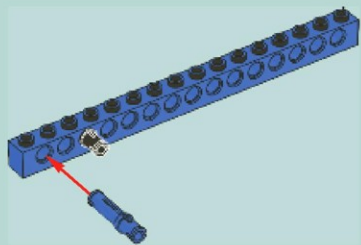

17





18

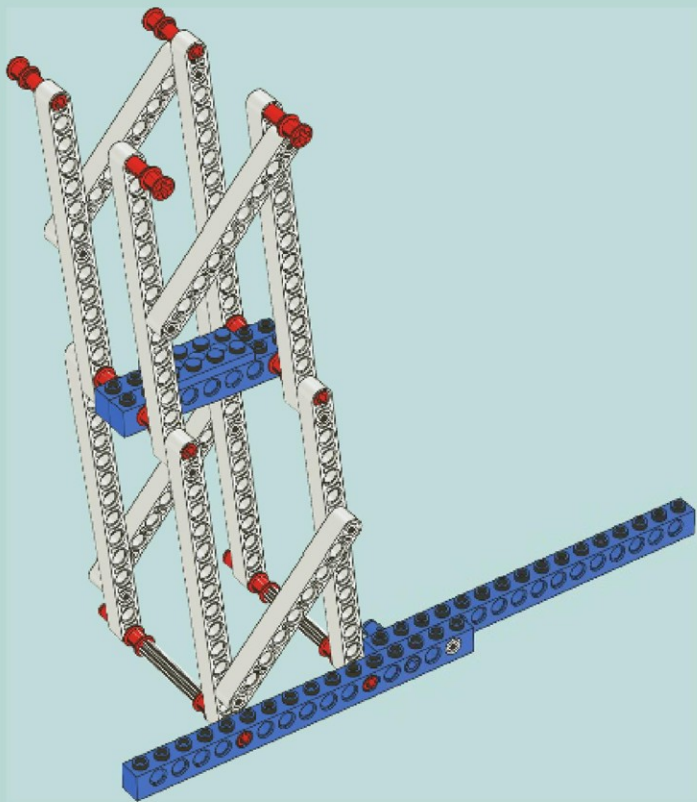

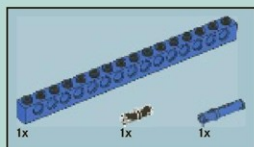

19

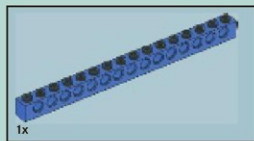
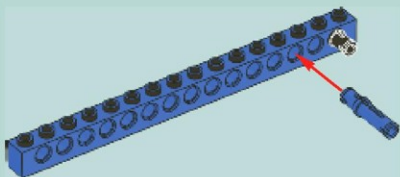

20

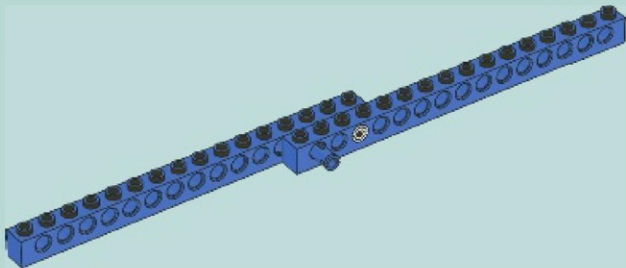

21

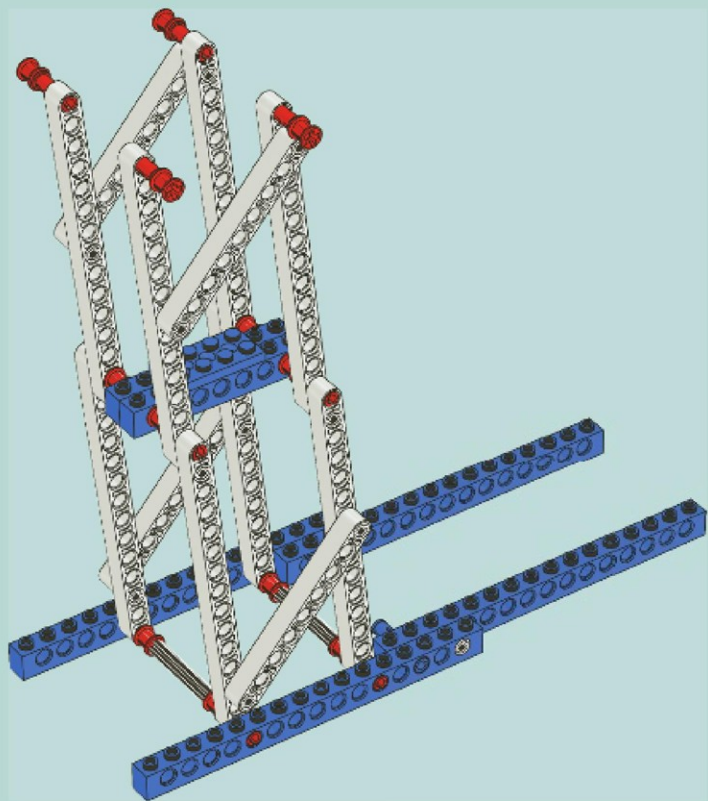

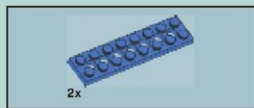

22

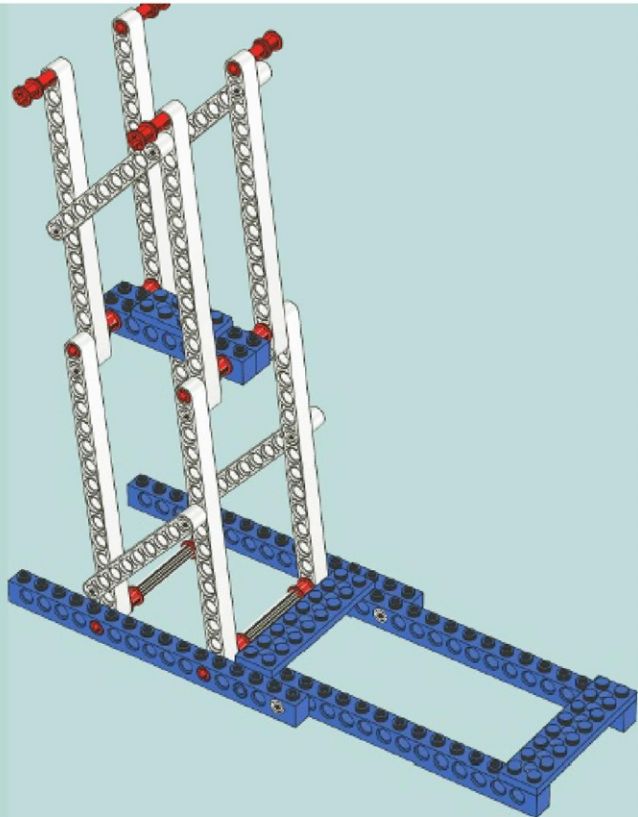

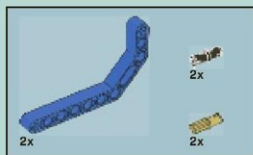

23

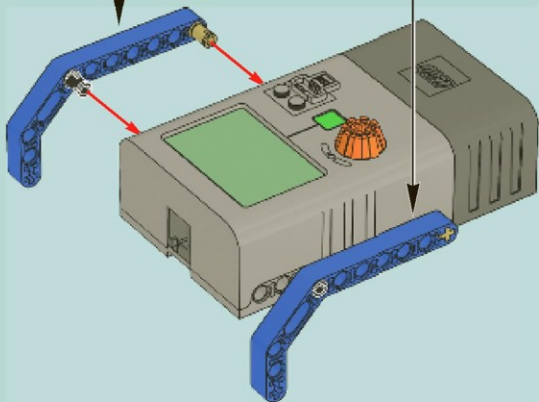
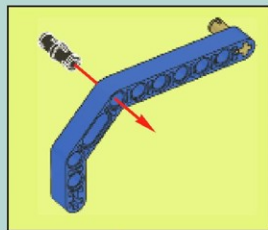
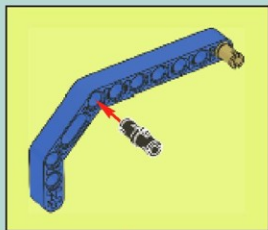

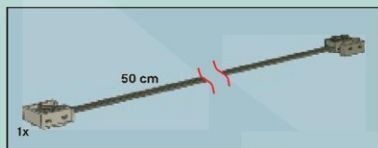

24

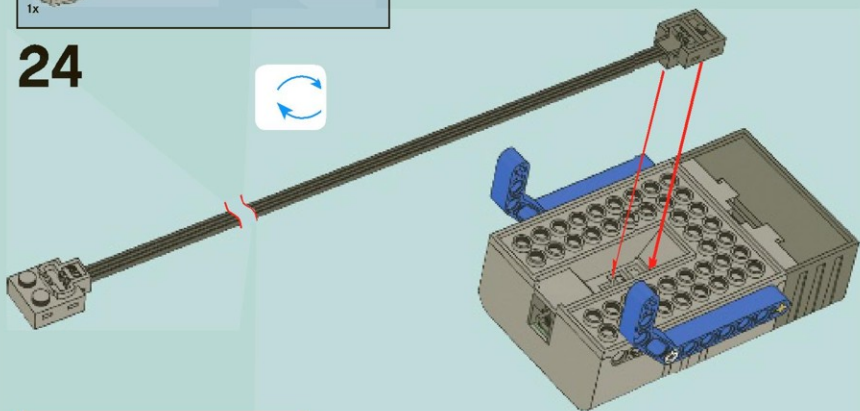

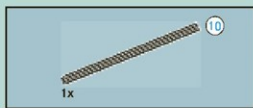

25

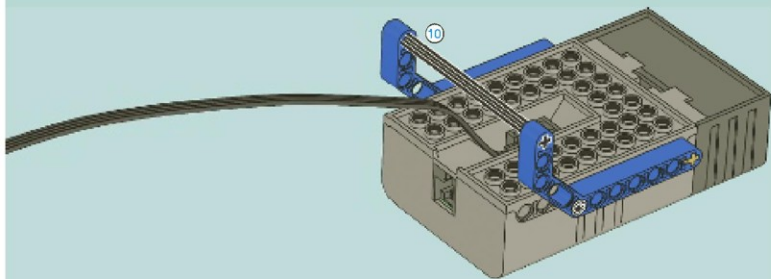

# 26

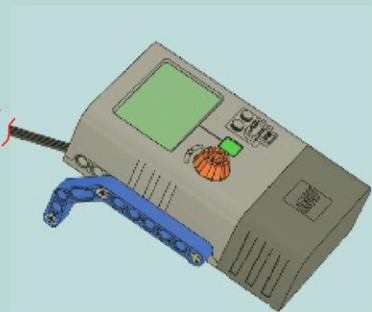
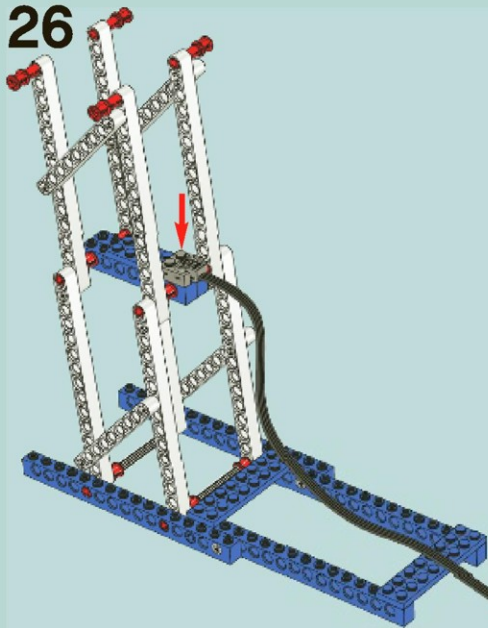







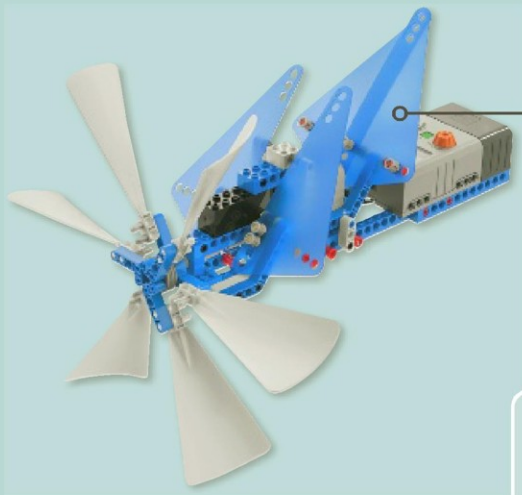

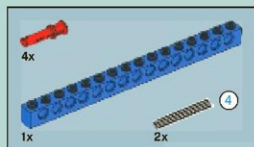

1

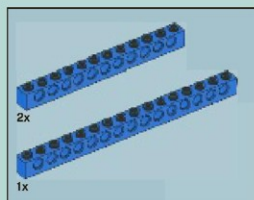
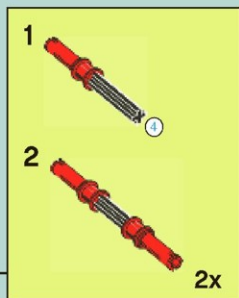
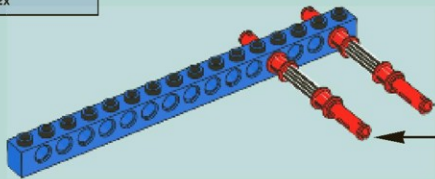

2

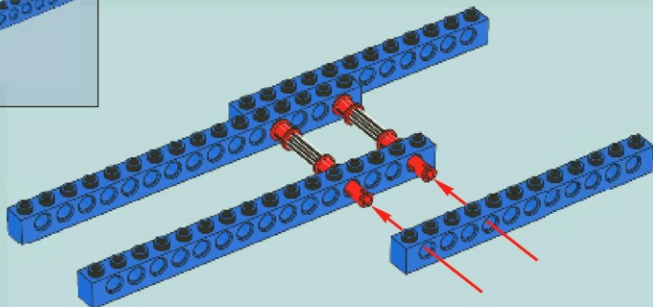

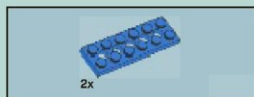

3

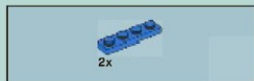
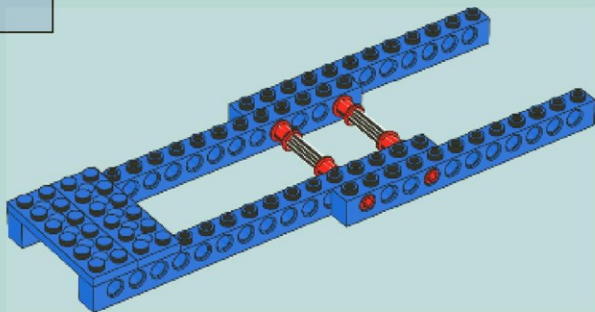

4

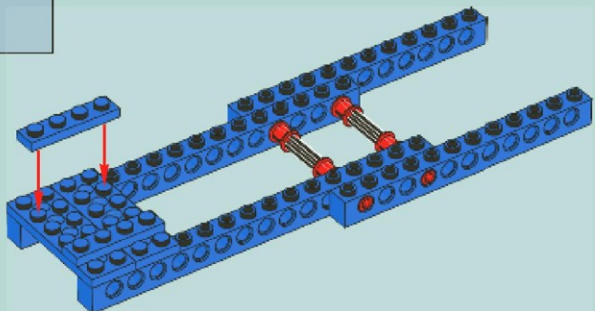

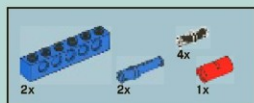

5

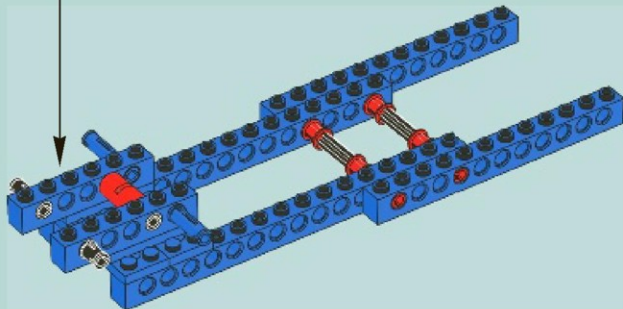
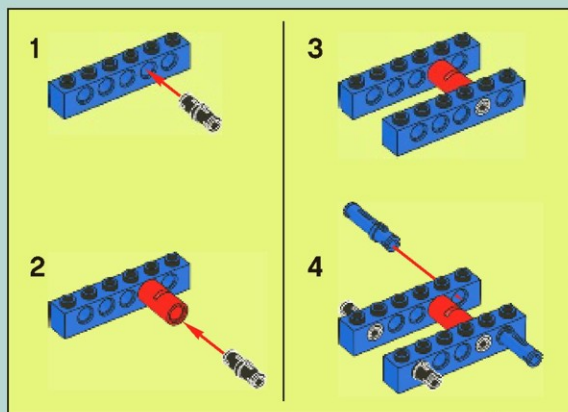

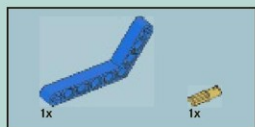

6

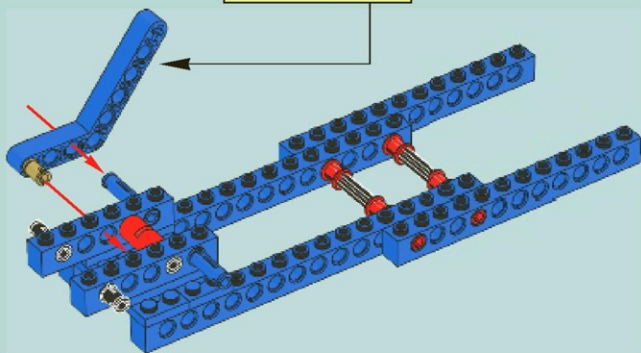
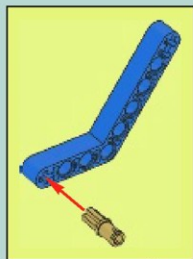

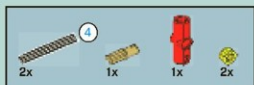

7

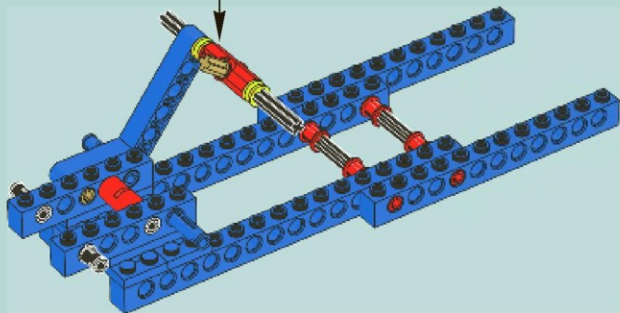
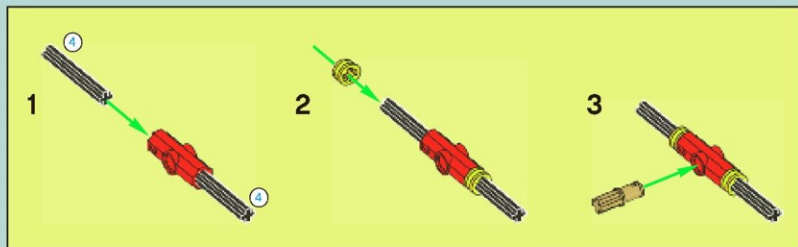



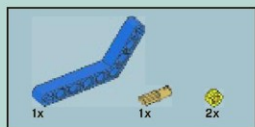

8

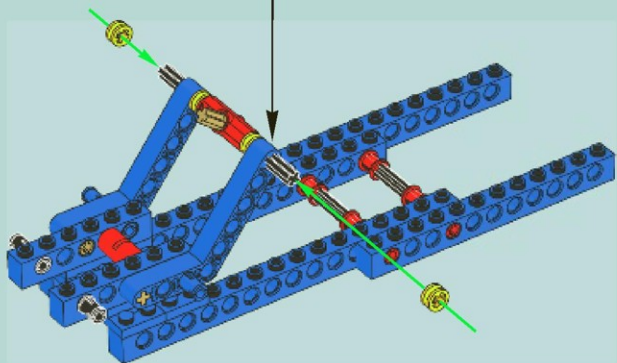
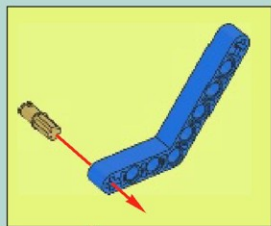



2x



2x

# 9

1



2



2x

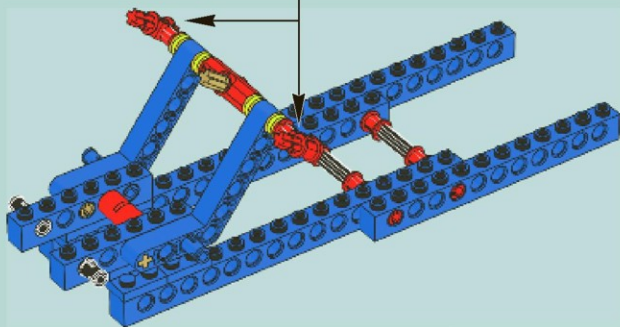

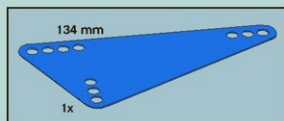

10

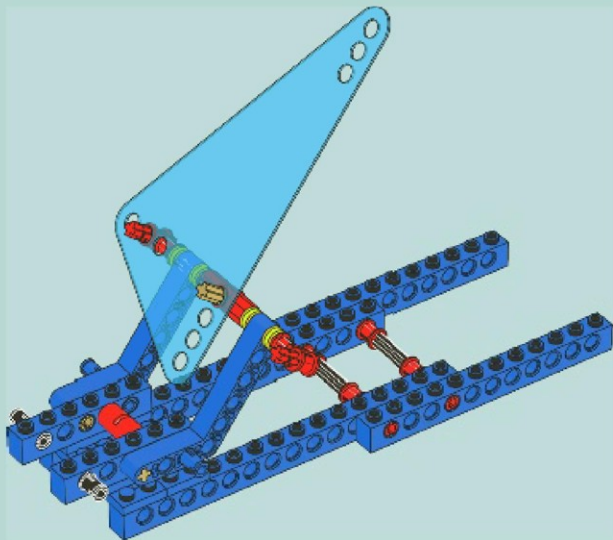

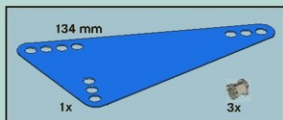

11

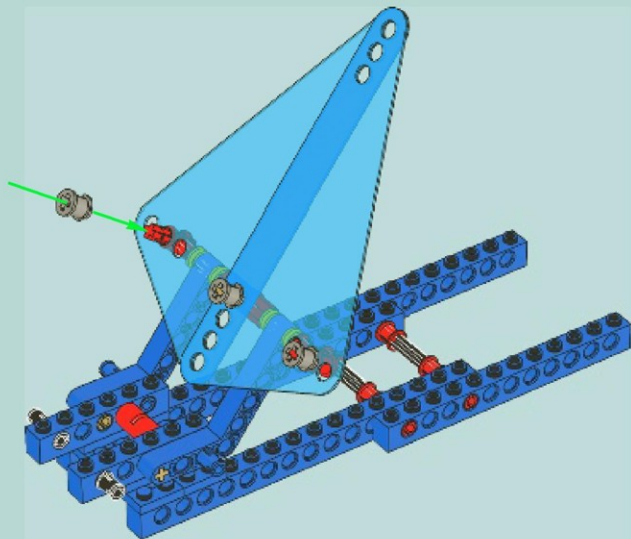

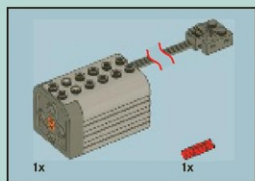

12

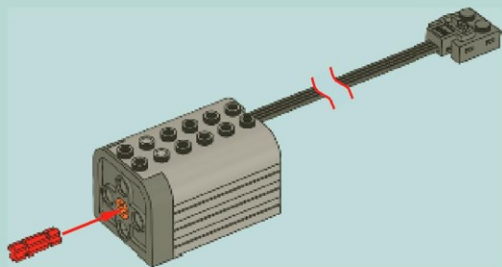

13

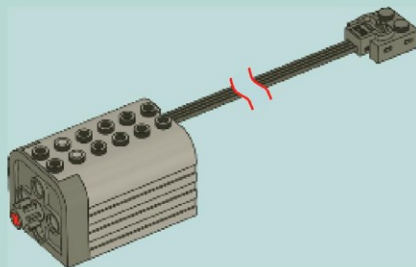

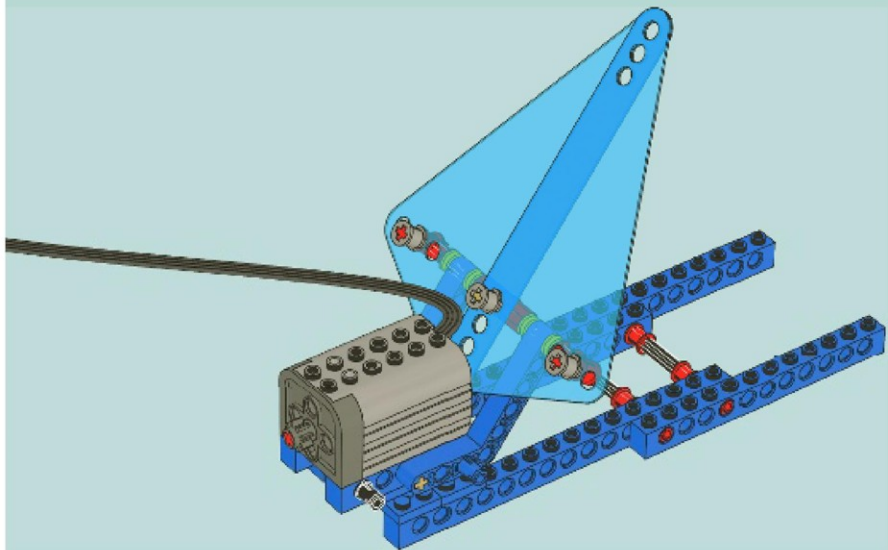

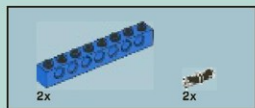

15

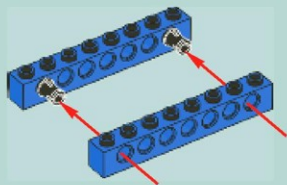

16

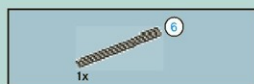
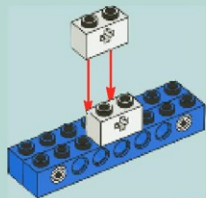

17

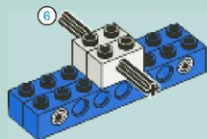

18

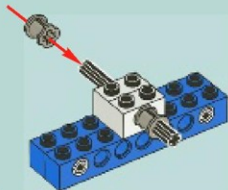

19

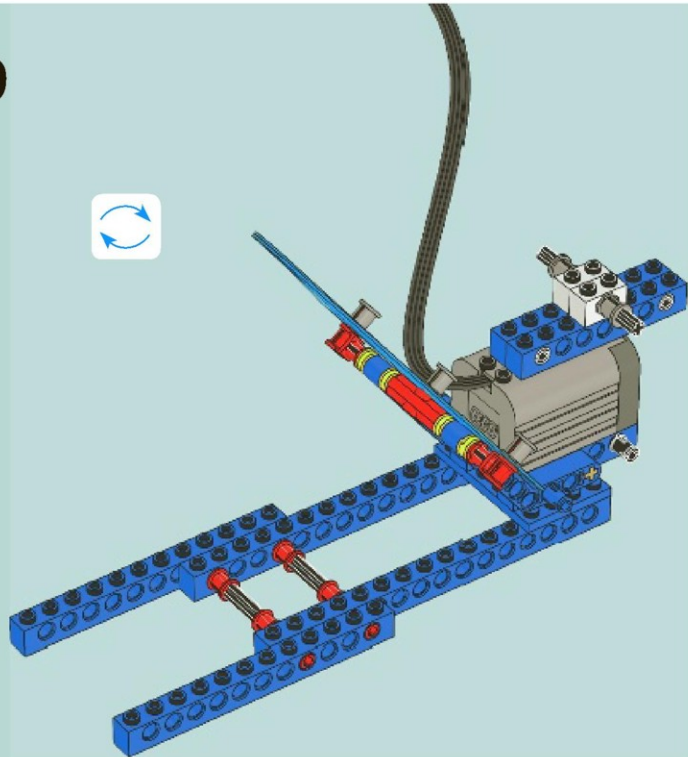



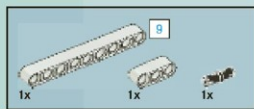

20

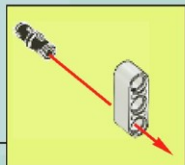
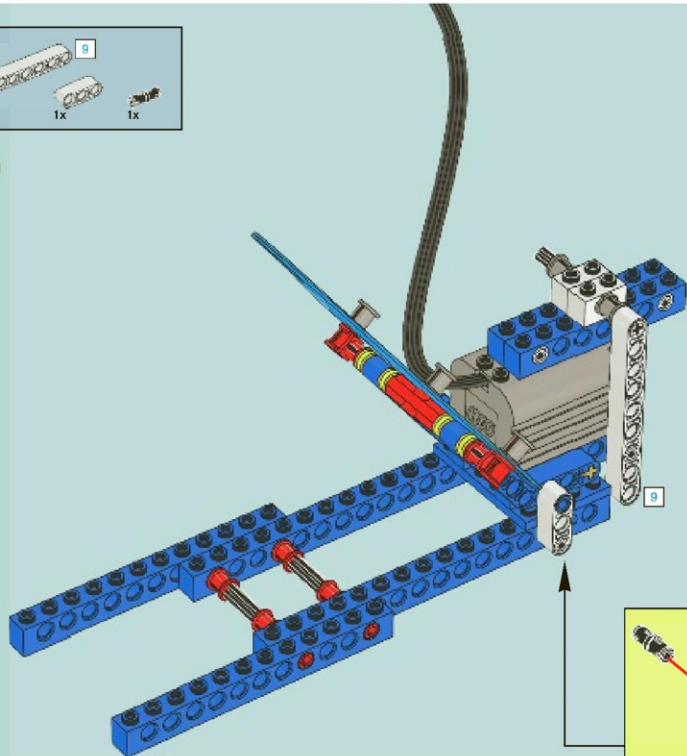



3x

21

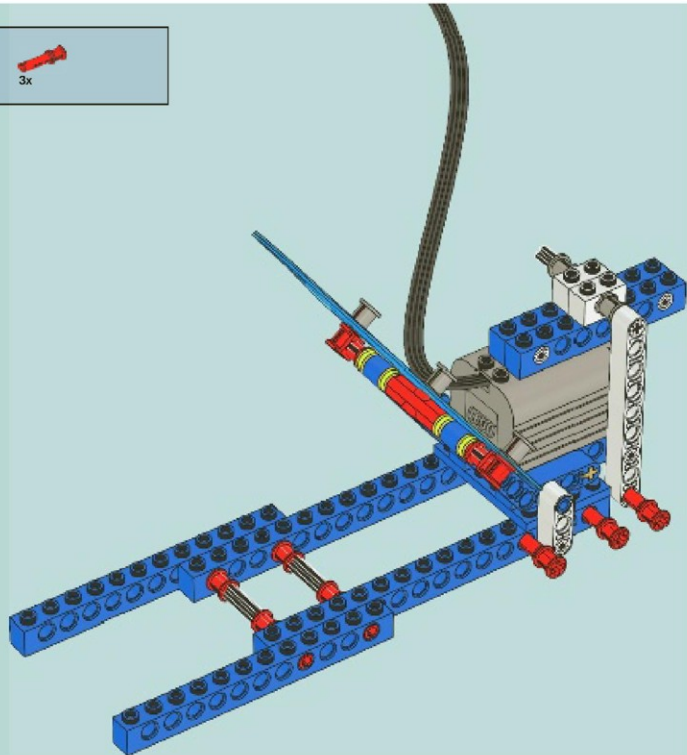

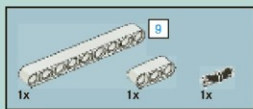

22

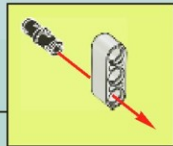
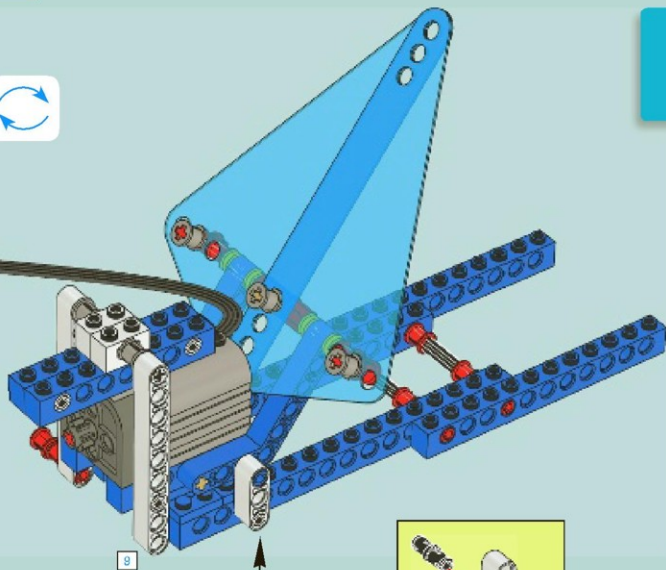



3x

# 23

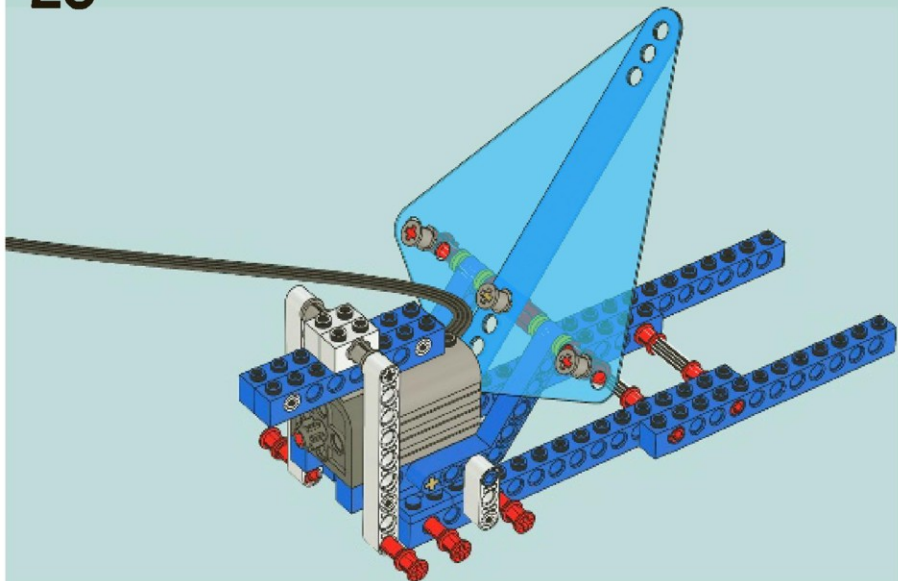

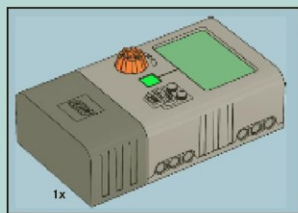

24

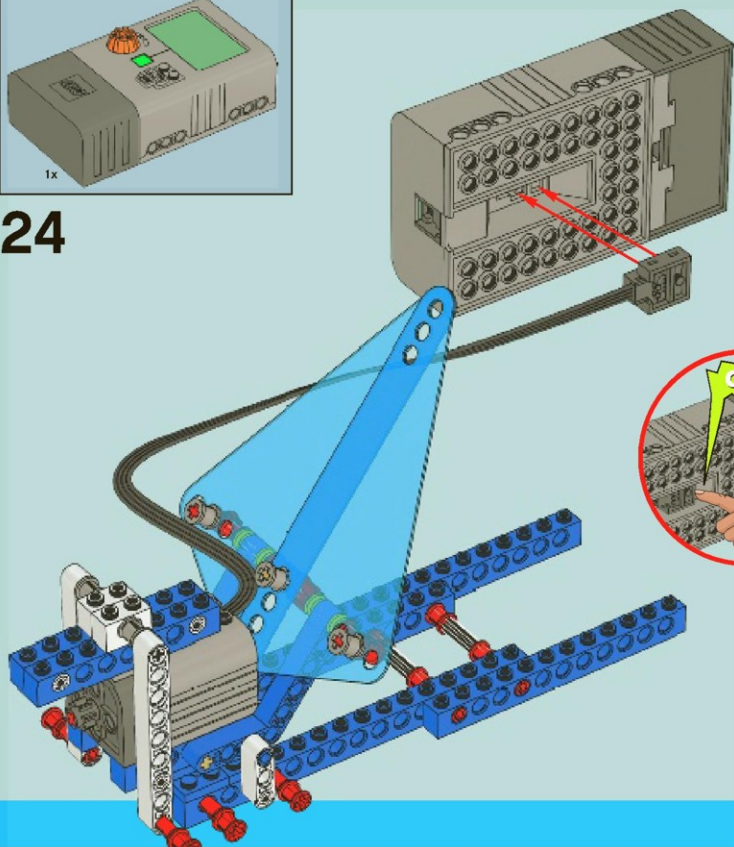

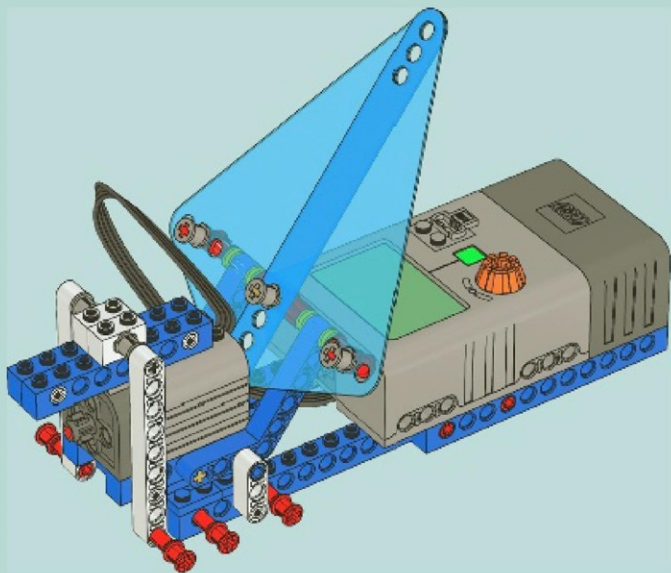



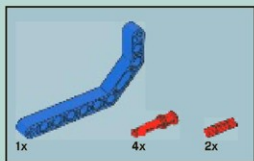

1

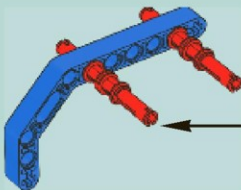
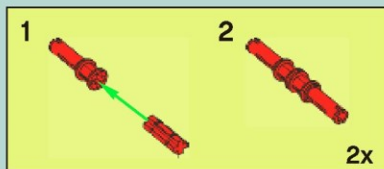



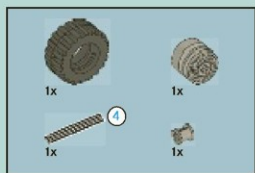

2

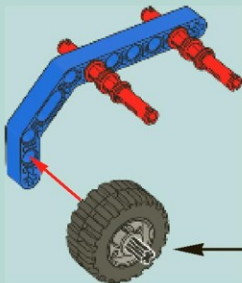
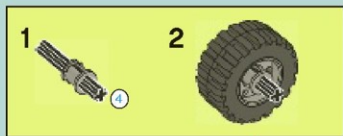

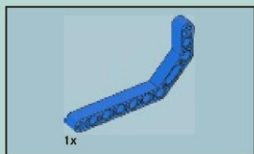

3

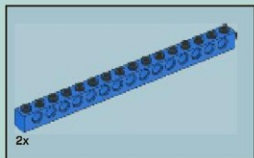
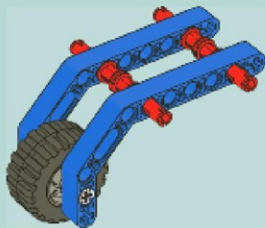

4

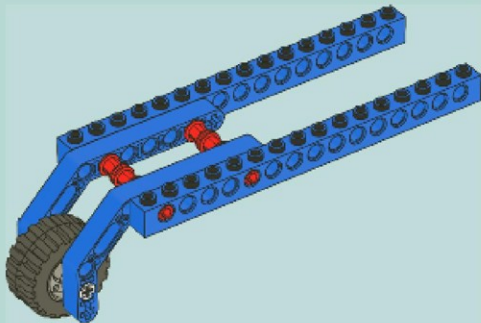

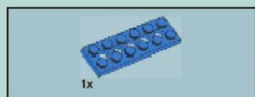

5

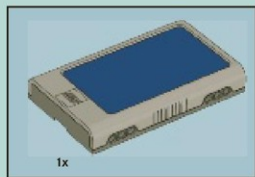
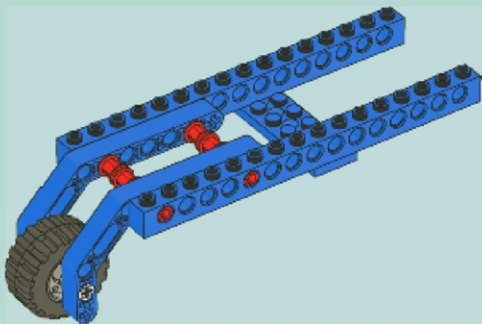

6

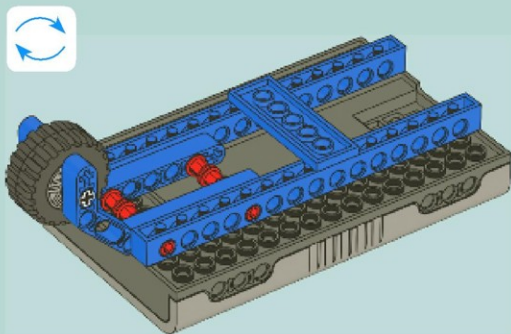

7

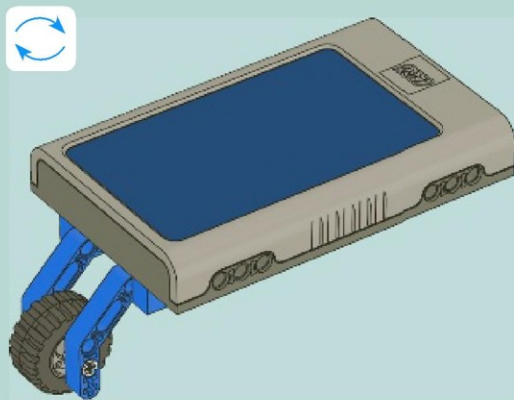

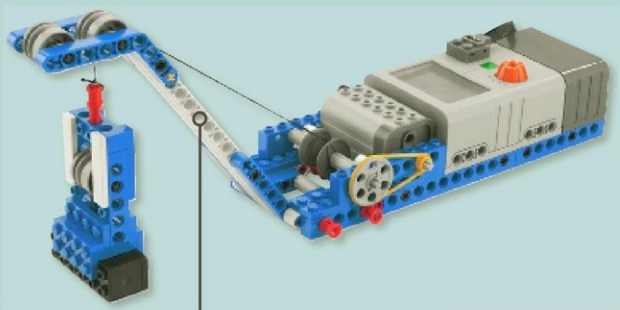

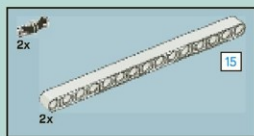

1

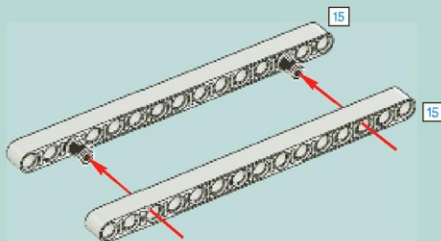

2

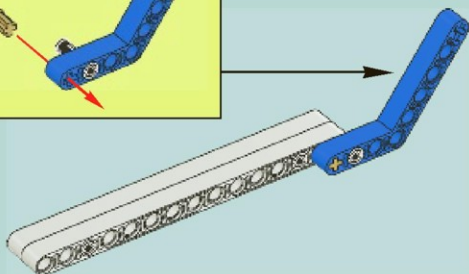
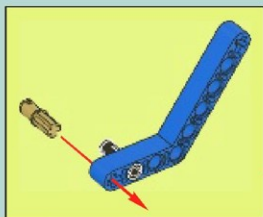



3

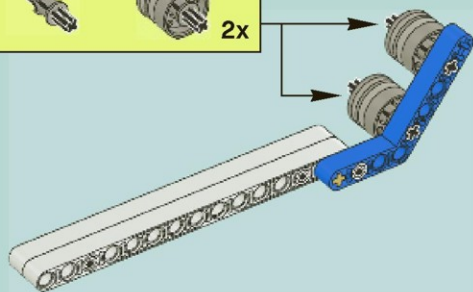
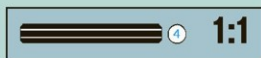
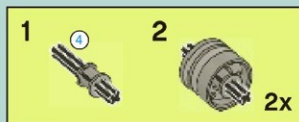

4

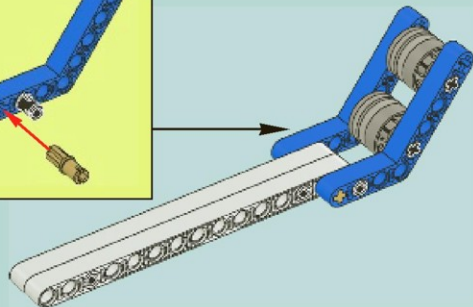
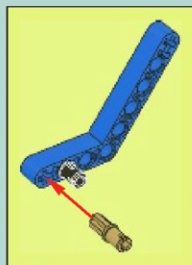

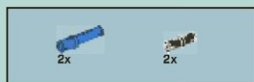

5

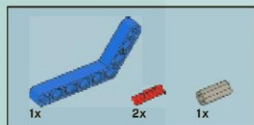
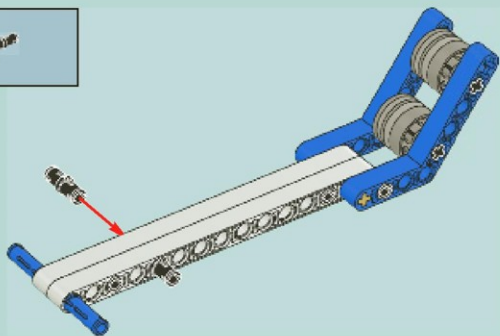

6

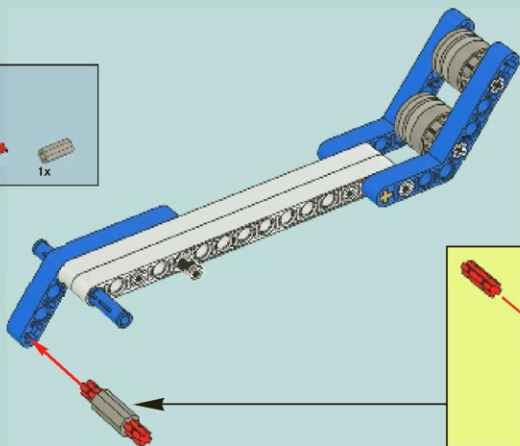



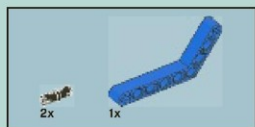

7

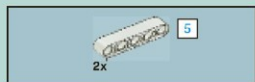
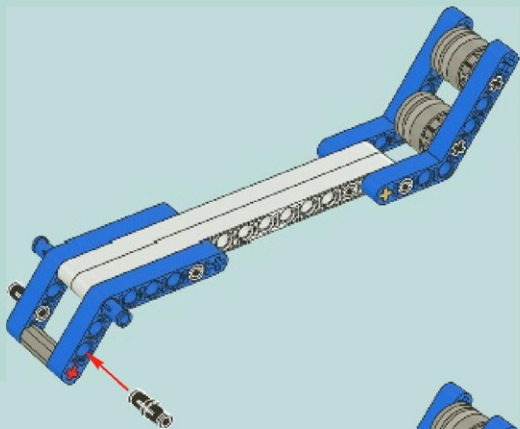

8

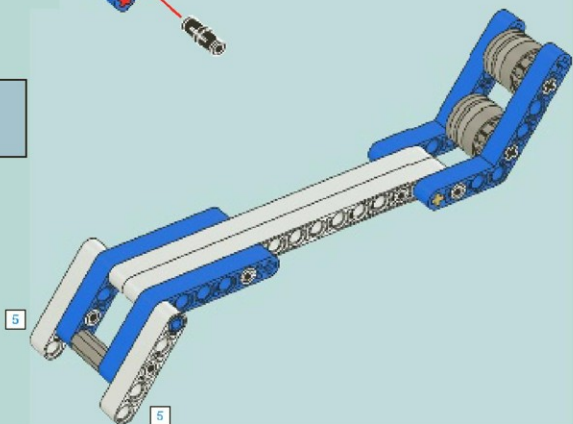



9

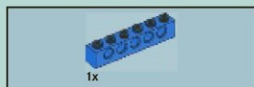
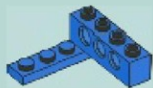

10

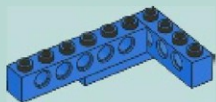

11

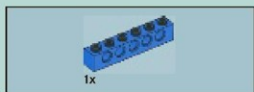
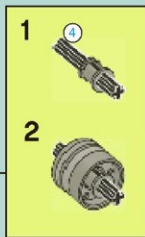
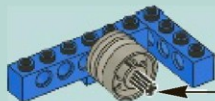

12





13

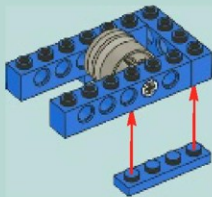

14

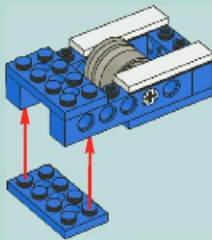

15

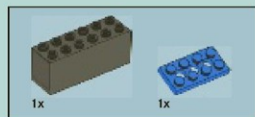
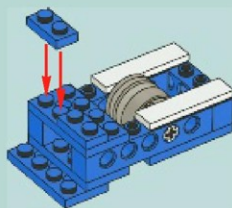

16

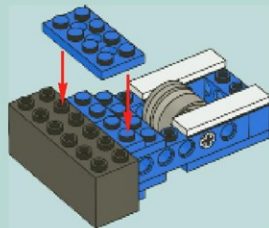

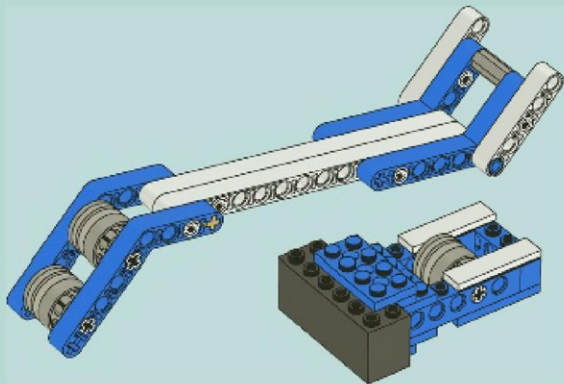

9688

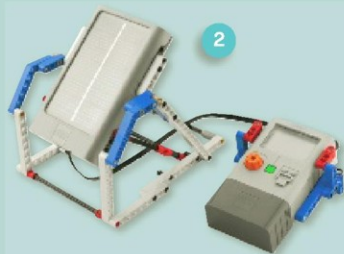

1B

2B

3B



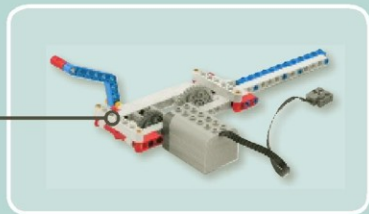

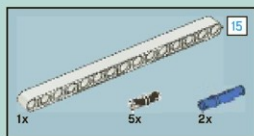

1

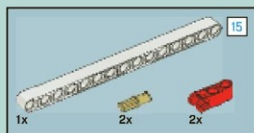
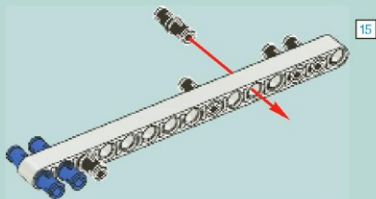

2

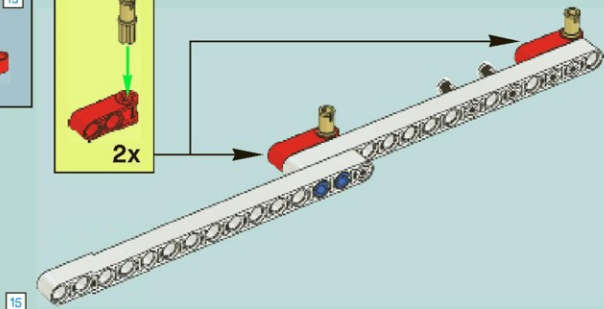
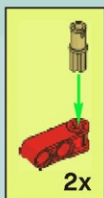





3

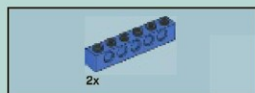
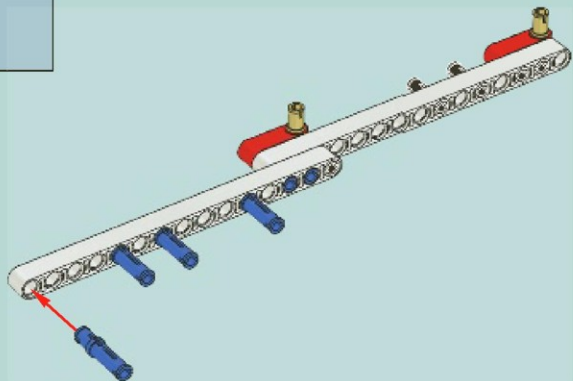

4

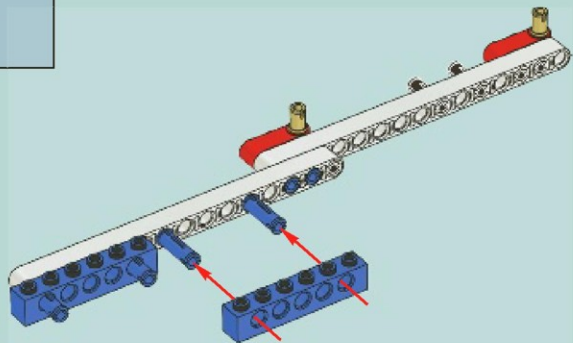

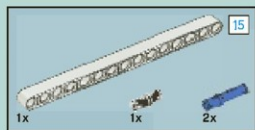

5

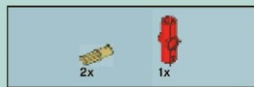
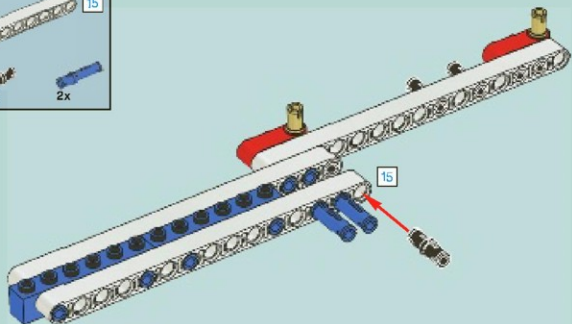

6

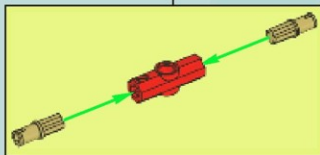
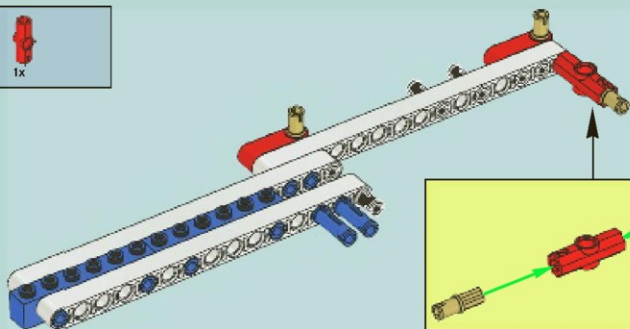

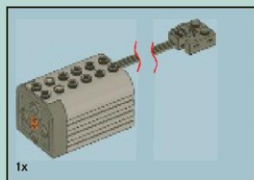

7

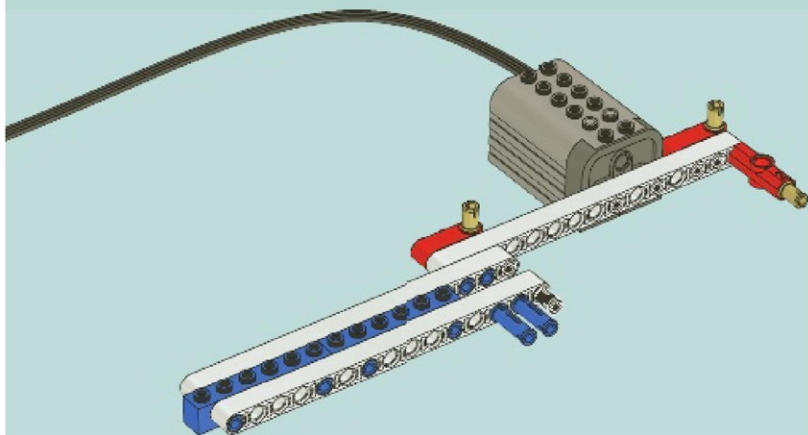

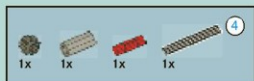

8

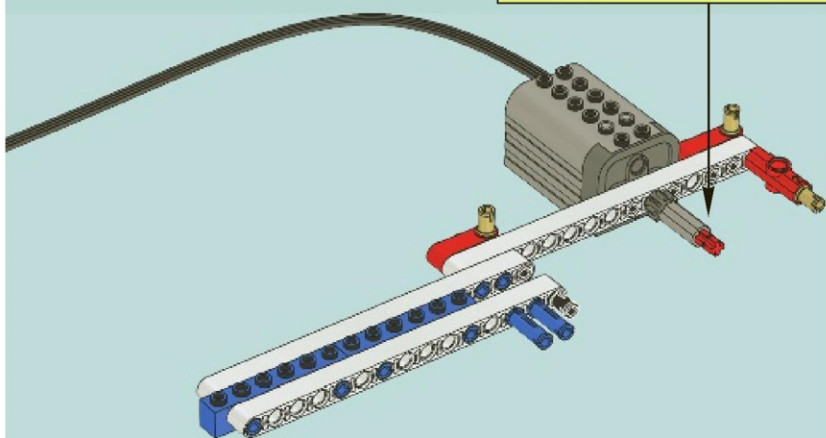
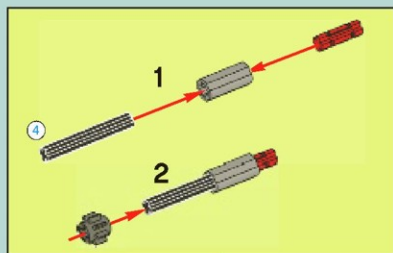



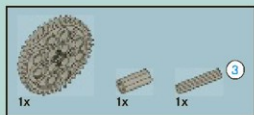

10

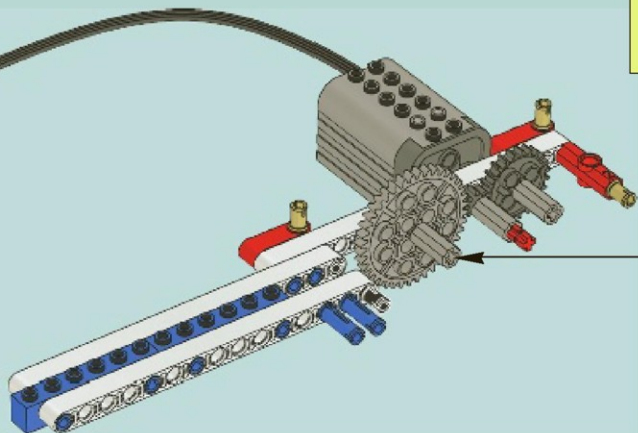
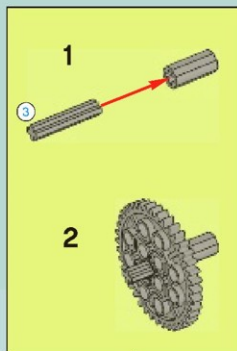

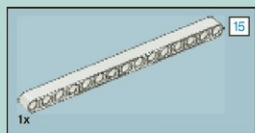

11

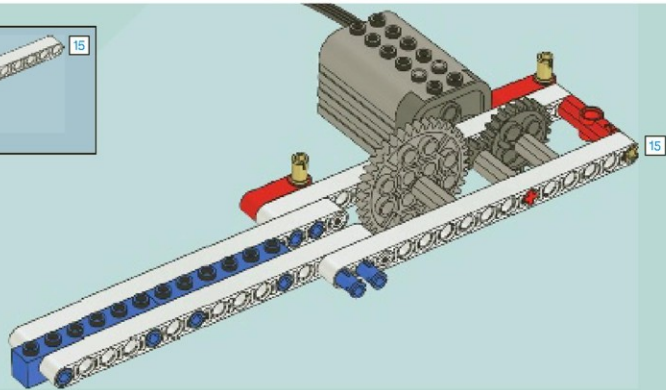

12

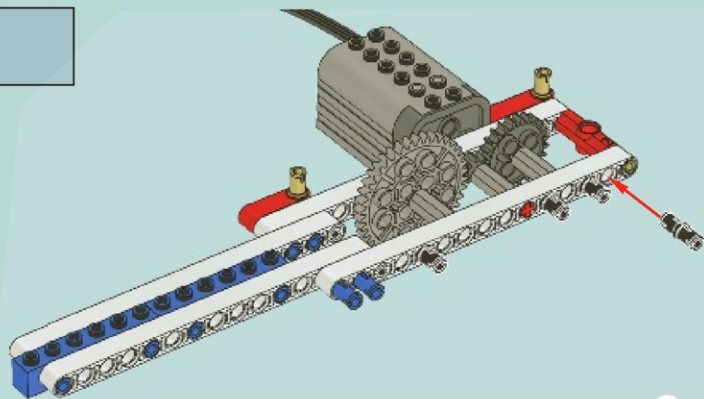



2x



2x

# 13

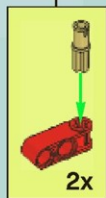
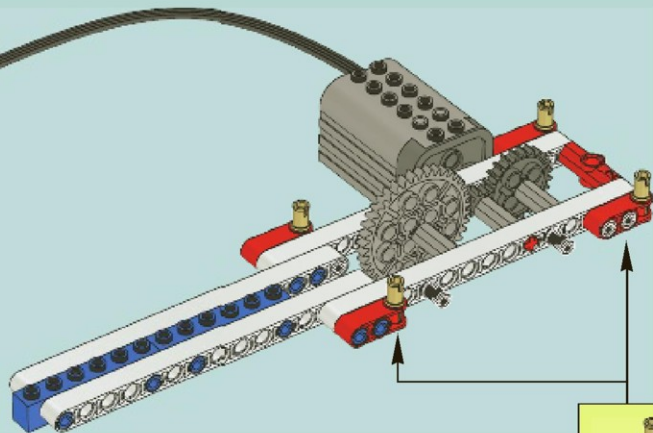

2x



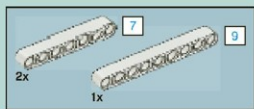

14

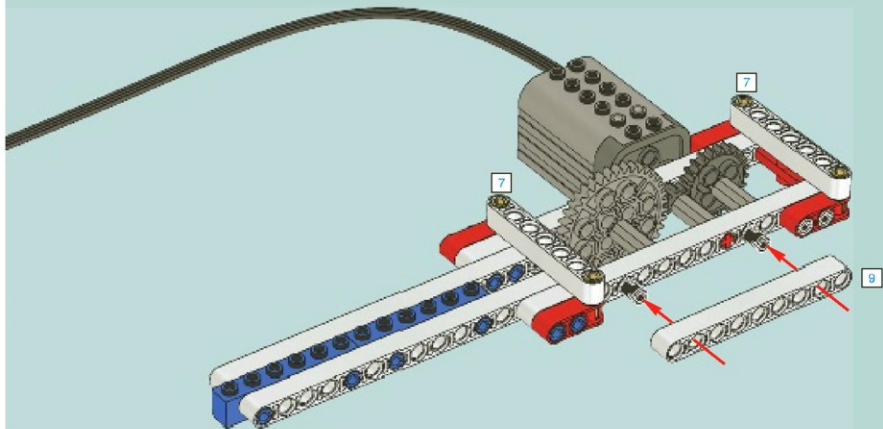



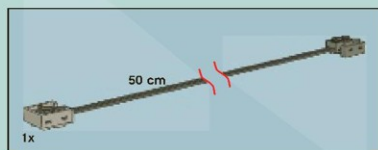

16

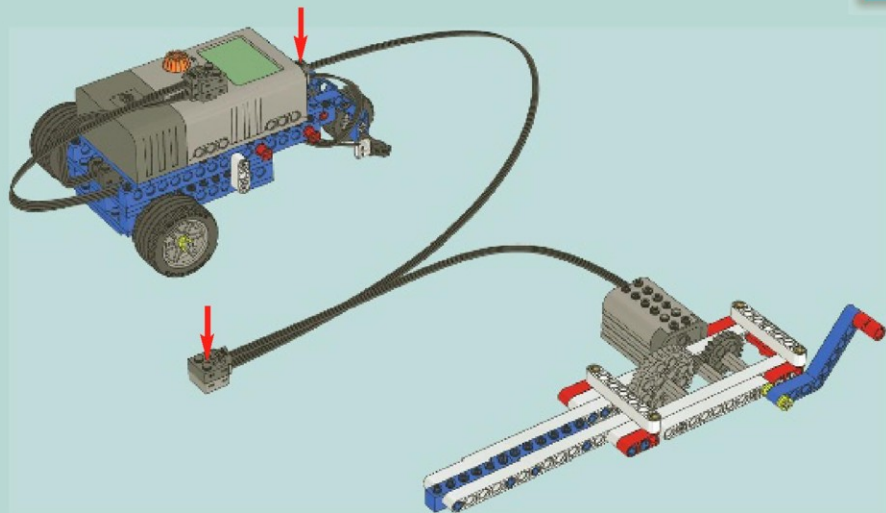

1

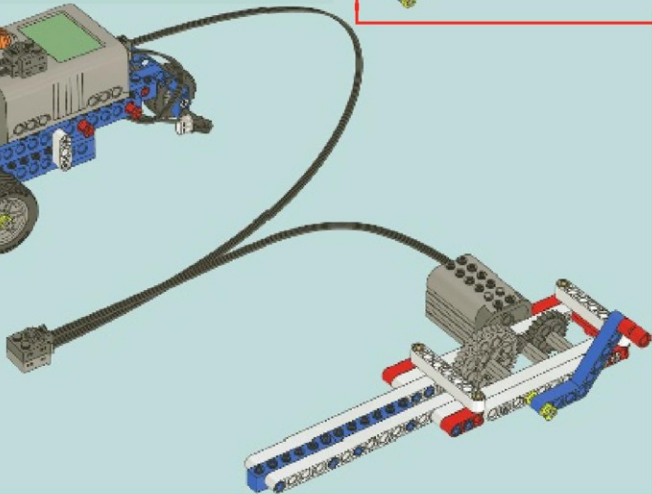
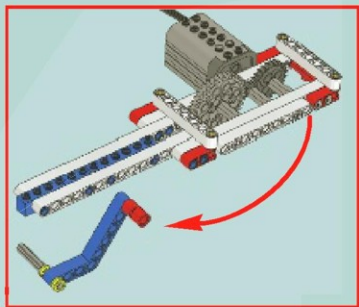
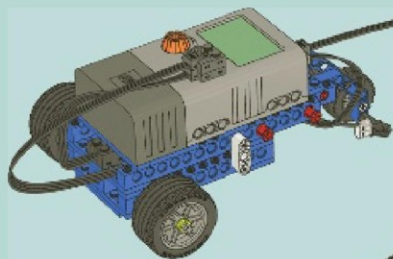



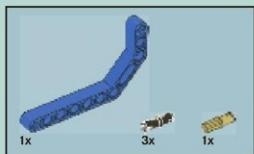

1

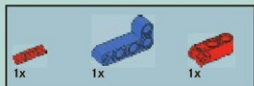
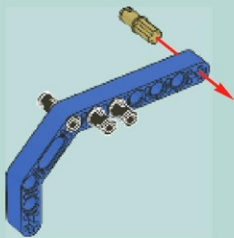

2

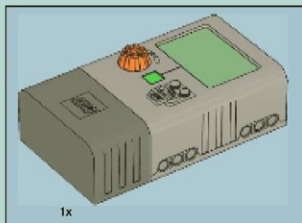
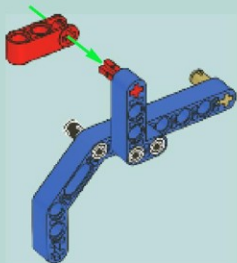

3

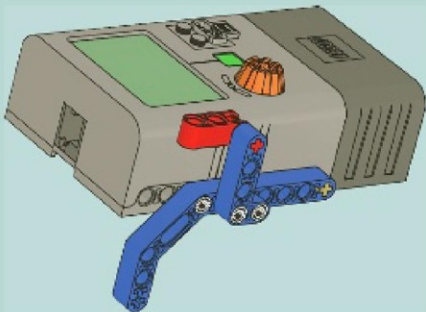

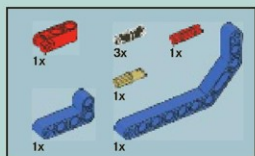

4

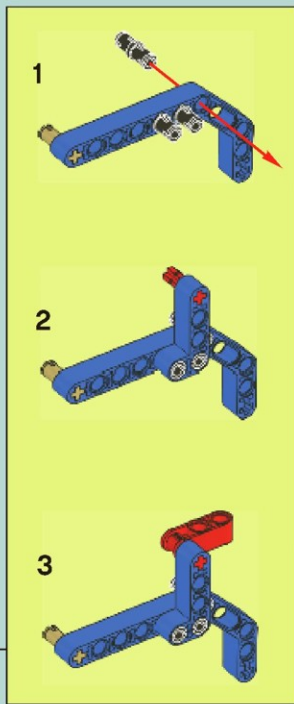
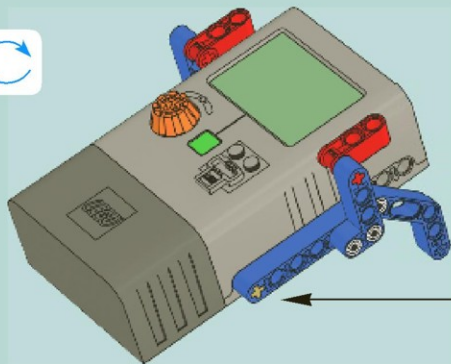

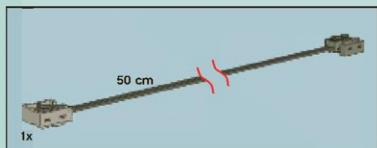

5

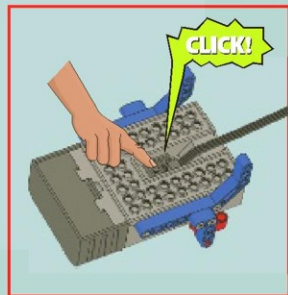
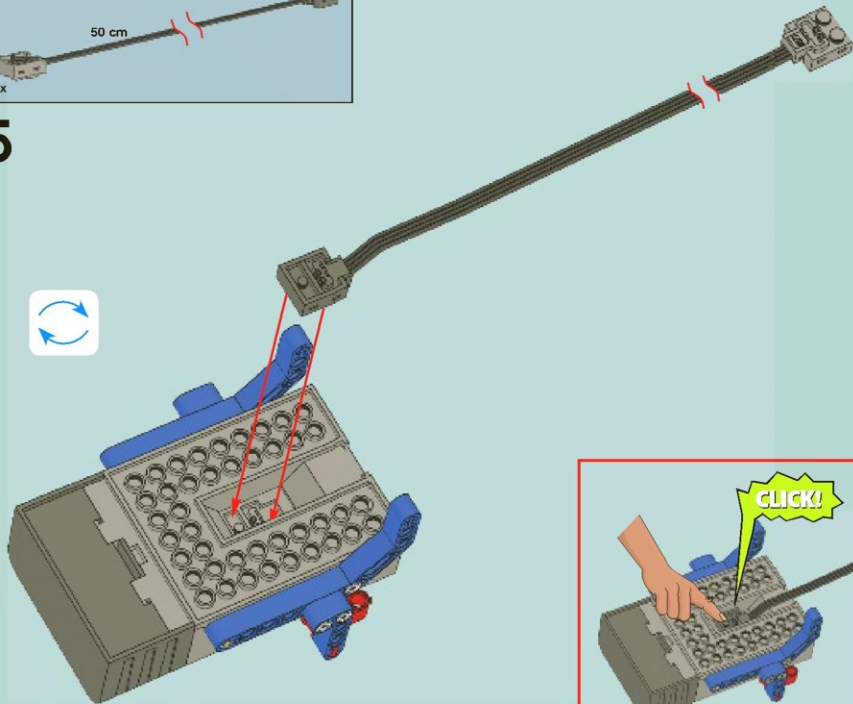



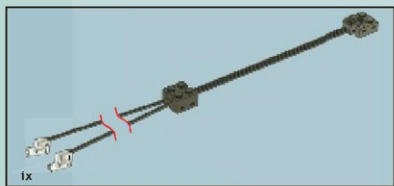

6

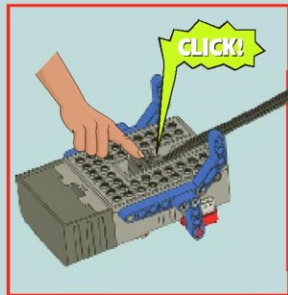
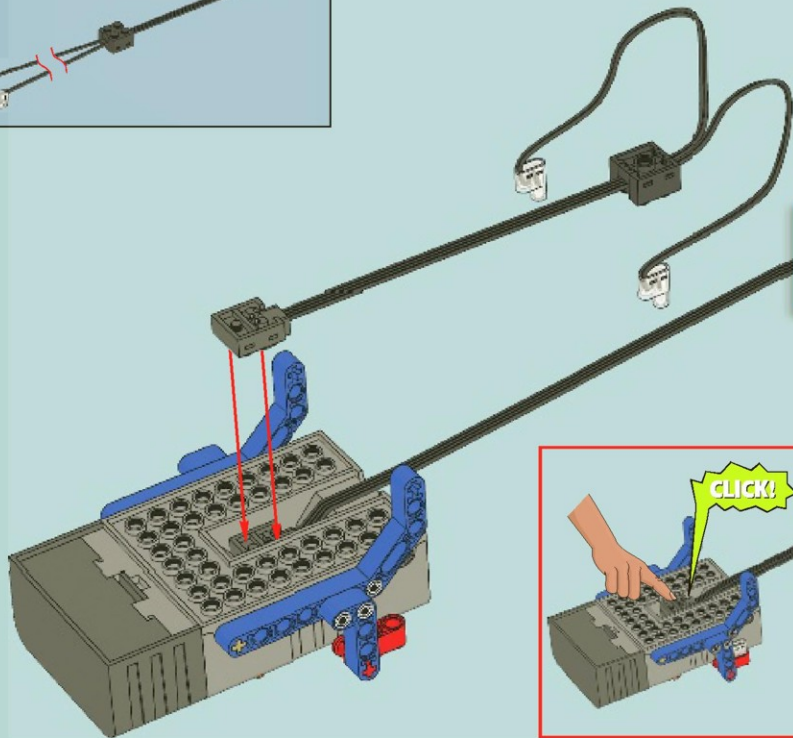

7

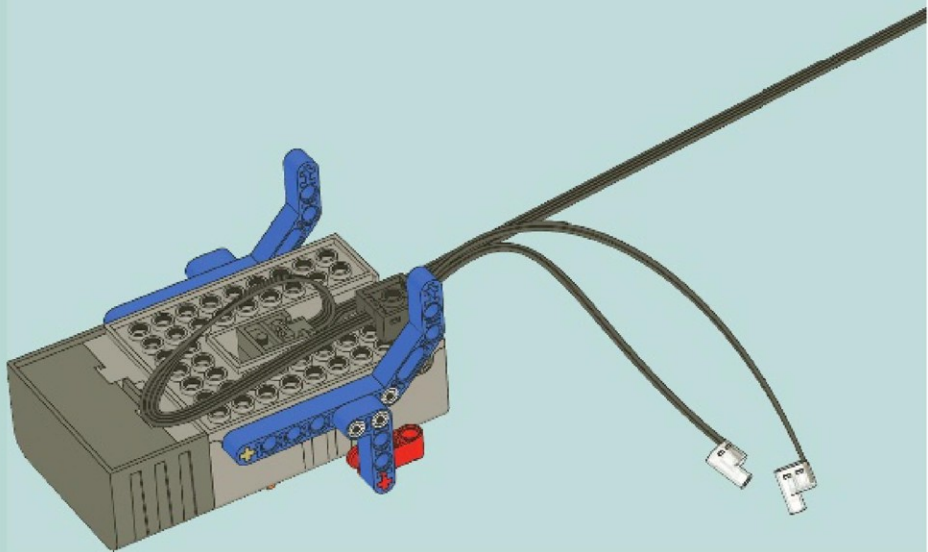

8

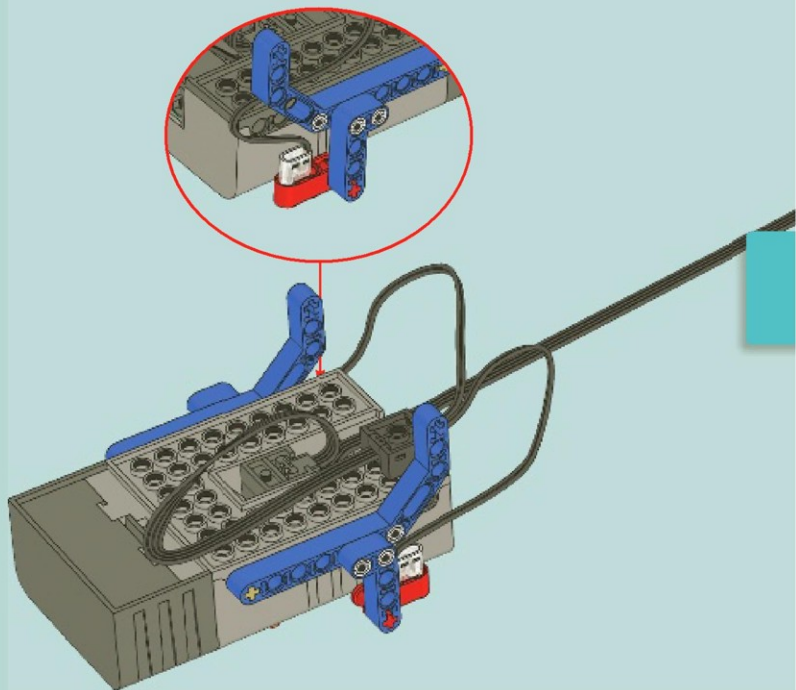

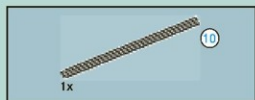

9

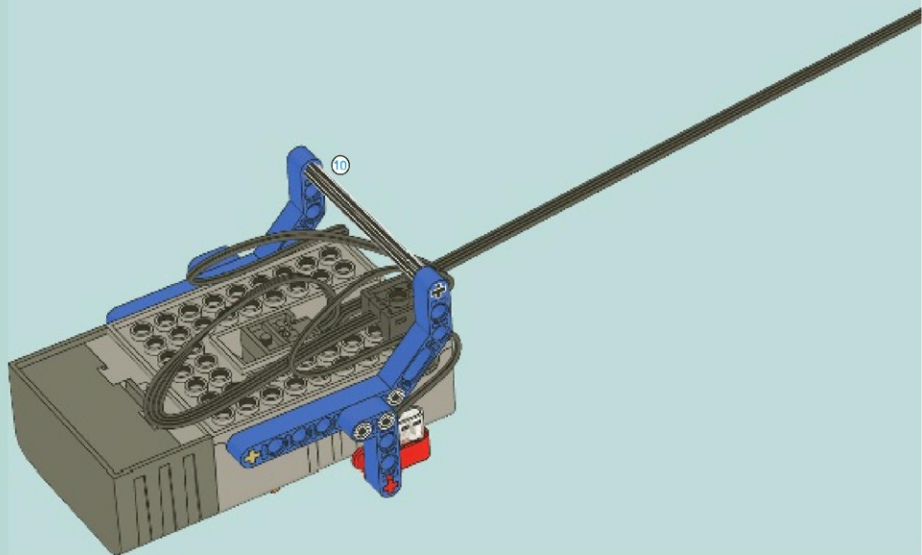

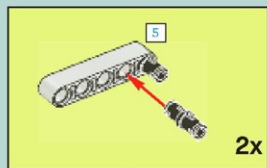
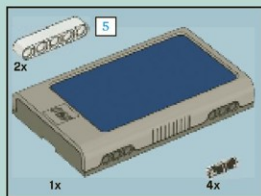

# 10

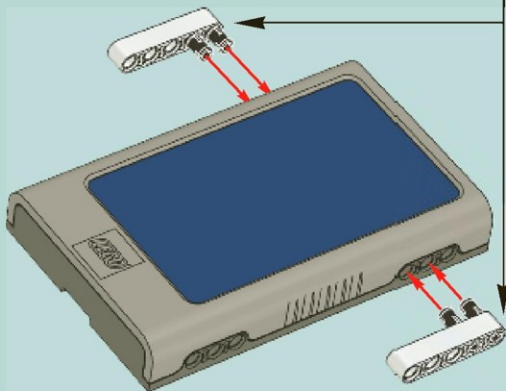

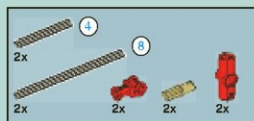

# 11

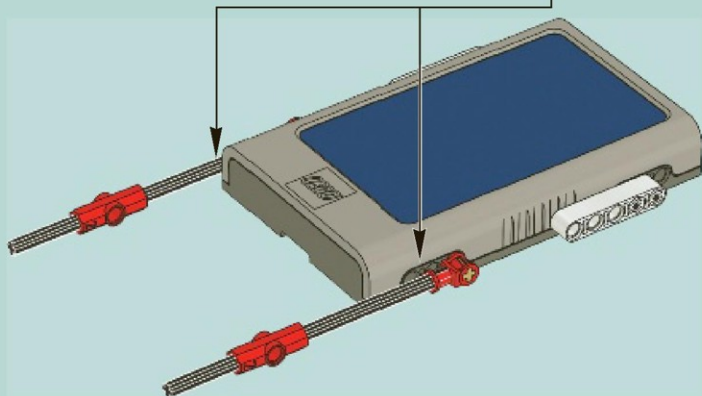
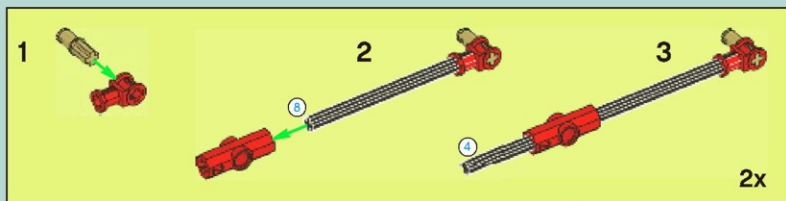

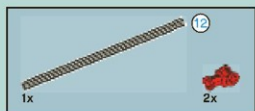

12

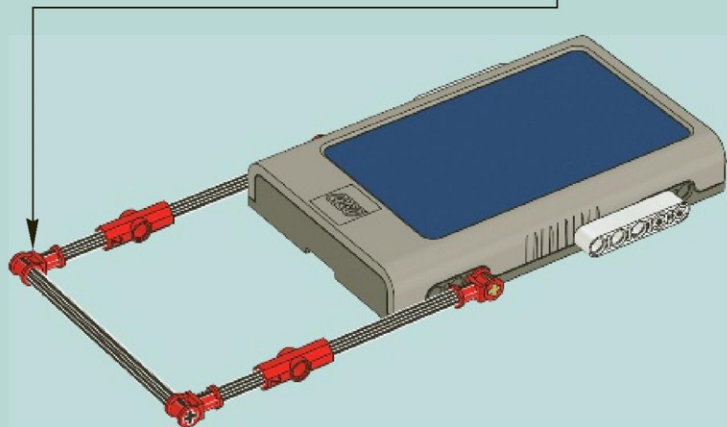
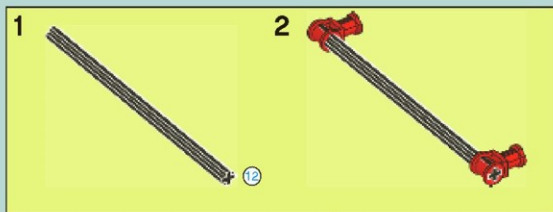

13

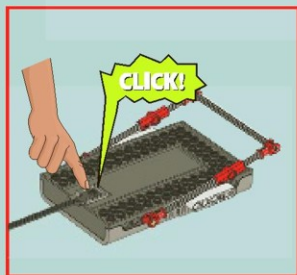
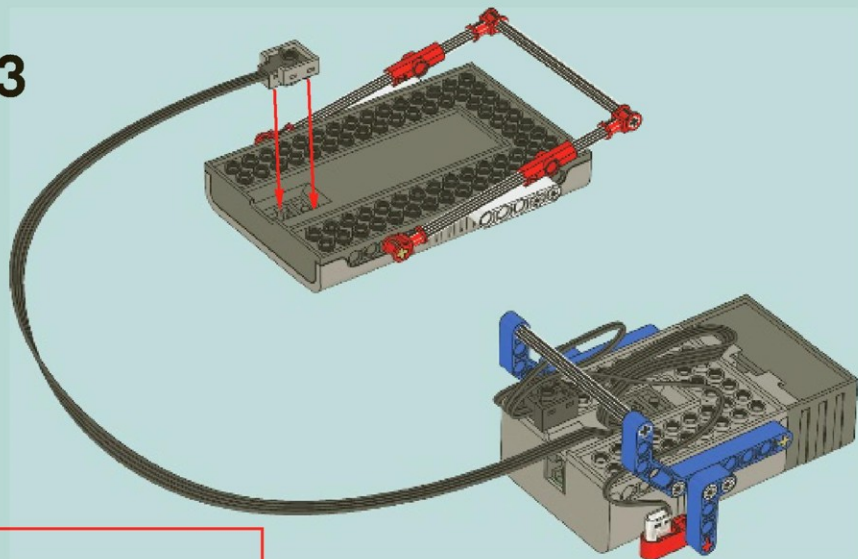



14

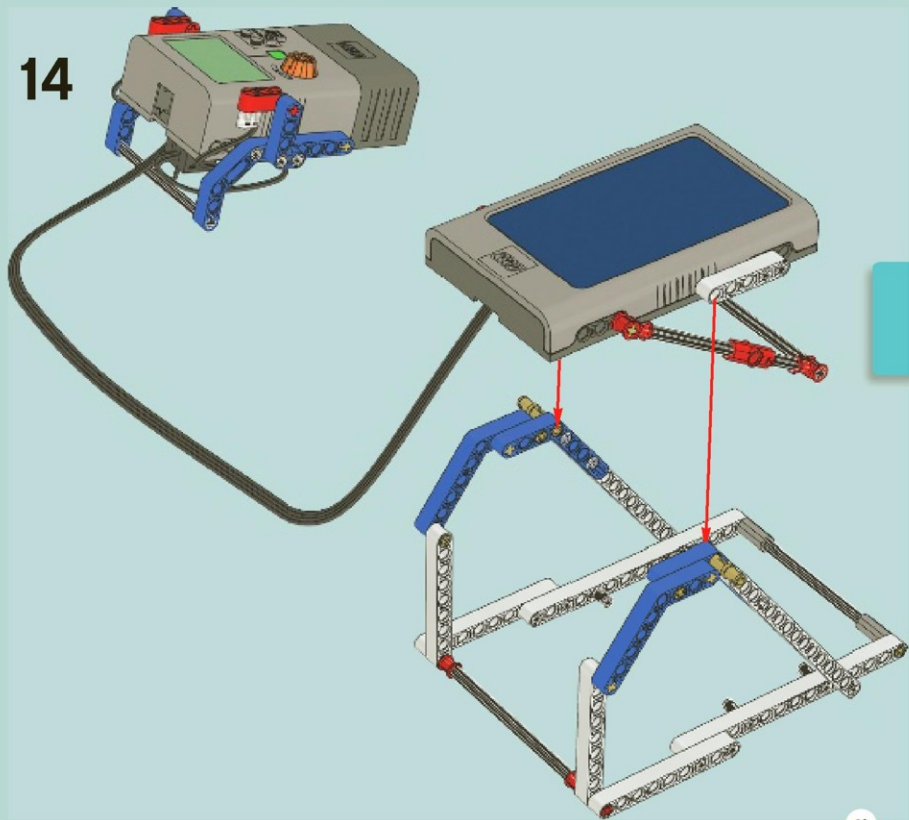

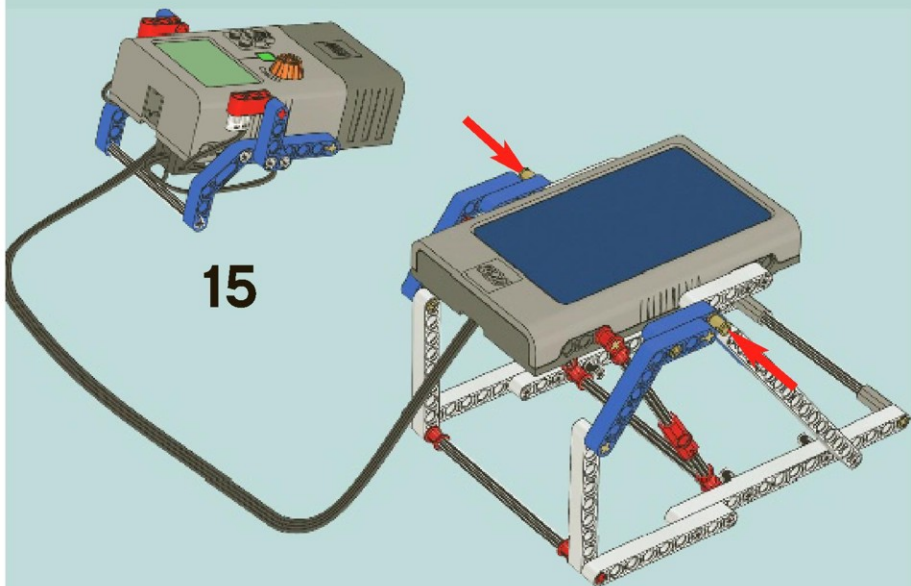

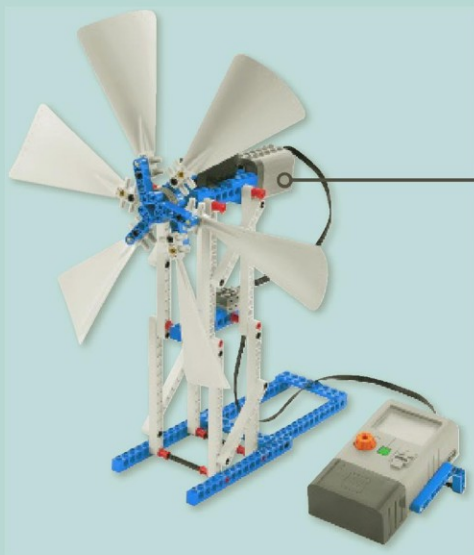

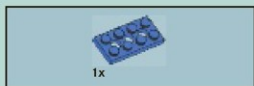

1

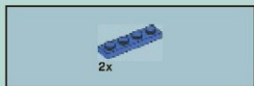

2

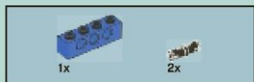
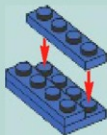

3

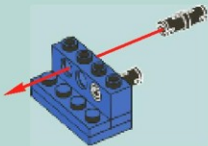

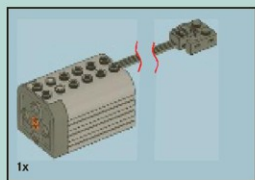

4

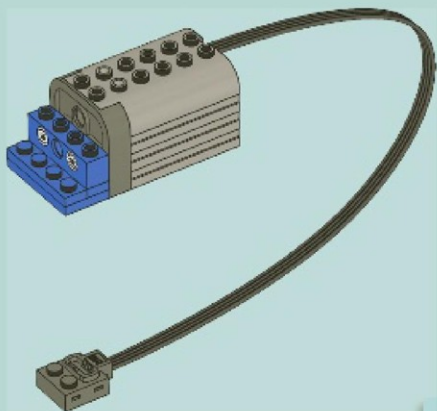

5

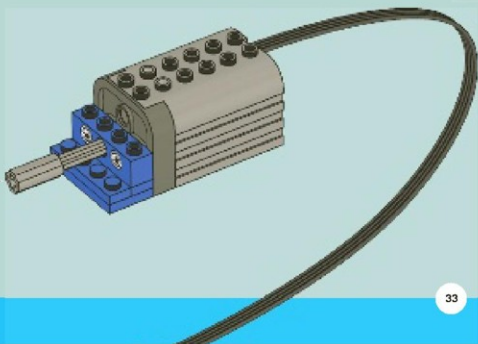
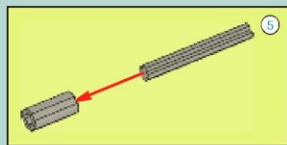

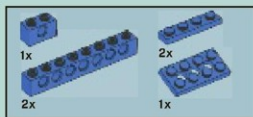

6

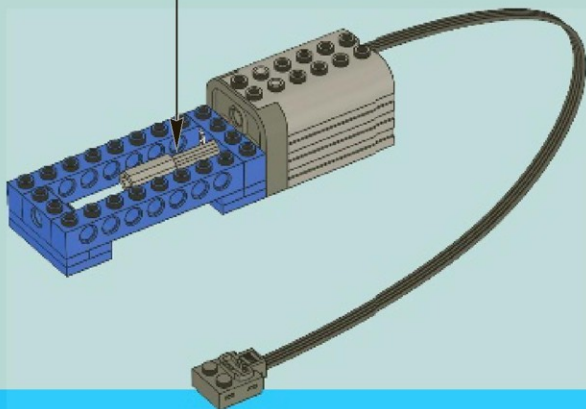
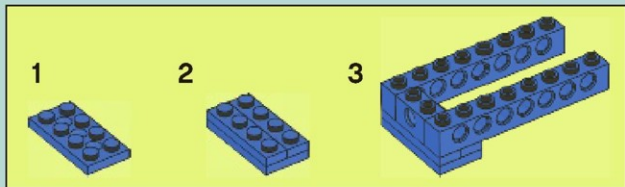

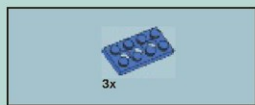

7

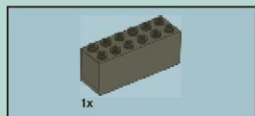
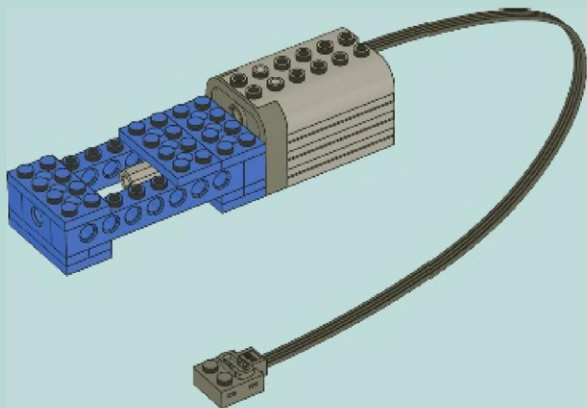

8

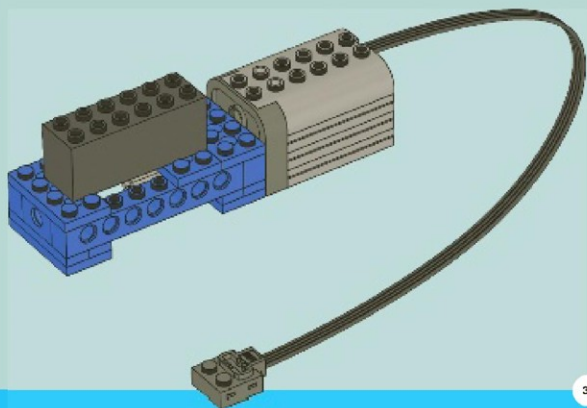

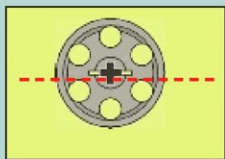
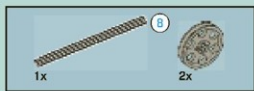

9

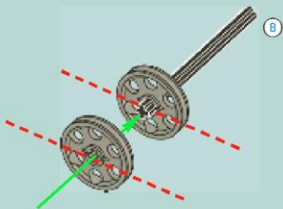

10

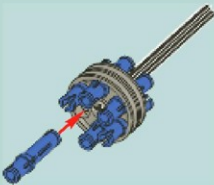





# 11

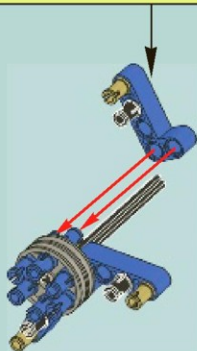
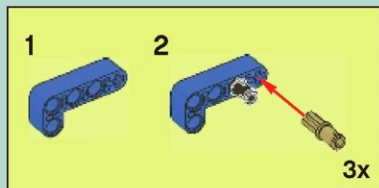

# 12

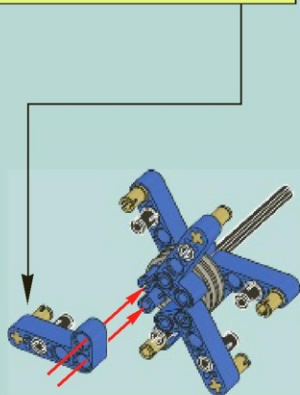
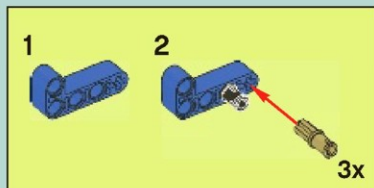

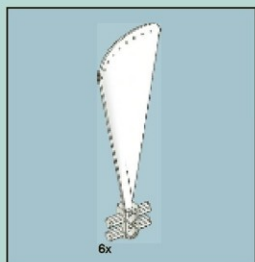

13

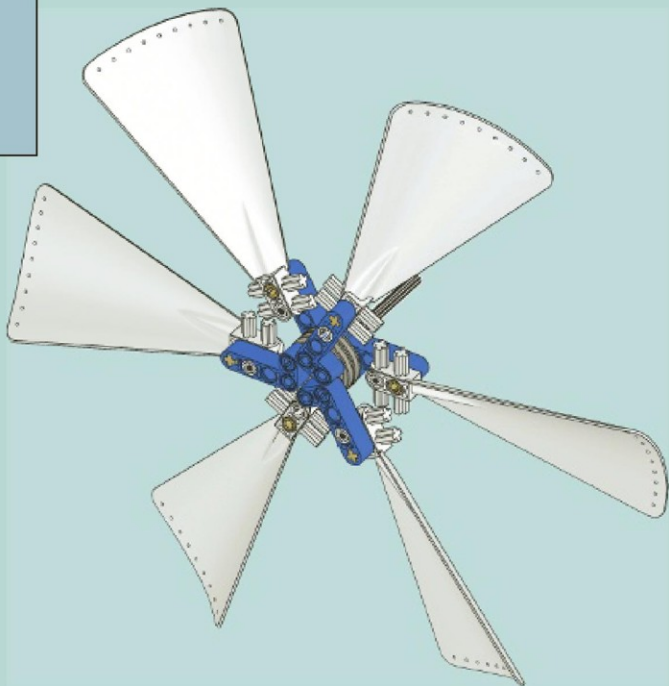



1x

14

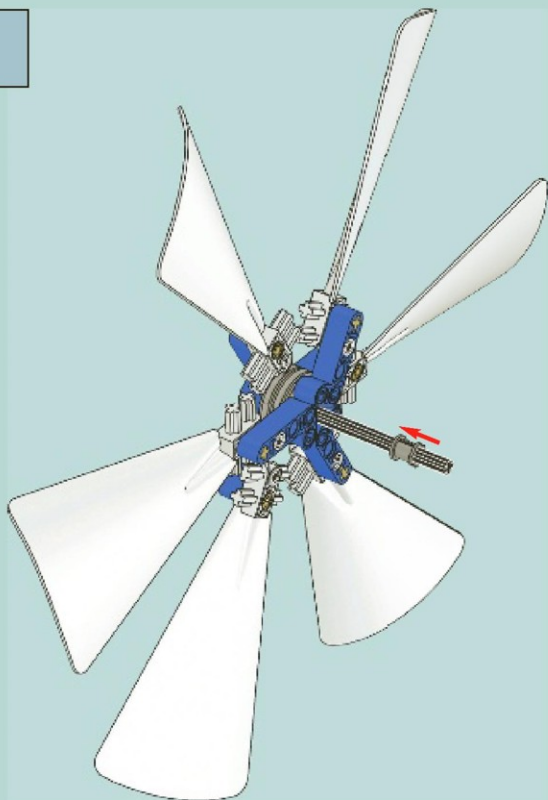

15

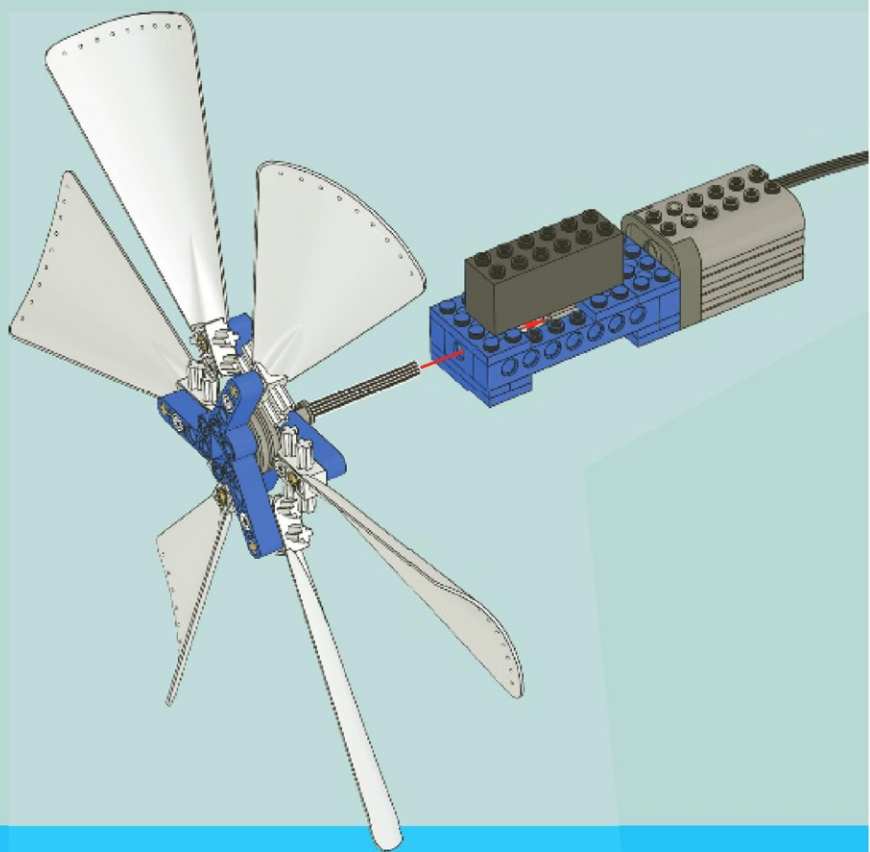

16

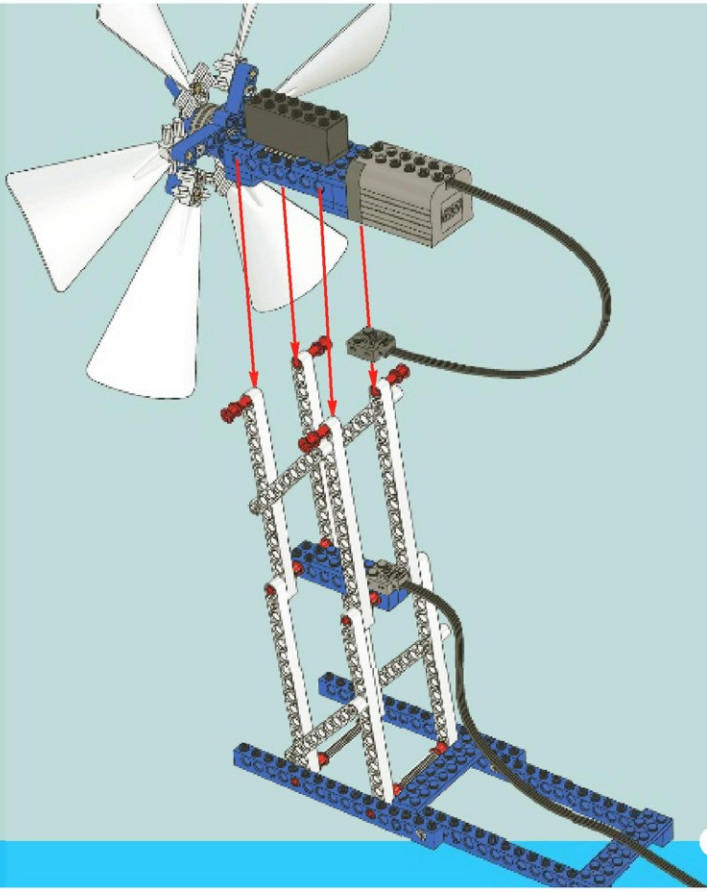

17

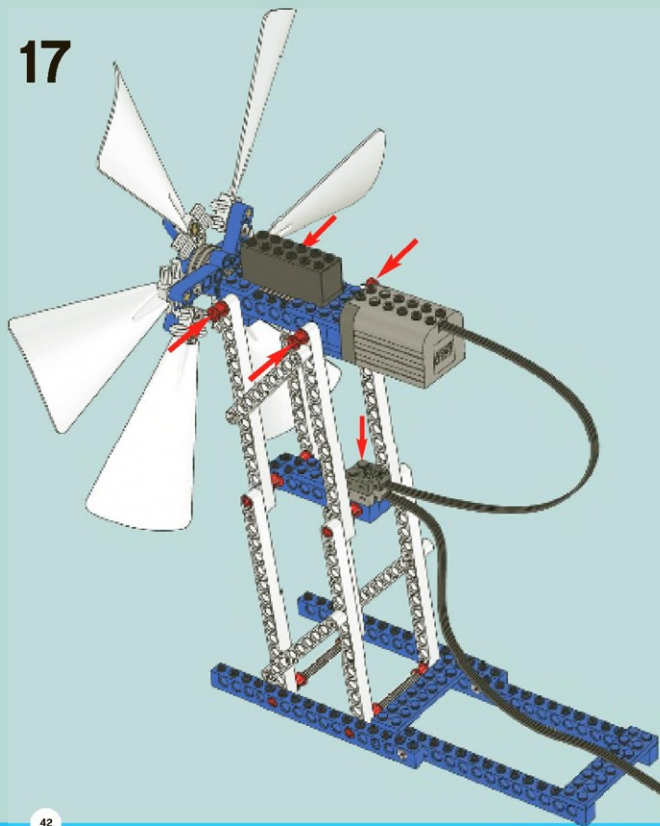

# 18

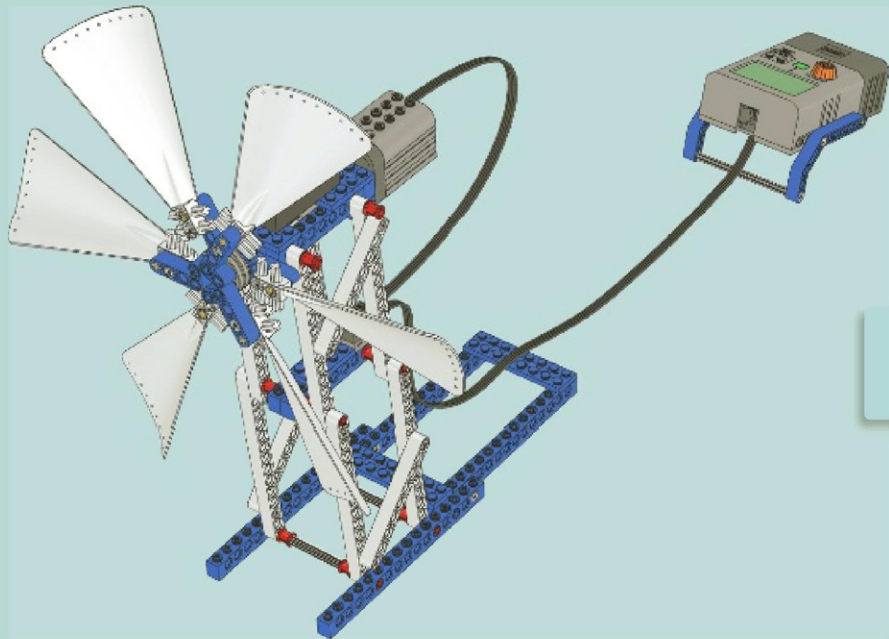

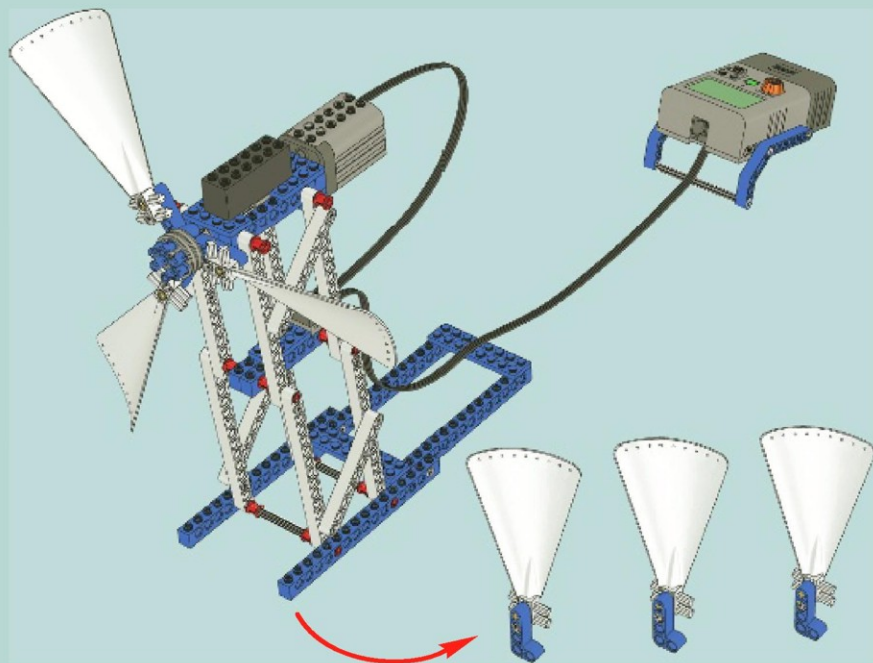



9688

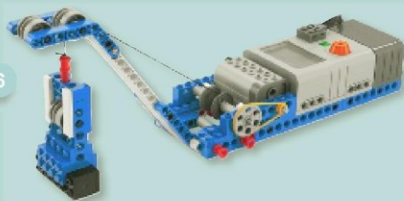
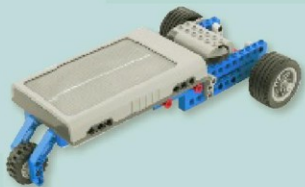

4B

5B

6B



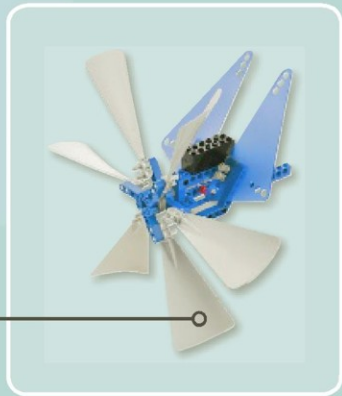
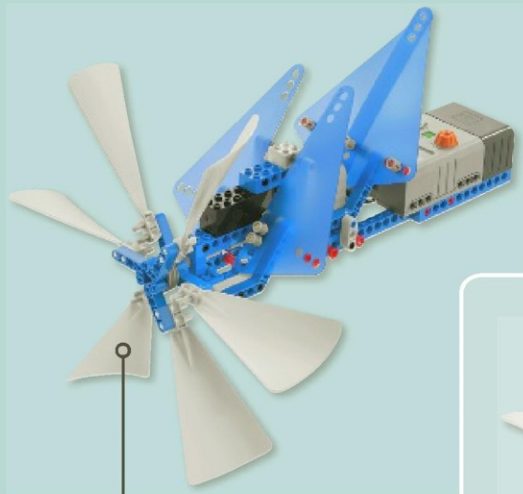

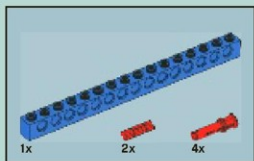

1

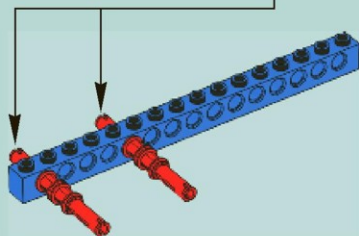
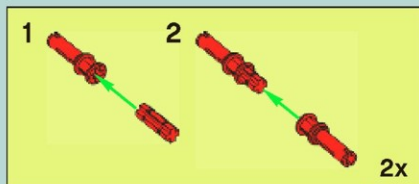

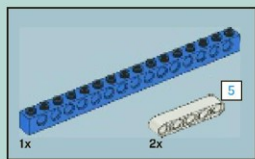

2

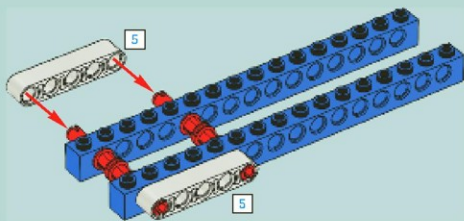

3

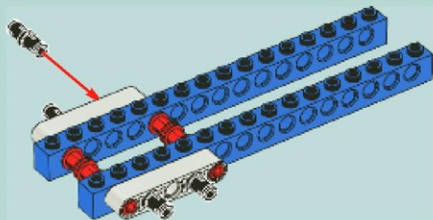



2x

4

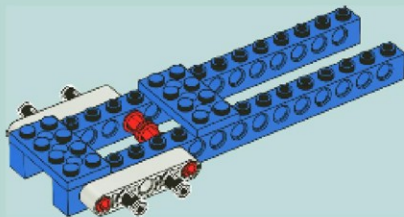

4x

5

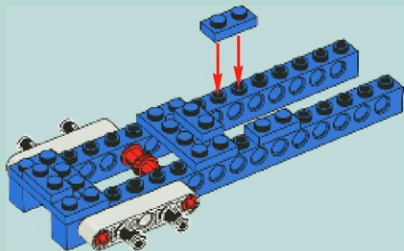

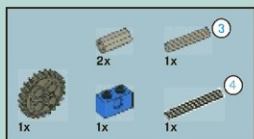

6

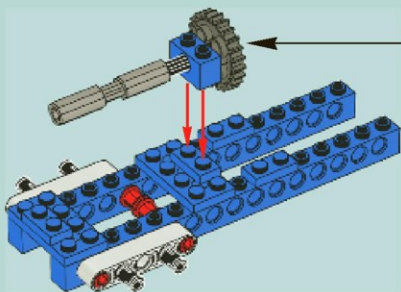
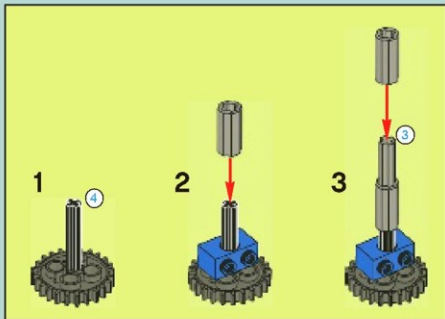

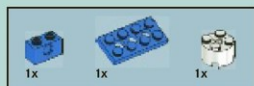

7

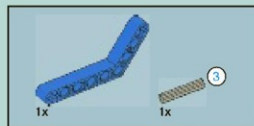
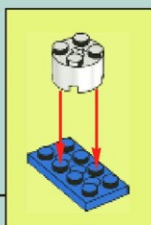
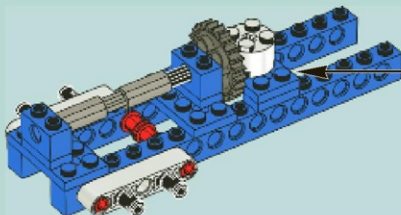

8

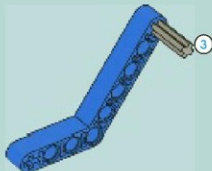



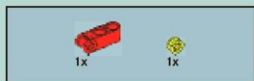

9

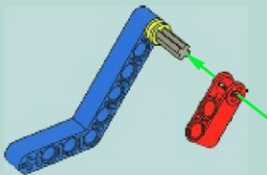

10

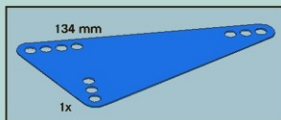
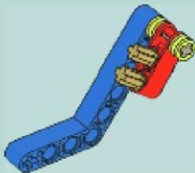

11

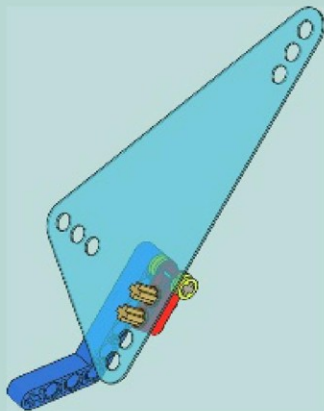



2x

12

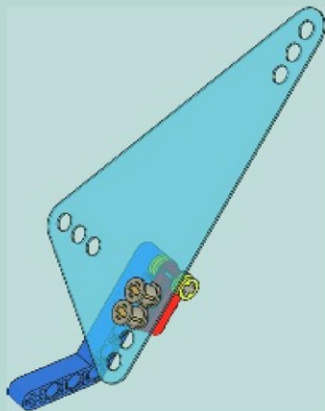

13

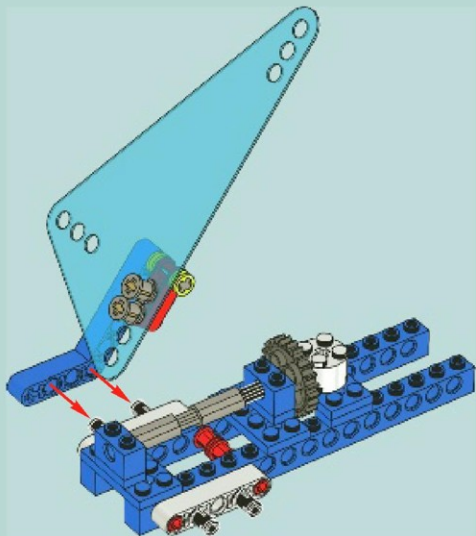

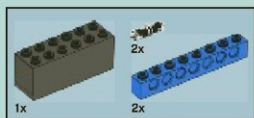

# 14

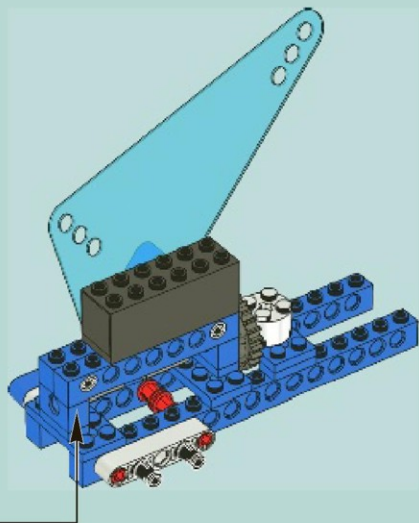
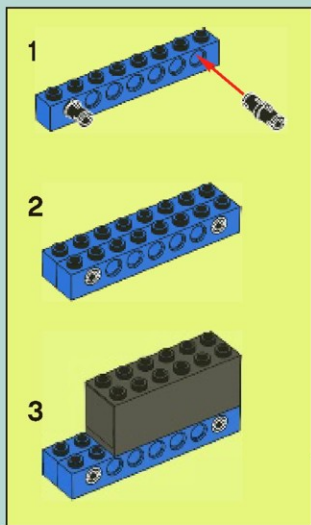



15



16

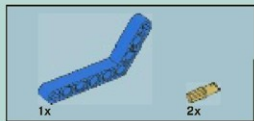
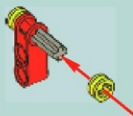

17

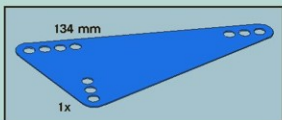
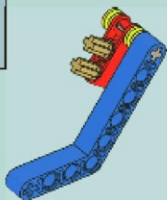

18

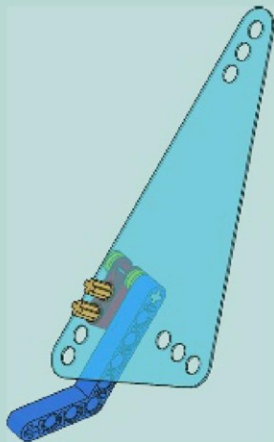



2x

19

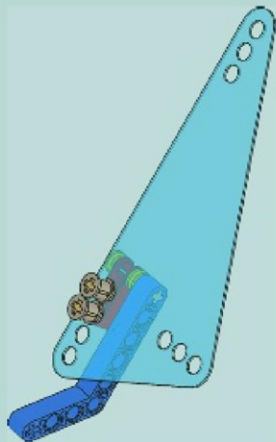

20

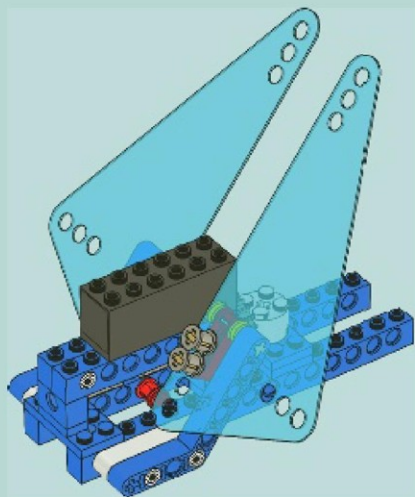

21

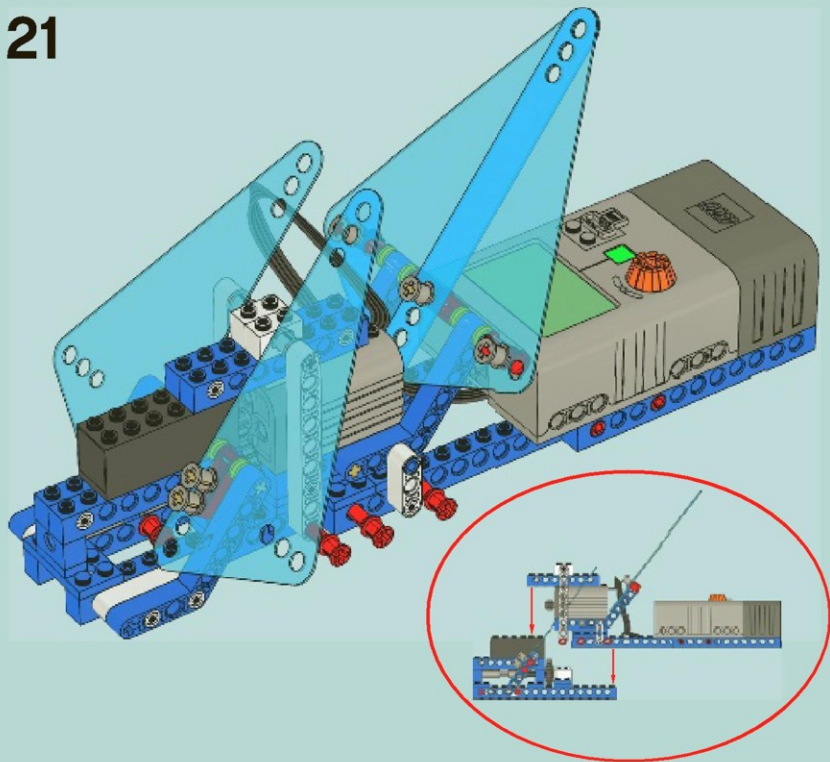

22

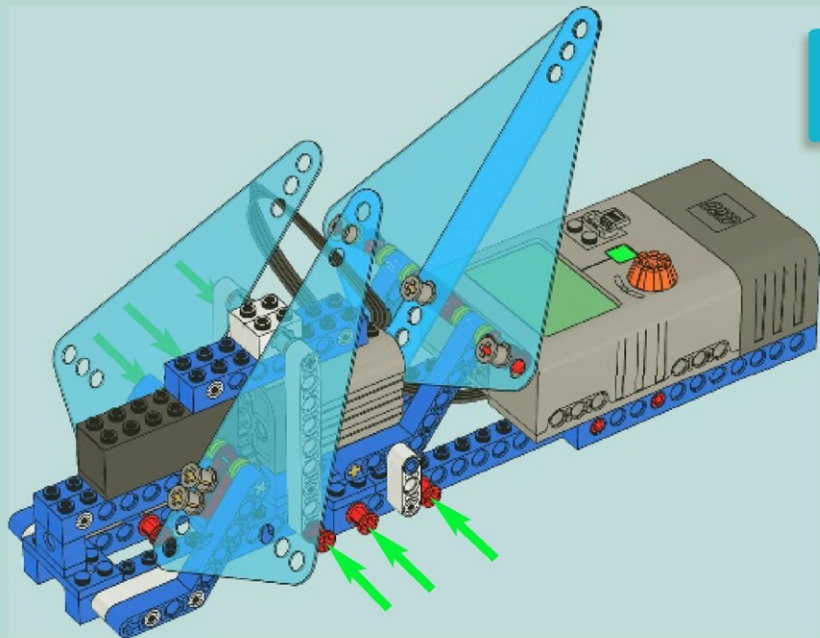



1x

# 23



1x

# 24



5

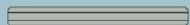

5 1:1



1x

# 25

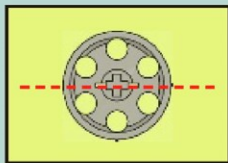
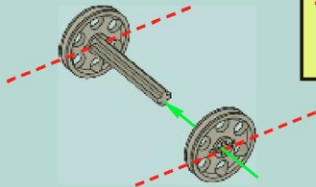

6x

# 26

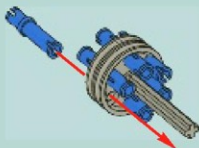



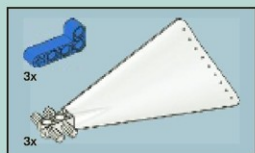

27

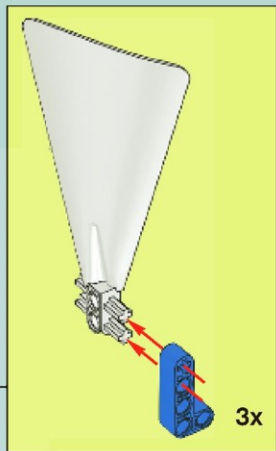
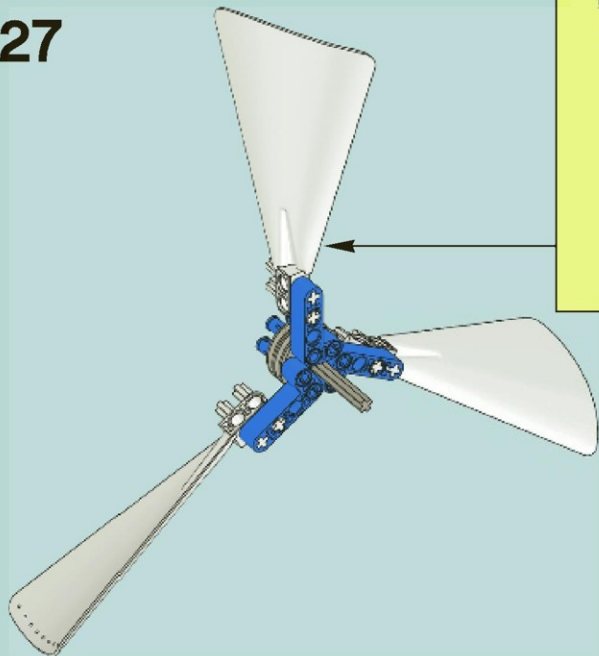



1x

28

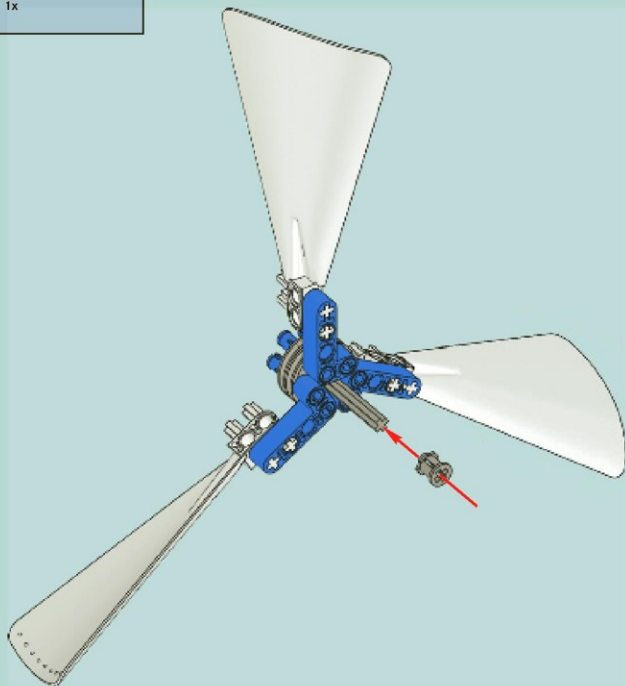

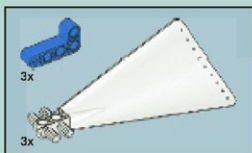

29

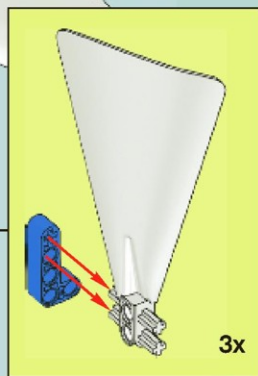
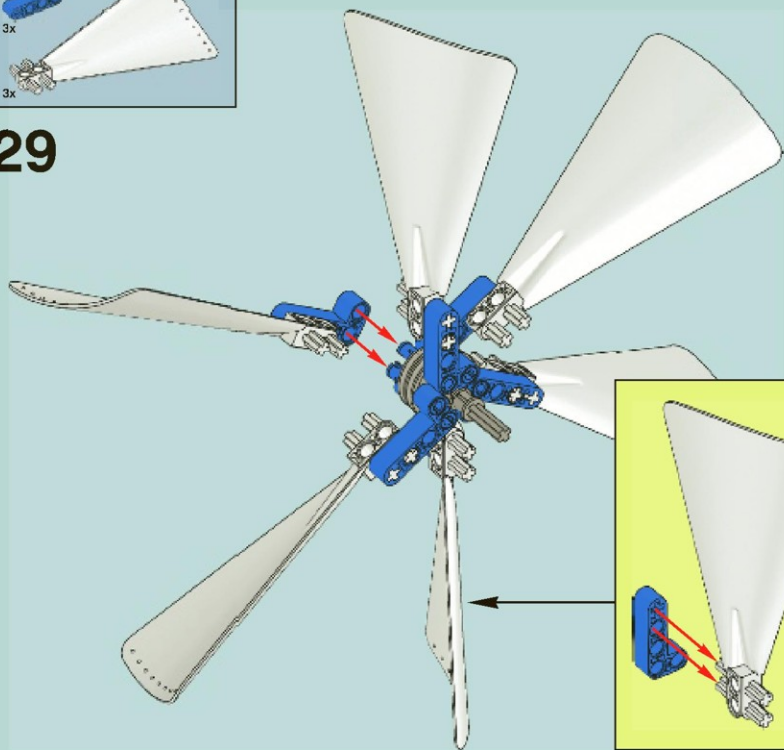

30

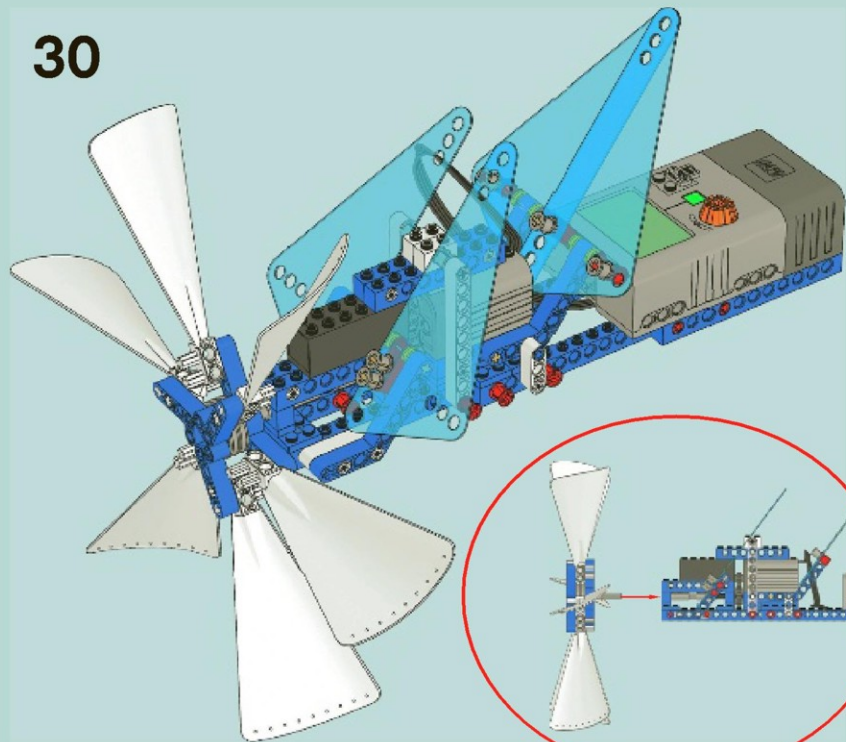

1

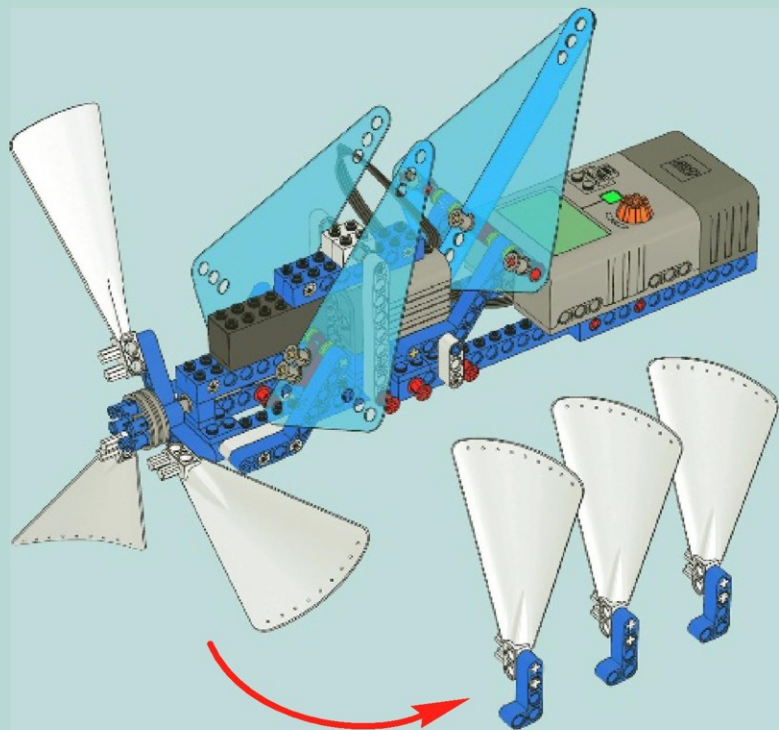

2

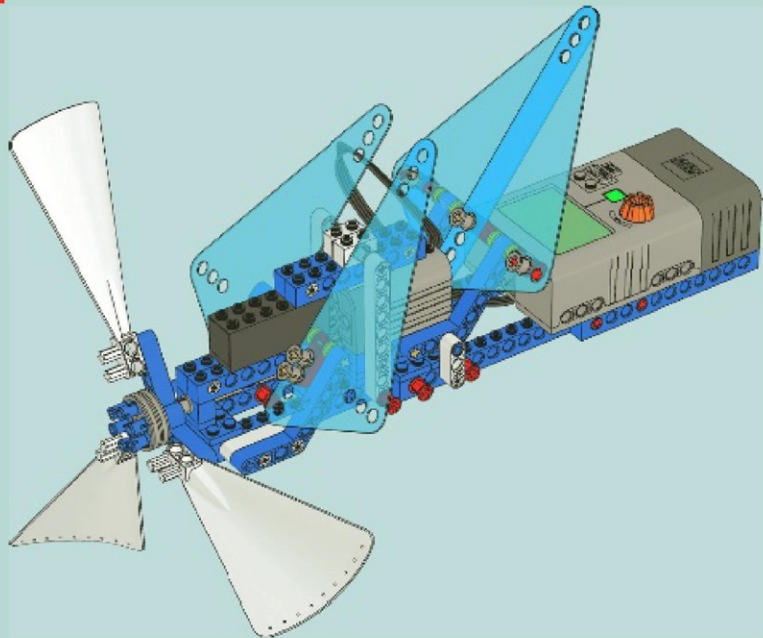

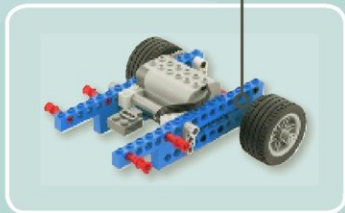
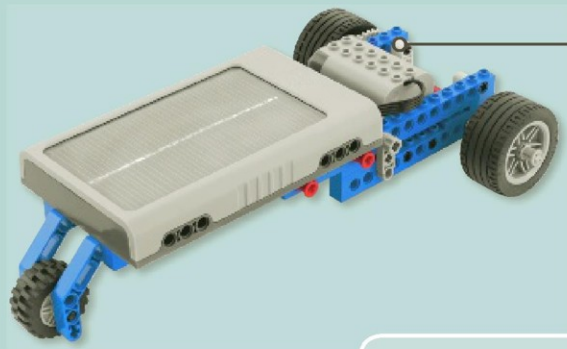

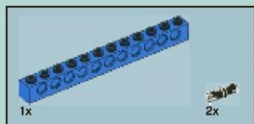

1

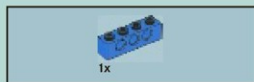
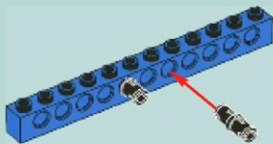

2

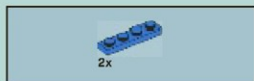
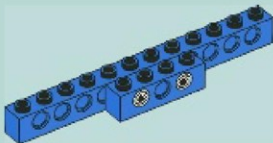

3

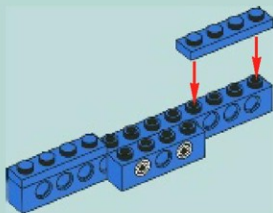

4

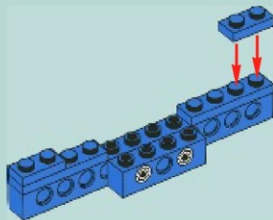



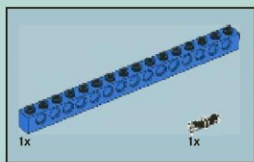

5

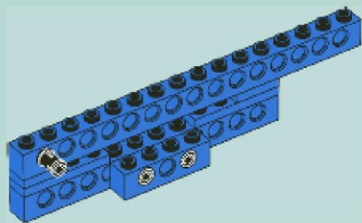

6

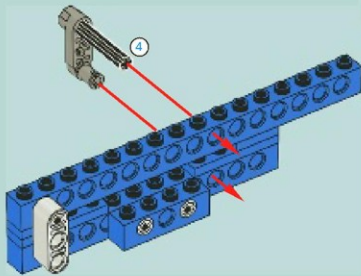

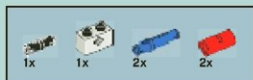

7

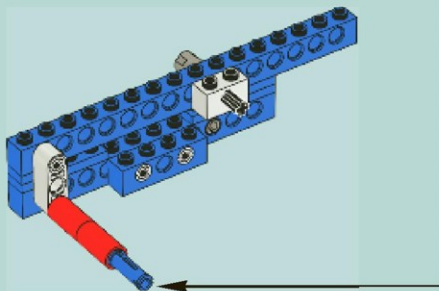
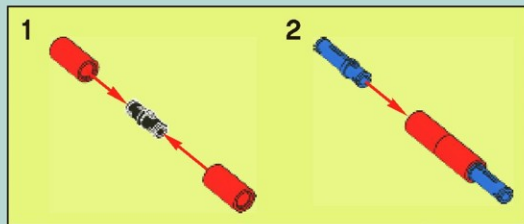

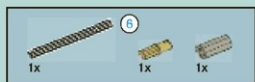

8

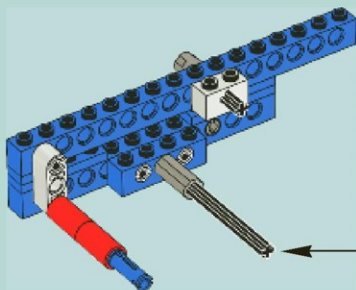
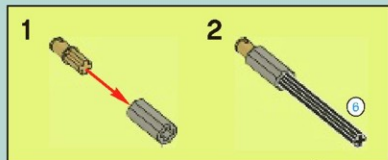

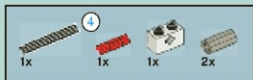

9

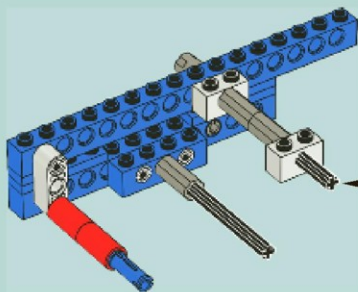
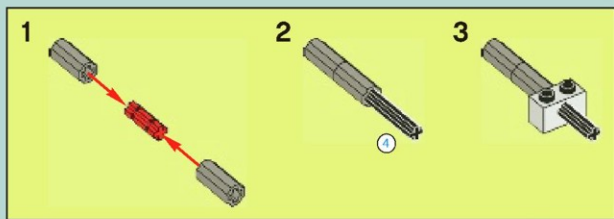

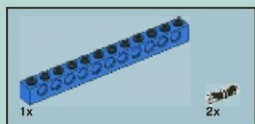

10

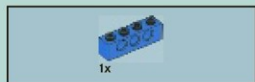
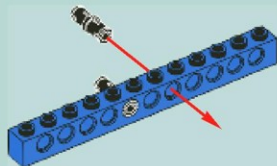

11

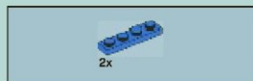

12

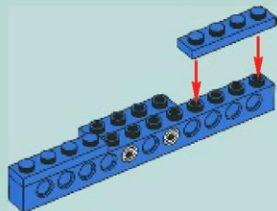

13

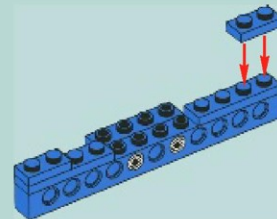

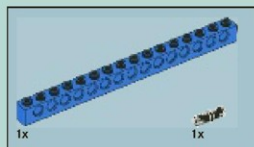

14

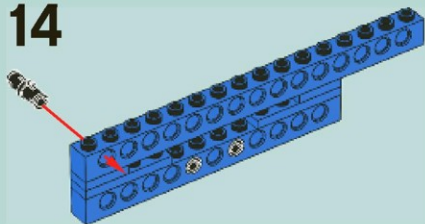

15

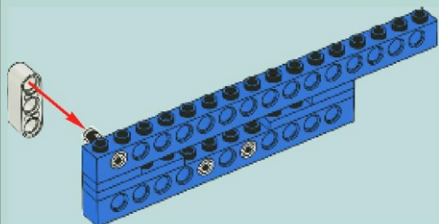

16

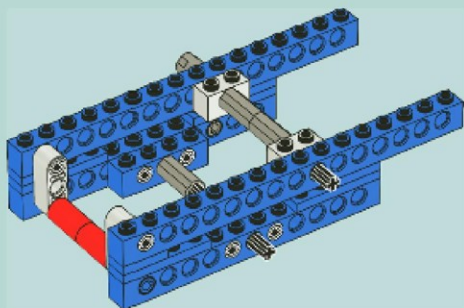

1x



1x



17

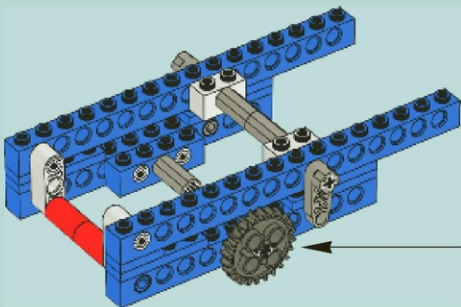
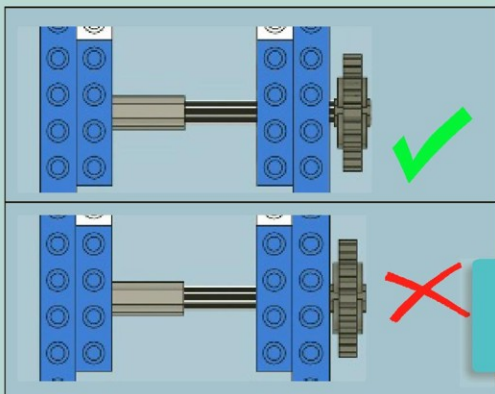

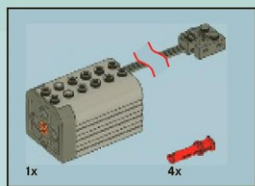

18

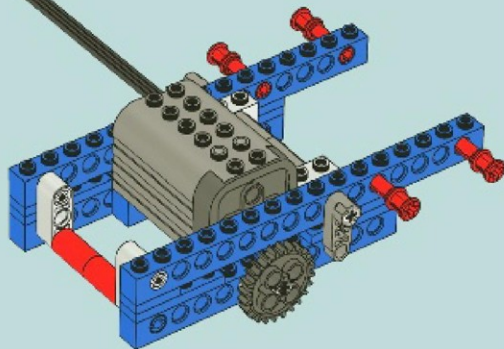



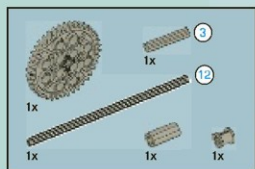

# 19

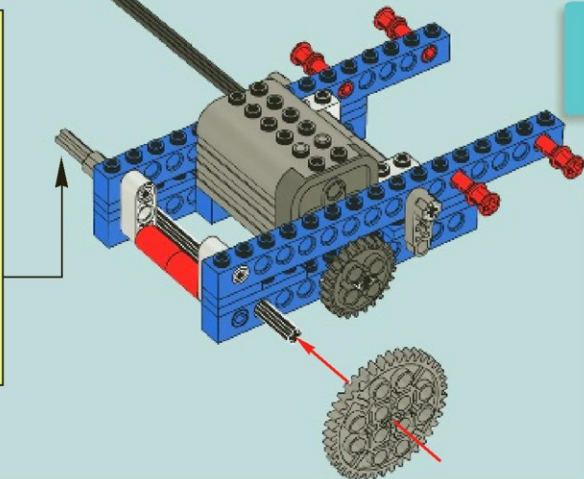
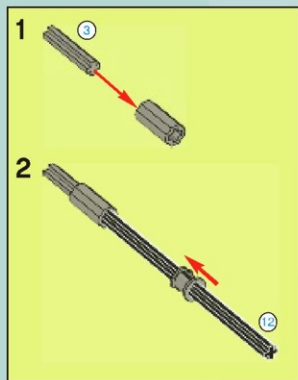

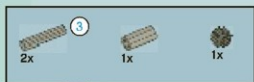

20

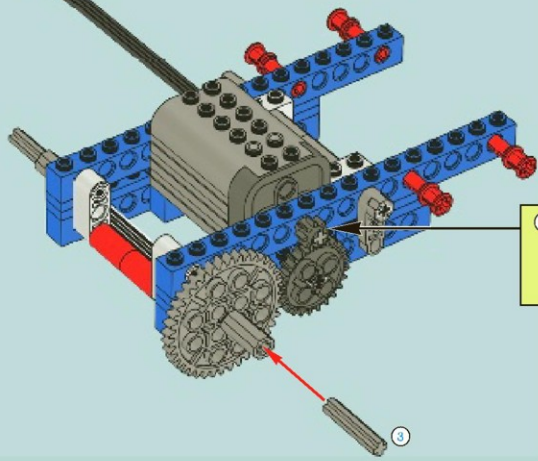

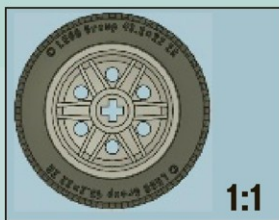
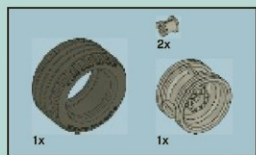

21

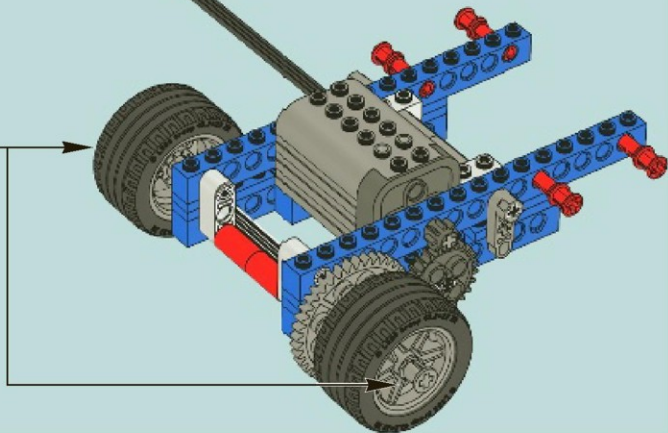

# 22

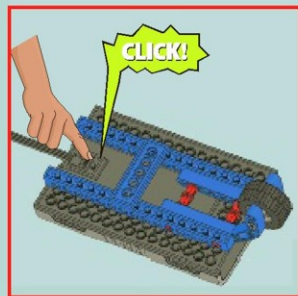
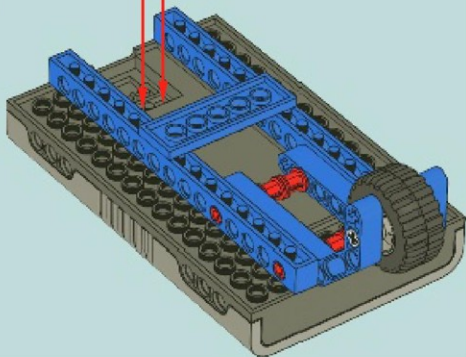
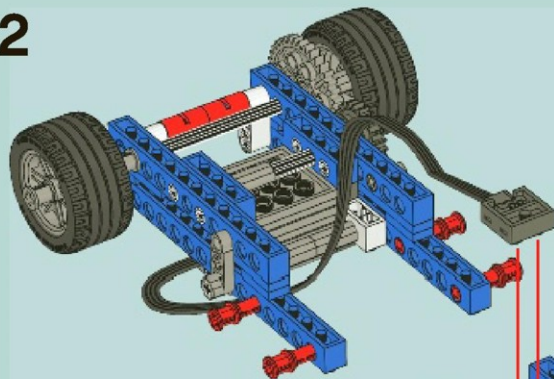

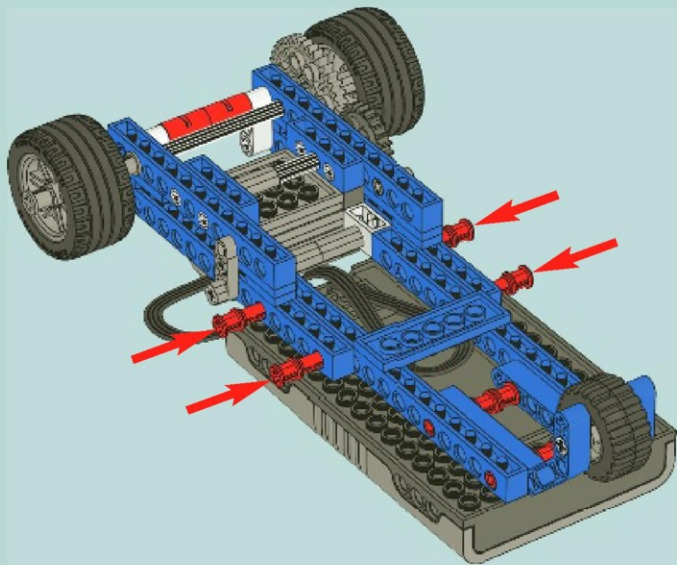

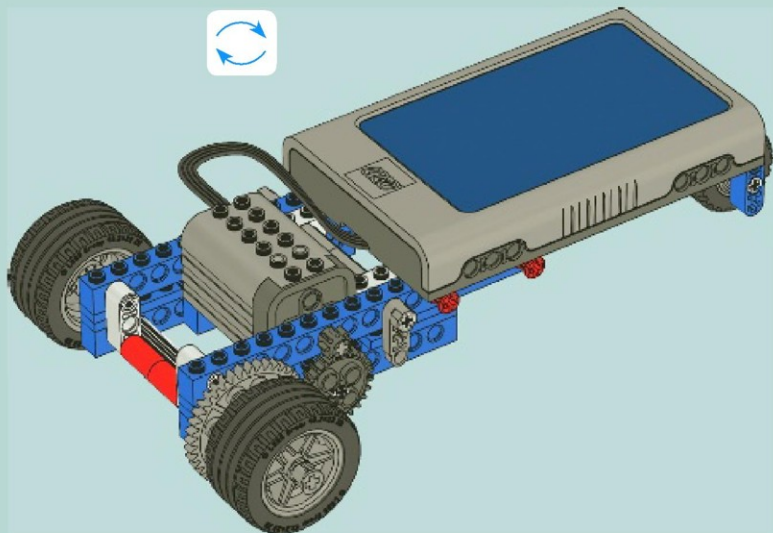

1

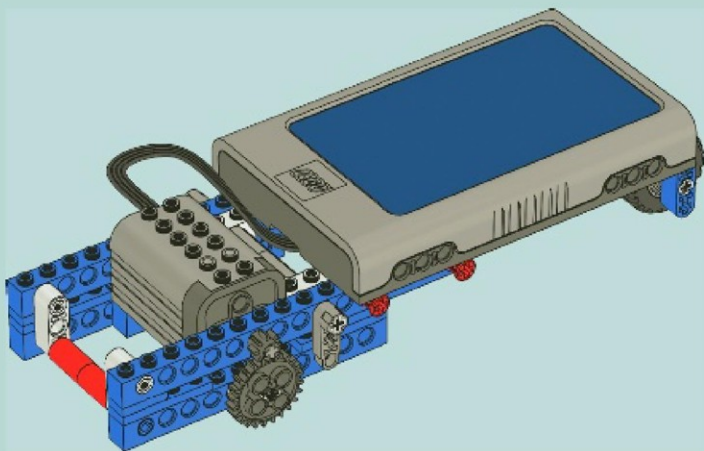

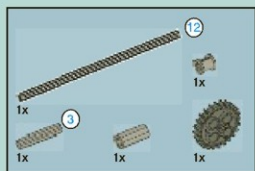

2

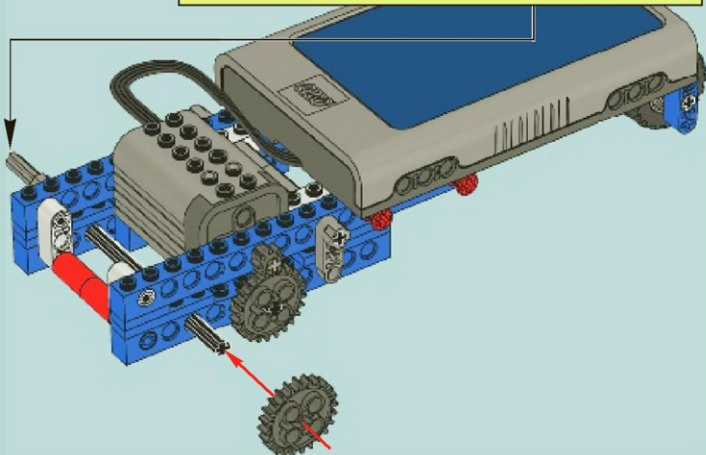
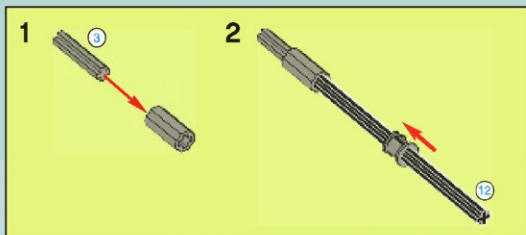



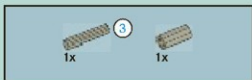

3

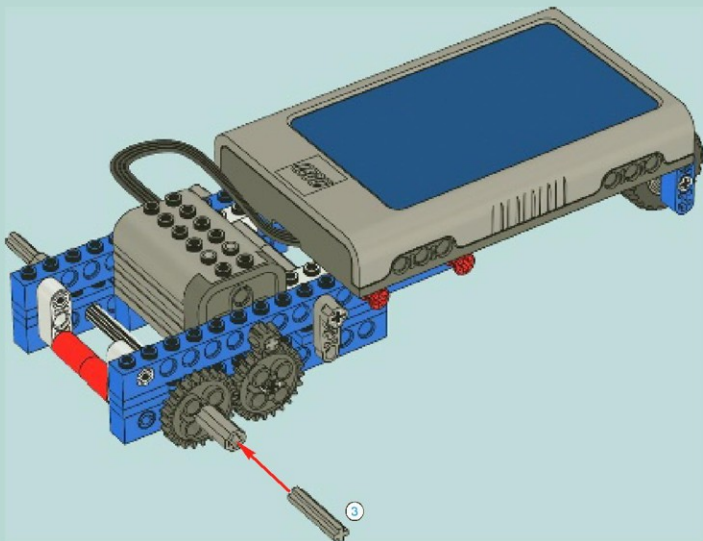

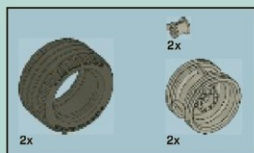

4

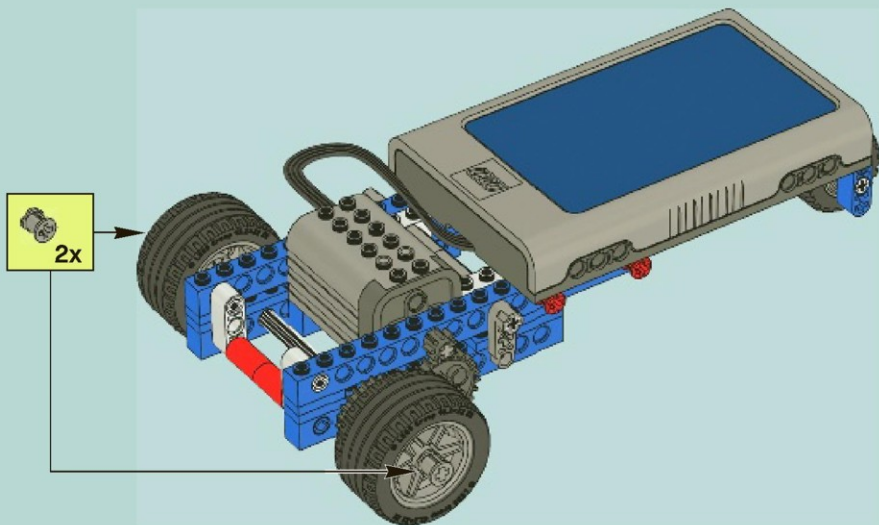

5

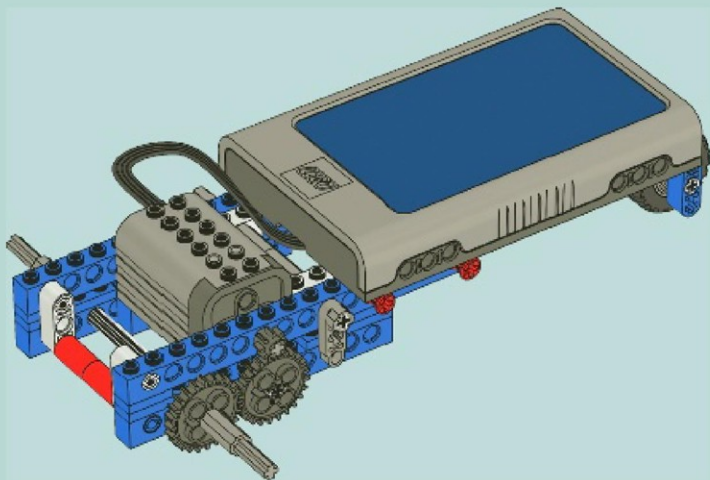



6

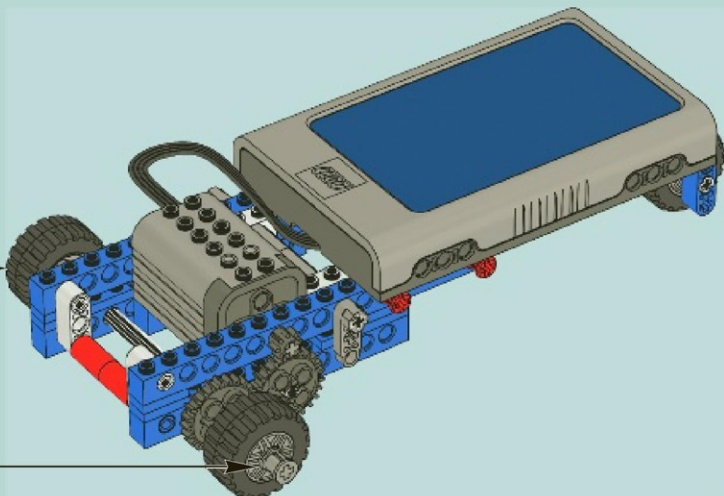

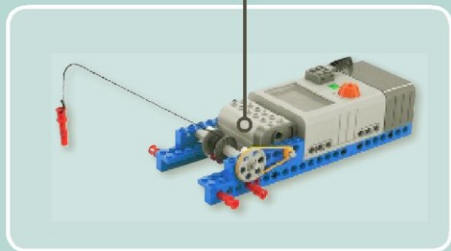
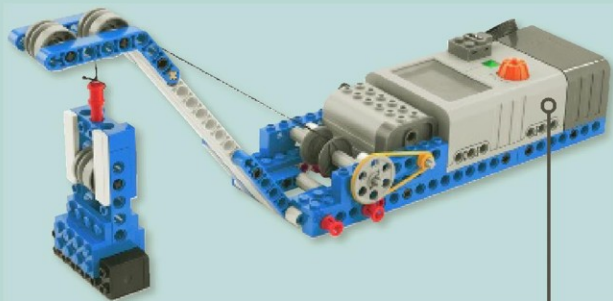

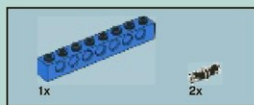

1

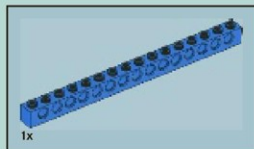
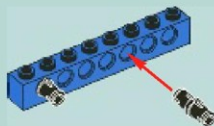

2

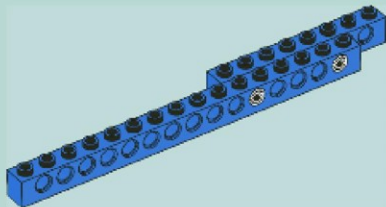

3

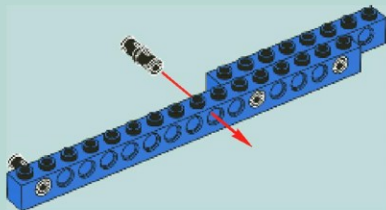

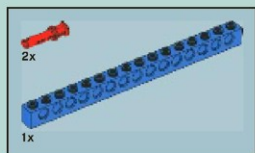

4

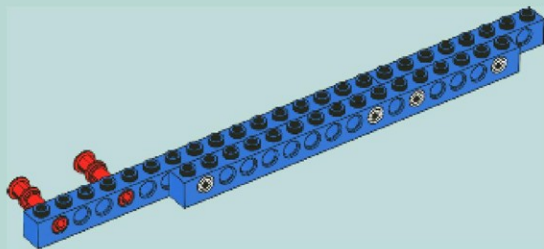

5

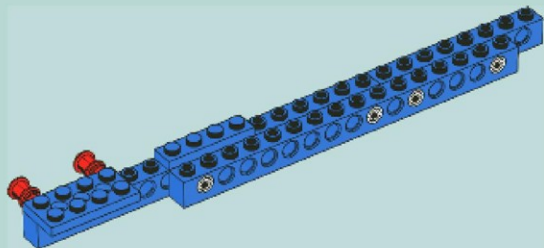



2x

6

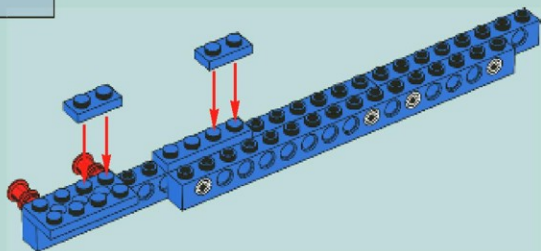

1x



1x

7

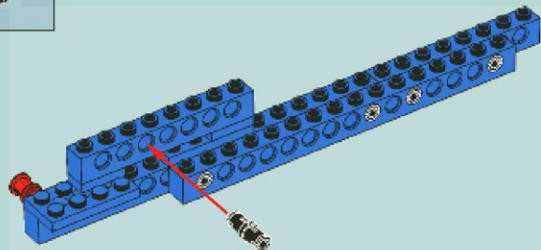



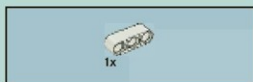

8

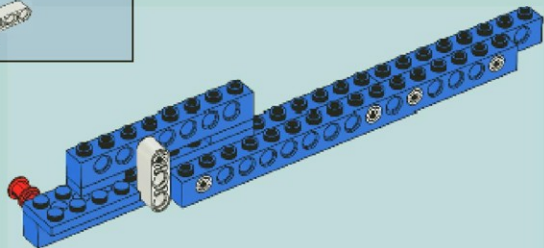

9

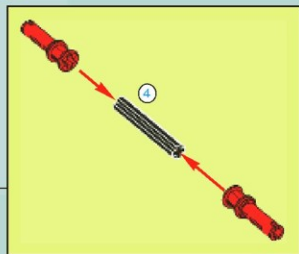
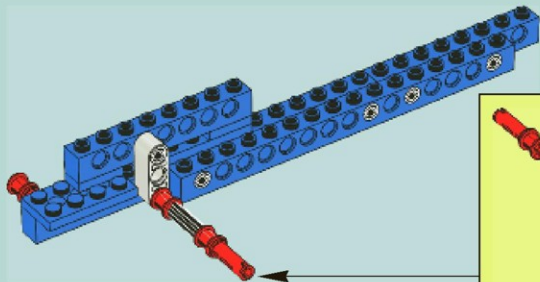

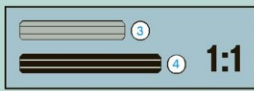
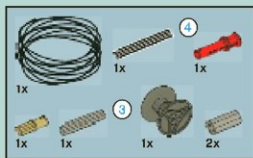

# 10

1



2



3

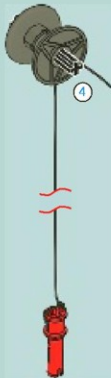

4



5

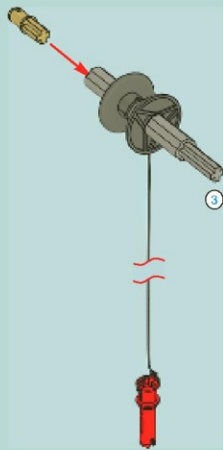

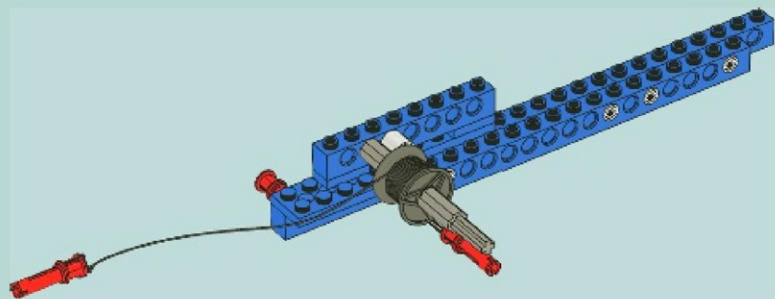

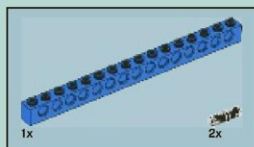

11

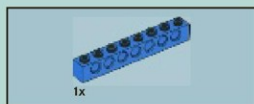

12

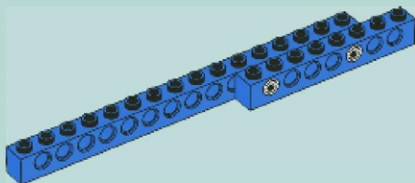



2x

# 13

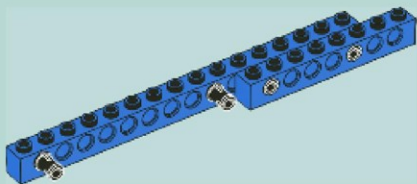

2x



1x

# 14

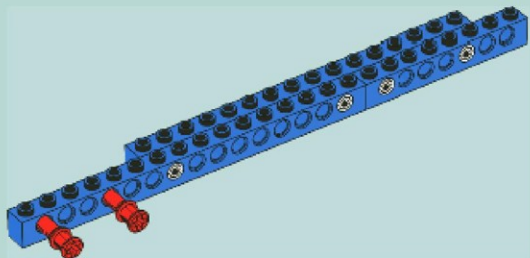



15

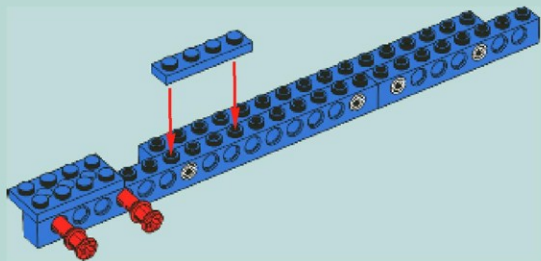

16

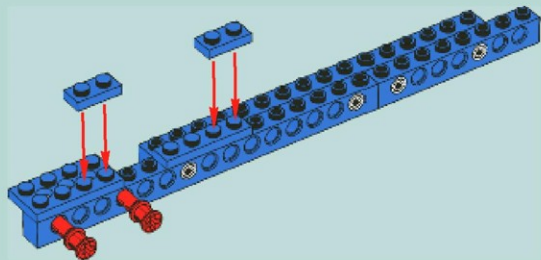

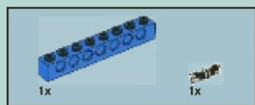

17

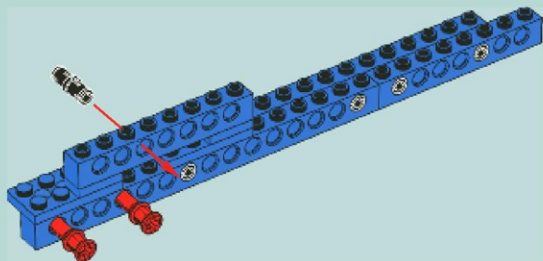

18

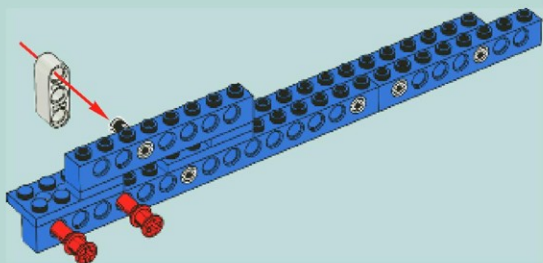

19

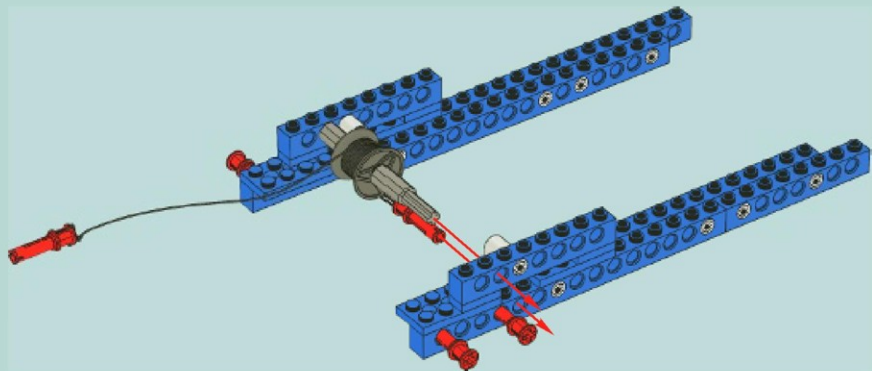



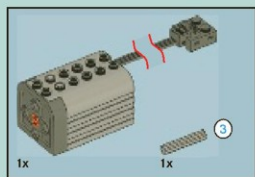

20

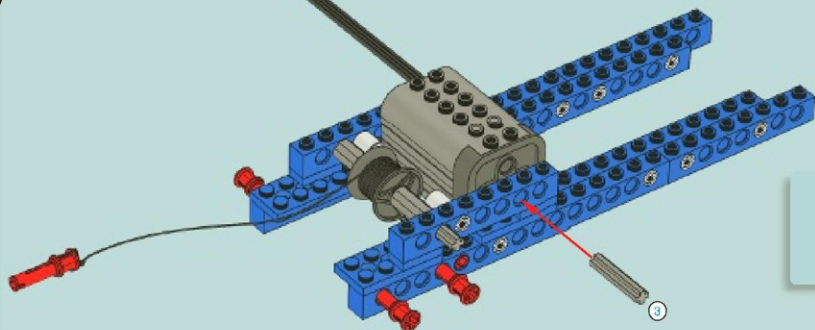



21

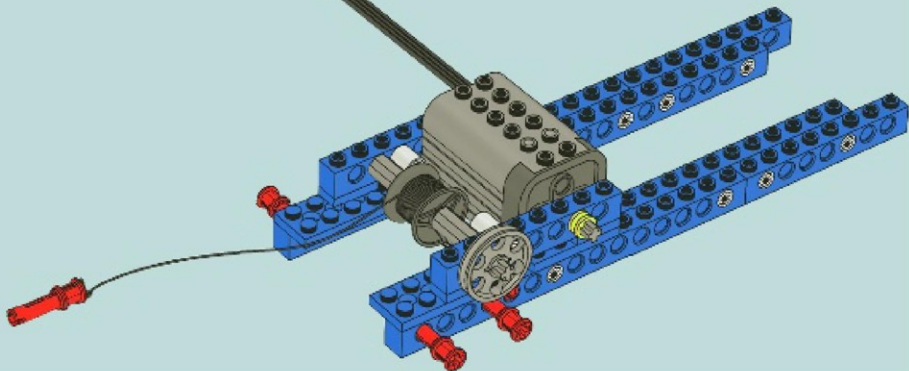

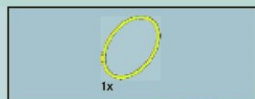

22

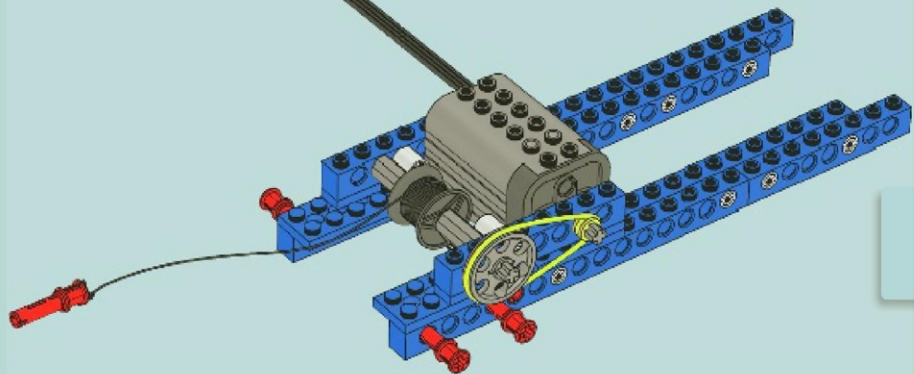

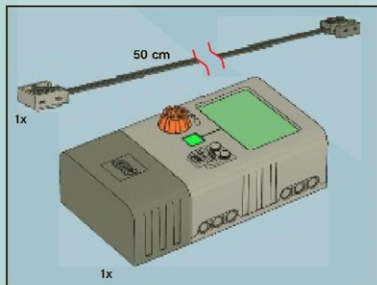

23

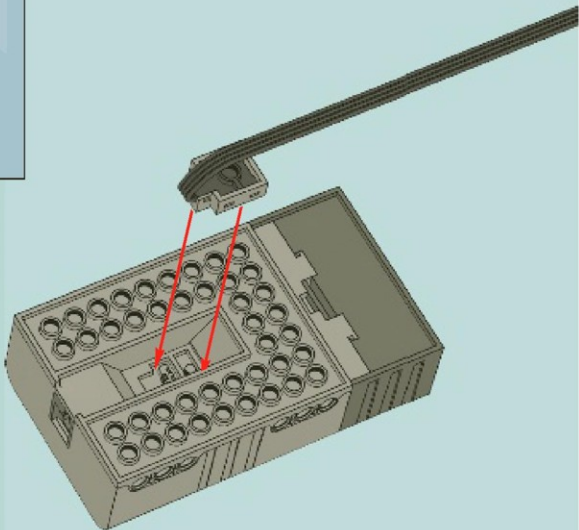

24

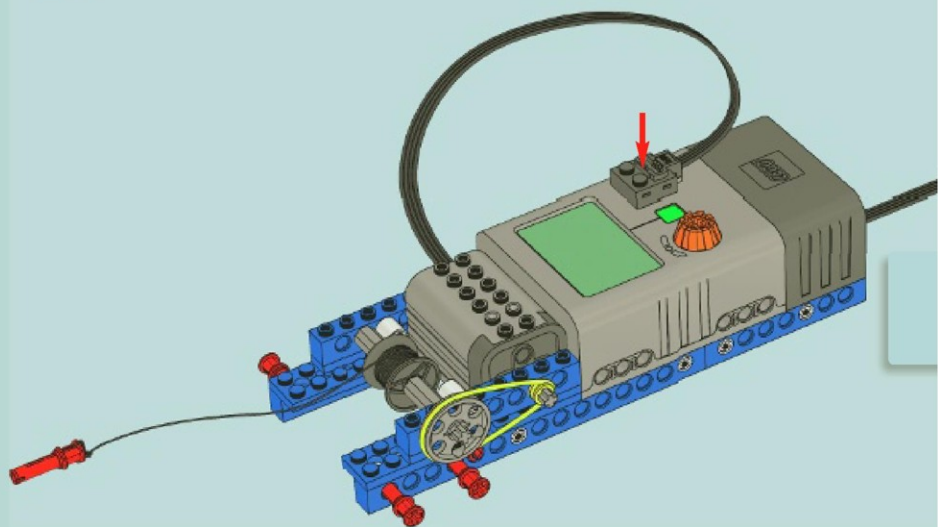

25

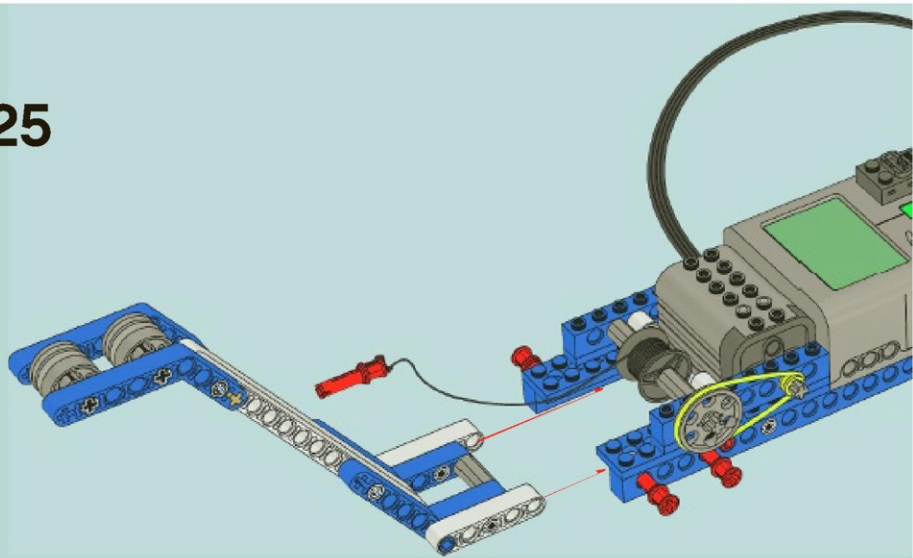

26

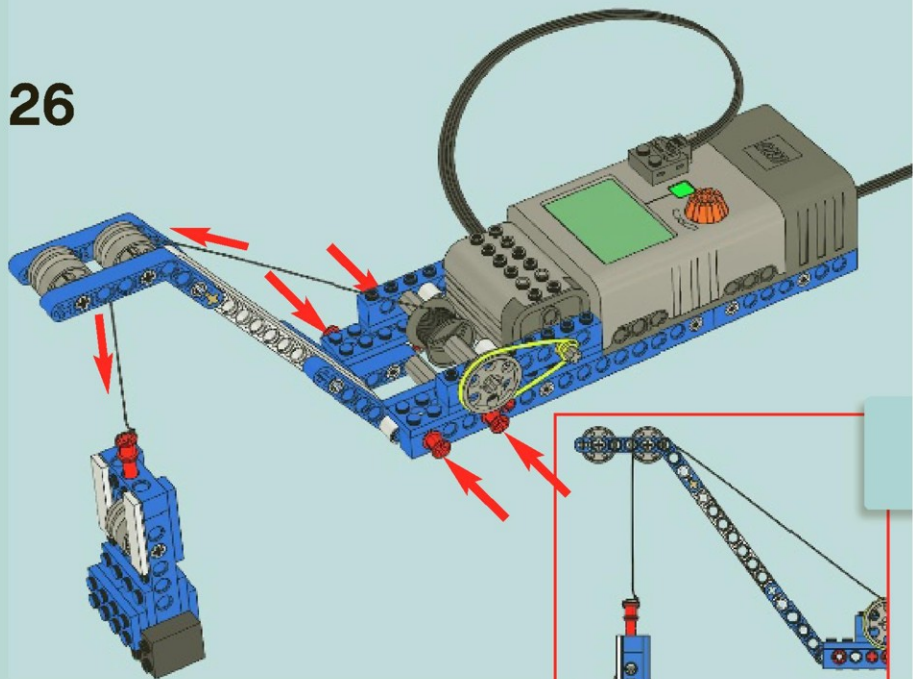

1

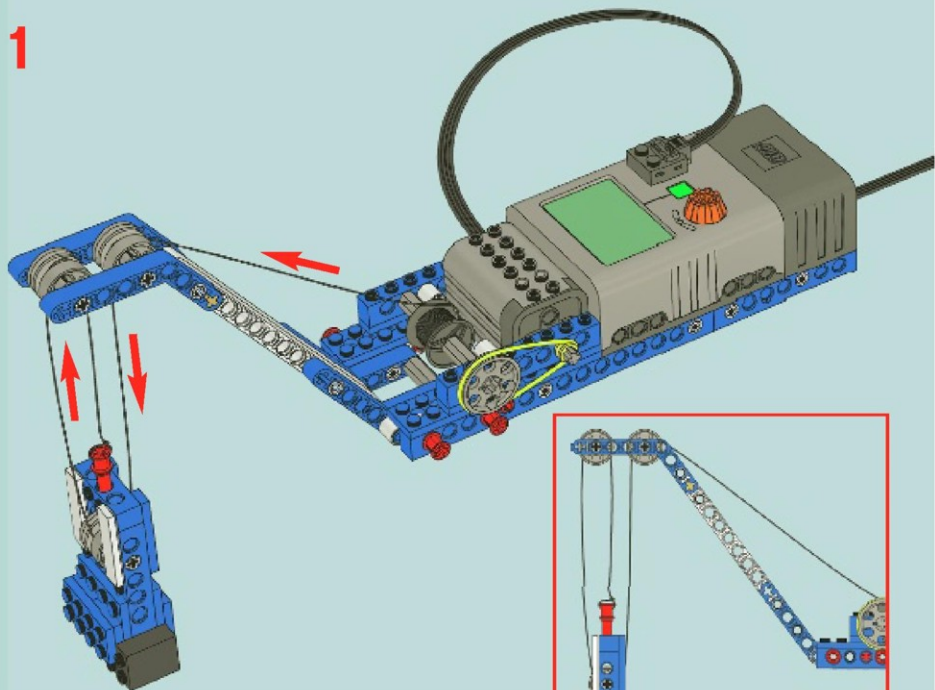

 [LEGOeducation.com](http://LEGOeducation.com)



9688

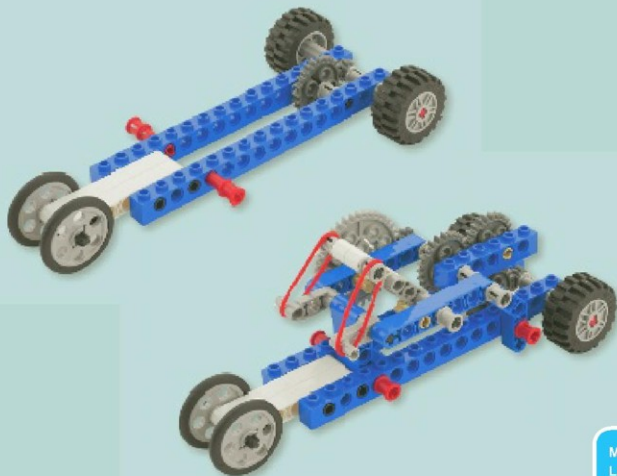

Machines & Mechanisms  
LEGO® MINDSTORMS® Education





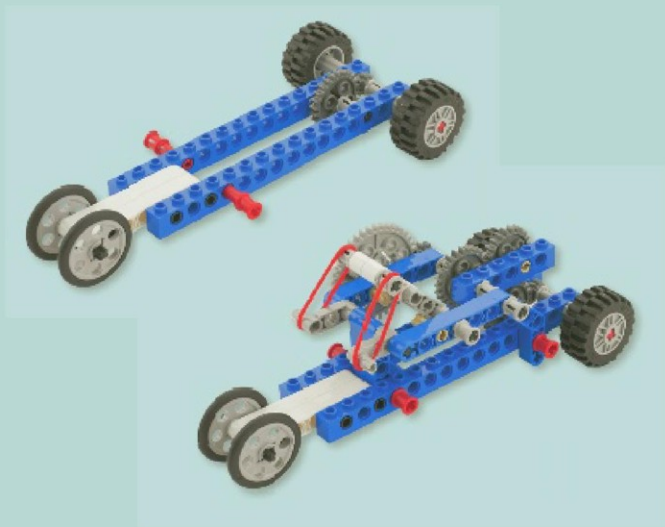

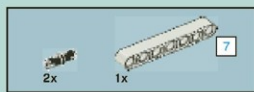

1



2

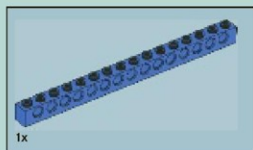
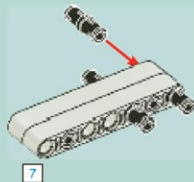

3

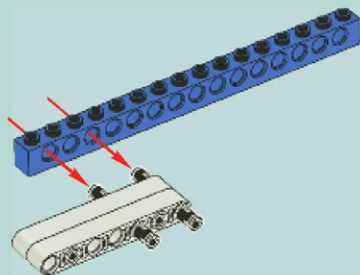

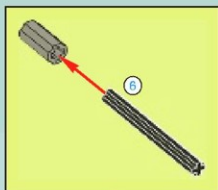
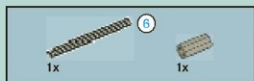

4

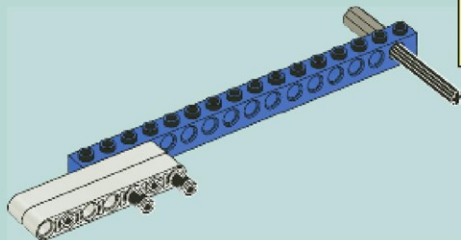

5

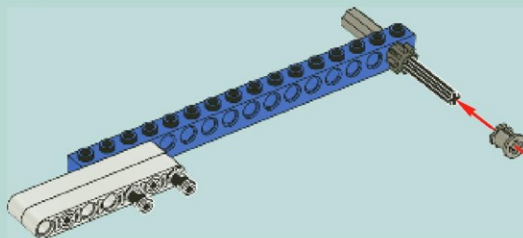

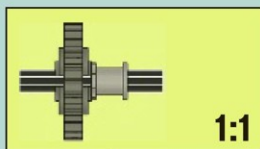

6

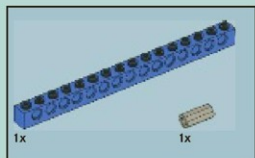
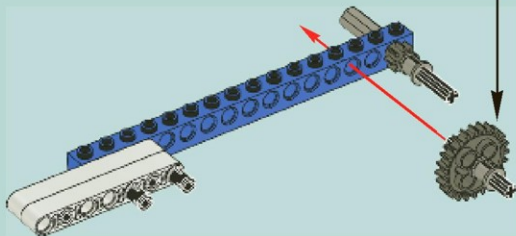

7

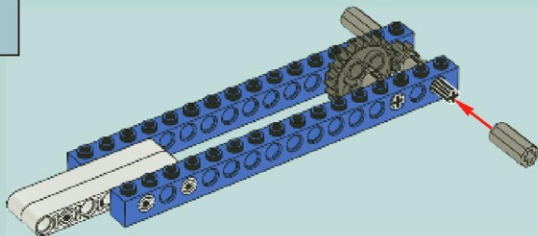

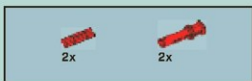

8

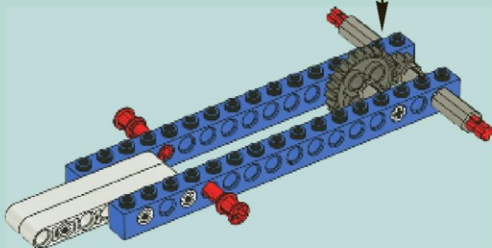
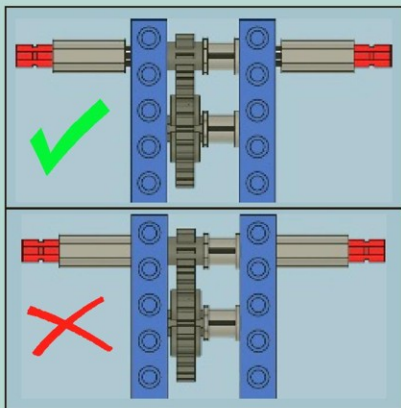

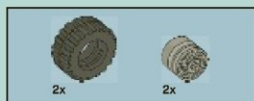

9

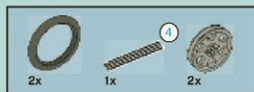
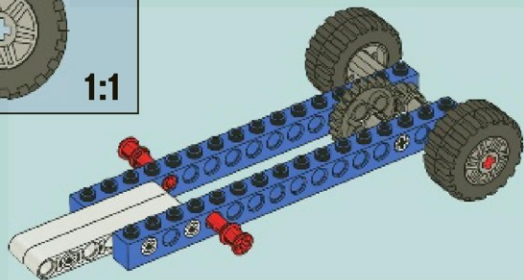

10

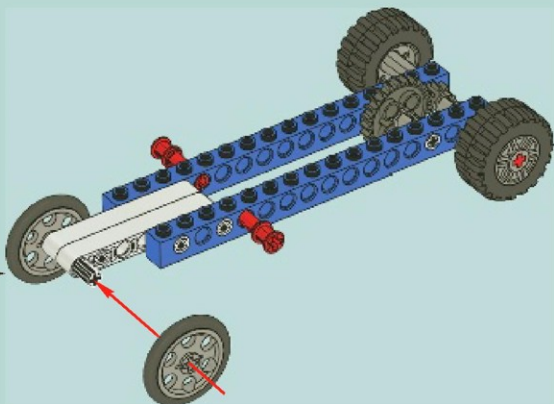



# 11

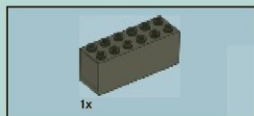
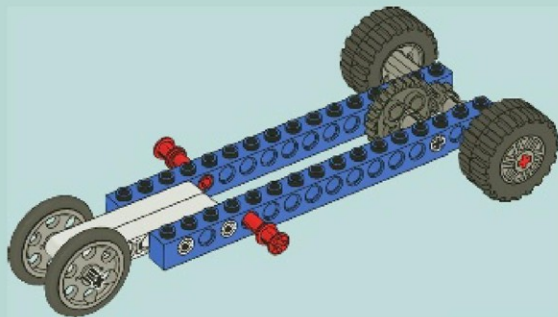

# 12

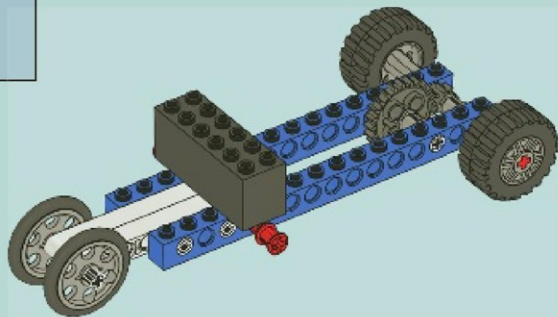

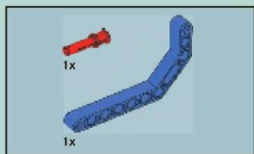

13

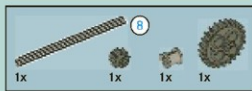
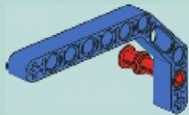

14

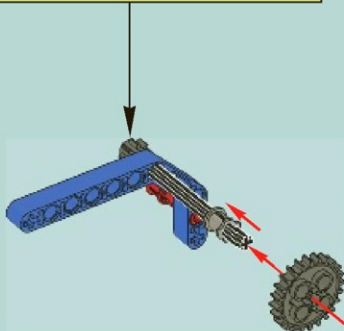

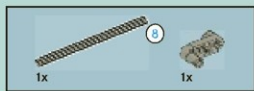

15



16

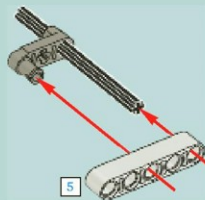

17

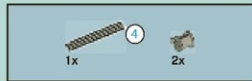
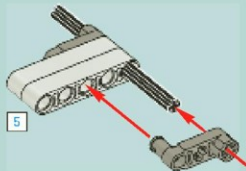

18

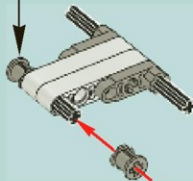

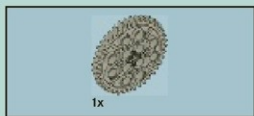

19

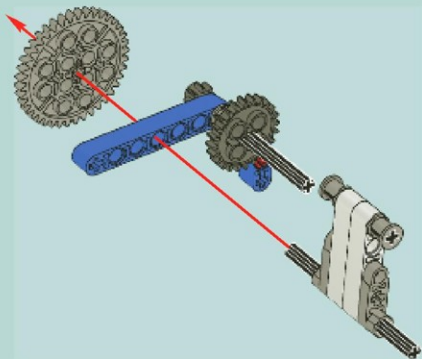

20

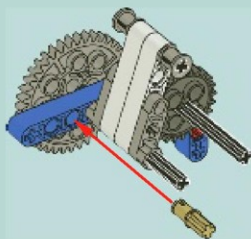

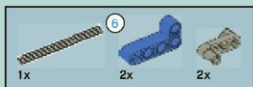

# 21

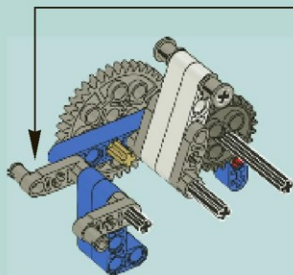
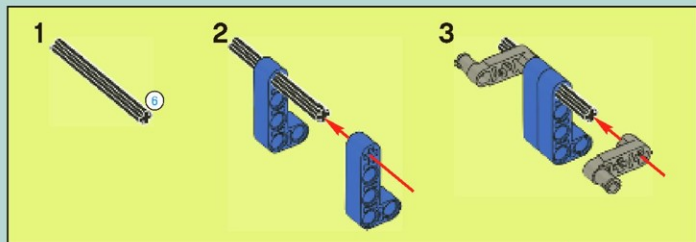

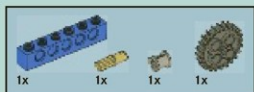

22

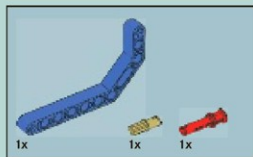

23

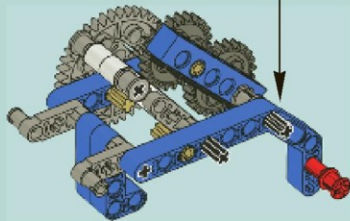
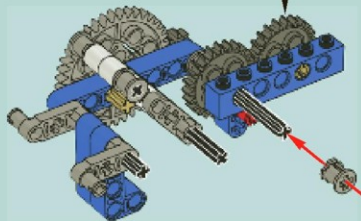
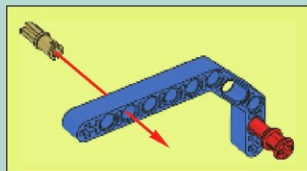
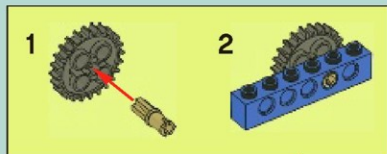



2x

# 24

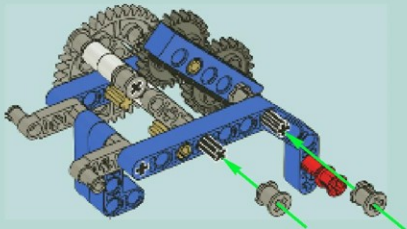

25

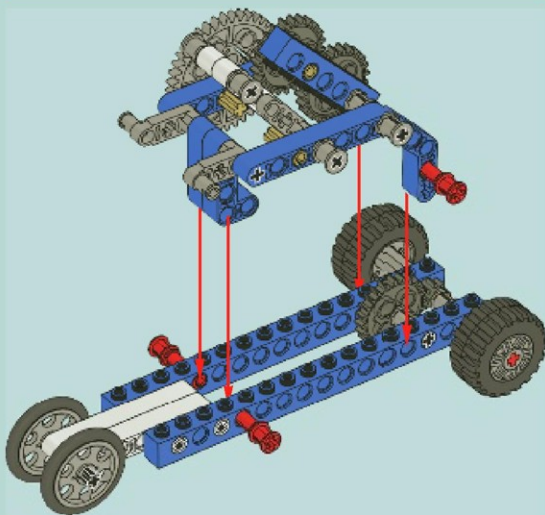
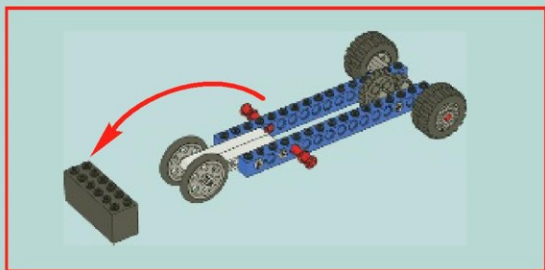



26

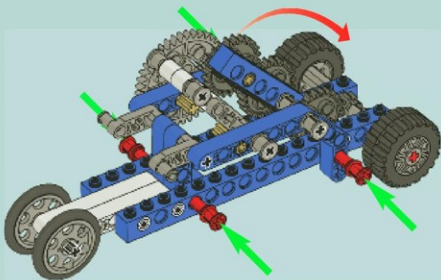



2x

27

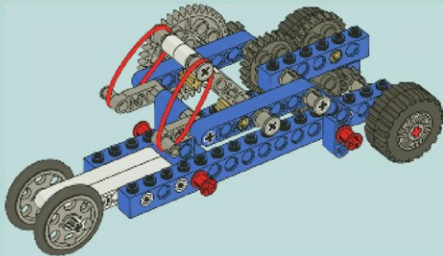

28

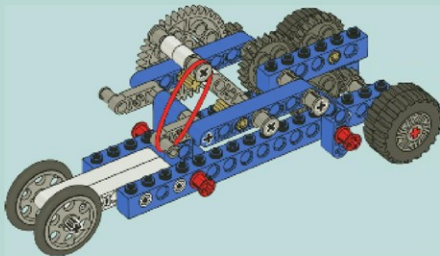
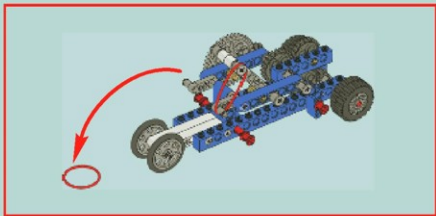







## EN

How to get started

To install the Energy Storage, simply slide it down onto the Energy Display. To remove the Energy Storage, press the plastic tab on the back with your thumb and gently press the Energy Storage down to slide it off.

- Disconnect after use
- Store at room temperature in a clean, dry place away from heat and frost

How to charge and discharge the Energy Meter in order to achieve full capacity on your Energy Storage we recommend that you charge and discharge the Energy Meter three times upon initial use, but also after every 6 months of use or after a long storage period.

To charge the Energy Meter:

- Connect the Energy Meter either to the LEGO Power Functions Battery Box supplied with six new batteries, the LEGO Power Functions Rechargeable Battery Box or the NXT in order to charge the Energy Storage
- Turn on the Energy Meter by pressing the green On/Off button, check that the display is on
- Let the LEGO Power Functions Battery Box, the LEGO Power Functions Rechargeable Battery Box or the NXT charge the Energy Meter by leaving them connected for three hours or until the display turns off

To discharge the Energy Meter:

- Disconnect all wires and other devices from the Energy Meter
- Press the green On/Off button for 10 seconds until a triangle with an exclamation mark appears blinking with one second intervals on the display
- Let the Energy Meter remain like this for approximately 1½ hours or until the display turns off

If you wish to cancel the discharge, simply press the On/Off button to turn off the Energy Meter. To return to normal mode, turn on the Energy Meter again.

For more information see [www.legoeducation.com](http://www.legoeducation.com) or [www.MINDSTORMSeducation.com](http://www.MINDSTORMSeducation.com)

## ESSA

Primeros pasos

Para instalar el Acumulador eléctrico, insértalo en la Pantalla de consumo. Para desconectar el Acumulador eléctrico, presiona la pestaña de plástico situada en la parte posterior con el dedo pulgar y, a continuación, empuja con cuidado el Acumulador eléctrico hacia abajo para extraerlo.

- Desconectar después del uso.
- Conservar a temperatura ambiente en un lugar limpio, seco y alejado de fuentes de calor y congelación.

Cómo cargar y descargar el Medidor de consumo

Para que el Acumulador eléctrico alcance su máxima capacidad, se recomienda cargar y descargar el Medidor de consumo tres veces antes de usarlo por primera vez y cada 6 meses de uso o tras periodos prolongados de almacenamiento.

Para cargar el Medidor de consumo:

- Conecta el Medidor de consumo a la Batería LEGO Power Functions tras instalar en ella seis baterías nuevas, a la Batería recargable LEGO Power Functions o al ladrillo NXT para cargar el Acumulador eléctrico.
- Enciende el Medidor de consumo pulsando el botón verde de encendido/apagado y comprueba si se enciende la pantalla.
- Deja que la Batería LEGO Power Functions, la Batería recargable LEGO Power Functions o el ladrillo NXT carguen el Medidor de consumo manteniéndolos conectados durante tres horas o hasta que la pantalla se apague.

Para descargar el Medidor de consumo:

- Desconecta todos los cables y dispositivos conectados al Medidor de consumo.
- Mantén pulsado el botón verde de encendido/apagado durante 10 segundos hasta que aparezca en la pantalla un símbolo intermitente a intervalos de un segundo, formado por un triángulo con un signo de exclamación en su interior.
- Deja el Medidor de consumo en este estado durante aproximadamente una hora y media o hasta que la pantalla se apague.

Si deseas cancelar la descarga, pulsa el botón de encendido/apagado para apagar el Medidor de consumo. Para volver al modo normal, enciende de nuevo el Medidor de consumo.

Si deseas obtener más información, visita las direcciones [www.legoeducation.com](http://www.legoeducation.com) o [www.MINDSTORMSeducation.com](http://www.MINDSTORMSeducation.com)

## FR

Guide de démarrage

Pour installer la réserve d'énergie, il suffit de la faire glisser sur le socle à énergie. Pour enlever la réserve d'énergie, appuyez avec votre pouce sur l'onglet situé à l'arrière et appuyez doucement sur la réserve d'énergie pour la faire glisser.

- Déconnectez-la après utilisation.
- Stockez-la à température ambiante dans un endroit propre et sec à l'abri de la chaleur.

Charger et décharger le compteur d'énergie

Pour obtenir la pleine capacité de votre réserve d'énergie, nous vous conseillons de charger et décharger trois fois le compteur d'énergie avant sa première utilisation mais également après 6 mois d'utilisation ou après une longue période de stockage.

Pour charger le compteur d'énergie :

- Branchez le compteur d'énergie soit au boîtier à piles LEGO Power Functions fourni avec six piles neuves, soit au boîtier à piles rechargeables LEGO Power Functions ou encore au NXT afin de recharger la réserve d'énergie
- Allumez le compteur d'énergie en appuyant sur le bouton vert Marche/Arrêt et vérifiez que l'écran s'allume
- Laissez le boîtier à piles LEGO Power Functions, le boîtier à piles rechargeables LEGO Power Functions ou le NXT recharger le compteur d'énergie en les laissant branchés pendant trois heures ou jusqu'à ce que l'écran s'éteigne.

Pour décharger le compteur d'énergie :

- Débranchez tous les câbles et autres appareils du compteur d'énergie

- Appuyez sur le bouton vert Marche/Arrêt pendant 10 secondes jusqu'à ce qu'un triangle avec un point d'exclamation, clignotant par intervalle d'une seconde, s'affiche à l'écran.
- Laissez ainsi le compteur d'énergie pendant environ une heure et demie ou jusqu'à ce que l'écran s'éteigne.

Si vous souhaitez interrompre le déchargement, appuyez simplement sur le bouton Marche/Arrêt pour éteindre le compteur d'énergie. Pour retourner au mode normal, rallumez le compteur d'énergie.

Pour plus d'informations, consultez le site Web [www.legoeducation.com](http://www.legoeducation.com) ou [www.MINDSTORMSeducation.com](http://www.MINDSTORMSeducation.com)

## DE

### Erste Schritte

- Um den LEGO Energiespeicher zu verwenden, wird er wie abgebildet auf die Energieanzeige aufgeschoben. Um den LEGO Energiespeicher zu entfernen, muss der kleine Plastikreiter mit dem Daumen gedrückt und der LEGO Energiespeicher nach unten abgezogen werden.
- Nach Gebrauch von der Anzeige abnehmen
- Bei Zimmertemperatur an einem staubfreien, trockenen Ort aufbewahren. Von Wärmequellen und Frost fernhalten.

**Aufladen und Entladen des Energiezählers**  
Um die volle Akkukapazität zu erreichen, sollte der LEGO Energiespeicher dreimal in Folge vollständig aufgeladen und entladen werden. Nach sechs Monaten oder nach längerem Nichtgebrauch sollte man ebenso verfahren.

### Den LEGO Energiezähler aufladen:

- Um den LEGO Energiespeicher aufzuladen, schließen den Energiezähler entweder an die LEGO Power Functions Batteriebox an, in der sich sechs neue Batterien befinden müssen, oder an die LEGO Power Functions Wiederaufladbare Batteriebox oder an den NXT.
- Schalte den Energiezähler ein, indem du den grünen Ein-/Auswahlknopf drückst. Stelle sicher, dass die Anzeige eingeschaltet ist.
- Lasse nun den LEGO Energiezähler drei Stunden lang über die angeschlossene Stromquelle (LEGO Power Functions Batteriebox, LEGO Power Functions Wiederaufladbare Batteriebox oder NXT) aufladen.

### Den LEGO Energiezähler entladen:

- Entferne alle Kabel und Geräte vom Energiezähler

- Drücke 10 Sekunden lang auf den grünen Ein-/Auswahlknopf, bis ein Dreieck mit einem Ausrufezeichen auf der Anzeige erscheint und anfängt, zu blinken.
- Lasse den Energiezähler nun ca. 1½ Stunden entladen, oder solange, bis sich die Anzeige ausschaltet.

Wenn du den Entladevorgang abbrechen willst, drücke einfach auf den Ein-/Auswahlknopf, um den Energiezähler auszuschalten. Um den Energiezähler dann wieder normal verwenden zu können, schalte ihn einfach ein.

Weitere Informationen findest du auf [www.legoeducation.com](http://www.legoeducation.com) und [www.MINDSTORMSeducation.com](http://www.MINDSTORMSeducation.com)

## NL

- Hoe te beginnen
- Schuf de energieopslag eenvoudig ontlag op de energiedisplay om hem te installeren. Om de energiedisplay weer te verwijderen: druk met je duim de plastic lip aan de achterzijde in en duw de energieopslag voorzichtig ontlag.
- Koppel de eenheid na gebruik af
- Bewaar hem bij kamertemperatuur, op een schone, droge plaats, verstrijf en uit de buurt van warmtebronnen

### De energiemeter laden en ontladen

Om optimale werking van de energieopslag te bereiken raden we aan energiemeter vóór gebruik, maar ook na iedere 6 maanden gebruik of na een lange ongebruikte periode, drie keer achter elkaar te laden en weer te ontladen.

### De energiemeter opladen

- Om de energieopslag op te laden moet de energiemeter worden verbonden met de LEGO Power Functions batterijhouder die bij de zes nieuwe batterijen geleverd is, of met de LEGO Power Functions houder voor oplaadbare batterijen, of met de NXT
- Zet de energiemeter aan met de groene Aan/Uit knop. Controleer of de display aan staat
- Laat de energiemeter op door hem drie uur lang - of tot de display vanzelf uitgaat - aangesloten te laten op de LEGO Power Functions batterijhouder, de LEGO Power Functions houder voor oplaadbare batterijen of de NXT

### De energiemeter ontladen

- Maak alle leidingen en andere op de energiemeter aangesloten apparatuur los

- Houd de groene Aan/Uit knop ca. 10 seconden ingedrukt, tot er in de display een driehoekje met een uitroepsteken verschijnt dat knippert met tussenpozen van een seconde
- Laat de energiemeter ongeveer 1½ uur - of tot dat de display uitgaat - zo liggen

Om het ontladproces te onderbreken druk je eenvoudig op de Aan/Uit knop om de energiemeter uit te zetten. Om weer naar 'normaal bedrijf' te gaan, zet je de energiemeter weer aan.

Va voor meer informatie naar [www.legoeducation.com](http://www.legoeducation.com) of [www.MINDSTORMSeducation.com](http://www.MINDSTORMSeducation.com)

## DA

- Sådan kommer du i gang
- Installer Energiakkumulatoren ved at sætte den ned over Energiedisplayet. Fjern Energiakkumulatoren ved at trykke på plastiktappen på bagsiden med din tommelfinger og forsigtigt trykke ned på Energiakkumulatoren for at få den af.
- Frakobl strømmen efter brug.
- Opbevar ved stuetemperatur på et rent og tørt sted beskyttet mod varme og frost.

**Sådan oplades og aflades Energi måleren**  
For at få mest muligt ud af din Energiakkumulator anbefaler vi, at du oplader og aflader Energi måleren tre gange, inden den bruges første gang, samt hvert halve år eller efter en længere opbevaringsperiode.

### Sådan oplades Energi måleren:

- Slut Energi måleren til enten LEGO Power Functions batteriet (med seks nye batterier), det genopladelige LEGO Power Functions batteri eller NXT'en for at oplade Energiakkumulatoren.
- Tænd for Energi måleren ved at trykke på den grønne tænd- og slukknop. Kontrollér, at displayet er tændt.
- Energi måleren oplades ved at lade LEGO Power Functions batteriet, det genopladelige LEGO Power Functions batteri eller NXT'en ystre slukstret i tre timer, eller indtil displayet slukkes.

### Sådan aflades Energi måleren:

- Frakobl alle ledninger og andet udstyr fra Energi måleren.
- Hold den grønne tænd- og slukknop nede i 10 sekunder, til en trekant med et udbrætsgen blinker hvert sekund i displayet.
- Lad Energi måleren stå sådan i ca. 1½ time, eller indtil displayet slukkes.

Hvis du vil standse afladningen, skal du bare trykke på tænd- og slukknappen for at slukke for Energi måleren. Tænd for Energi måleren for at vende tilbage til normal tilstand.

Se yderligere oplysninger på [www.legoeducation.com](http://www.legoeducation.com) eller [www.MINDSTORMSeducation.com](http://www.MINDSTORMSeducation.com).

## SV

### Att komma i gång

För att montera energiladdret låser du det helt enkelt glida ner på energidisplayskärmen underifrån. För att ta bort energiladdret trycker du med tummen på plastfliken på baksidan och trycker sedan försiktigt energiladdret nedåt så det glider av.

• Koppla bort efter användning.

• Förvara energimätaren i rumtemperatur på ett rent och torrt ställe. Undvik hög värme och frost.

Så här laddar och laddar man ur energimätaren. För att energimätaren ska få full kapacitet rekommenderar vi att du laddar och laddar ur energimätaren tre gånger vid första användningstillfället, men också var fjärde månad eller efter en längre tids lagring.

Så här laddar man energimätaren:

- Anslut energimätaren armbågen till LEGO Power Functions batterilåda med sex nya batterier, LEGO Power Functions laddningsbara batterilåda eller NXT för att ladda energiladdret.
- Starta energimätaren genom att trycka på den gröna På/Av-knappen. Kontrollera sedan att displayn tänds.
- Låt LEGO Power Functions batterilåda, LEGO Power Functions laddningsbara batterilåda eller NXT ladda energimätaren genom att låsa dem vara analysera i tre timmar eller tills displayn släcks.

Så här laddar man ur energimätaren:

- Koppla bort alla ledningar och andra enheter från energimätaren.
- Tryck ned den gröna På/Av-knappen i 10 sekunder tills du ser en triangel med ett utropstecken som blinkar en gång i sekunden på displayn.
- Låt energimätaren vara på detta sätt i cirka 1,5 timmar eller tills displayn släcks.

Om du vill avbryta urladdningen trycker du bara på På/Av-knappen för att stänga av energimätaren. För att gå tillbaka till normaltillag, starta energimätaren igen.

För ytterligare information, se [www.legoeducation.com](http://www.legoeducation.com) eller [www.MINDSTORMSeducation.com](http://www.MINDSTORMSeducation.com).

## PTBR

Como iniciar

Para instalar o Armazenamento de Energia, simplesmente deslize-o na Tela Energia. Para remover o Armazenamento de Energia, pressione a aba plástica a traseira com o polegar e pressione gentilmente o Armazenamento de Energia para deslizar-lo para fora.

- Desconectar após o uso
- Armazenar em temperatura ambiente, em local seco e limpo, longe do calor e gelo

Como carregar e descarregar o Medidor de Energia Para obter a máxima capacidade em seu Armazenamento de Energia, recomendamos carregar e descarregar o Medidor de Energia três vezes na primeira vez de uso, mas também a cada 6 meses de uso ou após um longo período de armazenamento.

Para carregar o Medidor de Energia:

- Conecte o Medidor de Energia à Caixa de Bateria de Funções de Energia LEGO, fornecida com seis baterias novas, a Caixa de Baterias Recarregáveis da Função de Energia LEGO ou o NXT para carregar o Armazenamento de Energia.
- Ligue o Medidor de Energia pressionando o botão Ligar/Desligar verde, verifique se o monitor está ligado
- Permita que a Caixa de Bateria de Funções de Energia LEGO, a Caixa de Baterias Recarregáveis da Função de Energia LEGO ou o NXT carregue o Medidor de Energia, deixando-o conectados por três horas ou até a tela apagar

Para descarregar o Medidor de Energia:

- Desconecte todos os fios e demais dispositivos do Medidor de Energia
- Pressione o botão Ligar/Desligar por 10 segundos até um triângulo com um ponto de exclamação aparecer piscando com em intervalos de um segundo na tela
- Deixe o Medidor de Energia assim por aproximadamente uma hora e meia ou até a tela desligar

Para cancelar o descarregamento, basta pressionar o botão Ligar/Desligar para desligar o Medidor de Energia. Para retornar ao modo normal, religue o Medidor de Energia.

Para mais informações, veja [www.legoeducation.com](http://www.legoeducation.com) ou [www.MINDSTORMSeducation.com](http://www.MINDSTORMSeducation.com)

## JA

はじめに

エネルギー貯蔵ユニットは、エネルギーディスプレイの下部にスライドさせて取り付けてください。バッテリー部分を取り外すには、裏側のツメ部分を指で押し、バッテリー部分をゆっくりとスライドさせてください。

- 使用後は、取外してください。
- 高温や低温を避け、清潔な乾燥した場所に室温で保管してください

エネルギーメーターの充電・放電方法

エネルギーメーターを最適な状態で使用いただくために、初回のご使用時には、エネルギーメーターの充電と放電を3回繰り返すことをお勧めします。その後は6ヶ月毎の再充電または長期保管後にも再充電が必要です。

エネルギーメーターの充電方法

- エネルギー貯蔵ユニットを充電するには、エネルギーメーターをレゴパワーファンクションバッテリーボックス後部の新品バッテリー付属レゴパワーファンクション再充電式バッテリーボックスまたはNXTに接続します。
- 緑の電源ボタンを押して、エネルギーメーターの電源を入れます。ディスプレイが表示されていることを確認してください。
- レゴパワーファンクションバッテリーボックス、レゴパワーファンクション再充電式バッテリーまたはNXTを3時間またはディスプレイが表示されなくなるまで接続して、エネルギーメーターを充電します。

エネルギーメーターの放電方法

- エネルギーメーターに接続されているコードやケーブルをすべて外します。
- 緑の電源ボタンを10秒押し続けます。ディスプレイに「1」マークの付いた三角形が表示され、1秒間隔で点滅します。
- エネルギーメーターを約1時間半 [またはディスプレイが表示されなくなるまで] この状態にしておきます。

放電を中断する場合は、電源ボタンを押してエネルギーメーターの電源を切ります。通常の状態で戻すには、エネルギーメーターの電源を入れ直します。

詳細については、[www.legoeducation.com](http://www.legoeducation.com)または[www.MINDSTORMSeducation.com](http://www.MINDSTORMSeducation.com)をご覧ください

## ZHSI

开始操作

- 需要裝備操作，只需將它向下滑動到觸控顯示器上面。要移除觸控器，用手按住後面的塑料片，輕鬆按下觸控器將其滑出。
- 使用过后应断开连接
- 在干净干燥处室温保存。远离热源和冰冻。



#### 如何为能量表充电

为了使能量表发挥最大电量，在首次使用时应对能量表进行三次充放电操作。另外，每六个月或长时间存放后，也应进行此项操作。

#### 为能量表充电：

- 将能量表连接至乐高高动力功能电池盒（随附六节电池）、乐高高动力功能可充电电池盒或 NXT，即可以对能量表进行充电。
- 按绿色的开/关按钮，打开能量表，查看显示器是否打开。
- 保持连接，让乐高高动力功能电池盒、乐高高动力功能可充电电池盒或 NXT 对能量表进行持续充电 3 小时，或直到显示器自动关闭。

#### 为能量表放电：

- 从能量表上断开所有电线和其他设备。
- 按住绿色的开/关按钮 10 秒钟，直到显示屏上出现一个带有汉字的三角形，每秒钟闪烁一次。
- 让能量表保持这个状态的一个半小时，或直到显示器自动关闭。

如果您希望取消放电操作，只需按开/关按钮能量表即可，要返回正常模式，只需再次启动能量表即可。

如需了解更多信息，敬请访问 [www.legoeducation.com](http://www.legoeducation.com) 或 [www.MINDSTORMSeducation.com](http://www.MINDSTORMSeducation.com) 网站。

#### RU

##### С чего начать?

Чтобы установить Накопитель Энергии просто вставьте его в корпус Монитора Энергии. Чтобы удалить Накопитель Энергии, снимите на его тыльной стороне защитный вкладыш. Вытащите накопитель, аккуратно отгибая его вниз.

- Отсоедините после использования
- Храните его при комнатной температуре в чистом и сухом месте, вдали от источников тепла и холода

#### Как зарядить и разрядить Измеритель Энергии

Для того, чтобы Измеритель Энергии работал с максимальной емкостью, рекомендуется перед использованием трижды зарядить и разрядить Измеритель Энергии, и повторять эту процедуру через каждые 6 месяцев использования или после длительного периода хранения.

#### Чтобы зарядить Измеритель Энергии:

- Подключите Измеритель Энергии к батарейному блоку LEGO Power Functions с шестью новыми батарейками, или к отсеку перезаряжаемого аккумулятора LEGO Power Functions или к NXT для того, чтобы зарядить Накопитель Энергии

- Включите Измеритель Энергии, нажав на зеленую кнопку On/OFF (вкл./выкл.), проверьте, чтобы загорелся дисплей
- Зарядка Измерителя Энергии должна производиться при помощи батарейного блока LEGO Power Functions, отсека перезаряжаемого аккумулятора LEGO Power Functions или NXT непрерывно в течение трёх часов или до отключения дисплея

#### Чтобы разрядить Измеритель Энергии:

- Отключите все провода и другие устройства от Измерителя Энергии
- Нажмите на зеленую кнопку On/OFF (вкл./выкл.) в течение 10 секунд до появления надписи «Мощность интервала в одну секунду треугольника с восклицательным знаком»
- Оставьте Измеритель Энергии в этом положении примерно на 1½ часа или до отключения дисплея

Если вы хотите отменить разрядку, просто нажмите на кнопку On/OFF (вкл./выкл.), чтобы отключить Измеритель Энергии. Чтобы вернуться в обычный режим, снова включите Измеритель Энергии.

Если вам нужна дополнительная информация, зайдите на сайт [www.legoeducation.com](http://www.legoeducation.com) или [www.MINDSTORMSeducation.com](http://www.MINDSTORMSeducation.com)

#### NO

##### Komme i gang

Du installerer Energiboksen ved å la den gli på plass i sporene på energidisplayet. Du fjerner Energiboksen ved å trykke med tommelen på plastflisen bakpå, og deretter trykke Energiboksen forsiktig ned for å tigrere den.

- Skal kobles fra etter bruk
- Skal oppbevares i romtemperatur på et rent og tørt sted. Skal ikke utsettes for varmekilder eller kulde

#### Slik lader og utlader du Energiboksen

For å oppnå full kapasitet på LEGO Energiboksen anbefaler vi at du lader og utlader den tre ganger før bruk, men også etter hver 6. måned eller etter en lang oppbevaringsperiode.

#### Slik lader du Energiboksen:

- Koble Energiboka enten til LEGO Power Functions-batteriboksen som leveres med seks nye batterier, LEGO Power Functions' oppladbare batteriboks eller NXT-en for å lade Energiboksen.

- Slå på Energiboksen ved å trykke på På/Av-knappen, og kontroller at displayet er på
- Bruk LEGO Power Functions-batteriboksen, LEGO Power Functions' oppladbare batteriboks eller NXT-en til å lade opp Energiboksen ved å la de være tilkoblet i tre timer, eller helt å displayet slås av

#### Slik utlader du Energiboksen:

- Koble alle ledninger og andre enheter fra Energiboksen
- Trykk på den grønne På/Av-knappen i 10 sekunder til den er trolket med et utropsteget blinker med ett sekunds intervaller på displayet
- La Energiboksen forbli i denne tilstanden i omtrent 1½ time, eller helt til displayet slås av

Hvis du vil avbryte utladingen trykker du bare på På/Av-knappen for å slå av Energiboksen. For å gå tilbake til normal modus, slår du bare Energiboksen på igjen.

Se [www.legoeducation.com](http://www.legoeducation.com) eller [www.MINDSTORMSeducation.com](http://www.MINDSTORMSeducation.com) for mer informasjon



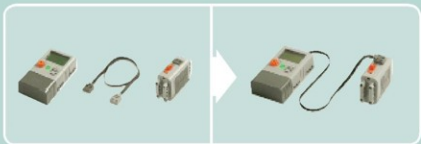

#### EN

Charging the Energy Meter using the Power Function battery box.

You need to use the Power Functions Extension Wire 20" to connect the LEGO® Energy Meter with the Power Functions Battery Box.

#### ESSA

Carga del Medidor de consumo a través de la Batería Power Functions.

Necesitarías usar el Cable prolongador Power Functions de 20" para conectar el Medidor de consumo LEGO® a la Batería Power Functions.

#### FR

Chargement du compteur d'énergie avec le boîtier à piles Power Functions :

Vous devez utiliser le câble d'extension 20" Power Functions pour brancher le compteur d'énergie LEGO® au boîtier à piles Power Functions.

#### DE

Aufladen des Energiemessers mithilfe der Power Functions Batteriebox.

Um den LEGO® Energiemesser mit der Power Functions Batteriebox zu verbinden, wird das Power Functions Verlängerungskabel (50 cm) benötigt.

#### NL

Opladen van de energiemeter met de Power Functions batterijhouder.

Gebruik het Power functions 20" verlengsnoer om de LEGO® energiemeter te verbinden met de Power functions batterijhouder.

#### DA

Opladning af Energiemåleren ved hjælp af Power Functions batteriet.

Du skal bruge en Power Functions forlængerledning (50 cm) til at slutte LEGO® Energiemåleren til Power Functions batteriet.

#### SV

Ladda Energiområdet med Power Functions batterilåda:

Du behöver en Power Functions förlängningskabel på 50 cm för att ansluta din LEGO® Energiområde till Power Functions batterilåda.

#### PTBR

Como carregar o Medidor de Energia usando a Caixa de Bateria de Função de Energia:

Você precisa usar o Fio de Extensão das Funções de Energia de 20 polegadas para conectar o Medidor de Energia LEGO® à Caixa de Bateria de Funções de Energia.

#### JA

バッテリーボックスを使って、レゴエネルギーメーターを充電する:

レゴエネルギーメーターをバッテリーボックスと接続するには、モーター用ケーブル 20インチが必要です。

#### ZHSI

使用动力功能电池盒给“能量表”充电:

必须使用 20 英寸的动力功能延长线将乐高能量表与动力功能电池盒连接起来。

#### RU

Зарядка Измерителя энергии с помощью батарейного блока

Для соединения Измерителя энергии и батарейного блока Power Functions Блок вам потребуется провод Power Functions Extension Wire 20".

#### NO

Slik lader du Energiområdet ved bruk av Power Functions-batteriboksen:

Du må bruke den 20" skjeteledningen til Power Functions Por å koble LEGO® Energiområde med Power Functions-batteriboksen.



**EN**  
**Charging the Energy Meter using the LEGO® MINDSTORMS® NXT:**

You need to use two different converter cables to connect the LEGO Energy Meter with the LEGO MINDSTORMS NXT, Port A.

When charging the LEGO Energy Meter through the LEGO MINDSTORMS NXT remember to connect a LEGO transformer to the LEGO MINDSTORMS NXT.

Build the following program within the LEGO MINDSTORMS NXT Software.

- The first block is a Move block configured for motor A, Duration set to unlimited and power set to 100.
- The second block is a Loop block configured to run forever.
- Within the loop block a Keep Alive block is inserted to make sure the MINDSTORMS NXT to not power down.

Then download and run the program.

**ESSA**  
**Carga del Medidor de consumo a través de LEGO® MINDSTORMS® NXT:**

Necesitarás usar dos cables convertidores diferentes para conectar el Medidor de consumo LEGO al puerto A de LEGO MINDSTORMS NXT.

Recuerda conectar un transformador LEGO a LEGO MINDSTORMS NXT durante la carga del Medidor de consumo LEGO a través de dicho dispositivo.

Construye el siguiente programa con el software de LEGO MINDSTORMS NXT.

- El primer bloque es un bloque Mover configurado para el motor A, de duración ilimitada y potencia establecida a 100.
- El segundo bloque es un bloque Bucle configurado para ejecutarse continuamente.
- Debes colocar también un bloque Mantener dentro del bloque bucle para asegurarte de que MINDSTORMS NXT no se apague.

A continuación, descarga y ejecuta el programa.

**FR**  
**Chargement du compteur d'énergie avec LEGO® MINDSTORMS® NXT :**

Vous devez utiliser deux câbles convertisseurs différents pour brancher le compteur d'énergie LEGO au port A du LEGO MINDSTORMS NXT.

Lorsque vous chargez le compteur d'énergie LEGO avec LEGO MINDSTORMS NXT, n'oubliez pas de brancher un transformateur LEGO au LEGO MINDSTORMS NXT.

Construisez le programme suivant dans le logiciel LEGO MINDSTORMS NXT.

- Le premier bloc est un bloc Déplacer configuré pour le moteur A, avec une durée illimitée et une alimentation de 100.
- Le second bloc est un bloc Boucle configuré pour fonctionner en continu.
- Dans le bloc Boucle, un bloc Rémantent est inséré pour s'assurer que MINDSTORMS NXT ne s'éteindra pas.

Téléchargez ensuite et exécutez le programme.

**DE**  
**Aufladen des Energiemessers mithilfe des LEGO® MINDSTORMS® NXT:**

Um den LEGO Energiemessers mit Port A des LEGO MINDSTORMS NXT zu verbinden, werden zwei verschiedene Adapterkabel benötigt.

Wenn der LEGO Energiemessers mithilfe des LEGO MINDSTORMS NXT aufgeladen wird, muss ein LEGO Transformator mit dem LEGO MINDSTORMS NXT verbunden werden.

Erstelle mithilfe der LEGO MINDSTORMS NXT Software folgendes Programm:

- Der erste Block ist ein Bewegungs-Block, der für Motor A konfiguriert wird. Stelle die Dauer auf unbegrenzt und das Energieniveau auf 100 ein.
- Der zweite Block ist ein Schleifen-Block in einer Endlosschleife.
- In den Schleifen-Block füge du einen Lebenserhaltungs-Block ein, um sicherzustellen, dass der MINDSTORMS NXT sein Energieniveau hält.

Lade dann das Programm herunter und starte es.





**NL**  
Opladen van de energiemeter met de LEGO® MINDSTORMS® NXT:

Je hebt twee verschillende converteerkabels nodig om de LEGO energiemeter met de A-poort van je LEGO MINDSTORMS NXT te verbinden.

Når je de LEGO energiemeter oplaat via je LEGO MINDSTORMS NXT, vergeet dan niet om ook een LEGO transformator op je LEGO MINDSTORMS NXT aan te sluiten.

Maak het volgende programma in de software van je LEGO MINDSTORMS NXT.

- Het eerste blok is een Verplaats blok dat is geconfigureerd voor motor A, met de tijdsduur ingesteld op 'onbepakt' en het vermogen ingesteld op 100.
- Het tweede blok is een Herhaling blok, geconfigureerd om oneindig door te blijven gaan.
- Binnen dit Herhaling blok wordt een Waak blok geplaatst dat ervoor zorgt dat de MINDSTORMS NXT niet uitgeschakeld kan worden.

Download dan het programma en start het.

**DA**  
Opladning af Energimåleren ved hjælp af LEGO® MINDSTORMS® NXT:

Du skal bruge to forskellige konverterkabler til at slutte LEGO Energimåleren til port A på LEGO MINDSTORMS NXT.

Når LEGO Energimåleren oplades ved hjælp af LEGO MINDSTORMS NXT, skal du huske at slutte en LEGO transformator til LEGO MINDSTORMS NXT.

Byg følgende program i LEGO MINDSTORMS NXT softwaren.

- Det første ikon er et Kør-ikon konfigureret til Motor A. Varighed er indstillet til ubegrænset, og strømm er indstillet til 100.
- Det andet ikon er et Løkke-ikon, der er konfigureret til at køre uden stop.
- I Løkke-ikonet indsættes et Hold i gang-ikon for at være sikker på, at MINDSTORMS NXT ikke slukkes.

Derefter downloades og køres programmet.

**SV**  
Ladda Energimätaren med LEGO® MINDSTORMS® NXT:

Du behöver två olika konverteringskablar för att ansluta din LEGO Energimätare till Port A på LEGO MINDSTORMS NXT.

Kom ihåg att ansluta en LEGO transformator till LEGO MINDSTORMS NXT när du laddar din Energimätare på det här sättet.

Bygg följande program i LEGO MINDSTORMS NXT programvara.

- Den första ikonen ska vara en Kör-ikon som ska konfigureras för motor A. "Varaktighet" ska ställas in på "unlimited" och "styrka" på "100".
- Den andra ikonen ska vara en Loop-ikon som ska konfigureras för att upprepas oavbrutet.
- I loop-ikonen ska en Hålligång-ikon infogas för att se till att MINDSTORMS NXT inte stängs av.

Ladda sedan ner och kör programmet.

**PTBR**  
Como carregar o Medidor de Energia usando o LEGO® MINDSTORMS® NXT:

Você precisa usar dois cabos conversores diferentes para conectar o Medidor de Energia LEGO ao LEGO MINDSTORMS NXT, porta A.

Ao carregar o Medidor de Energia LEGO através do LEGO MINDSTORMS NXT, lembre-se de conectar um transformador LEGO ao LEGO MINDSTORMS NXT.

Crie o seguinte programa a partir do software do LEGO MINDSTORMS NXT.

- O primeiro bloco é um bloco de Movimento configurado para o motor A, duração definida como ilimitada e potência definida em 100.

- O segundo bloco é um bloco de ciclo configurado para ser executado indefinidamente.
- Dentro do bloco de ciclo, um bloco Manter Ligado é inserido para garantir que o MINDSTORMS NXT não desligue.

Depois, baixe e execute o programa.

#### JA

教育用レゴ®マインドストームNXTを使って、レゴエネルギーメーターを充電する:

レゴエネルギーメーターを教育用レゴ®マインドストームNXTのポートAと接続するには、2種類の交換ケーブルが必要です。

教育用レゴ®マインドストームNXTを使ってレゴエネルギーメーターを充電する際には、レゴ社の充電アダプターをNXT本体に接続してください。

教育用NXTソフトウェアに含まれている以下のプログラムを編み立ててください。

- 最初のブロックは「移動」ブロックで、ポートを「A」、接続時間を「無限」、パワーを「100」に設定します。
- 2番目のブロックは、「ループ」ブロックで、コントロールを「永久」に設定します。
- 「ループ」ブロックの中は、NXT本体の電力が落ちないように「キーアライブ」ブロックを挿入します。

次にプログラムをダウンロードして、実行してください。

#### ZHSI

使用 LEGO®MINDSTORMS®NXT 鉛筆量表充電:

必須使用两根不同的特殊线缆将乐高能量表与 LEGO MINDSTORMS NXT 的端口 A 连接起来。

通过 LEGO MINDSTORMS NXT 给乐高能量表充电时, 请记住给 LEGO MINDSTORMS NXT 连接一个乐高变压器。

在 LEGO MINDSTORMS NXT 软件中创建下列程序。

- 第一个模块是电机 A 配置的移动模块。
- “持续时间”设置为无限制, 功率设置为 100。
- 第二个模块是循环模块, 配置为永久运行。
- 在循环模块内插入保持活动模块, 确保 MINDSTORMS NXT 不会断电。

然后下载并运行该程序。

#### RU

Зарядка Измерителя энергии с помощью микрокомпьютера LEGO NXT:

Для соединения Измерителя энергии с портом A LEGO NXT вам потребуется два различных кабеля-конвертера.

Чтобы зарядить Измеритель энергии, микрокомпьютеру LEGO NXT необходим LEGO трансформатор!

В среде программирования LEGO® MINDSTORMS® NXT составьте следующую программу.

- Первый Блок – Блок Движение, настроенный на порт A, неограниченную длительность работы и уровень мощности 100.
- Второй Блок – Блок Цикл, настроенный работать бесконечно.

Блок Цикл вместе с Блоком Не спать гарантируют, что микрокомпьютер LEGO NXT не перейдет в режим экономии энергии. Затем загрузите и запустите программу.

#### NO

Slik lader du Energimåler ved bruk av LEGO® MINDSTORMS® NXT:

Du må bruke to ulike omPorker kabler. For å koble LEGO Energimåler med LEGO MINDSTORMS NXT, i port A.

Når du lader LEGO Energimåler via LEGO MINDSTORMS NXT, må du huske å koble en LEGO transformator til LEGO MINDSTORMS NXT.

Bygg følgende program i programvaren LEGO MINDSTORMS NXT.

- Det første ikonet er et Kjør-ikon som er konfigurert for motor A, varighet er angitt til ubegrenset og kraft angitt til 100.
- Det andre ikonet er et Løkke-ikon, som er konfigurert til å kjøre for evig.
- En Hold i gang-ikon settes inn i Løkke-ikonet, for at MINDSTORMS NXT ikke skal slås av.

Deretter laster du ned og kjører programmet.





- EN** Protect the environment by not disposing of this product with your household waste (2002/96/EC). Check with your local authority for recycling advice and facilities.
- ES** Proteja el medio ambiente no deshaciéndose de este producto junto con sus residuos domésticos (2002/96/CE). Solicite a su autoridad local consejos e información sobre instalaciones de reciclado.
- FR** Protégez l'environnement : ne jetez pas ce produit avec vos autres déchets ménagers (Directive européenne 2002/96/CE). Contactez les autorités locales pour obtenir des informations sur le recyclage et connaître les points de collecte.
- DE** Schützen Sie die Umwelt und entsorgen Sie dieses Produkt nicht mit Ihrem Hausmüll (2002/96/EC). Informationen zu Recycling-Möglichkeiten erhalten Sie bei den örtlichen Behörden.
- IT** Proteggi l'ambiente! Non smaltire questo prodotto con i rifiuti domestici (2002/96/CE). Per consulenza sul riciclaggio dei rifiuti e le strutture di riciclaggio, rivolgerti alle proprie autorità locali.
- NL** Bescherm het milieu: gooi dit product niet samen met het andere huishuisvuil (2002/96/EC). Raadpleeg de plaatselijke instanties voor locaties van milieustructuur en advies over hergebruik.
- DA** Beskyt miljøet! Smid ikke dette produkt ud sammen med husholdningsaffaldet (2002/96/EF). Få vejledning om genbrug og genbrugstationer hos din kommune.
- FI** Tämä tuote on hävettävä ympäristönsuojelun vuoksi asianmukaisesti talousjätteenä erillään (2002/96/EC). Tietoja kierrätyslaitosten sijainnista saa kunnan tai kaupungin teknisestä virastosta.
- SV** Skydda miljön genom att inte kasta denna produkt bland ditt hushållsavfall (2002/96/EC). Kontakta din kommun för frågor om återvinning och miljöstationer.
- PT** Proteja o ambiente não eliminando este produto com o seu lixo doméstico (2002/96/CE). Consulte as autoridades locais para informação sobre reciclagem e sistemas de recolha.
- EL** Προστατίστε το περιβάλλον. Μην πελάτε αυτό το προϊόν μαζί με τα συνηθισμένα οικιακά απορρίμματα (2002/96/ΕΚ). Επικοινωνήστε με τις τοπικές αρχές σχετικά με συμβουλές και εγκαταστάσεις ανακύκλωσης.
- PL** Aby chronić środowisko naturalne, nie należy wyrzucać tego produktu wraz z odpadkami z gospodarstwa domowego (2002/96/WE). W celu uzyskania wskazówek dotyczących recyklingu oraz adresów zakładów należy skontaktować się z lokalnymi urządzeniami.
- CZ** Nevýhazujte tento produkt do domácího odpadu, chráňte životní prostředí (2002/96/EC). Zjistěte si prosím u místních úřadů možnosti recyklace a dostupná zařízení.
- SK** Nevýhadzujte tento produkt do domáceho odpadu, chráňte životné prostredie (2002/96/EC). Zistite si prosím na miestnych úradoch možnosti recyklácie a dostupné zariadenia.
- HU** Környezetet óvja, ha etől a terméktől nem a háztartási hulladékkal együtt válik meg (2002/96/EC). Érdeklődjék a lakóhelyéhez közel eső hűtőszigetelt az újraelosztás módjáról és lehetőségeiről.
- SL** Zaščitite okolje! Odklopite varjete tako, da tega izdelka ne varjete skupaj z gospodinjstvenimi odpadki (v skladu z direktivo 2002/96/ES). Pri krajini upravi preverite, kakšne možnosti in kateri obrati za recikliranje obstajajo v vaši okolici.
- LV** Lai aizsārdētu vidi, neizmetiet šo izstrādājumu kopā ar sadzīves atkritumiem (2002/96/EC). Aizsietas vērtējās varas iestādēs, lai noskaidrotu, kur un kā tas nododams pārstrādei.
- ET** Keskkonda saate kaitata nii, et ei kõrvaldata seda toodet koos omeiejäätmetega (2002/96/EÜ). Nõuandend toote taaskasutuse võtmise ja ümbritõstmispunktidde kohta saate teada omaaast kohalikest asutustest.
- LT** Saugykite aplinka – nemeskite šio produkto kartu su buitineis atliekomais (2002/96/EB). Atsiveltike į savo vietos valdības rekomendacijas dėl pakartotinio panaudojimo ir sąlygas.



LEGO® MINDSTORMS® Education (building instructions and activities at [www.MINDSTORMSeducation.com](http://www.MINDSTORMSeducation.com))



- LEGO® MINDSTORMS® Education (building instructions and activities at [www.MINDSTORMSeducation.com](http://www.MINDSTORMSeducation.com))
- LEGO® MINDSTORMS® Education (Bauanleitungen und Aktivitäten unter [www.MINDSTORMSeducation.com](http://www.MINDSTORMSeducation.com))
- LEGO® MINDSTORMS® Education (instructions de montage et activités sur le site [www.MINDSTORMSeducation.com](http://www.MINDSTORMSeducation.com))
- LEGO® MINDSTORMS® Education (instrucciones y actividades de construcción disponibles en [www.MINDSTORMSeducation.com](http://www.MINDSTORMSeducation.com))
- LEGO® MINDSTORMS® Education (instruções de construção e actividades em [www.MINDSTORMSeducation.com](http://www.MINDSTORMSeducation.com))

[MINDSTORMSeducation.com](http://MINDSTORMSeducation.com)

