



Kingdoms



7188



1

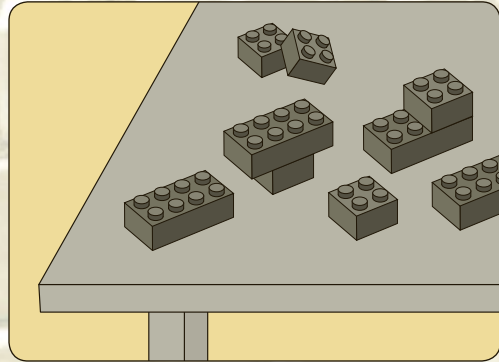

2





+

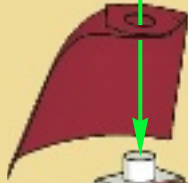



2x



1x



1x

1x



1

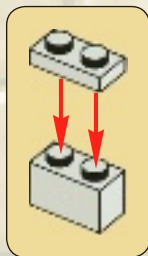



2

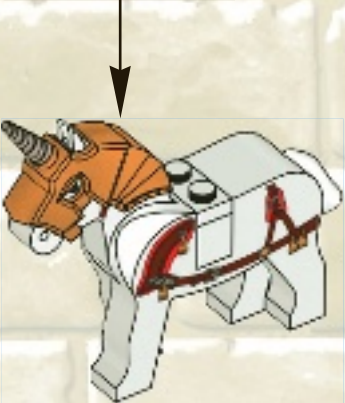
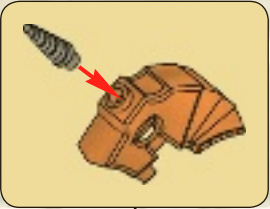

2x

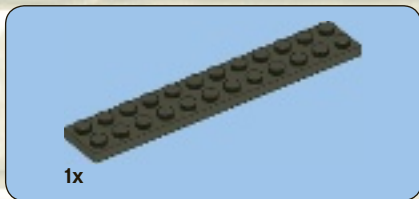

1



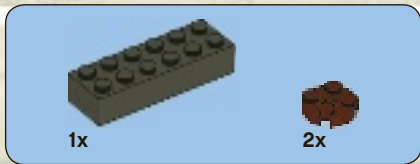

2

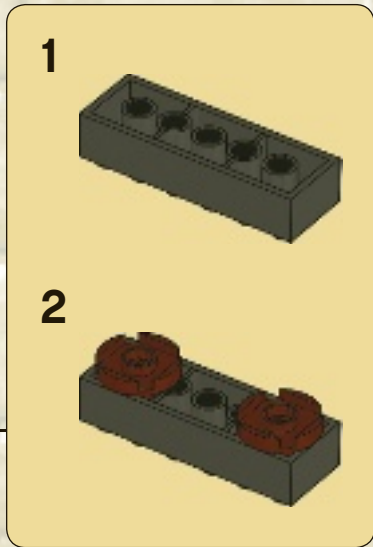
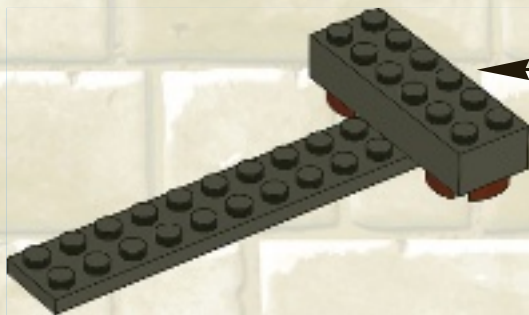



2x

3

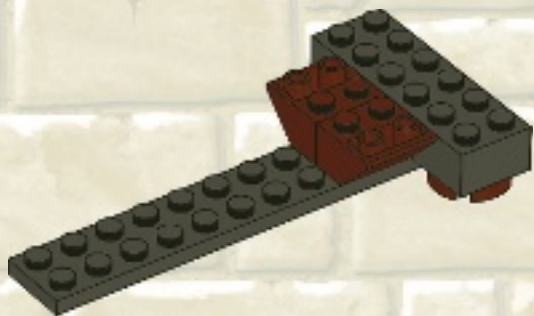

2x

4

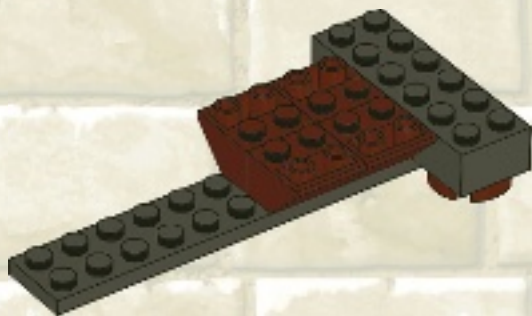



2x

5

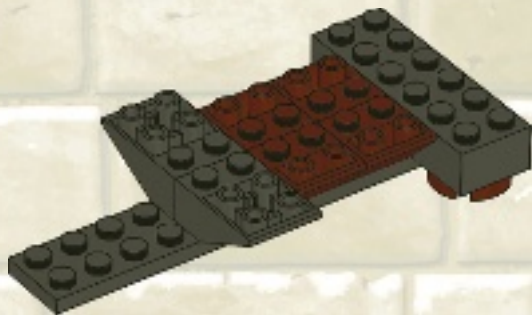

2x

6

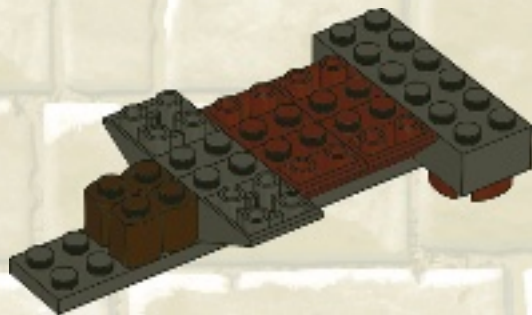



7

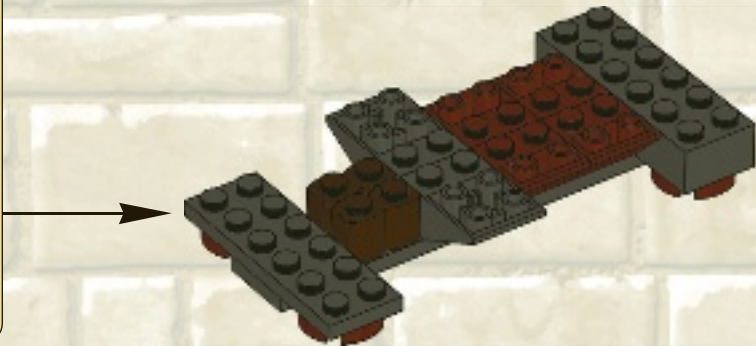
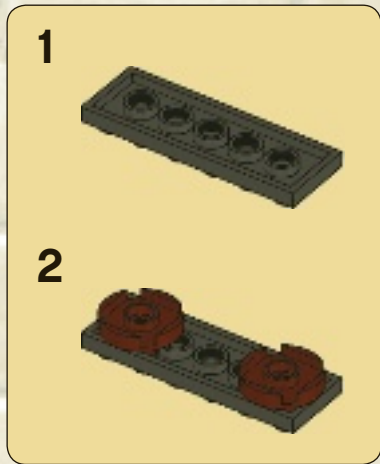



1x



1x

8

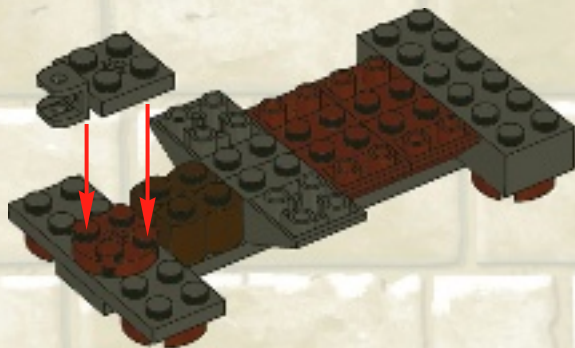

1x



2x

9

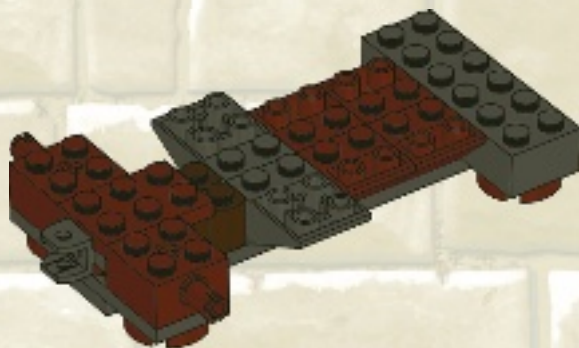

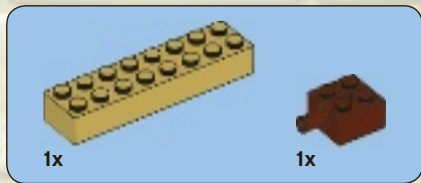

10

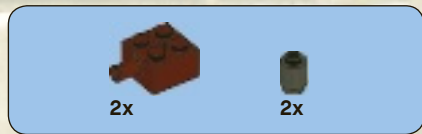
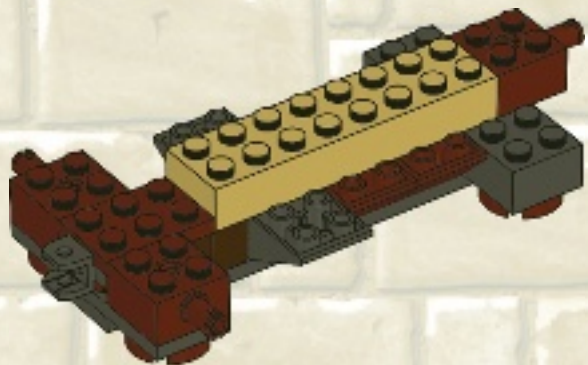

11

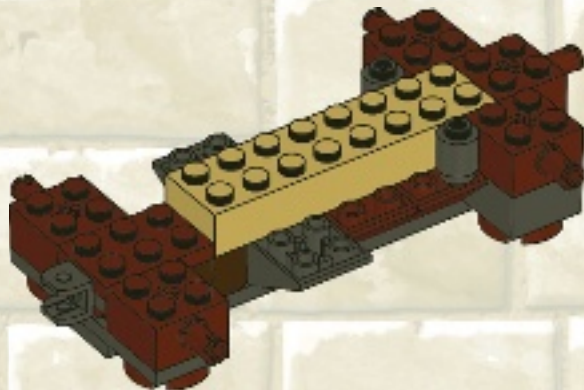



2x

12

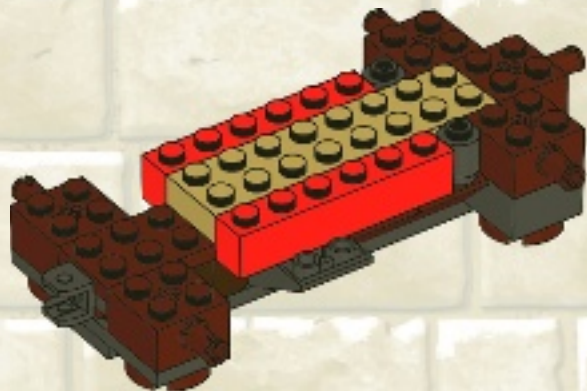

2x

13

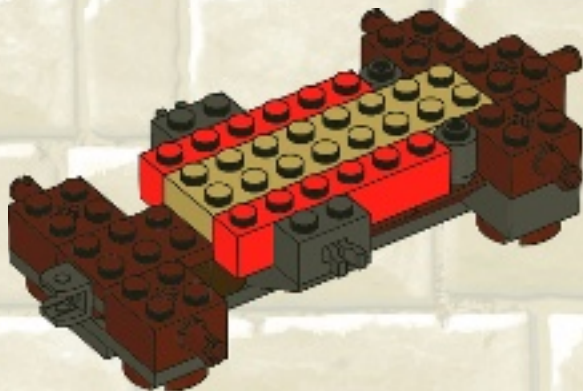



14



15

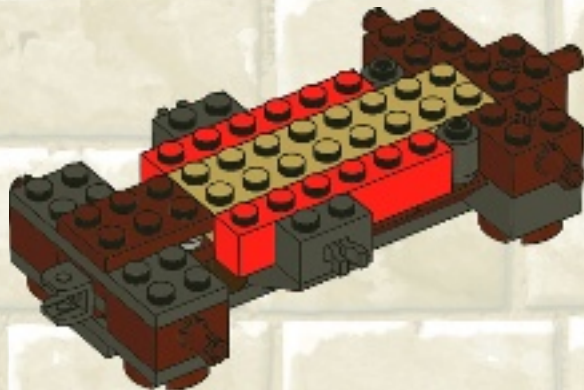



2x

16

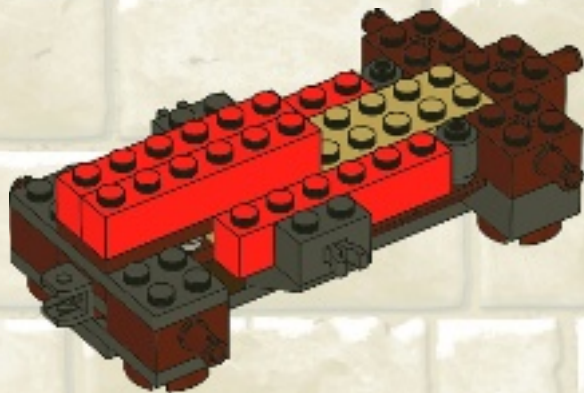

2x

17

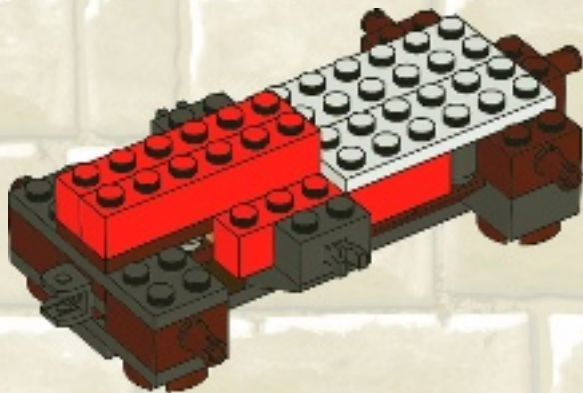

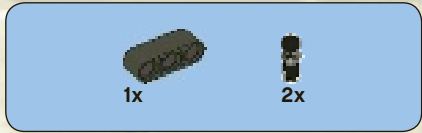

18

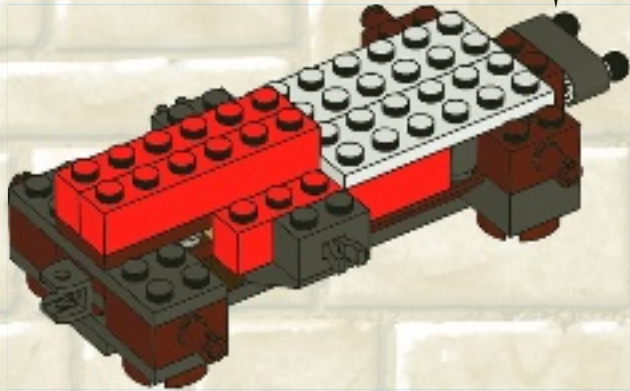
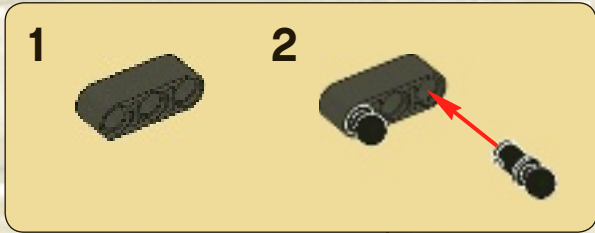



19

1

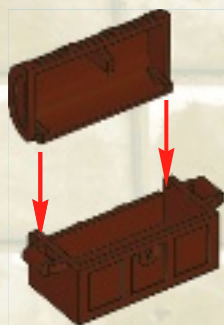

2



3



4



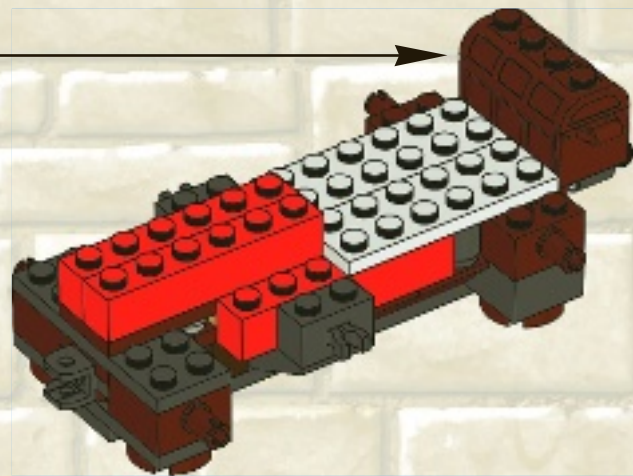

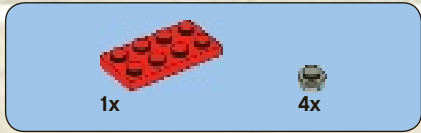

20

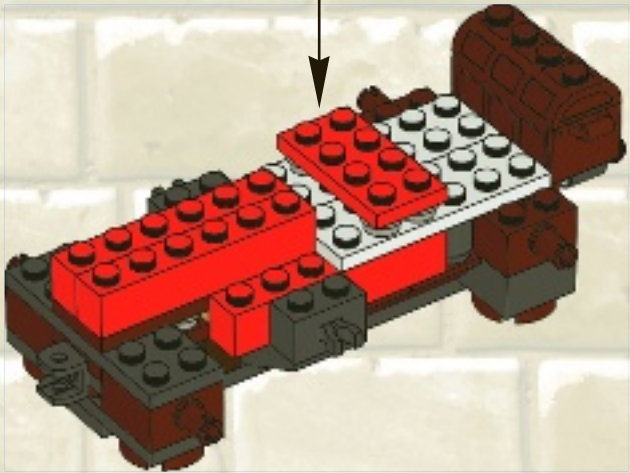
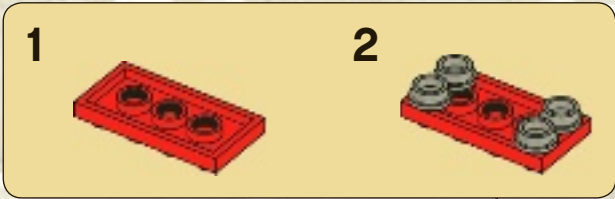



2x

21

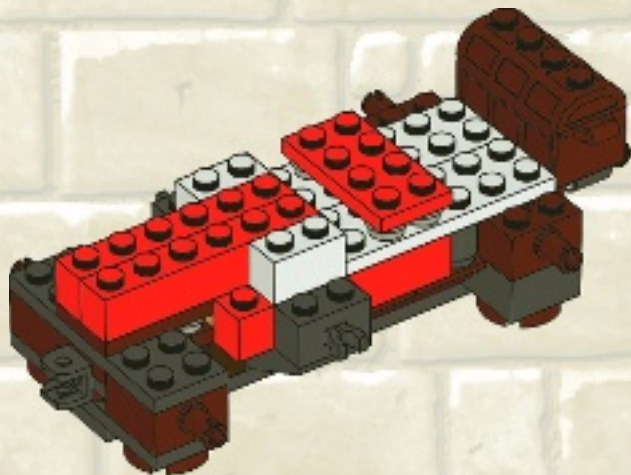

2x

22

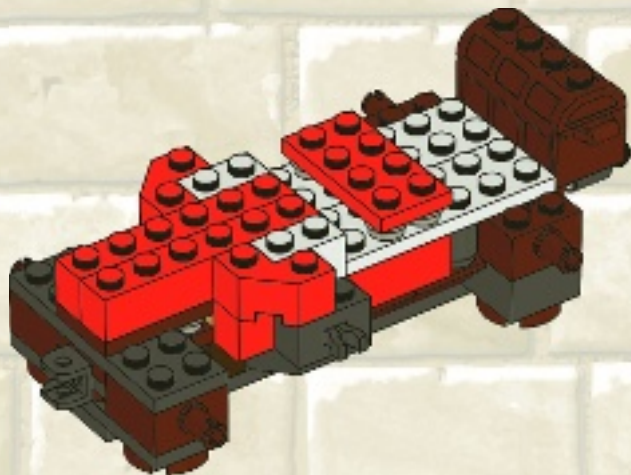

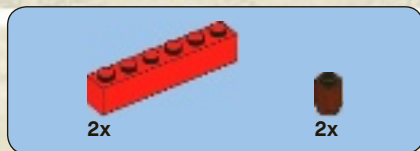

23

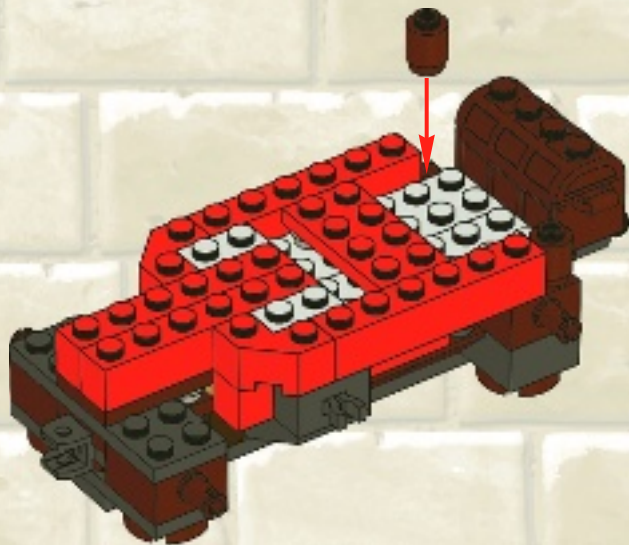



24

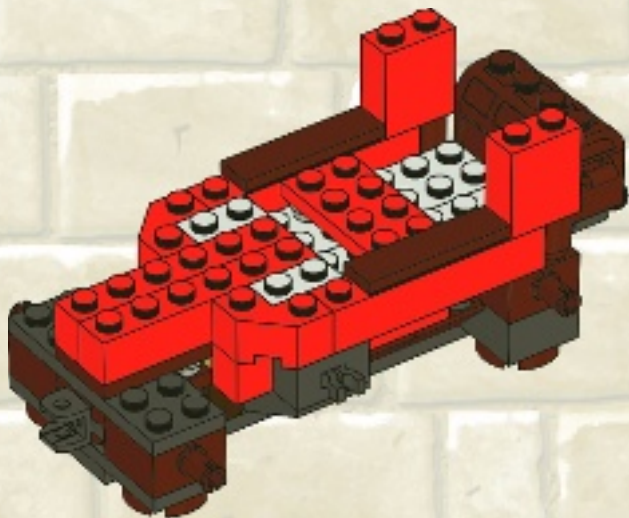

25

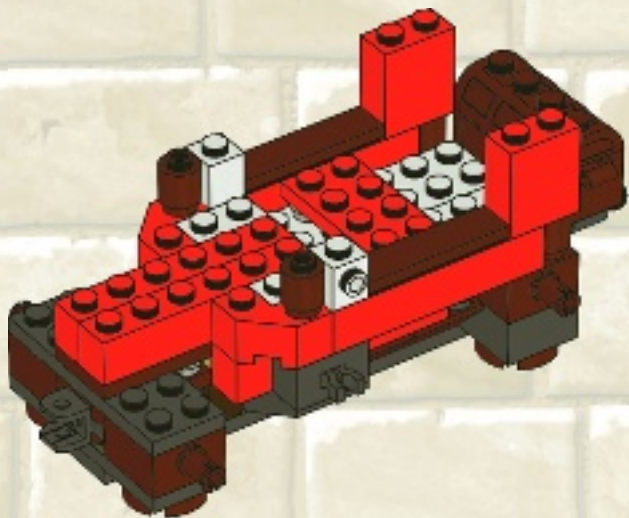



2x

26

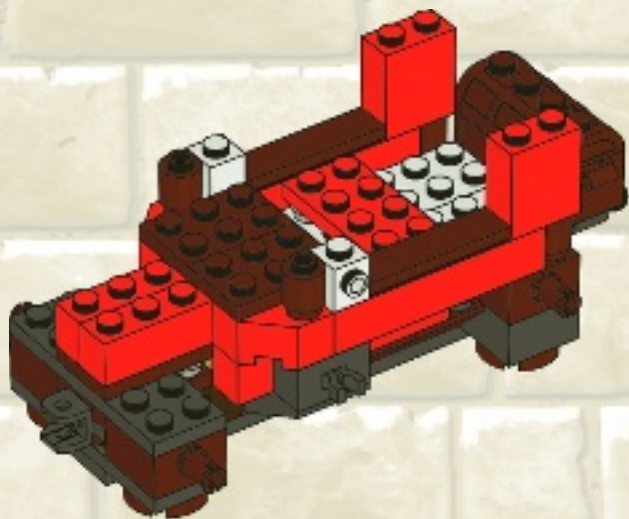

2x



2x

27

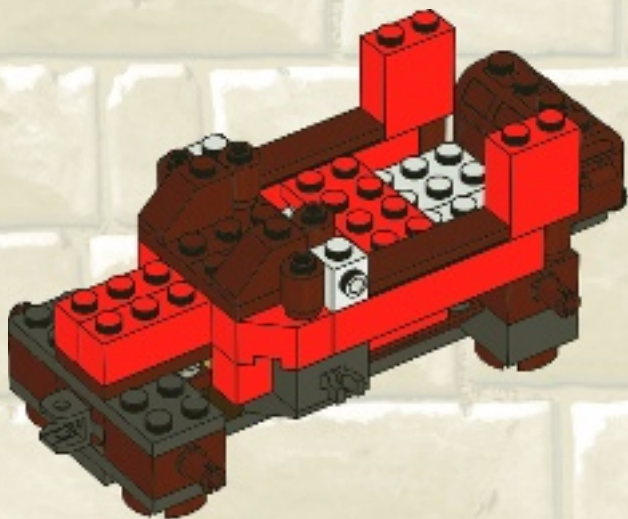



2x



2x

28

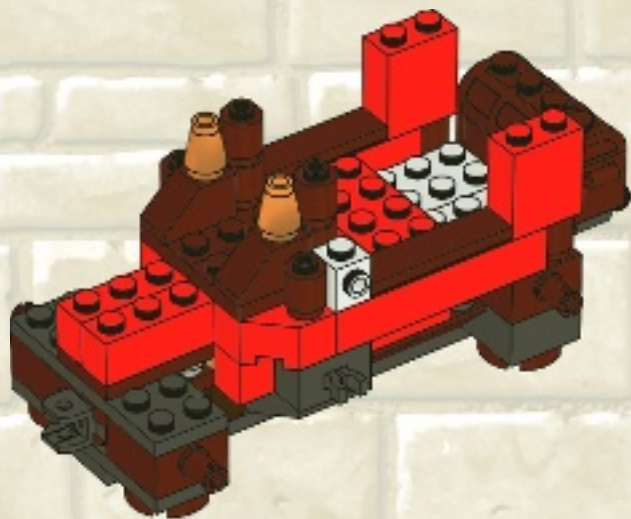



2x

29

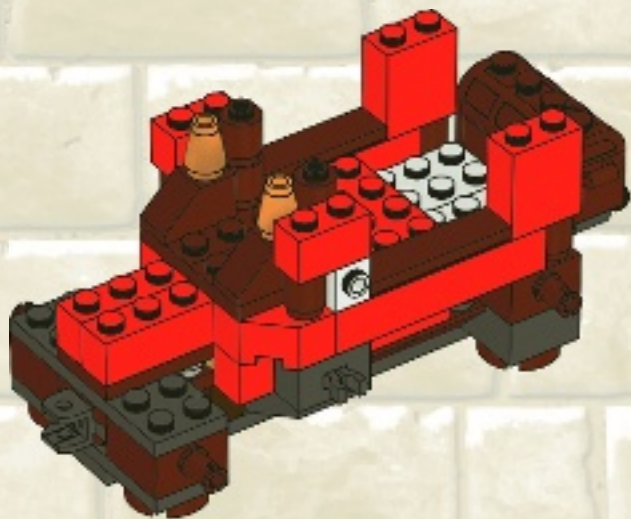

4x

30

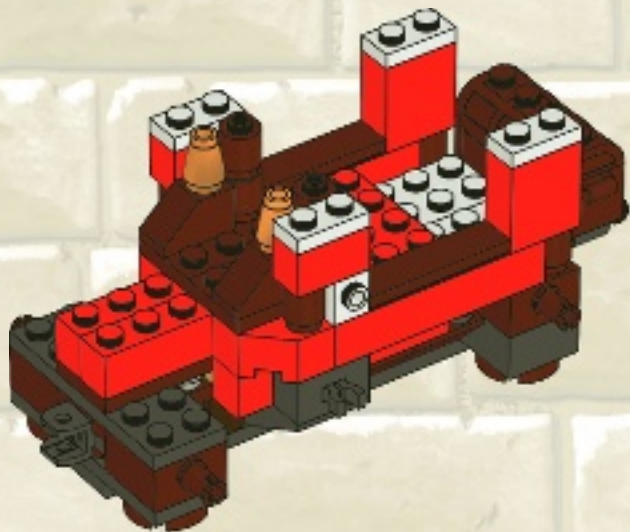



1x



1x

31

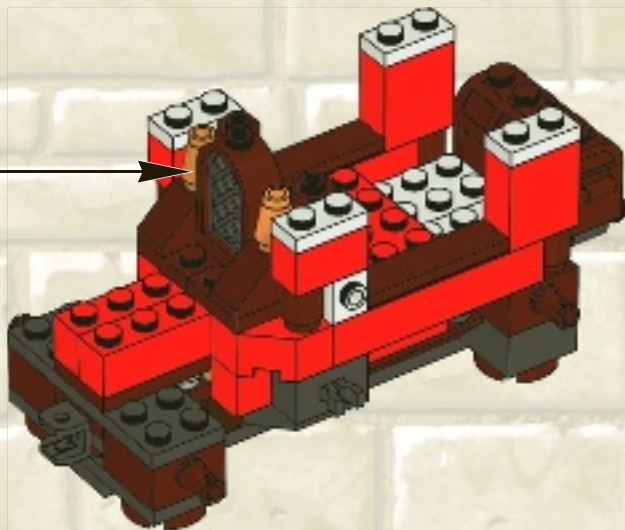
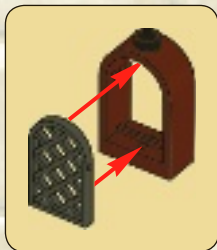



2x



1x

32

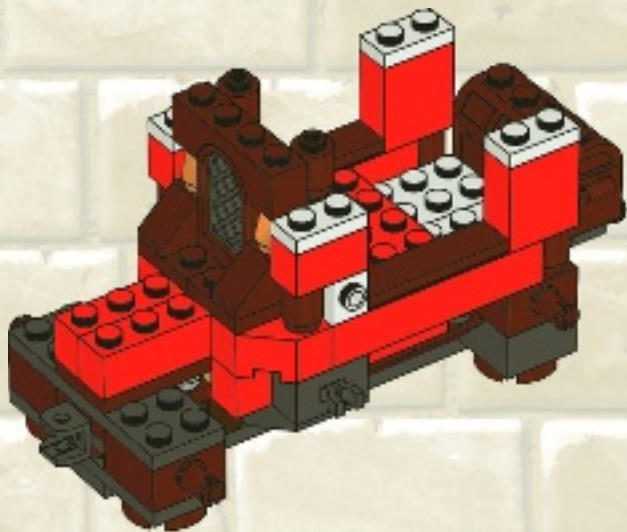



4x

33

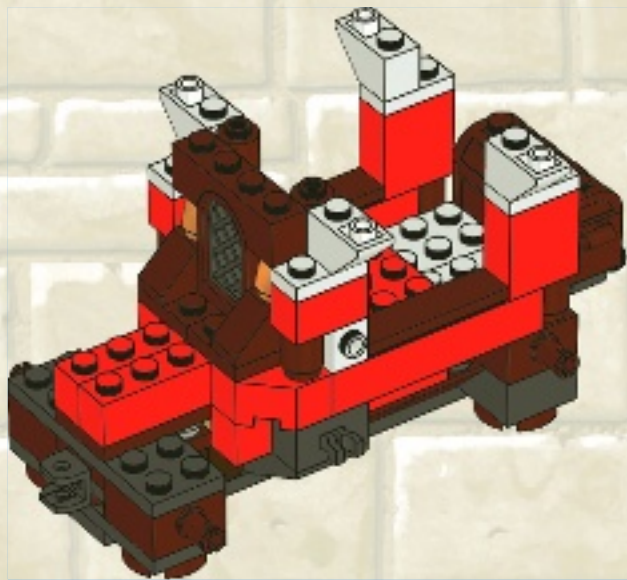



4x

34

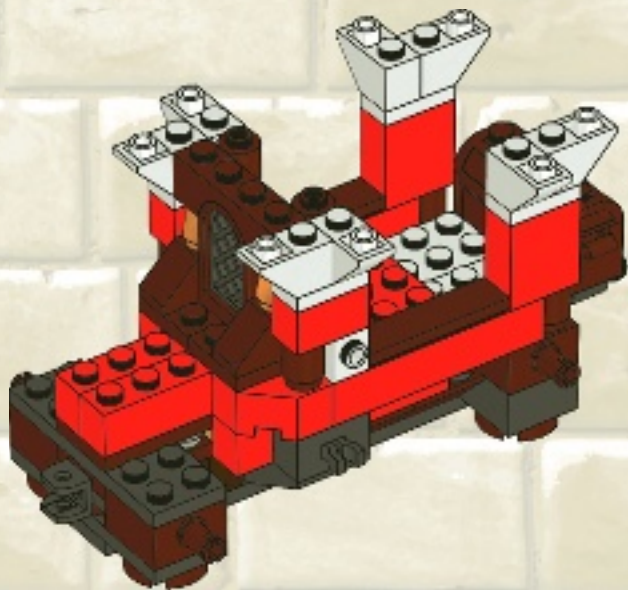



2x



2x

35

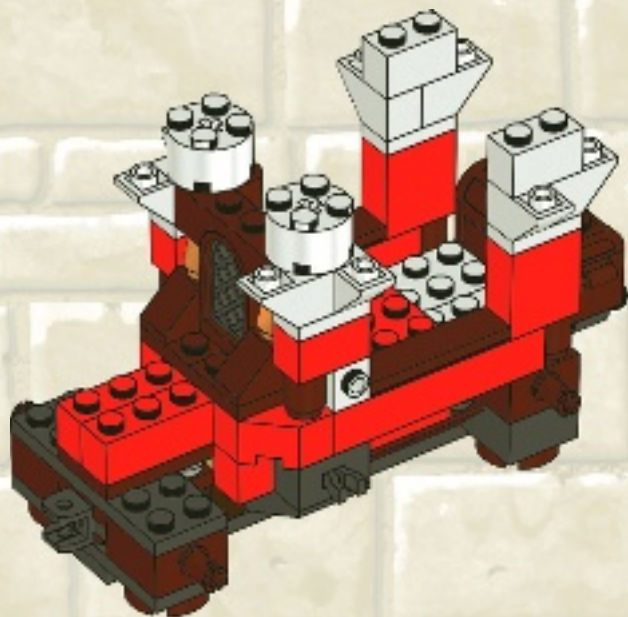

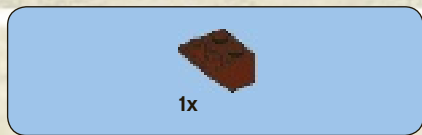

36

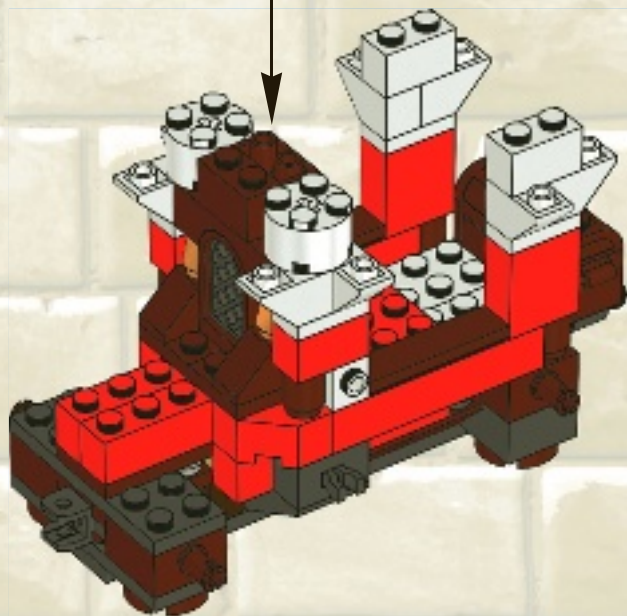



2x

37

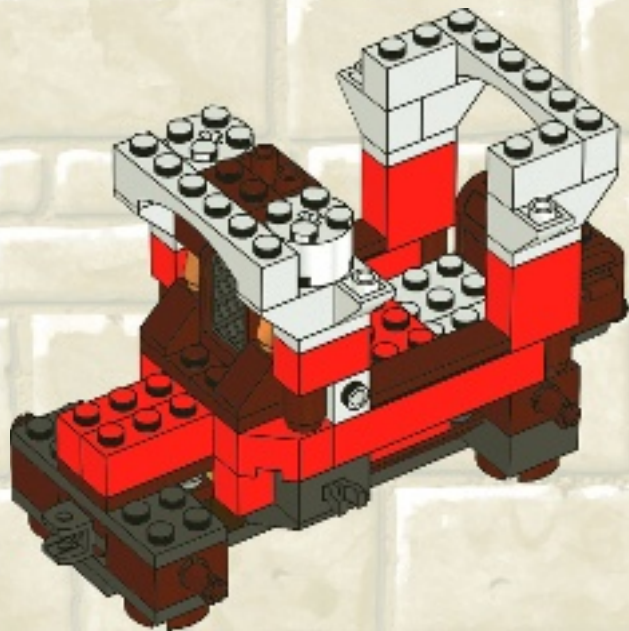

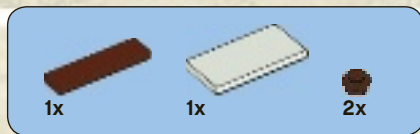

38

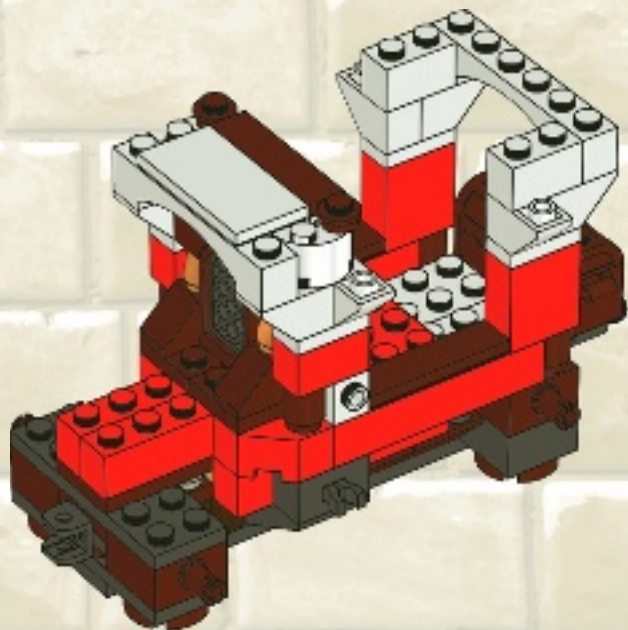



1x



2x

39

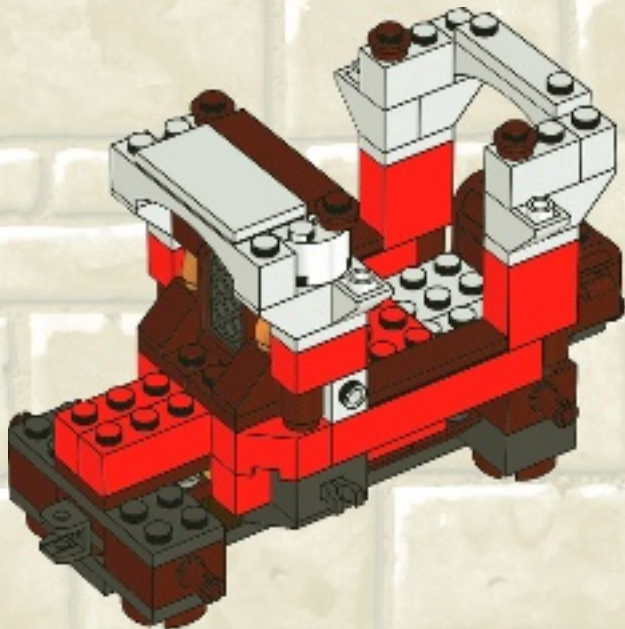



4x

40

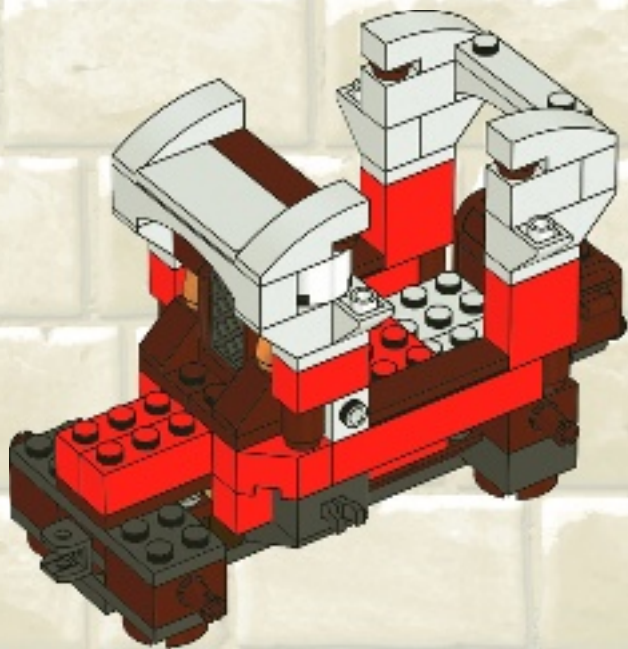



2x

41

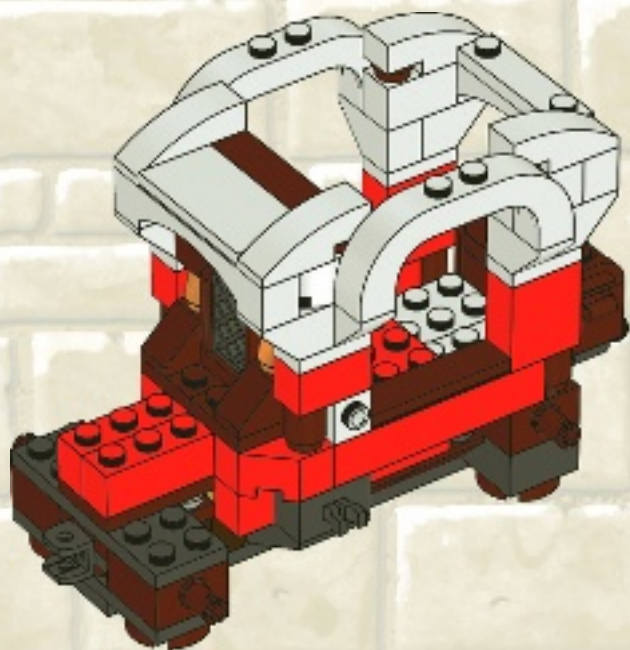

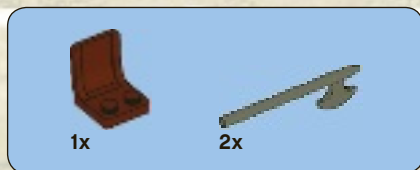

42

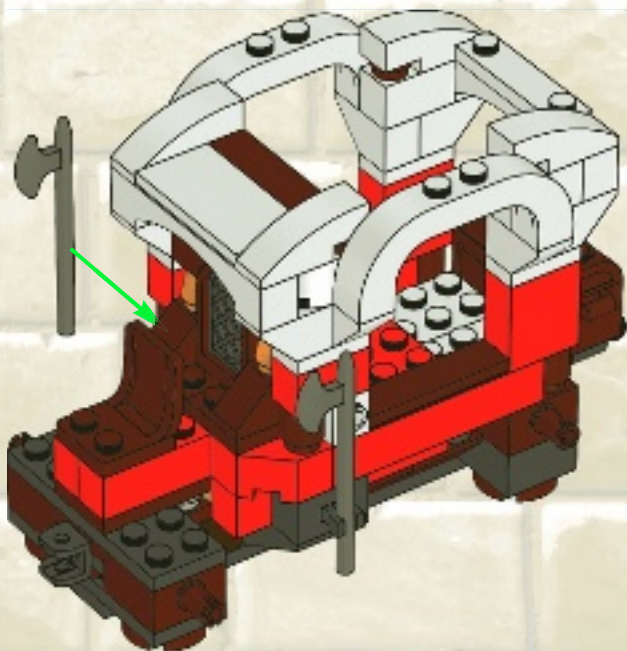



2x

43



2x

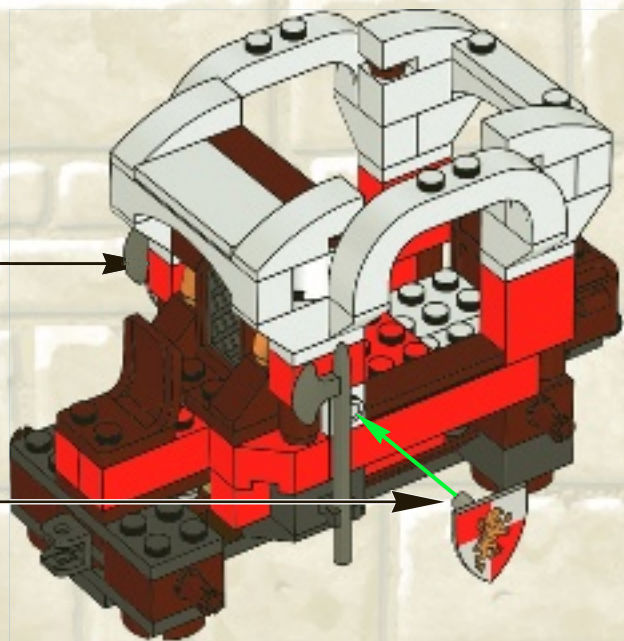

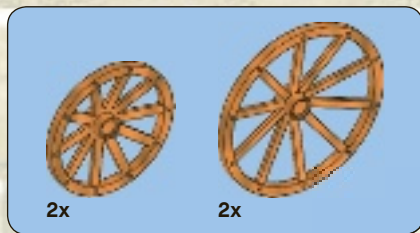

44

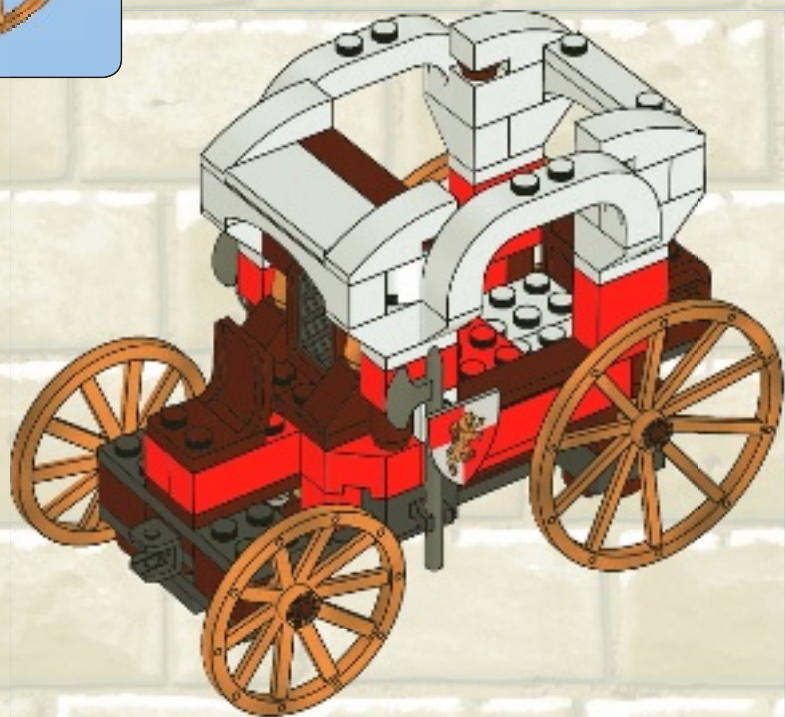

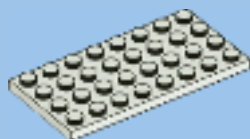

1x

1



1x



2x

2

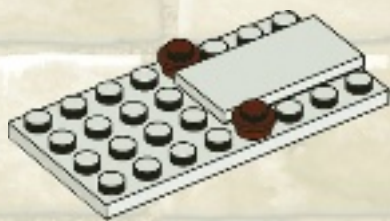



2x



2x

3

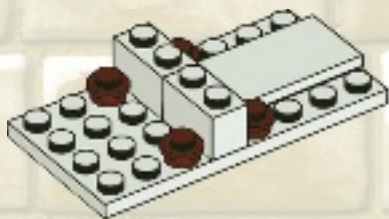

4x

4

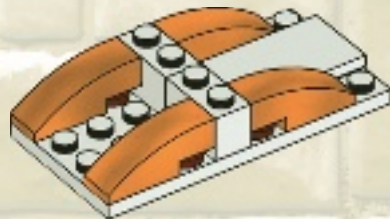

45

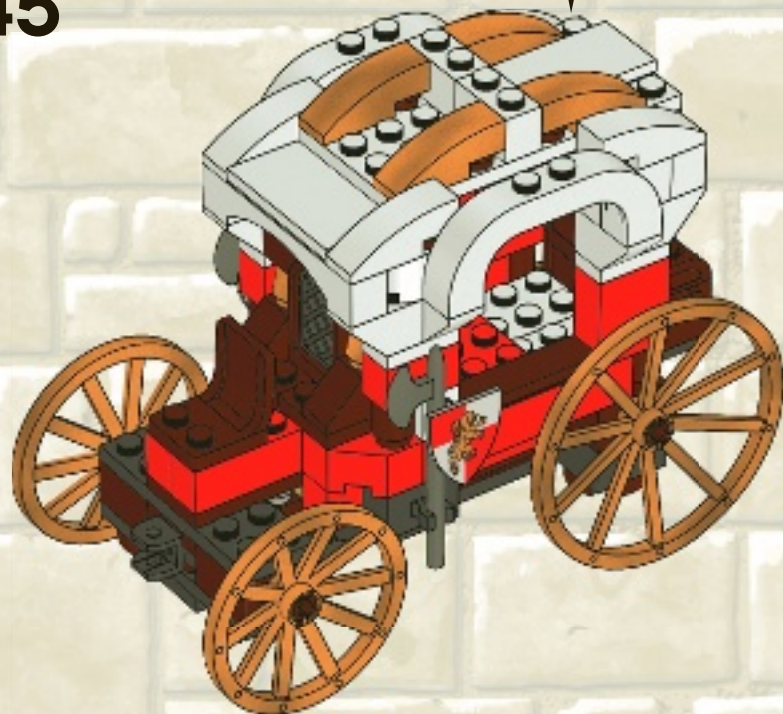

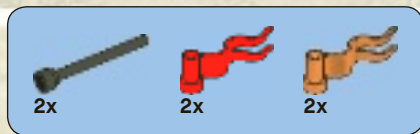

46

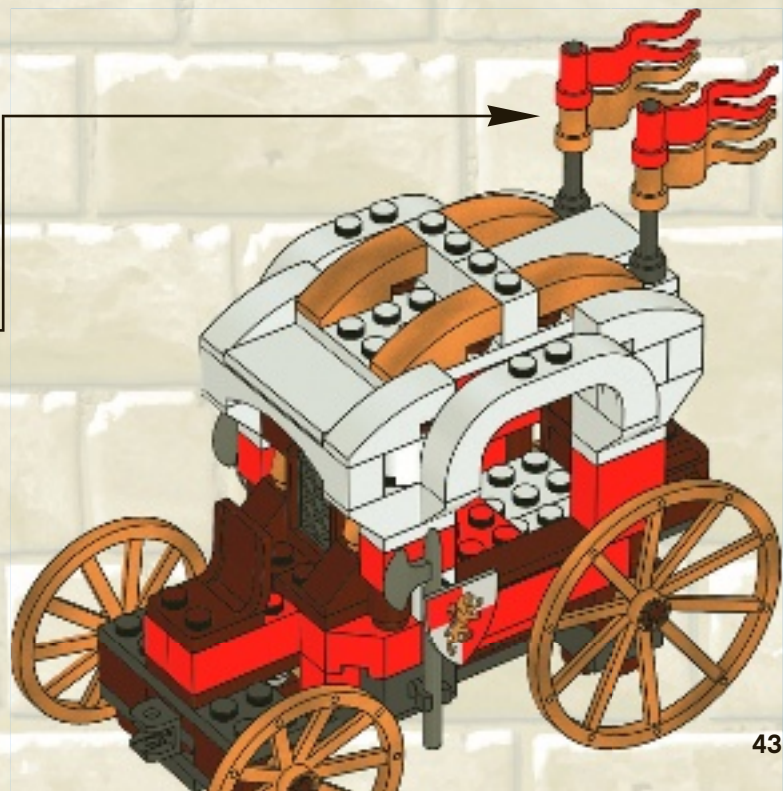
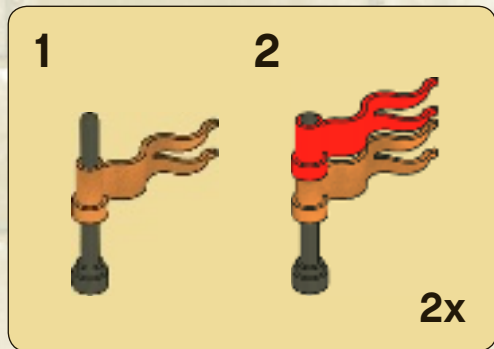



1x

1



2x



2x

2





3

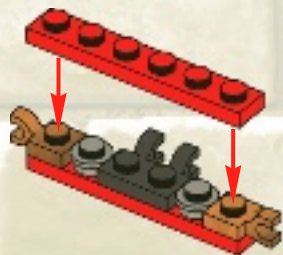

4



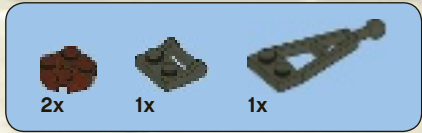

5

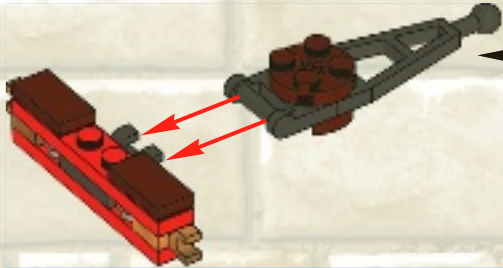

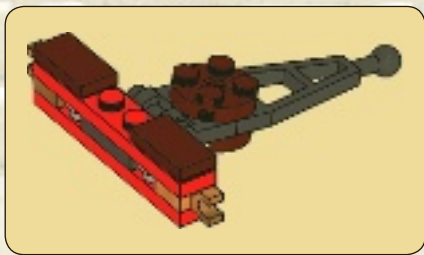

6



47

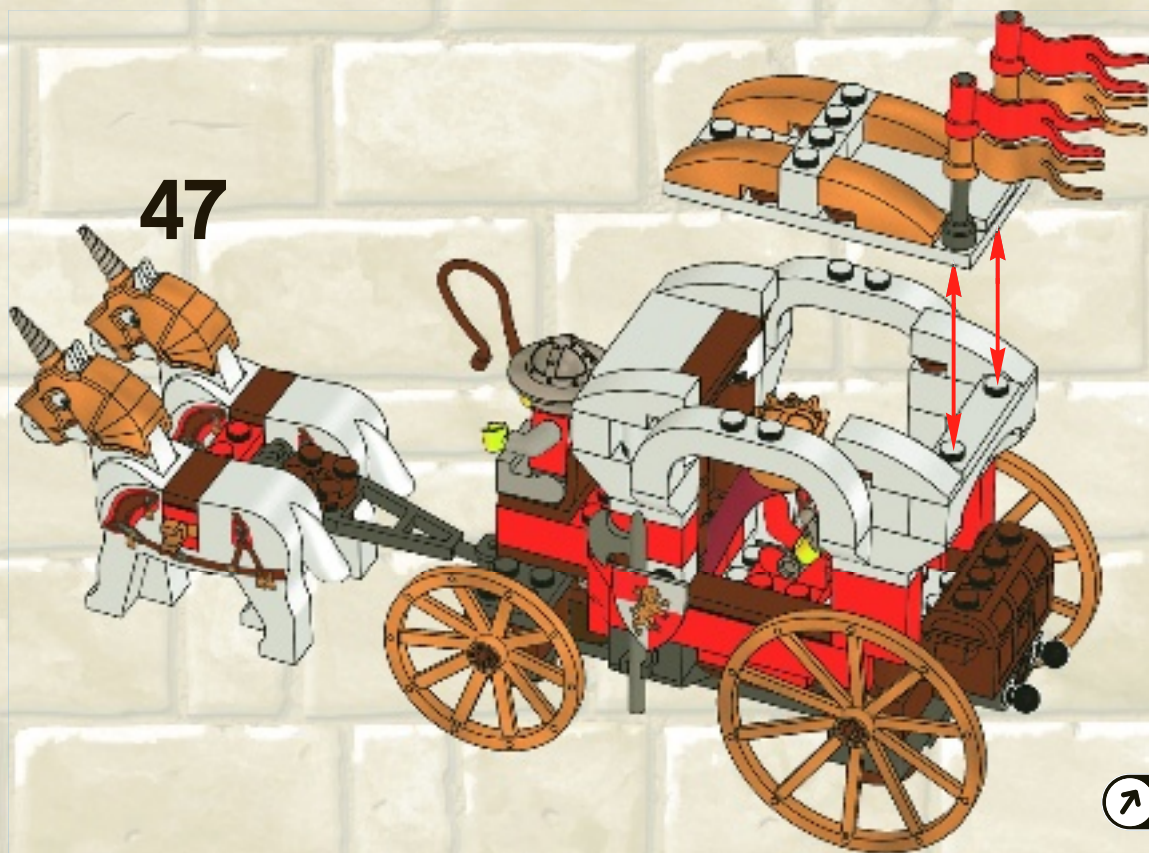



Kingdoms



7188



3



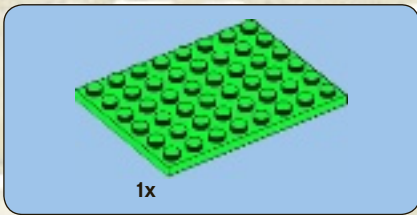

1





2



3



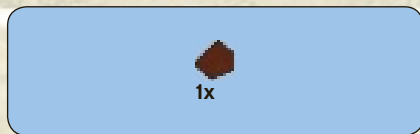

4



5





2x



1x

6

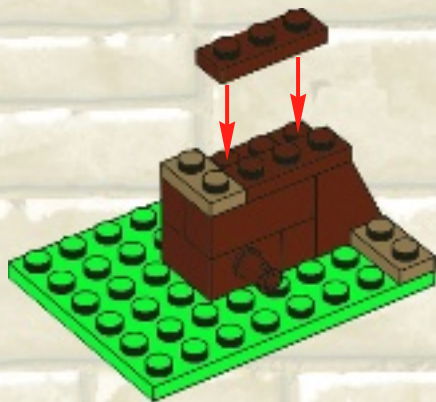



1x



1x

7



1x

8

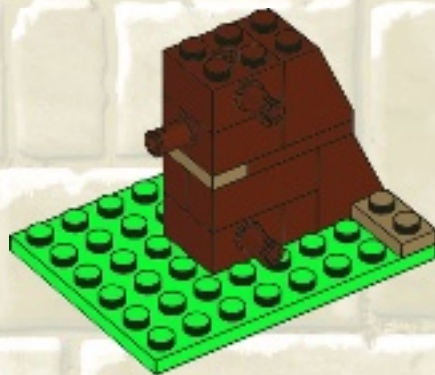



1x

9

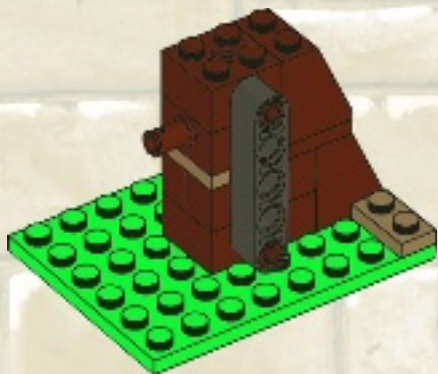

8



2x

10

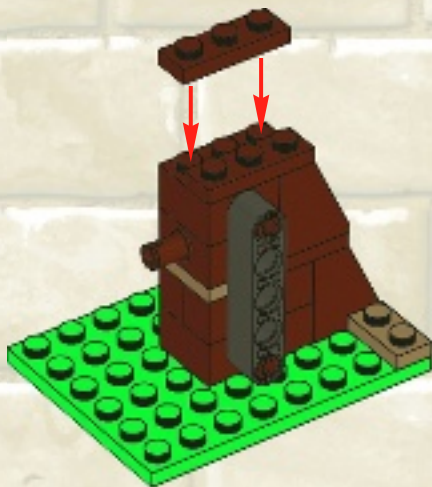



1x



1x

11

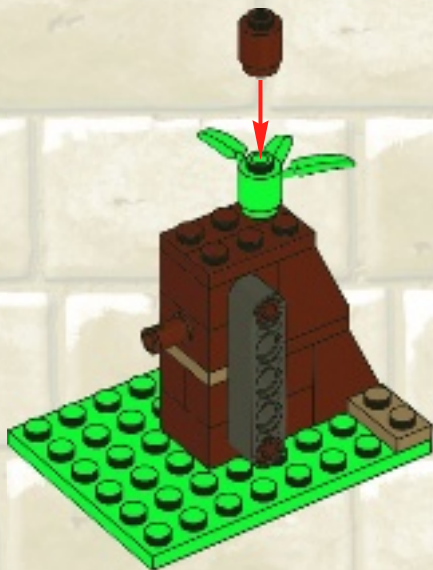

1x

12

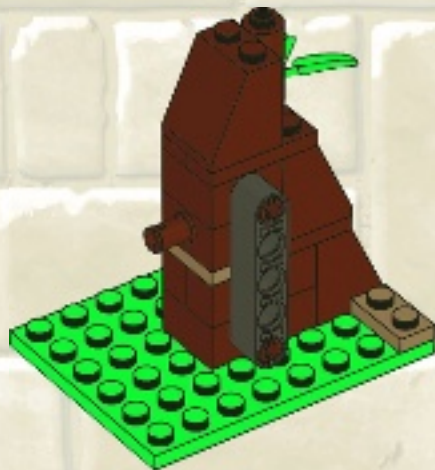

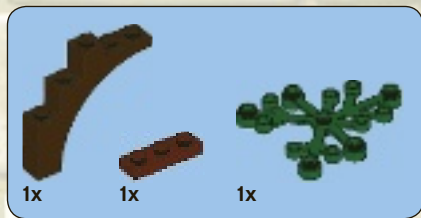

13

1



2



3



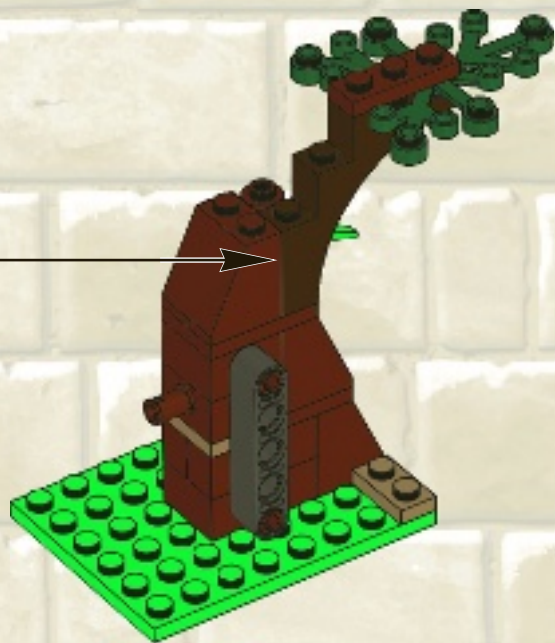



1x



1x

14

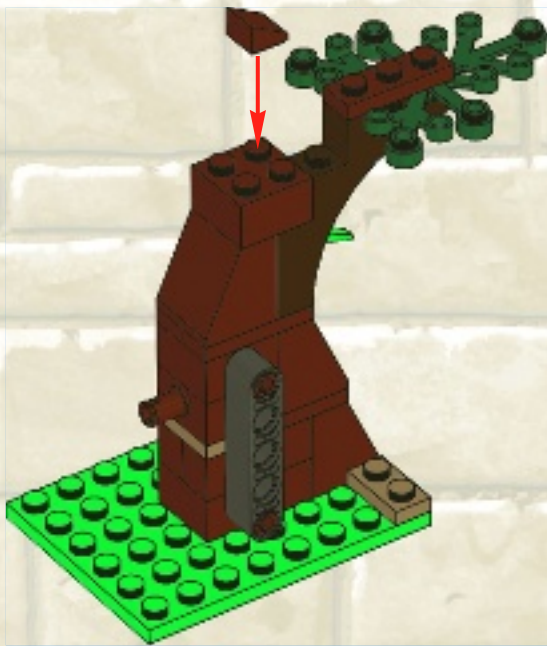



1x



1x

15

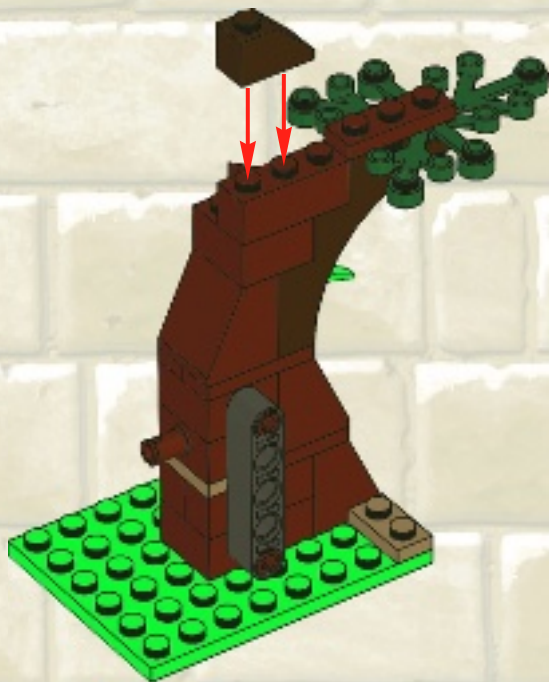

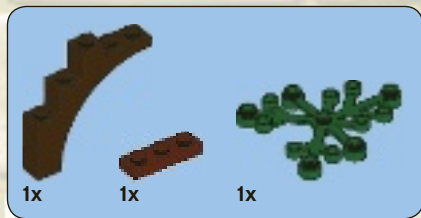

16

1



2



3



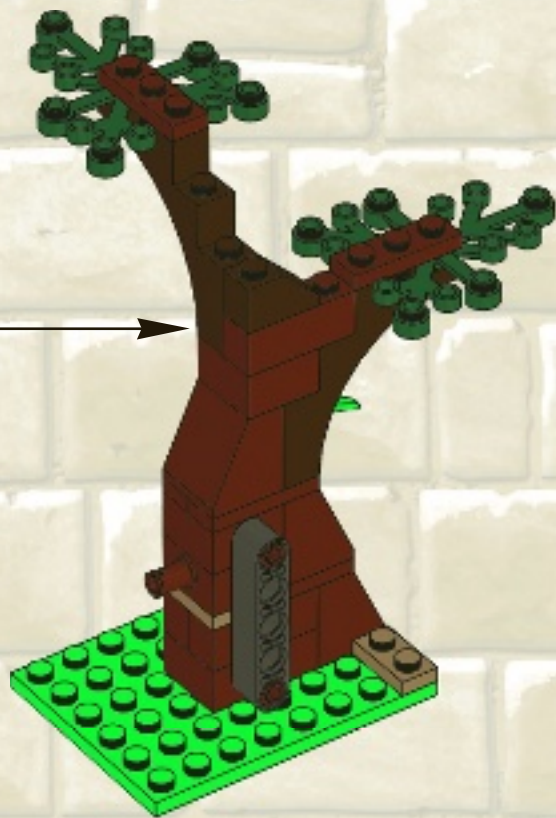



17

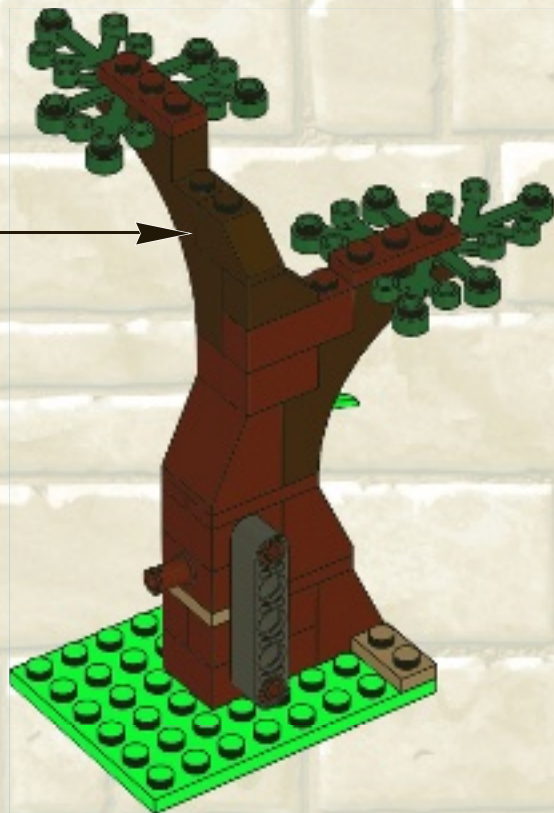



18

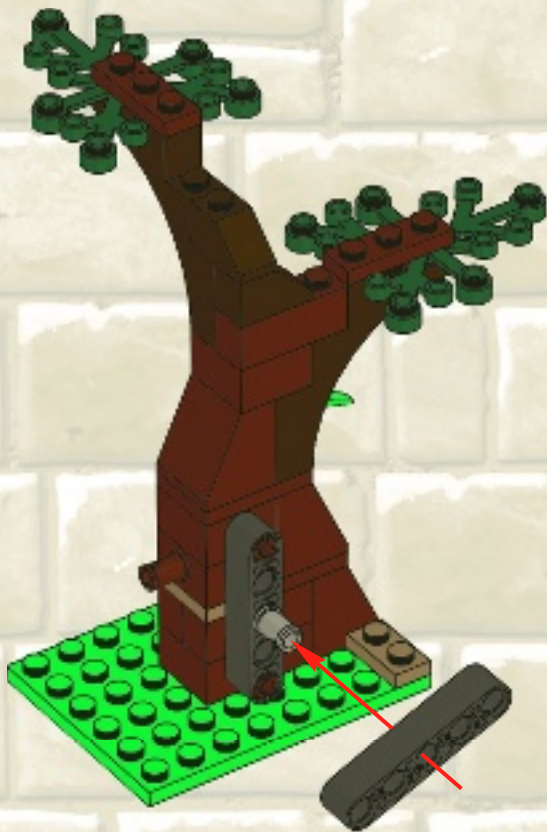



1x

1



2x

2





3

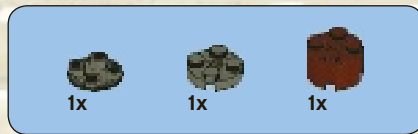

4

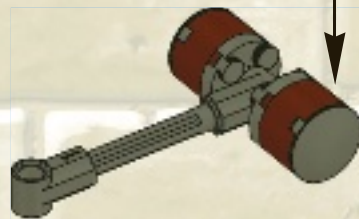

19

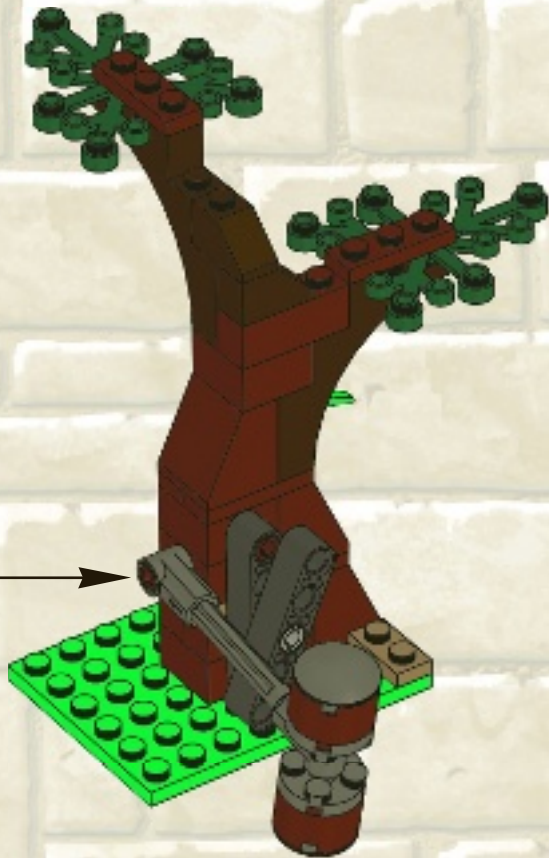

20

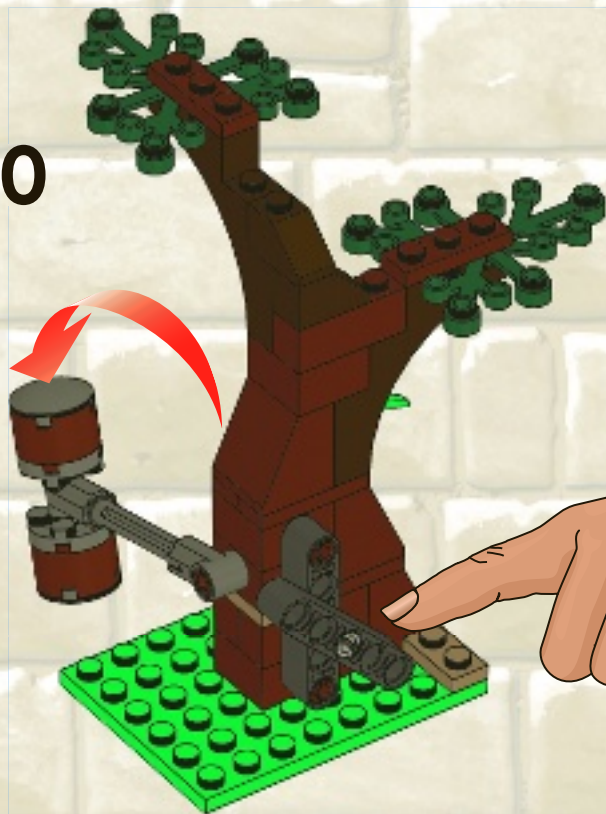

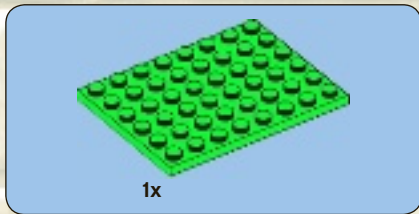

1





2

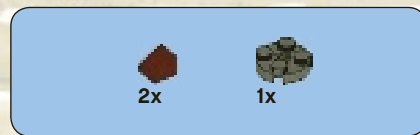
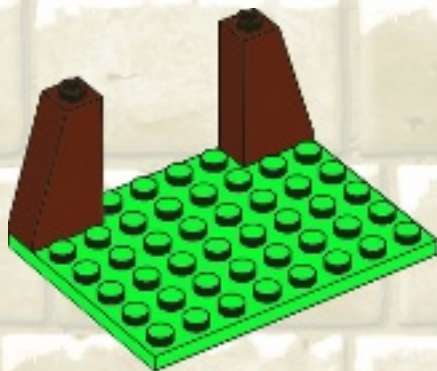

3

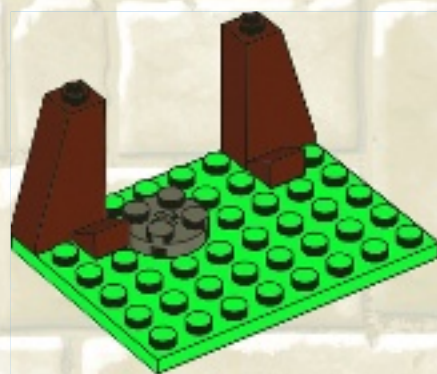



2x

4





2x



1x

5



2x

6





1x

7

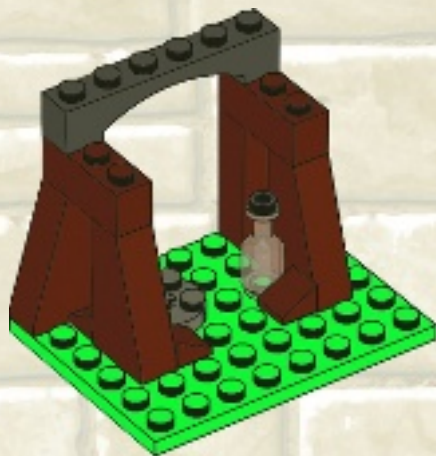



2x

8



1x

9





2x

10





4x



1x

11

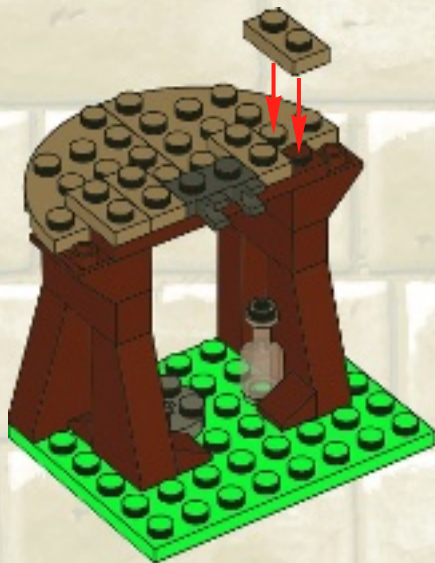

2x



1x

12



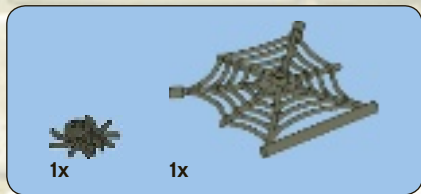

13

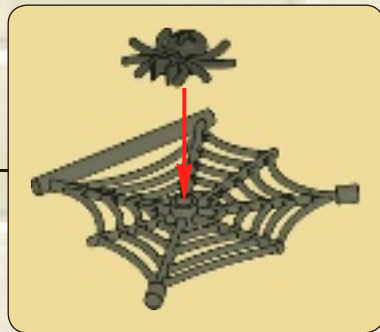
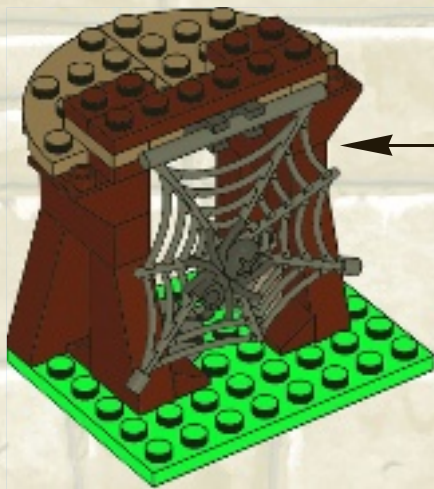



1x



1x

14

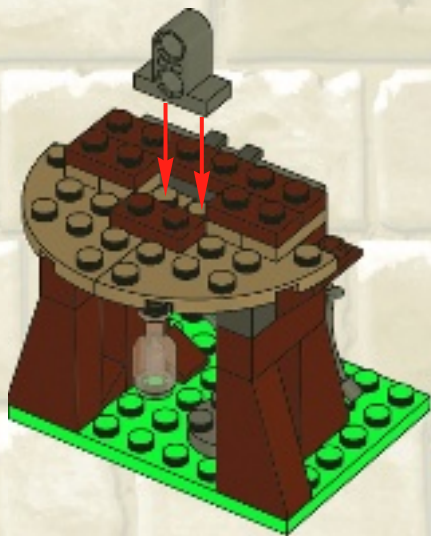



2x

15

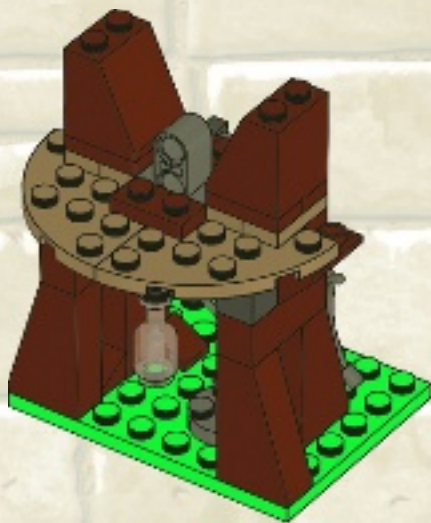



16

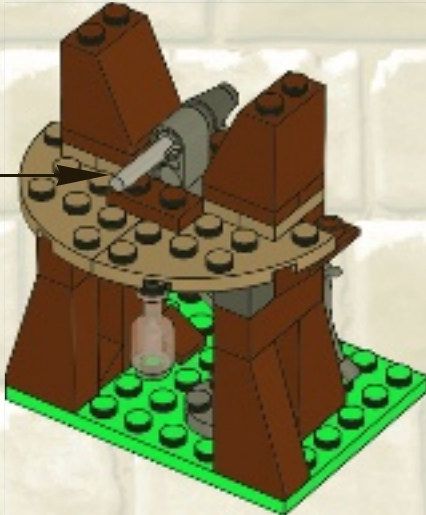
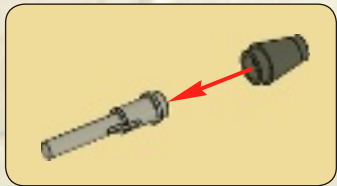
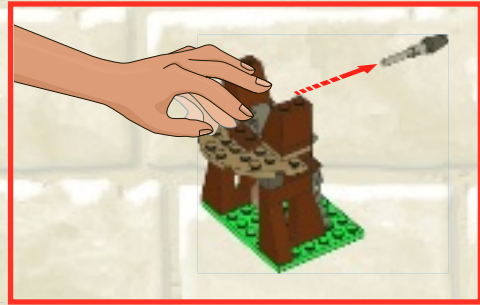

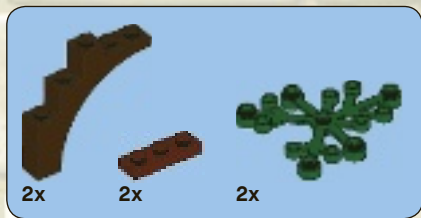

17

1



2



3



2x

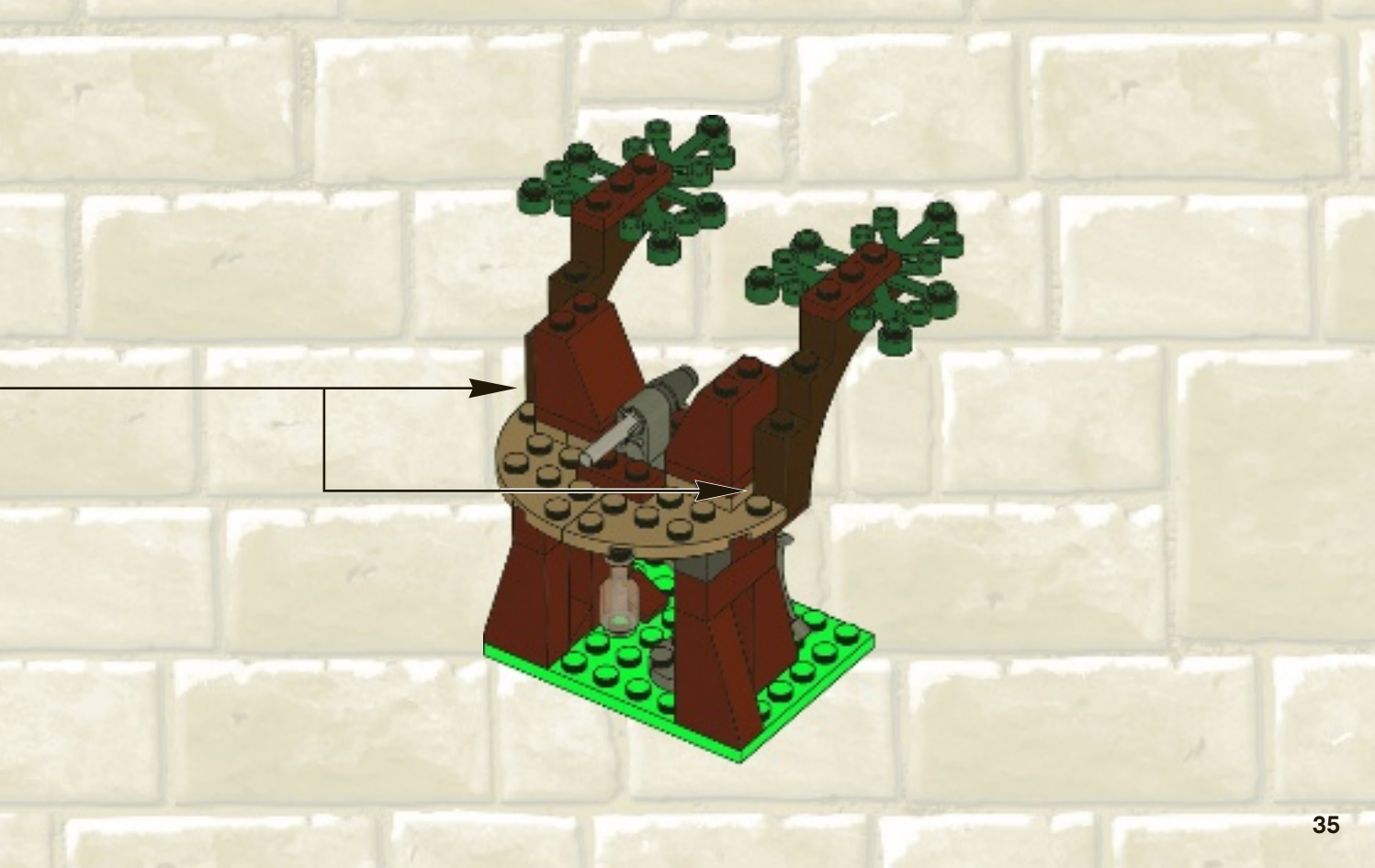

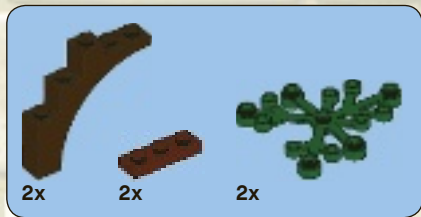

18

1



2



3



2x

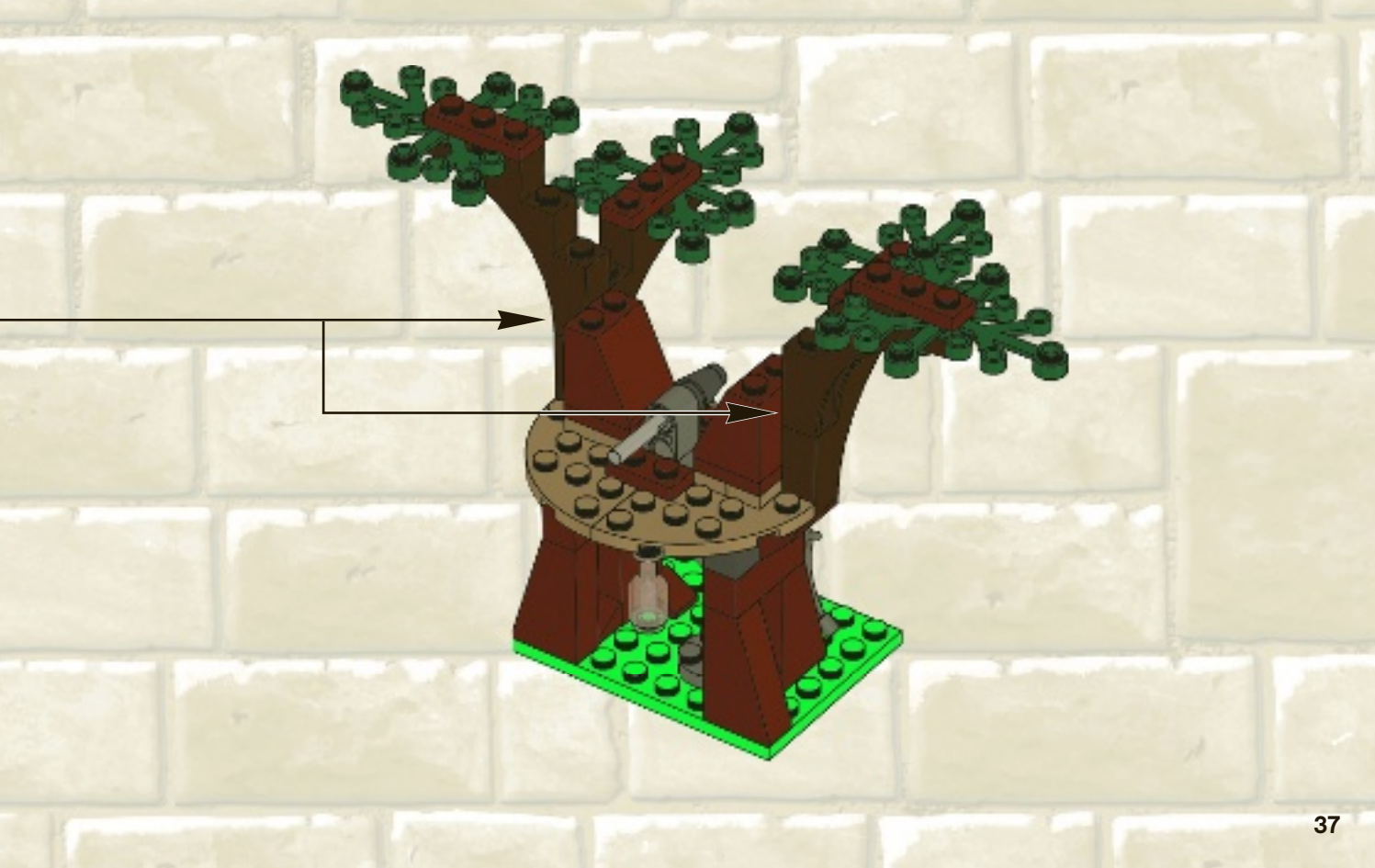



19

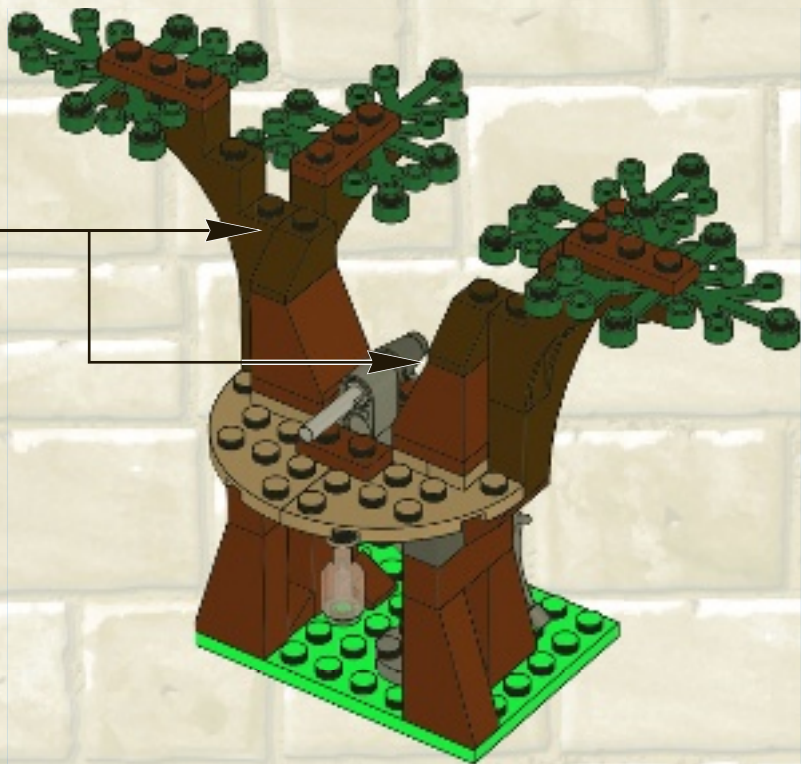



20

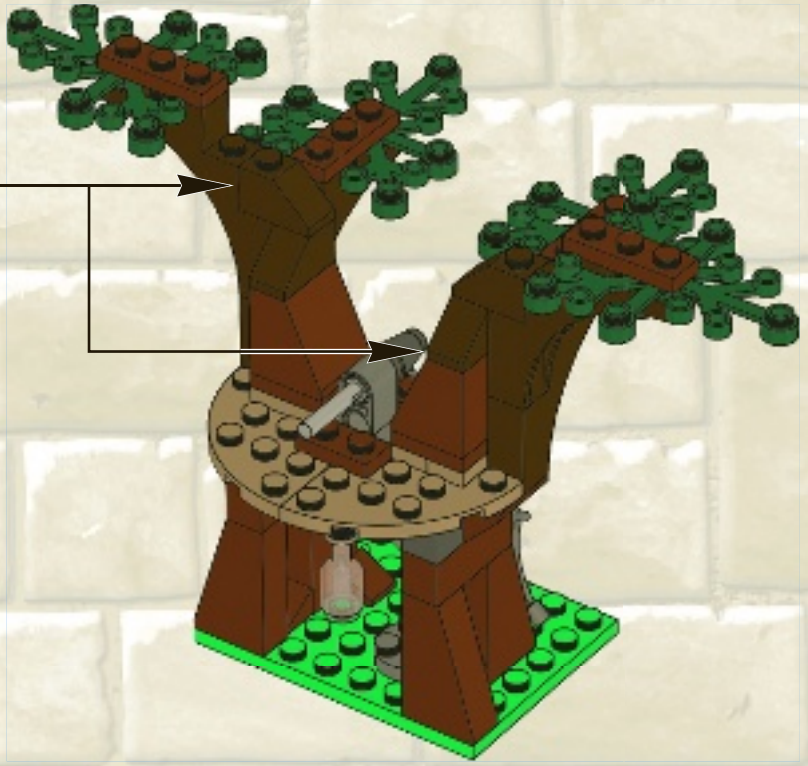







Kingdoms



7187

6918

7188



7946



7189





UNIVERSE

MASSIVELY MULTIPLAYER
ONLINE GAME



EVERYONE 10+ TM

E ₁₀₊

Cartoon Violence

ESRB CONTENT RATING www.esrb.org

Online Interactions Not Rated by the ESRB

MEHRSPIELER ONLINE SPIEL • VIDEOJUENGO MULTIJUGADOR MASIVO EN LINEA
 JEU EN LIGNE MASSIVEMENT MULTIOJUEUR • JOGO MULTIOGADOR ONLINE EM MASSA
 NAGYON SOK SZEREPLŐS ONLINE JÁTEK



www.LEGOuniverse.com



www.LEGOclub.com



LEGO® Club Email



LEGO® Club Magazine

SIGN UP ONLINE!

www.LEGOclub.com



00800 5346 5555*



1-866-534-6258 • 1-877-518-5346

US & Canada only

Outside continental

- * Freephone. Mobile charges may apply.
- * Numéro sans frais. Des frais peuvent s'appliquer avec les téléphones cellulaires.
- * Gebührenfrei. Kosten für Anrufe aus Mobilfunknetzen können abweichen.
- * Gratis telefoonnummer vanaf vaste lijn.
- * Det er et gratis nummer, når du ringer fra fasttelefon.
- * Det är gratis, när du ringer från en fast telefon.
- * Numéro sans frais. Des frais peuvent s'appliquer avec les téléphones portables.



8x
300401



2x
4558952



2x
614301



8x
366501



4x
4249112



2x
4581717



2x
4620761



6x
302301



1x
4597131

46



2x
4560178



2x
379501

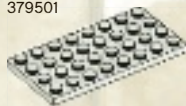

1x
303501



1x
4623967



2x
4622492



1x
4141533



2x
4143832



2x
300421



6x
300921



2x
4581525



1x
302021



2x
366621



2x
449521



1x
4623373



1x
4586497



1x
4570009



1x
4259915



1x
4586453



1x
4528206



1x
4181144



2x
4118624



2x
306226



1x
4529236



2x
379526

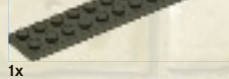

1x
244526



2x
374726

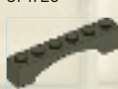

1x
4620763



1x
4529064



2x
4556158



1x
4225201



1x
4274405



1x
3004626



2x
395726



2x
9339



1x
4113209



1x
4142822



2x
4142135



2x
4184169



1x
4113954



1x
4113955



2x
4507311



1x
4114348



1x
4620380

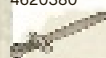

1x
4649842



6x
4528604



2x
4570451



6x
4505066



1x
4586500



1x
4590759



1x
4211210



Customer Service
Kundenservice
Service Consommateurs
Servicio Al Consumidor

www.lego.com/service or dial

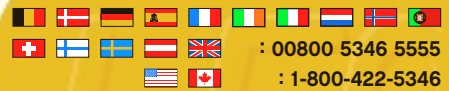

: 00800 5346 5555

: 1-800-422-5346



WIN!

Go to www.LEGOsurvey.com/product to fill out a survey for a chance to win a cool LEGO® Product.

No purchase necessary.

Open to all residents where not prohibited.

www.LEGO.com



www.LEGOsurvey.com/product

GEWINNE!

Nimm an der Umfrage auf www.LEGOsurvey.com/product teil und hab die Chance ein cooles LEGO® Produkt zu gewinnen!

Die Teilnahme am Gewinnspiel führt zu keinerlei Kaufverpflichtungen. Teilnahme in allen nicht ausgeschlossenen Ländern möglich.

WIN!

Ga naar www.LEGOsurvey.com/product, vul een enquêteformulier in en maak kans op een cool LEGO® product.

Geen aankoopverplichting. Iedereen mag deelnemen, uitgezonderd ingezetenden van landen waar een enquêteverbod geldt.

GAGNE!

Visite www.LEGOsurvey.com/product pour répondre à un questionnaire et avoir une chance de gagner un produit LEGO® très cool!

Aucune obligation d'achat. Ouvert à tous les résidents des pays autorisés.

当てよう!

www.LEGOsurvey.com/product にアクセスして、アンケートにご記入ください。当選者にはレゴ®製品を差し上げます。

お買い上げの必要はありません。禁止されていない限り、すべての皆様にご利用いただけます。