

LEGO

9480

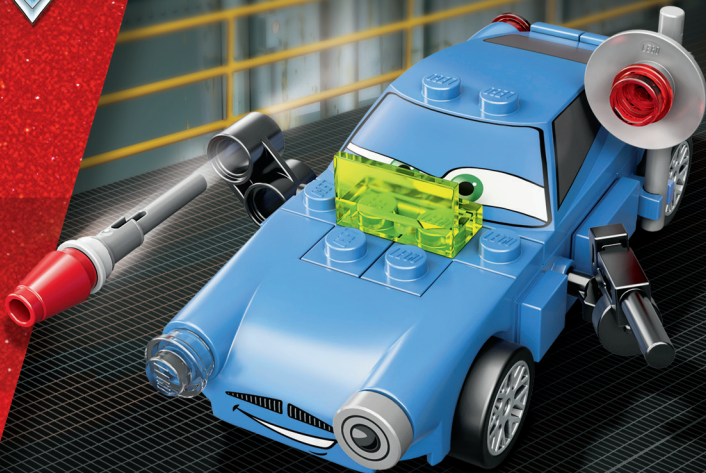

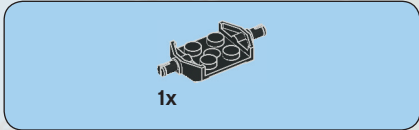
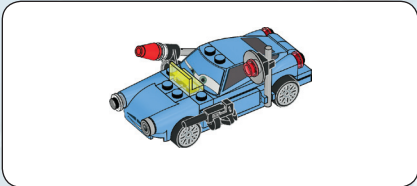

1



2

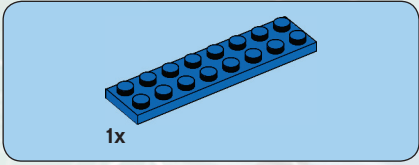

2

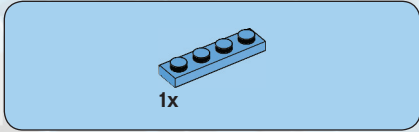
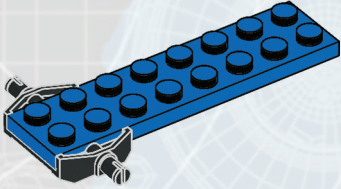

3

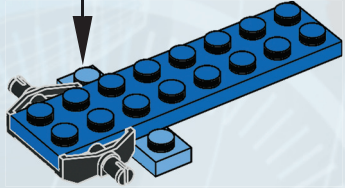
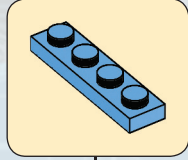

3

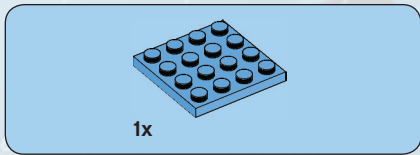

4

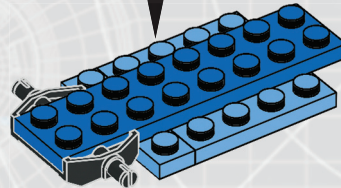
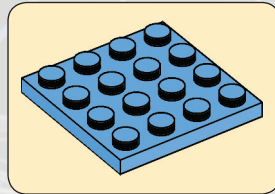

4

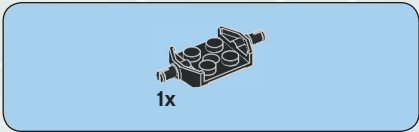

2

target
acquired

5

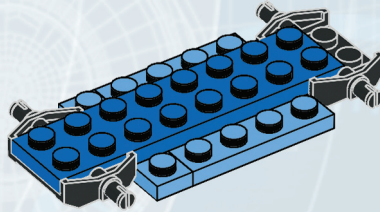

5



2x

6

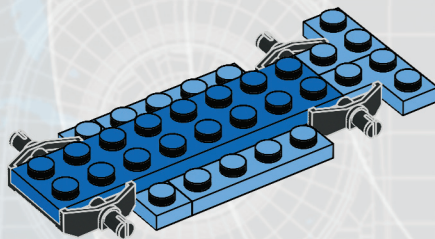

6

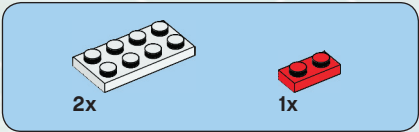

2

target
acquired

7

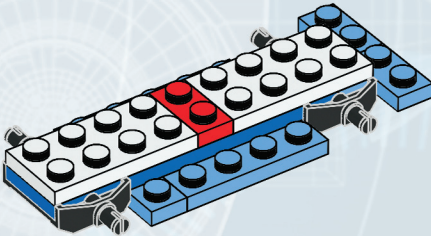

7

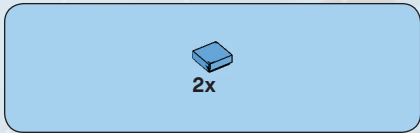

8

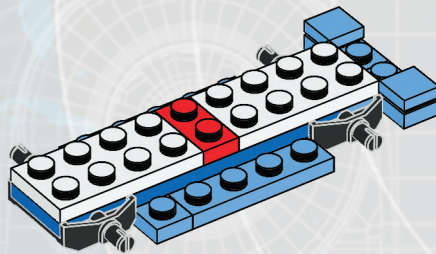

8

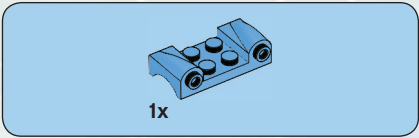

9

2 target acquired

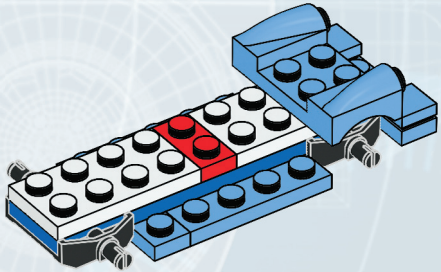

9



2x



2x

10

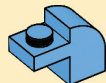

2x

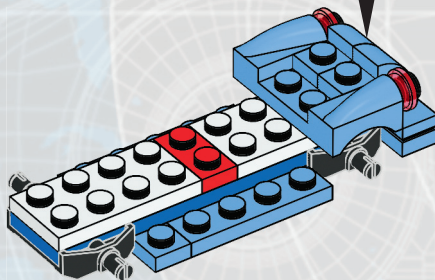

10

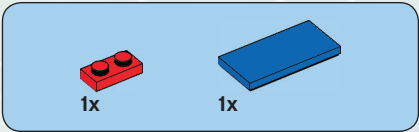

11

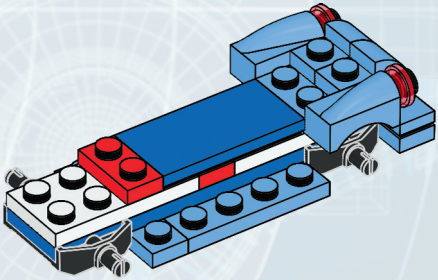

11

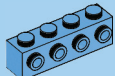

2x



2x

12

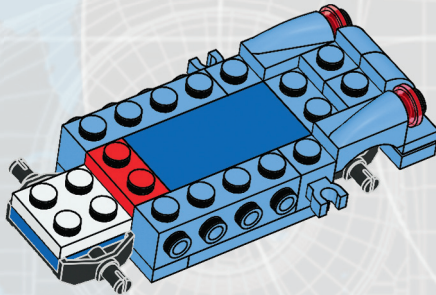

12

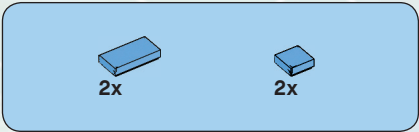

2

*target
acquired*

13

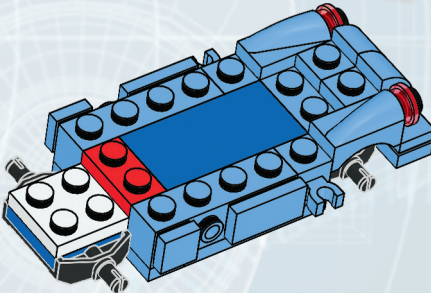

13



1x



1x

14

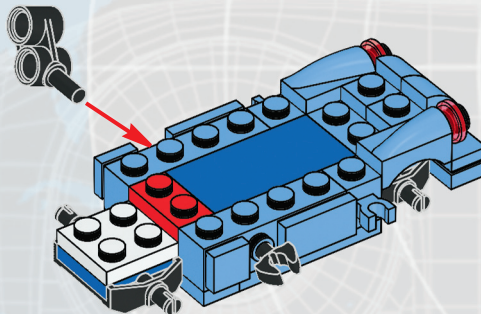

14

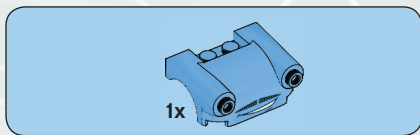

1x



*target
acquired*

15

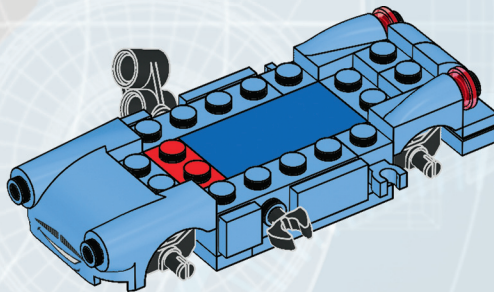

15

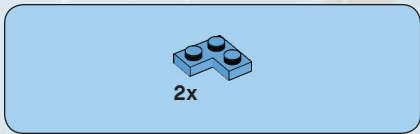

16

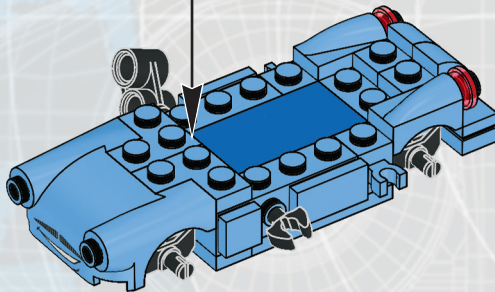
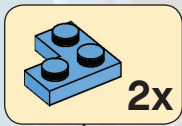

16

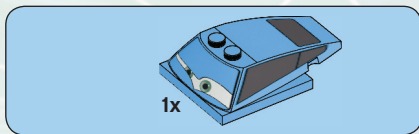

2

A white square box containing the number "2", indicating the quantity of parts to be used.

target
acquired

Stylized, semi-transparent text that reads "target acquired" in a light blue font, positioned in the upper right area of the page.

17

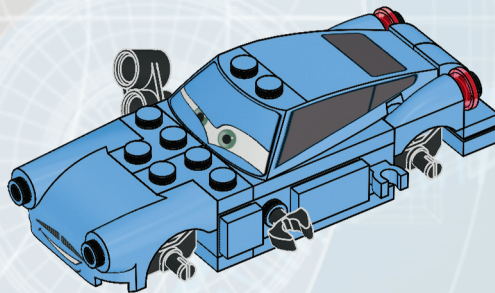
A large, bold black number "17" indicating the step number of the assembly instruction.

17

A smaller black number "17" located in the bottom right corner of the page.



1x



1x



1x

18

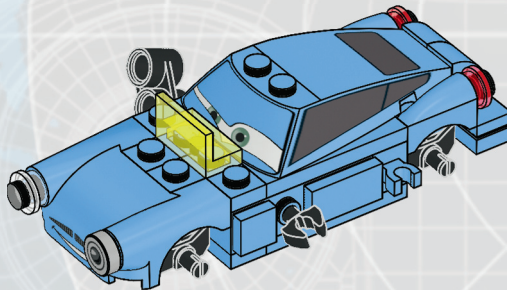

18

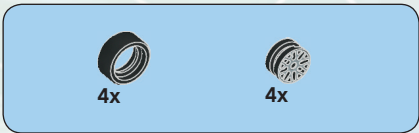

target
acquired

19

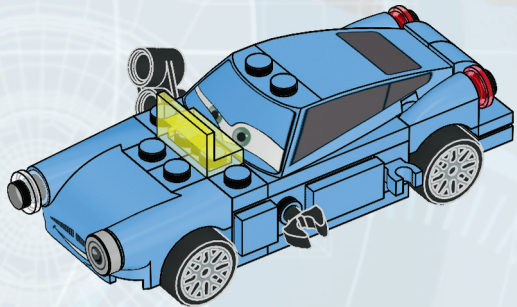

19

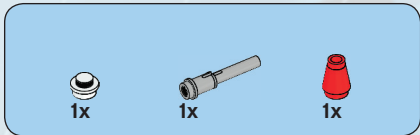

20

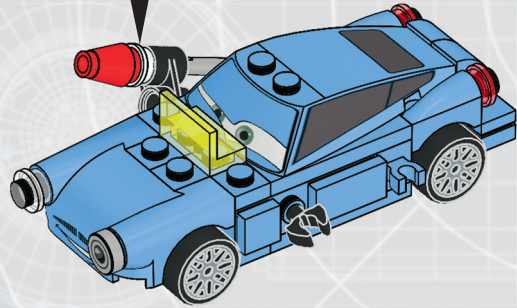
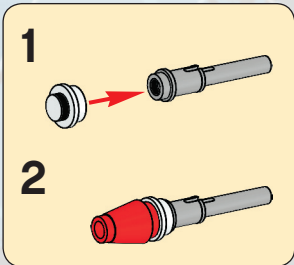

20

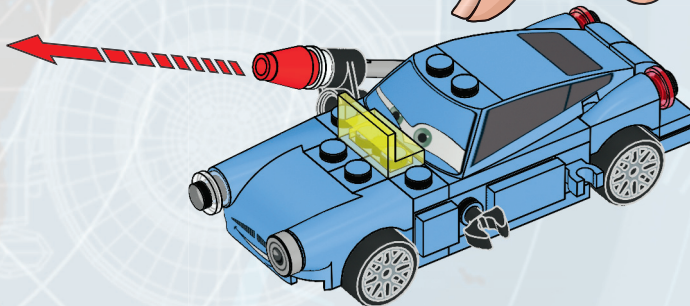

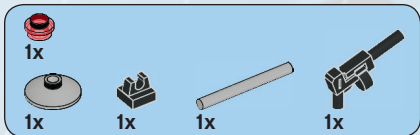

21

1

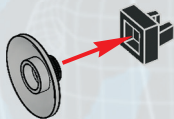

2



3

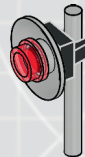

22

waypoint 2 target acquired

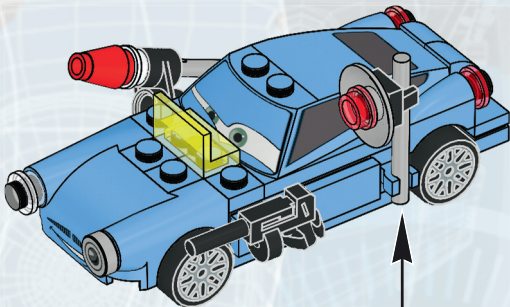



2x
302001



1x
614101



1x
4529234



2x
302321



1x
255526



Customer Service

Kundenservice

Service Consommateurs

Servicio Al Consumidor

www.lego.com/service or dial



00800 5346 5555 :



1-800-422-5346 :



1x
4560180



1x
303423



1x
4549989



4x
4246901



4x
4616406



2x
615726



1x
4289538



1x
4562148



1x
3005740



3x
3005741



1x
4655086



1x
4654781



2x
4650908



1x
4616408



4x
4527526



2x
4617019



4x
4598010



1x
4179828



2x
4651918



2x
4168345

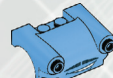

1x
4654784



1x
4622708



1x
4211512



1x
4653967



1x
4211628



1x
4520320

2011



8639



8423, 8639, 8679



8426



8487



8200, 8487



8487



8206, 8484, 8679



8206, 8679



8487



8424



8639



8423, 8679



8638



8638



8487



8638



8638



8638

2011



8201, 8487



8639



8639



8486



8426, 8639



8639



8426



8638



8486



8679



8679



8679



8679



8424

2012



9486



9485



9486



9481



9480



9483



9484



9485



9479



9484



9486



9483



9486



9485



9486



9485



9478



9484



9486



9486_BH.indd 23

23/08/2014 7:54:11 AM

LEGO.com/cars





www.LEGOclub.com



LEGO® Club Email

LEGO club™

FREE! GRATIS! GRATUIT!



LEGO® Club Magazine

SIGN UP ONLINE!

www.LEGOclub.com

00800 5346 5555*



1-866-534-6258 • 1-877-518-5346

US & Canada only

Canada seulement

B1110

- * Freephone. Mobile charges may apply.
- * Numéro sans frais. Des frais peuvent s'appliquer avec les téléphones cellulaires.
- * Gebührenfrei. Kosten für Anrufe aus Mobilfunknetzen können abweichen.
- * Gratis telefonnummer vanaf vaste lijn.
- * Det er et gratis nummer, når du ringer fra fasttelefon.
- * Det är gratis, när du ringer från en fast telefon.
- * Numéro sans frais. Des frais peuvent s'appliquer avec les téléphones portables.



WIN!

Go to www.LEGOsurvey.com/product to fill out a survey for a chance to win a cool LEGO® Product.
No purchase necessary.
Open to all residents where not prohibited.



www.LEGOsurvey.com/product

GEWINNE!

Nimm an der Umfrage auf www.LEGOsurvey.com/product teil und hab die Chance ein cooles LEGO® Produkt zu gewinnen!
Die Teilnahme am Gewinnspiel führt zu keinerlei Kaufverpflichtungen.
Teilnahme in allen nicht ausgeschlossenen Ländern möglich.



www.LEGO.com

6003652

WIN!

Ga naar www.LEGOsurvey.com/product, vul een enquêteformulier in en maak kans op een cool LEGO® product.
Geen aankoopverplichting, iedereen mag deelnemen, uitgezonderd ingezetenden van landen waar een enquêteverbod geldt.

GAGNE!

Visite www.LEGOsurvey.com/product pour répondre à un questionnaire et avoir une chance de gagner un produit LEGO® très cool!
Aucune obligation d'achat.
Ouvert à tous les résidents des pays autorisés.

当てよう!

www.LEGOsurvey.com/product にアクセスして、アンケートにご記入ください。
当選者にはレゴ製品を差し上げます。
お買い上げの必要はありません。
禁止されていない限り、すべての皆様にご利用いただけます。

LEGO and the LEGO logo are trademarks of the LEGO Group.
©2012 The LEGO Group. © Disney/Pixar