

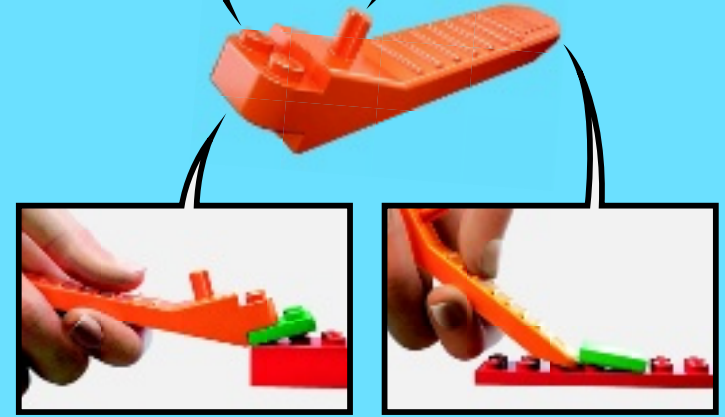

THE LEGO MOVIE

70815

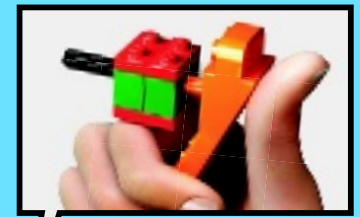

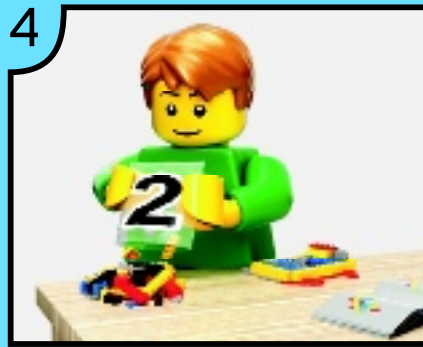

LEGO.com/brickseparator

EN IMPORTANT: Never modify the elements or use other projectiles than provided with this toy.
 DE WICHTIG: Die Elemente dürfen nicht verändert werden. Es dürfen ausschließlich die mit dem Spielzeug mitgelieferten Geschosse verwendet werden.
 FR IMPORTANT : Ne jamais modifier les éléments ni utiliser d'autres projectiles que ceux fournis avec ce jouet.
 IT IMPORTANTE: non modificare gli elementi o utilizzare proiettili non forniti con questo prodotto.
 NL BELANGRIJK! Verander niets aan de elementen en gebruik geen andere projectielen dan de bij het speelgoed geleverde.
 ES IMPORTANTE: No modifique los elementos ni utilice otros proyectiles diferentes a los suministrados junto con este juguete.
 DA VIGTIGT: Elementerne må ikke ændres, og der må ikke bruges andre projektiler end dem, der følger med legetøjet.
 FI TÄRKEÄÄ: Älä koskaan tee osiin muutoksia tai käytä lelussa muita kuin sen sisältyviä ammuksia.
 SV VIKTIGT: Modifera aldrig delarna och använd aldrig andra projektiler än de som medföljer denna leksak.
 PT IMPORTANTE: Nunca modifique os elementos nem utilize projecteis que não tenham sido fornecidos com este brinquedo.
 EL ΣΗΜΑΝΤΙΚΟ: Ποτέ μην τροποποιείτε τα στοιχεία του παιχνιδιού και μην χρησιμοποιείτε άλλα βλήματα εκτός από αυτά που συνοδεύουν αυτό το παιχνίδι.
 JA 重要： 部品を改造したり、本製品に付属の発射体以外のものを使用しないようにしてください。
 ZH 重要提示： 切勿更改组件或使用并非由本玩具附带的弹丸。
 KO 중요함: 이들 부품을 수정하거나 이 완구와 함께 제공된 것이 아닌 발사체는 결코 사용하지 마십시오.
 RU ВАЖНО: запрещается вносить изменения в элементы или использовать другие снаряды, отличные от тех, которые поставляются с данной игрушкой.
 PL WAŻNE: Nigdy nie modyfikować elementów zabawki ani nie używać pocisków innych niż dostarczone z zabawką.
 CZ UPOZORNĚNÍ: Nikdy neupravujte součástky a nepoužívejte jiné projektily než ty, které jsou dodávány s touto hračkou.
 SK UPOZORNENIE: Nikdy neupravujte súčiastky a nepoužívajte iné projektily než tie, ktoré sú dodávané s touto hračkou.
 HU FONTOS: Az elemeket nem szabad módosítani, és a játékhoz adott lövedékek helyett sem szabad másat használni.
 UA ВАЖЛИВО: забороняється вносити зміни до елементів або використовувати інші снаряди на відміну від тих, що поставляються з цією іграшкою.
 HR VAŽNO: Nemojte nikad mijenjati elemente ili koristiti druge projektile osim onih koji su bili priloženi uz ovu igračku prilikom kupnje.
 SR Важно: Немојте да модификујете елементе и не користите друге пројектиле осим оних који долазе уз ову играчку.
 SL POMEMBNO: Nikoli ne spremenjajte elementov in uporabljajte le izstrelke, ki so bili priloženi tej igrači.
 RO IMPORTANT: Nu modificați niciodată elementele și nu utilizați alte proiectile decât cele furnizate cu această jucărie.
 BG ВАЖНО: Не видоизменяйте елементите и не използвайте други снаряди освен приложените към тази играчка.
 LV SVARĪGI! Nekad nepārveidojiet rotallietas elementus, vienmēr izmantojiet tikai tās komplektā iekļautās lodītes.
 ET OLULINE: Mänguasja osi ei tohi teistega asendada, kasutada võib ainult kaasasolevat heitkeha.
 LT DĖMESIO! Niekuomet nekeiskite elementų ir naudokite tik tuos šovinius, kurie yra pridėti prie šio žaislo.
 TR ÖNEMLİ: Hiçbir zaman parçalarda değişiklik yapmayın veya bu oyuncakla sağlananlar dışında mermiler kullanmayın.



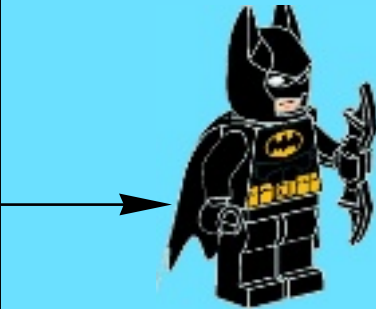
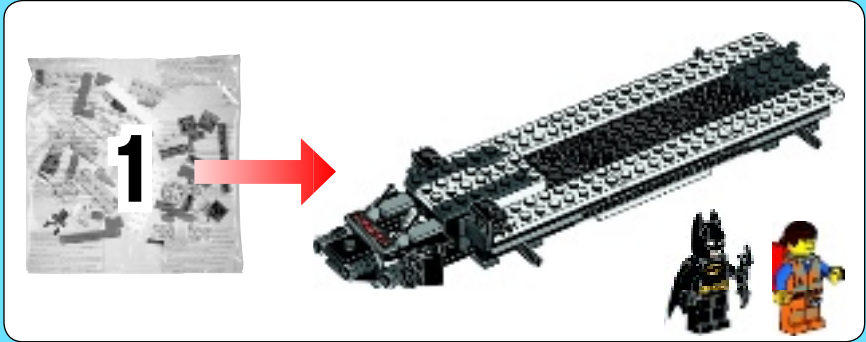

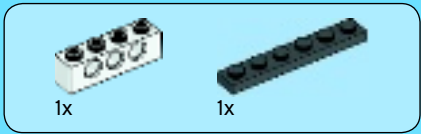
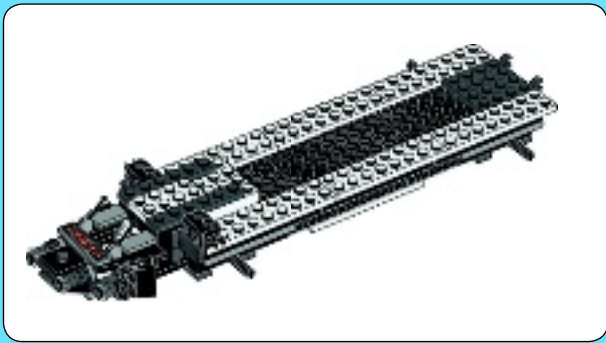

1

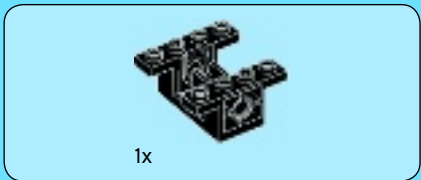
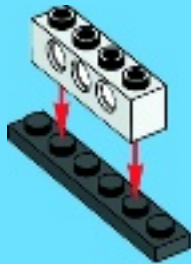

2

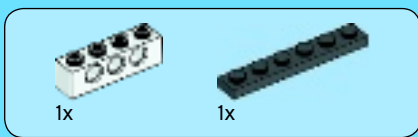

3

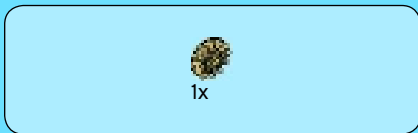
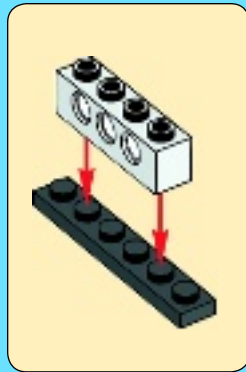

4



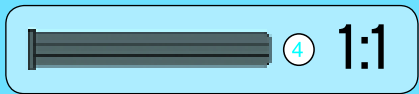
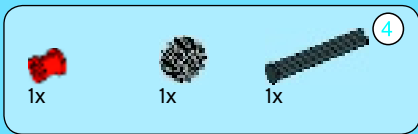

5

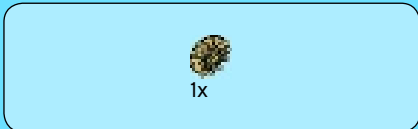
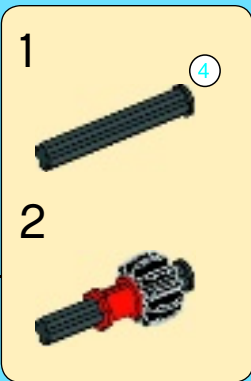

6

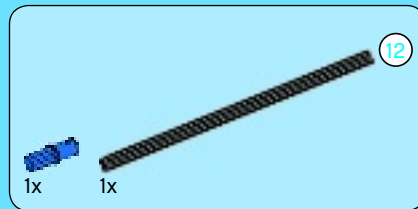

7

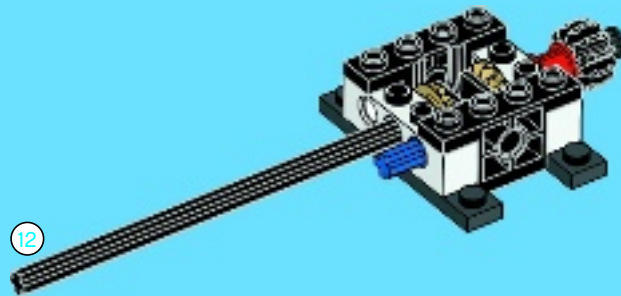

8

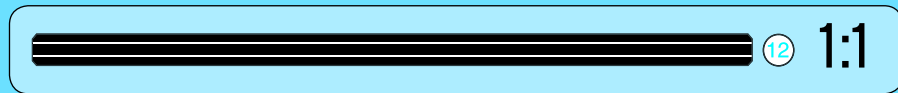
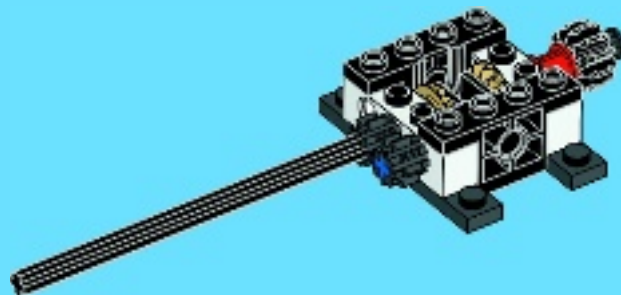

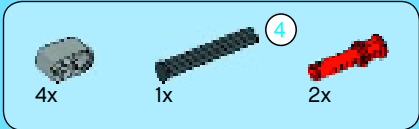

9

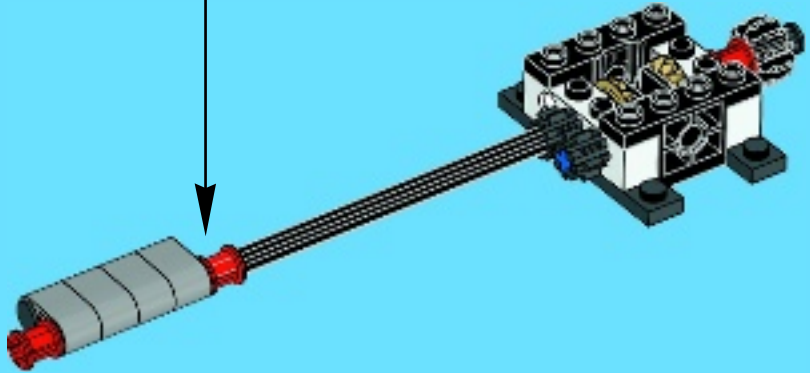
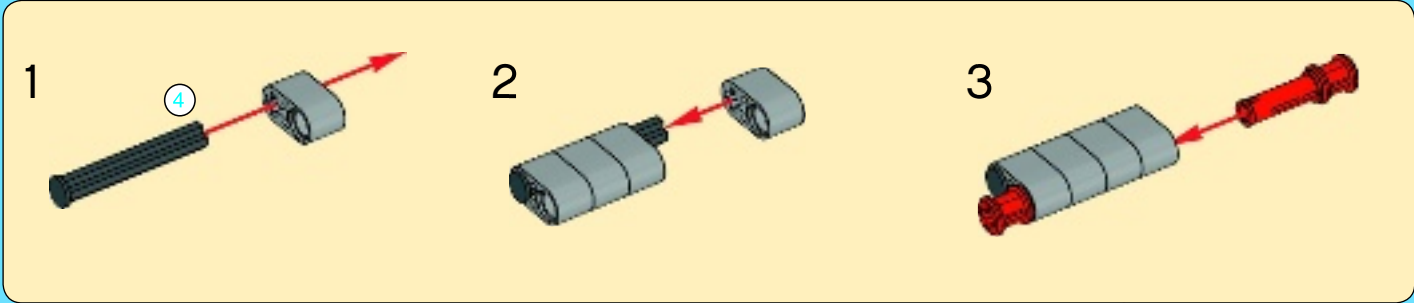

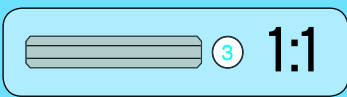
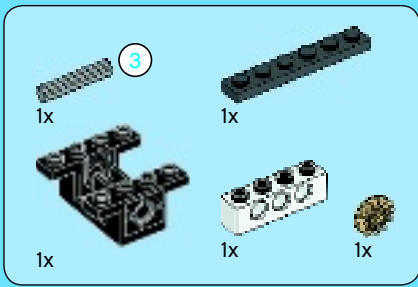

10

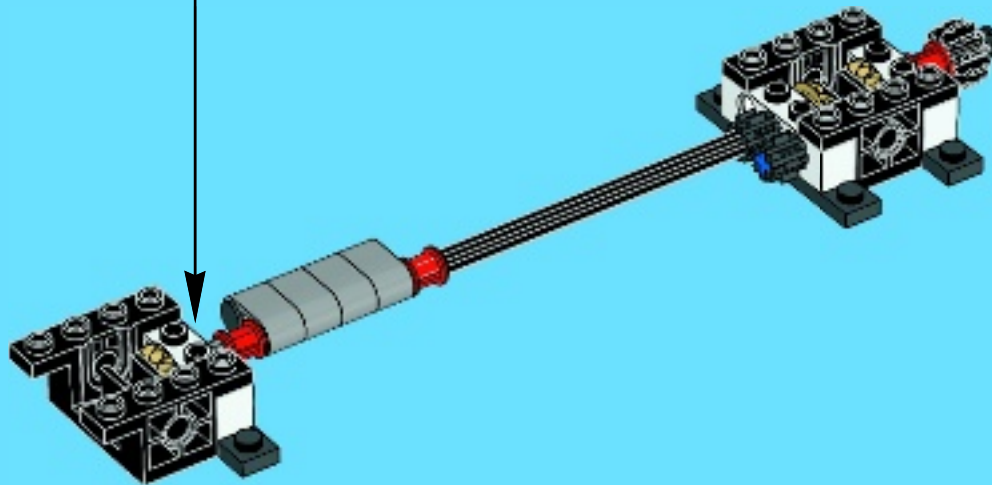
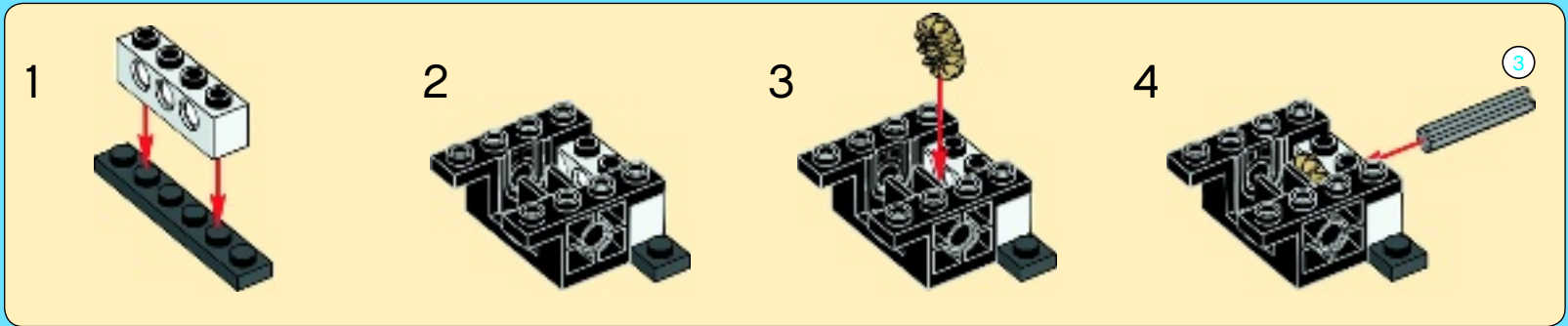

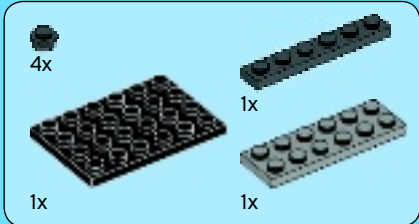

11

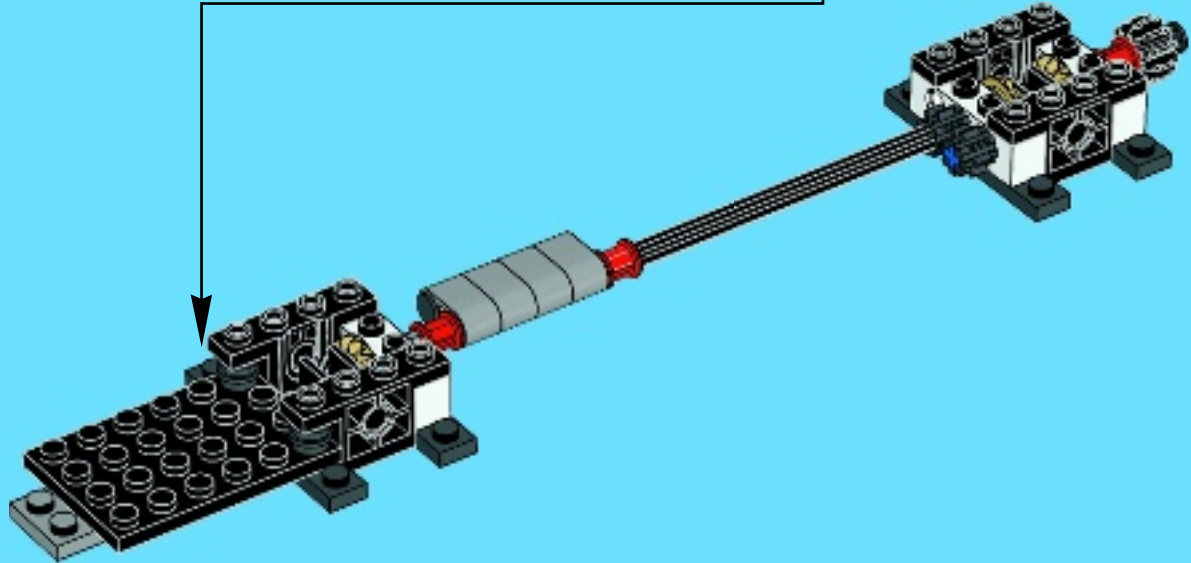
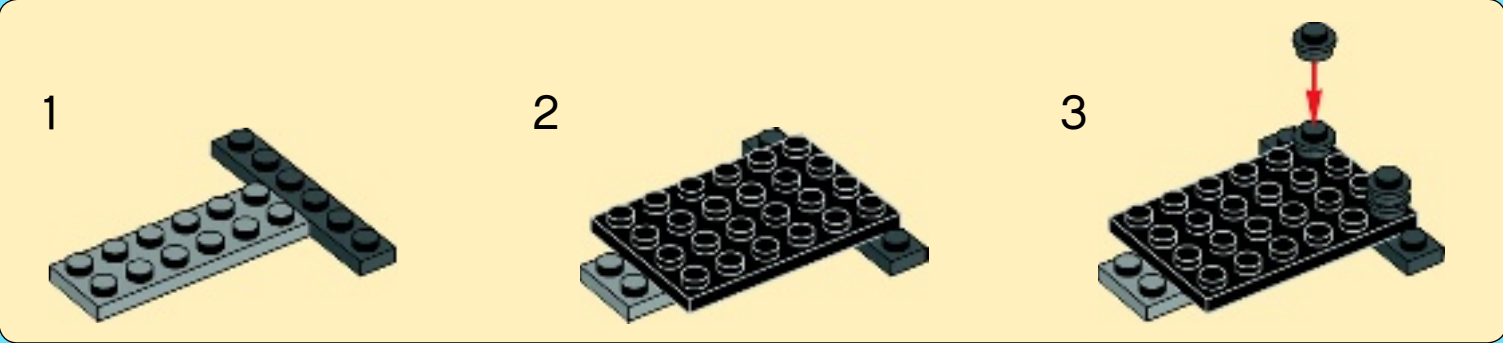

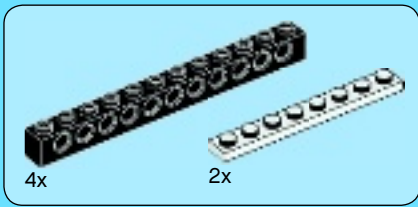

12

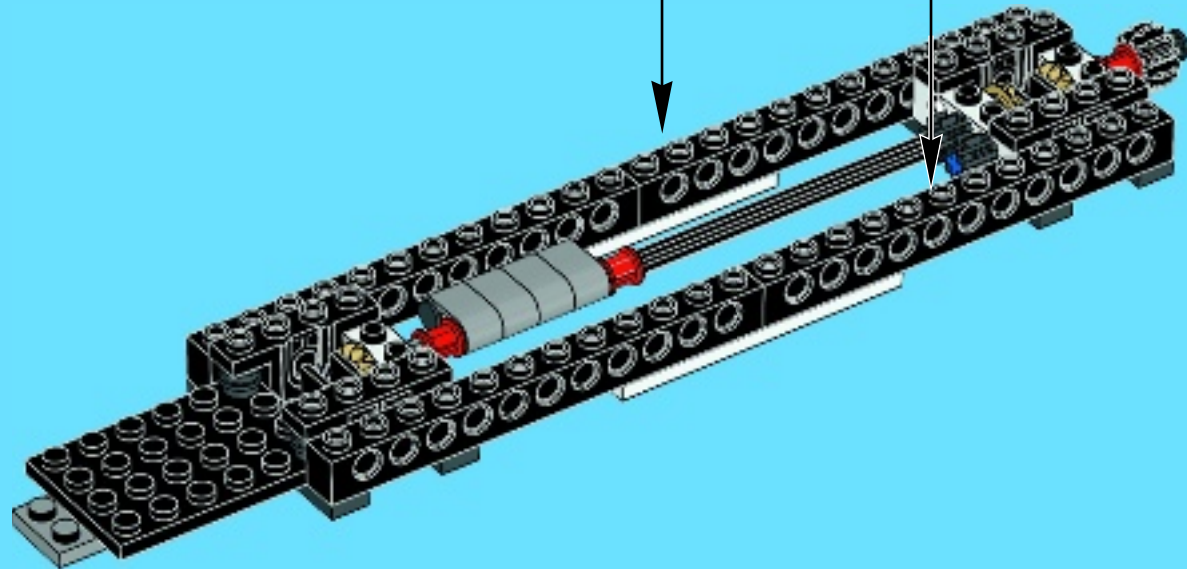
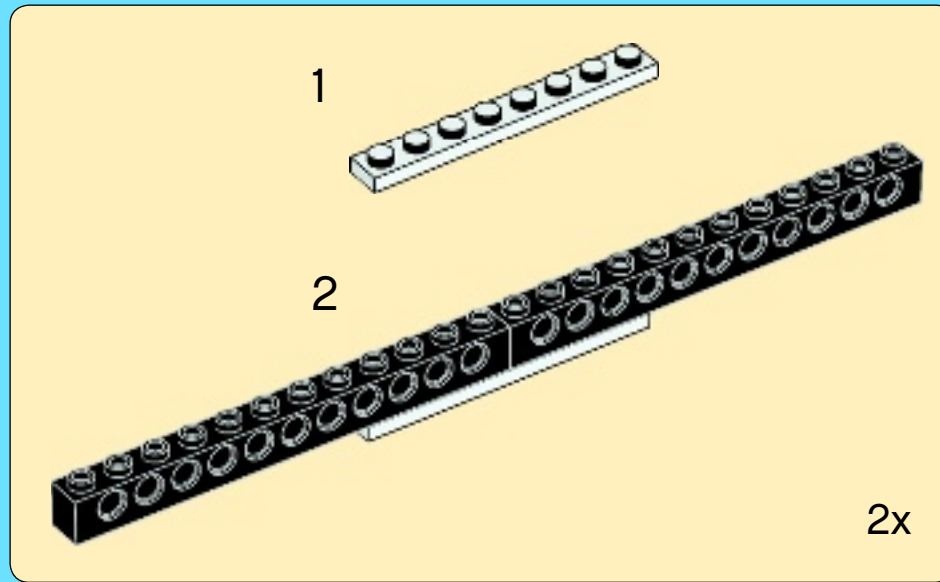

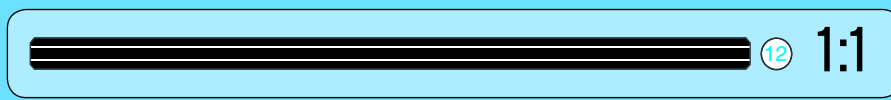
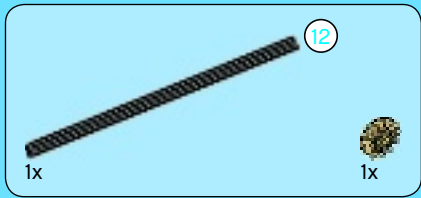

13

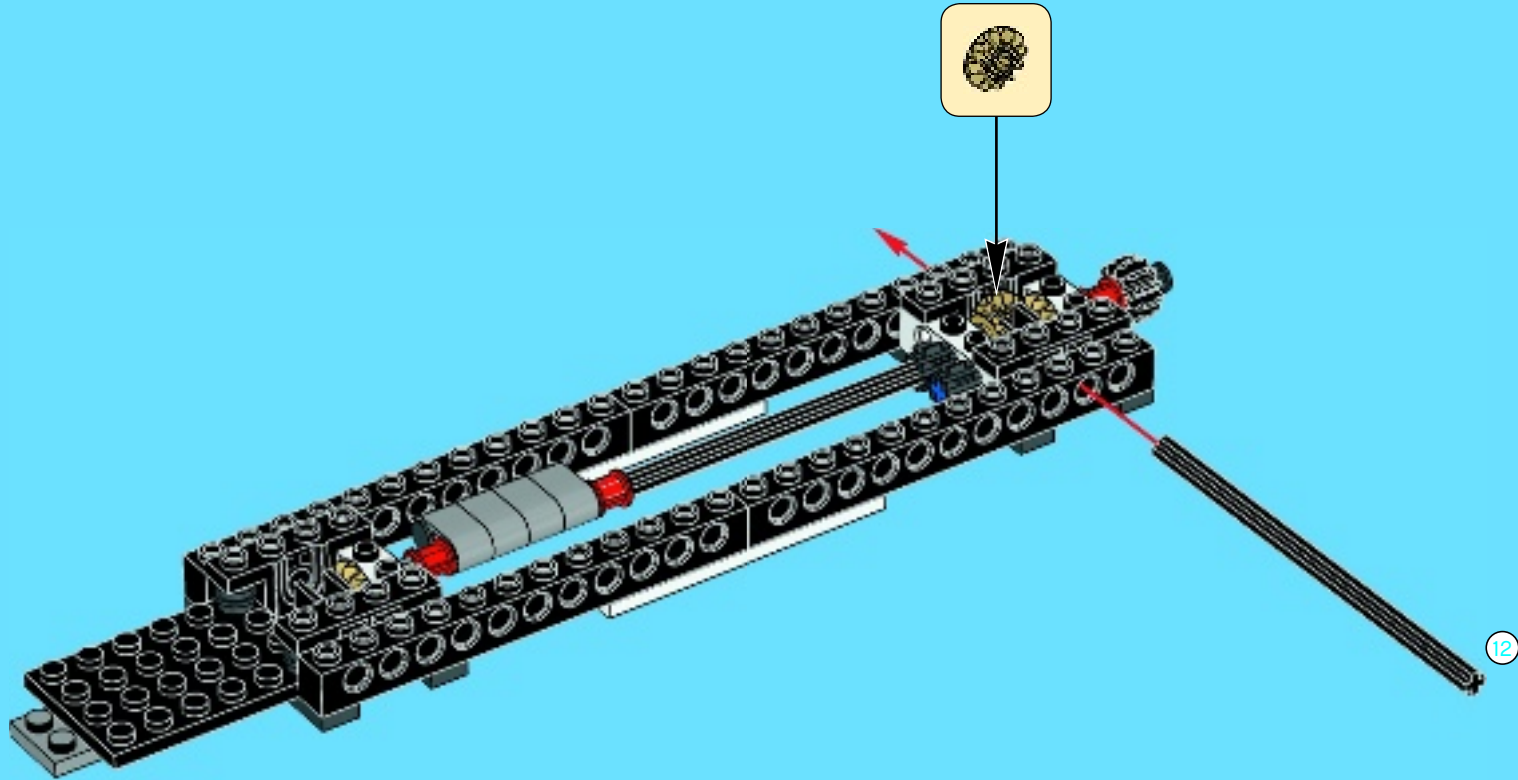

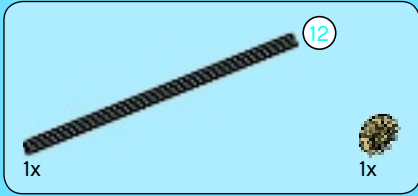

14

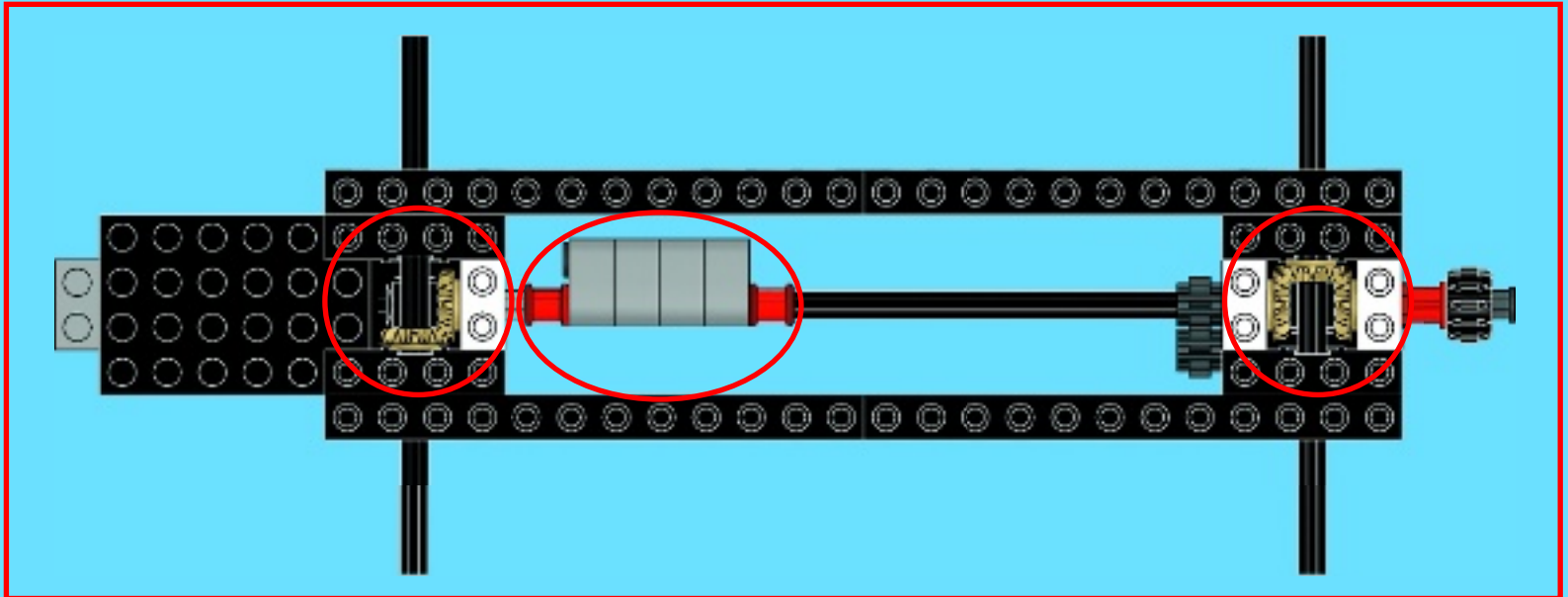
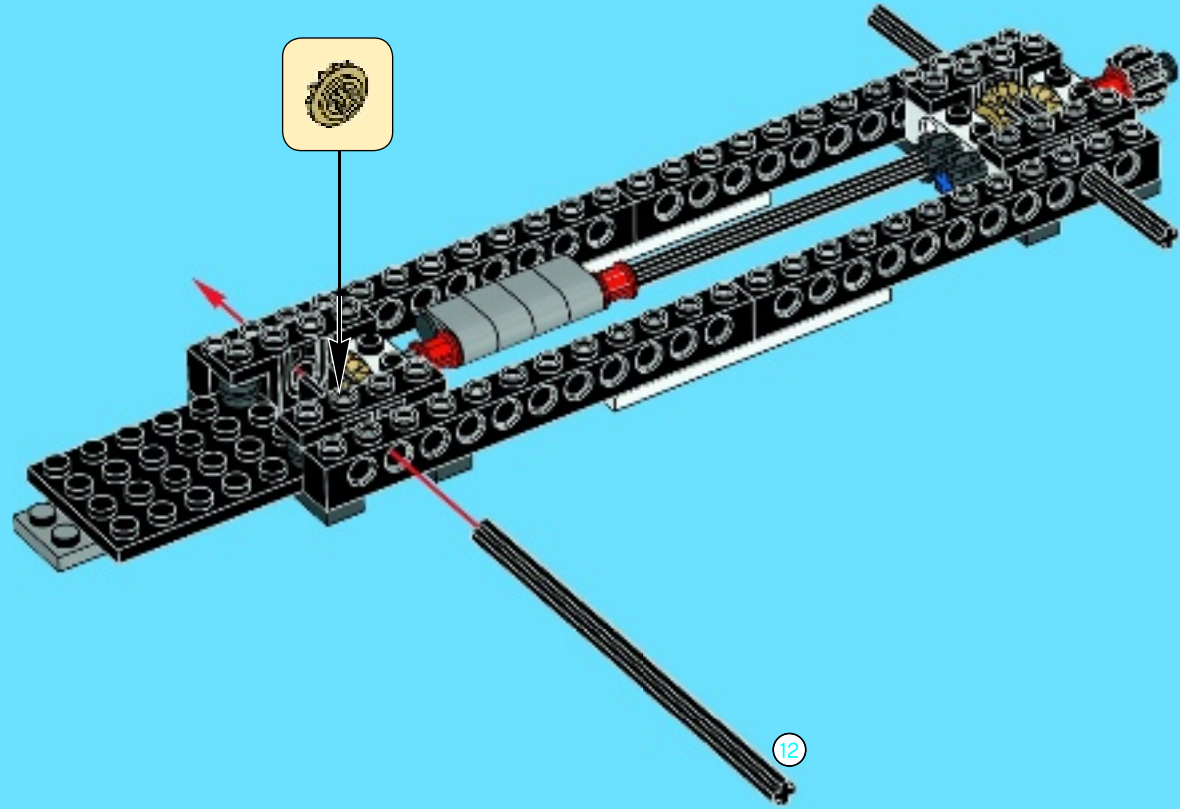



2x

15

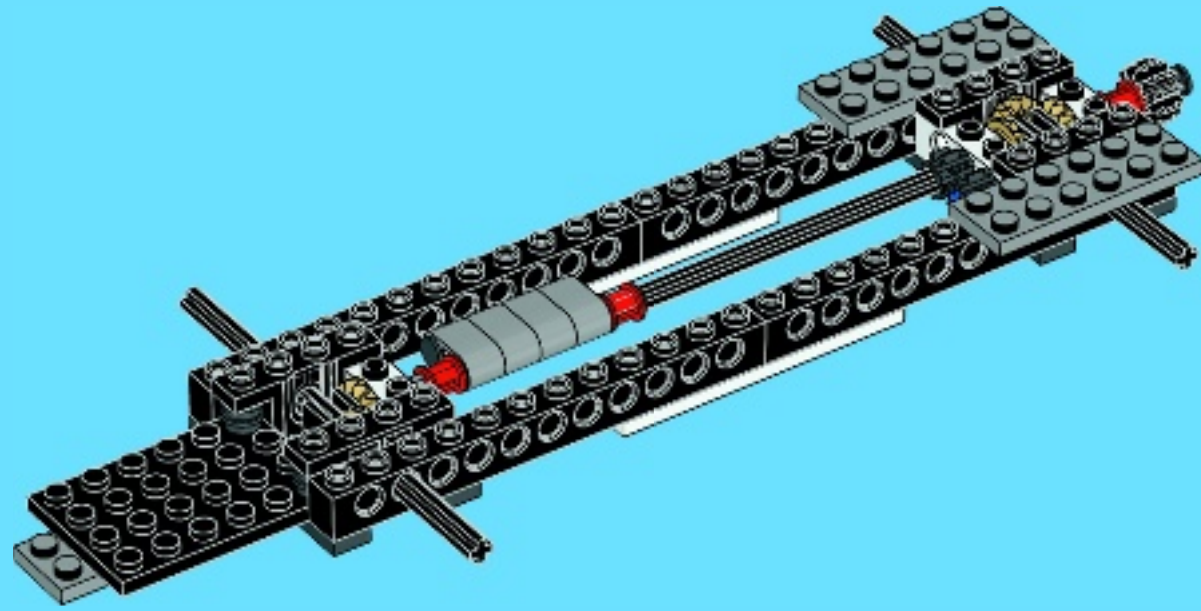

16

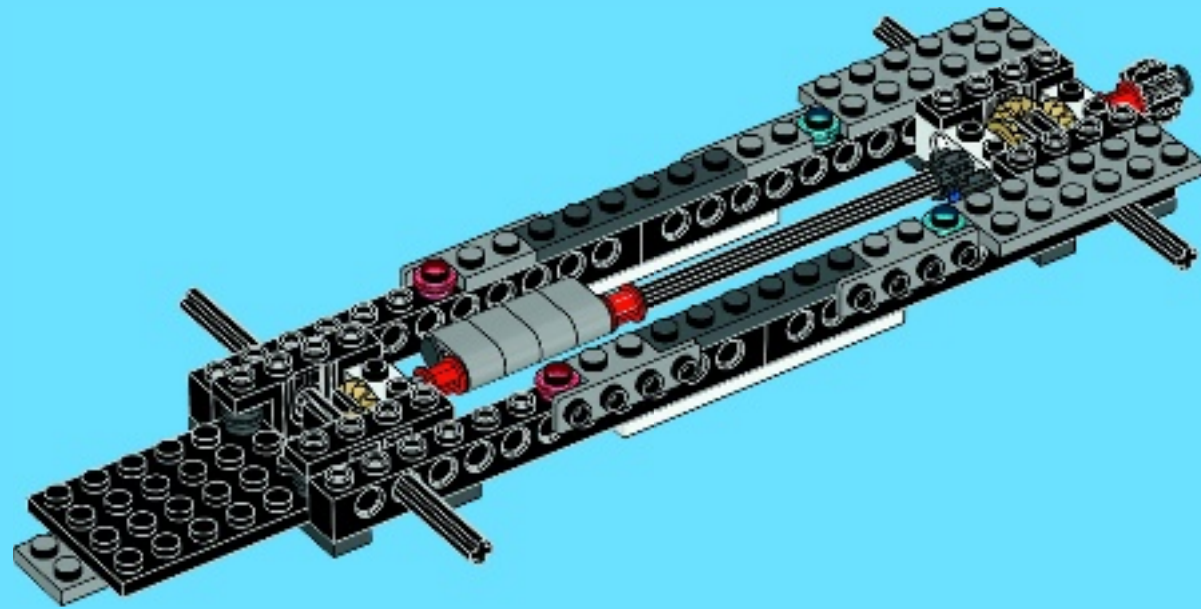



17

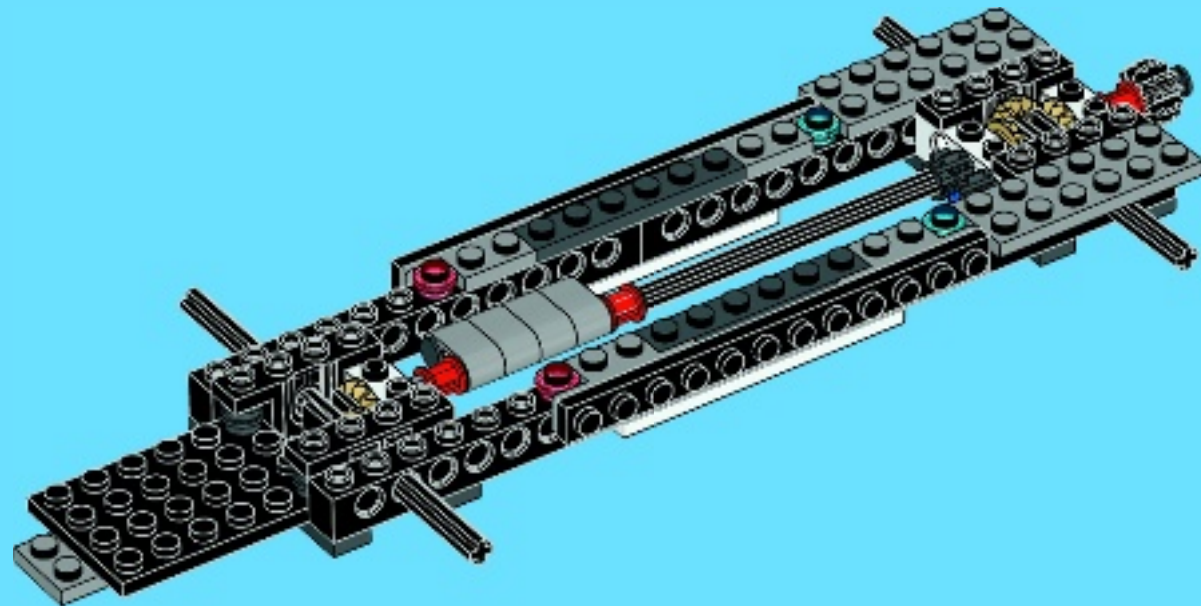

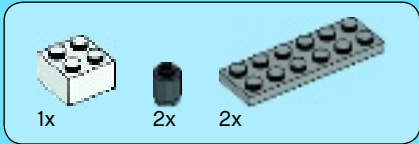

18

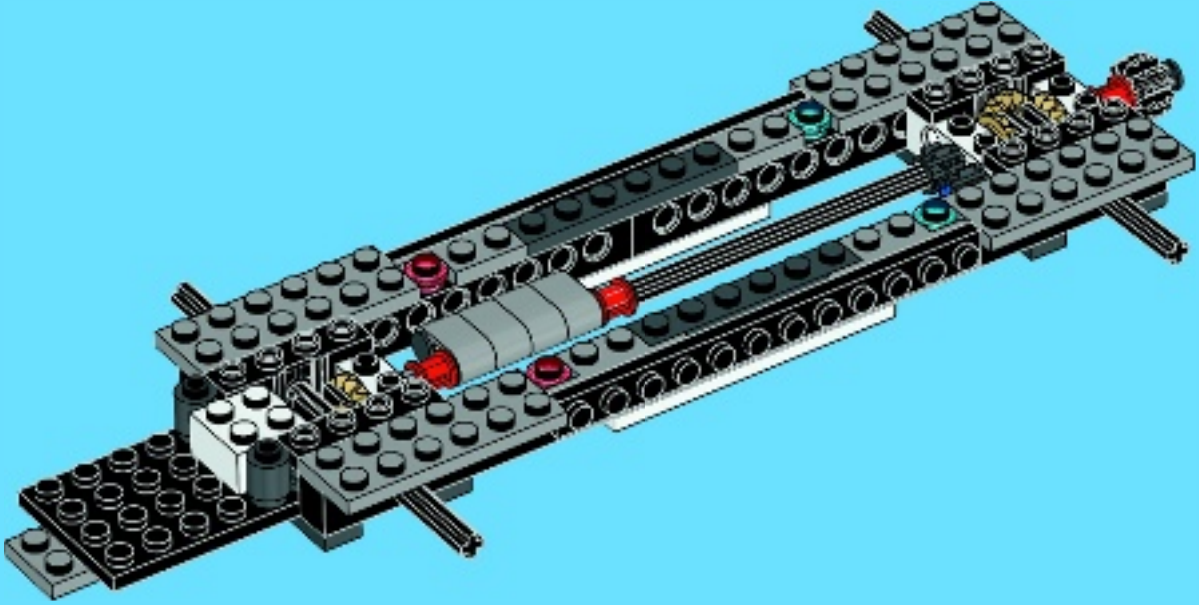

19

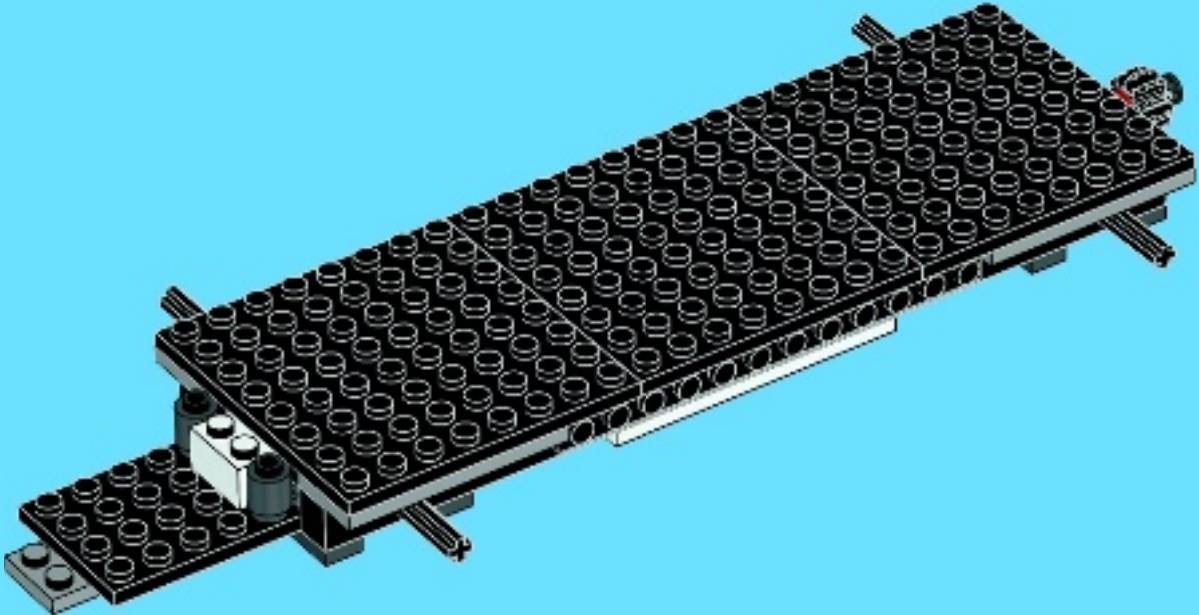

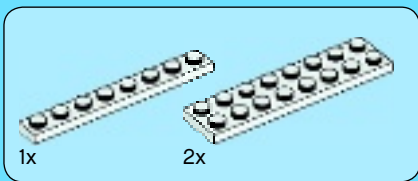

20

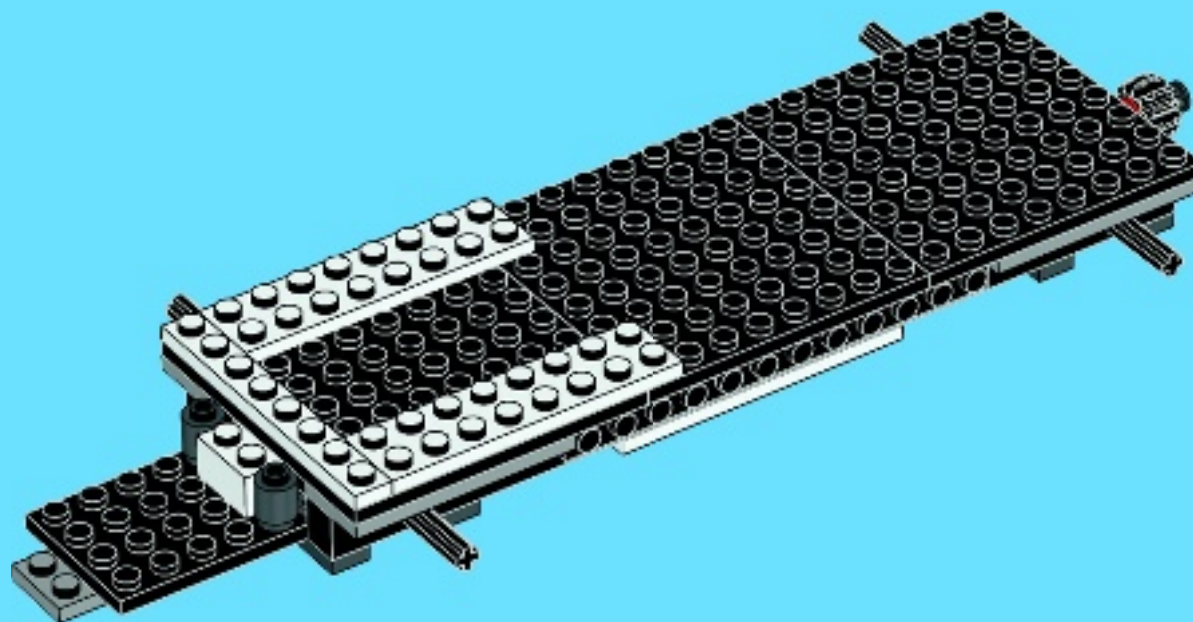

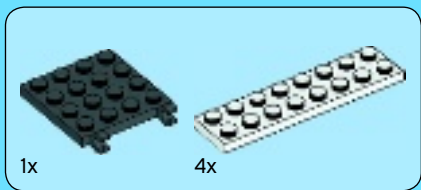

21

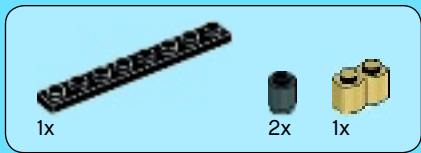
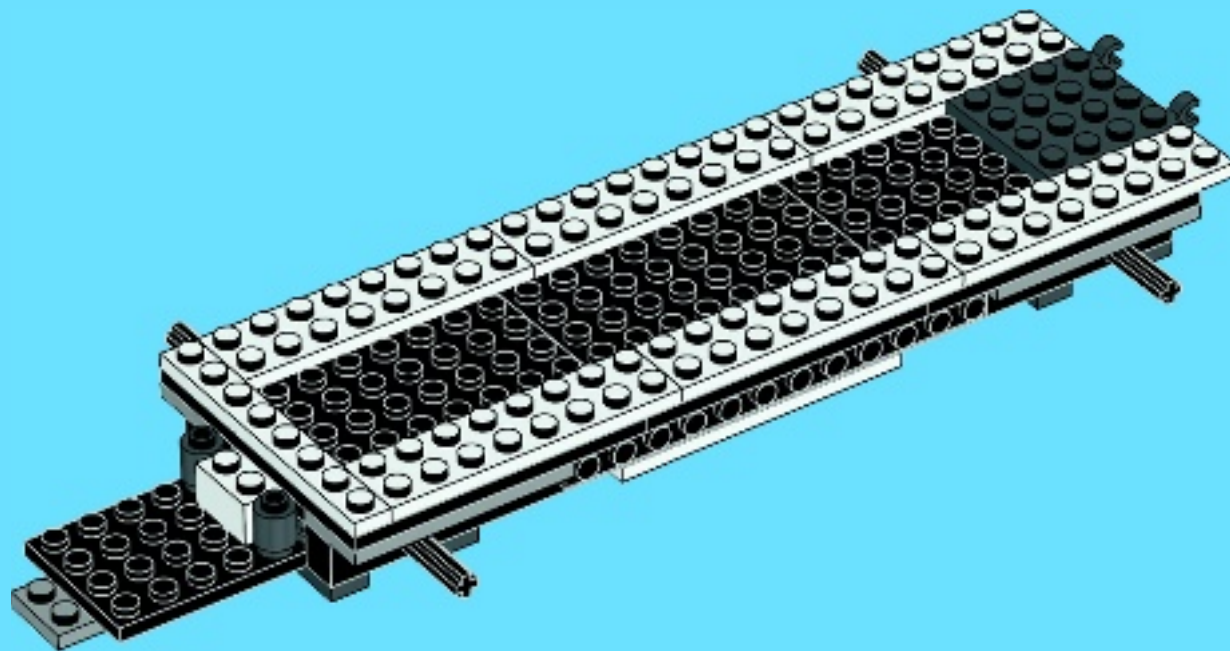

22

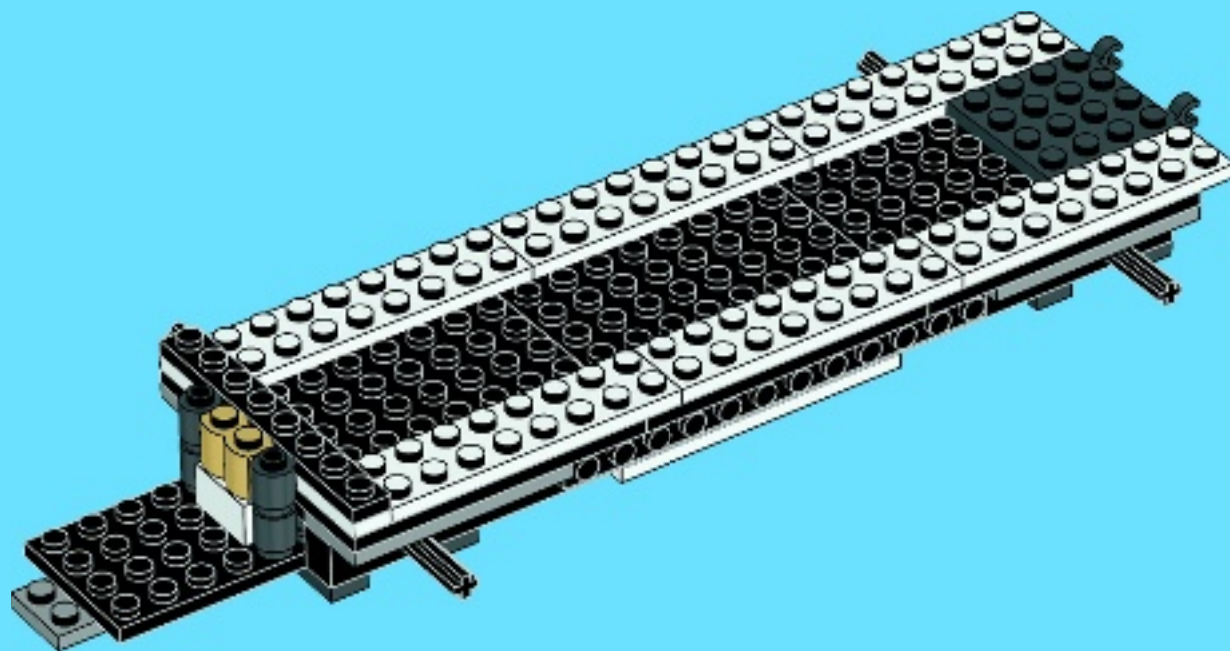



23

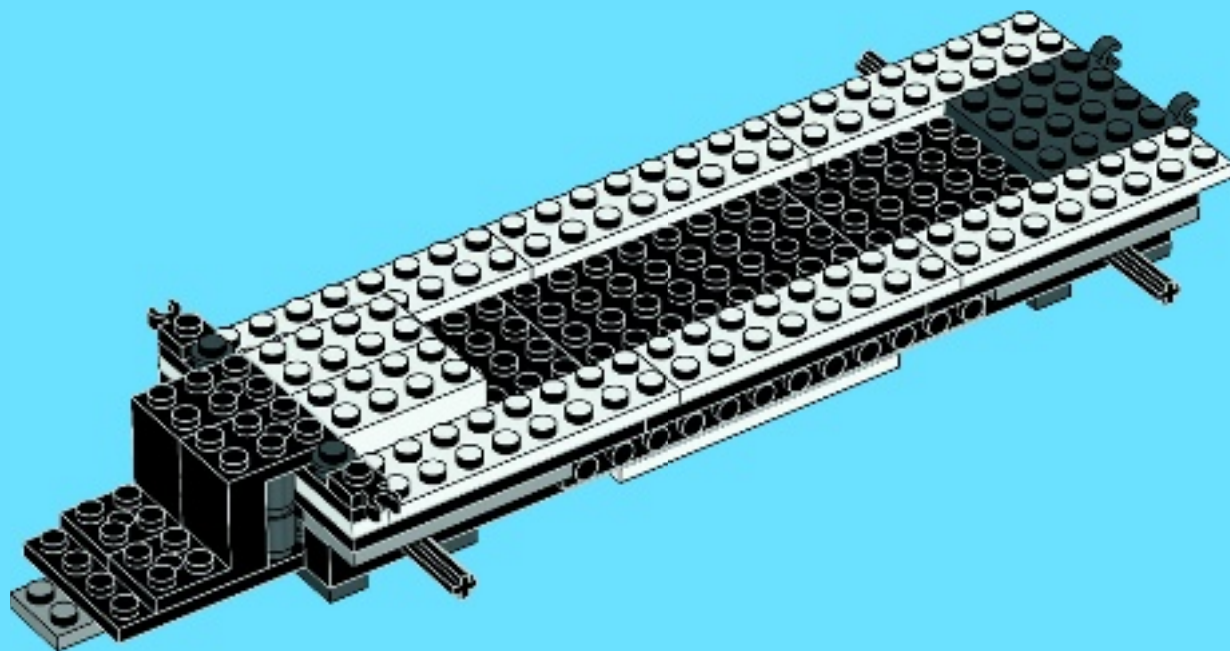

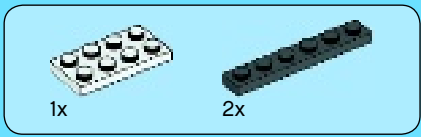

24

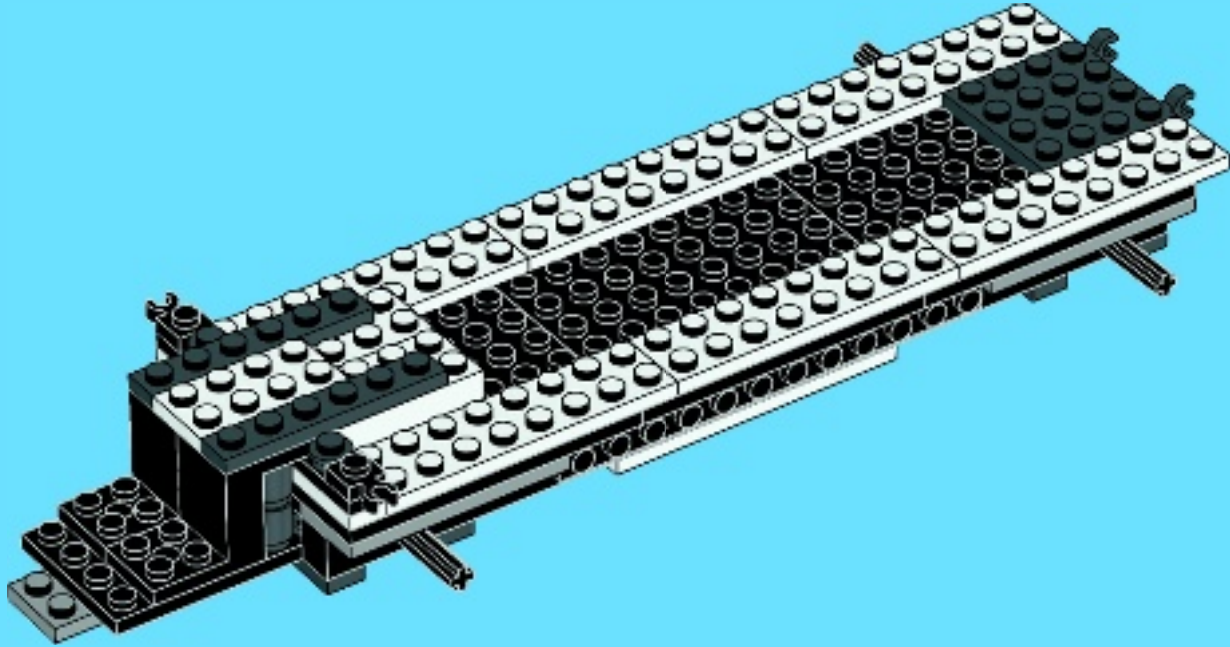

25

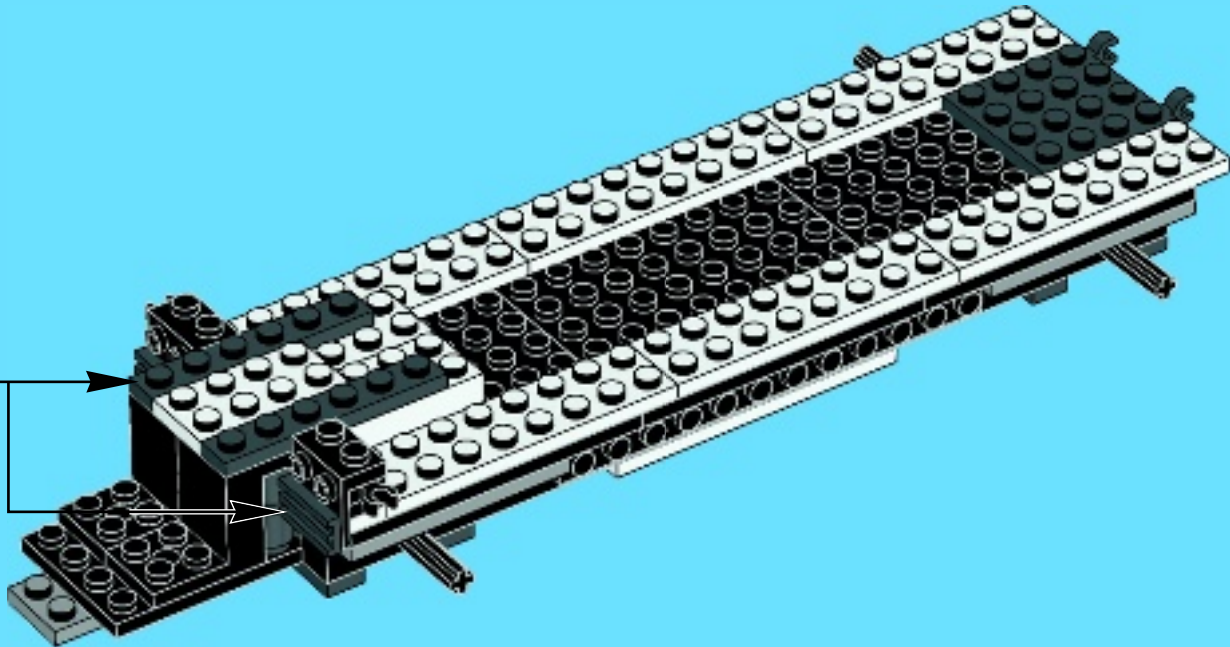
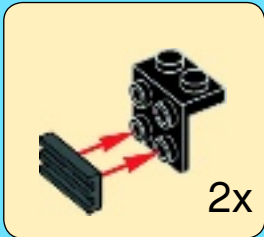



1x



2x



2x

26

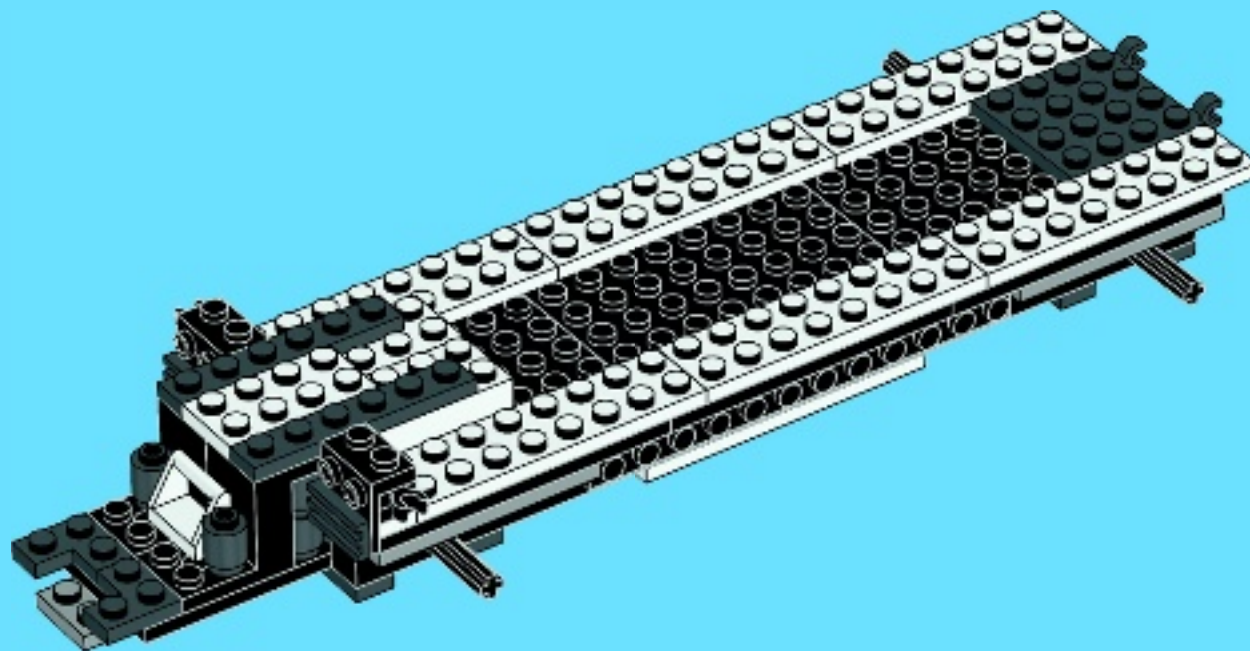



1x



1x

27

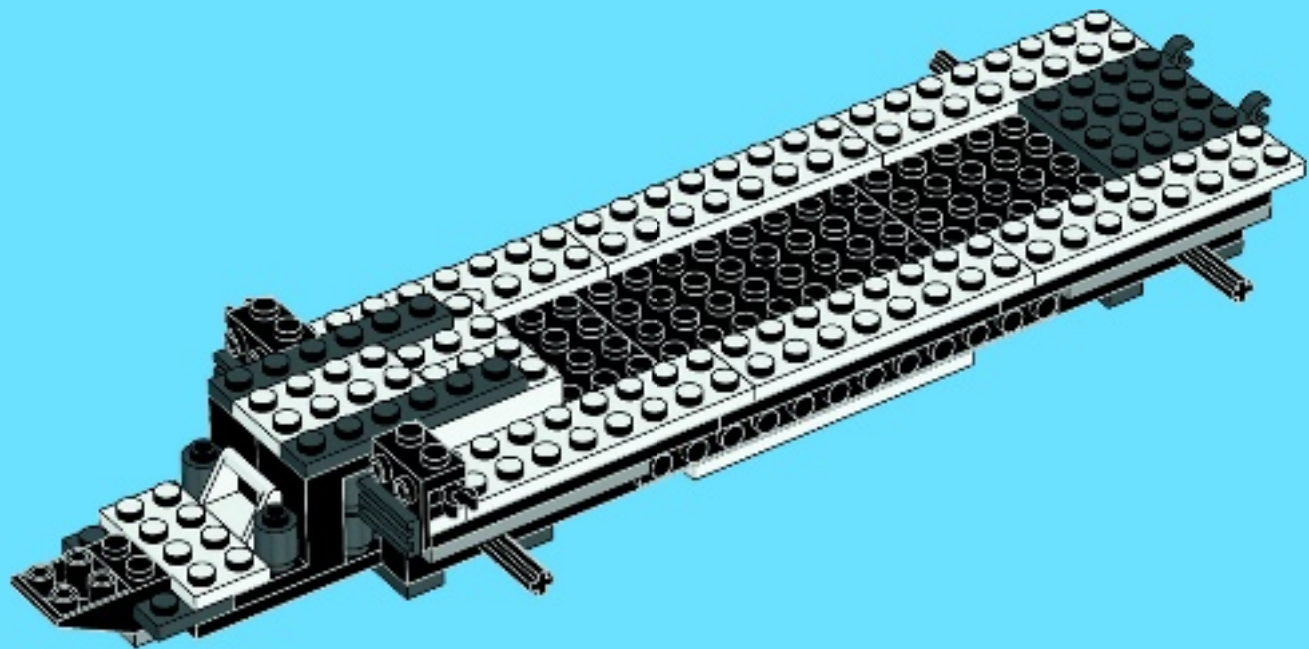

2x



2x

28

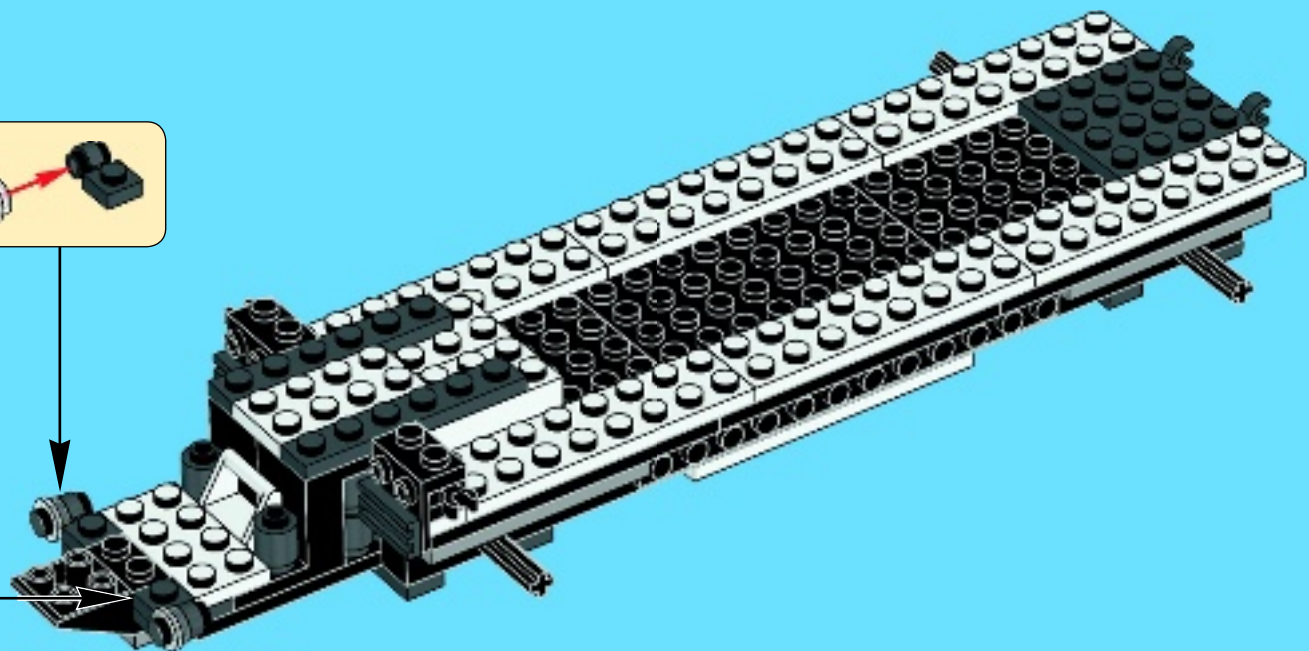
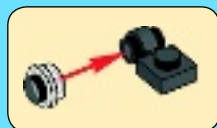



2x



2x

29

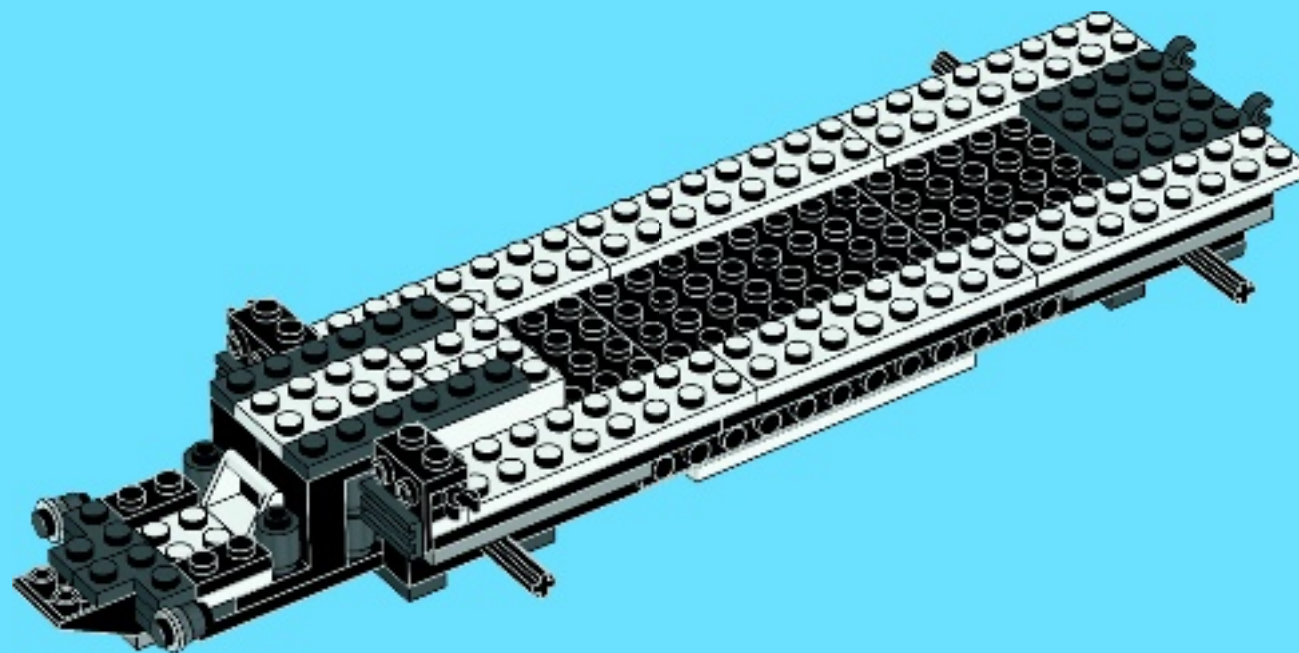

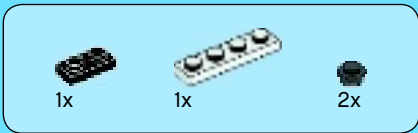

31

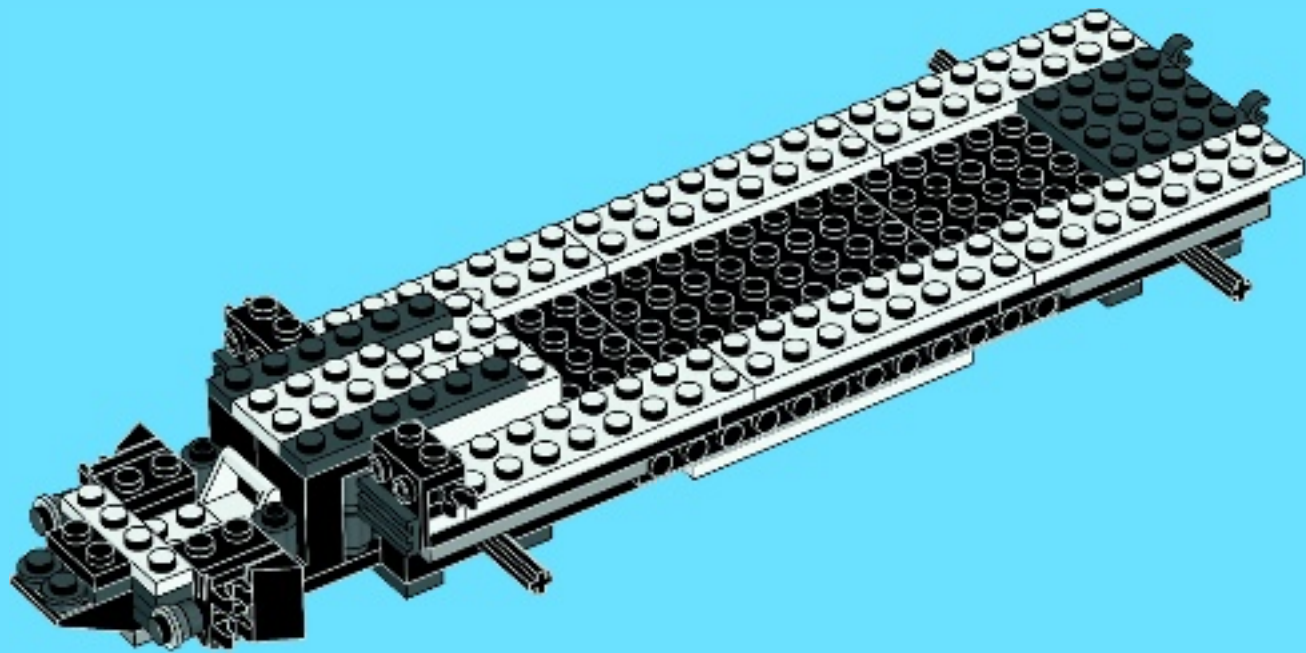



4x



2x



2x



2x

32

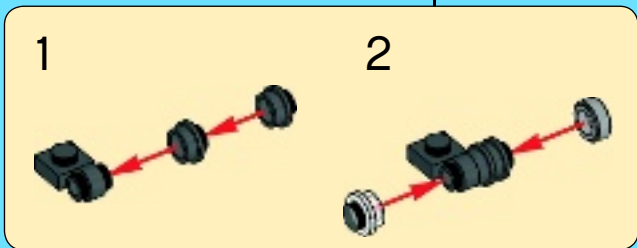
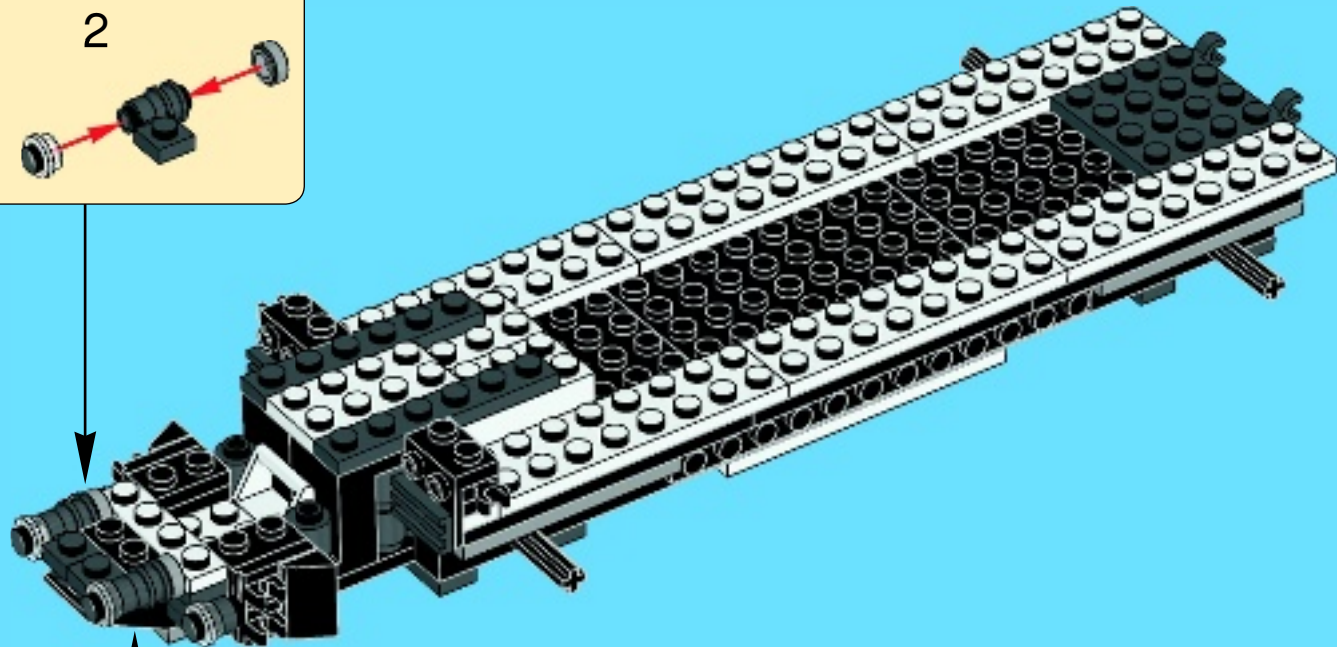
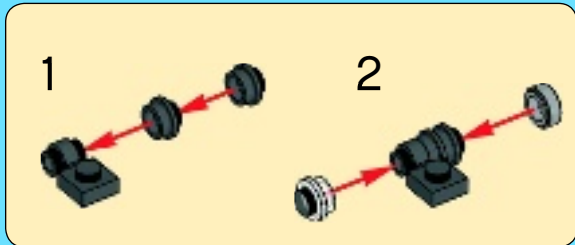

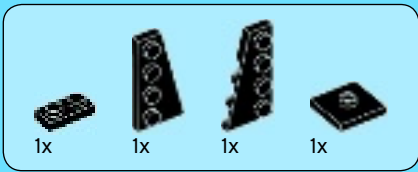

33

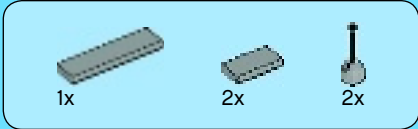
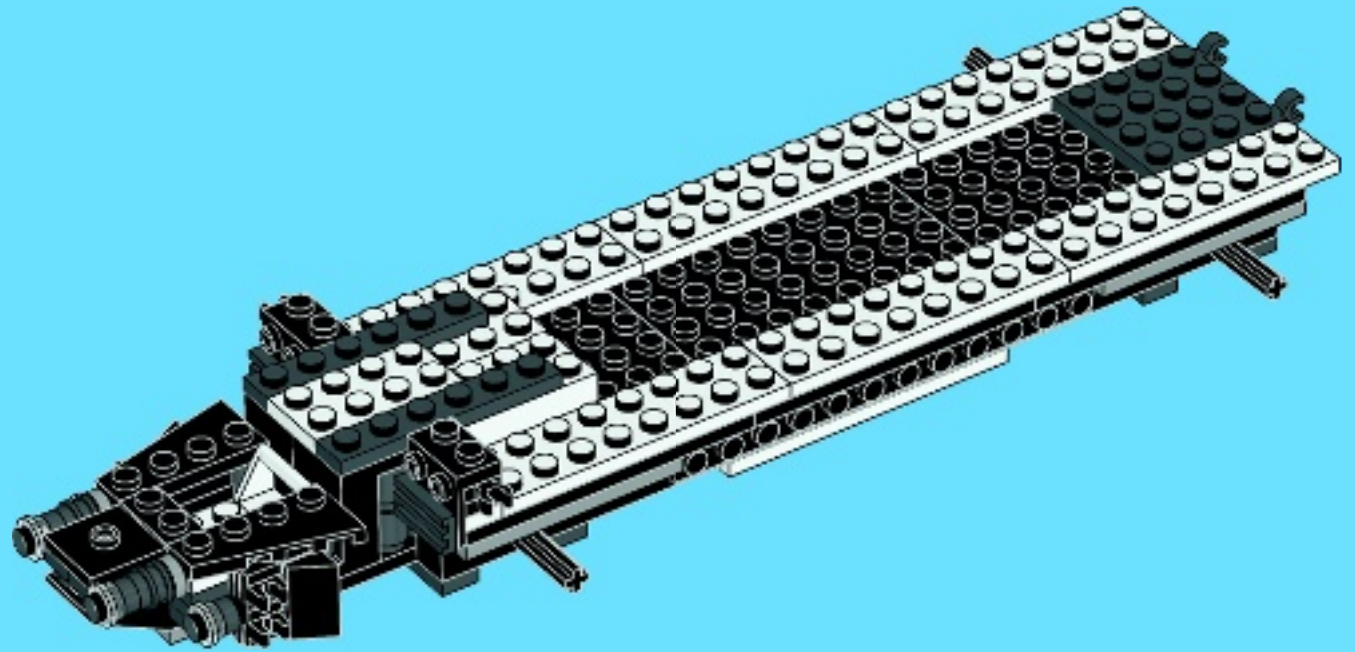

34

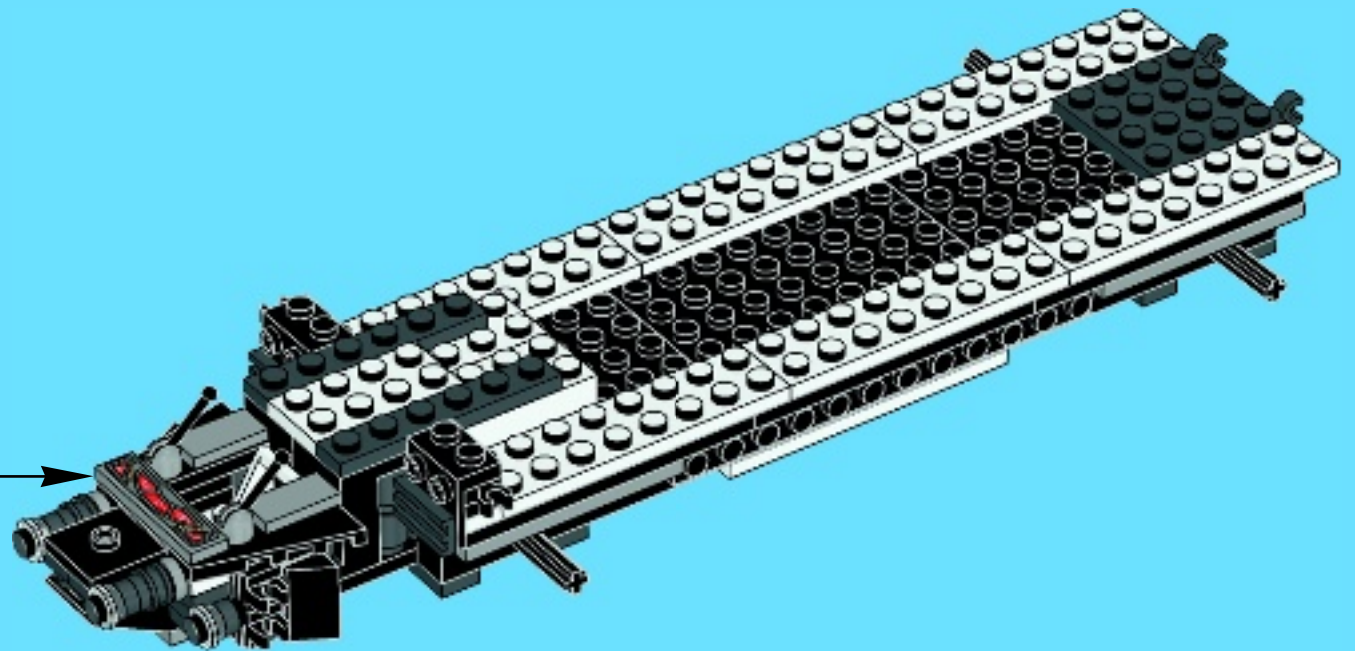
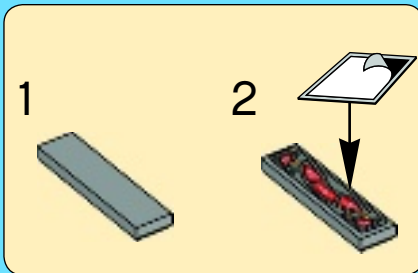

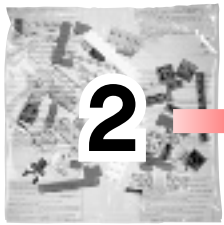

2

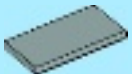
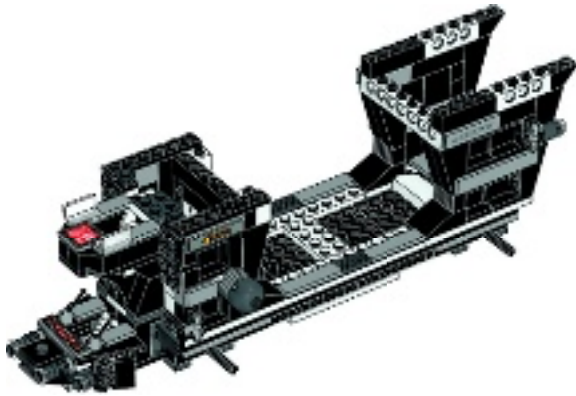

2x



1x

35

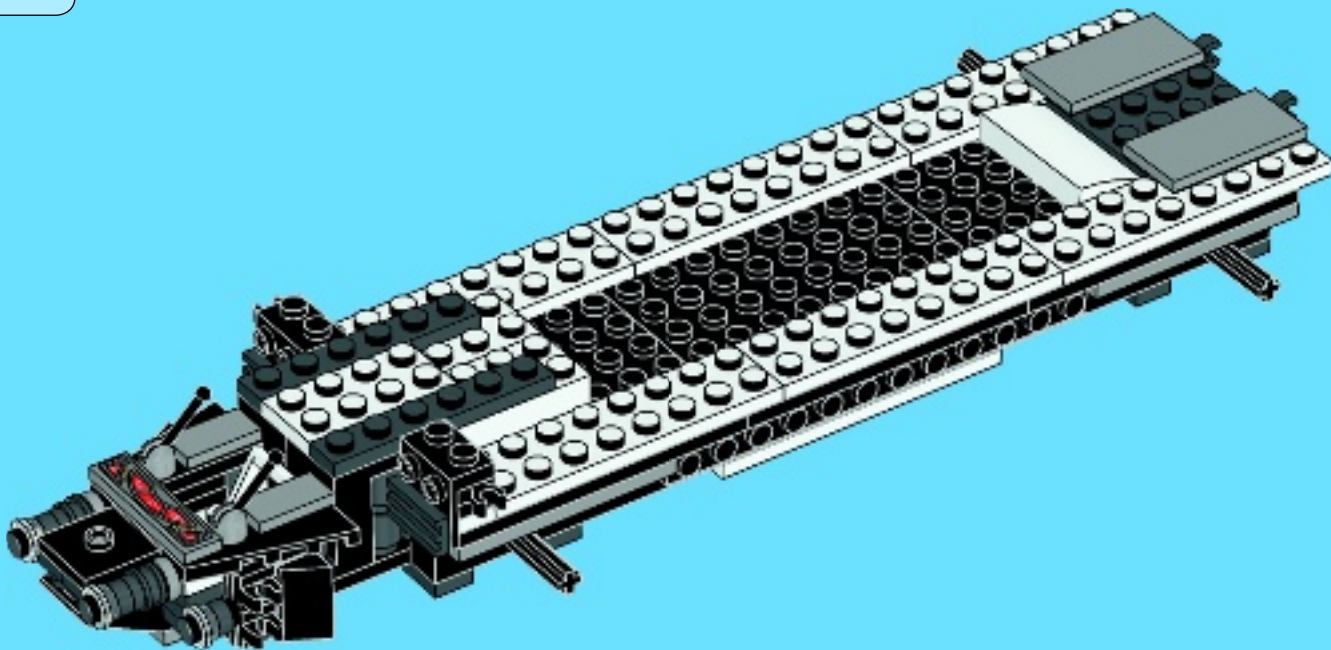



36

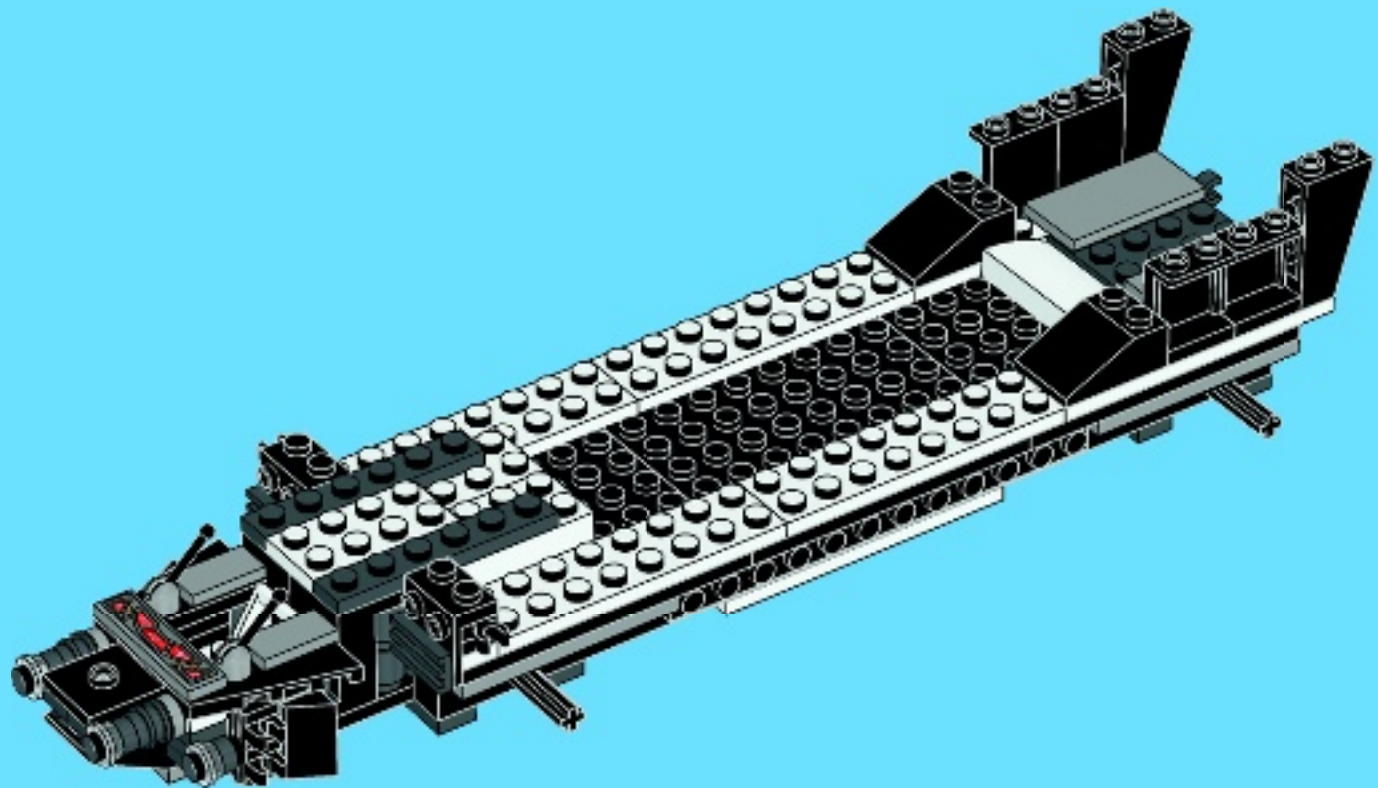



2x



2x

37

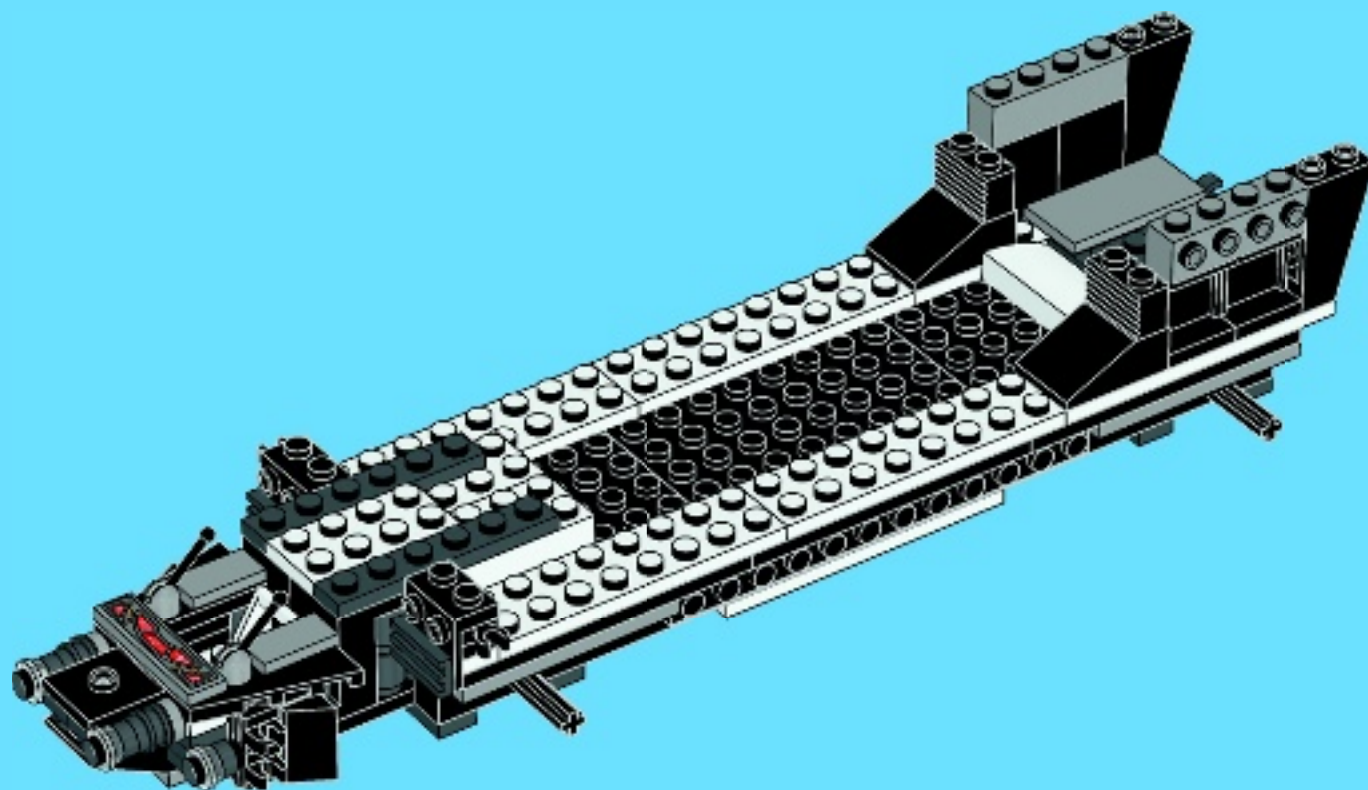



4x



4x

38

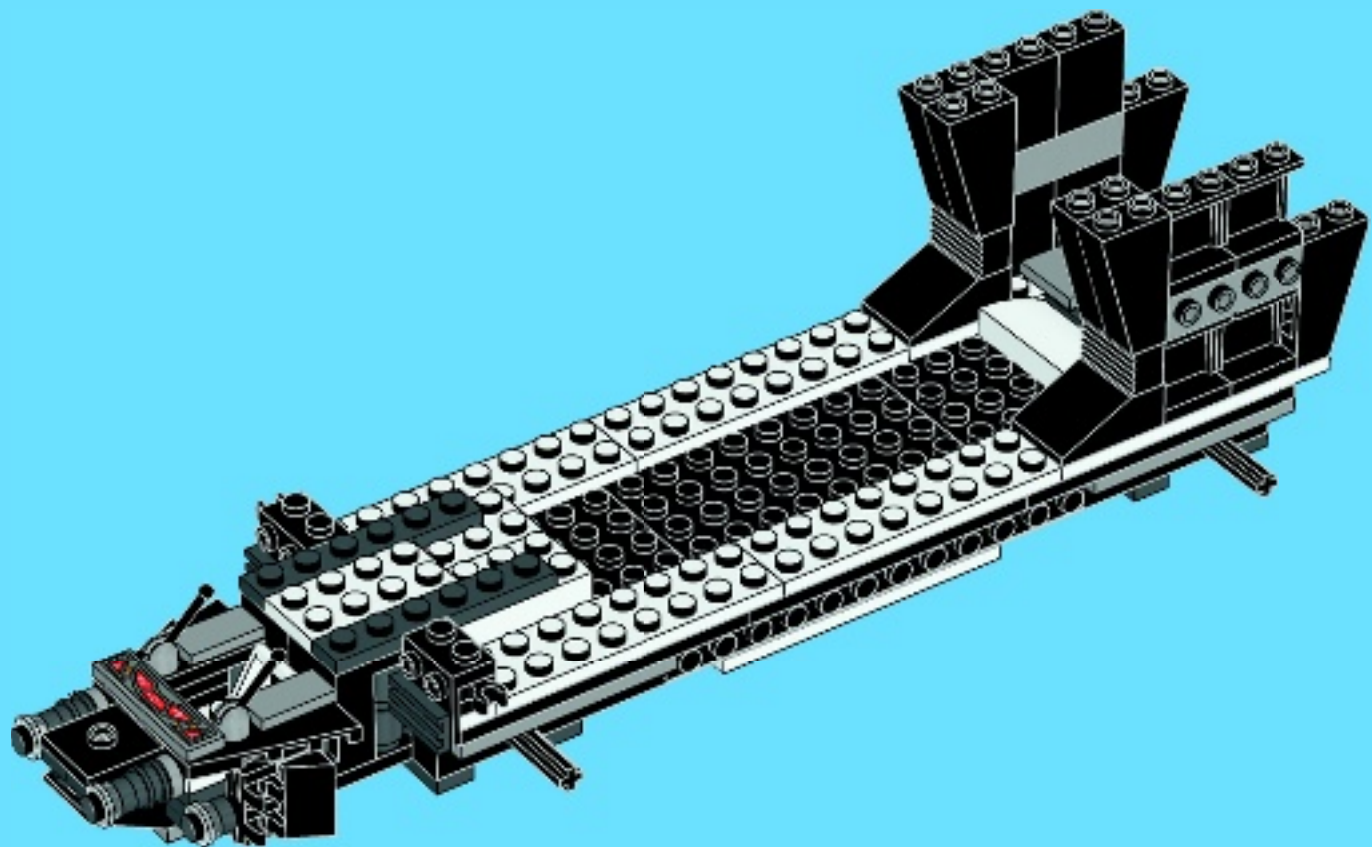



4x



2x



2x



2x

39

1 

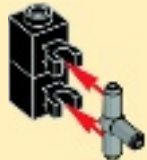
2 

3  2x

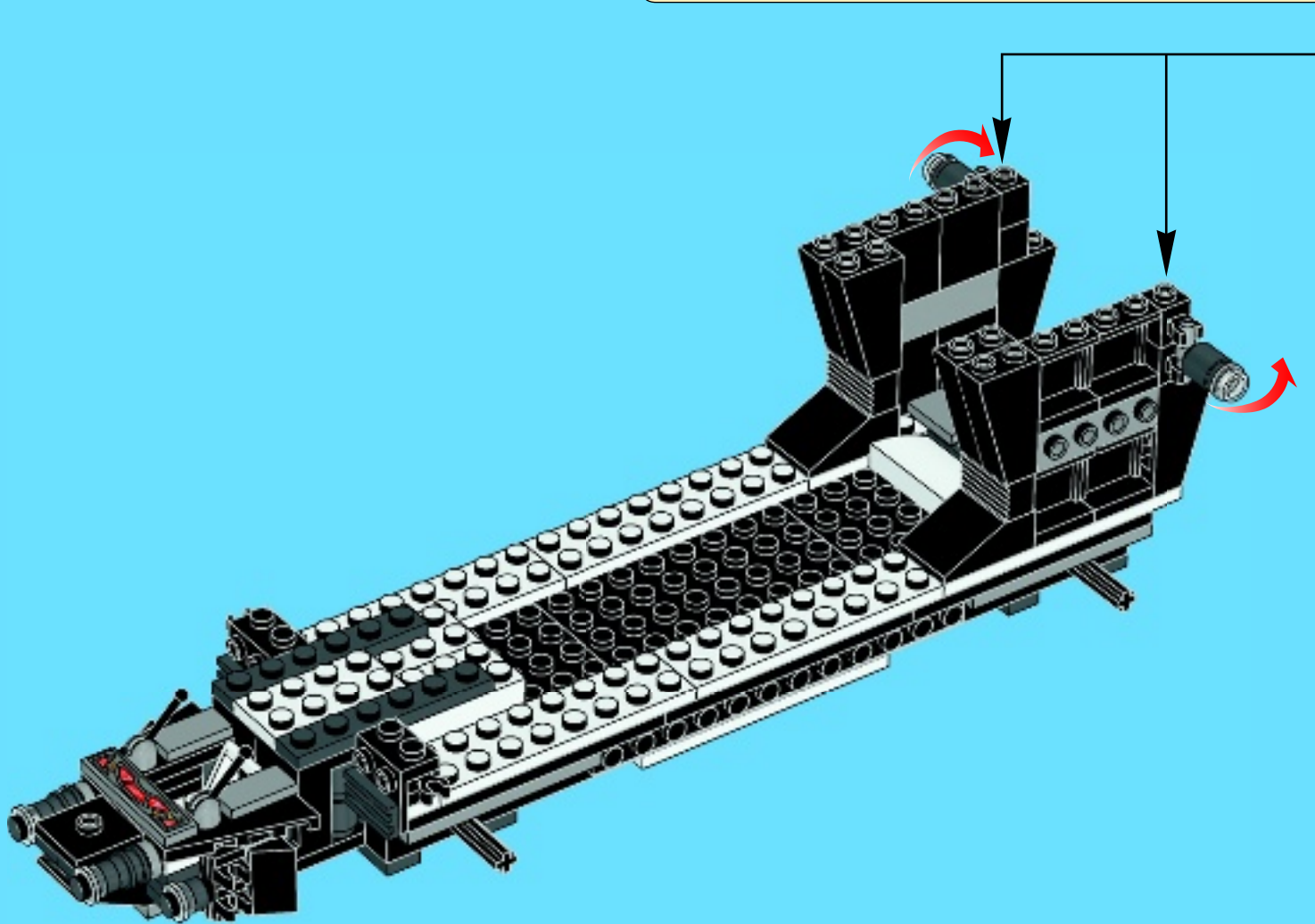

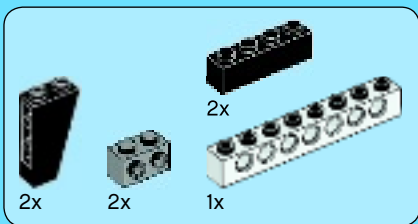

40

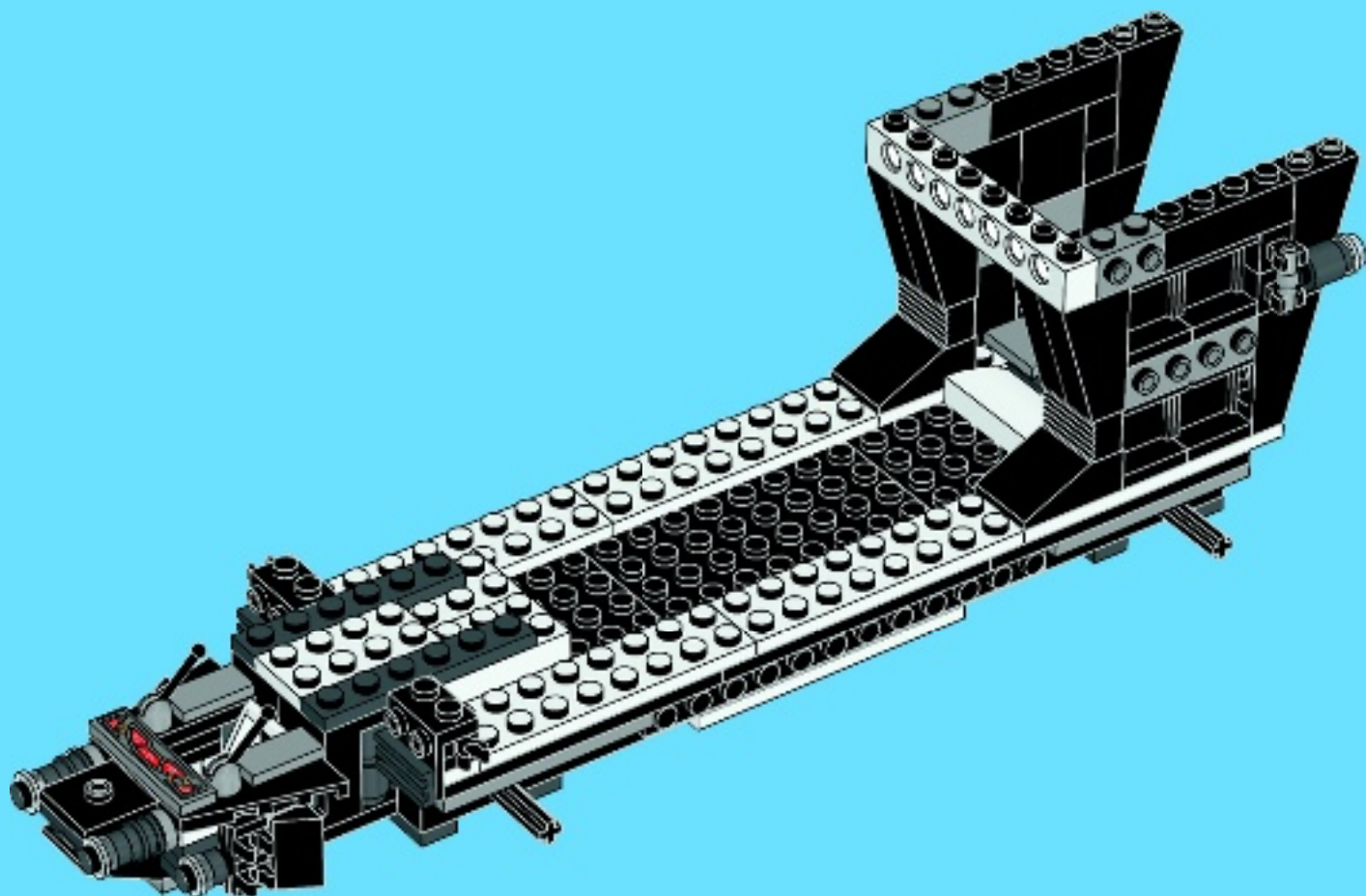

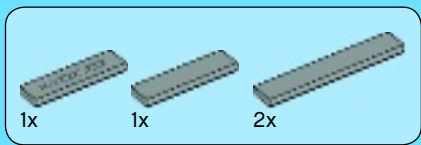

41

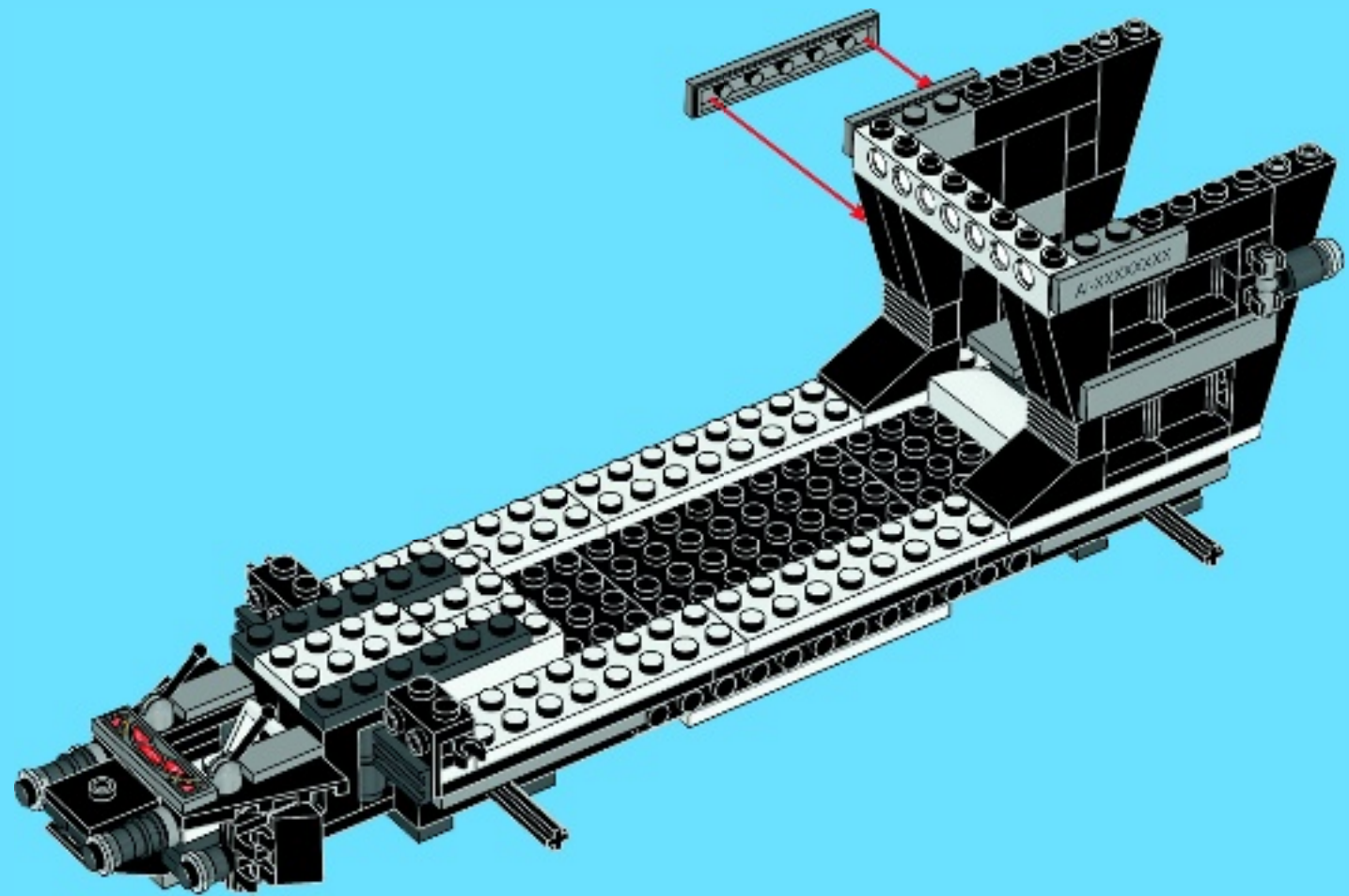

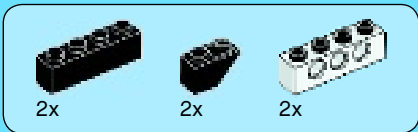

42

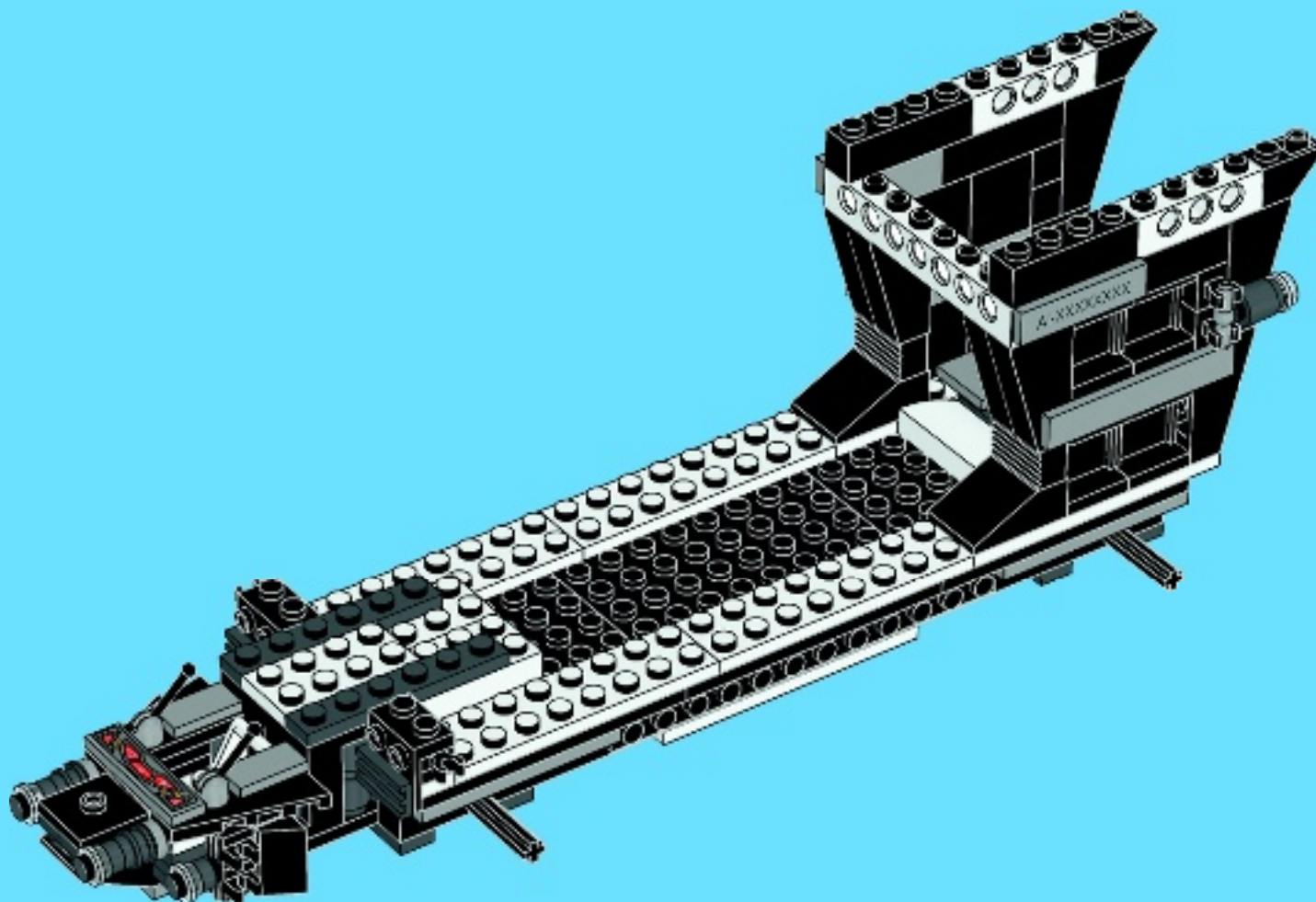



43

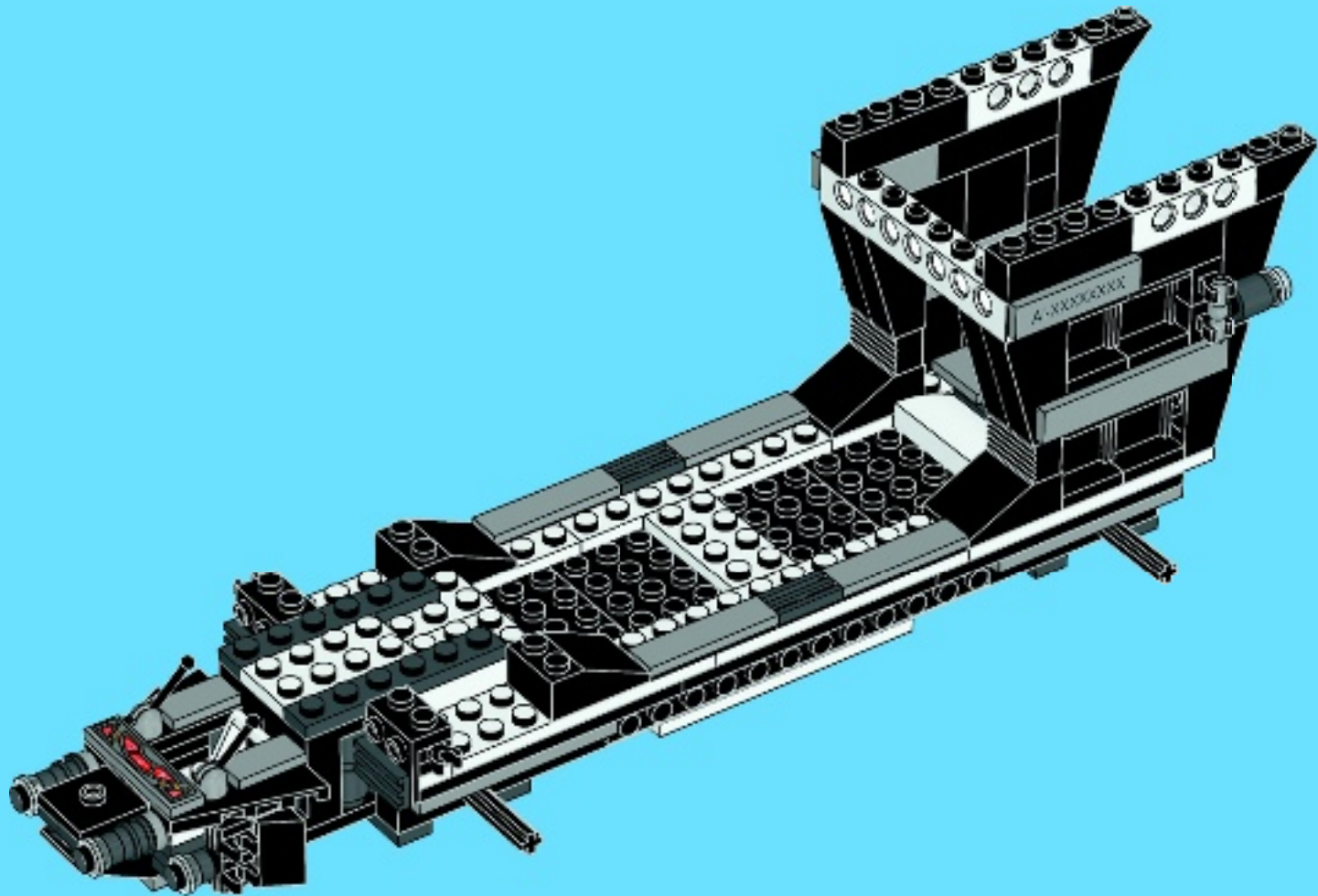

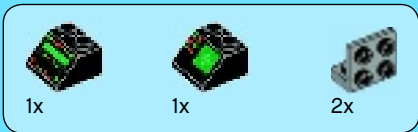

44

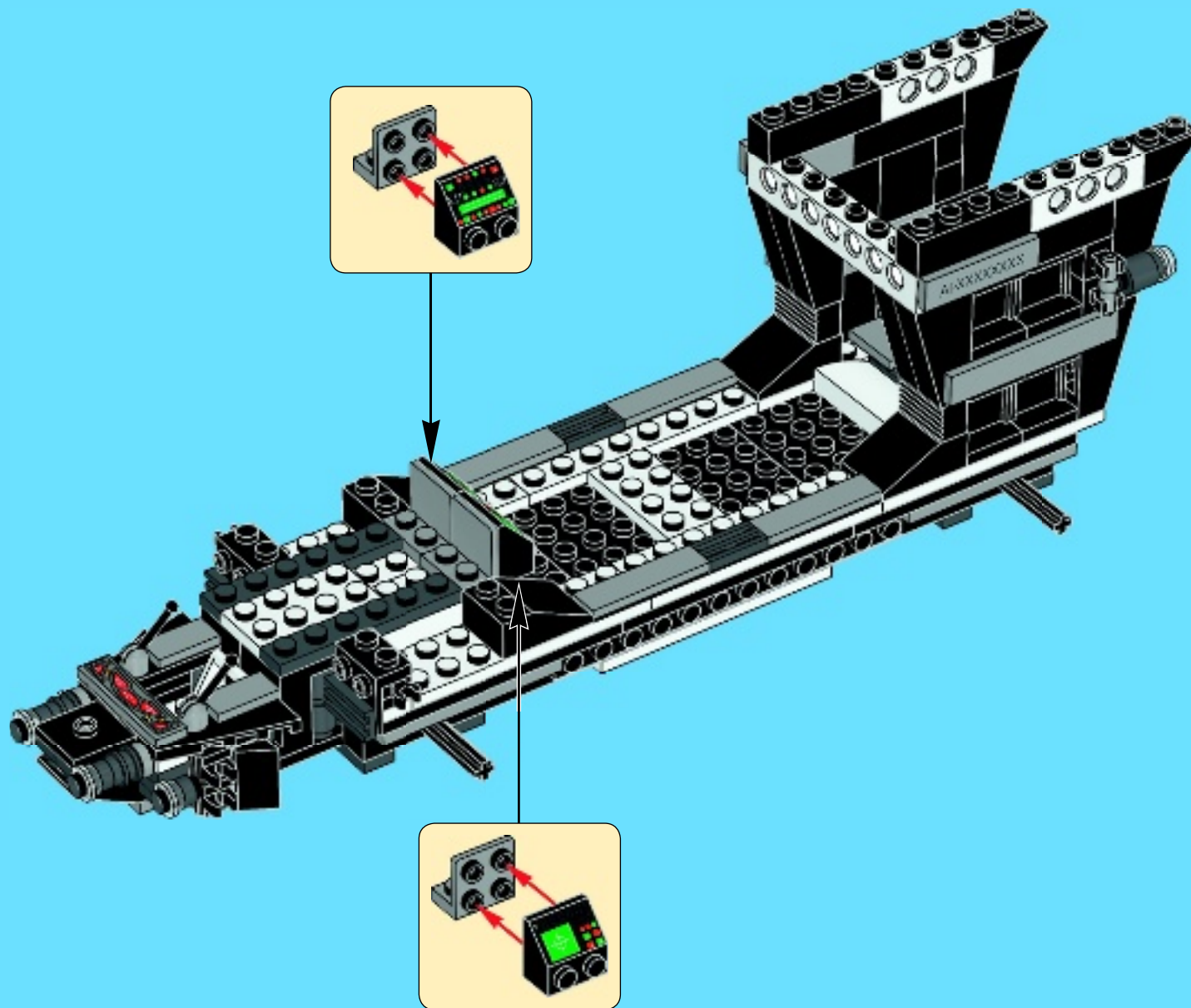



45

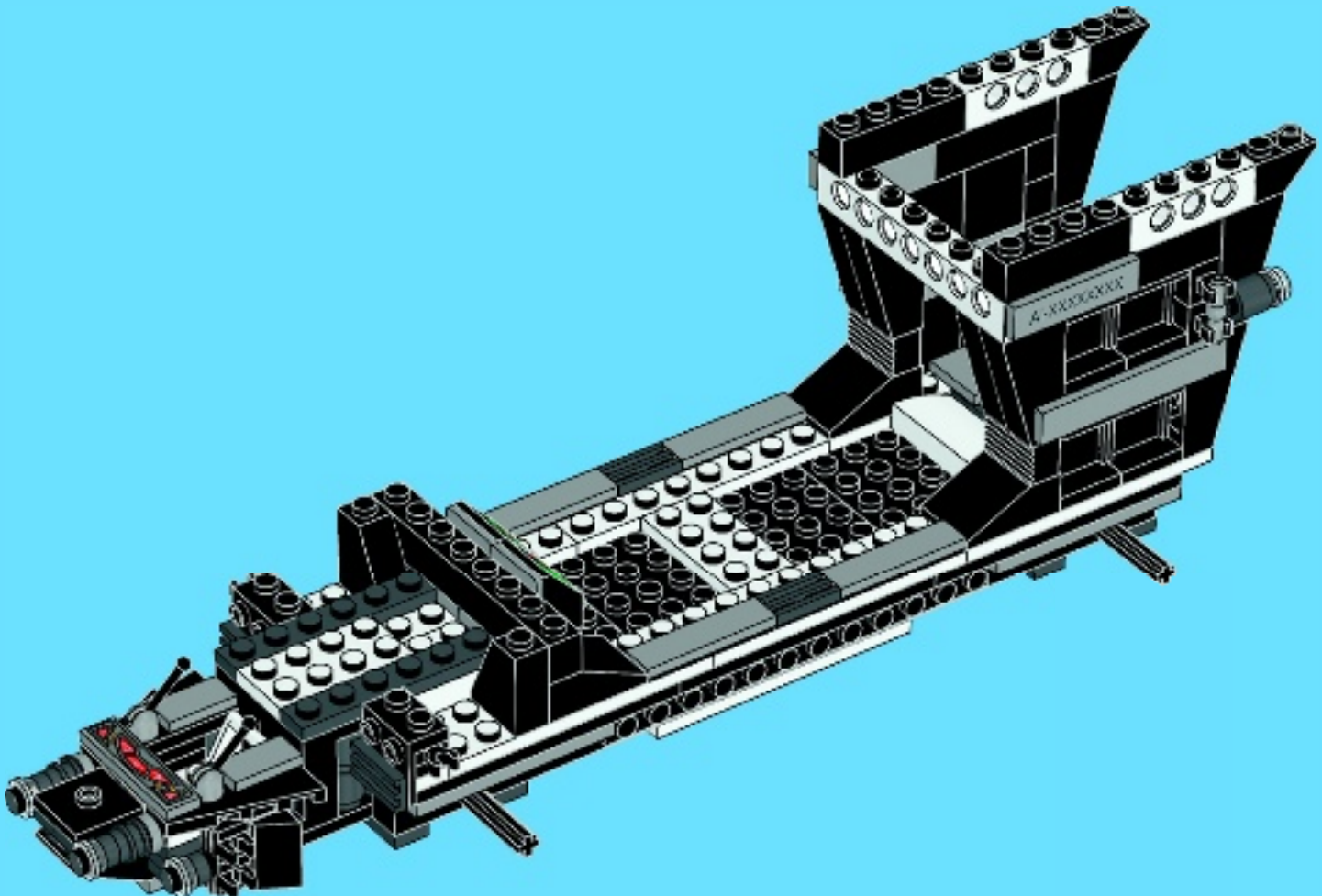

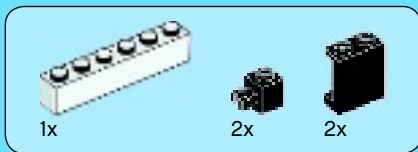

46

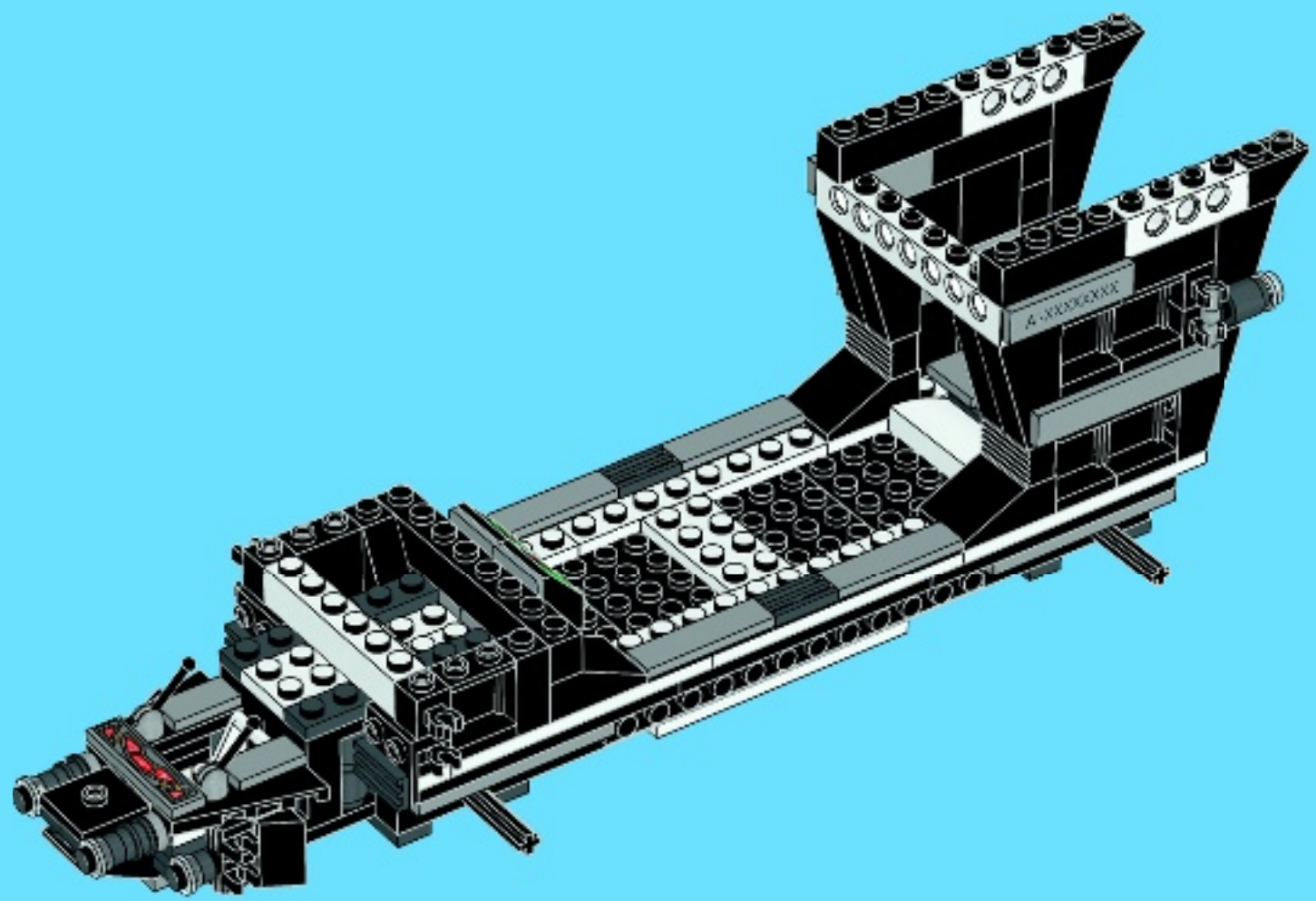



2x



1x

47

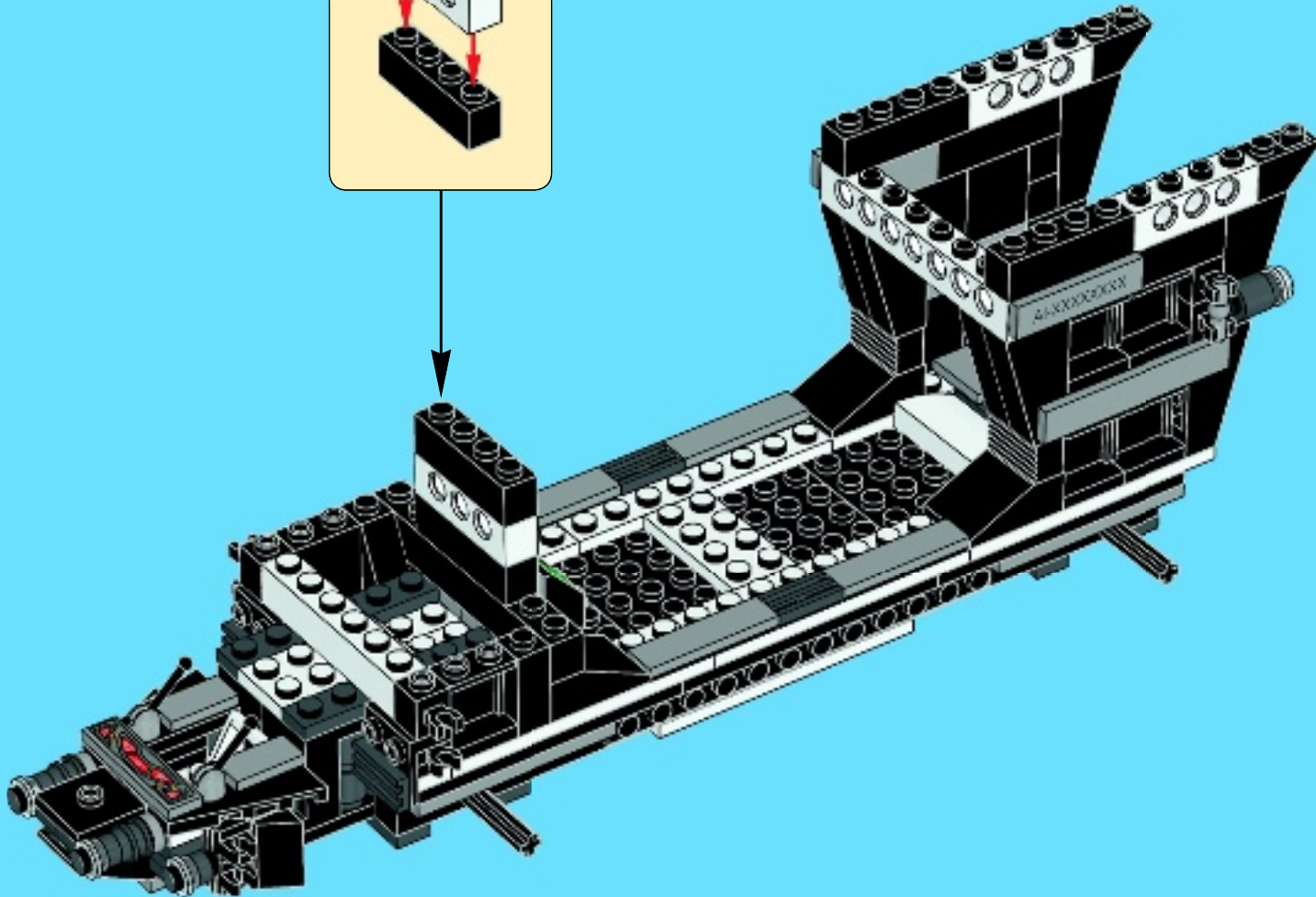
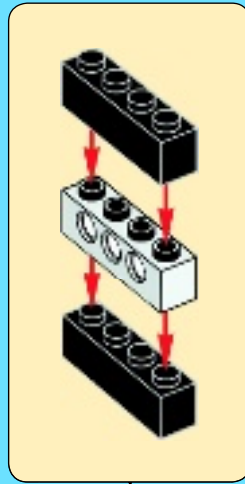



4x

48

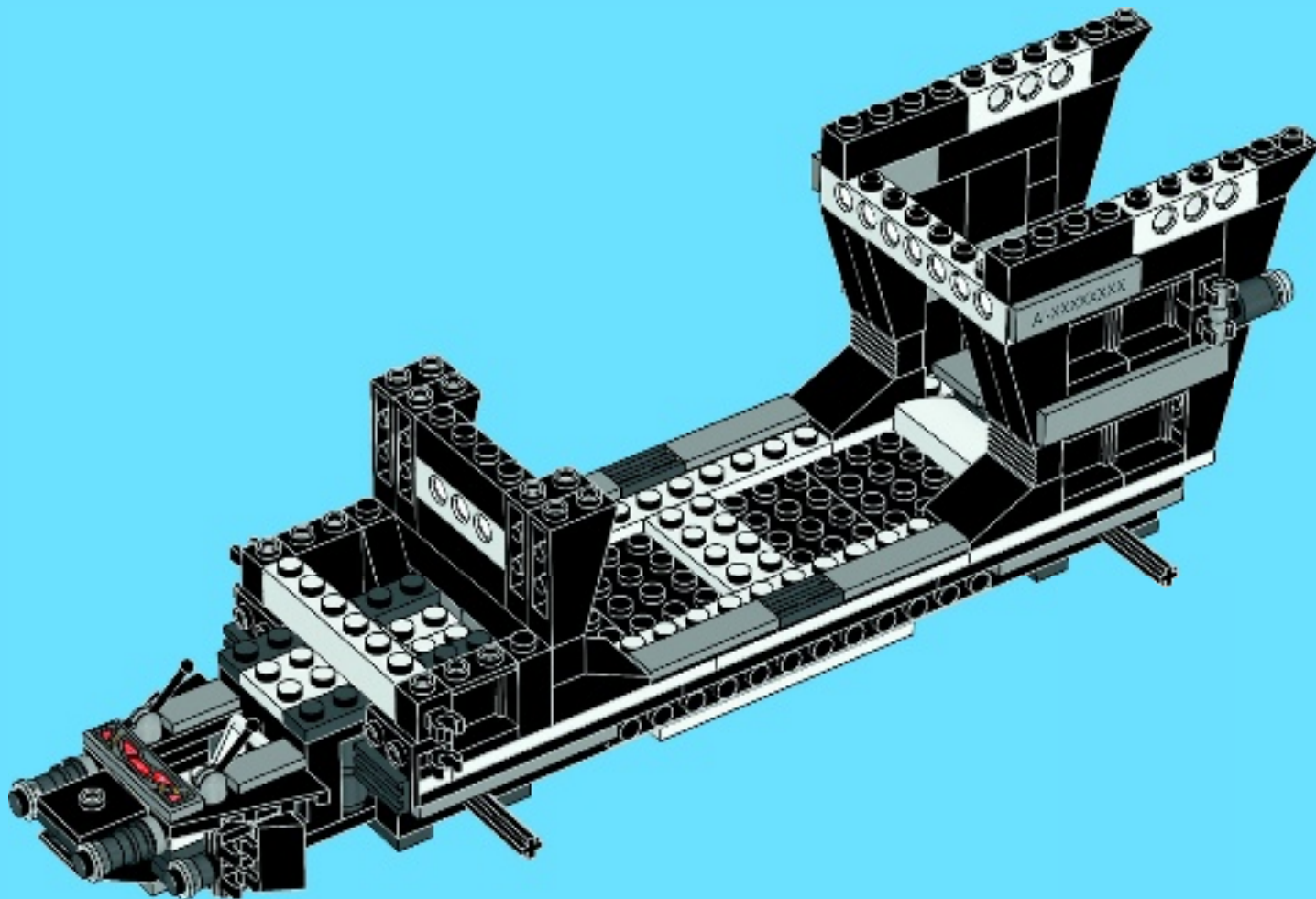



49

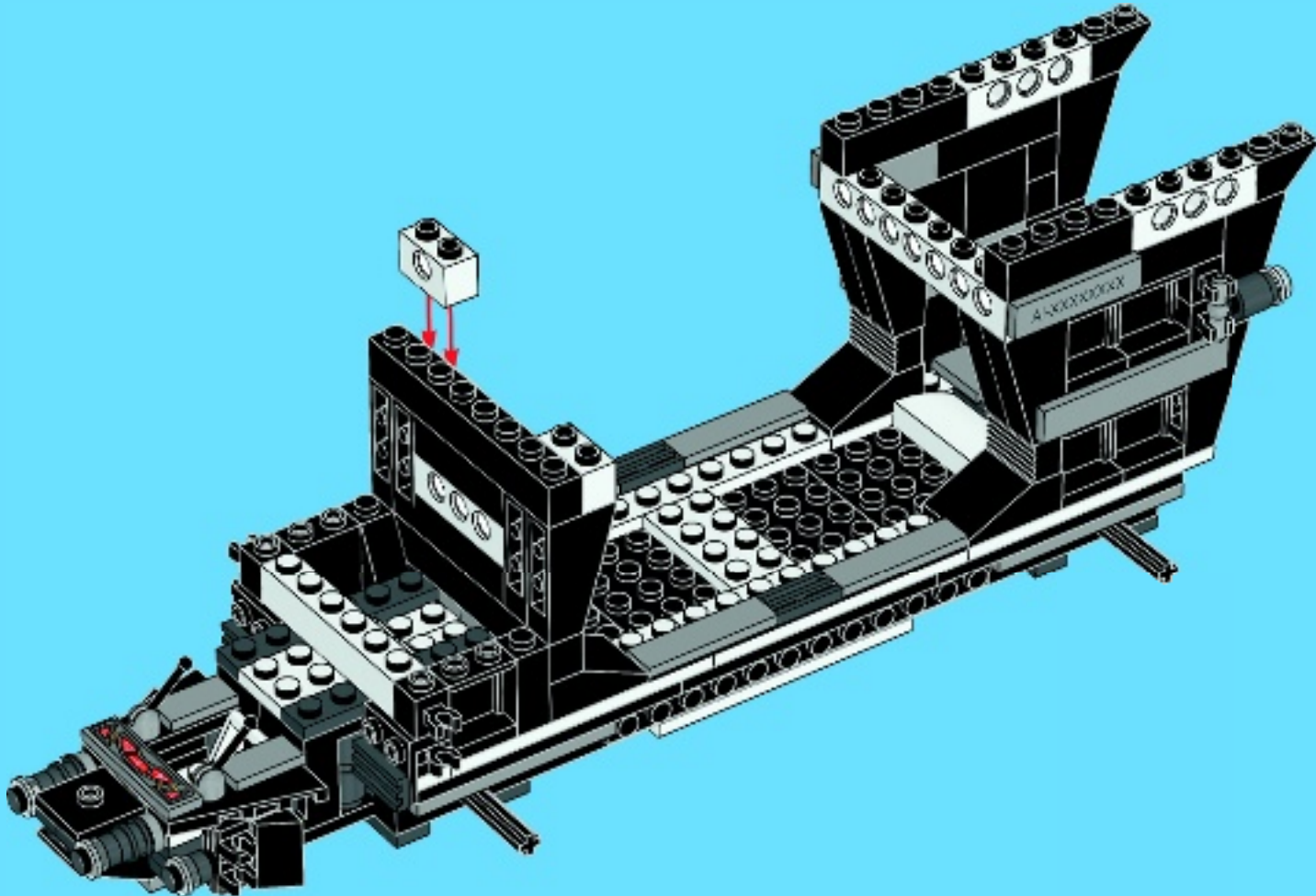

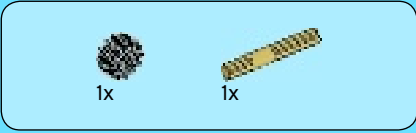
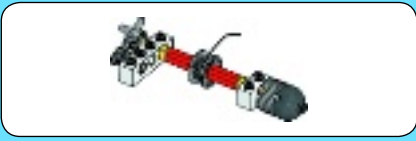

1

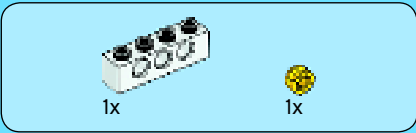
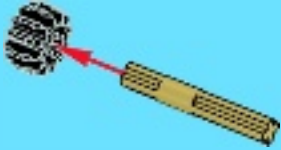

2

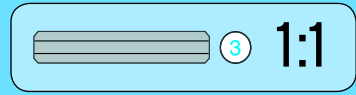
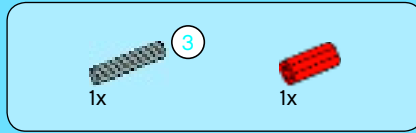
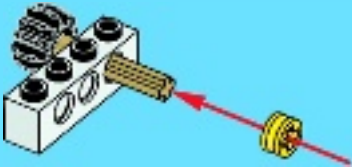

3

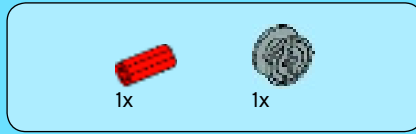
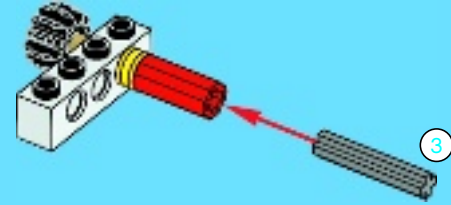

4

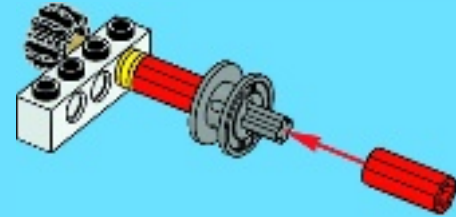

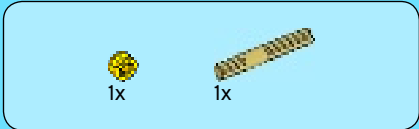

5

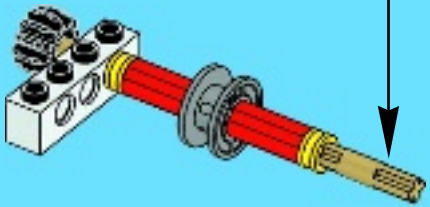
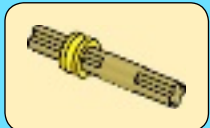

6

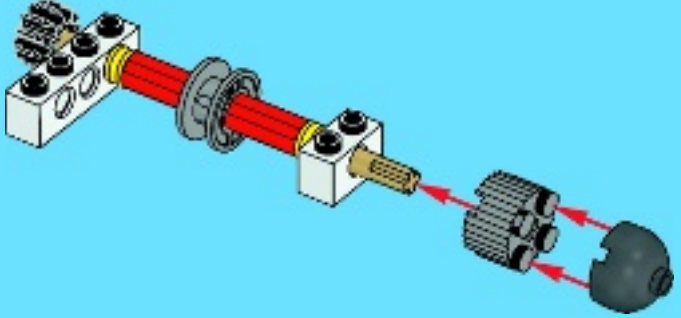

7

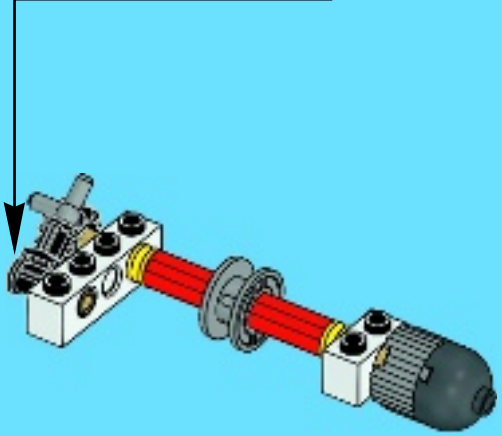
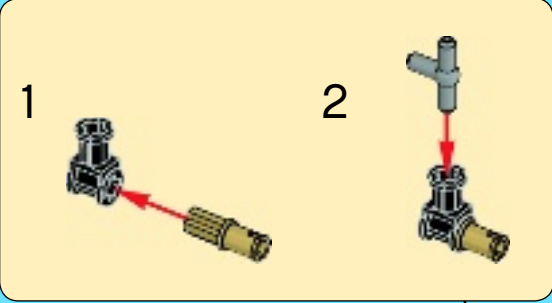



1x

8

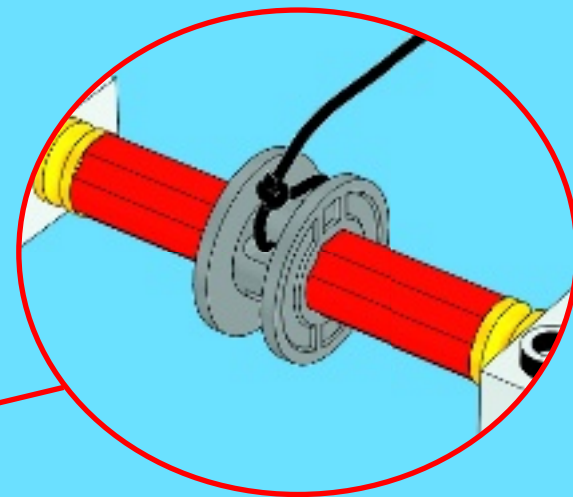
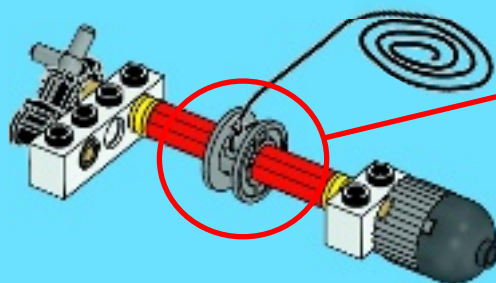

9

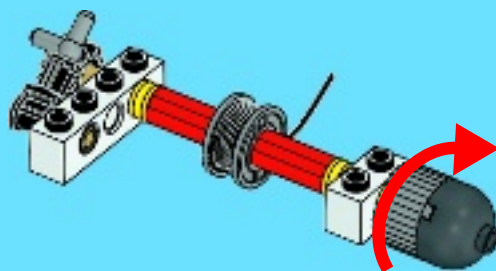

50

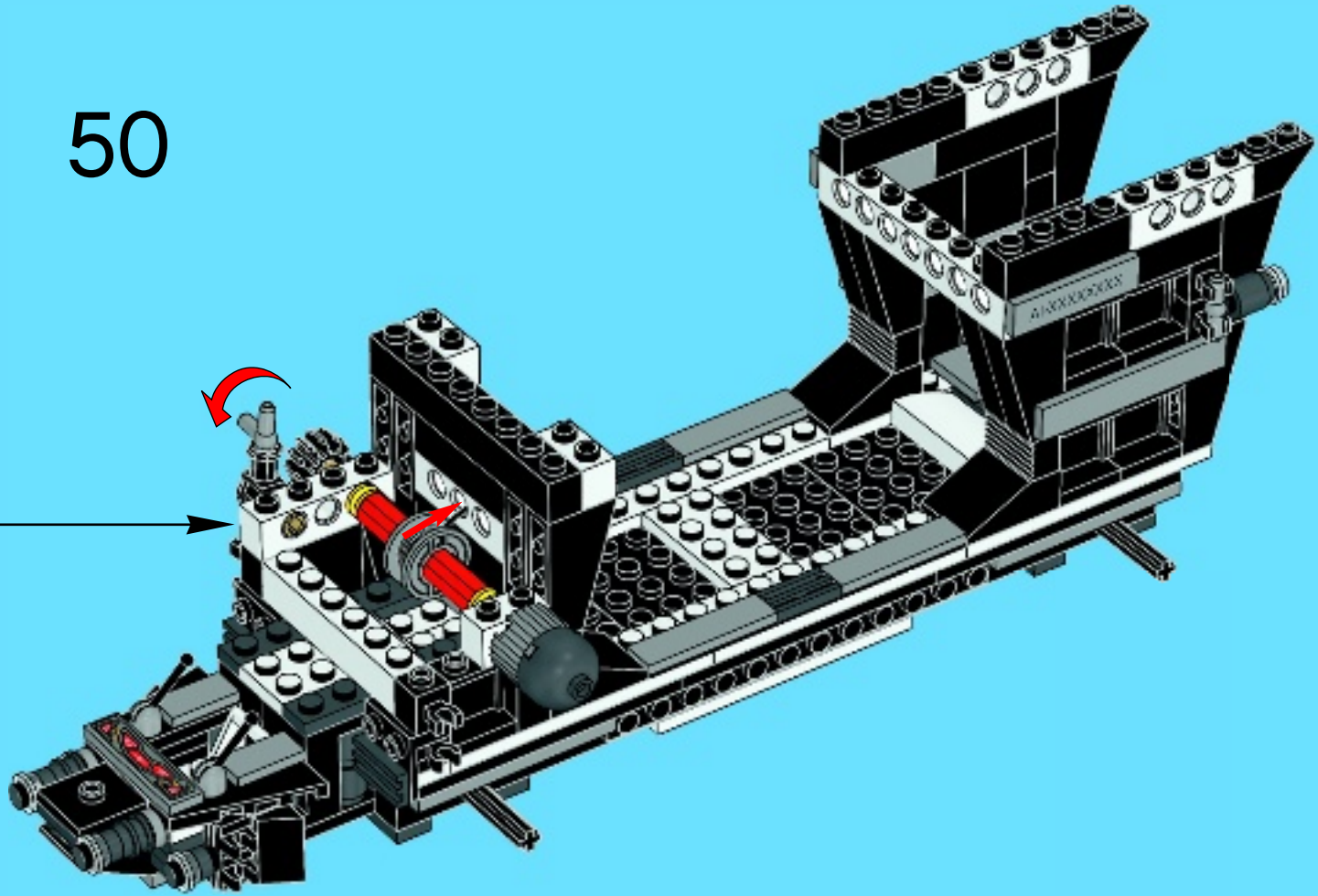



1x



1x

51

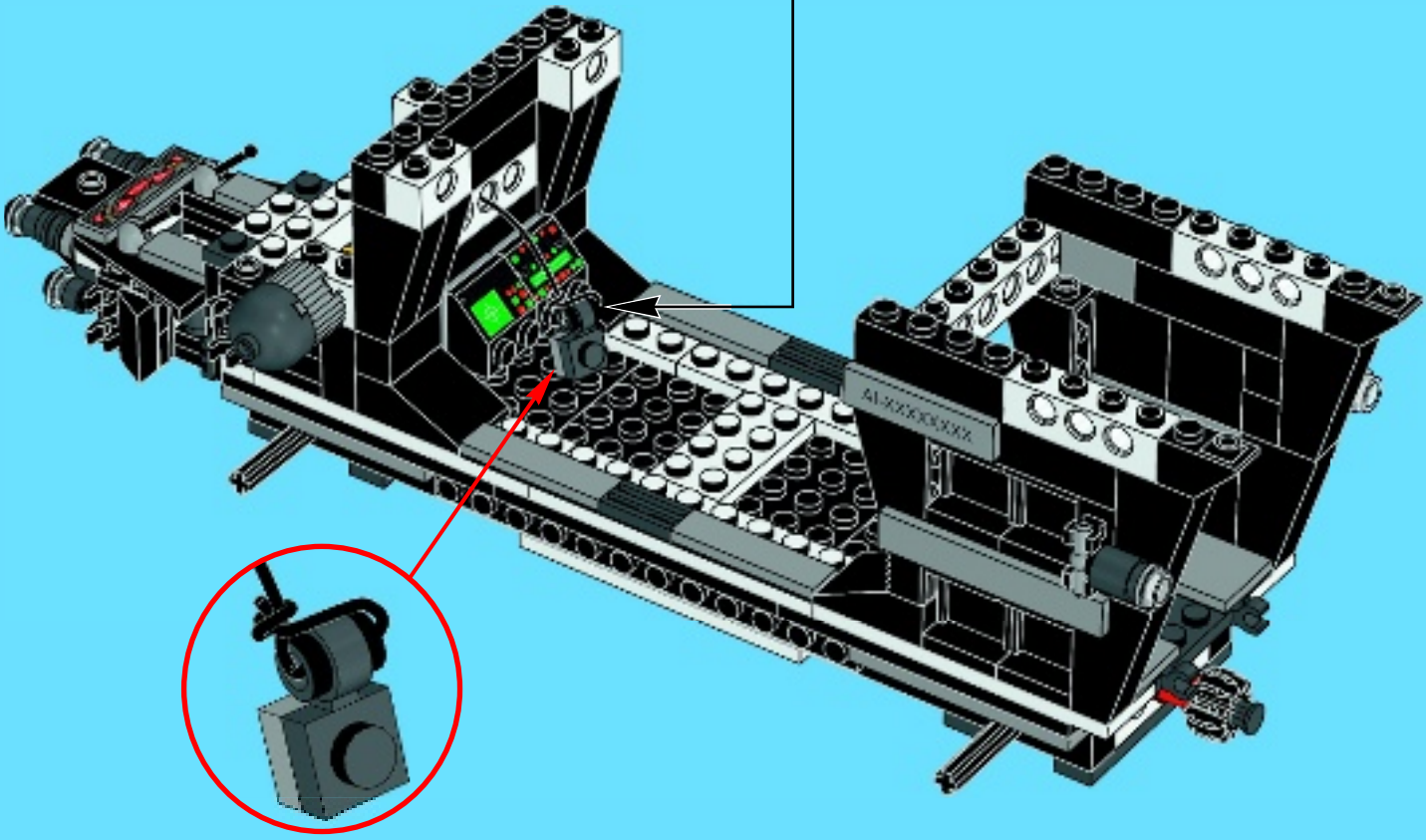
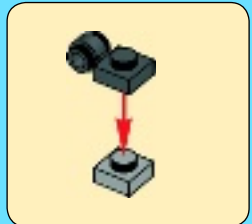

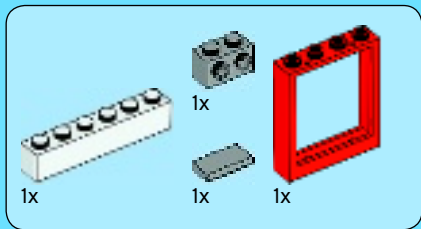

52

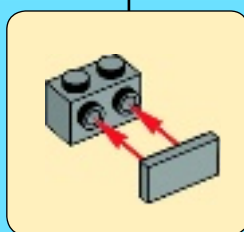
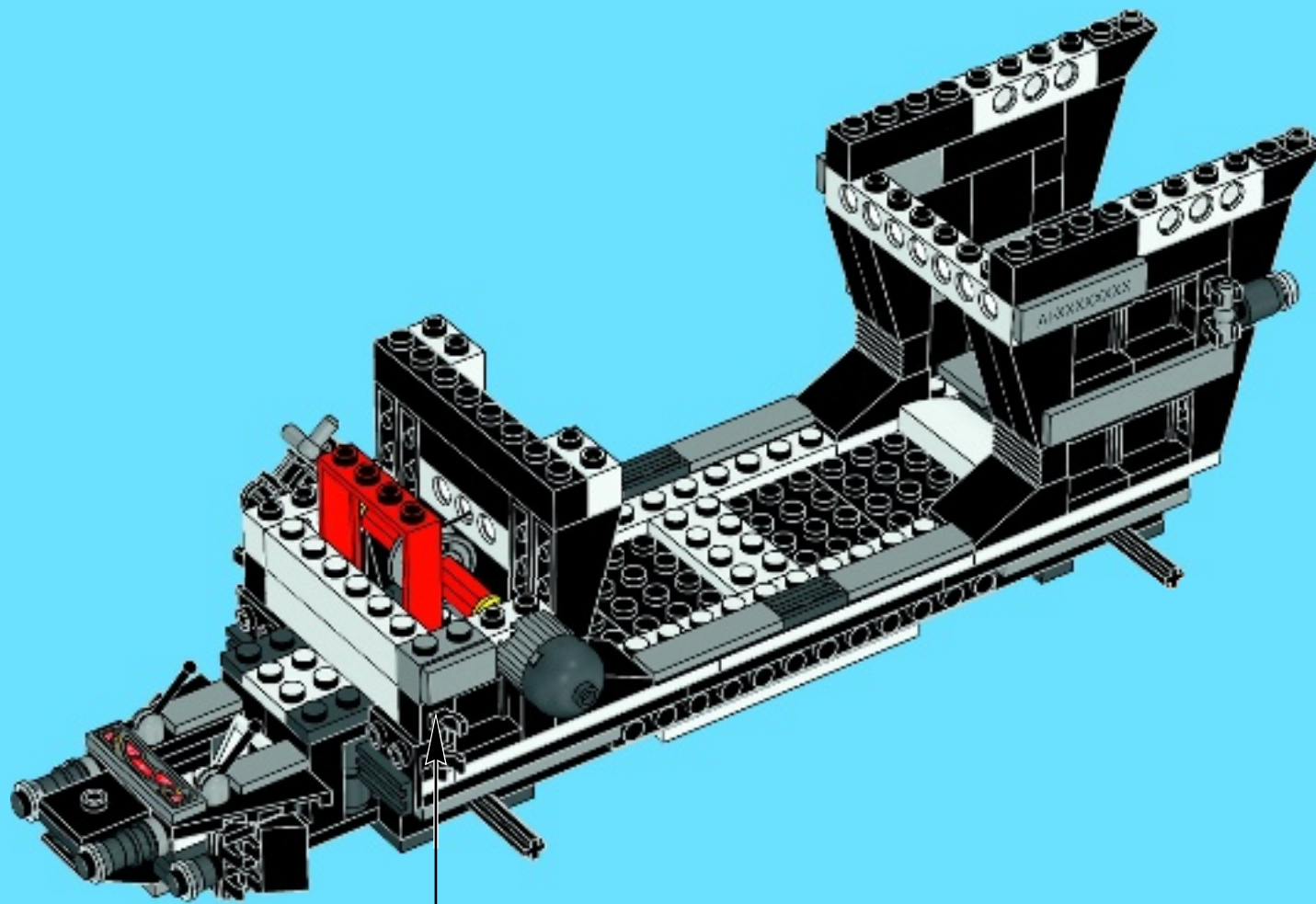

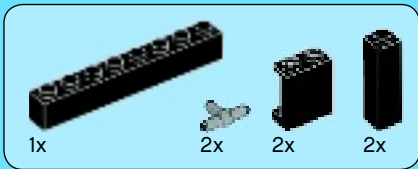

53

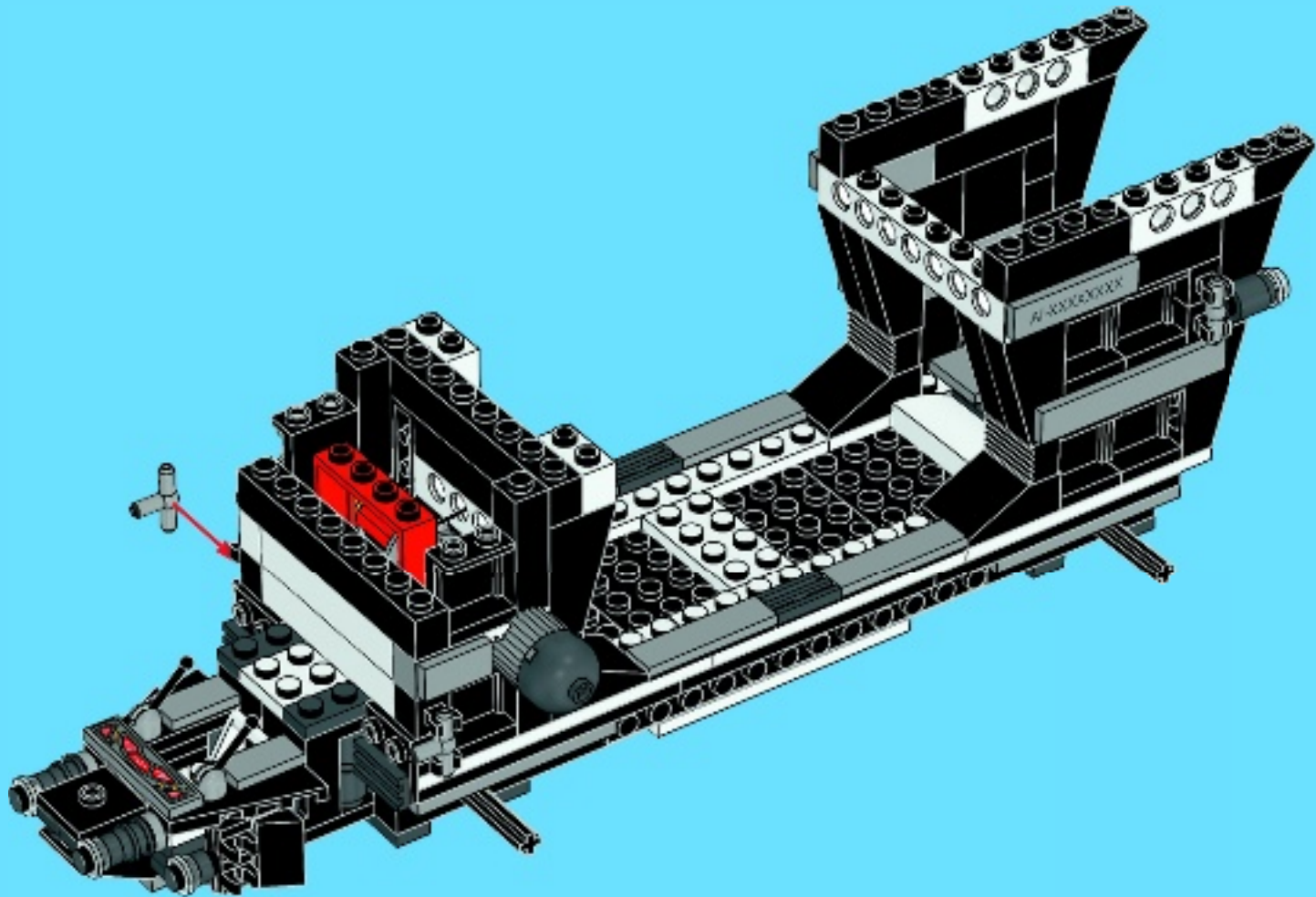



2x



2x

54

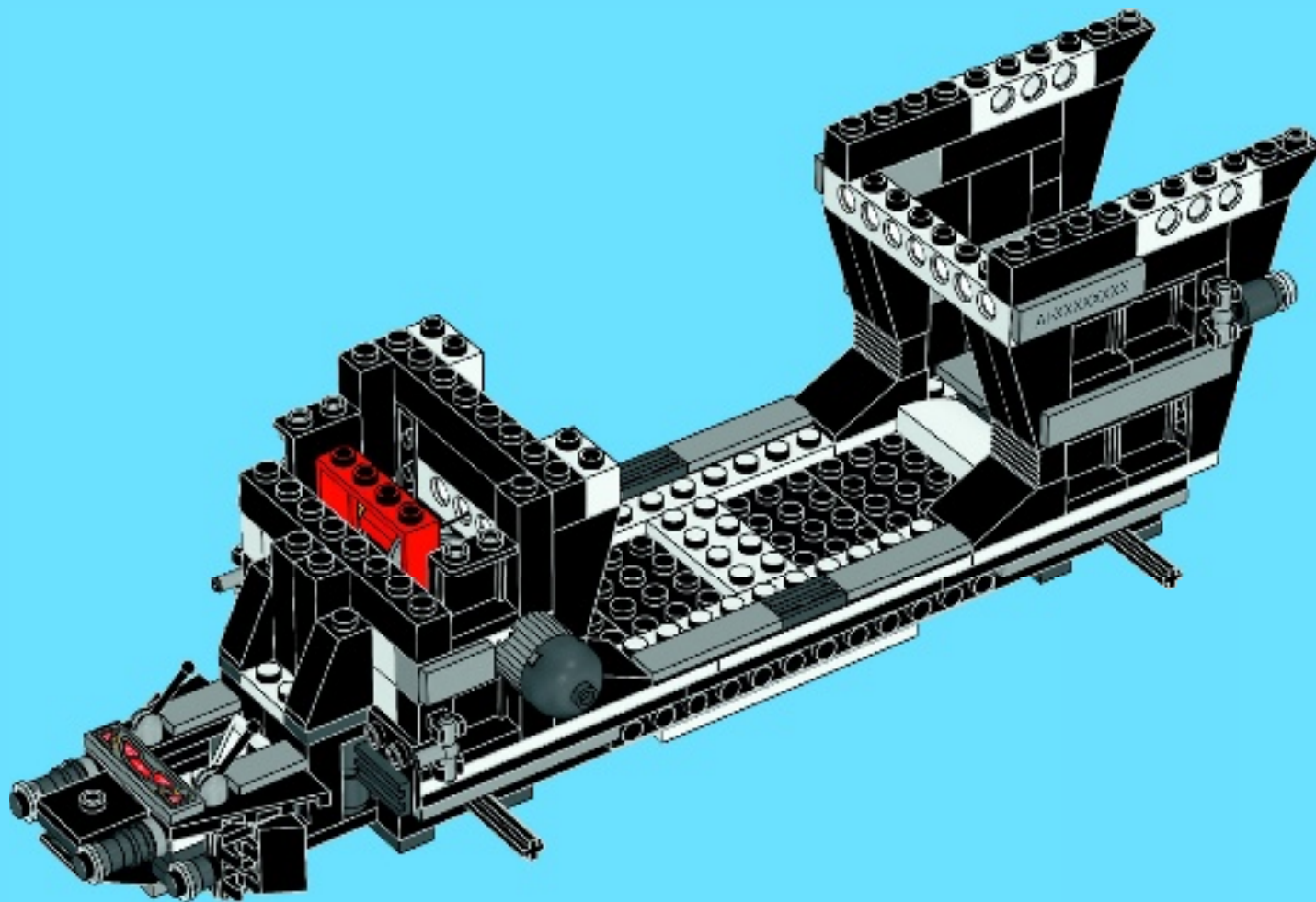

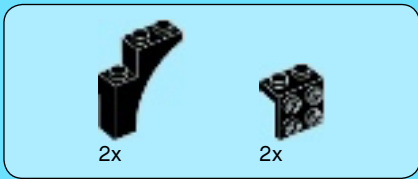

55

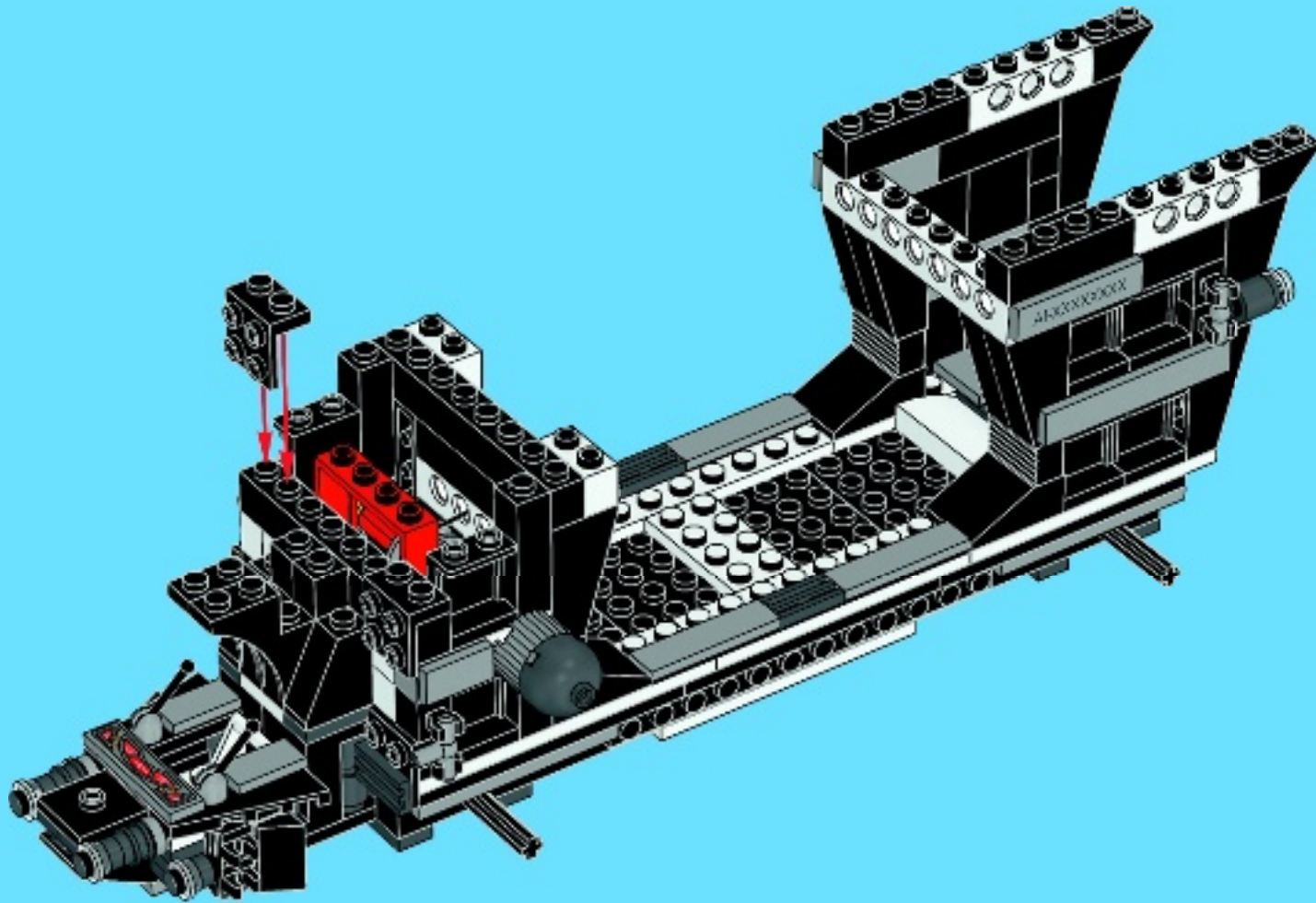



2x



1x

56

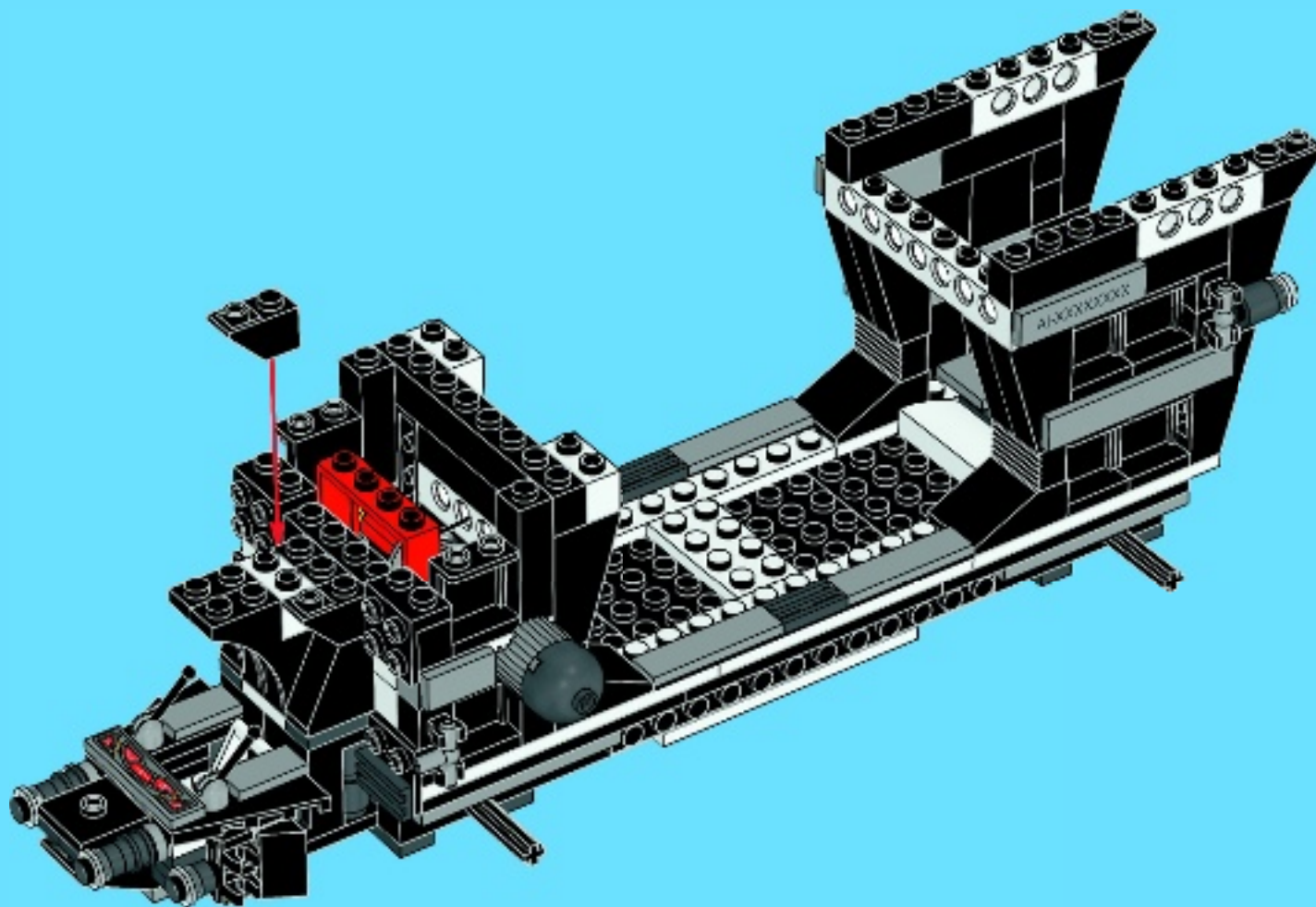

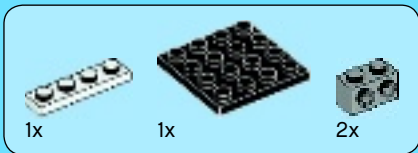

57

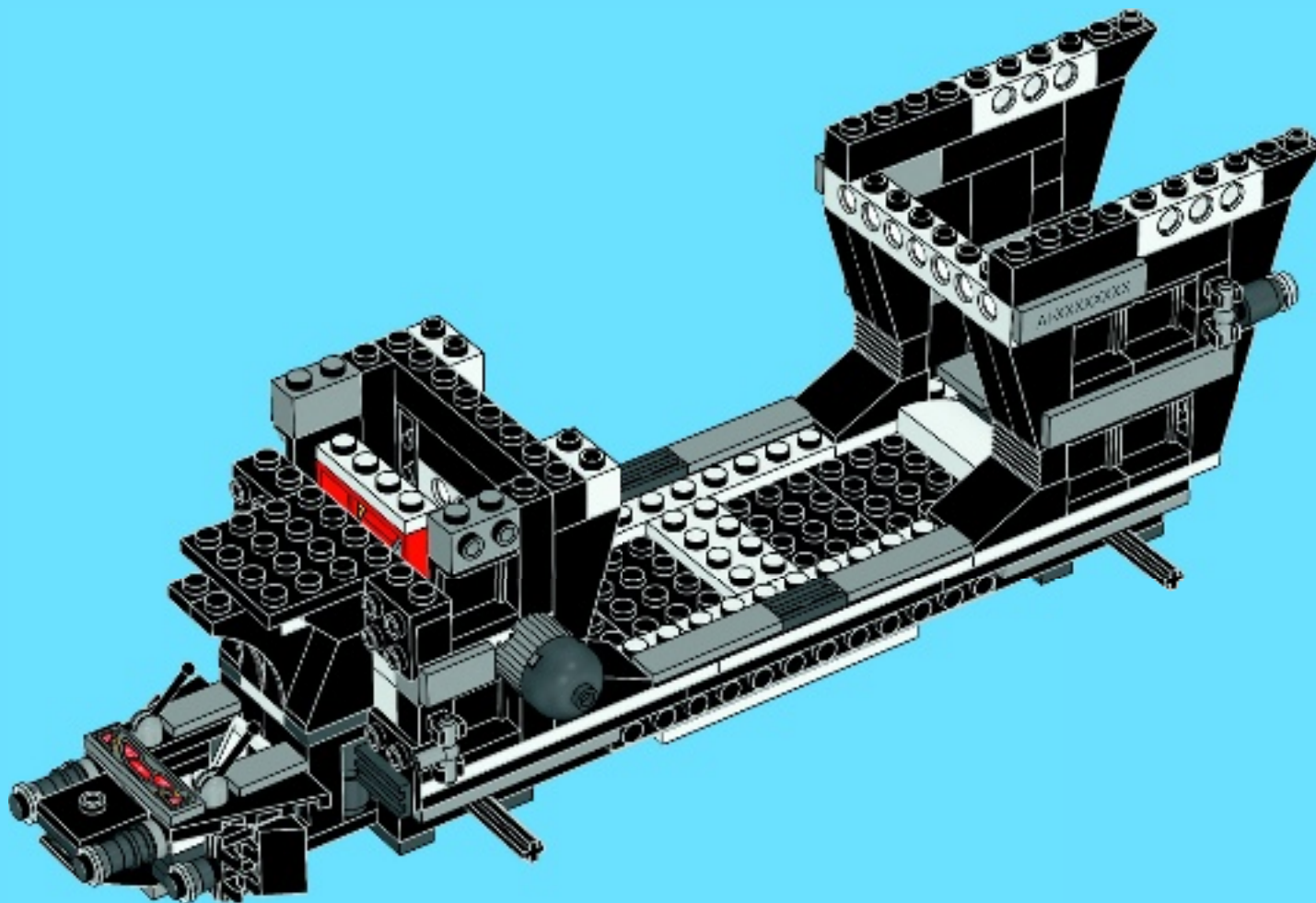



58

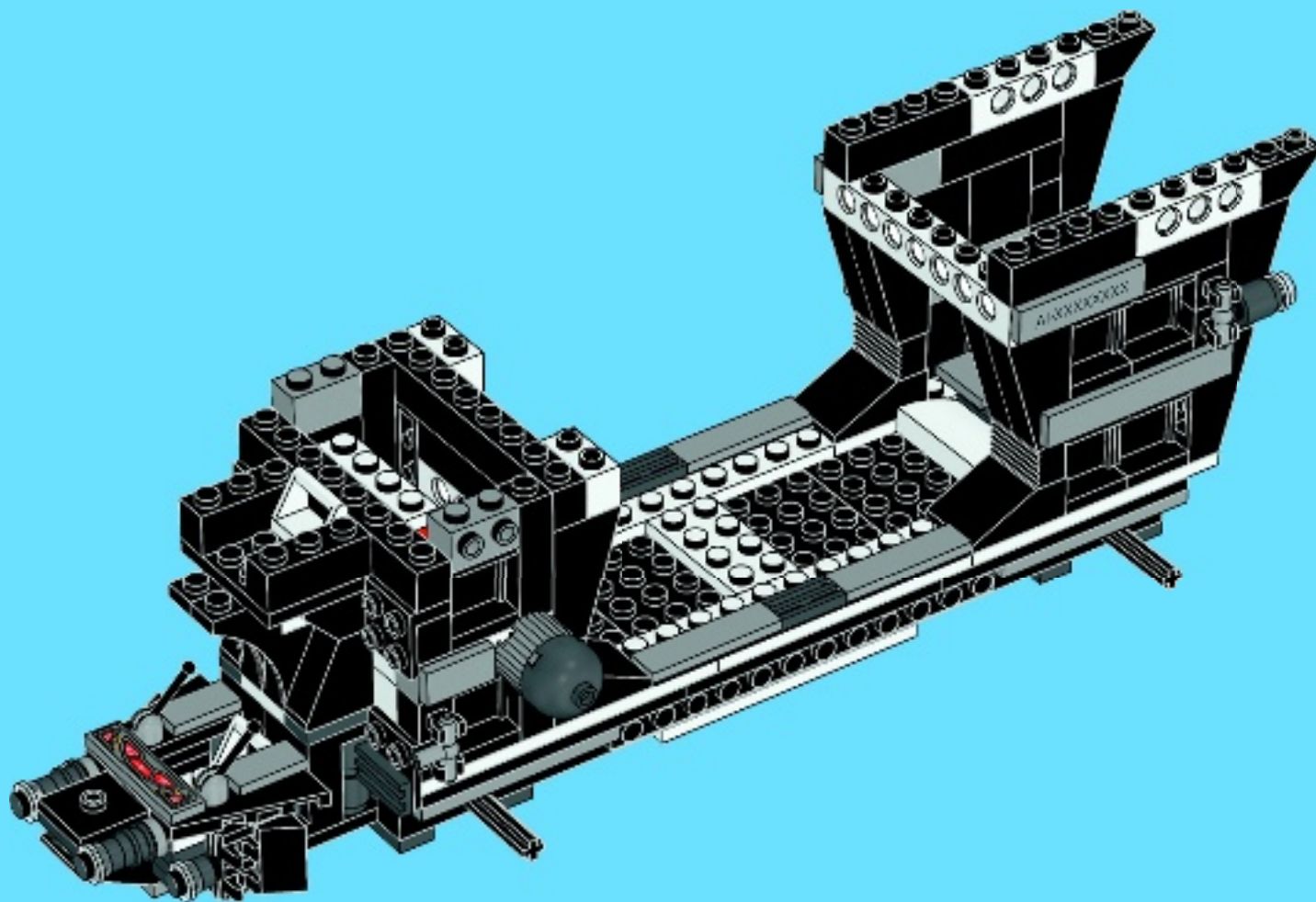



2x



1x

59

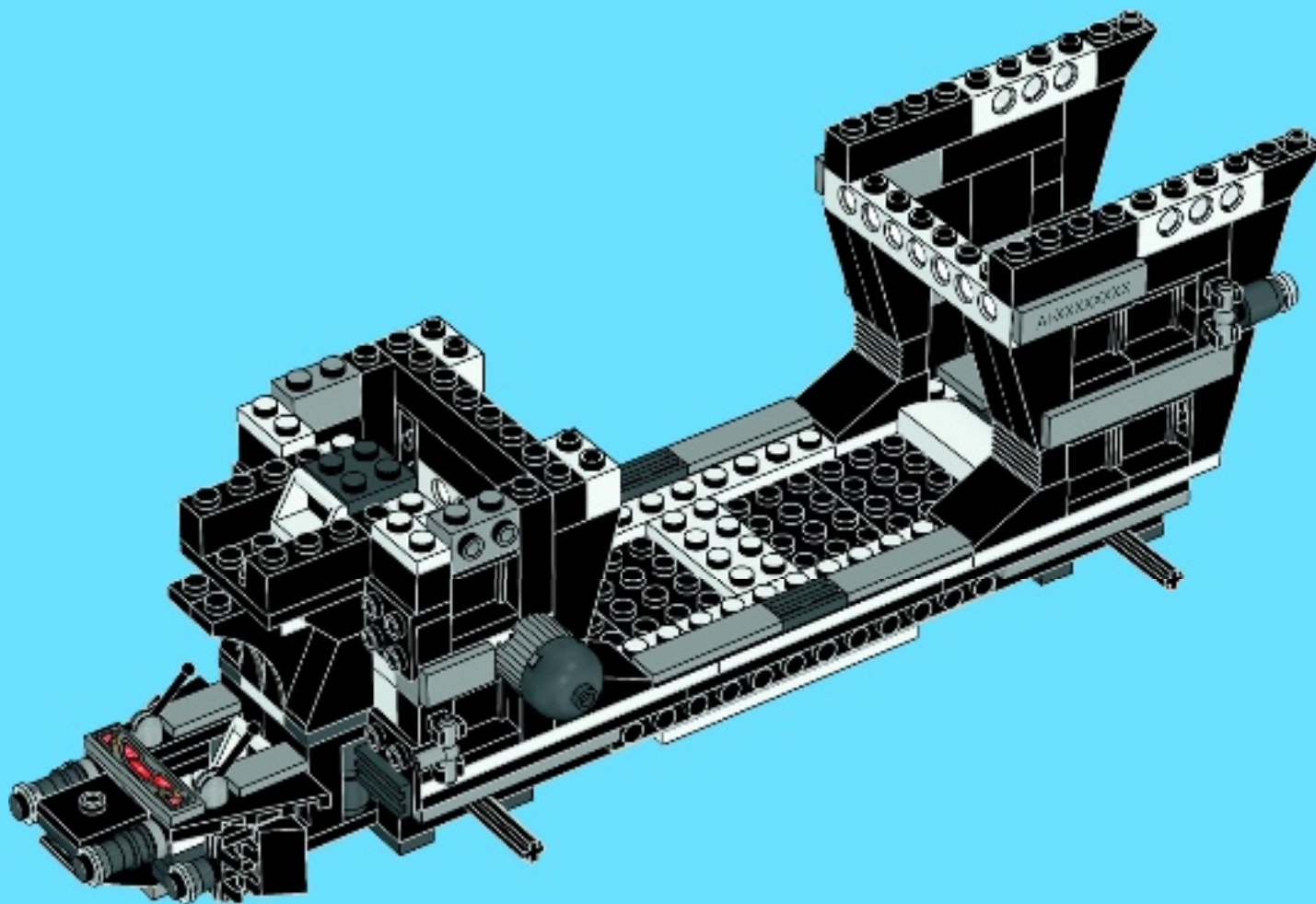



2x

60

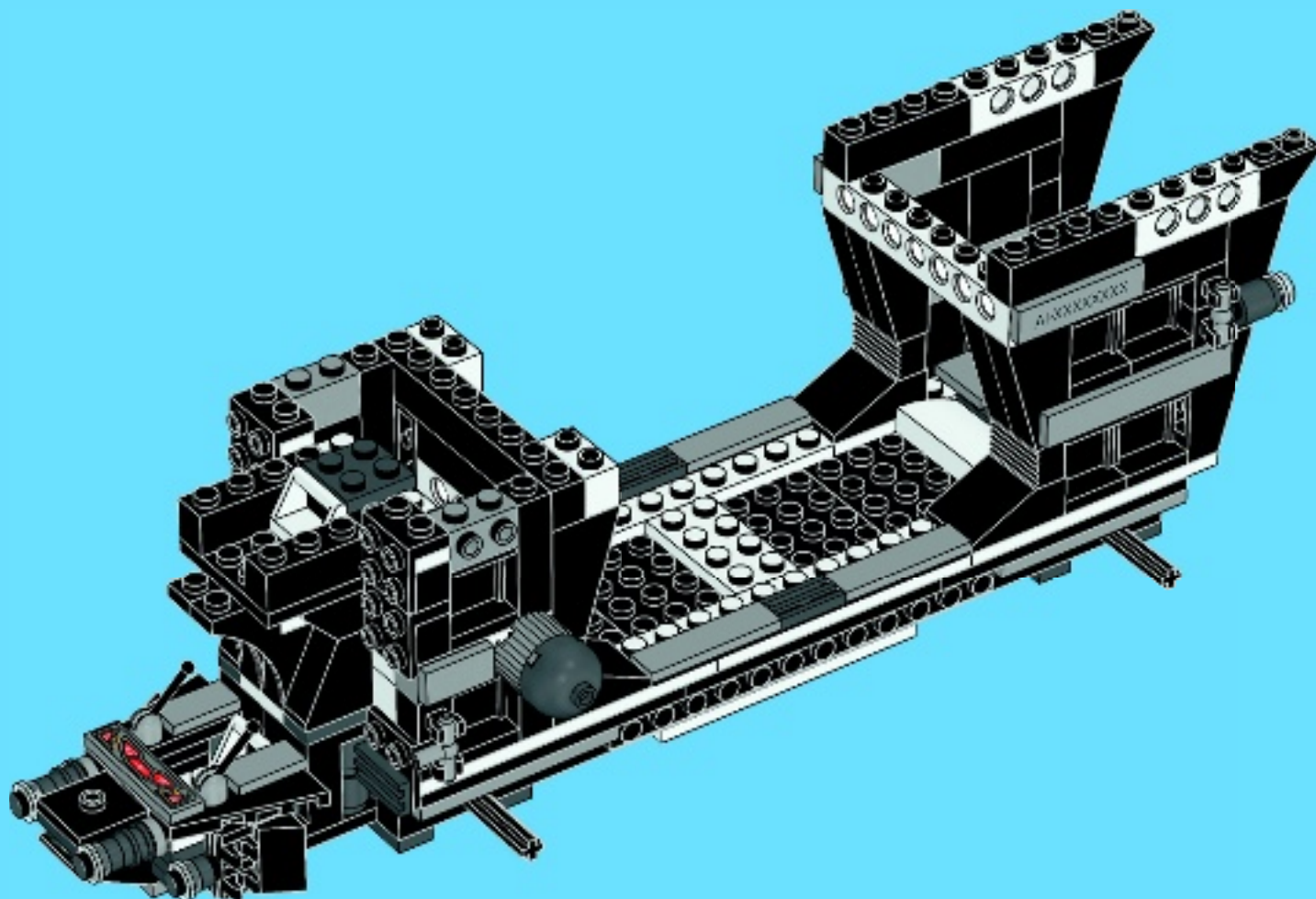



2x



2x

61

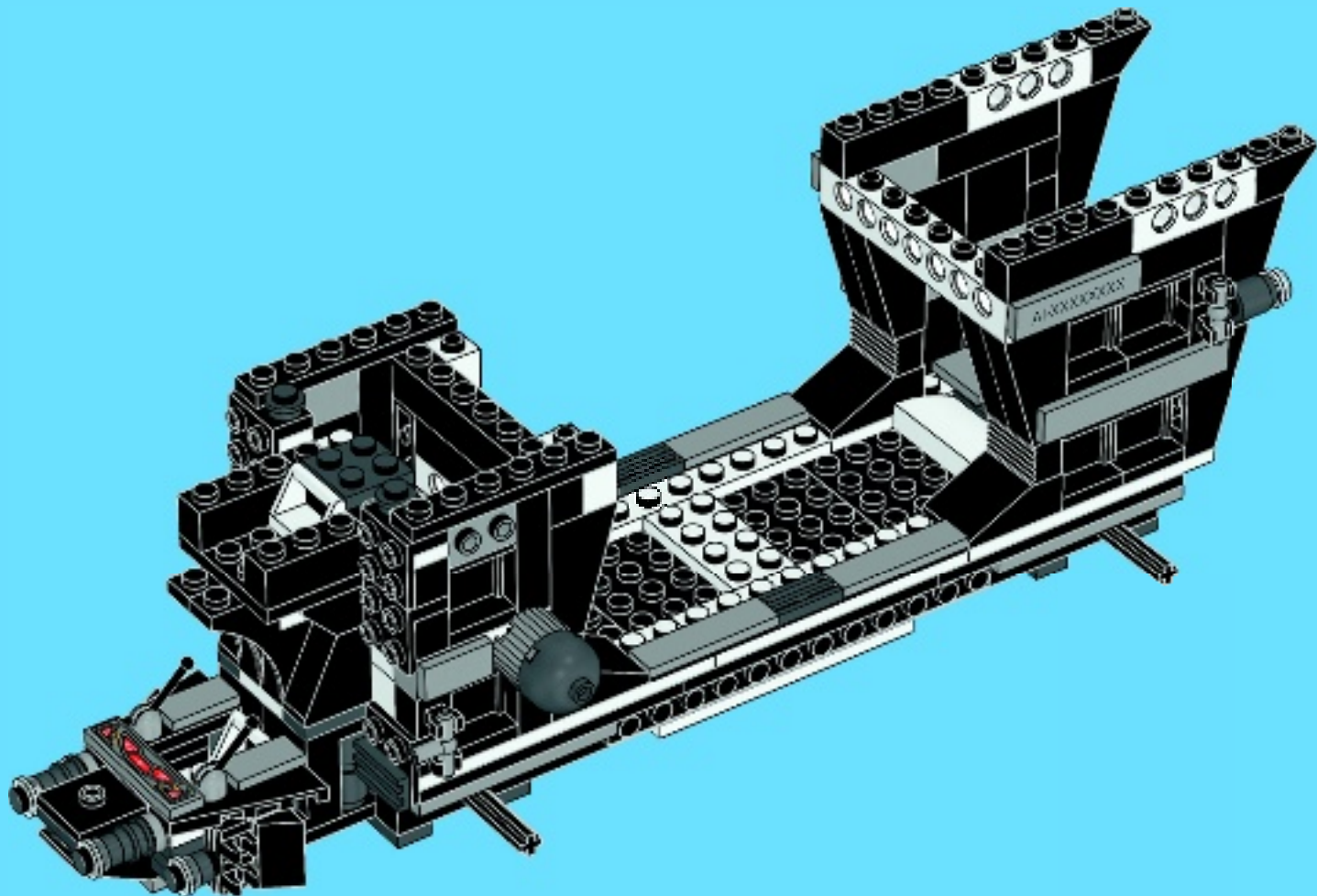



2x

62

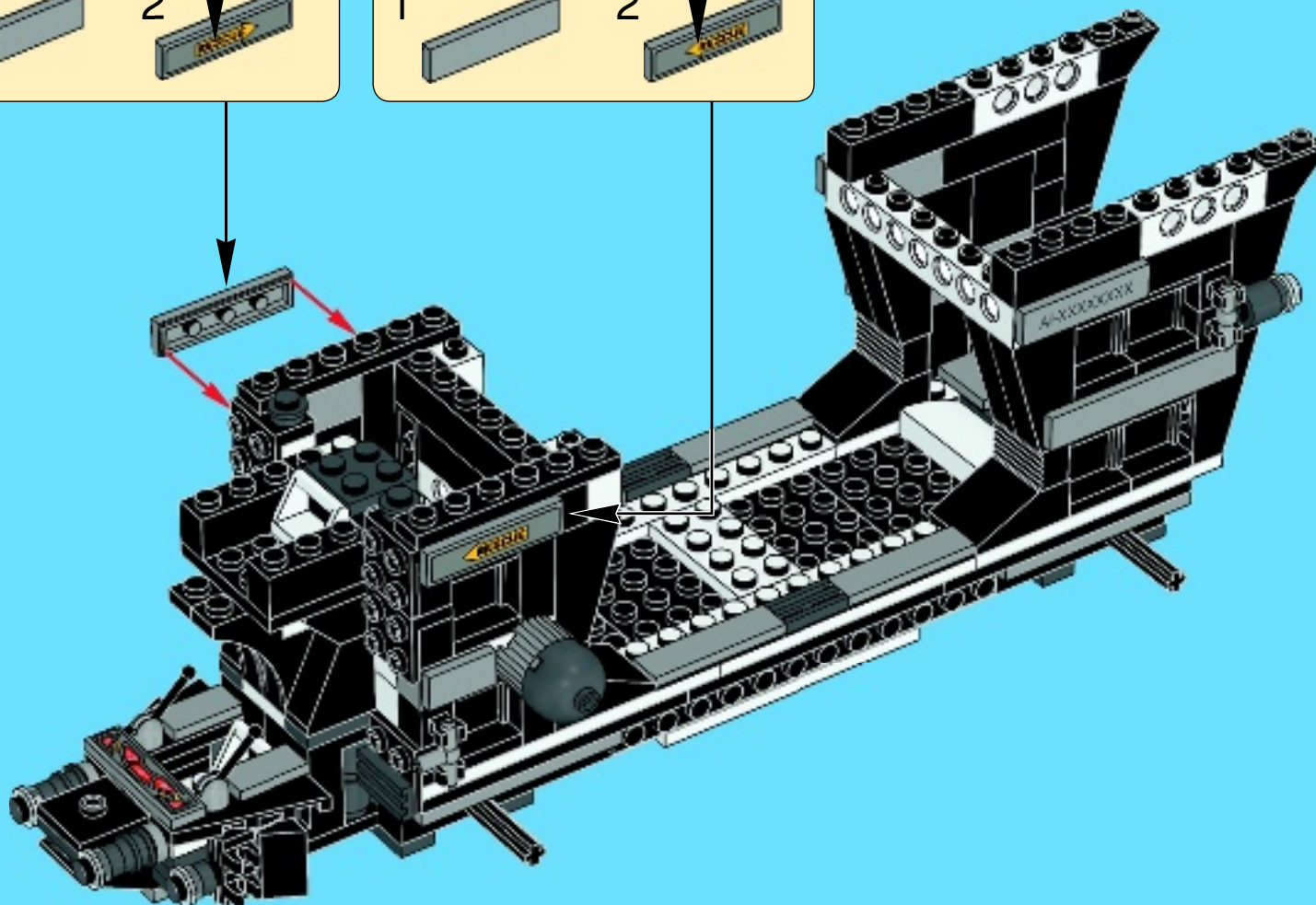
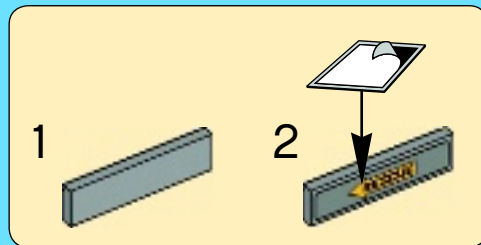
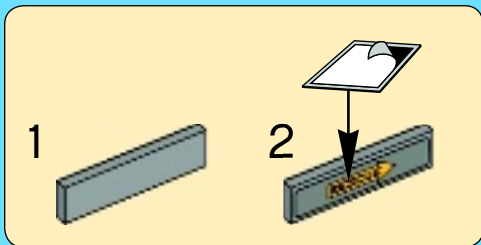



2x



2x

64

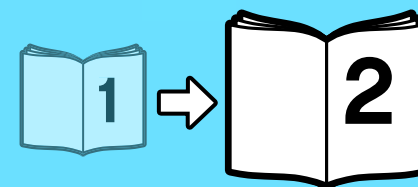
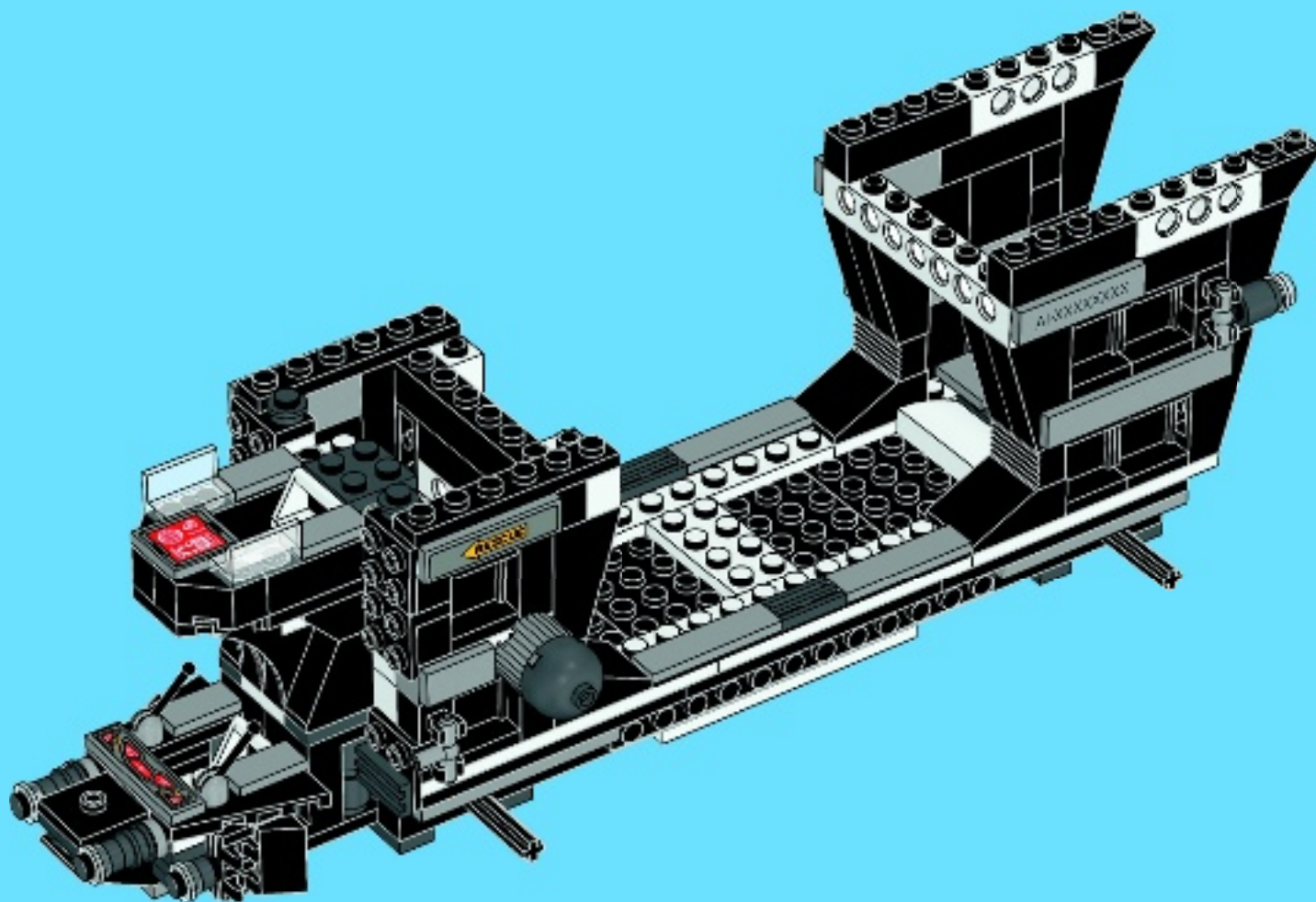



70805



70814



70815



70816

WIN

GO TO WWW.LEGO.COM/PRODUCTFEEDBACK AND GIVE US YOUR SHORT **FEEDBACK** ABOUT THIS LEGO® SET FOR A CHANCE TO WIN A COOL LEGO PRIZE.



LEGO.com/productfeedback

GEWINNE



Erzähle uns auf www.LEGO.com/productfeedback

etwas über die Erfahrungen, die du mit diesem LEGO® Set gemacht hast, und sichere dir die Chance auf einen coolen LEGO Preis!

GAGNE



Rends-toi sur www.LEGO.com/productfeedback

et donne-nous quelques commentaires sur ce produit LEGO® pour avoir une chance de gagner un prix LEGO !

GANAN



Visita www.LEGO.com/productfeedback

y envíanos tu opinión acerca de este set LEGO®. ¡Participarás en el sorteo de un premio LEGO!

获取奖品



登录 www.LEGO.com/productfeedback

给出关于此乐高®套装的简短反馈，就有机会获得炫酷乐高奖品

경품 당첨 기회



www.LEGO.com/productfeedback

페이지로 이동하여 이 레고® 세트에 대한 간략한 피드백을 보내 주시고 멋진 레고 경품을 탈 수 있는 기회도 잡으십시오

ЗАПОЛНИ АНКЕТУ И ПОЛУЧИ ПРИЗ



Перейди по ссылке www.LEGO.com/productfeedback

ответь всего на несколько вопросов об этом наборе LEGO®, и у тебя появится шанс выиграть замечательный приз от компании LEGO.



THE LEGO MOVIE

70815





3



1x



3x



2x

65

1



2



3

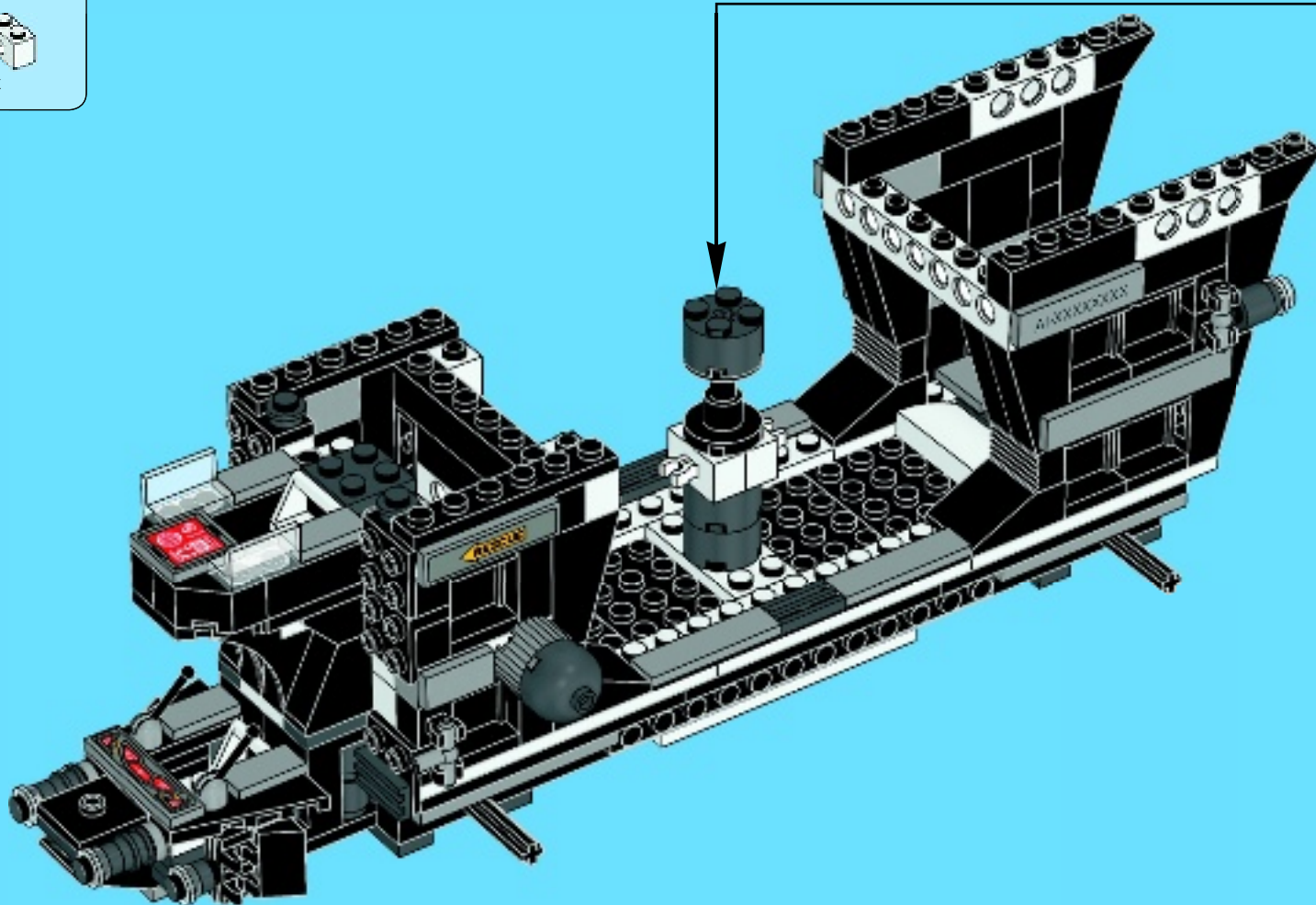

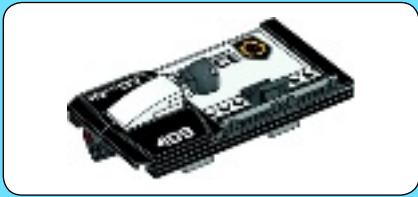

1

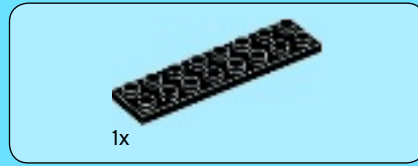

2

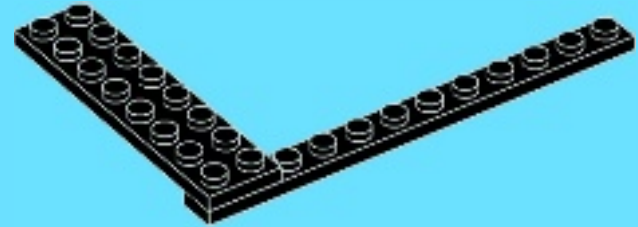

3

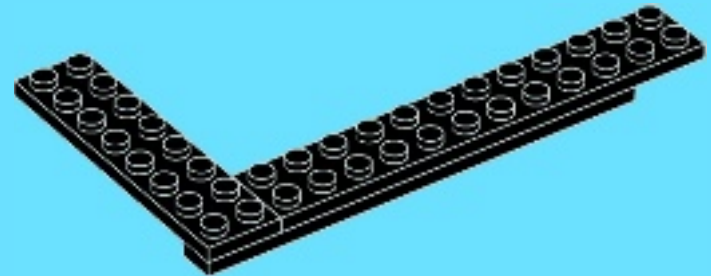



4

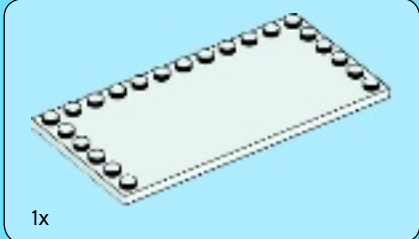
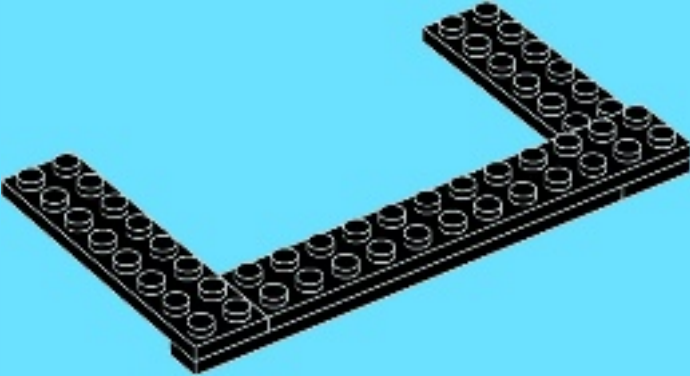

5

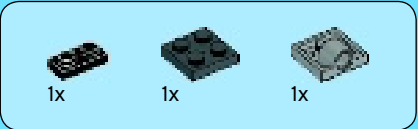
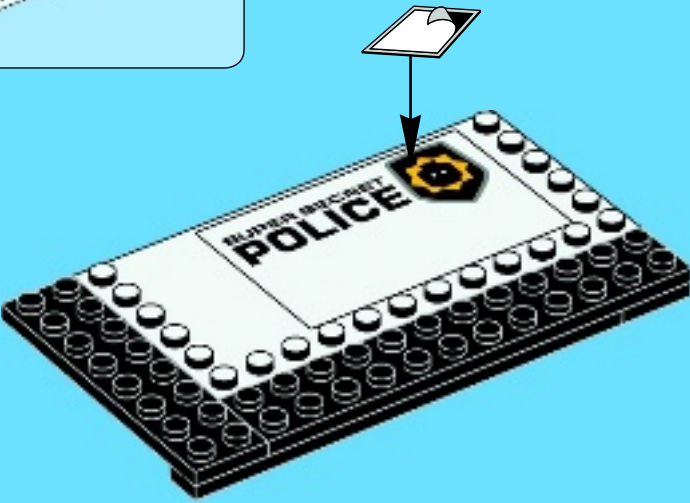

6

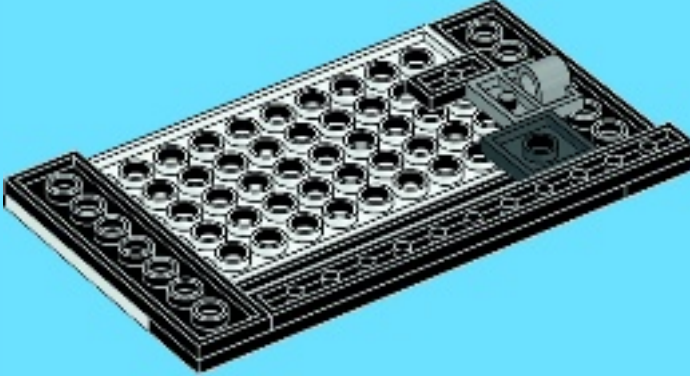

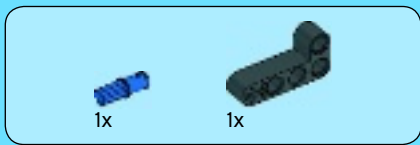

7

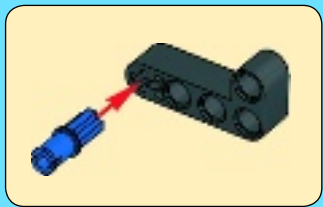
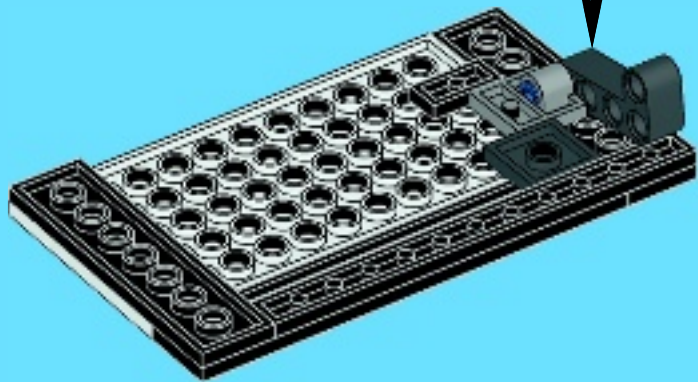

8

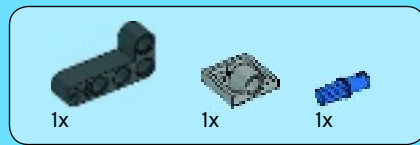
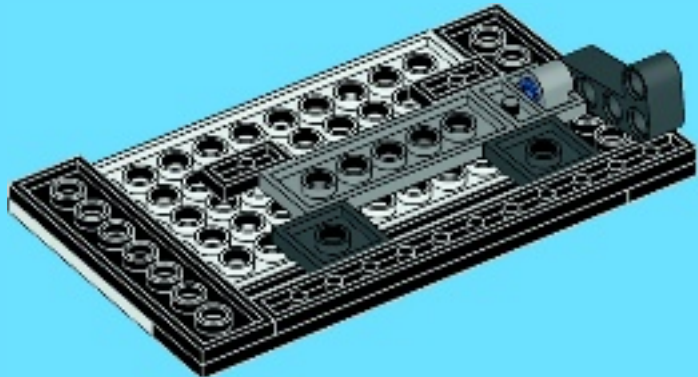

9

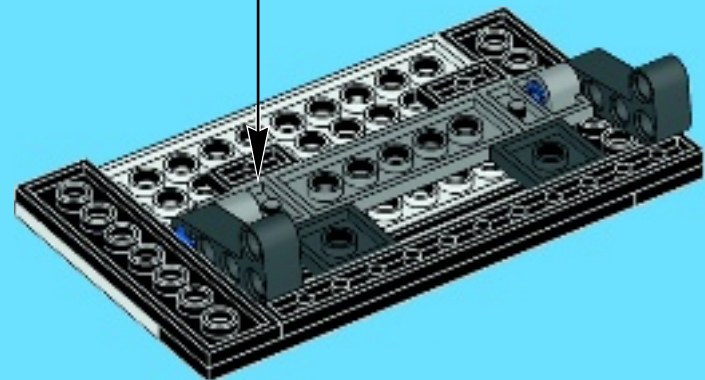
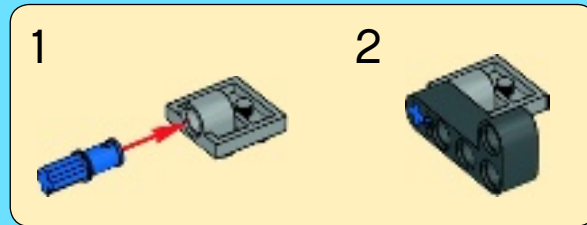



2x

10

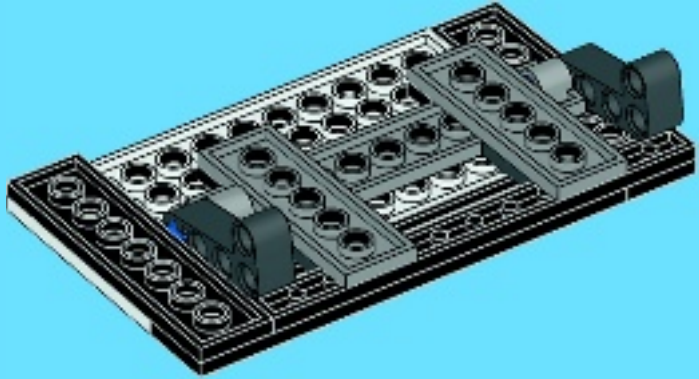

2x

11

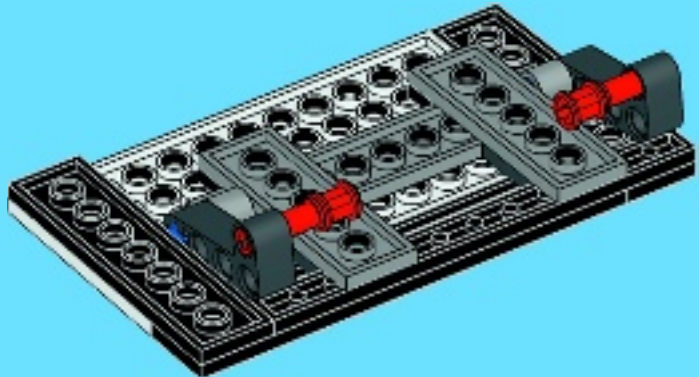

1x



2x



4x

12

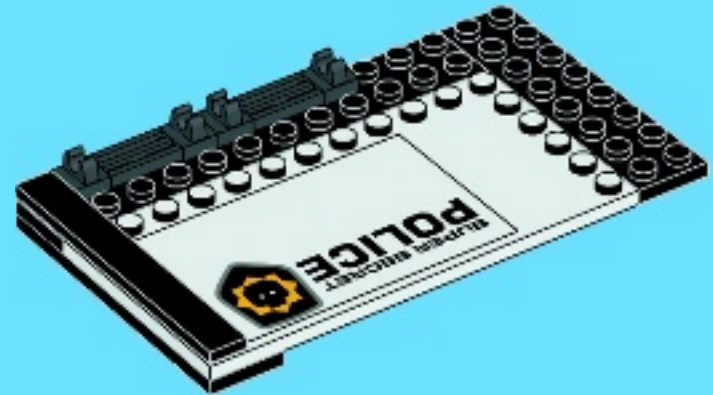
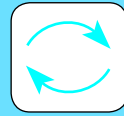

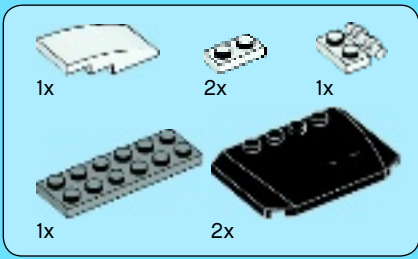

13

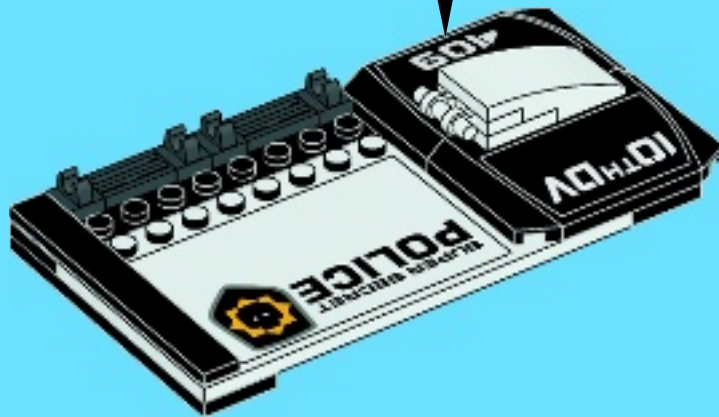
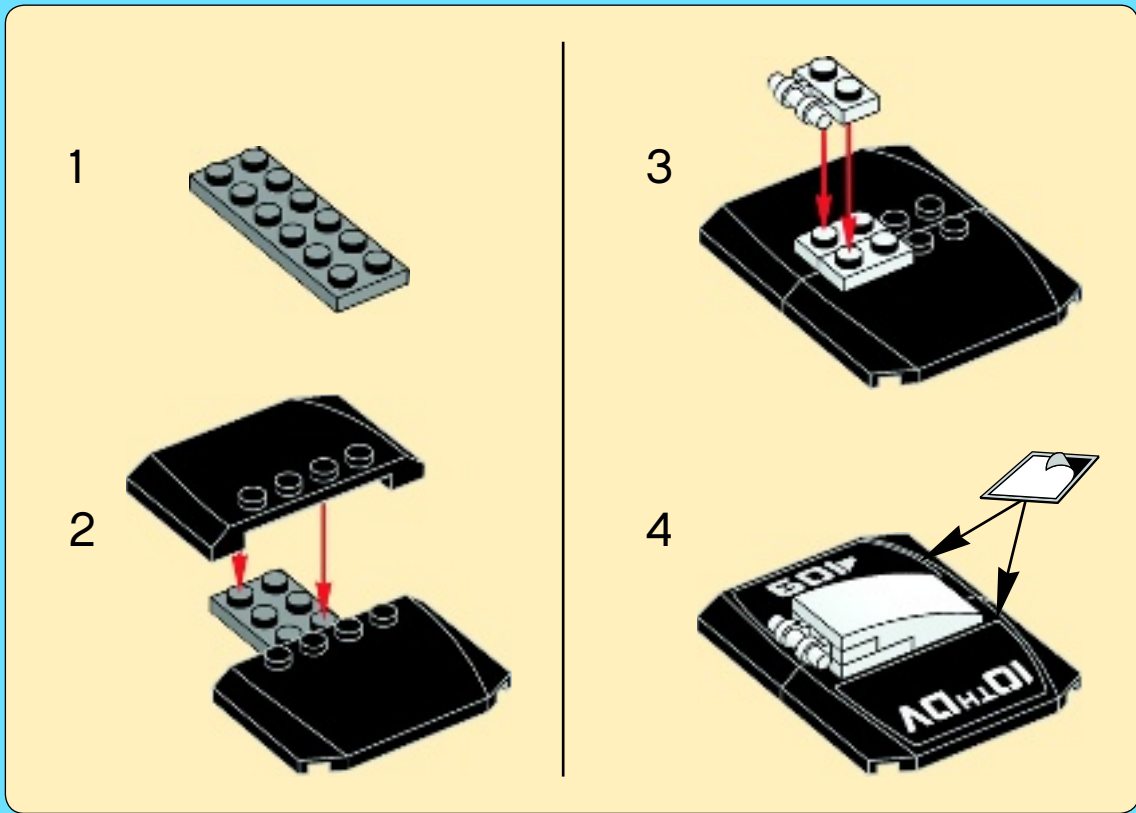

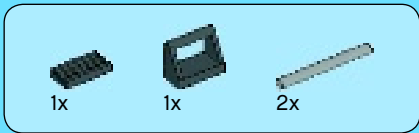

14

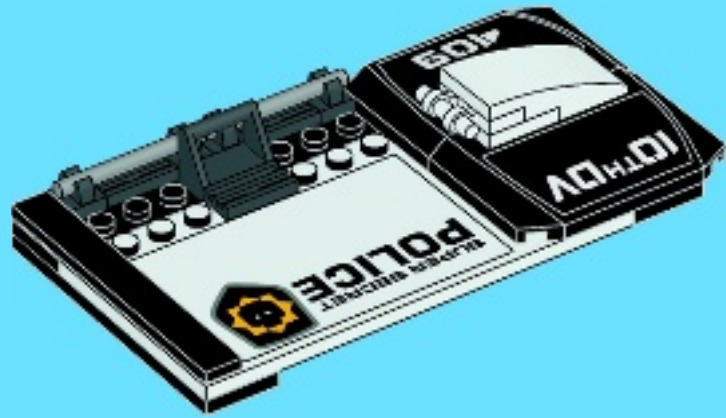

15

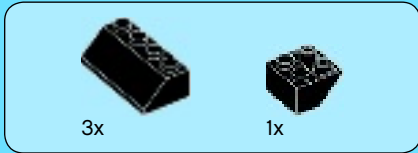
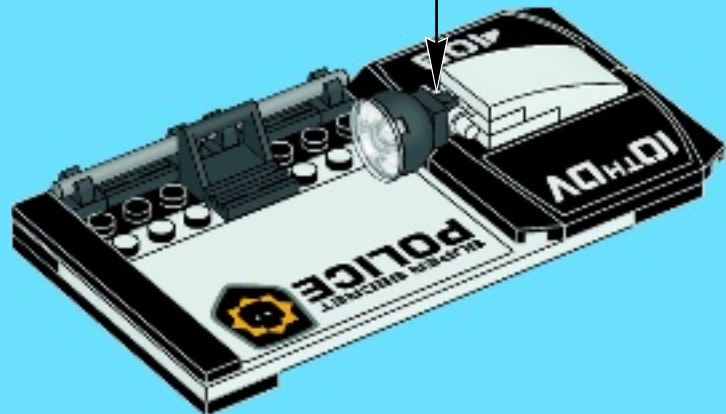
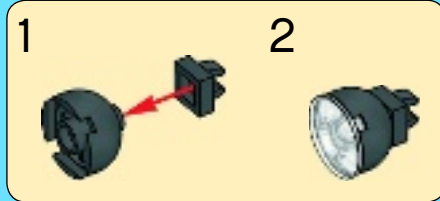

16

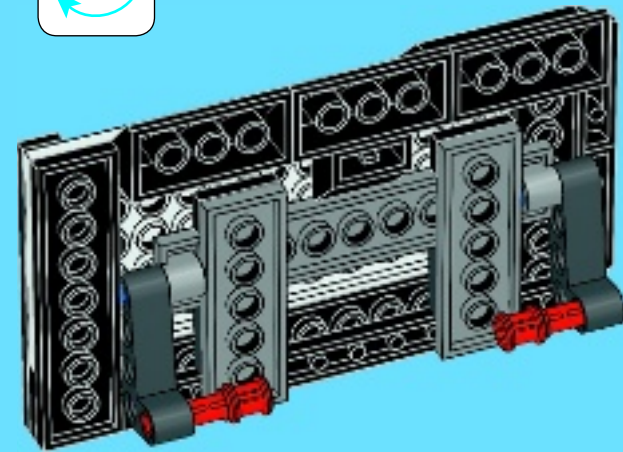
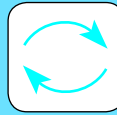



17

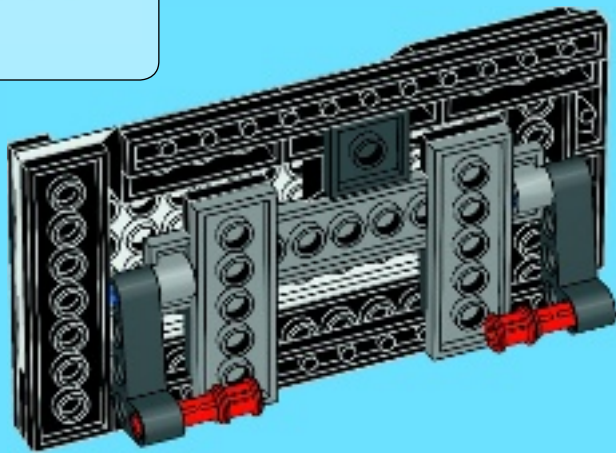

18

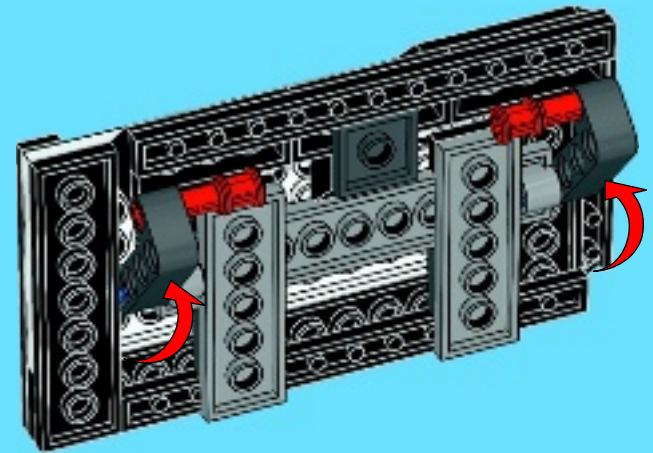

66

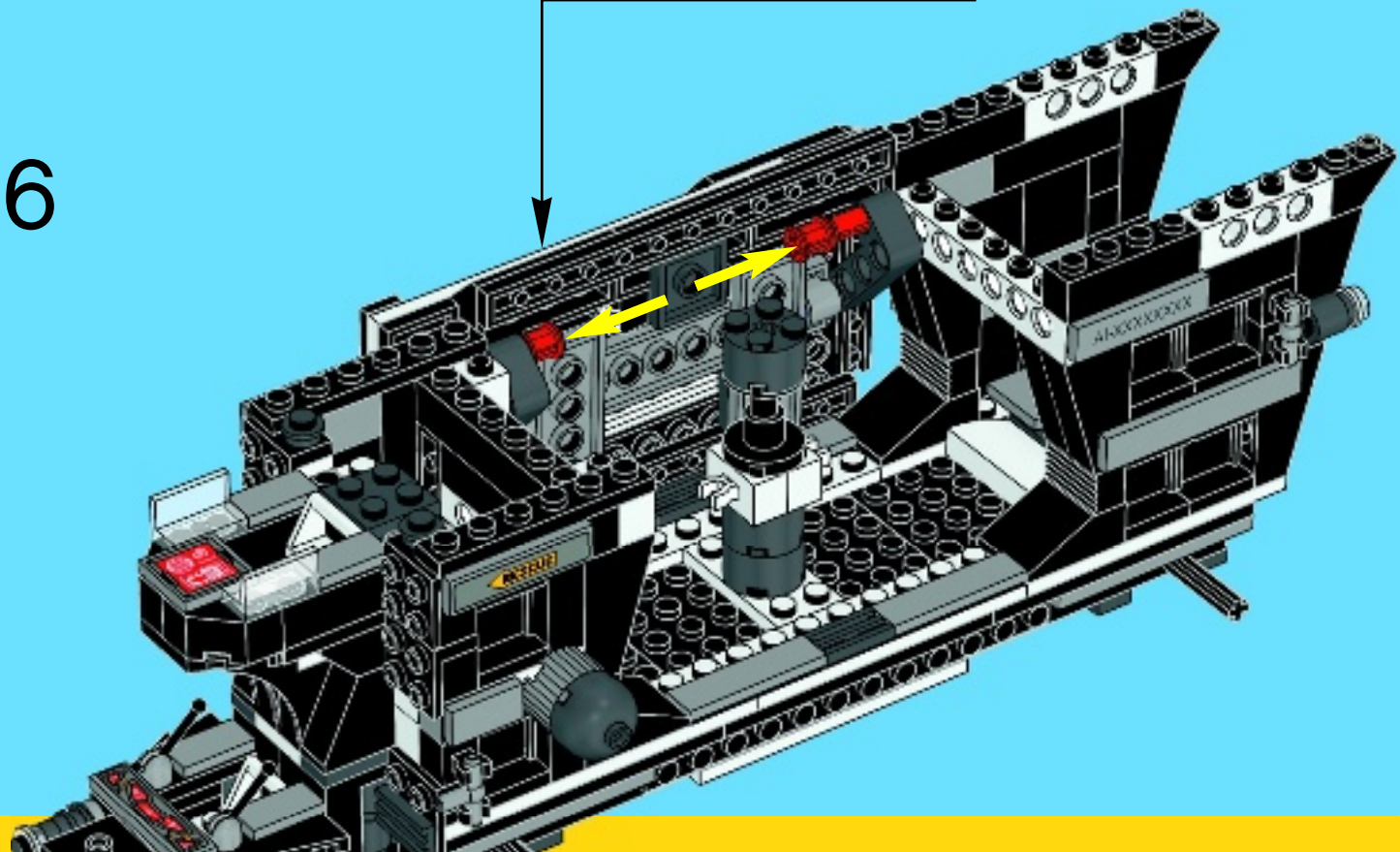

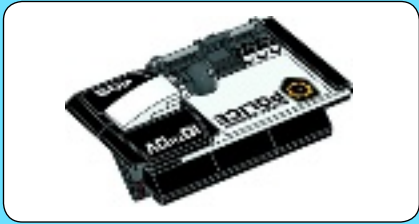

1

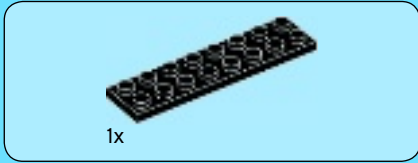

2

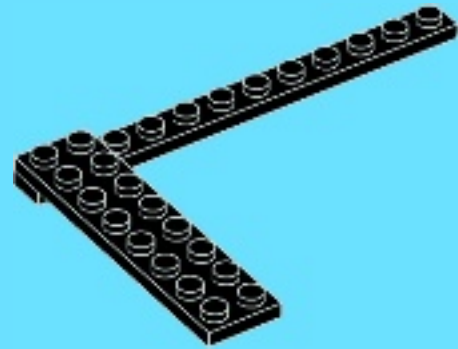

3

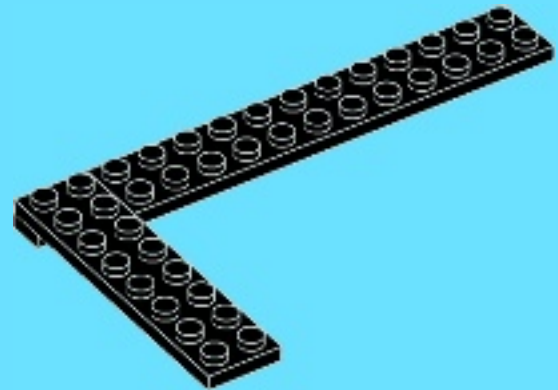

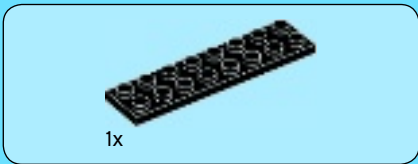

4

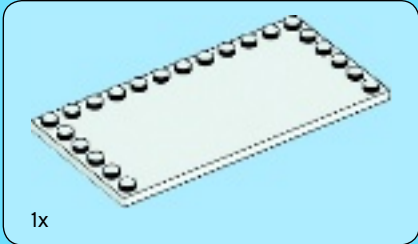
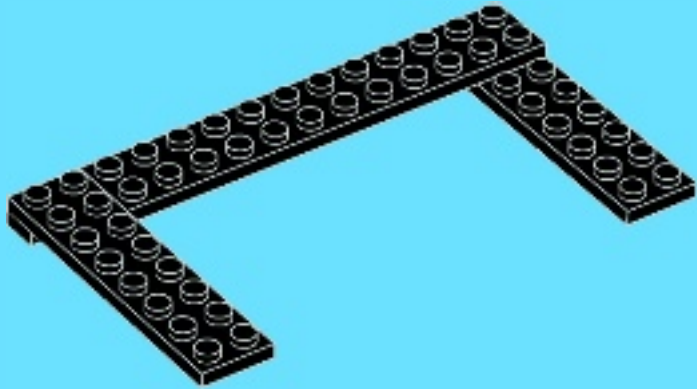

5

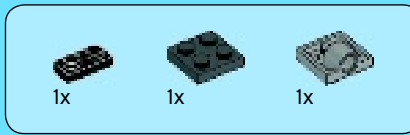
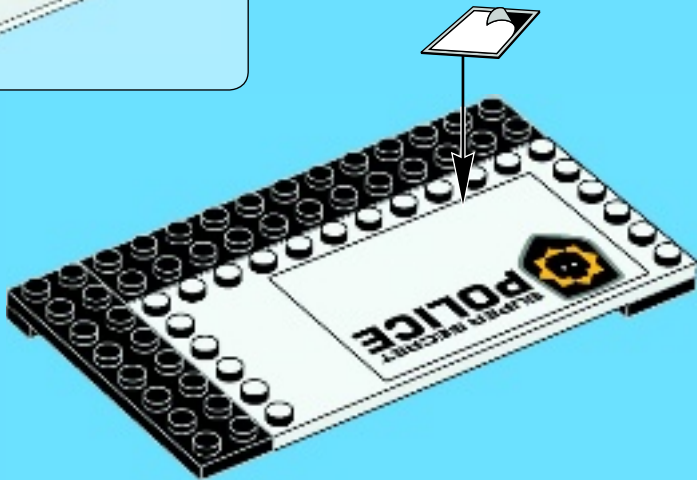

6

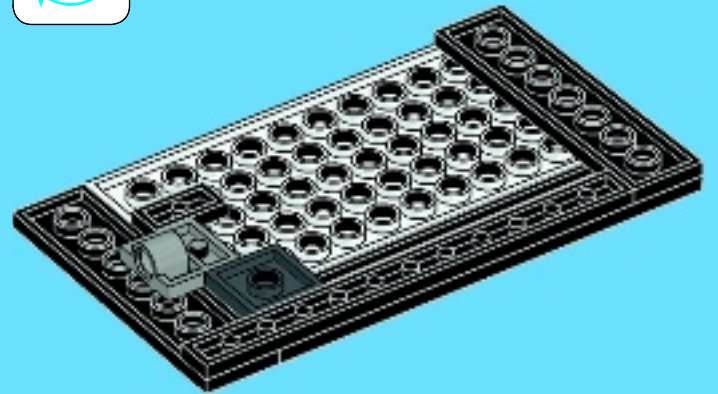
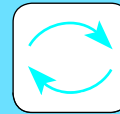

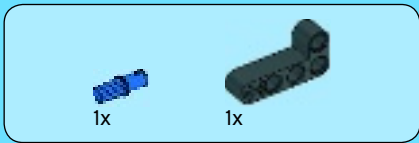

7

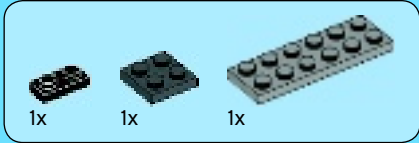
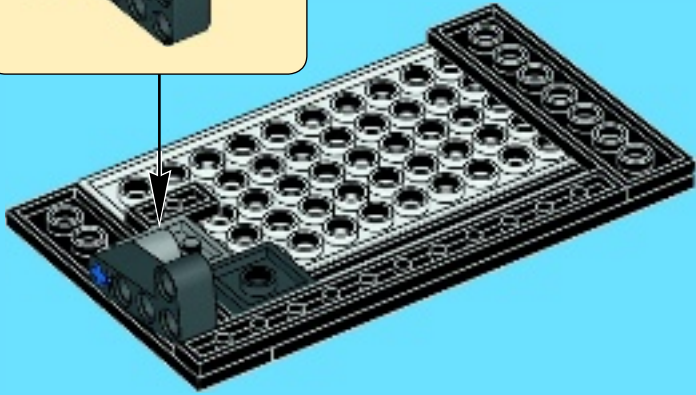
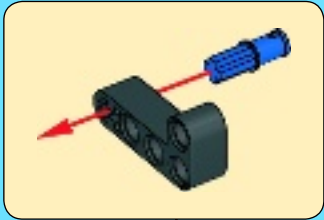

8

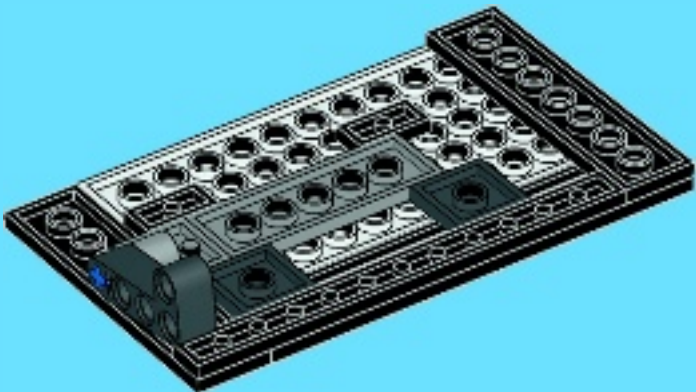

9

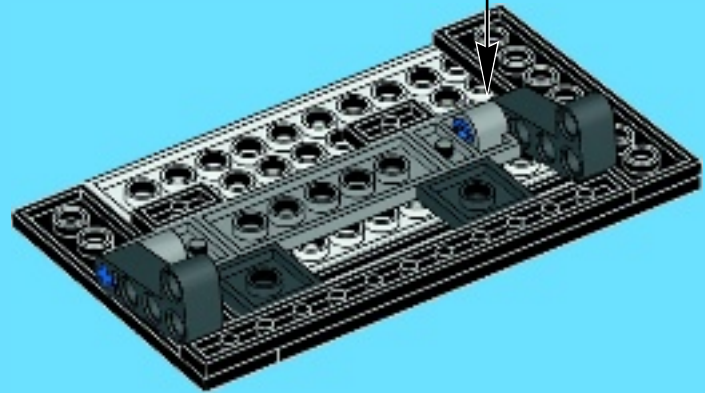
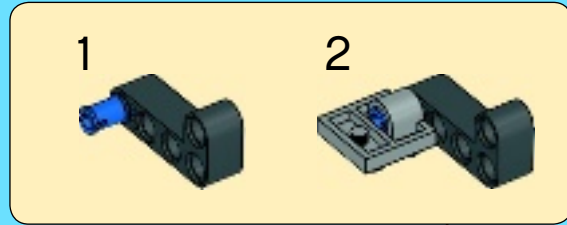



2x

10

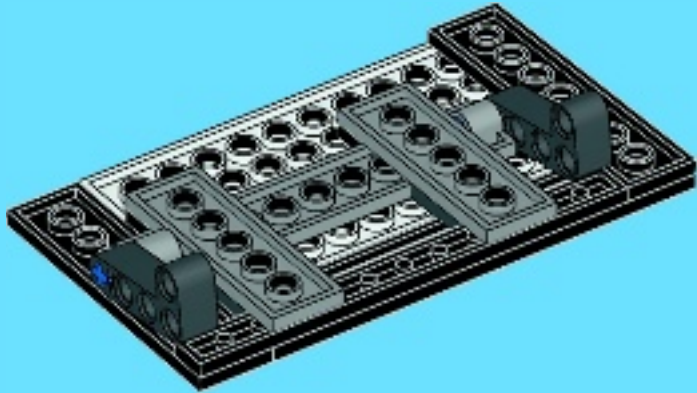

2x

11

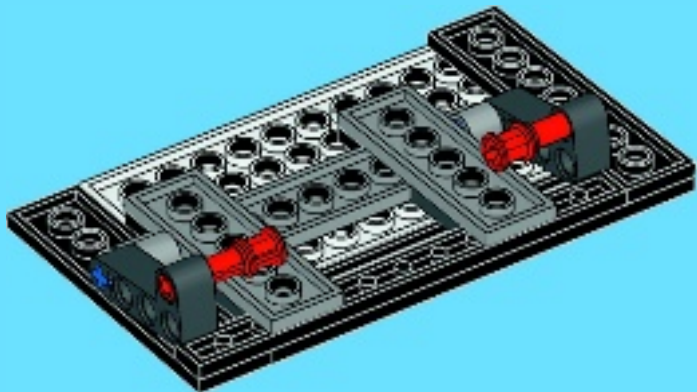

1x



2x



4x

12

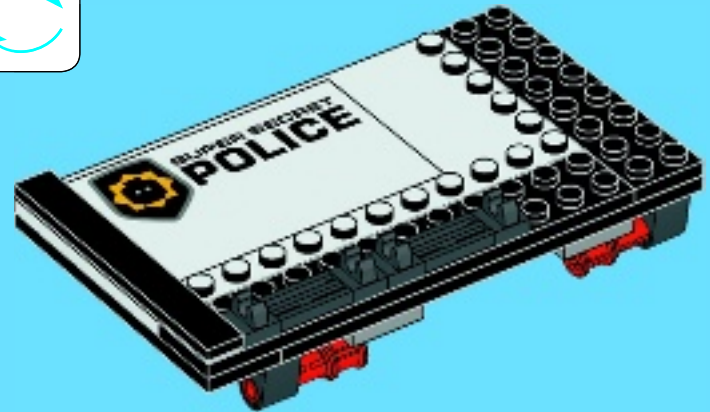
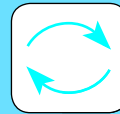

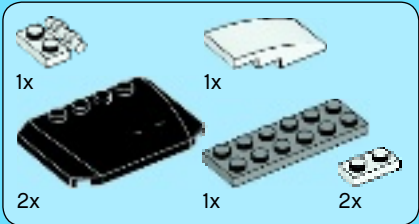

13

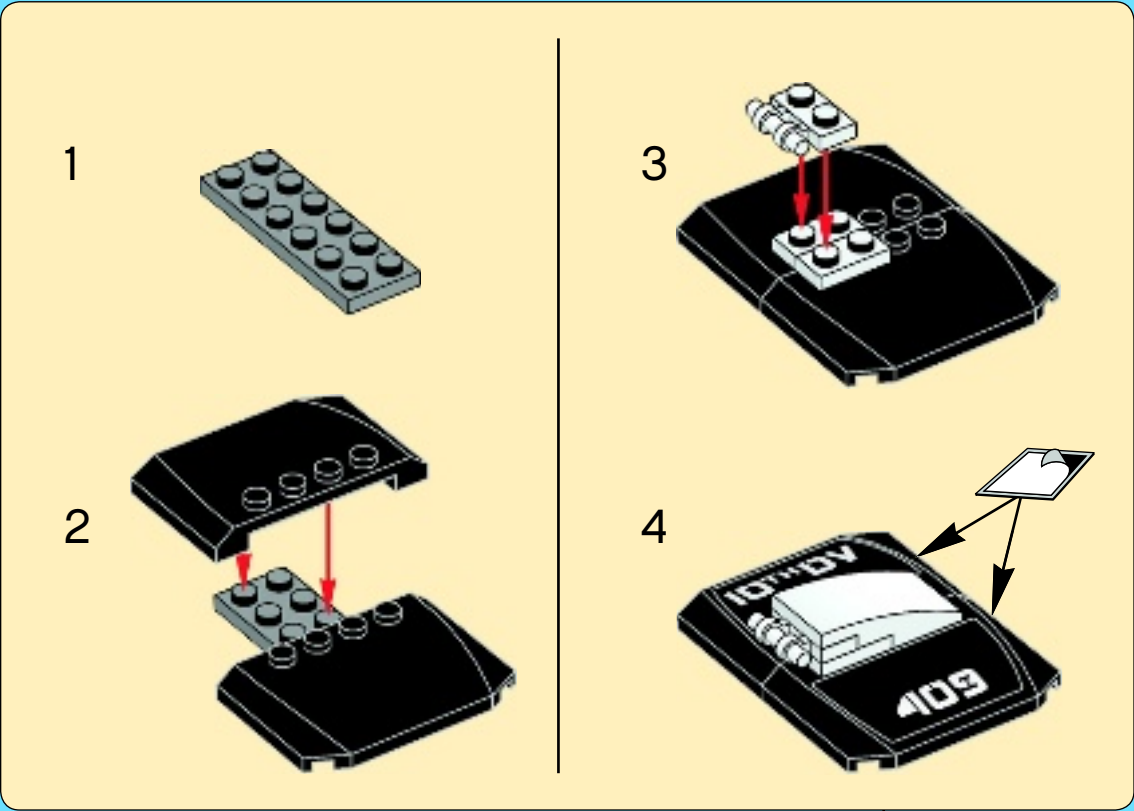

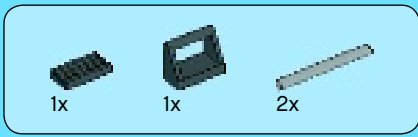

14

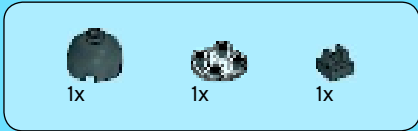

15

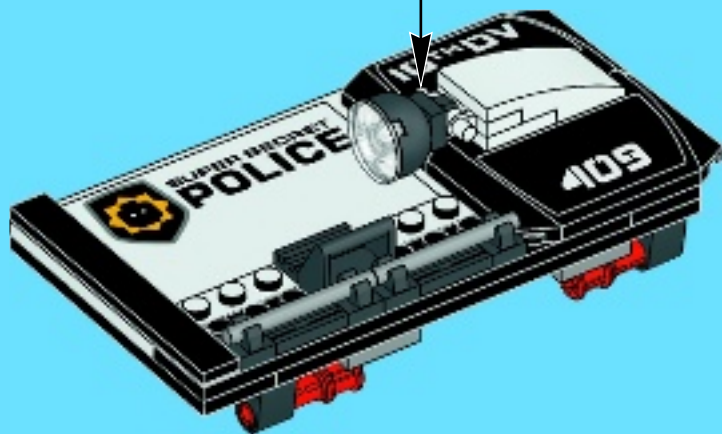
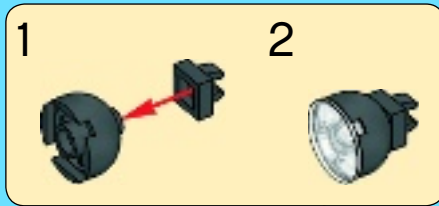

16

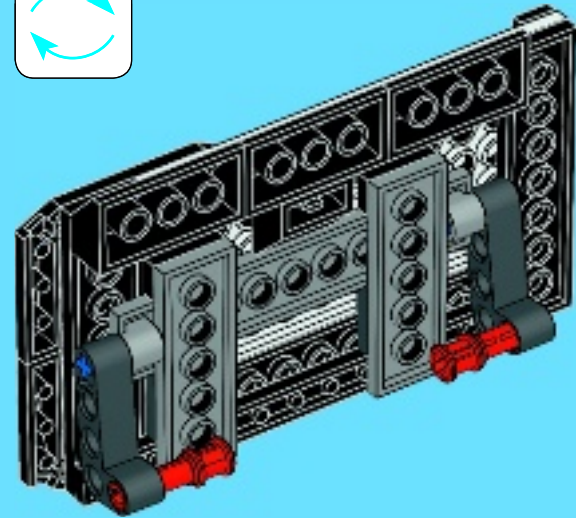
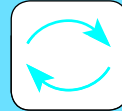



17

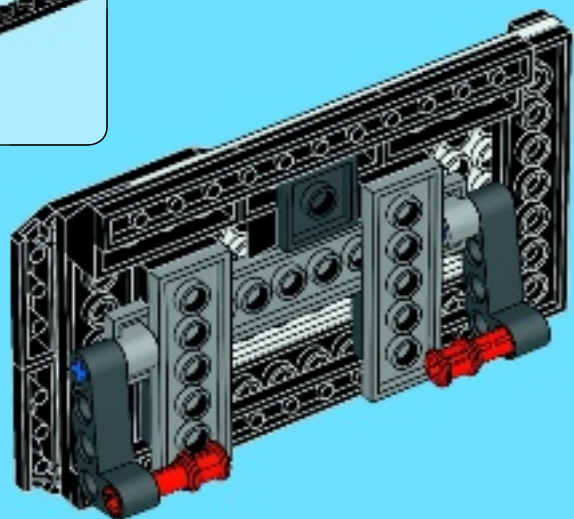

18

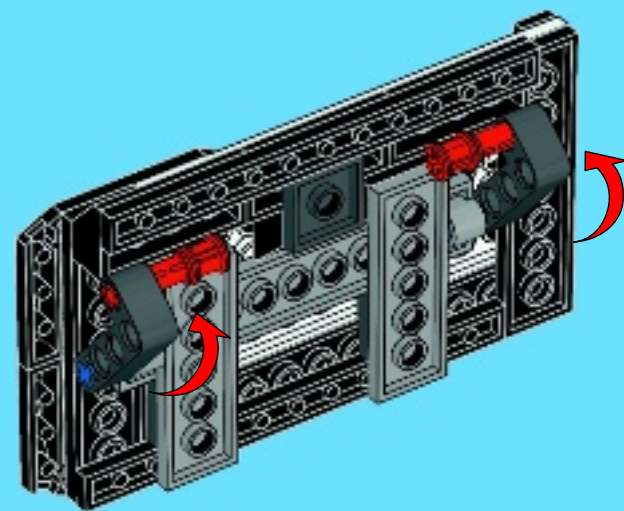

67

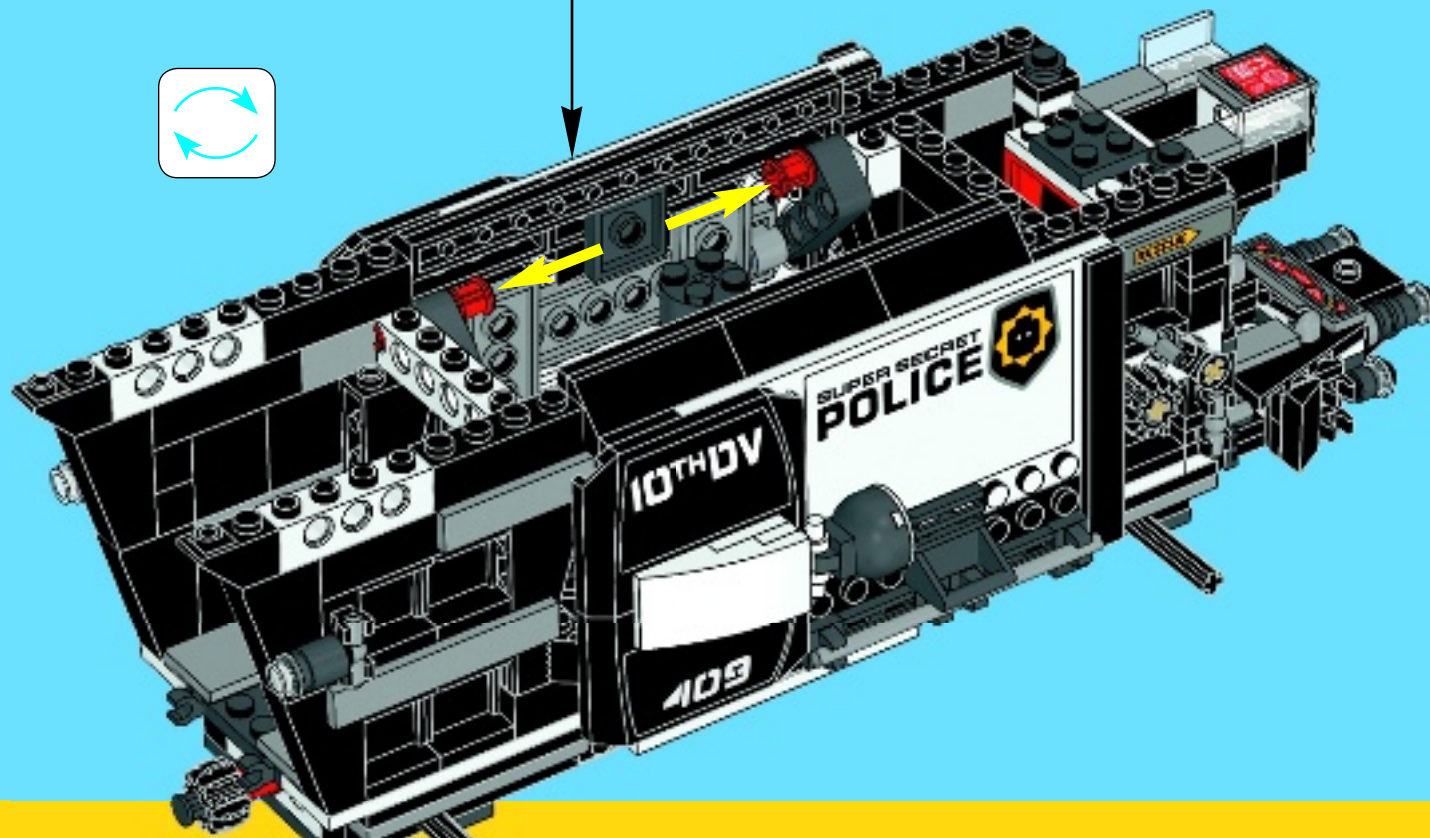
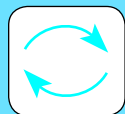

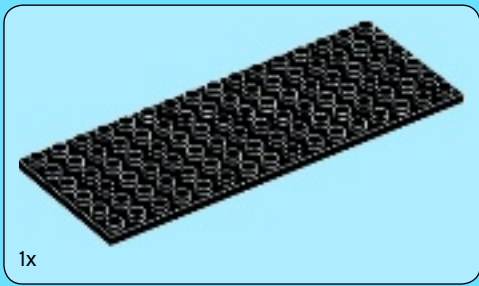

68

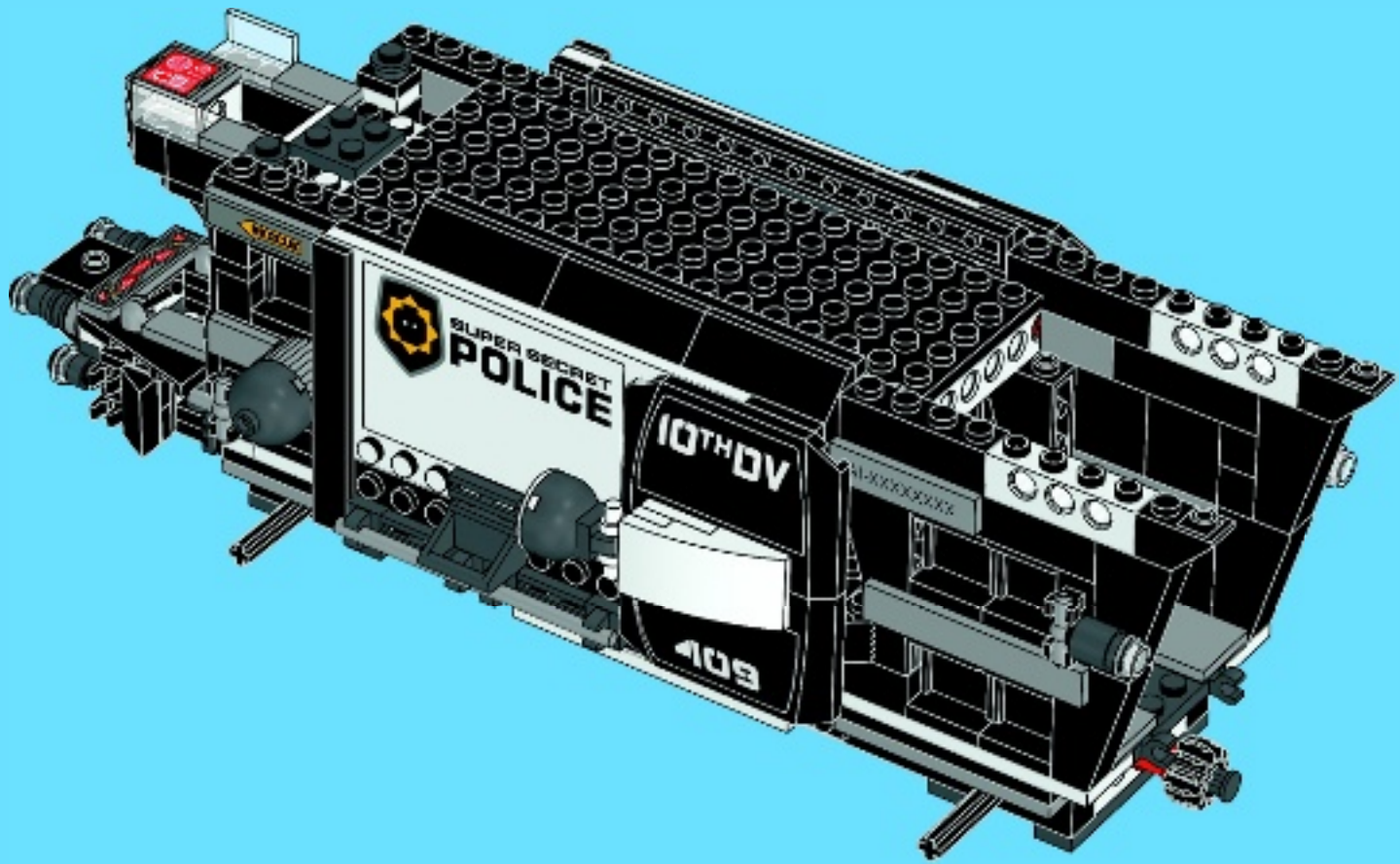
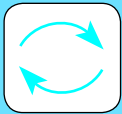



1

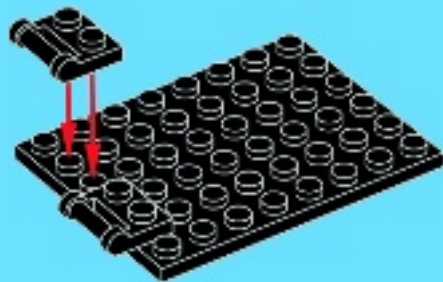

2

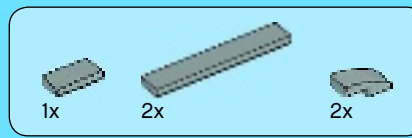

3

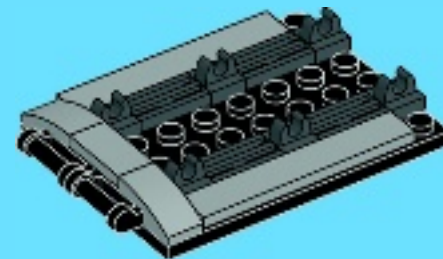



3x

4

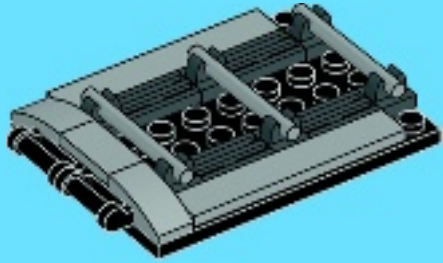

4x

5

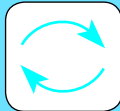

2x

6



69

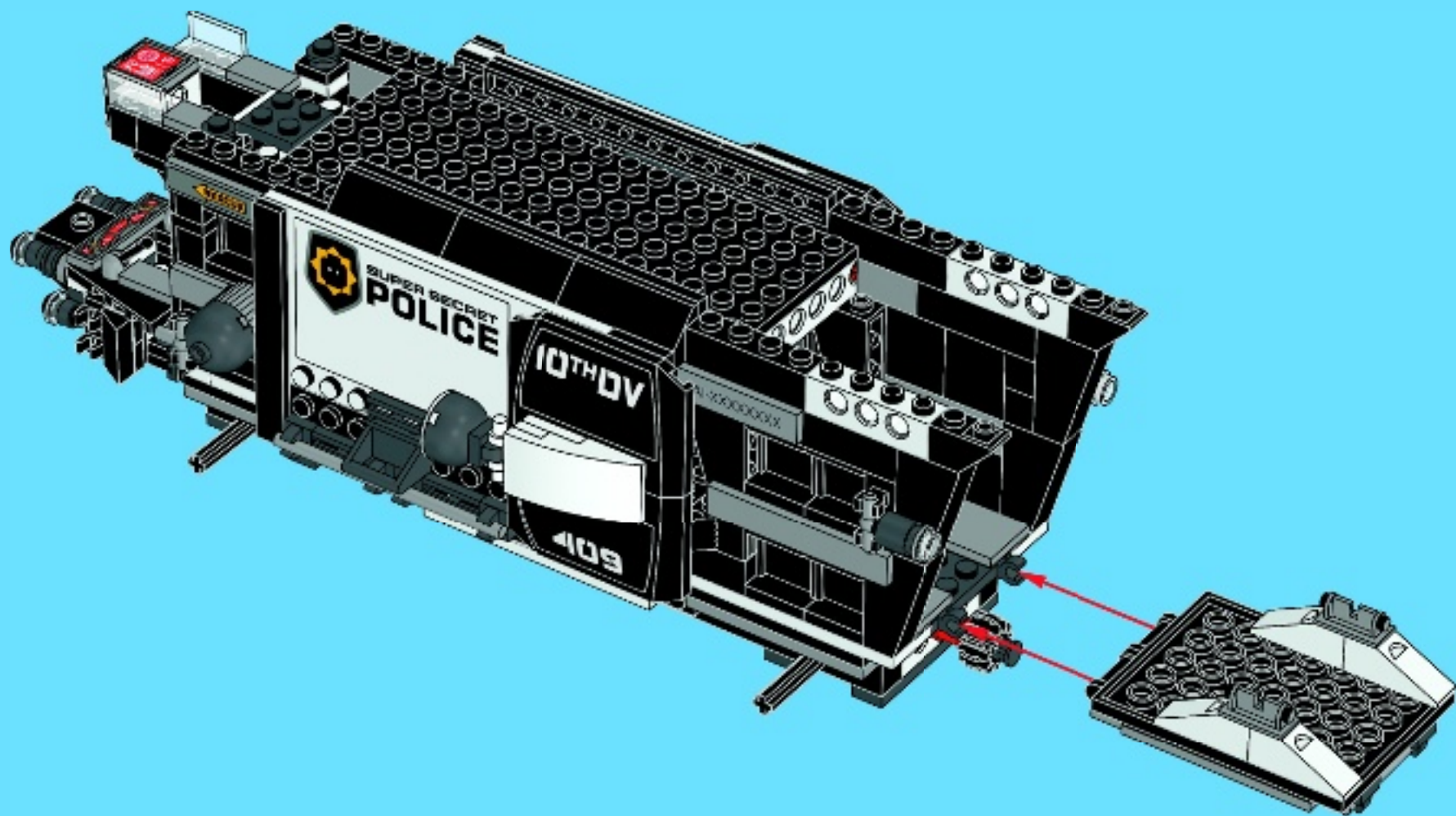



4

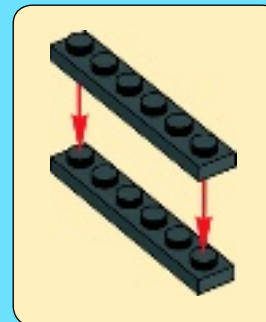
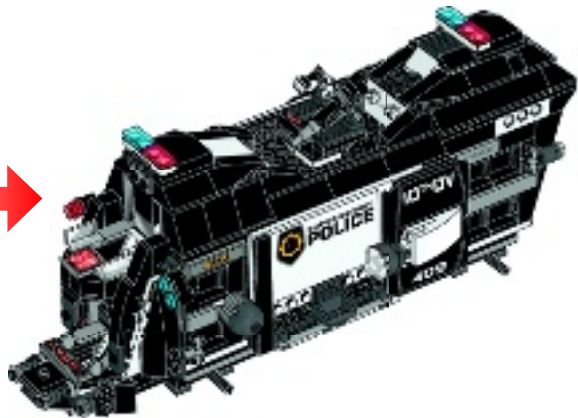

2x

70

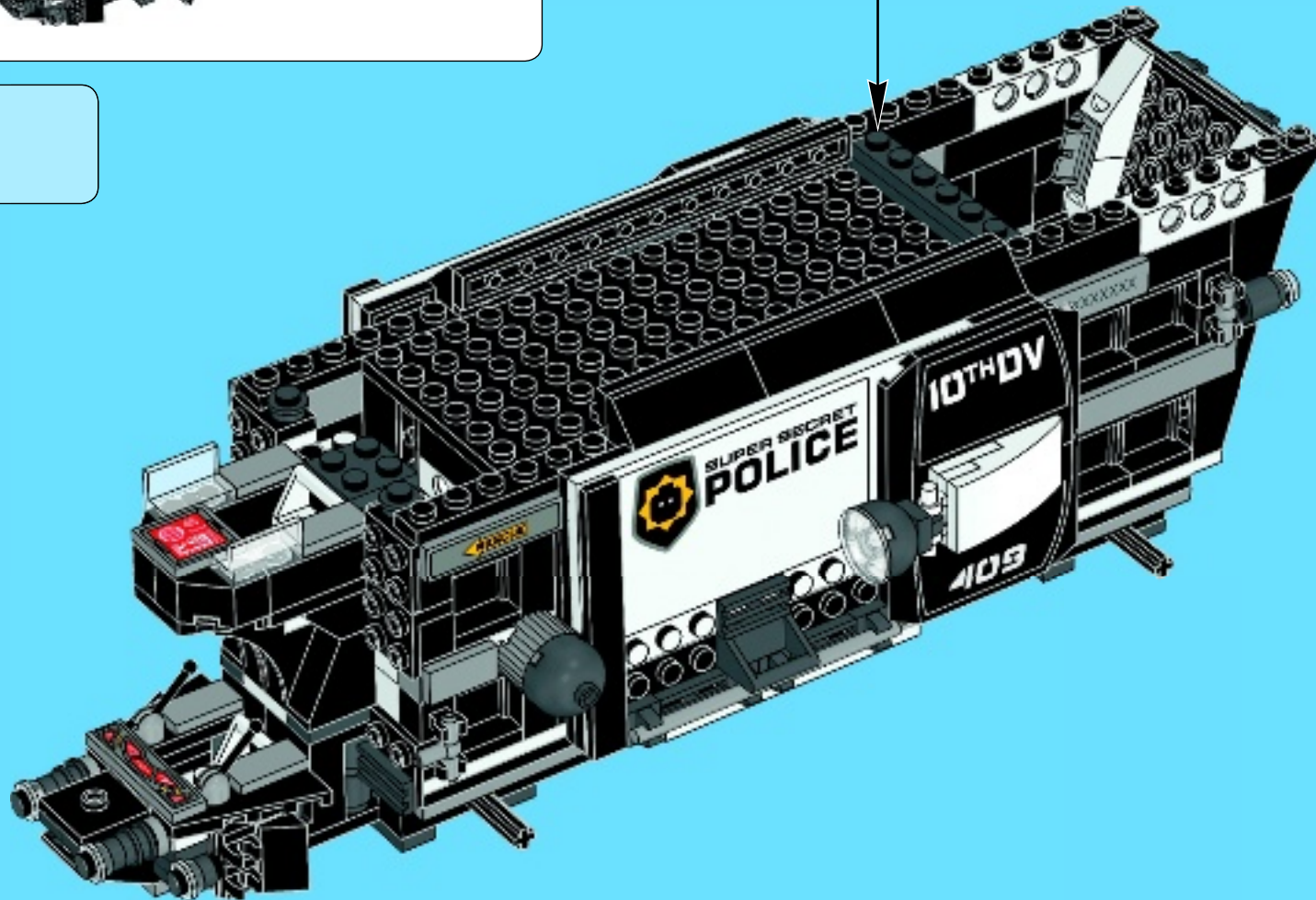



2x



1x

71

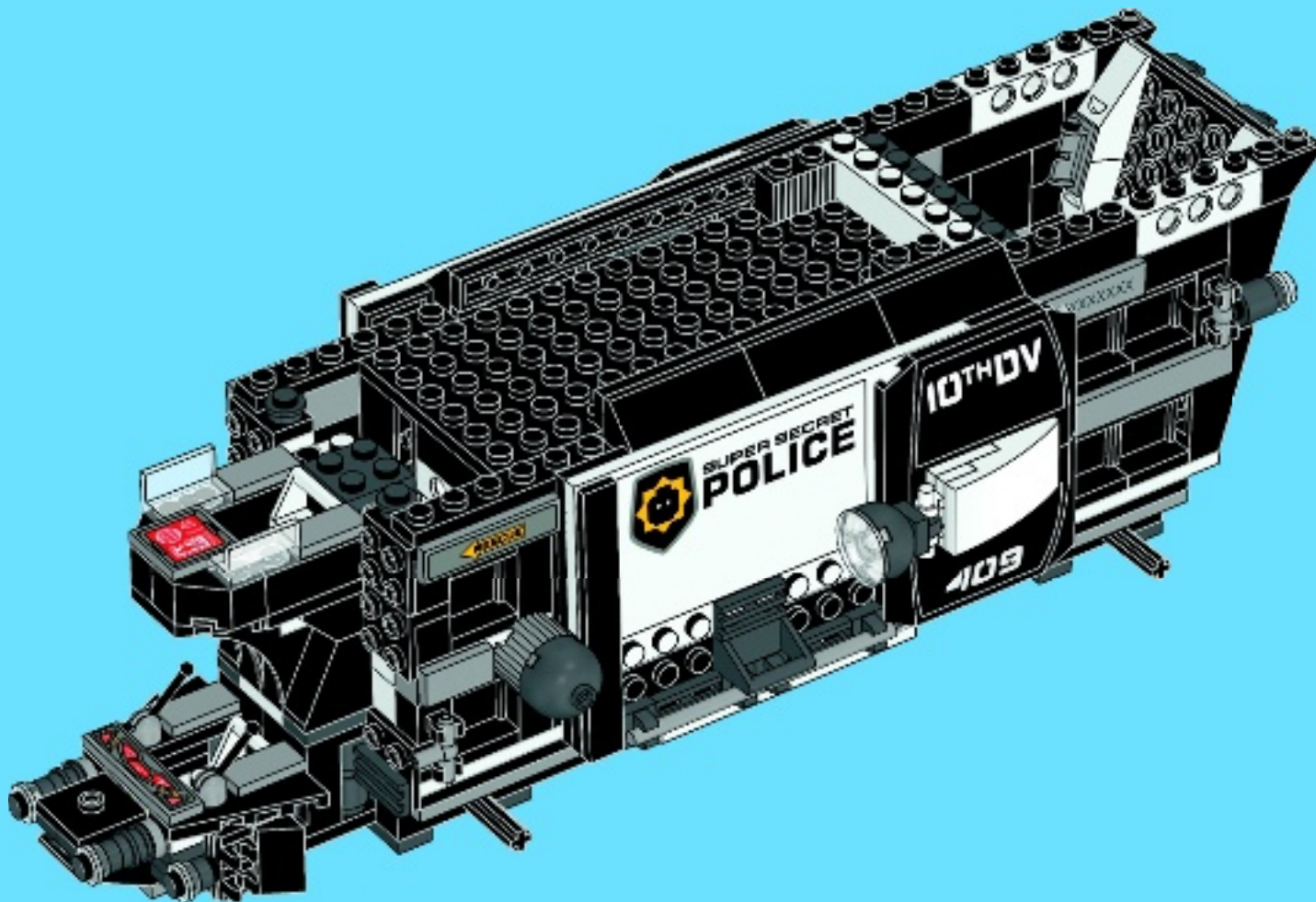



2x



2x

72

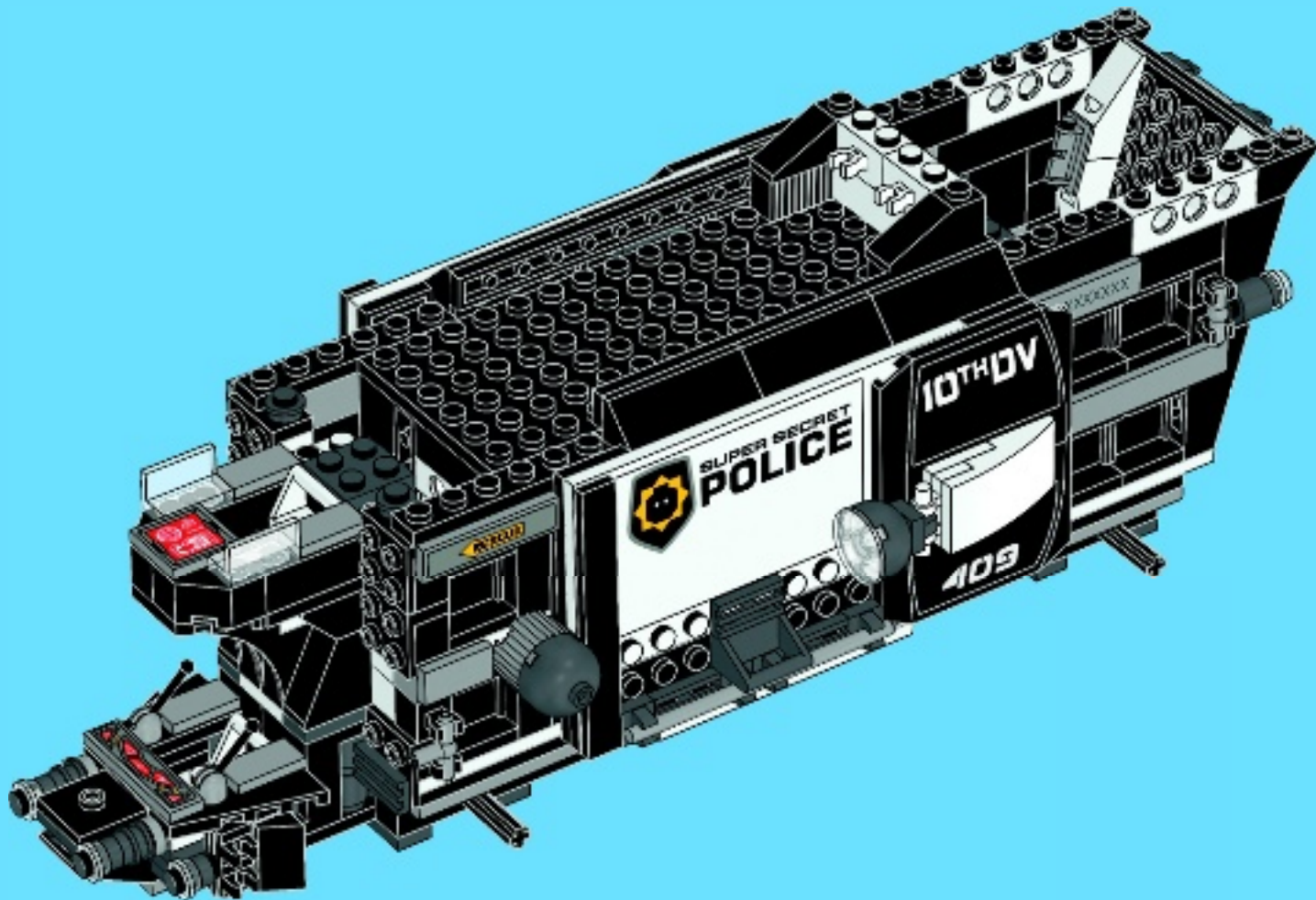

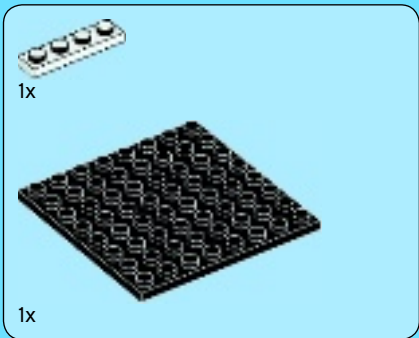

1



2



3

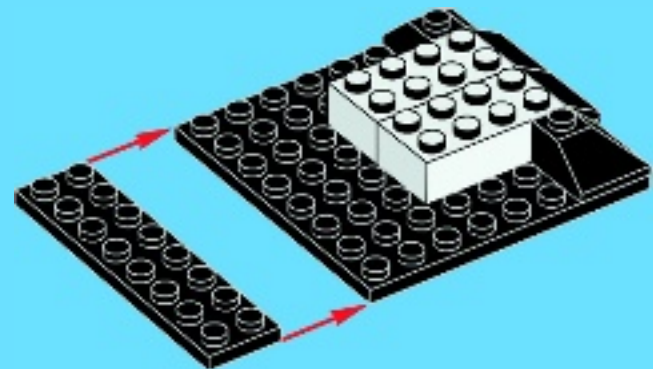

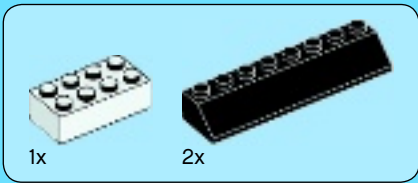

4

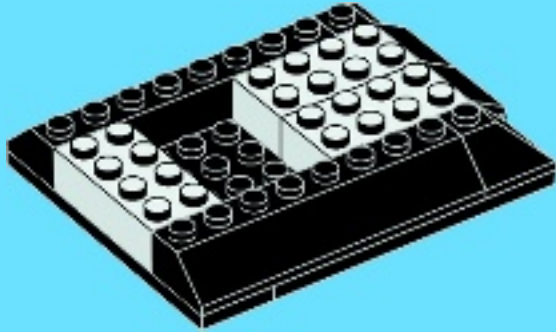

5

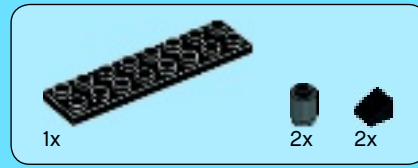
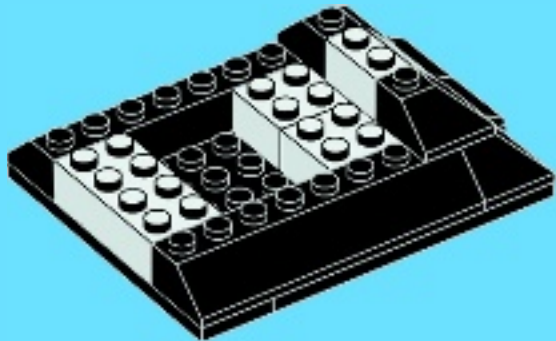

6

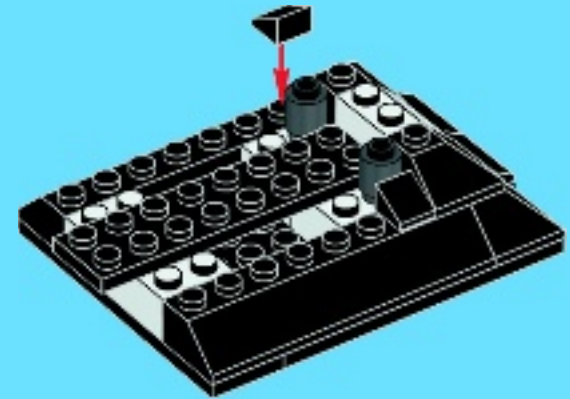

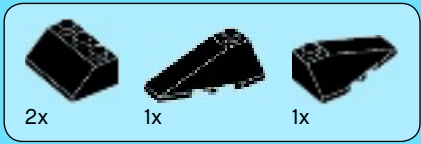

7

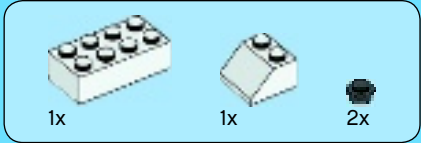

8

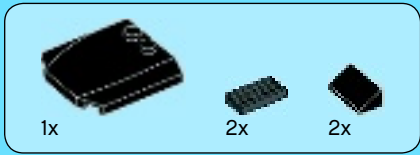

9



73

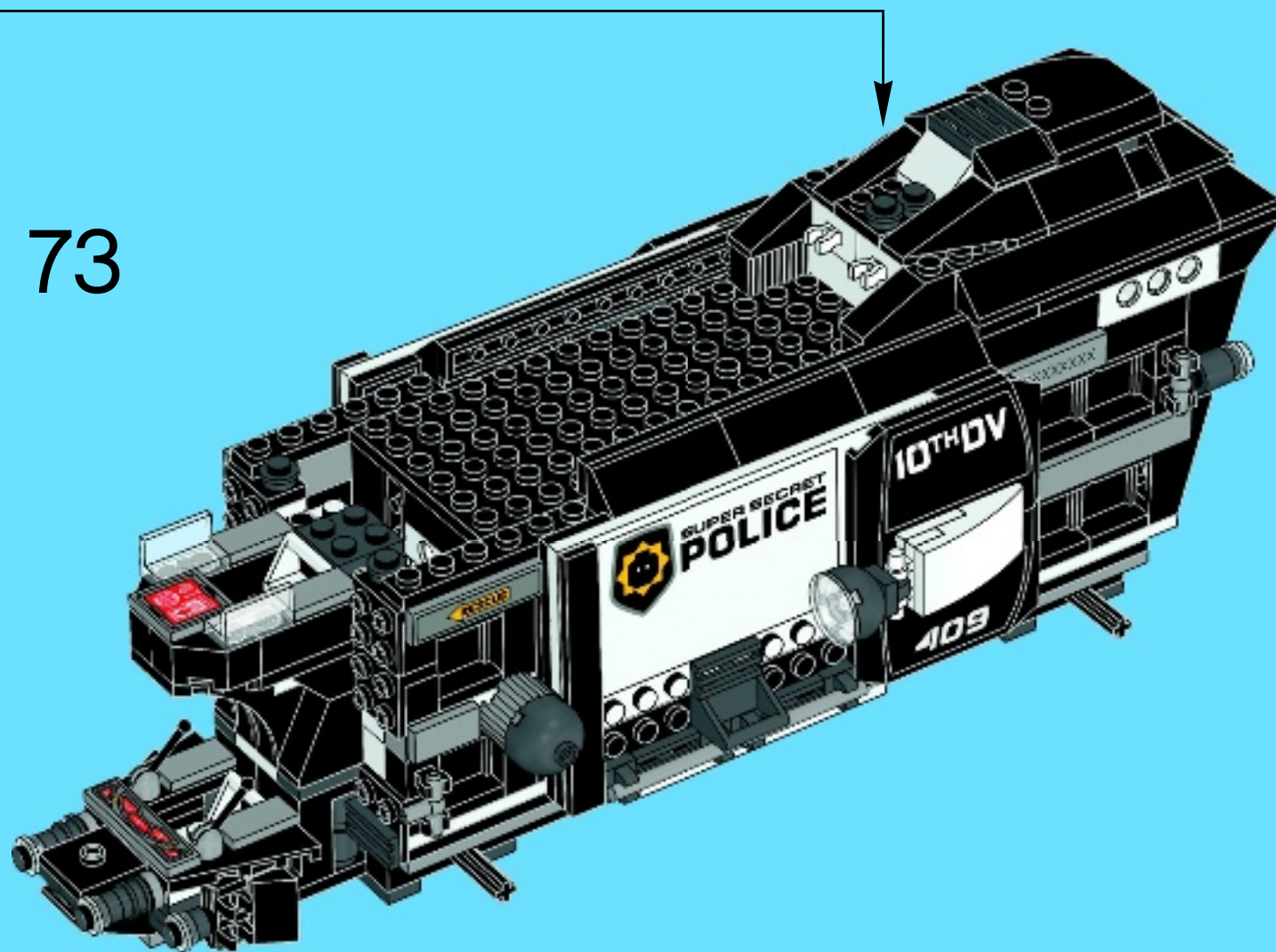

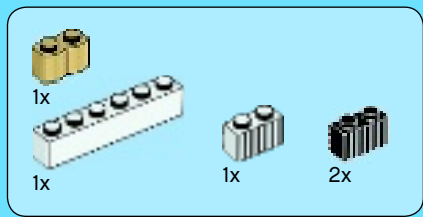

74

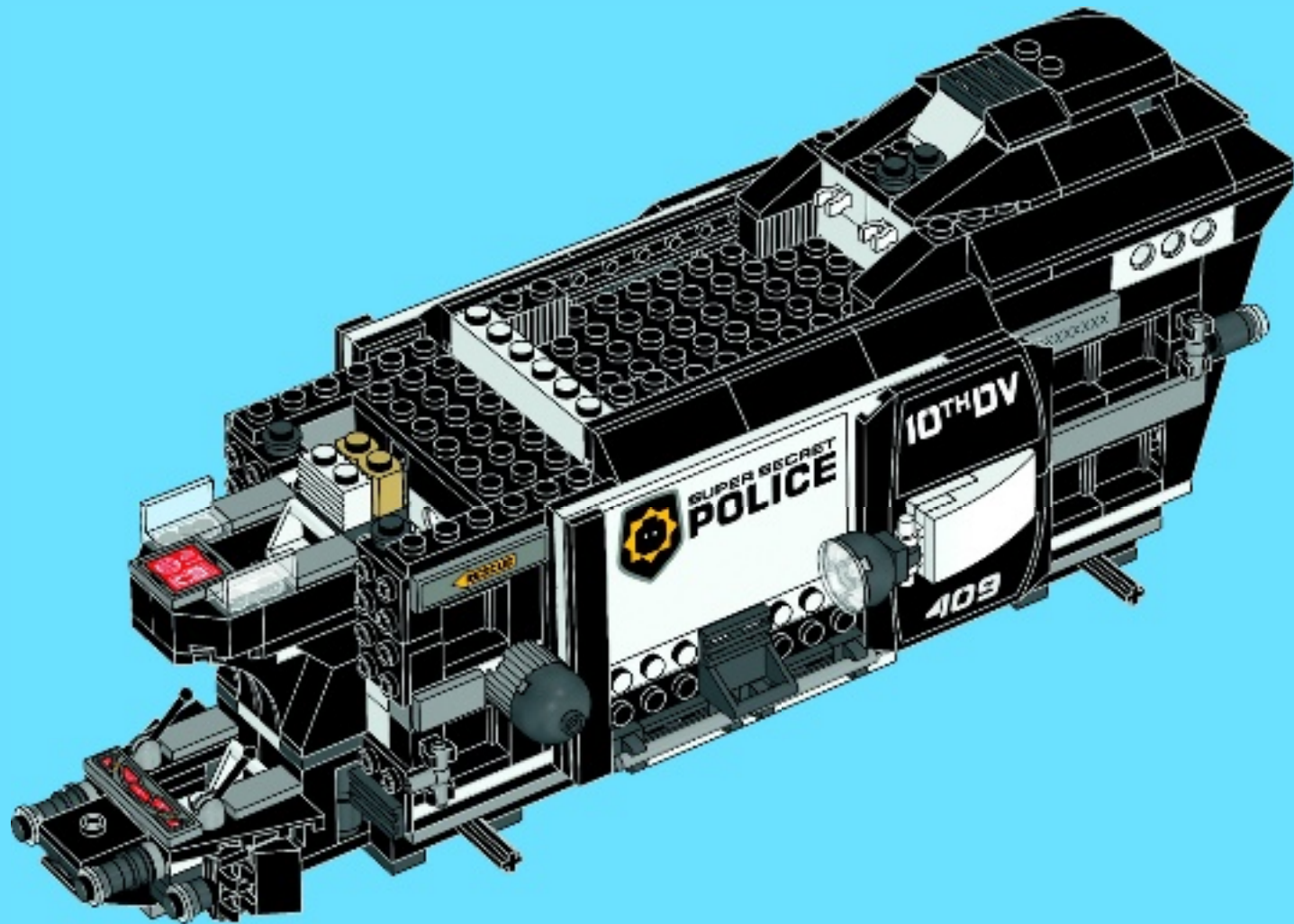

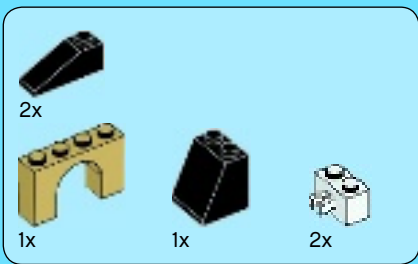

75

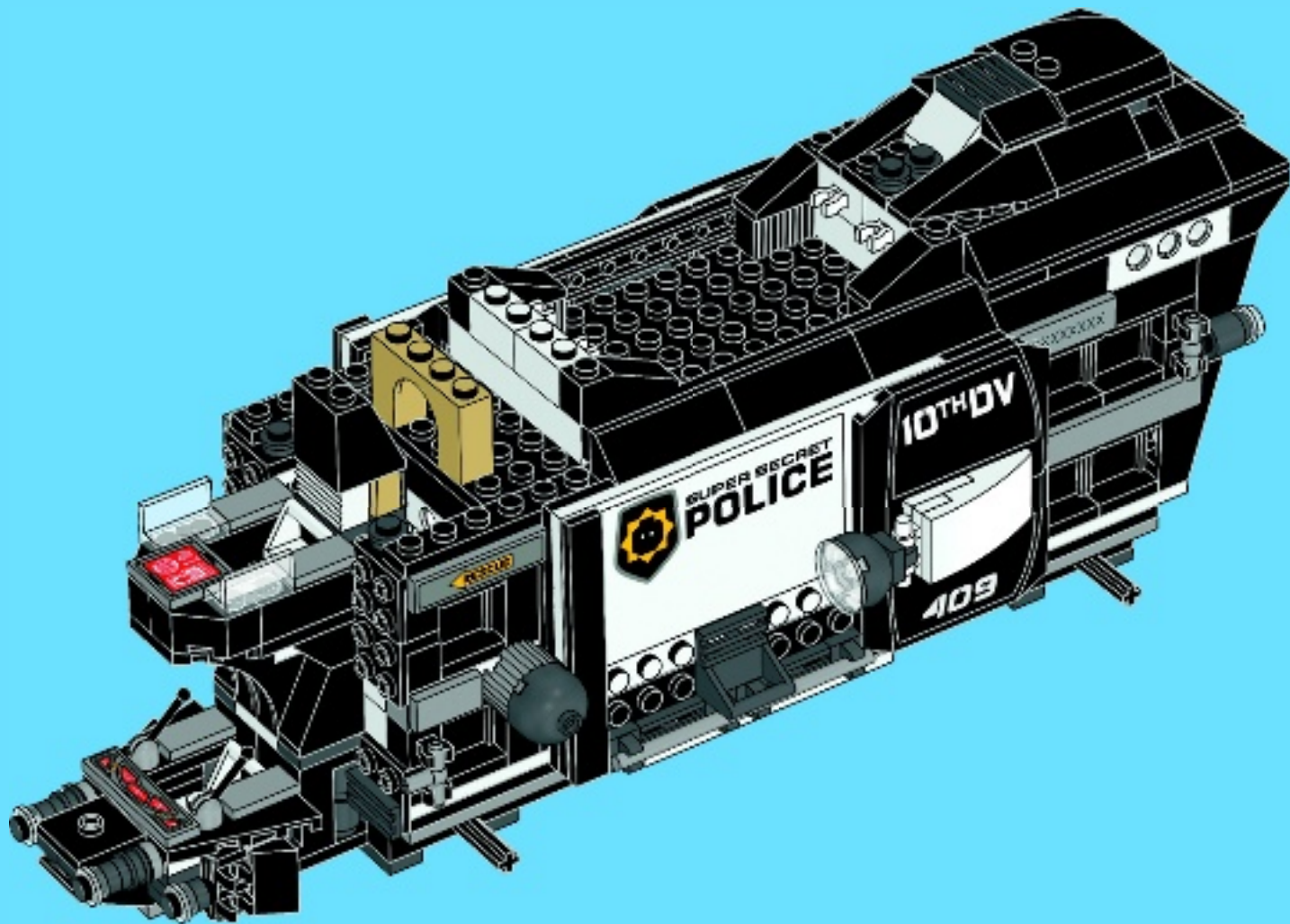



2x

76

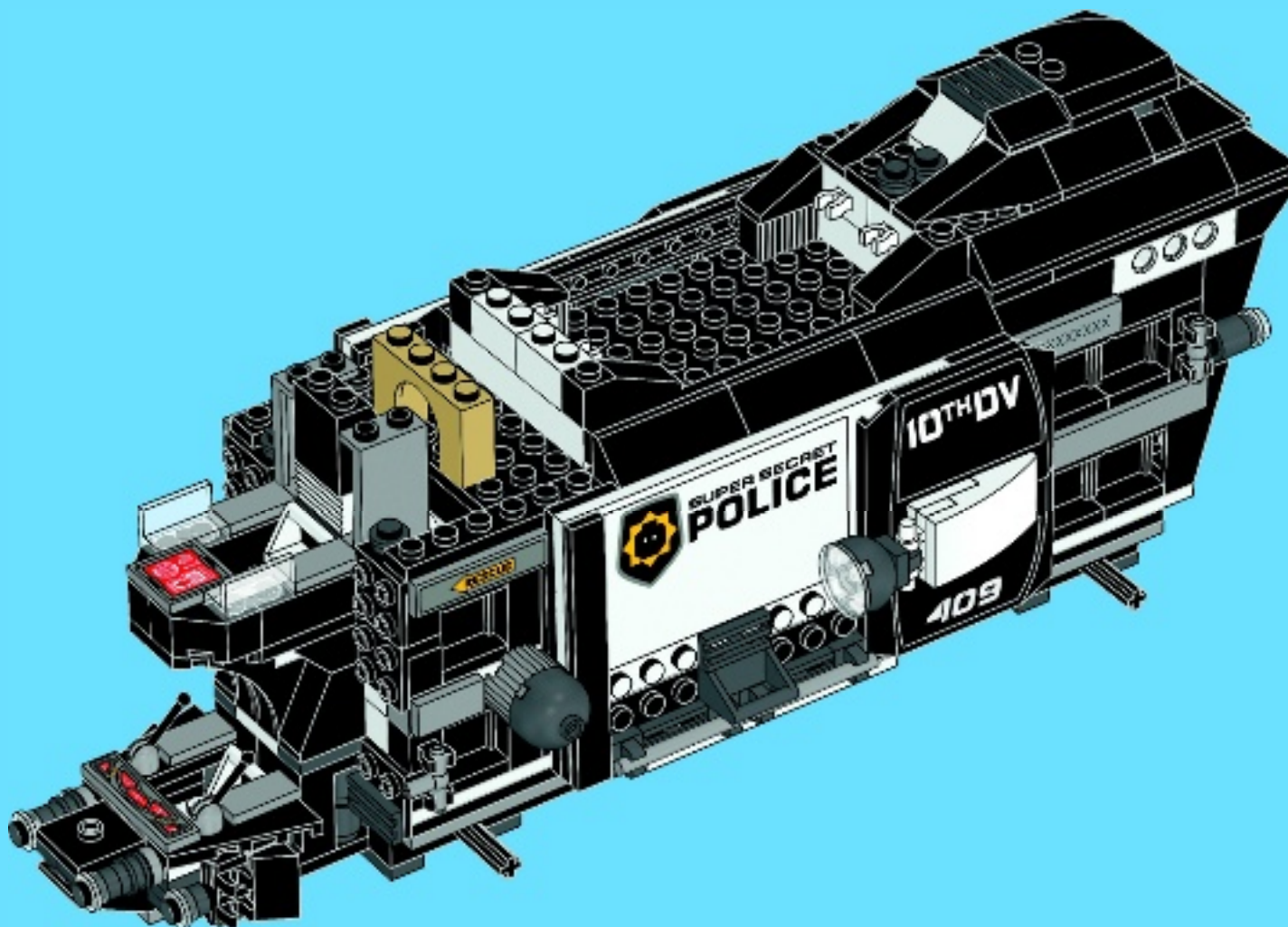



6x

77

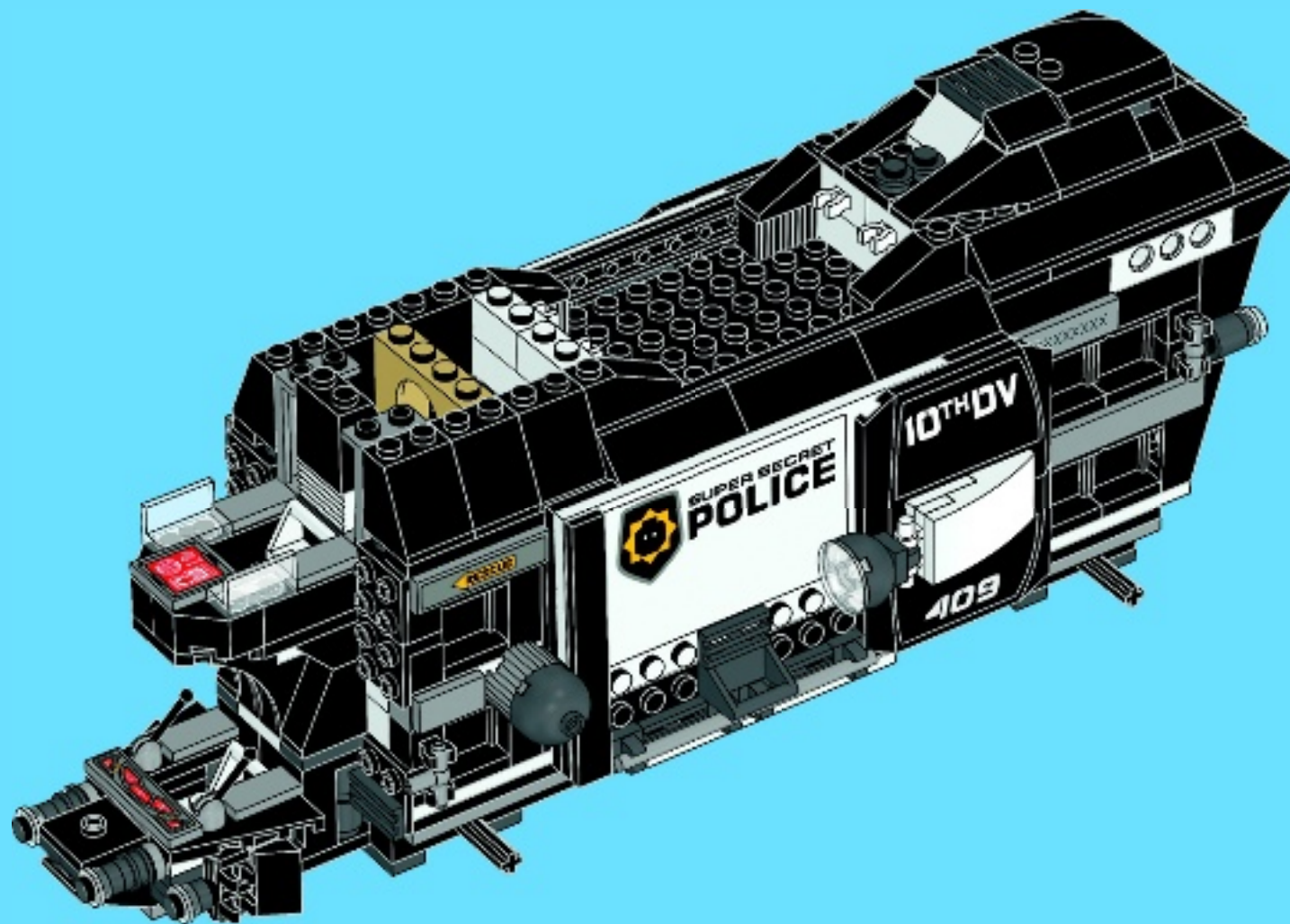

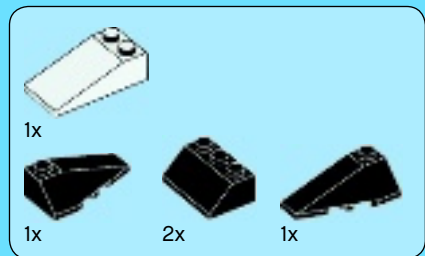

78

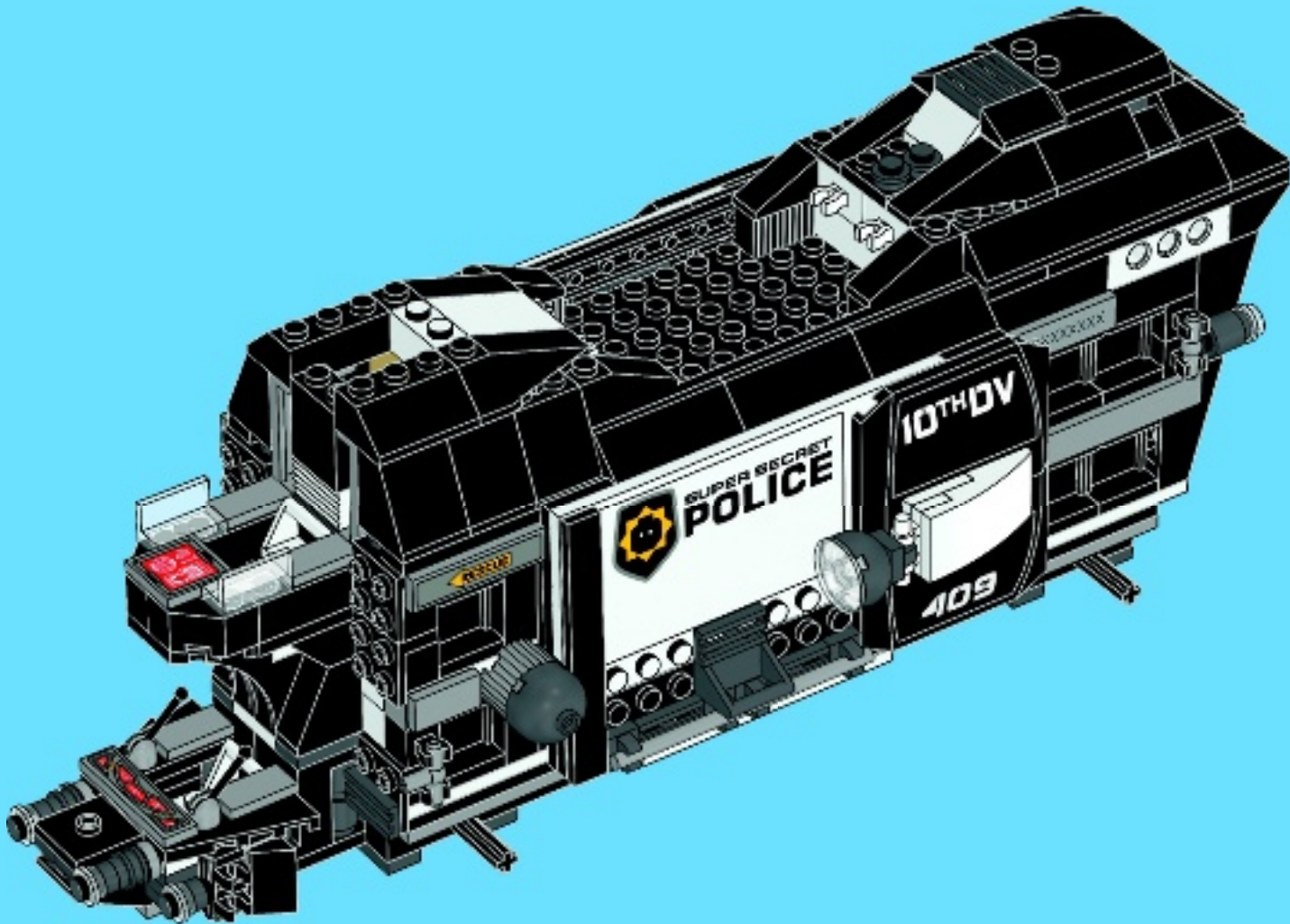



1x



1x



1x

79

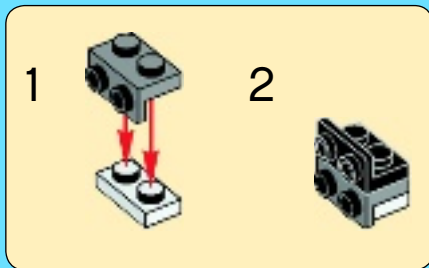

1

2

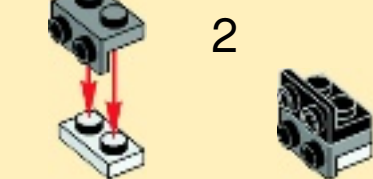



1x



1x



1x

80

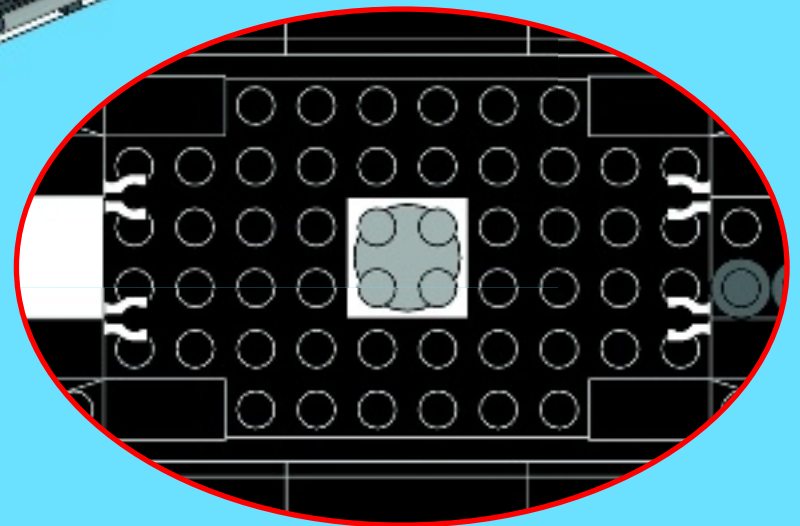
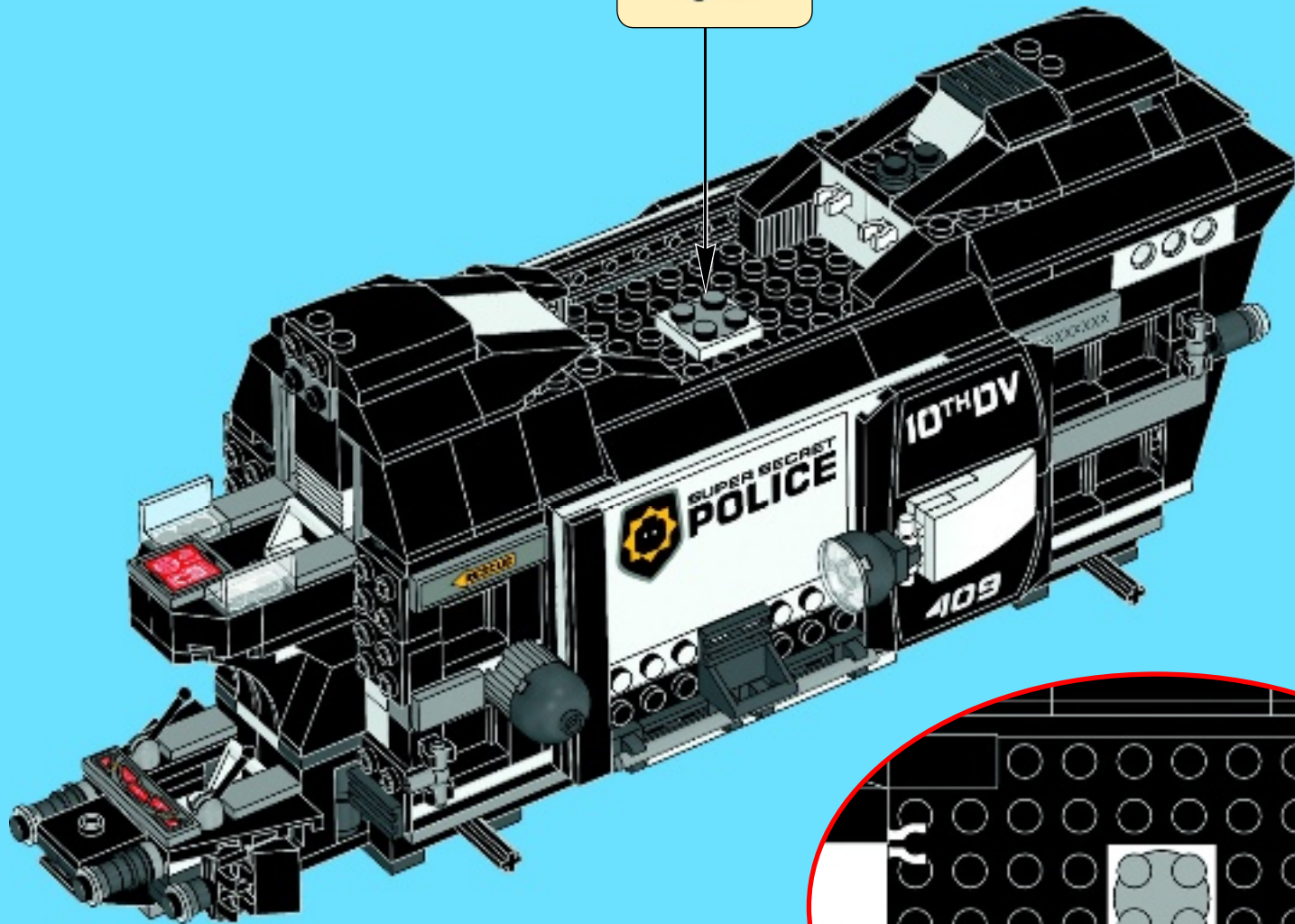
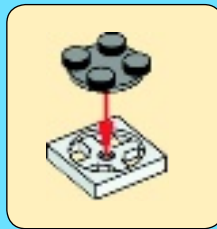



2x

1

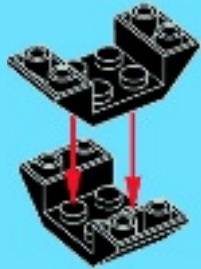

2x

2

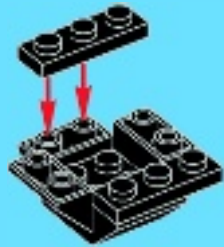

2x



2x



1x

3



1x



2x

4

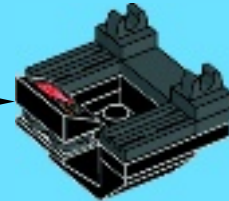
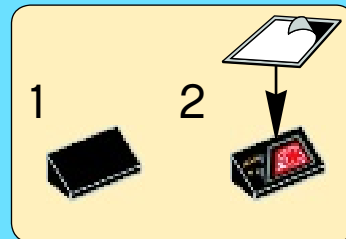



1x

5



2x

6



1x



1x

7



1x



1x



1x

8



1



2



81

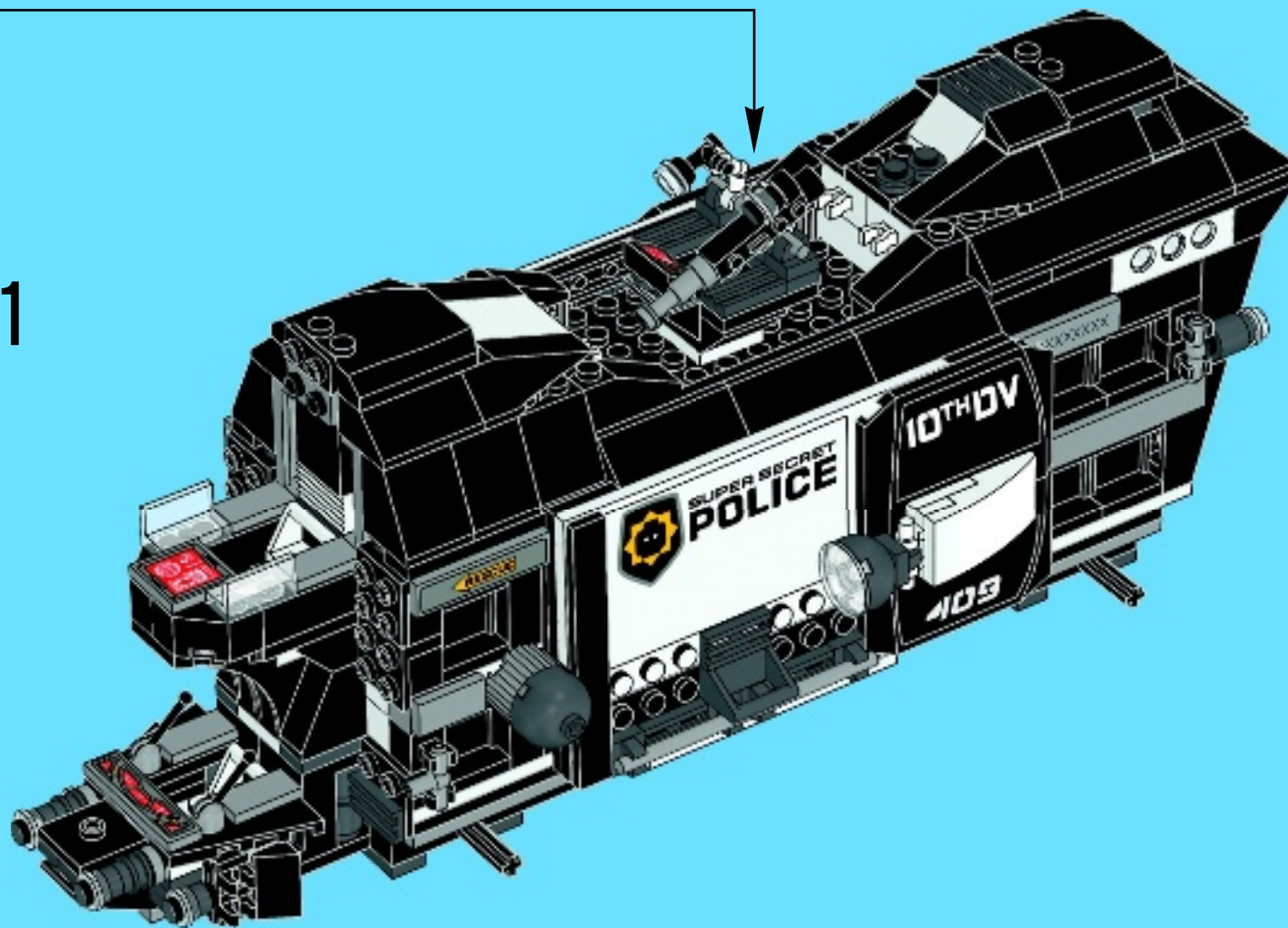



2x



2x



2x

82

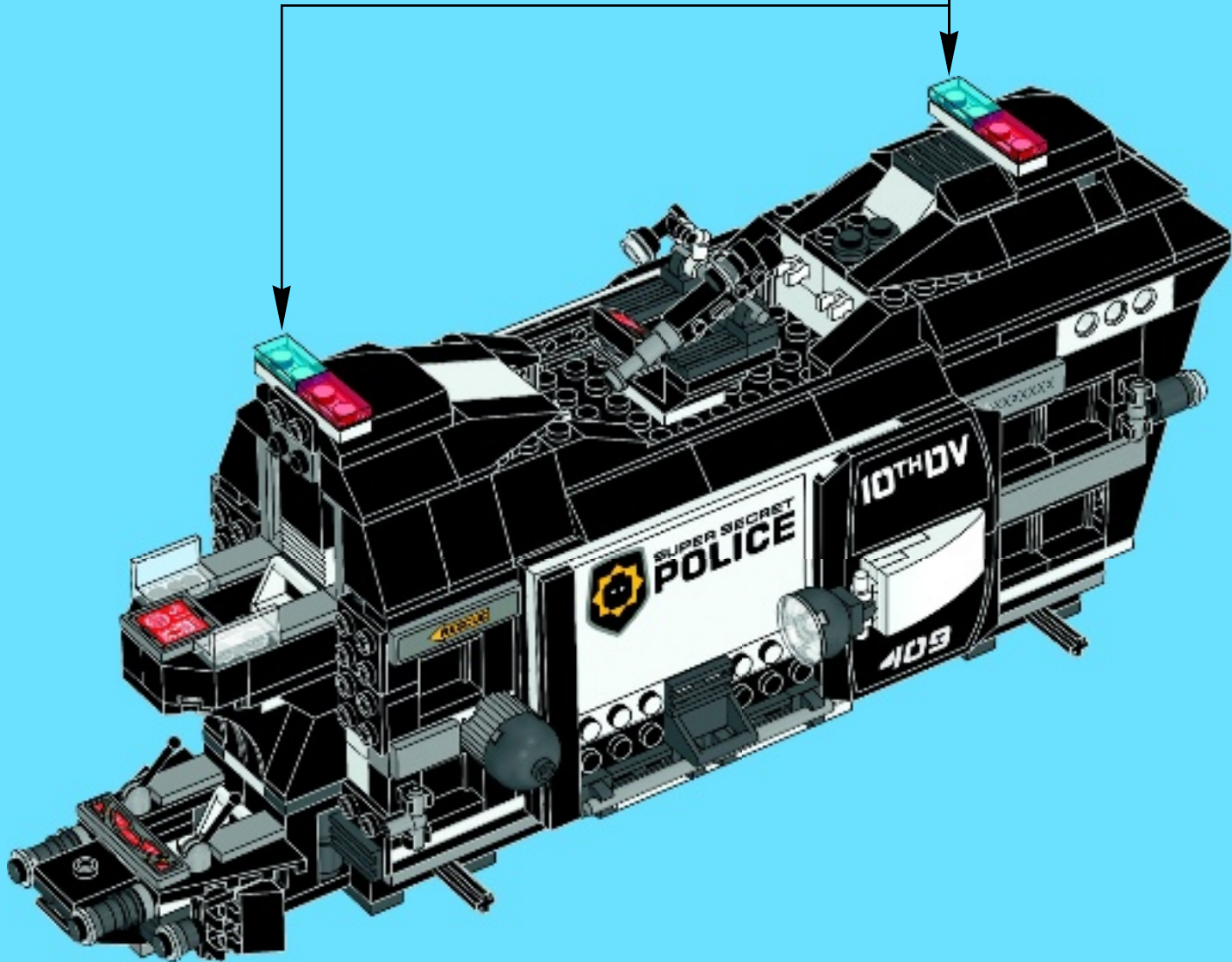
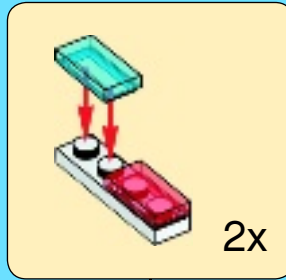



1

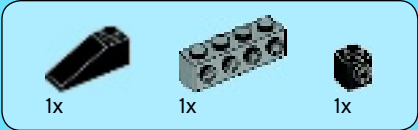

2



3

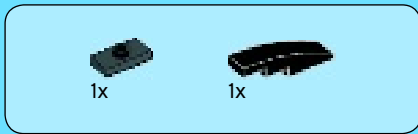
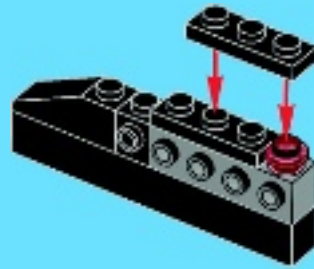

4

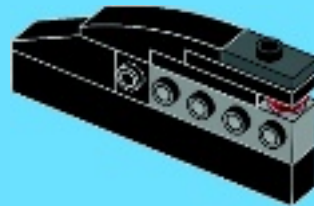

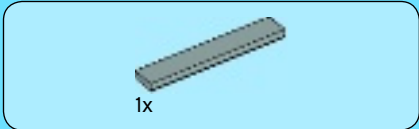

83

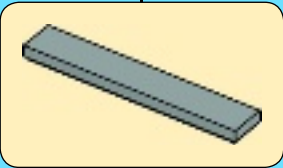
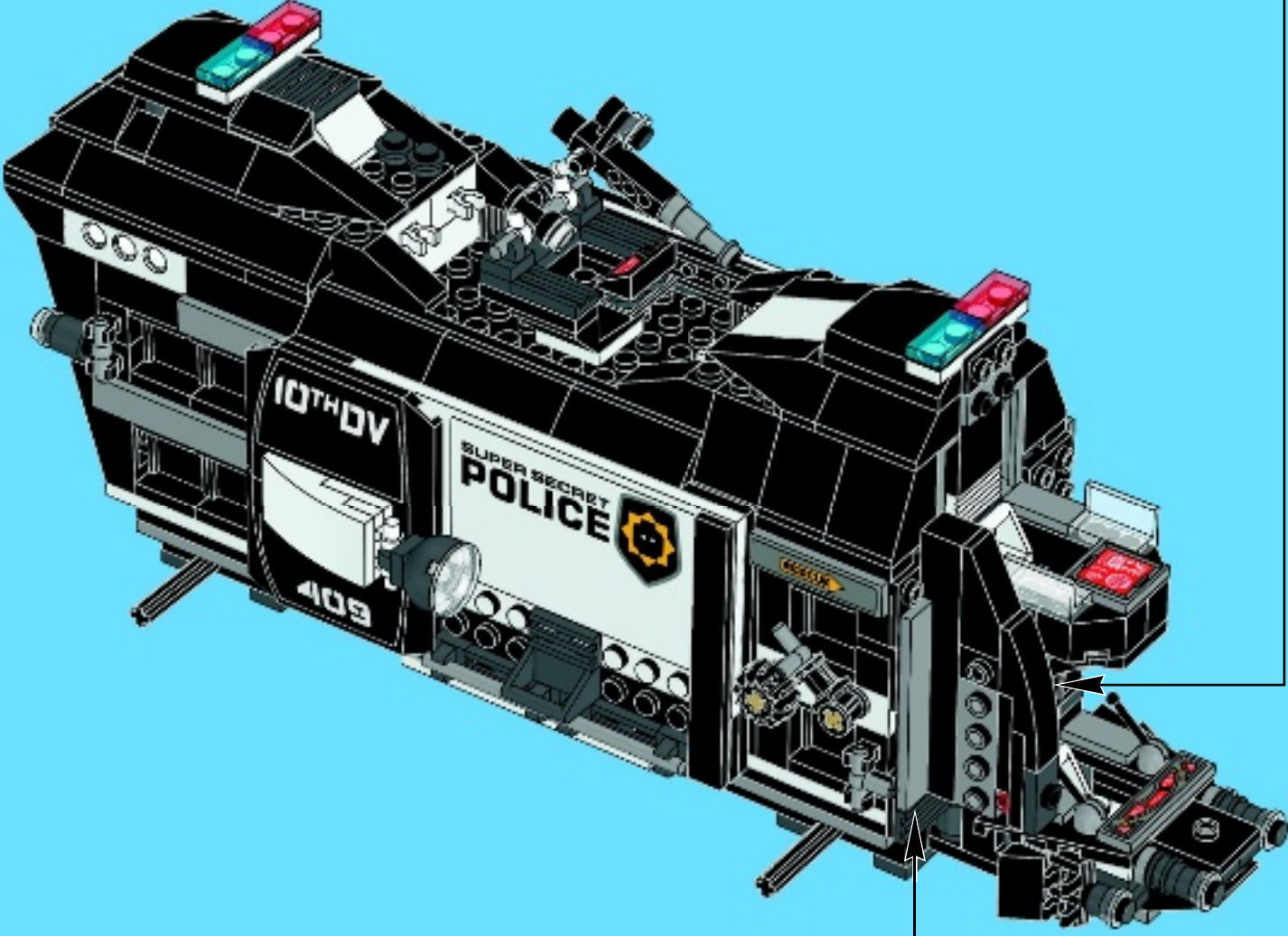
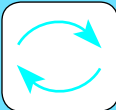

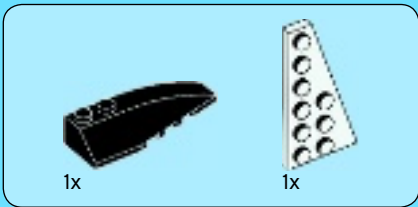

84

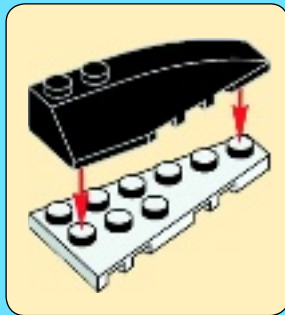
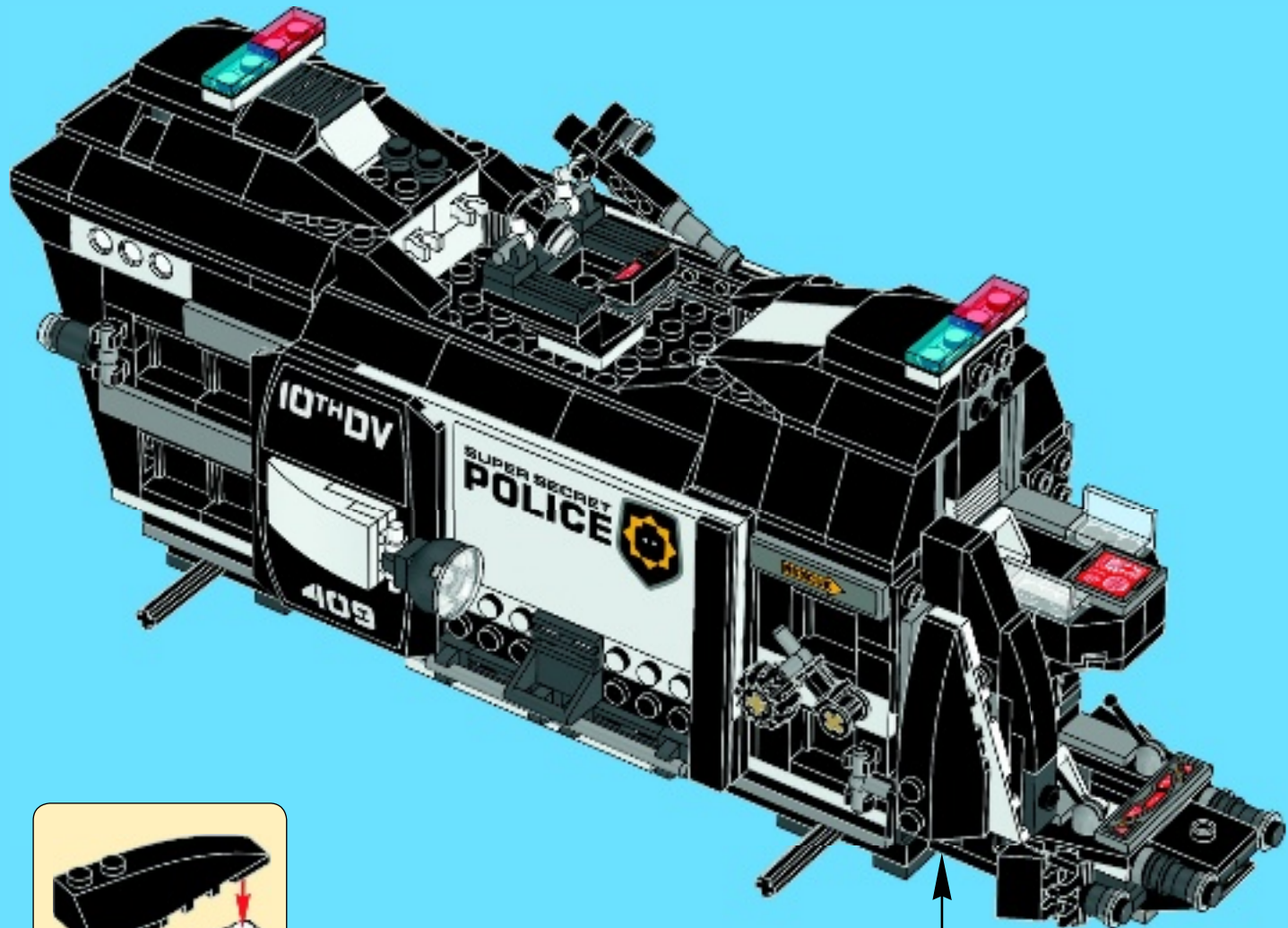



1

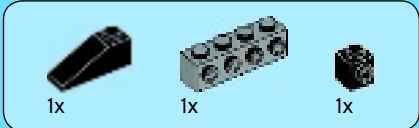

2



3

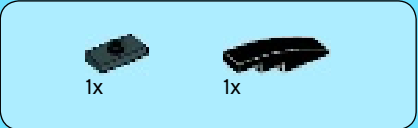
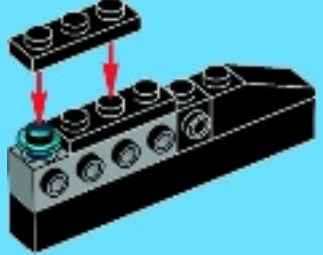

4





1x

85

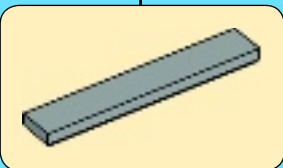
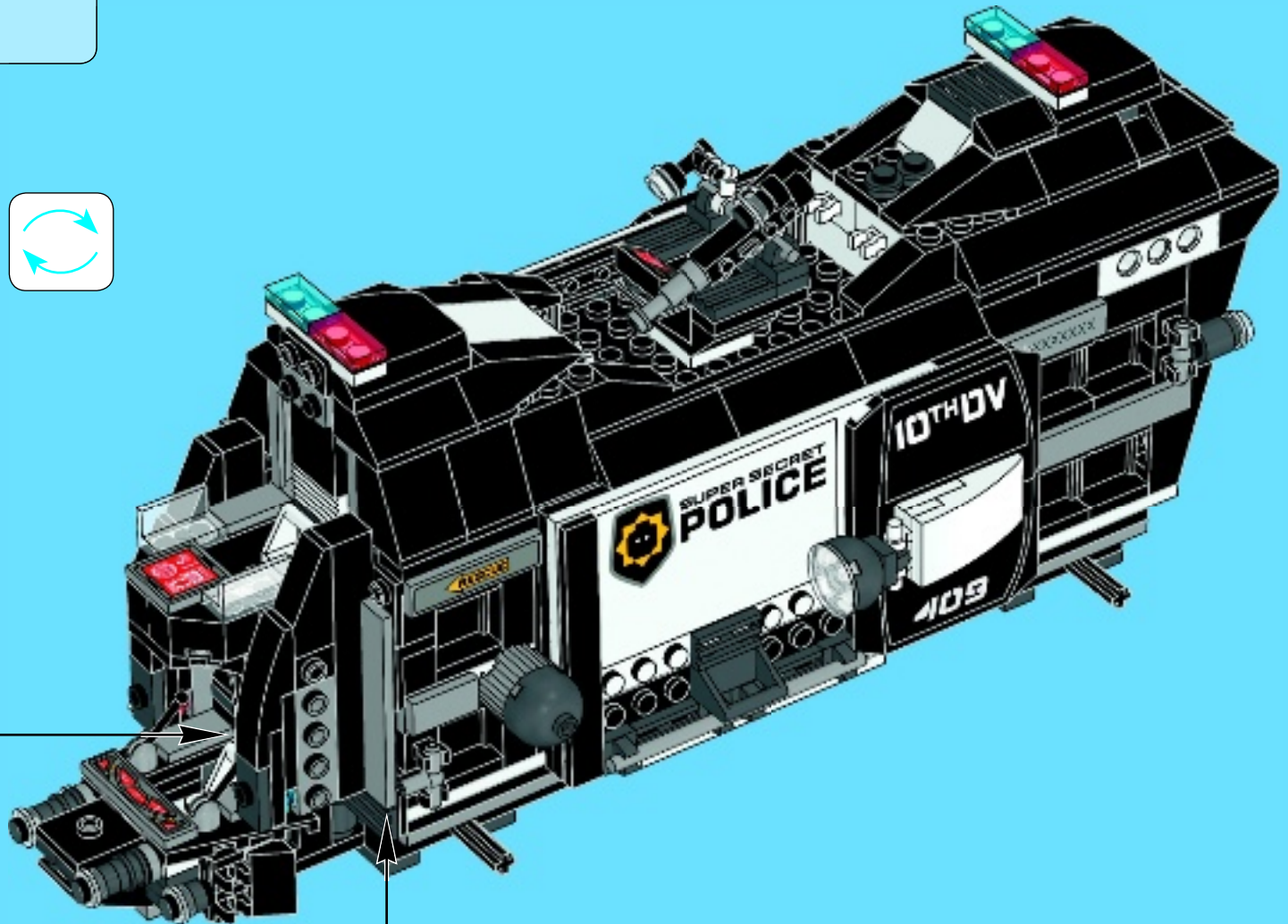
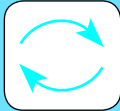

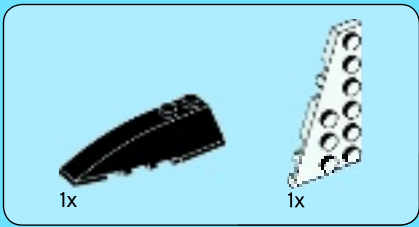

86

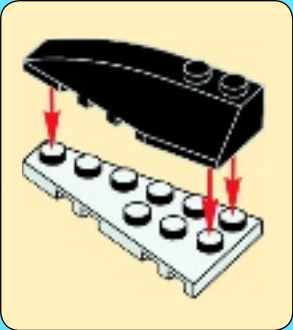
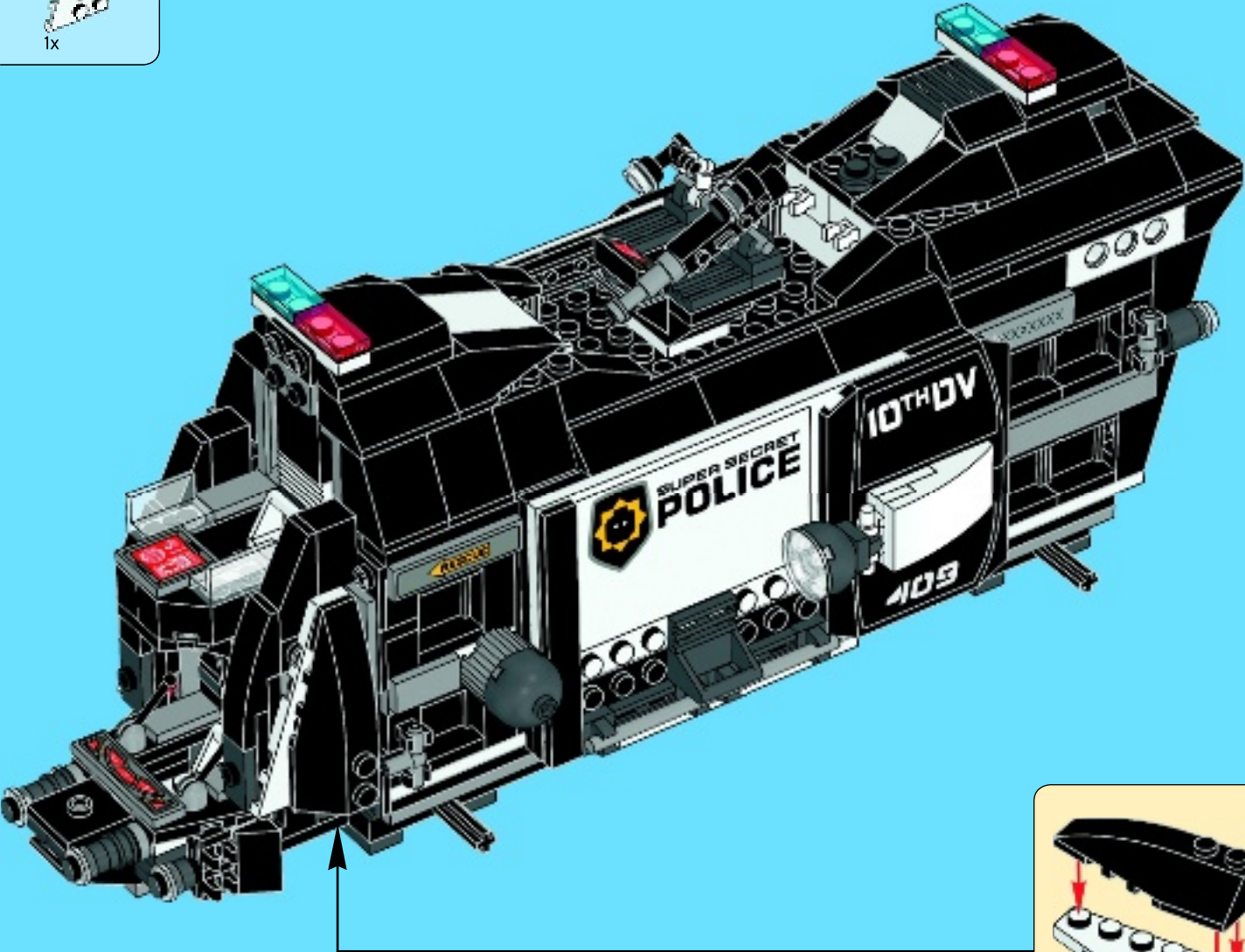

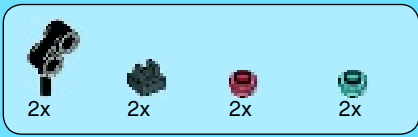

87

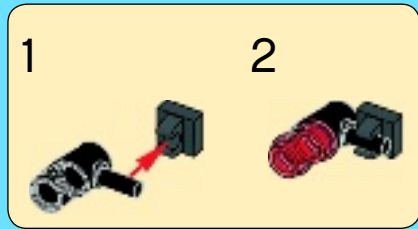

2

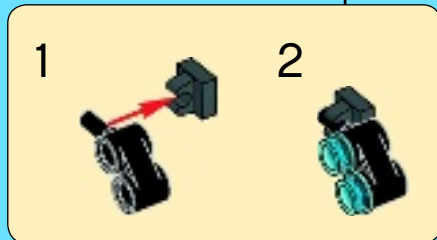
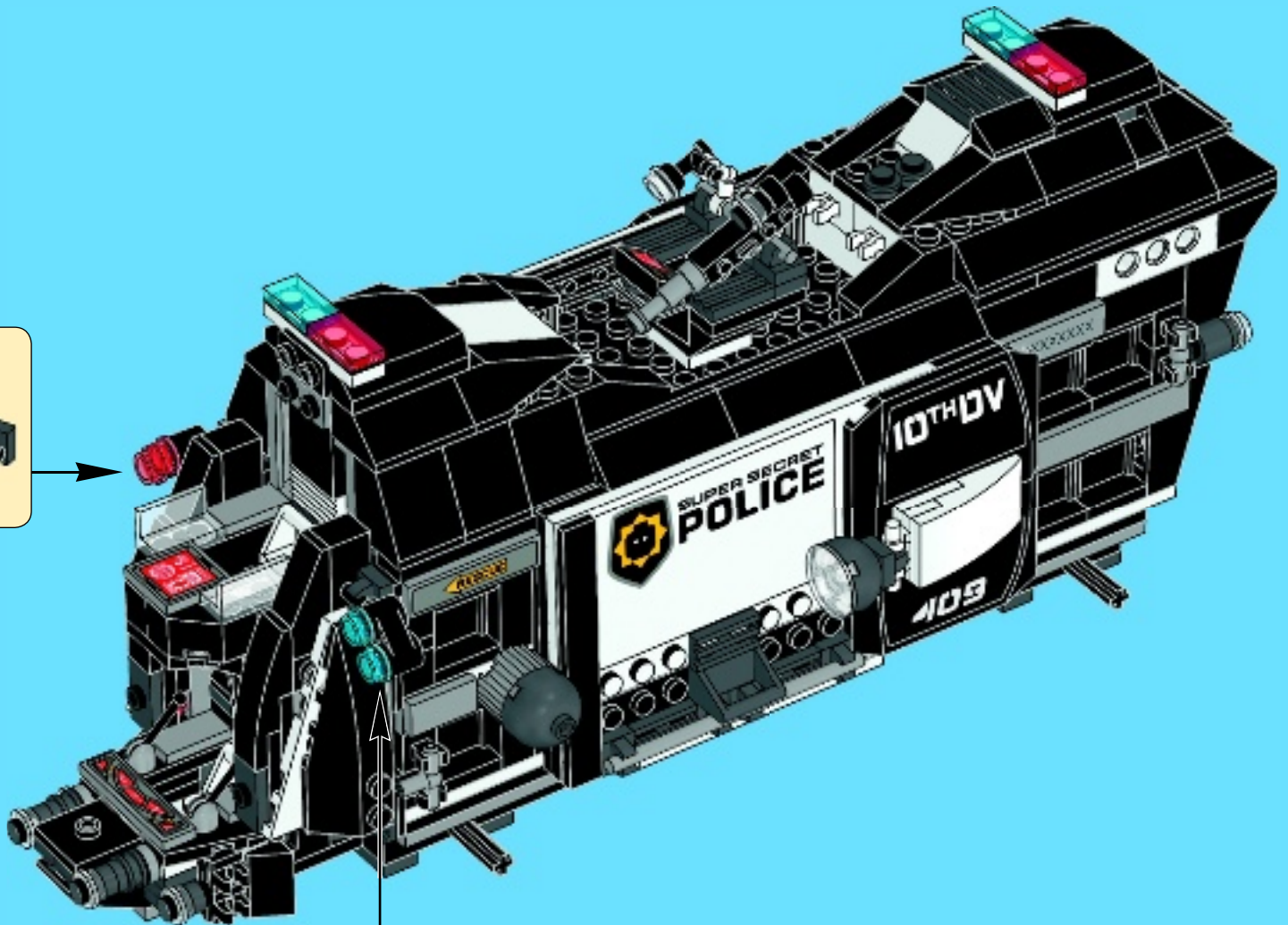

2



5



+

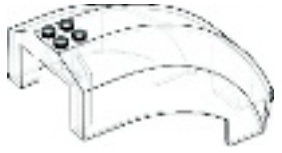



2x



2x

1

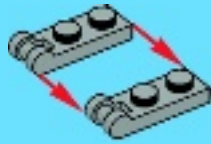

1x

2



2x

3

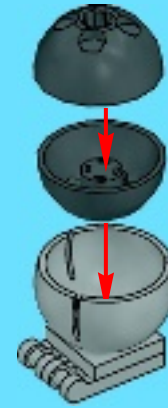

1x

4



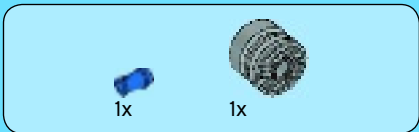

5

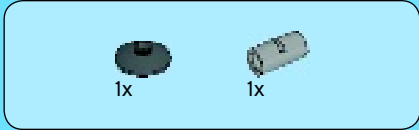

6



2x

88

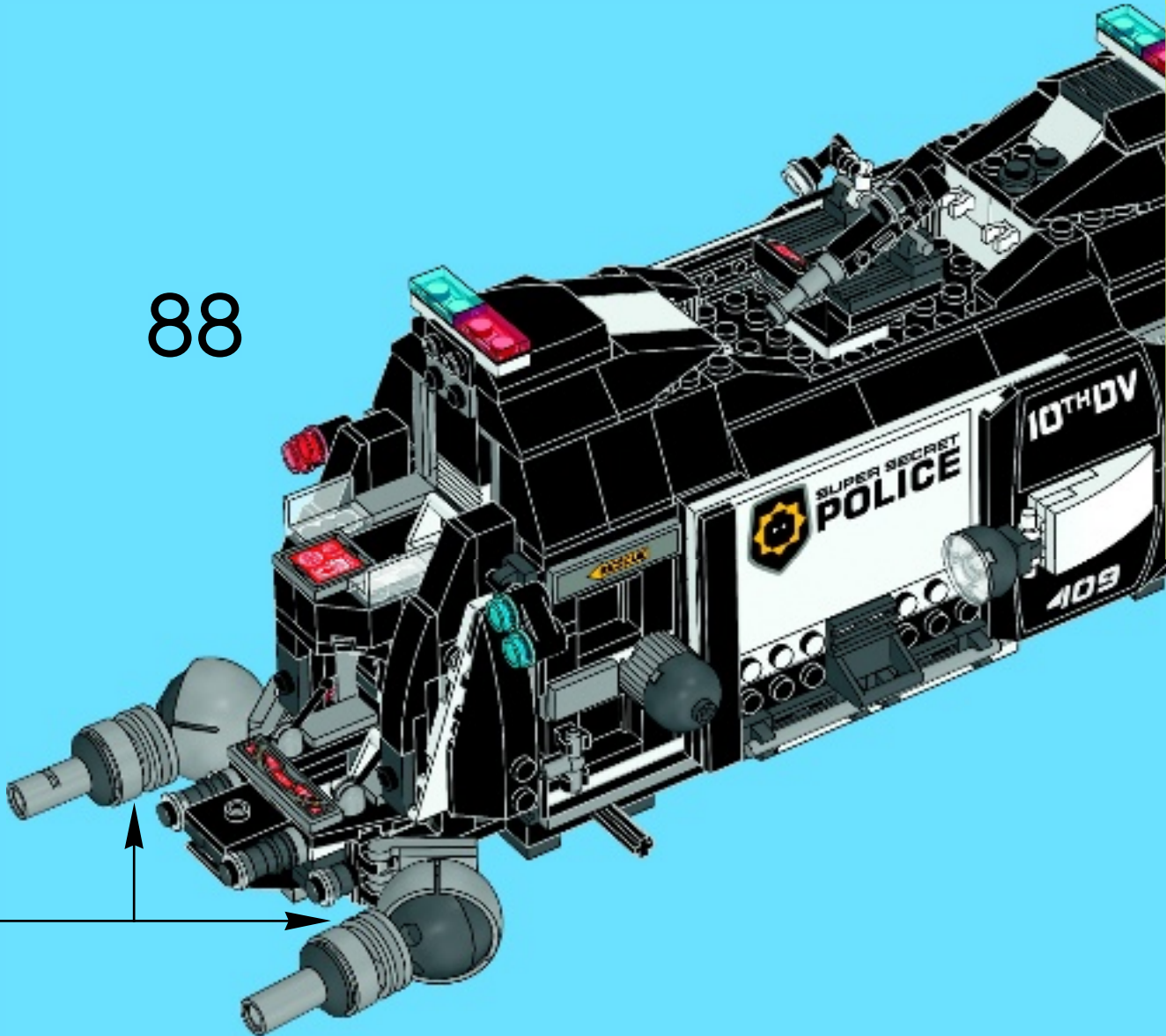

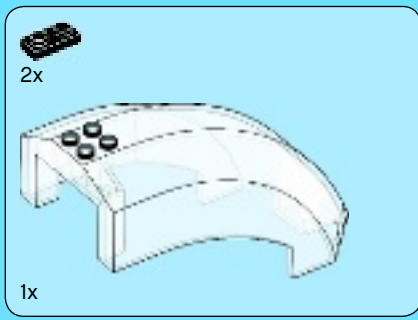

89

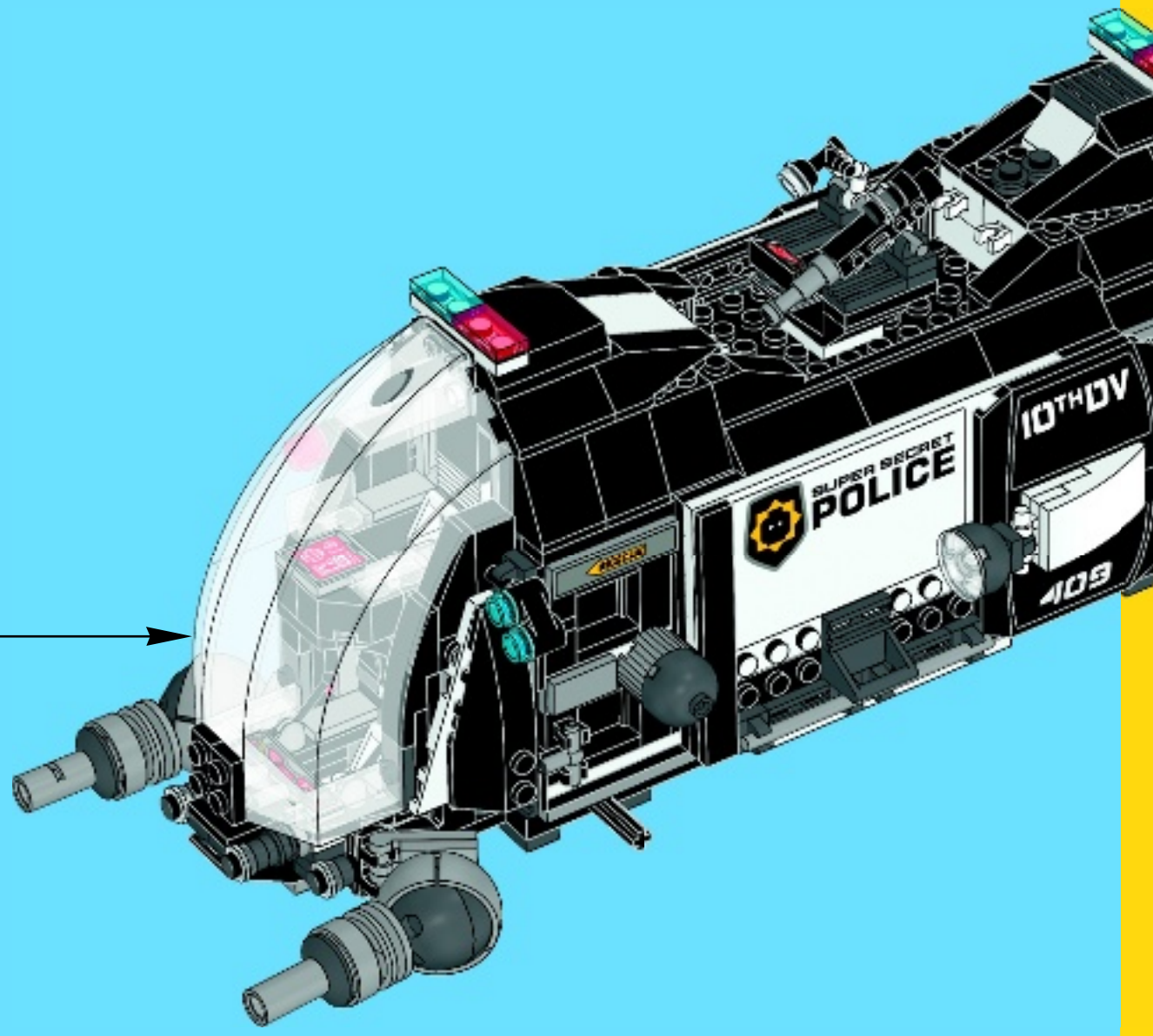
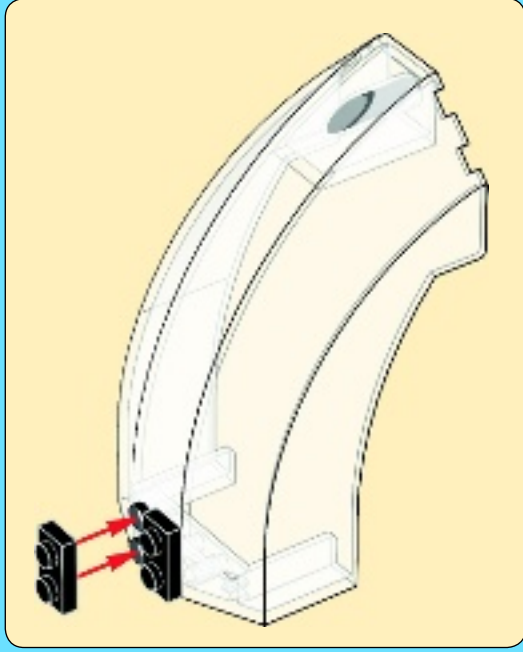

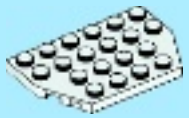

1x

1



1x



1x



1x

2



2x



2x

3



2x



1x

4

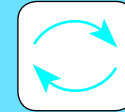

2x

5



90

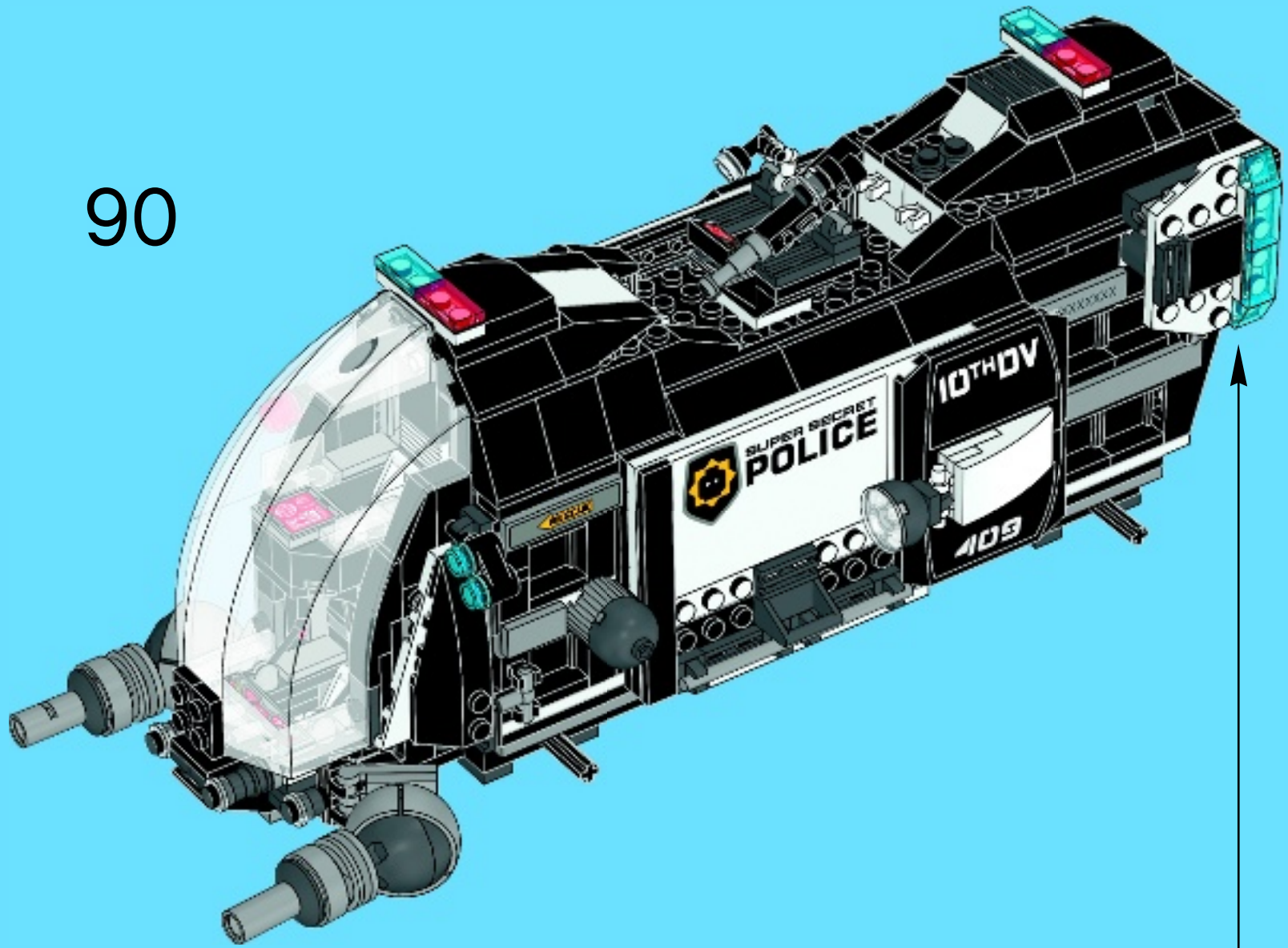

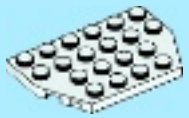

1x

1



1x



1x



1x

2



2x



2x

3



2x



1x

4

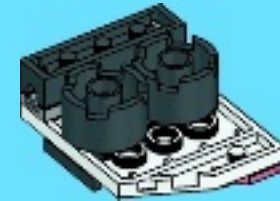
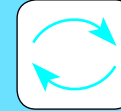

2x

5



91

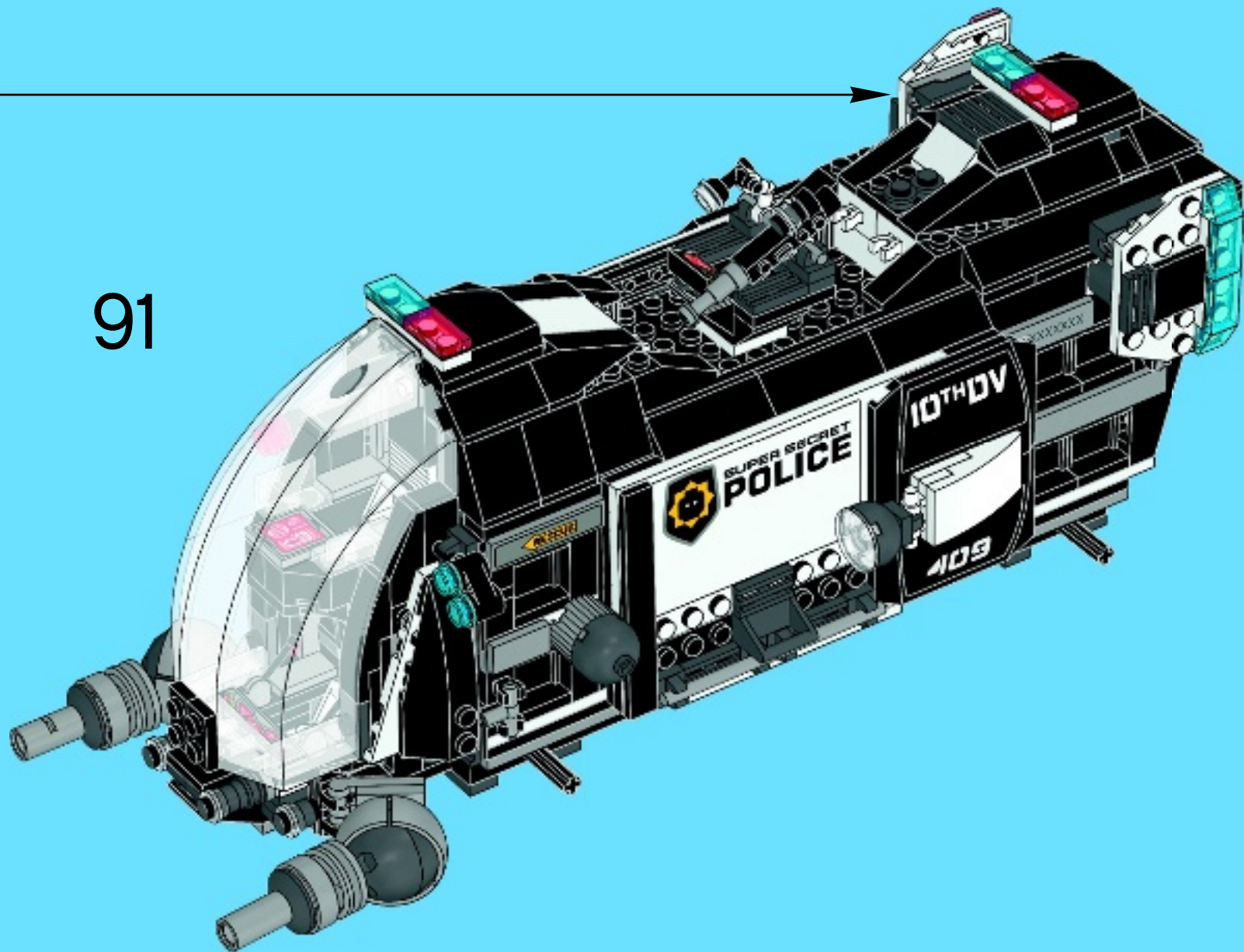



92

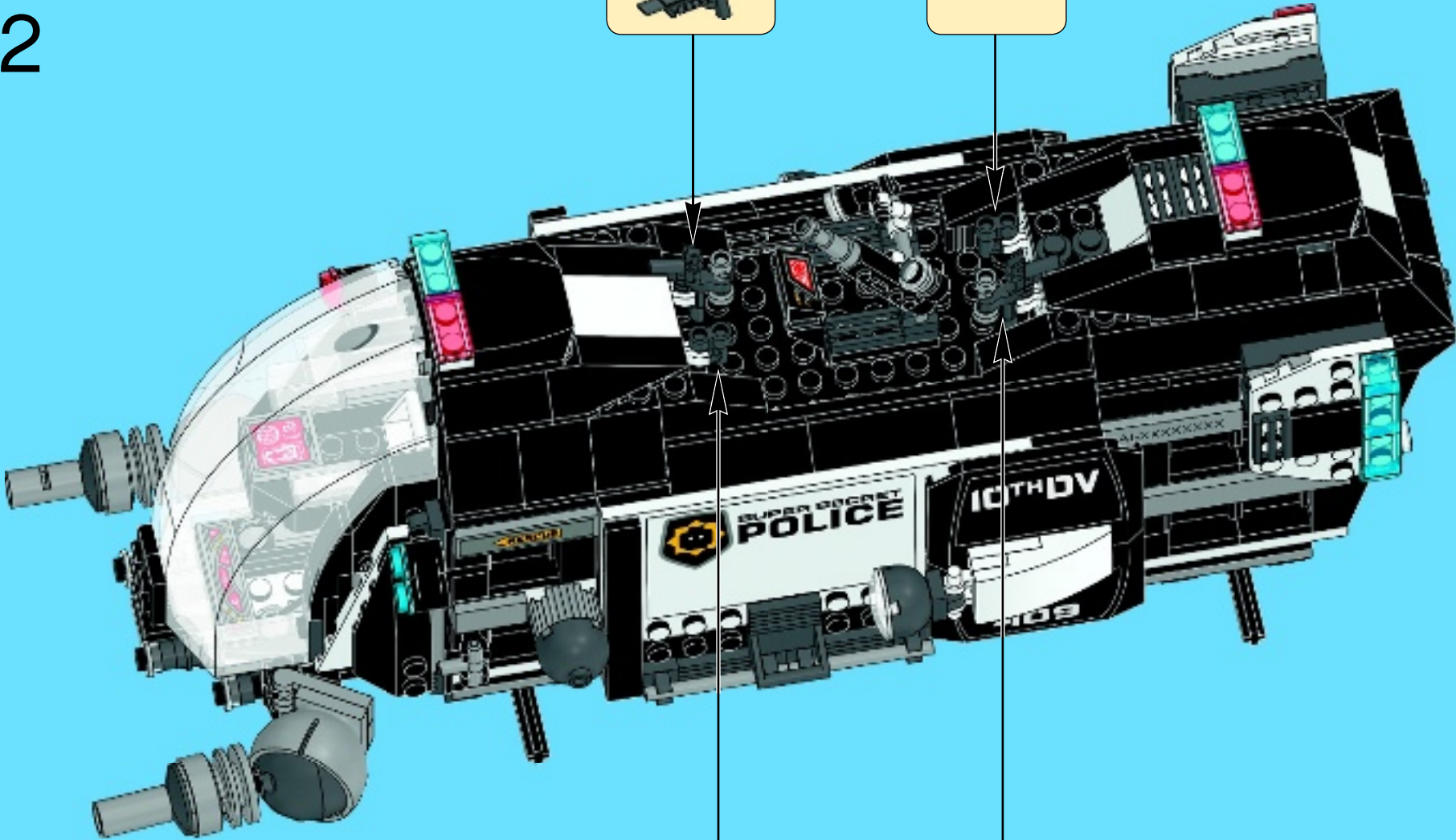



93

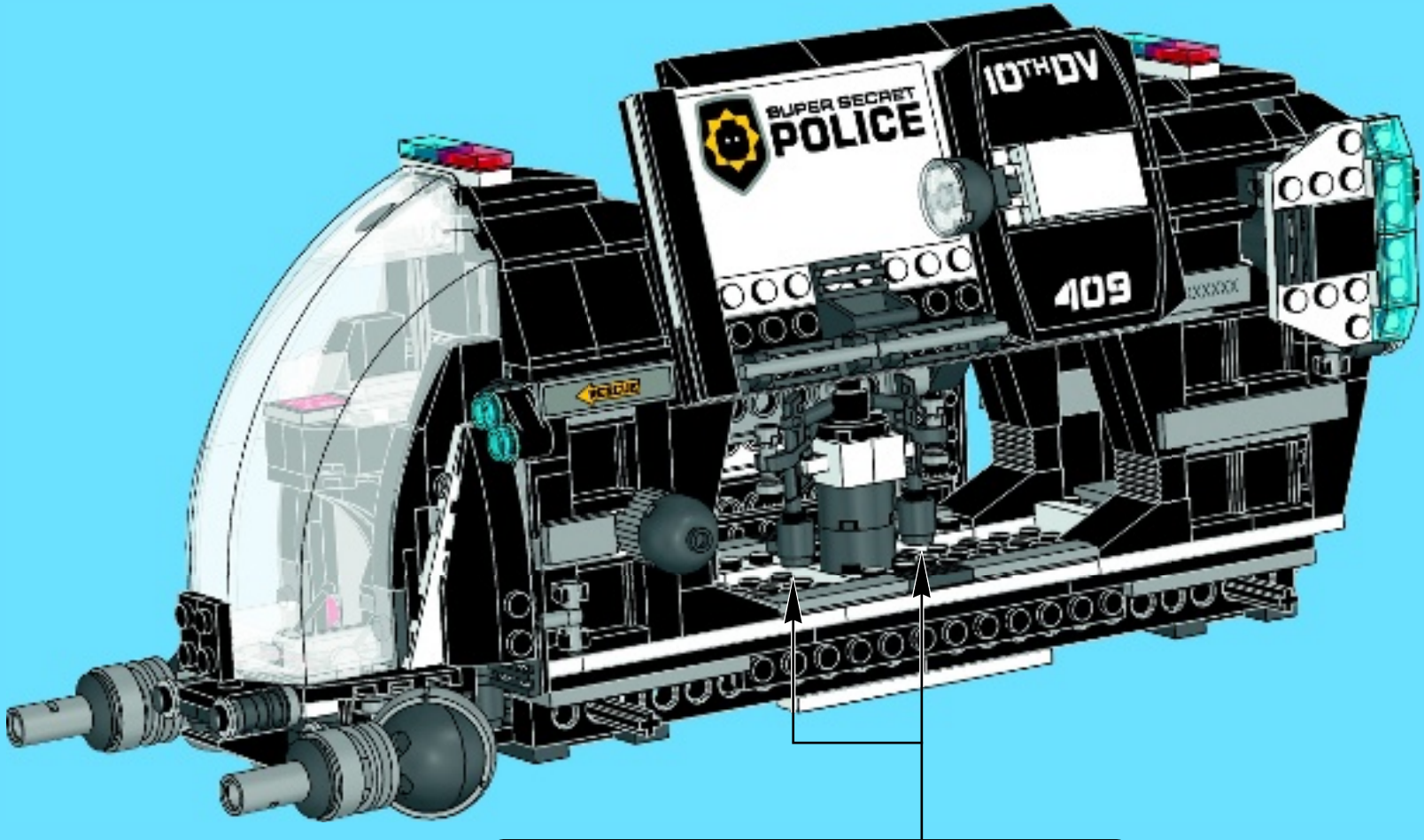



2x

1

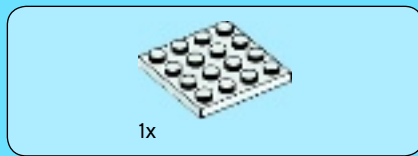
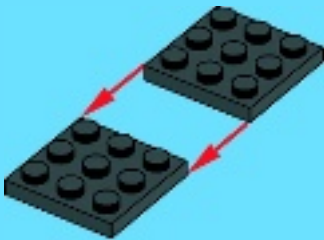

1x

2



2x

1x

3

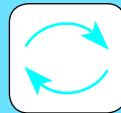

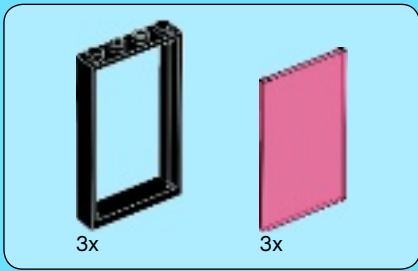

4

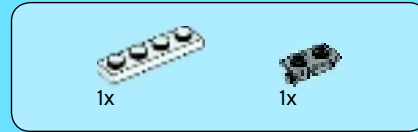
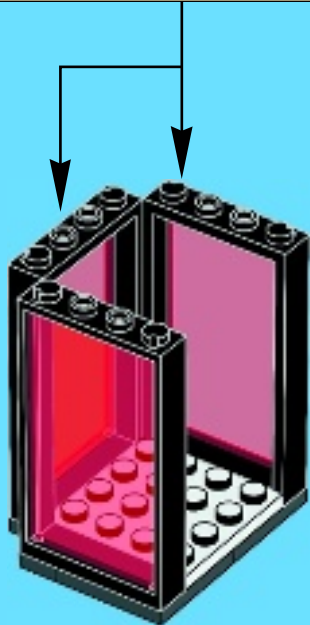
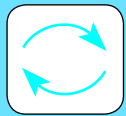
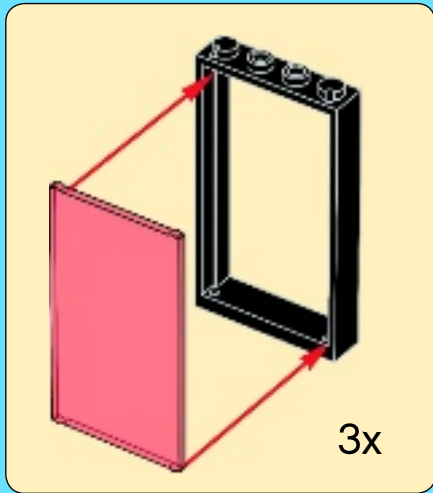

1

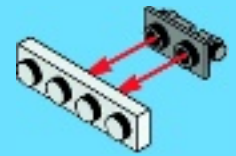

2

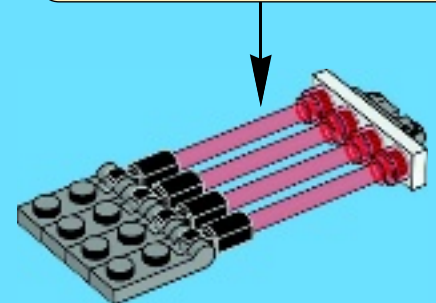
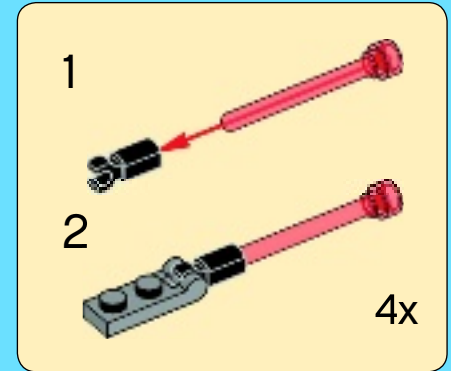



3

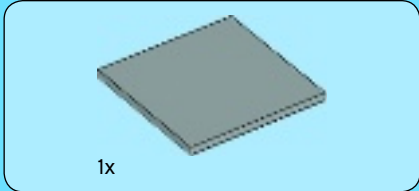
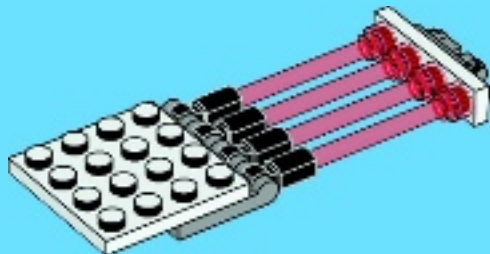

4

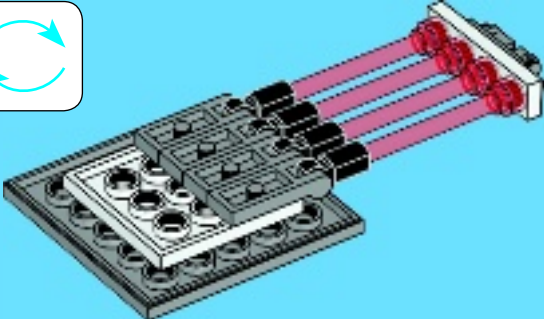
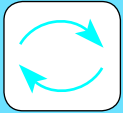

5

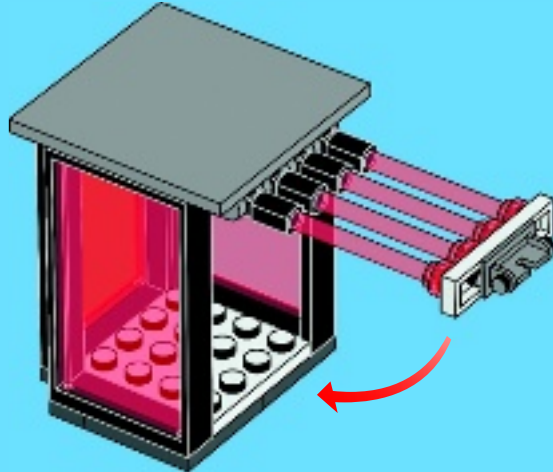

94

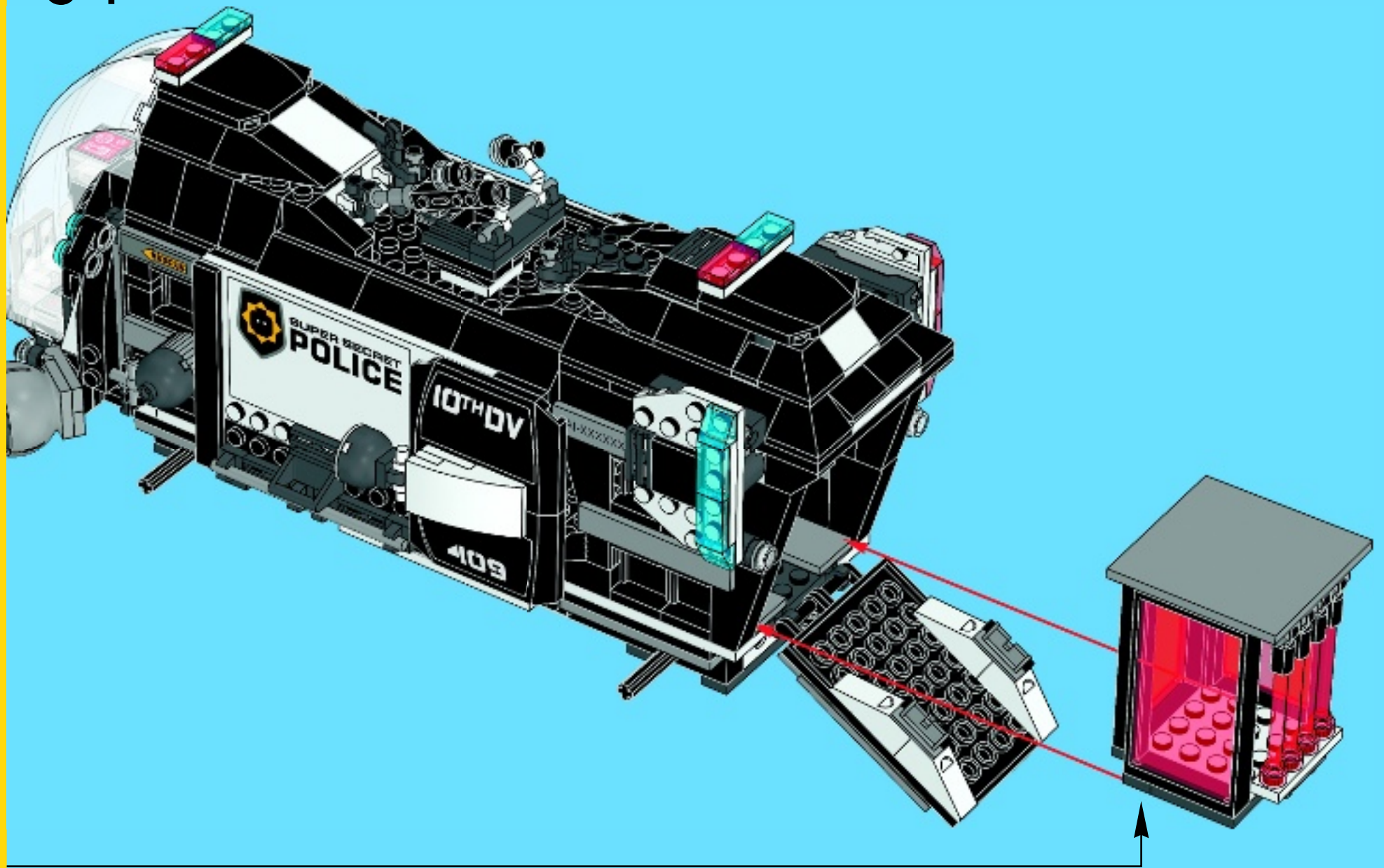



6



4x

95

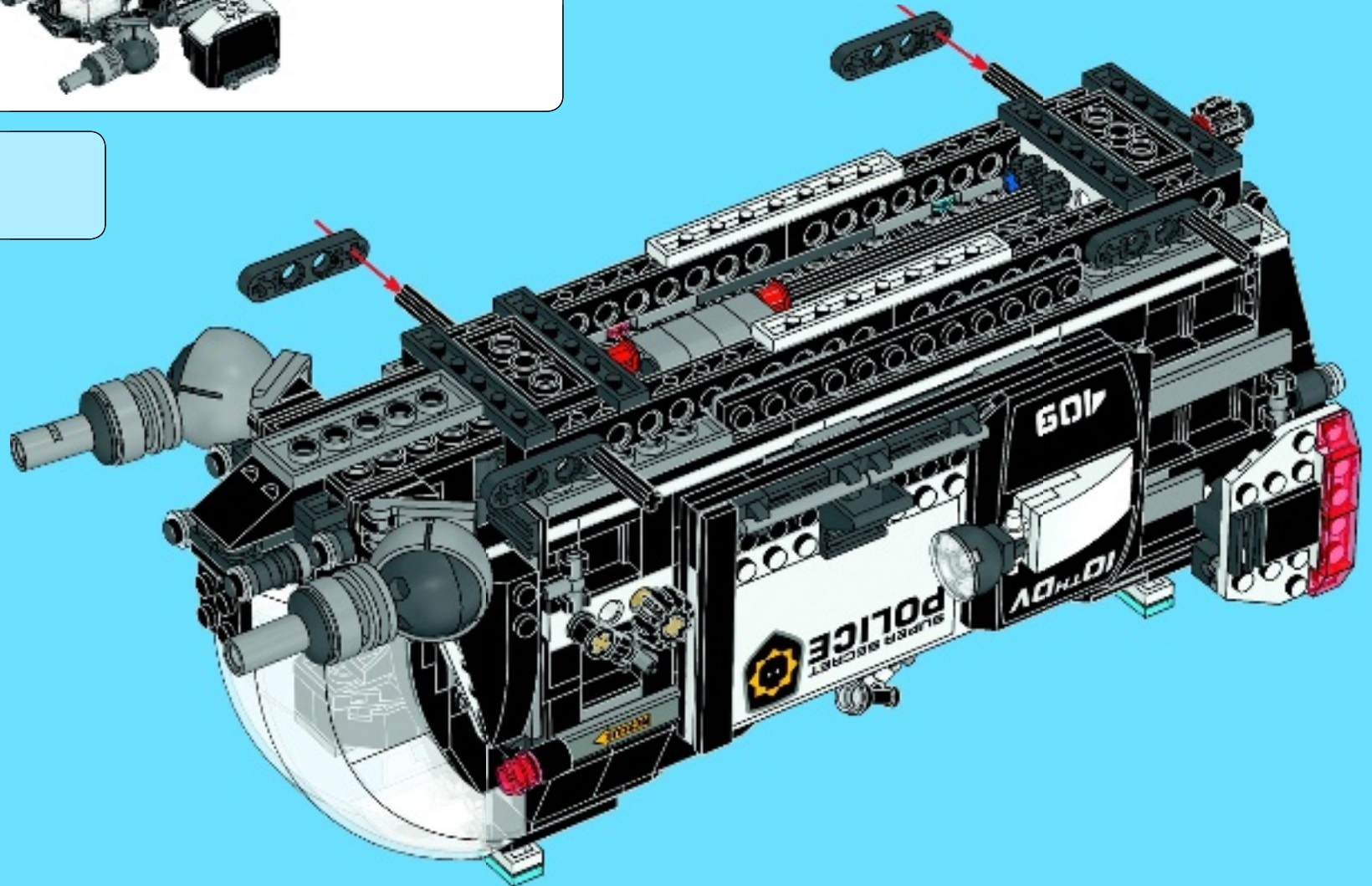



4x

96

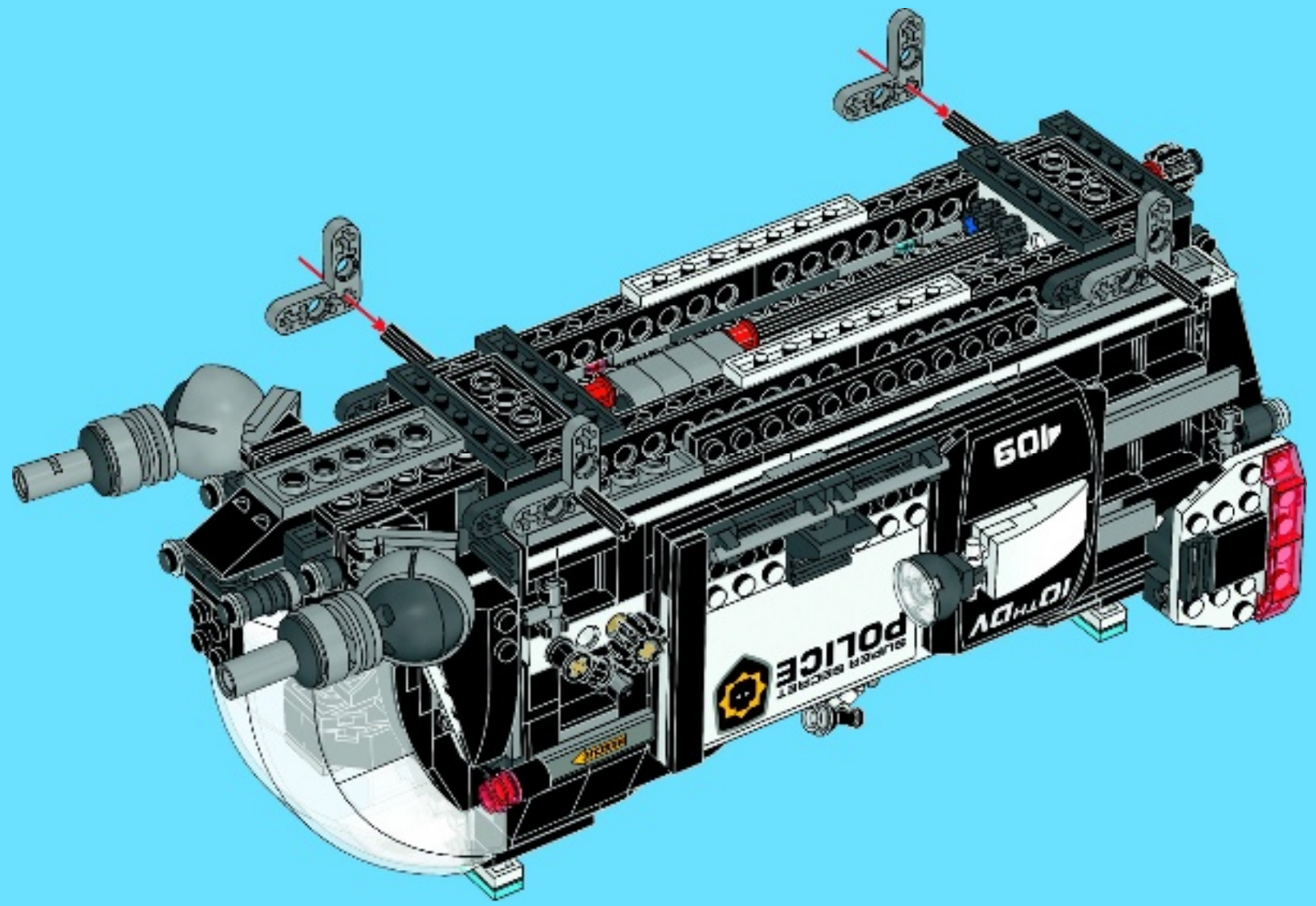

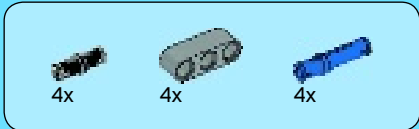

97

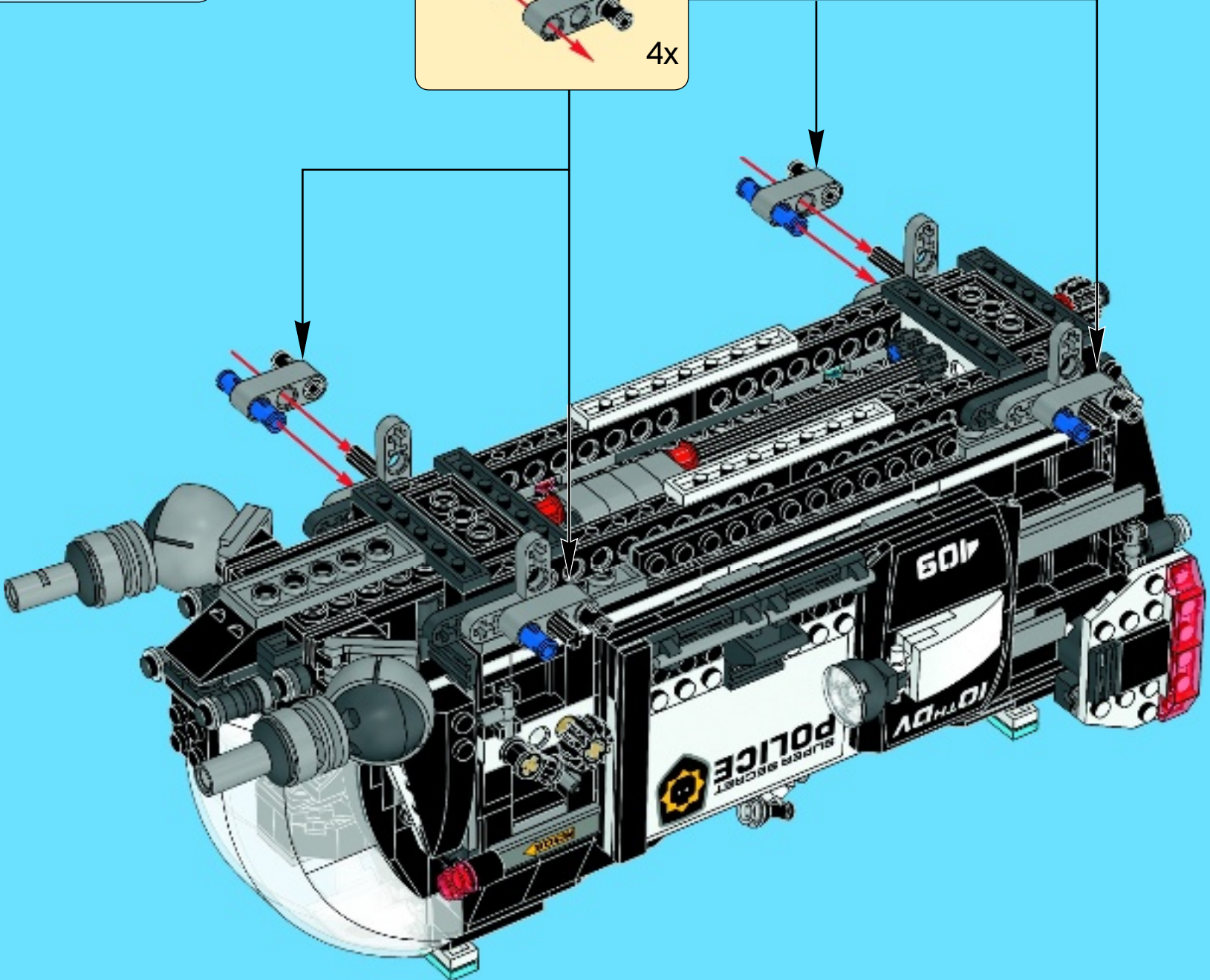
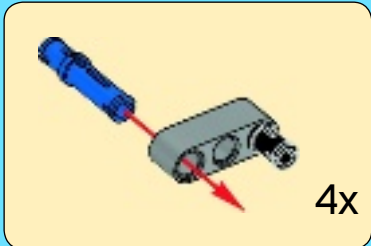



4x



2x

1



2x



1x

2

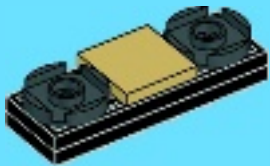

2x



1x

3

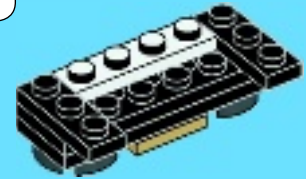
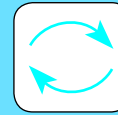

1x

4



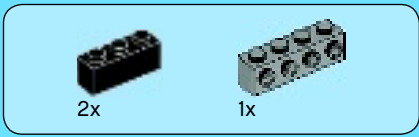

5

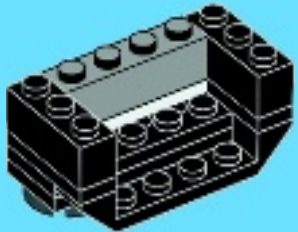

6

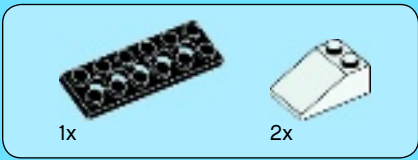

7

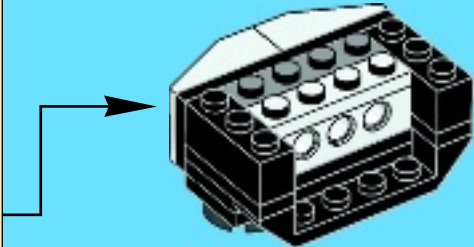
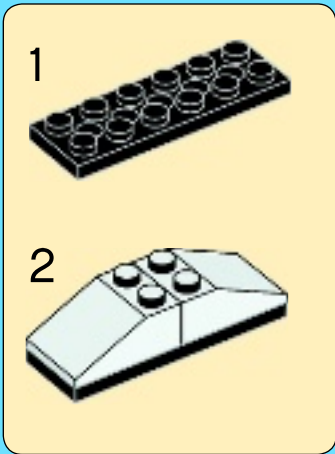

8





4x



2x

9

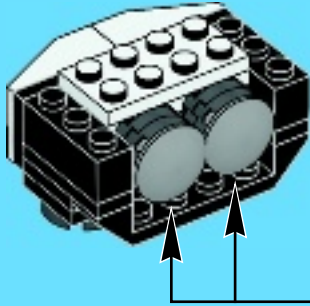

2x



1x

10

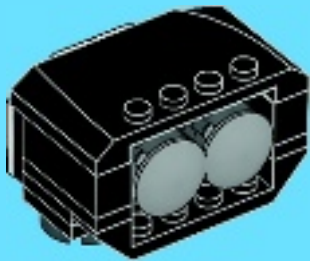

1x



1x



2x



5

1:1

11

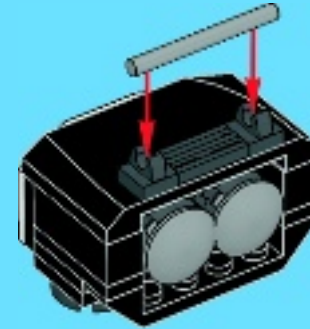

1x

5



2x

12

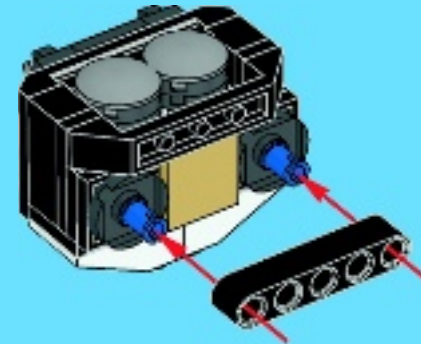
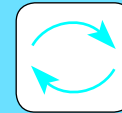

4x

98

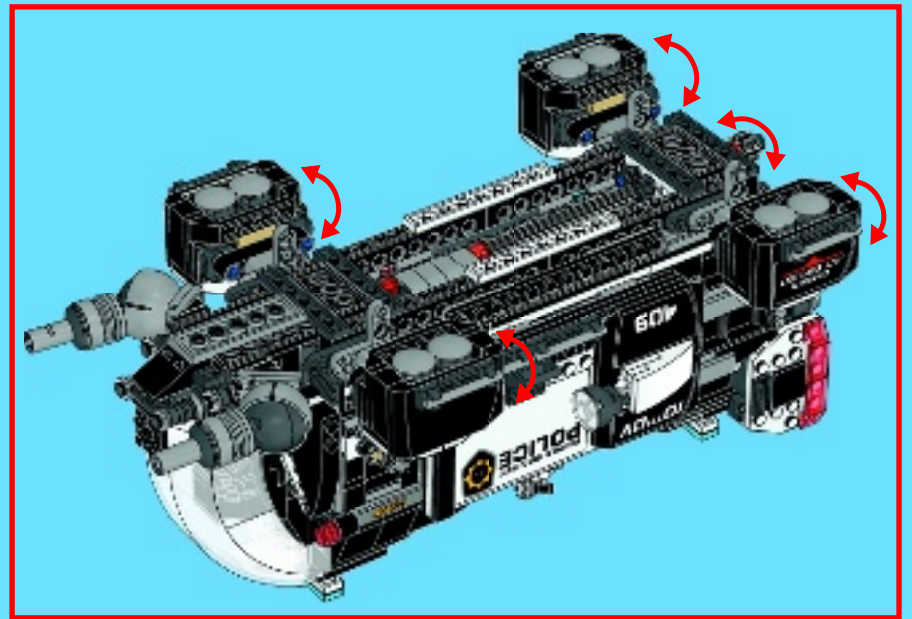
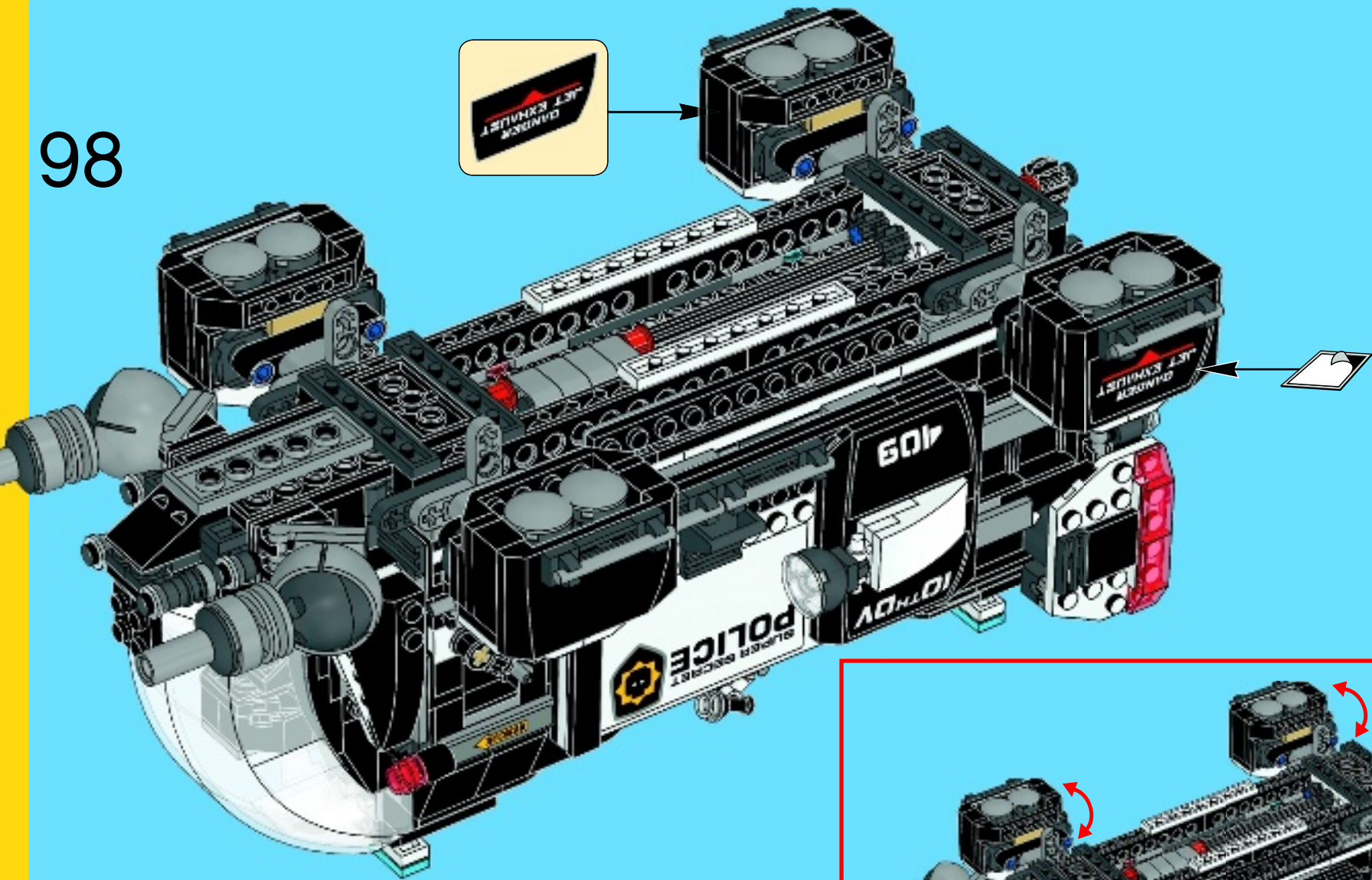



99

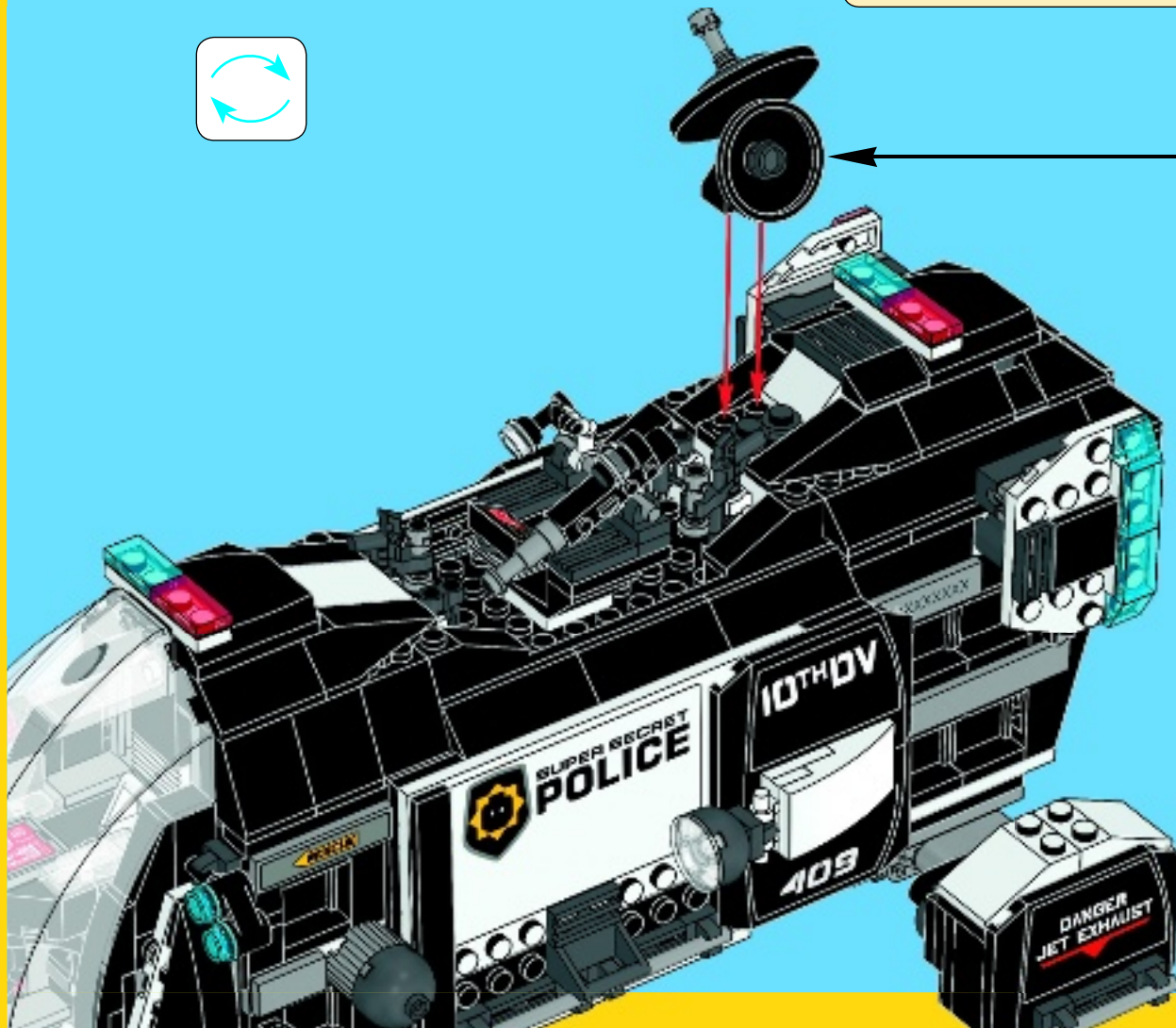
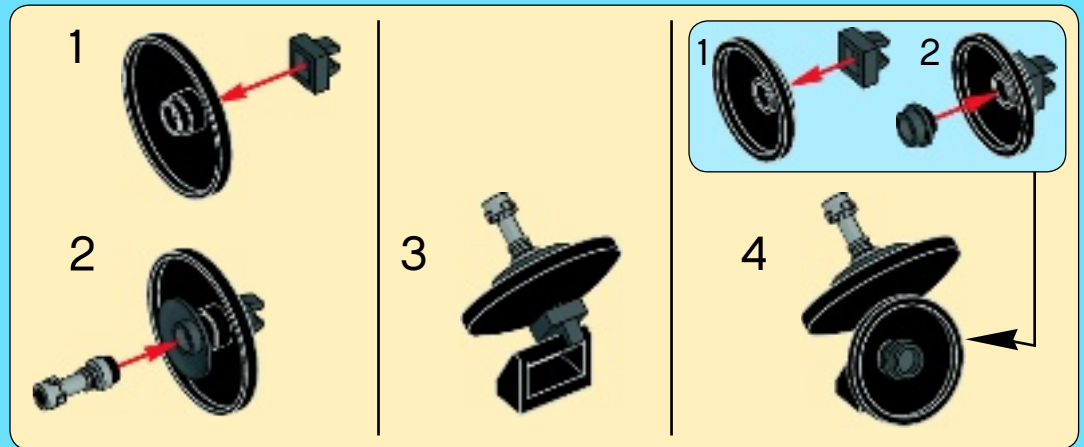
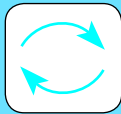

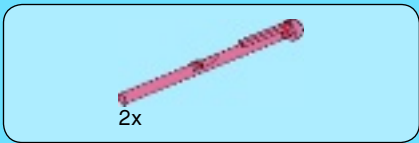

100

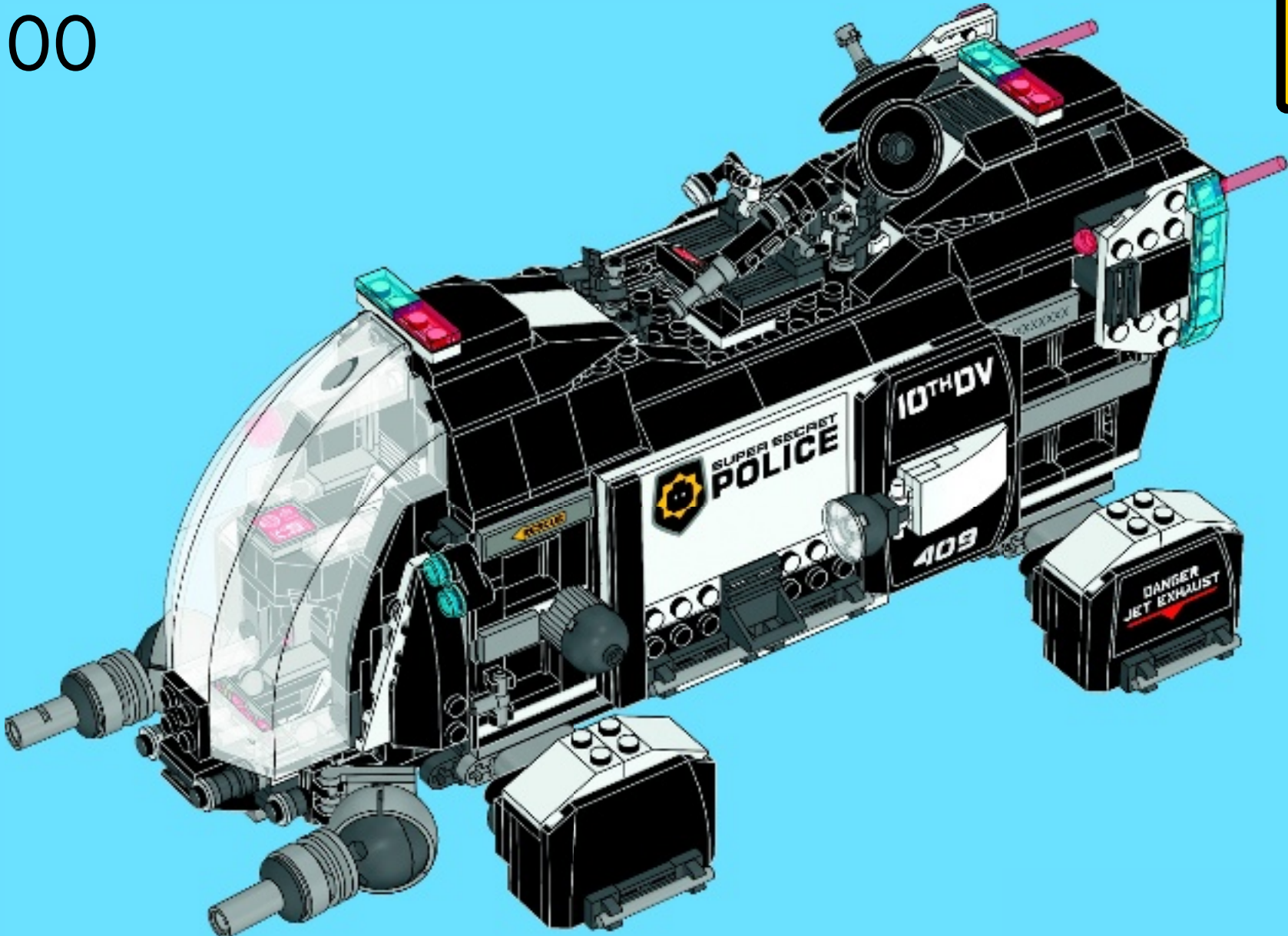

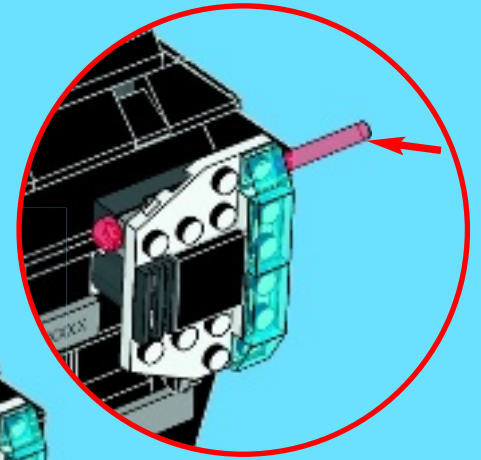
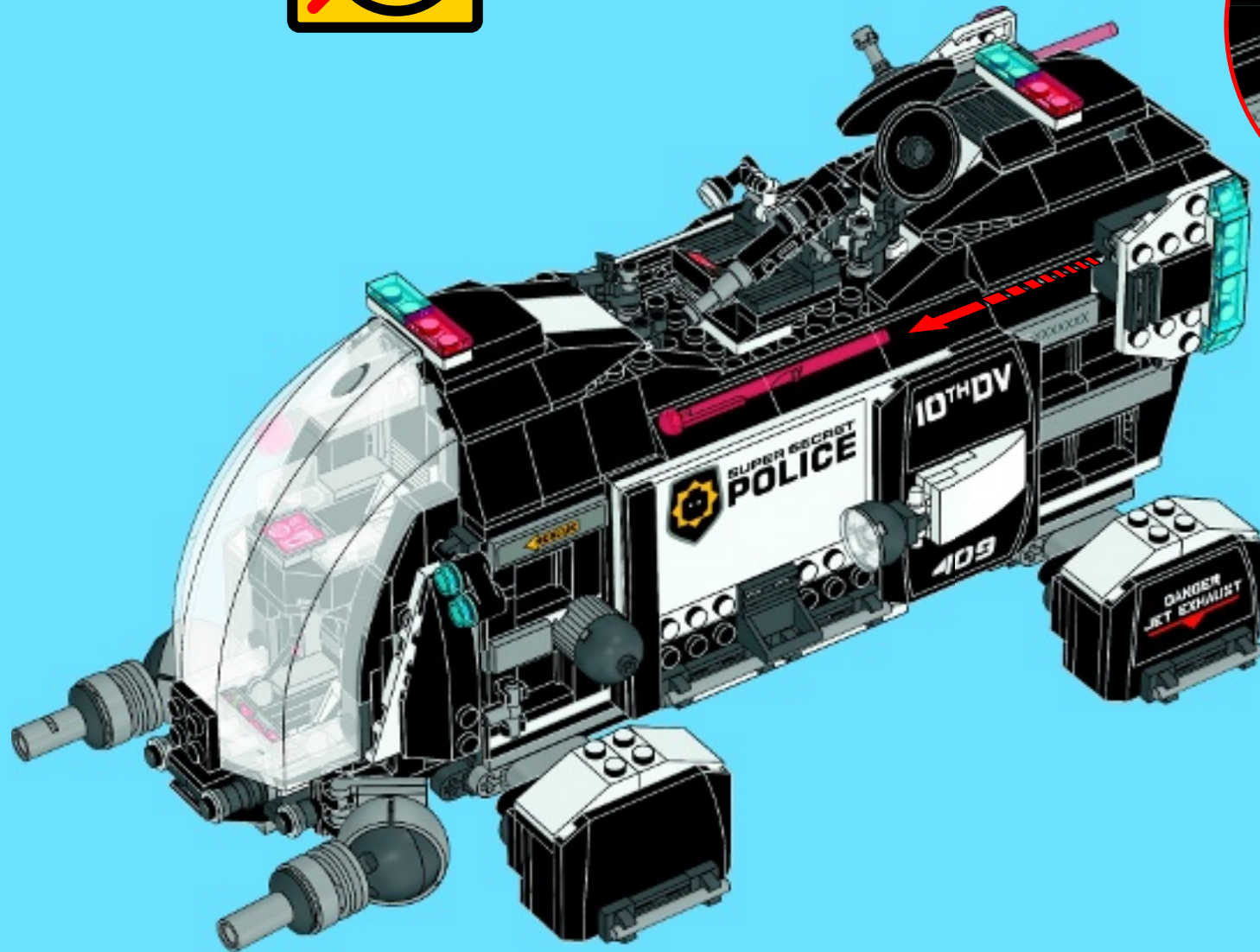



THE LEGO MOVIE VIDEOGAME

Surprise item
Überraschungsartikel
Objet surprise
Artículo sorpresa
Artigo surpresa
Meglépetés darab

For consoles only
Nur für Konsolen
Pour consoles uniquement
Sólo para consolas
Apenas para consolas
Csak konzolokhoz
仅限游戏控制器



PS3 PS4 PSVITA XBOX ONE XBOX 360 PC Wii U NINTENDO 3DS NINTENDO DS Nintendo eShop



The LEGO Movie Videogame software © 2014 TT Games Publishing Ltd. Produced by TT Games under license from the LEGO Group. LEGO, the LEGO logo, the Brick and the Knob configurations and the Minifigure are trademarks of the LEGO Group. © 2014 The LEGO Group. THE LEGO MOVIE © The LEGO Group & Warner Bros Entertainment Inc. The "PS" Family logo and "PS3" are registered trademarks of Sony Computer Entertainment Inc. The "PS4" and "PSVITA" logos are trademarks of the same company. Wii U and Nintendo 3DS are trademarks of Nintendo. © 2012 Nintendo. All other trademarks and copyrights are the property of their respective owners. All rights reserved.

WB GAMES LOGO, WB SHIELD: ™ & © Warner Bros. Entertainment Inc. (s14)





2 IN 1
合



70804



70805



70806



LEGO PARKS

BILLUND • DEUTSCHLAND
MALAYSIA • WINDSOR



LEGO DISCOVERY CENTER

MANCHESTER • TOKYO
BERLIN • OBERHAUSEN



Indoor Attraction • LEGO Rides • LEGO
MINILAND • 4D Cinema • LEGO Factory
Tour • Soft Play • Birthday Room •
Shop & Cafe

KIDS GO FREE

with full paid adult ticket

Purchase at LEGOLAND.com/TLMROW2014

See website for terms and offer details.

FREIER KINDER-EINTRITT

in Verbindung mit einem voll zahlenden Erwachsenen.

Erhältlich bei LEGOLAND.com/TLMROW2014

Siehe Webseite für alle Angebotsdetails und Konditionen.

ENTRÉE GRATUITE POUR LES ENFANTS

pour l'achat d'un billet adulte

Billets disponibles à la vente sur LEGOLAND.com/TLMROW2014

Conditions et détails de l'offre disponibles sur le site Internet



club™

Free*! Gratuit!

* Paid subscription in Australia and New Zealand.
Abonnement payant en Australie et Nouvelle-Zélande.



LEGO.com/club

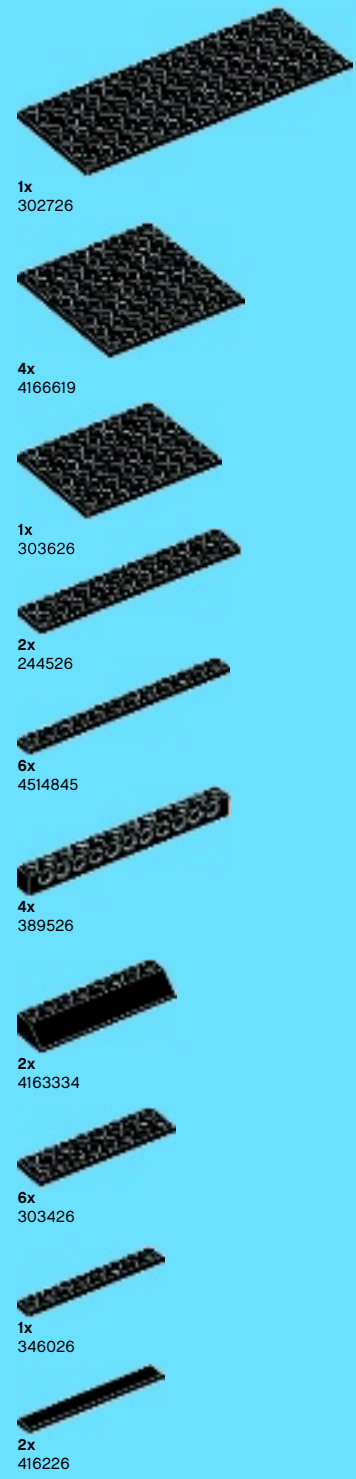
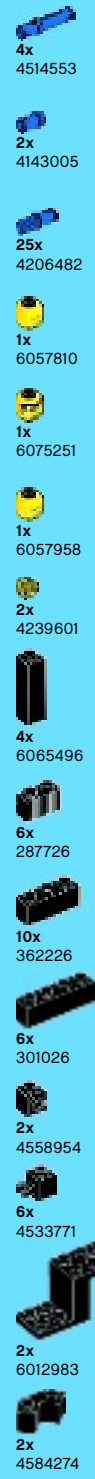
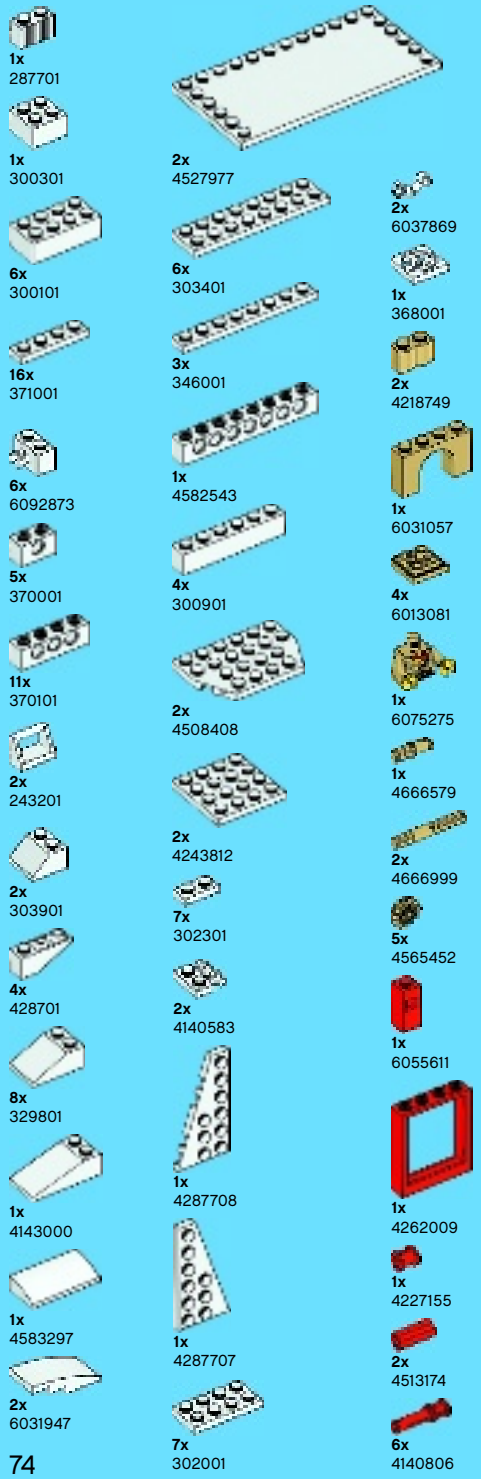



5

12

3

4

Customer Service
Kundenservice
Service Consommateurs
Servicio Al Consumidor
LEGO.com/service or dial





DC COMICS SUPERHEROES

LEGO and the LEGO logo are trademarks of the LEGO Group.
©2014 The LEGO Group. 6092414

THE LEGO MOVIE © The LEGO Group & Warner Bros. Entertainment Inc. (s14)

BATMAN: TM & © DC Comics. © Warner Bros. Entertainment Inc. (s14)



LEGO.com



76010



76011



76013



76012

LEGO.COM/SUPERHEROES



TM

TM & © DC Comics.
WB SHIELD: TM & © Warner Bros. Entertainment Inc. (s14)