



NEXO KNIGHTS



72003







1

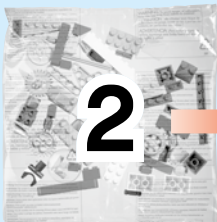
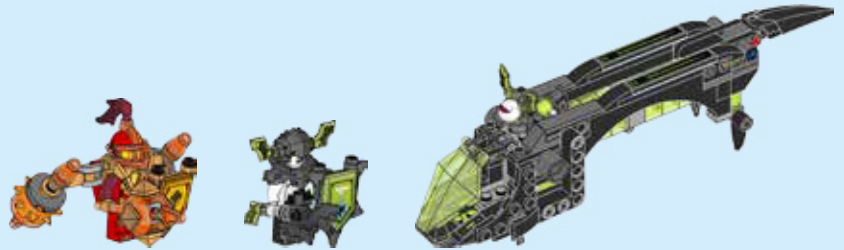

2

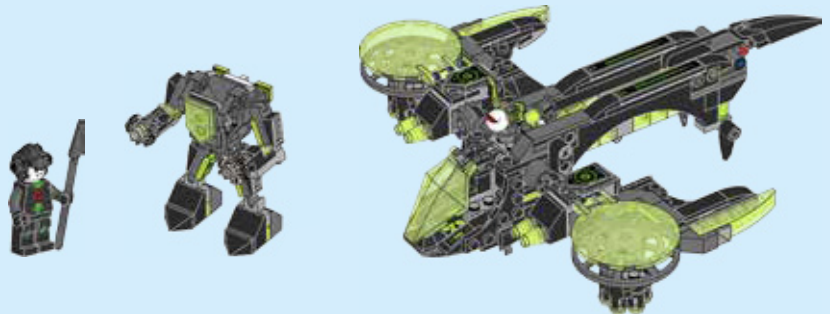

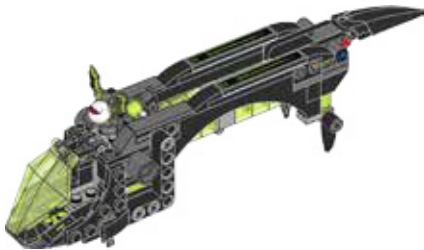

1x



1x



1x



1x

1





2

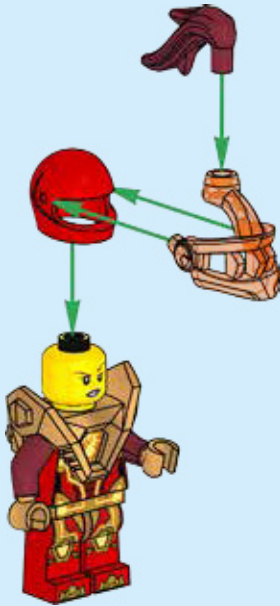

3



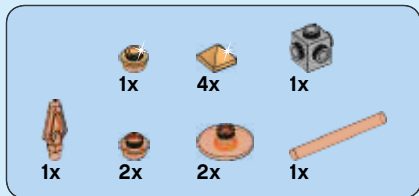

4

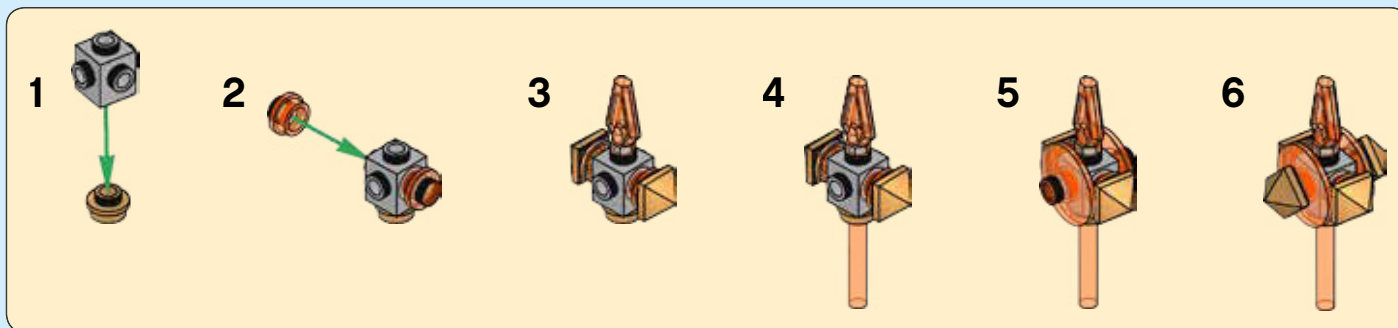

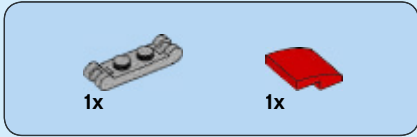
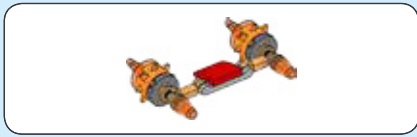

5

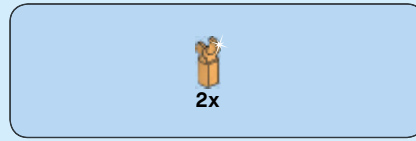
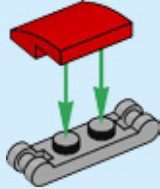

6

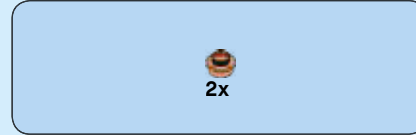
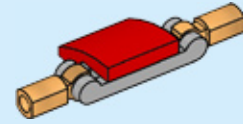

7

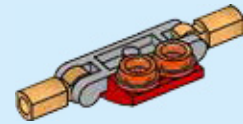
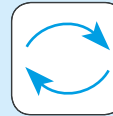



8

1

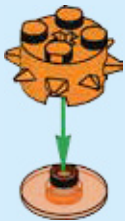

2

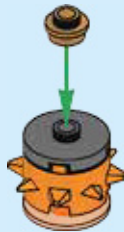

3

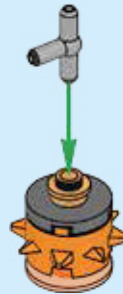

4



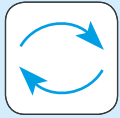

5

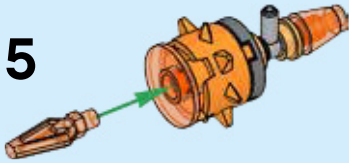

2x

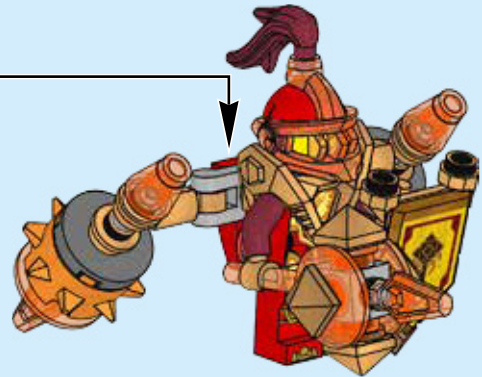
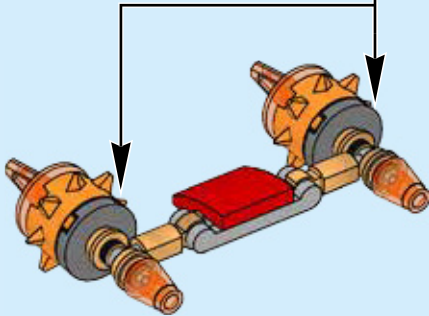
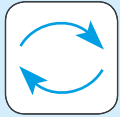



1

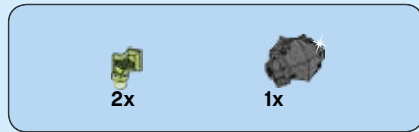
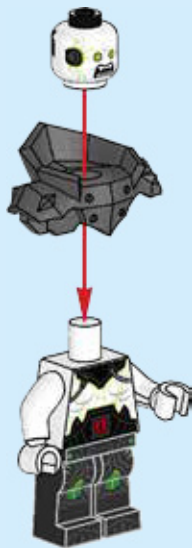

2

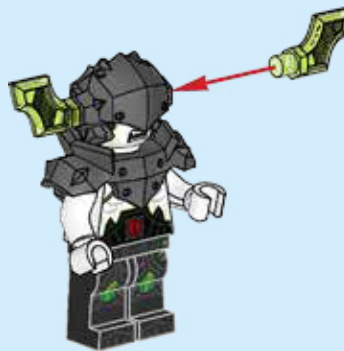

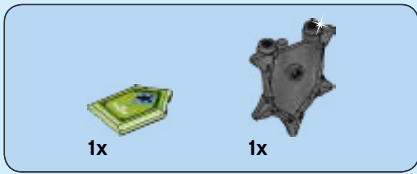

3

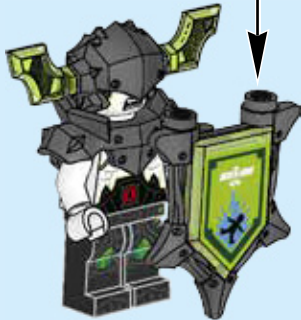
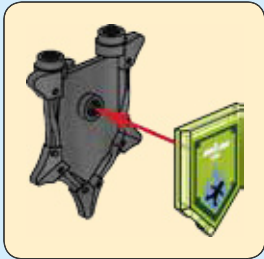

4

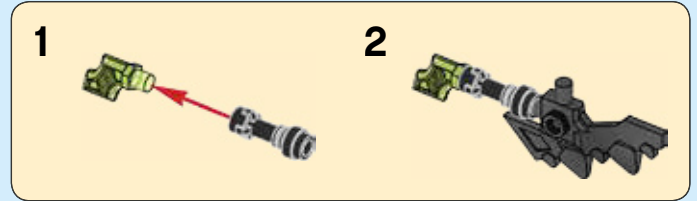

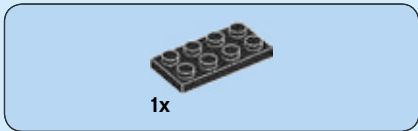
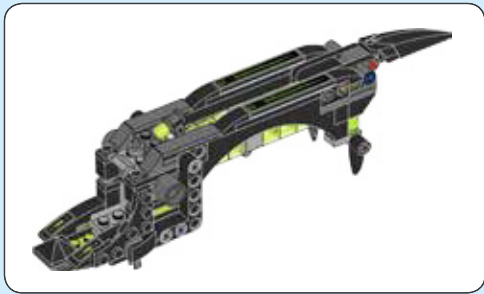

1

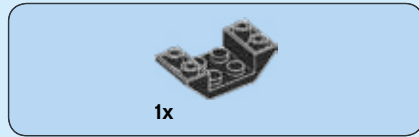
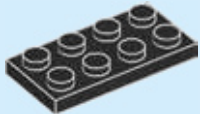

2

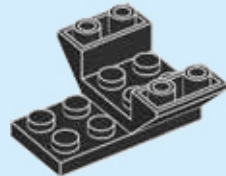

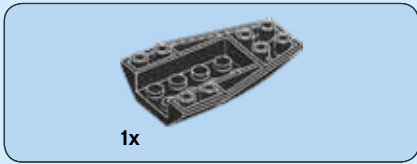

3

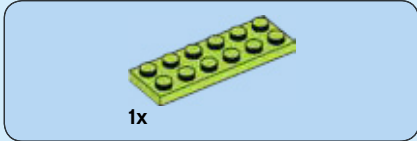
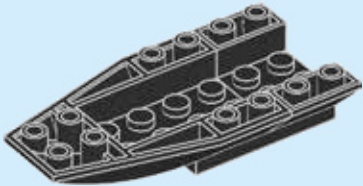

4

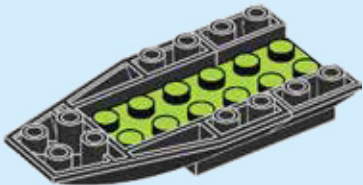

5

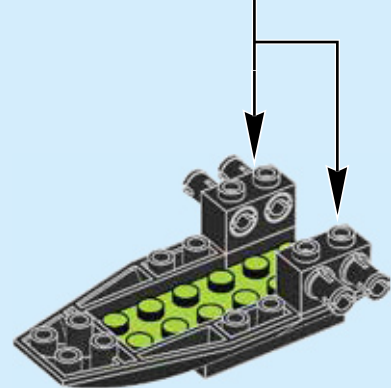
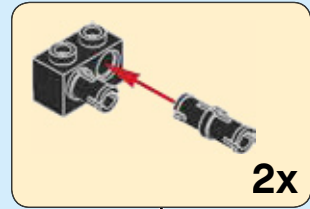



1x

6

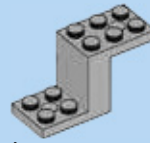
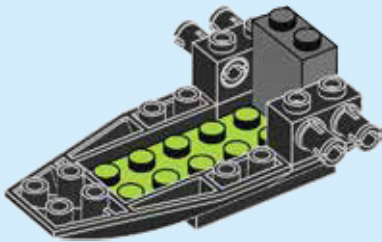

1x

7

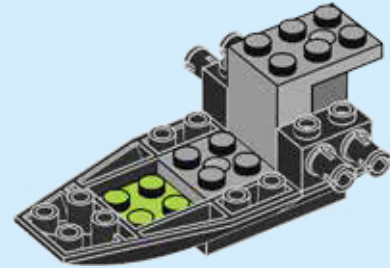

2x

8

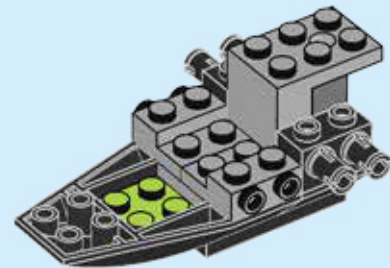



9

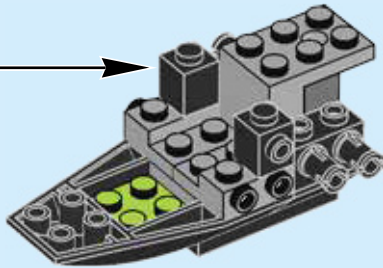
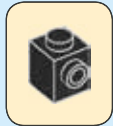

10

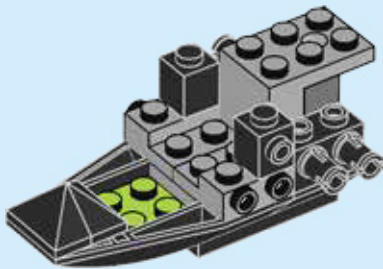

11

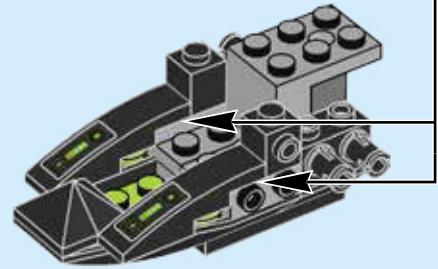
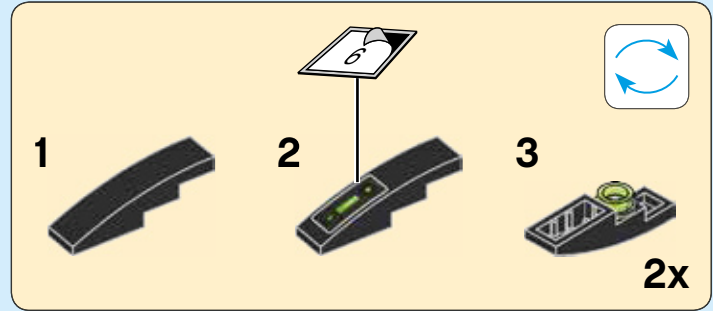



12

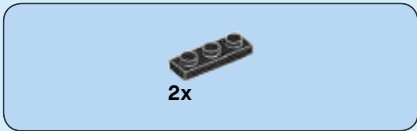
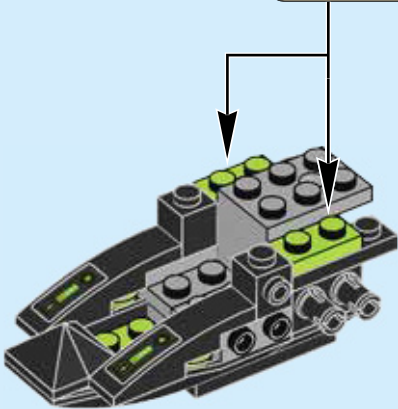
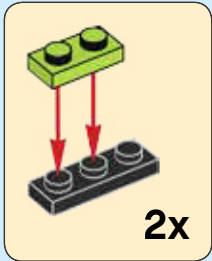

13

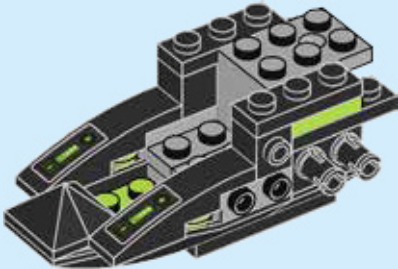

14

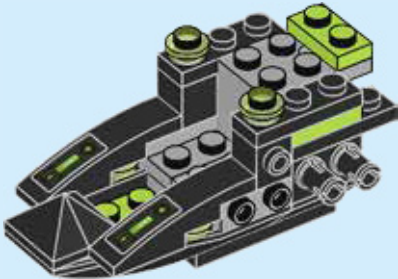

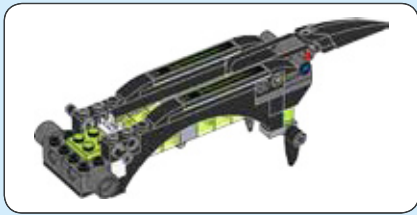

15



16

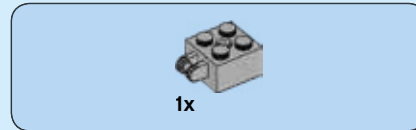
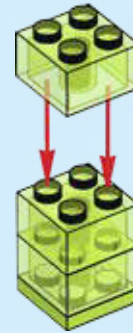

17





3x

18



1x



1x

19

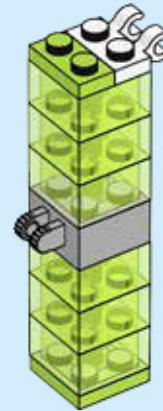

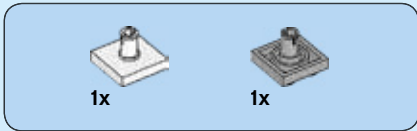

20

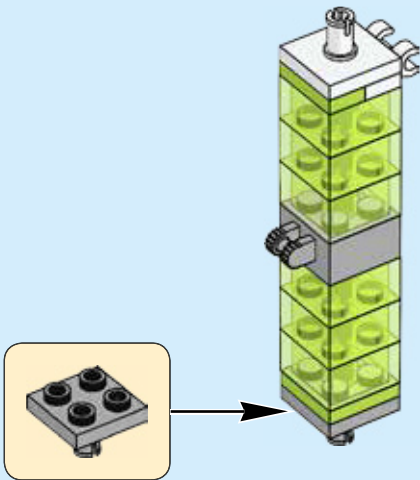

21

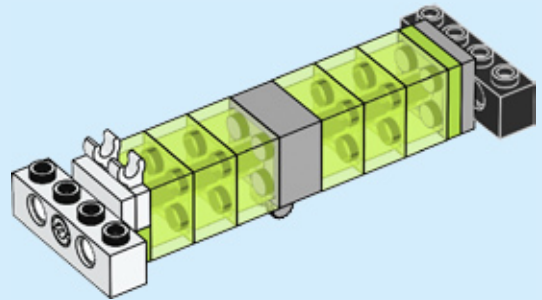
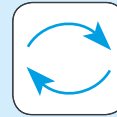

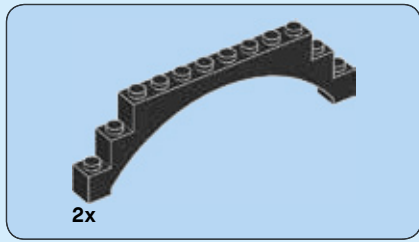

22

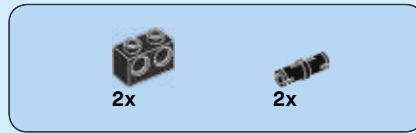
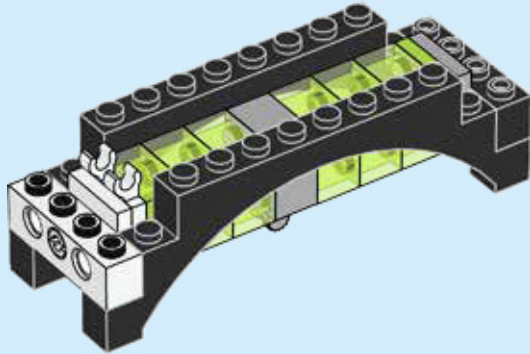

23

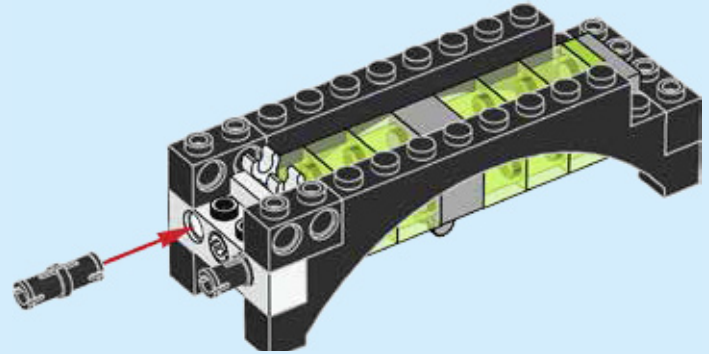



24

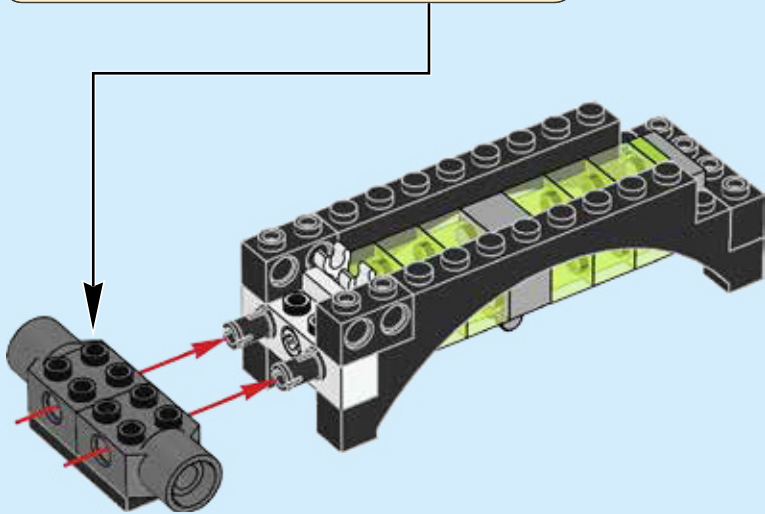
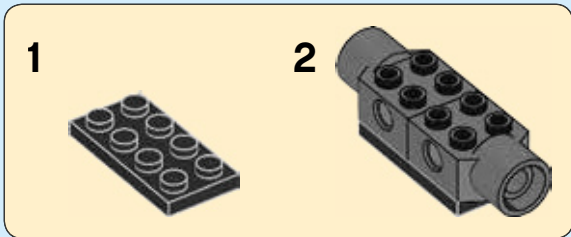

25

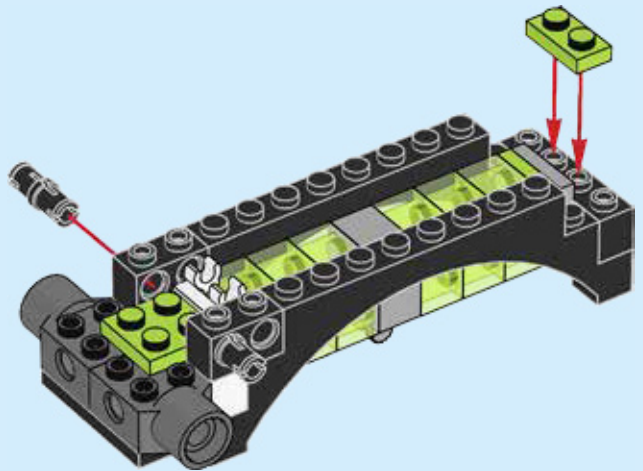

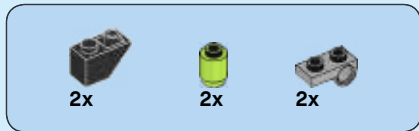

26

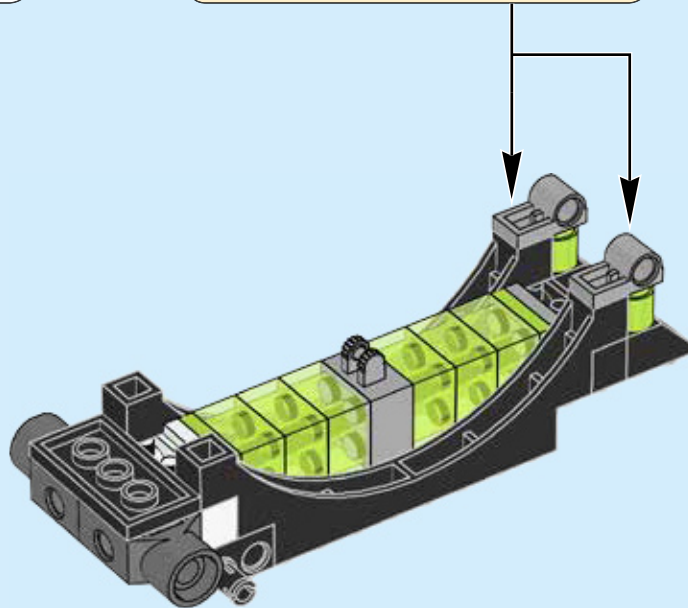
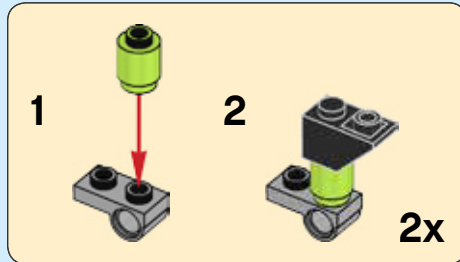
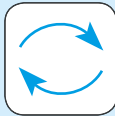

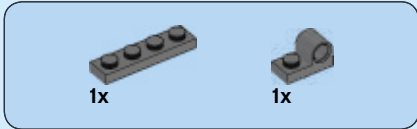

27

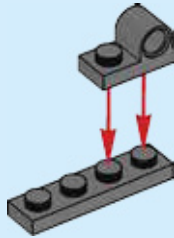

28

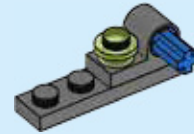

29

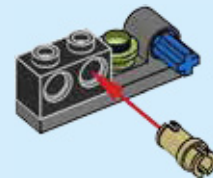

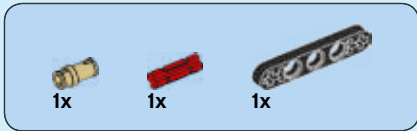

30

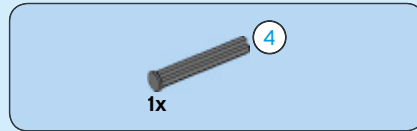
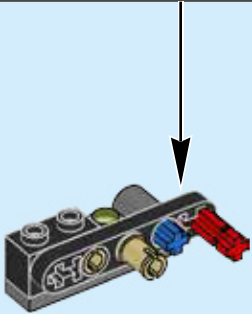
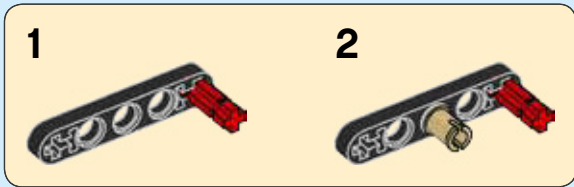

31

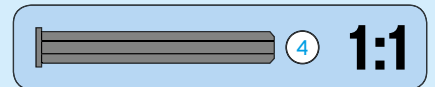
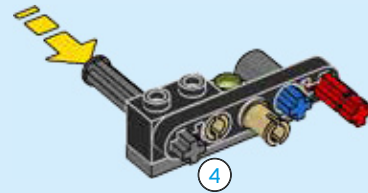

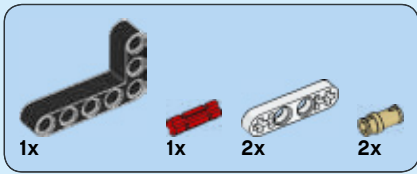

32

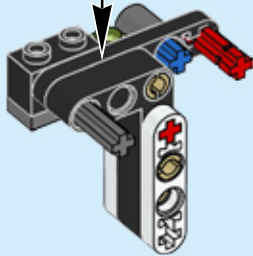
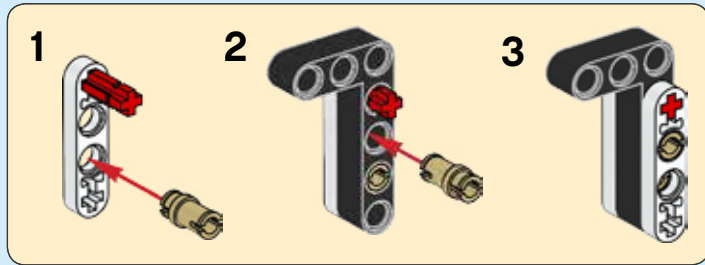

33

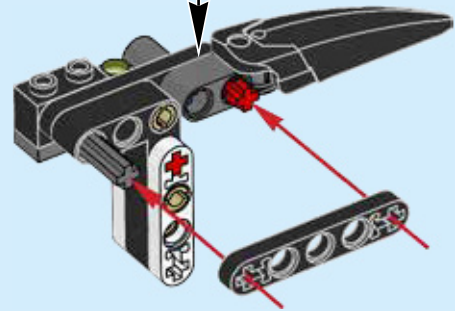
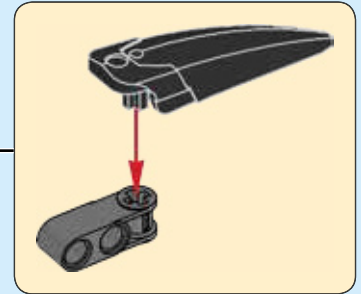

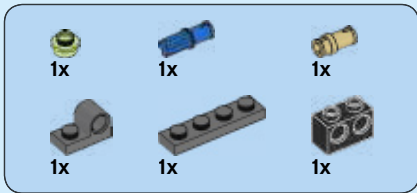

34

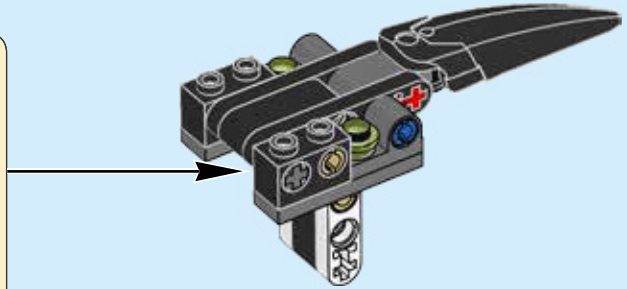

35

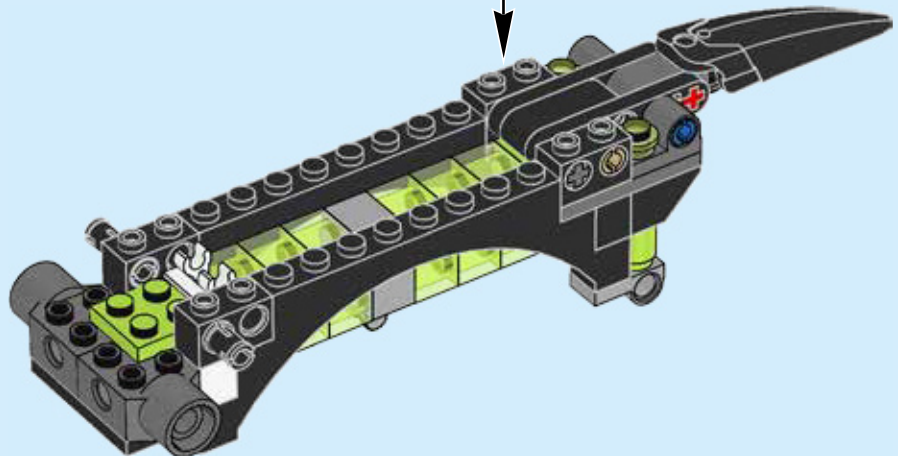
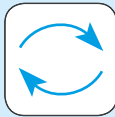

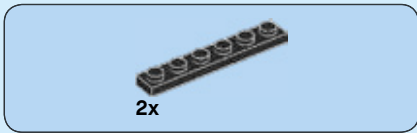

36

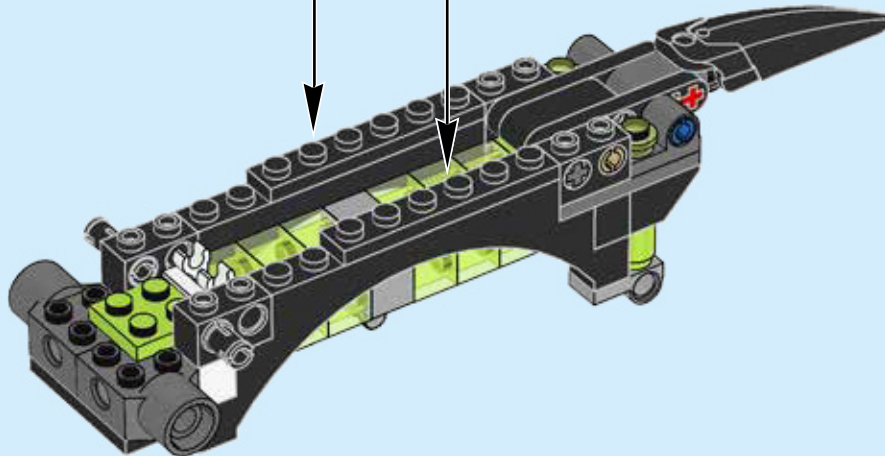
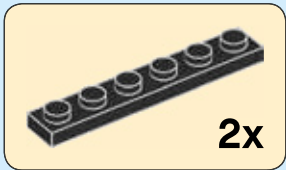

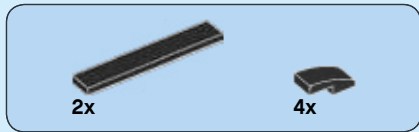

37

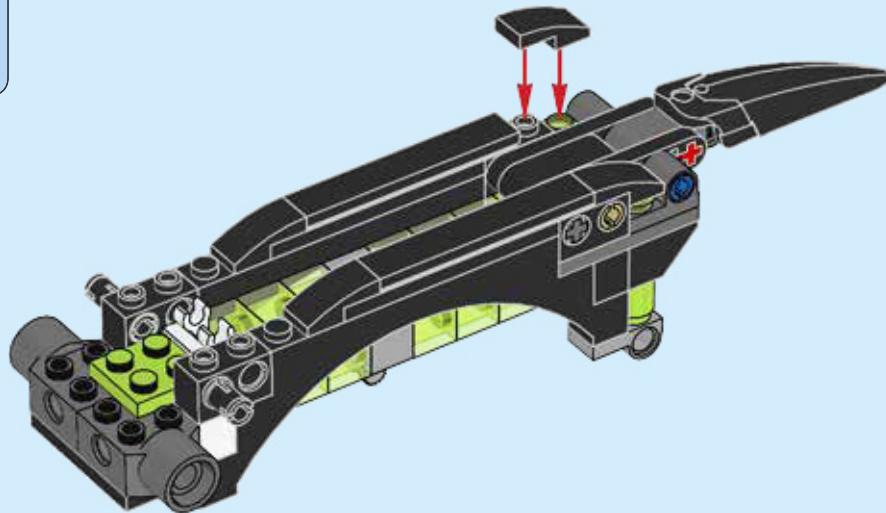

38

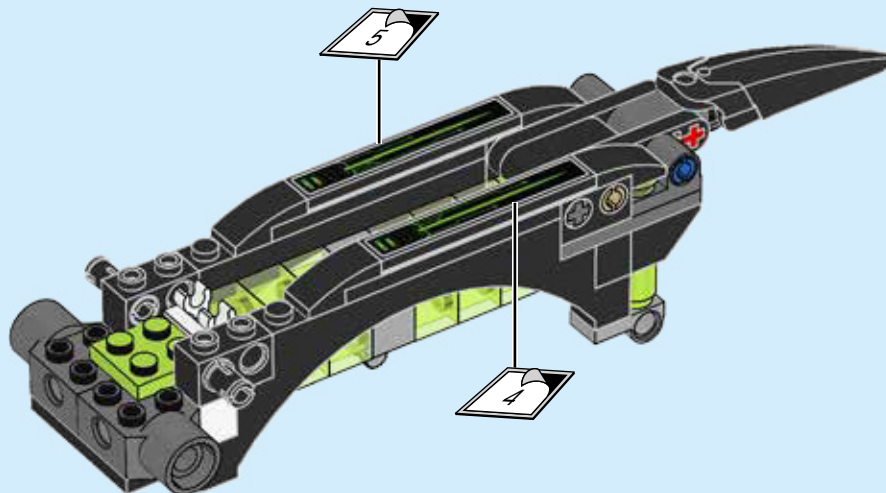

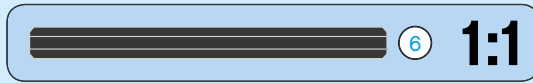
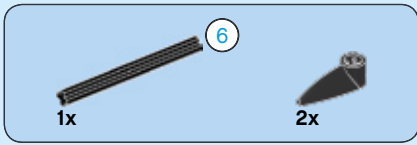

39

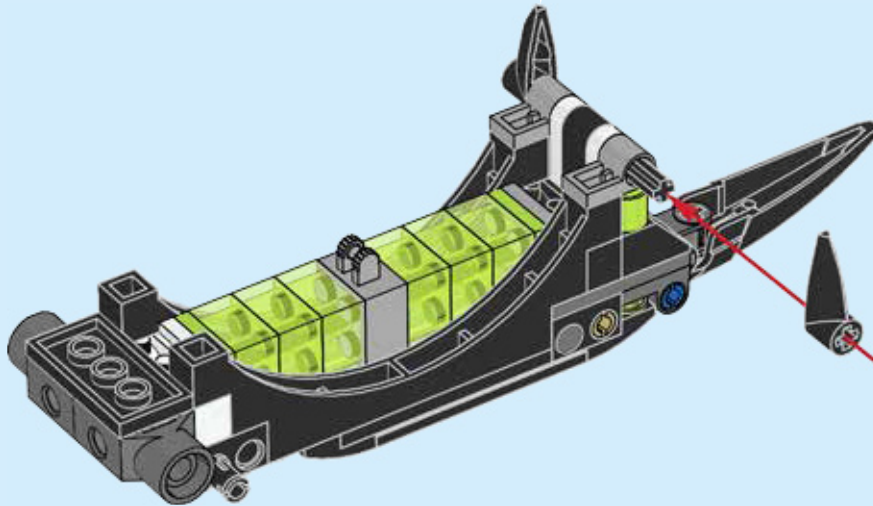
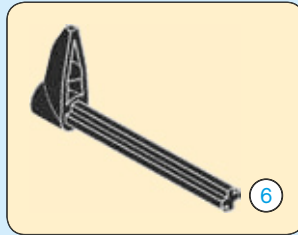
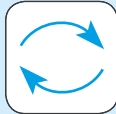

40

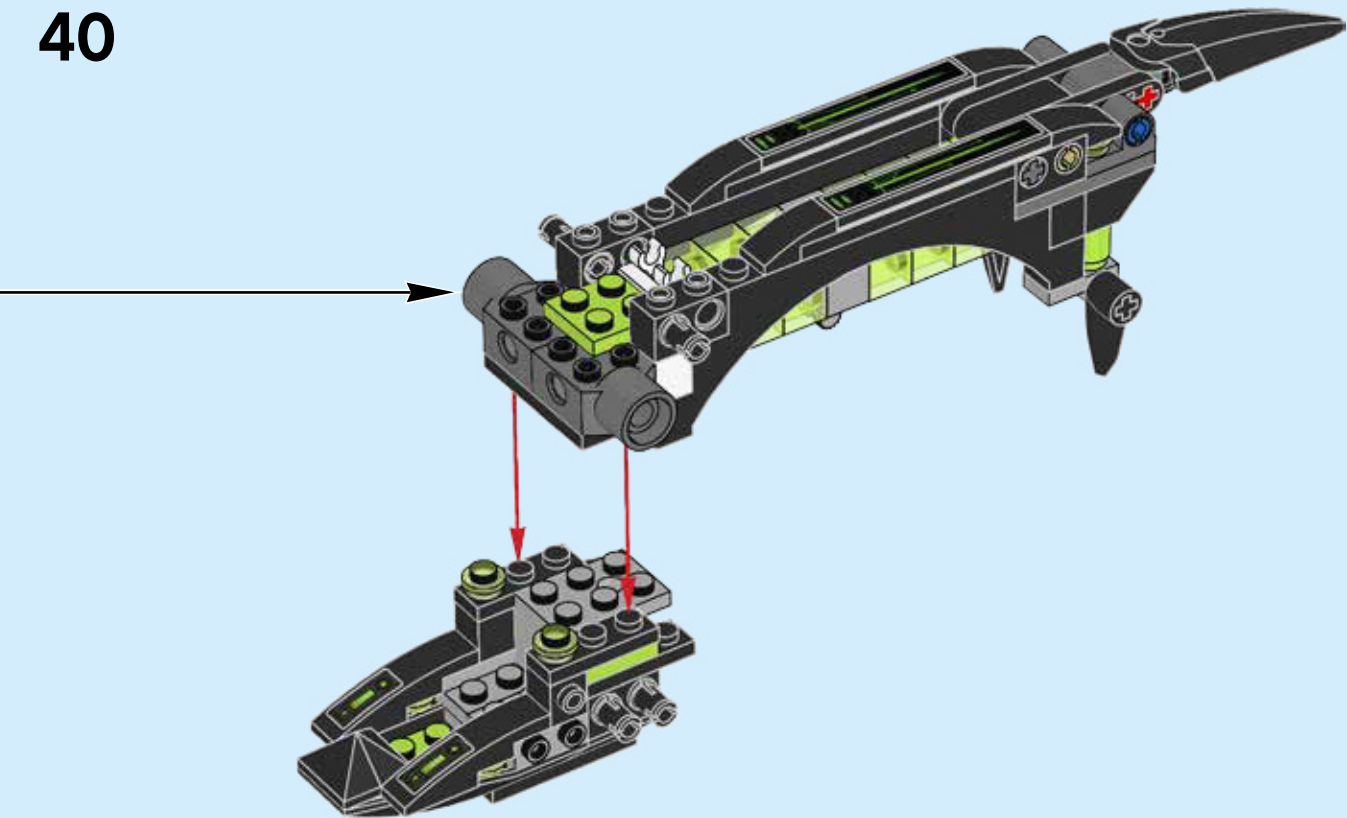

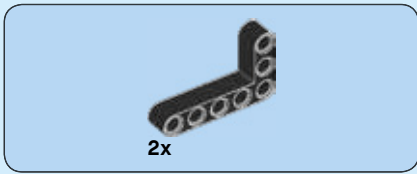

41

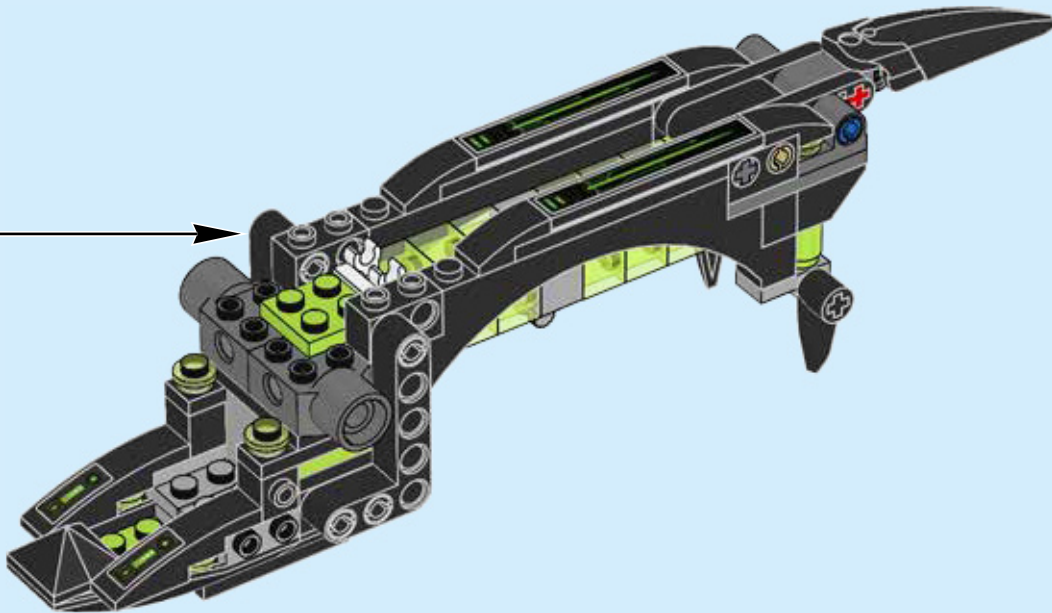
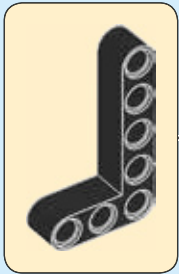



2x

42

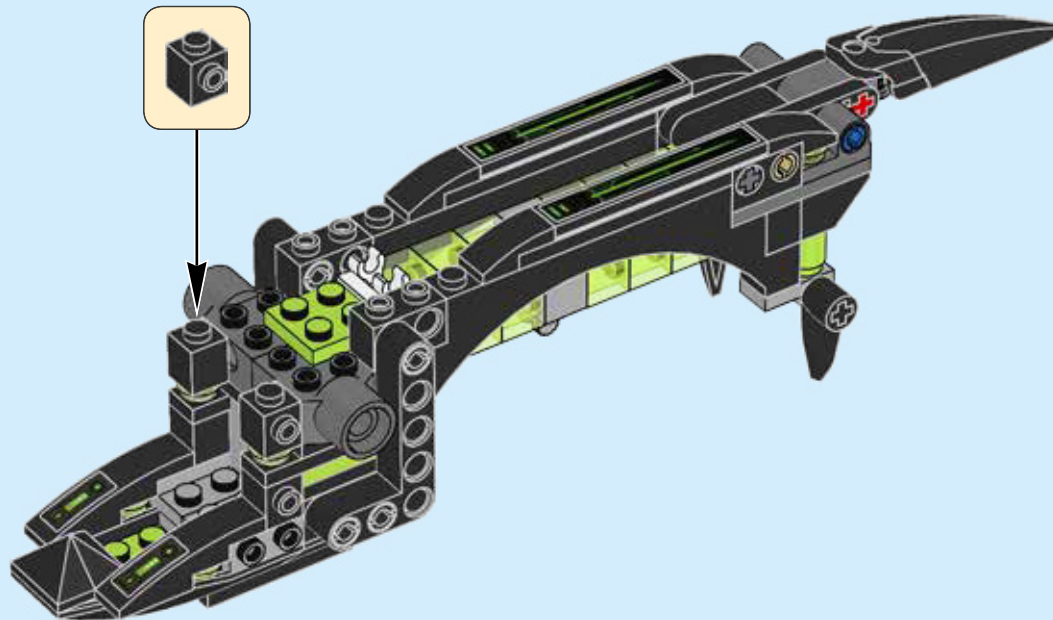



2x



1x

43

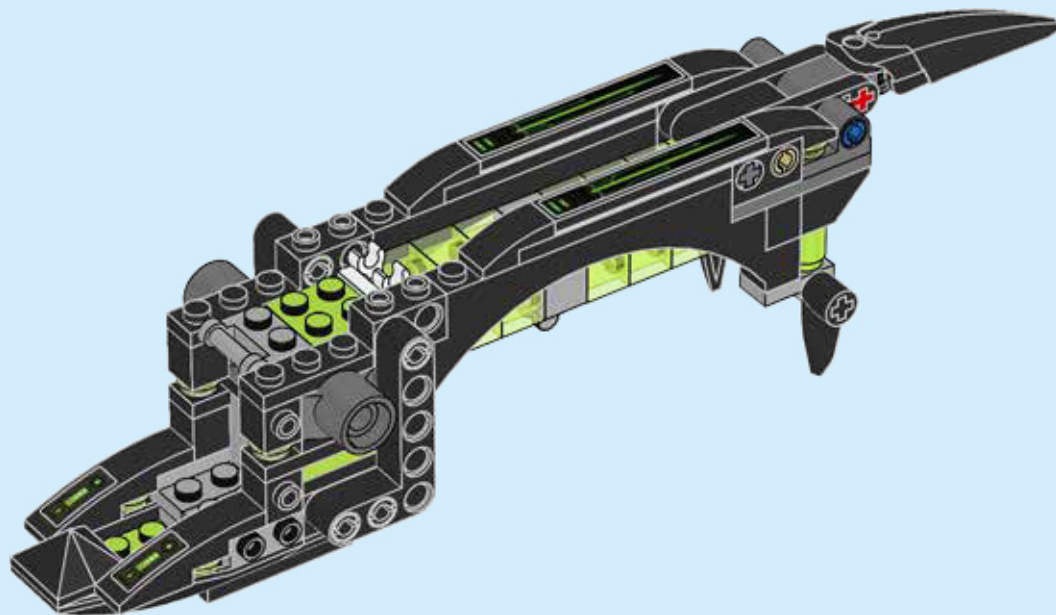



1x

44

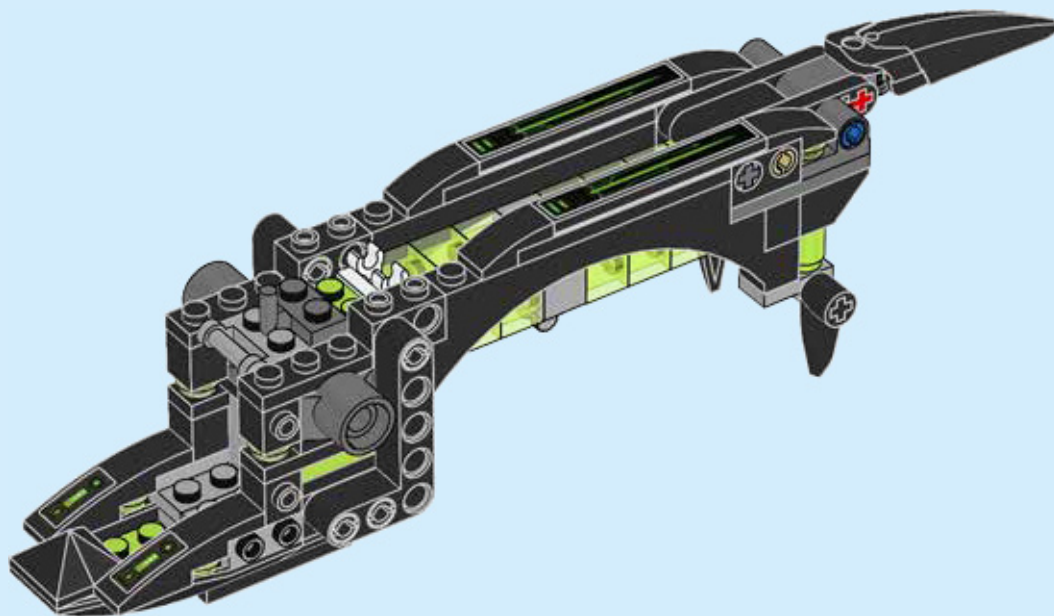

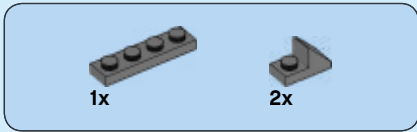

45

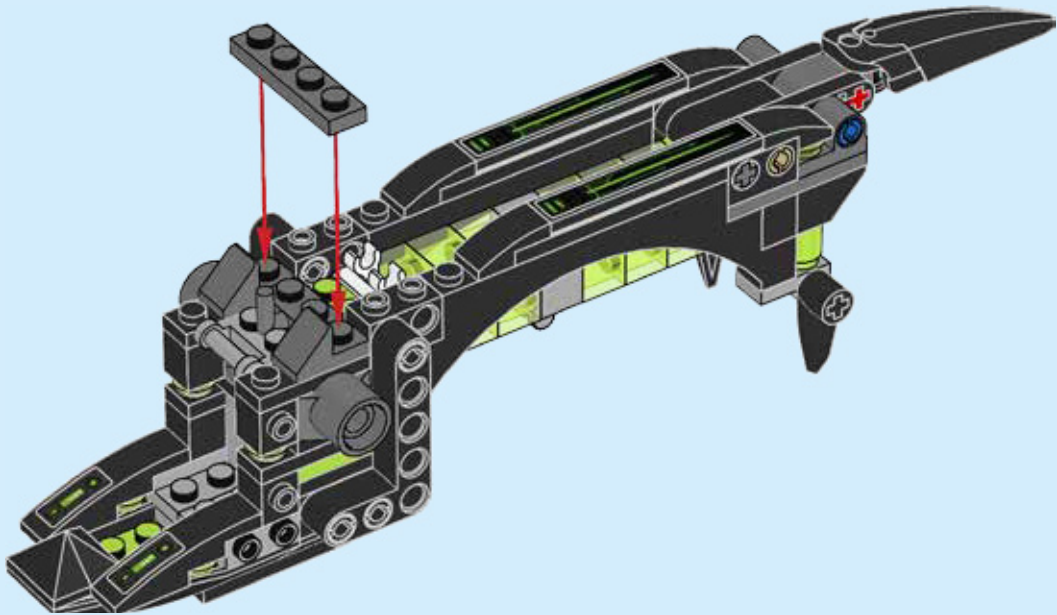



1x



1x

46

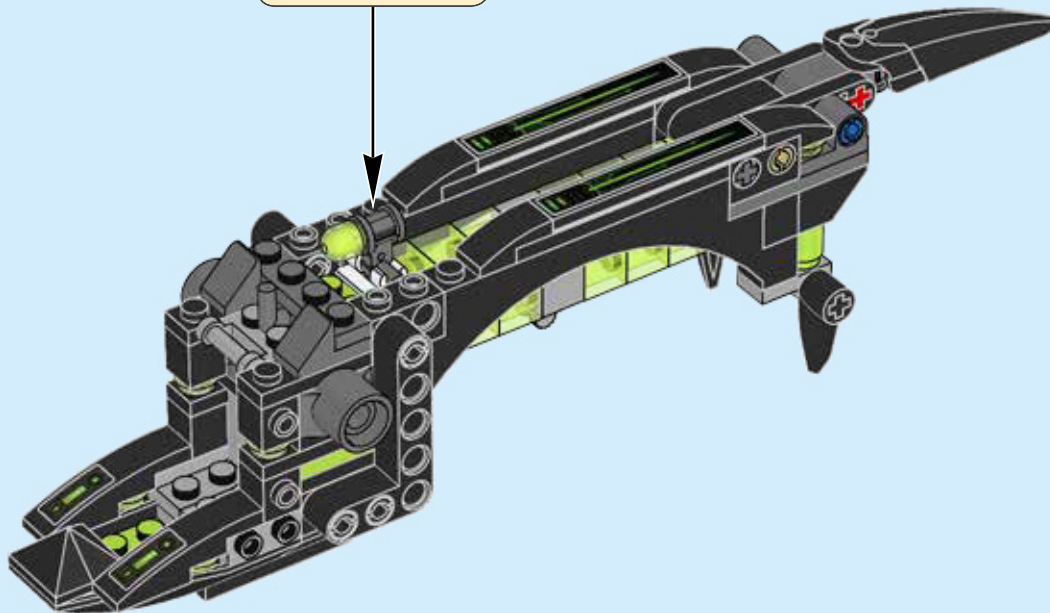
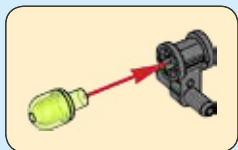

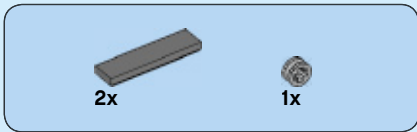

47

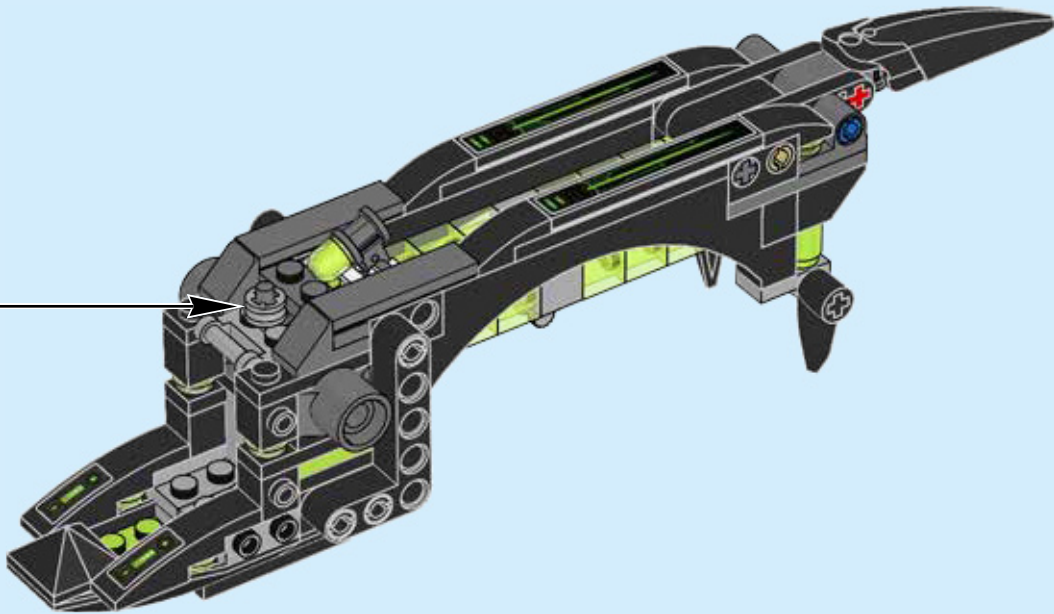

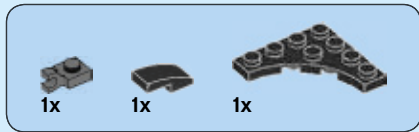

48

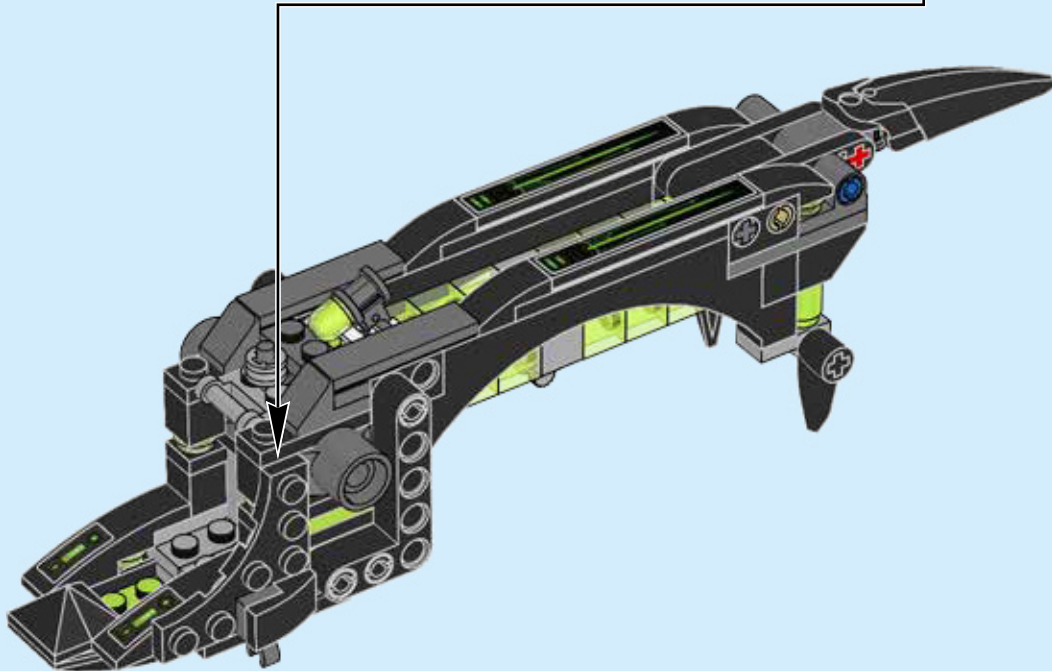
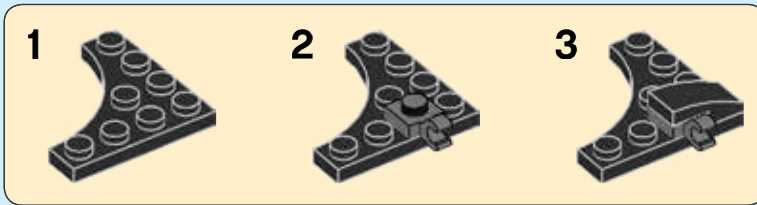

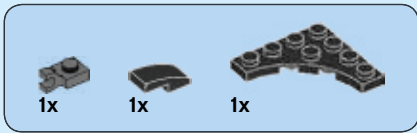

49

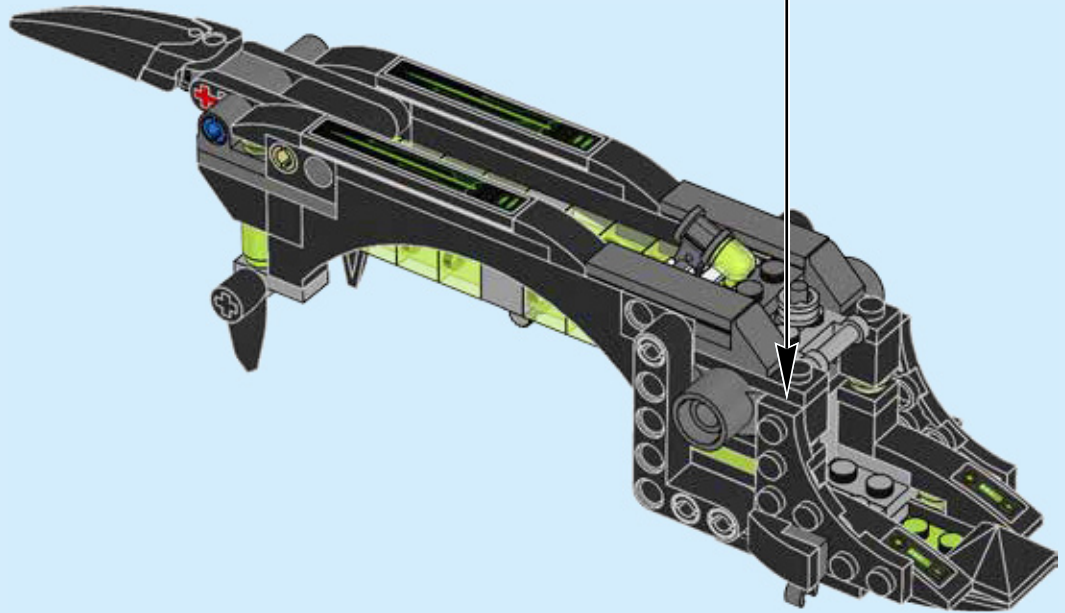
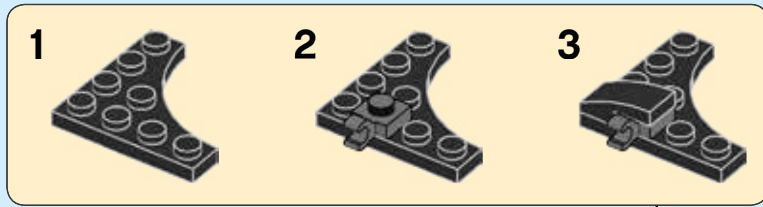



50

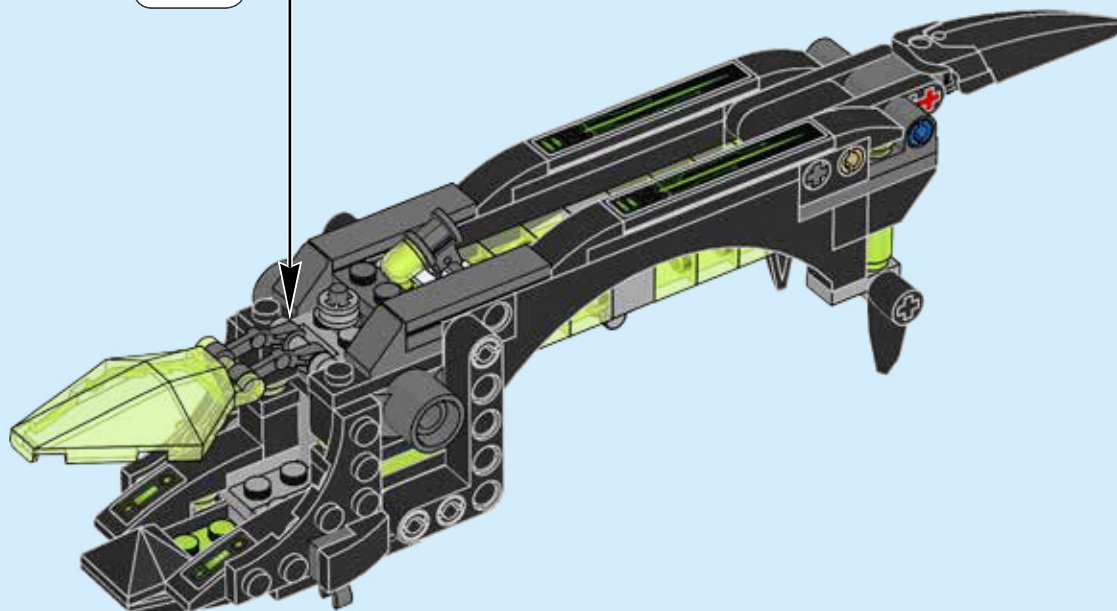
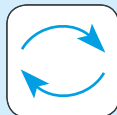

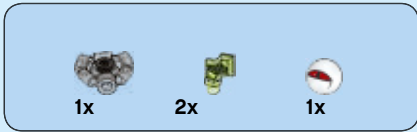

51

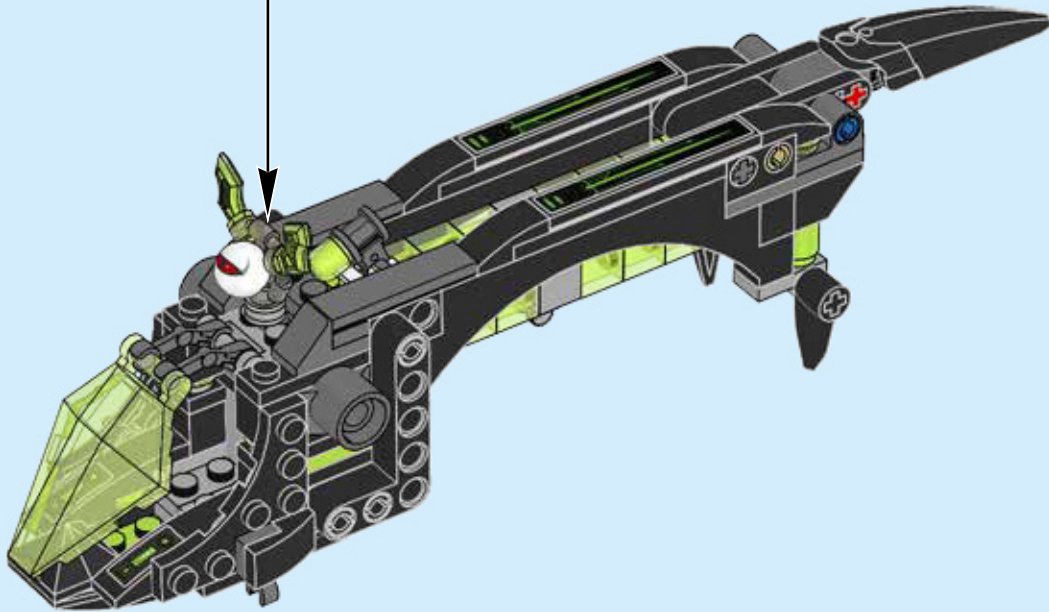

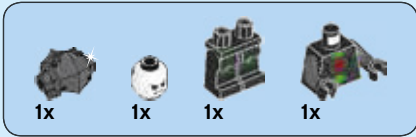
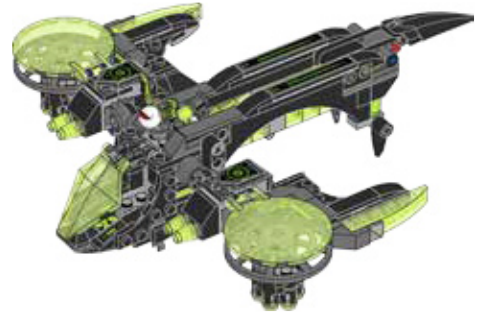
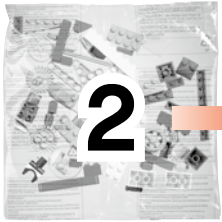

1

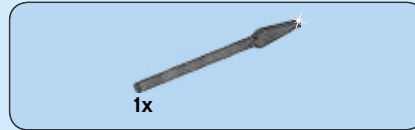

2



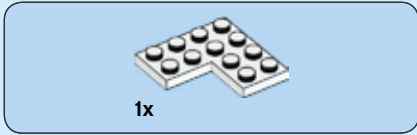

52

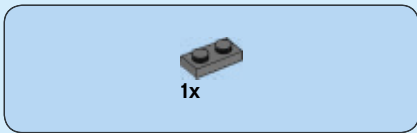
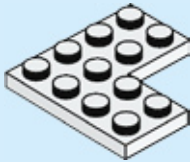

53

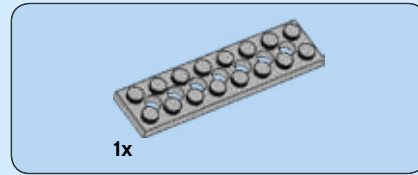
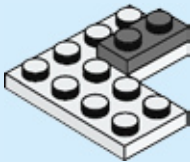

54

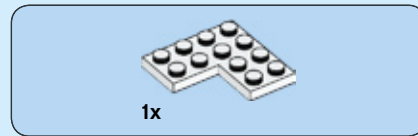
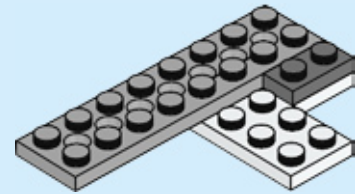

55

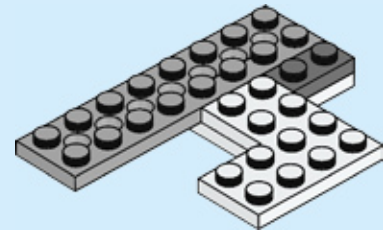

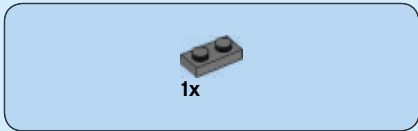

56

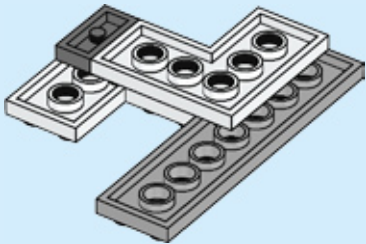
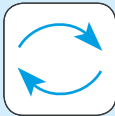

57

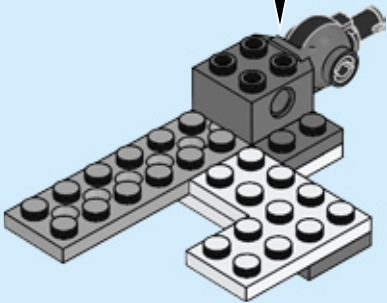
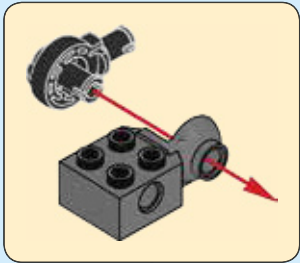
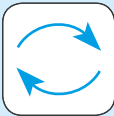



58

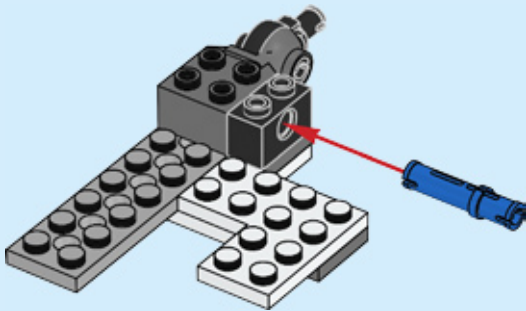

59

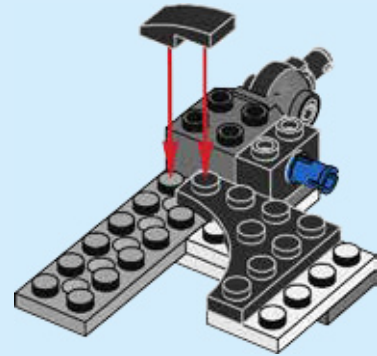

60

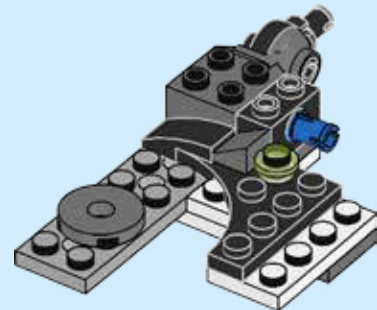

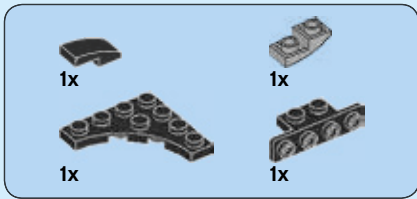

61

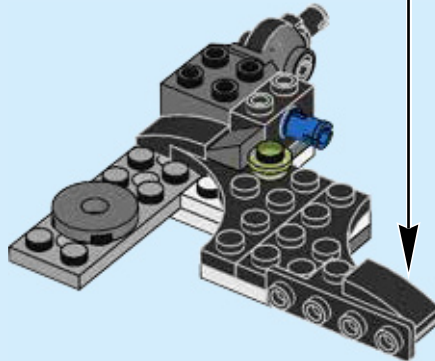
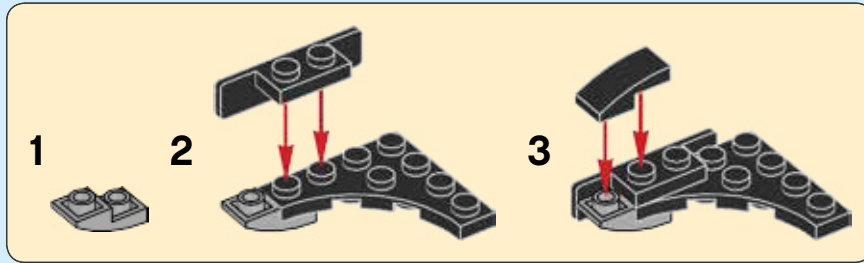



1x



2x

62

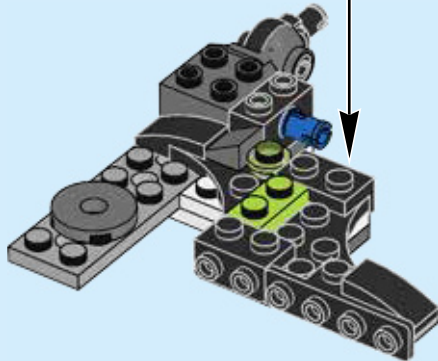
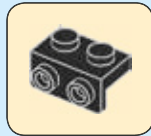

1x



1x



1x

63

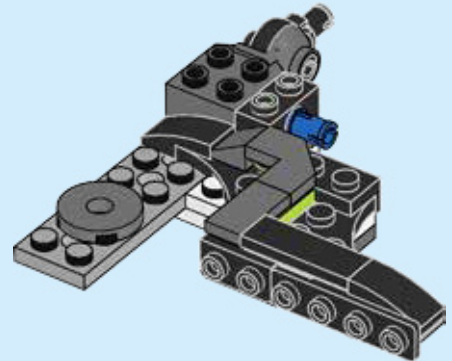

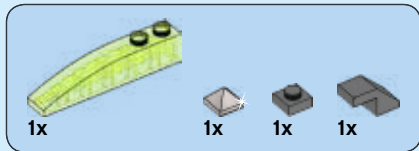

64

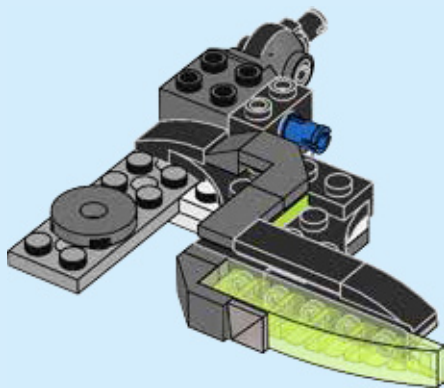
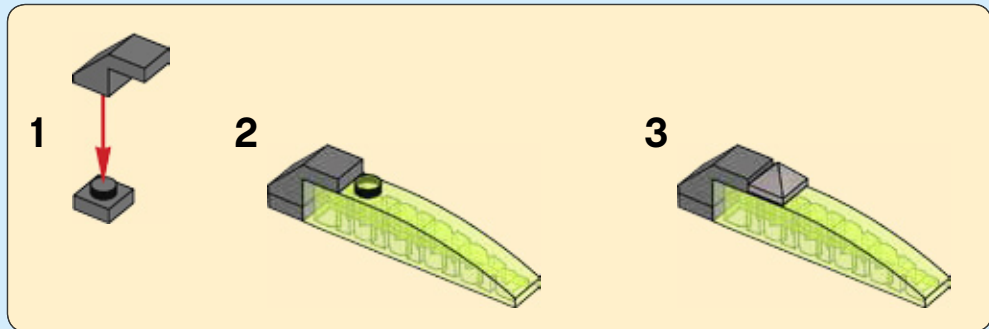



65

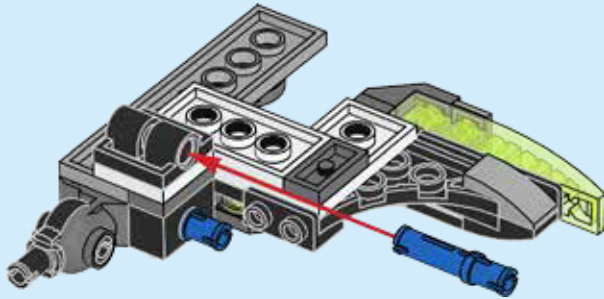
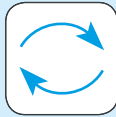

66

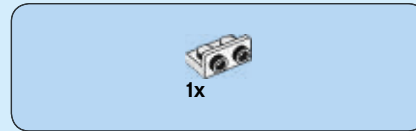
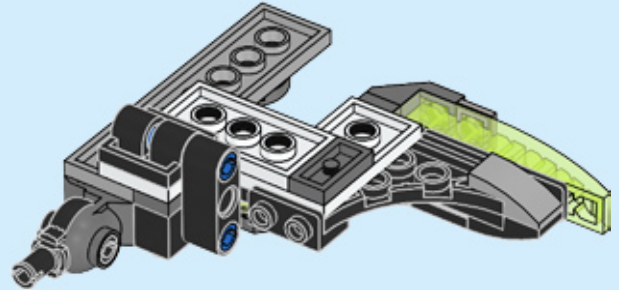

67

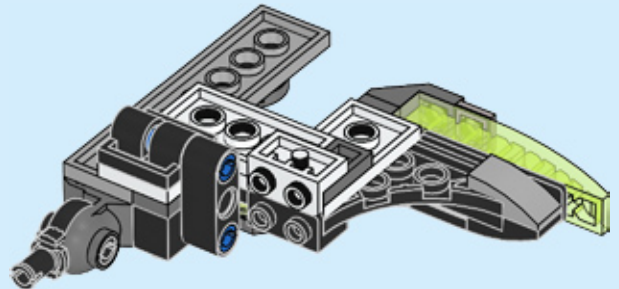



68

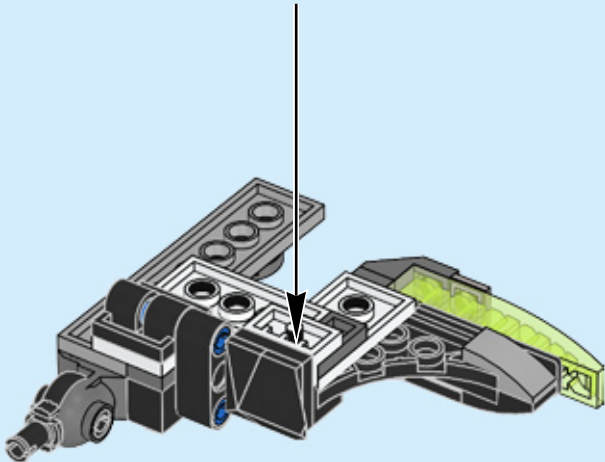
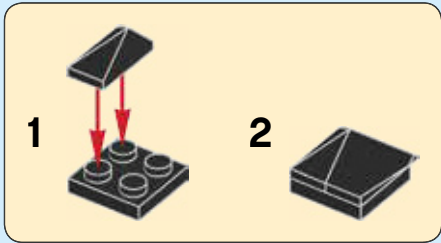

69

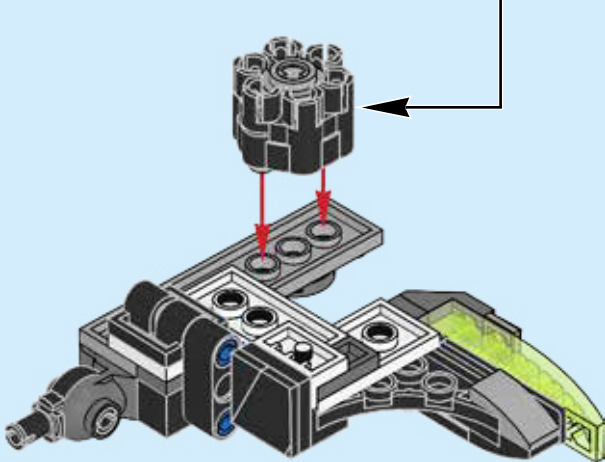
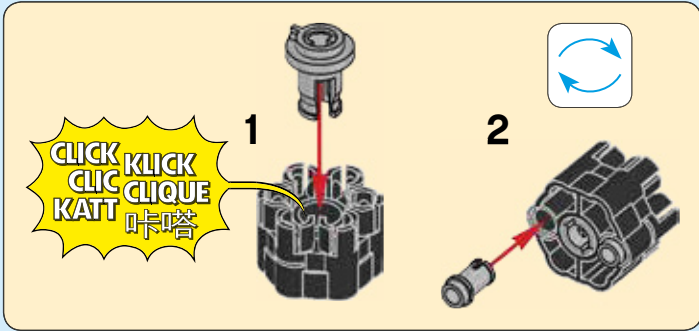

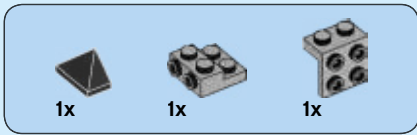

70

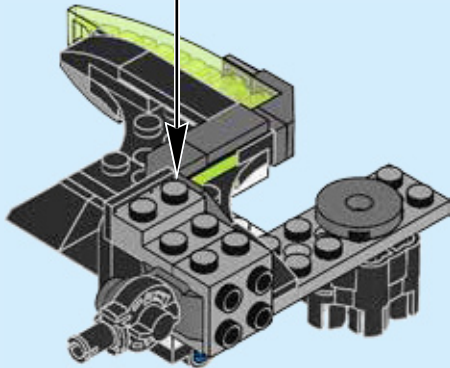
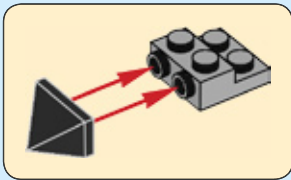
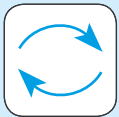

71

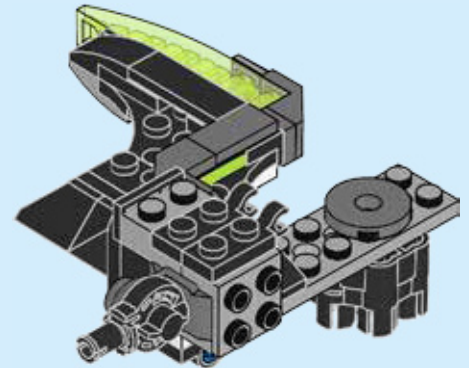



1x

72

1



2

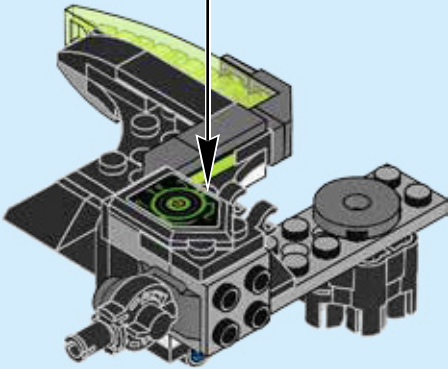

1x



2x

73

1



2

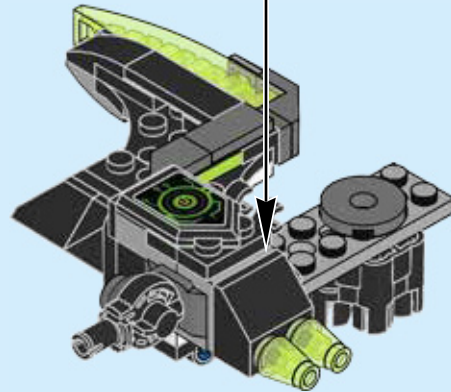

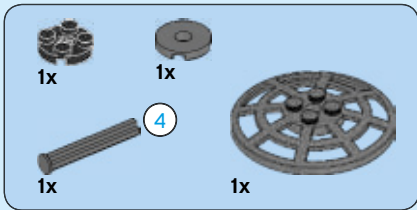

74

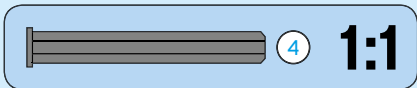
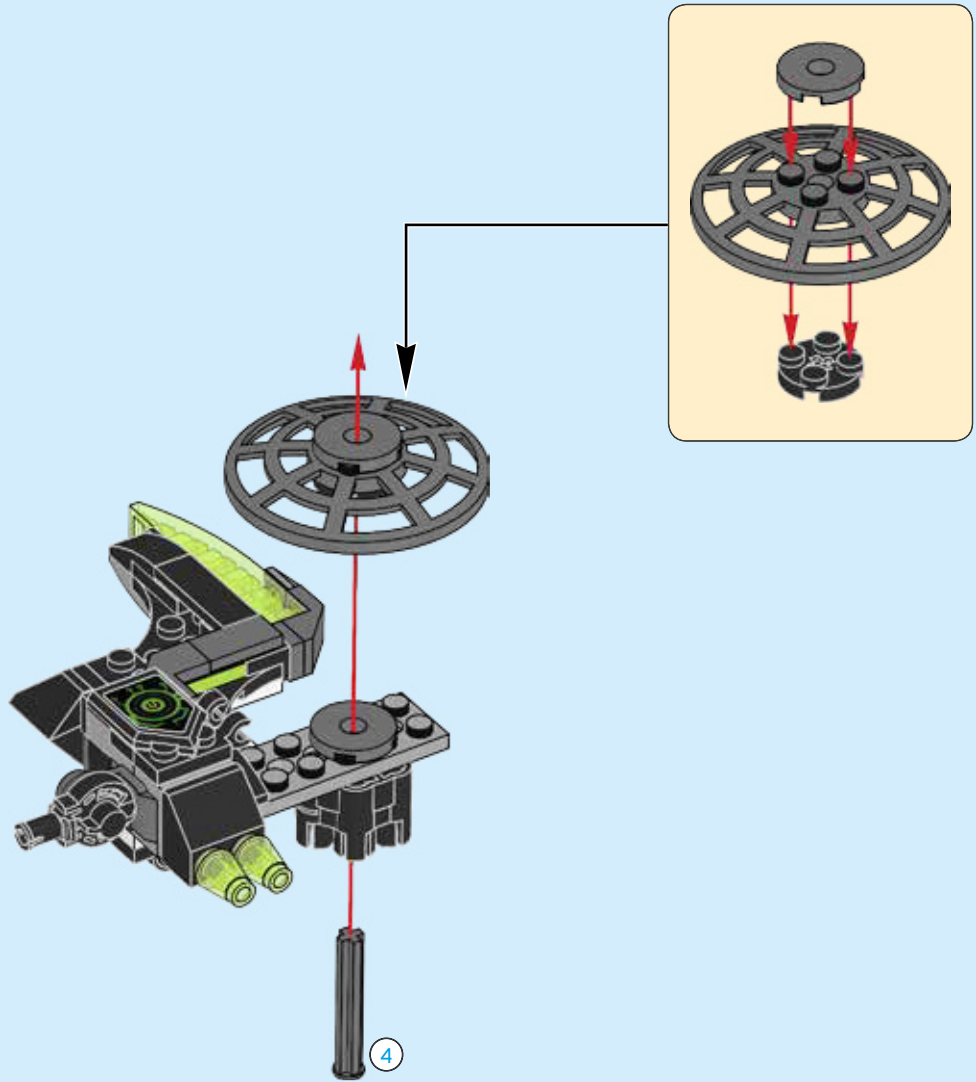

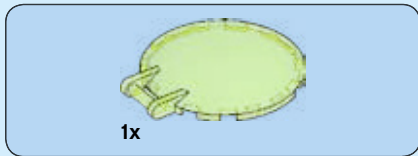

75

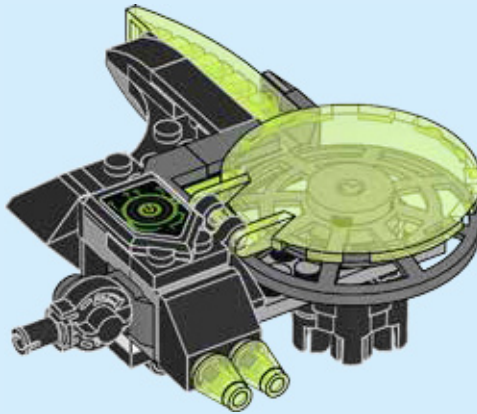

76

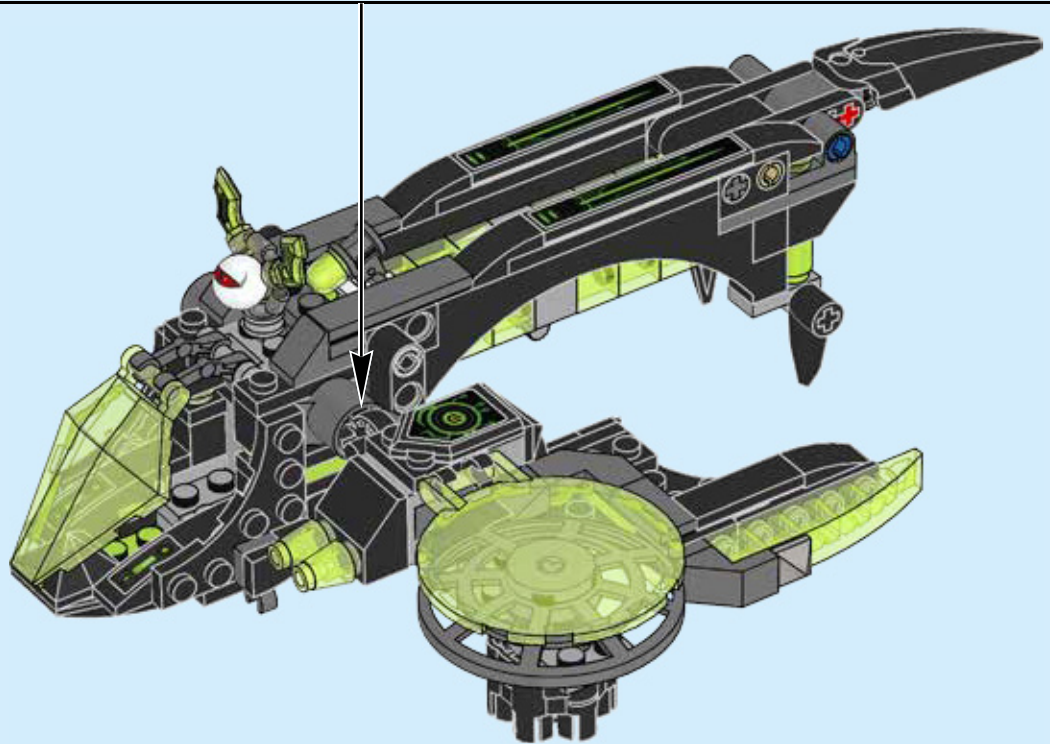

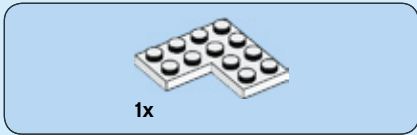

77

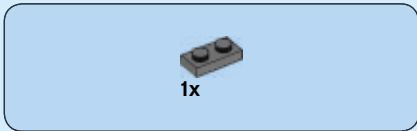
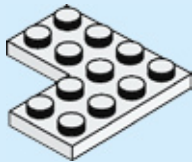

78

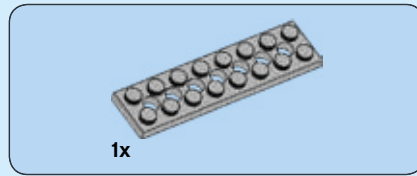
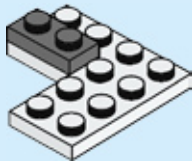

79

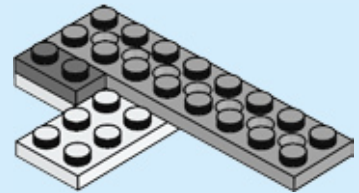

80

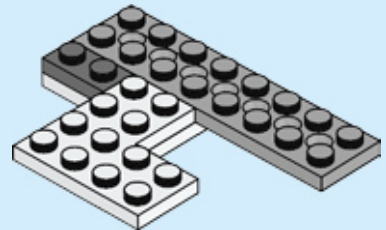

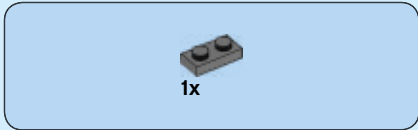

81

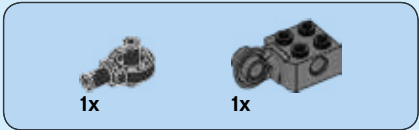
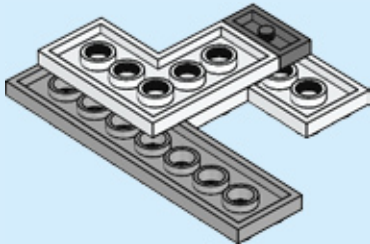
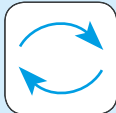

82

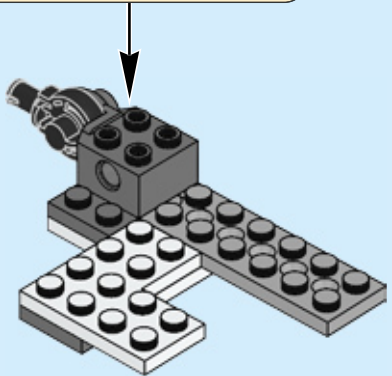
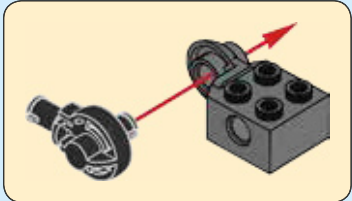
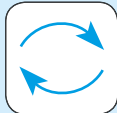

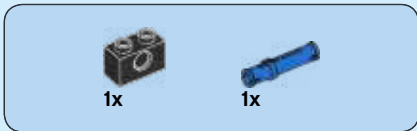

83

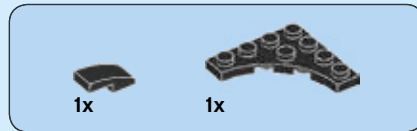
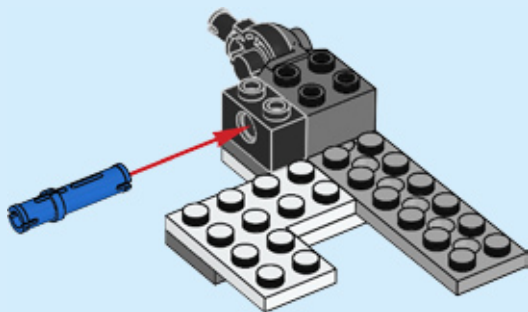

84

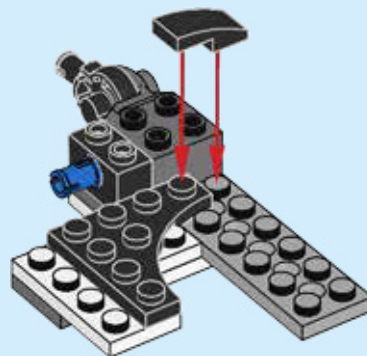

85

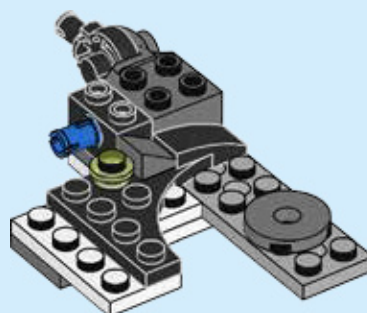

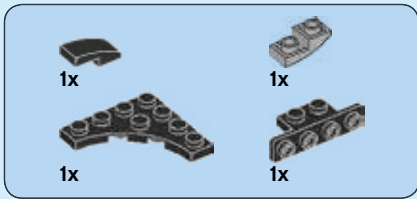

86

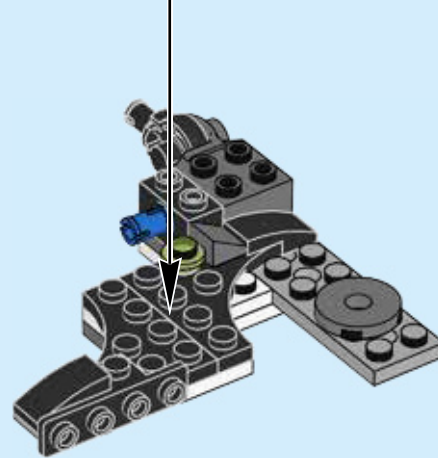
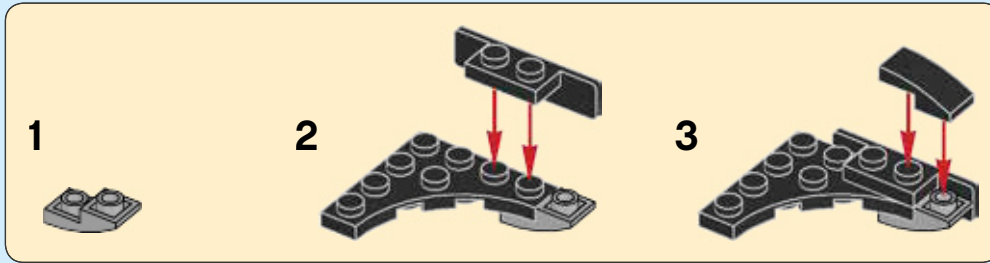



1x



2x

87

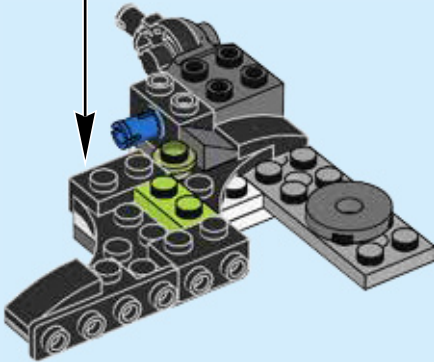
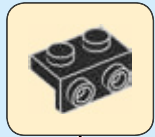

1x



1x



1x

88

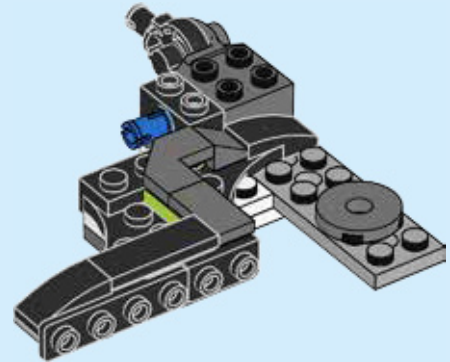

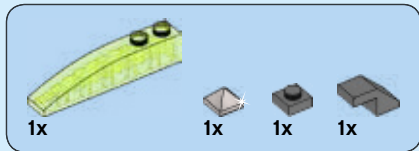

89

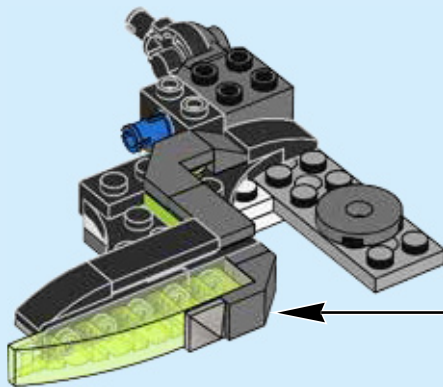
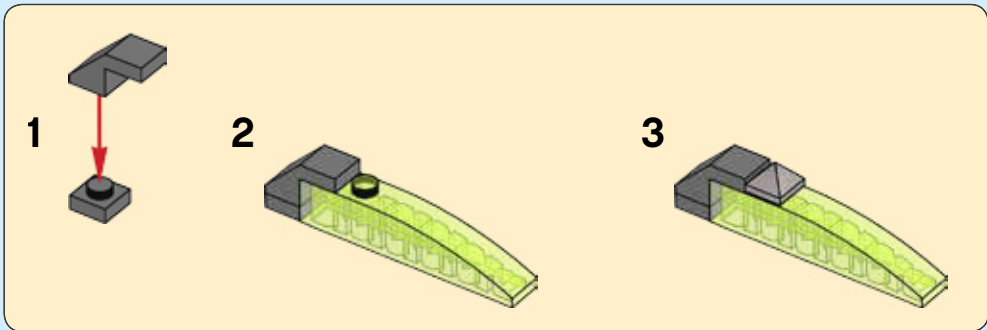



90

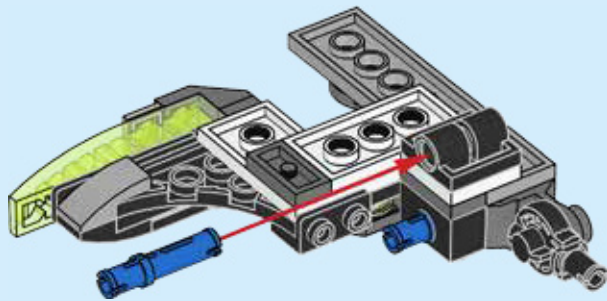
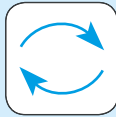

91

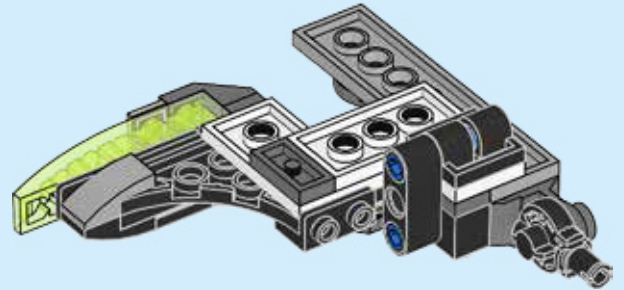

92

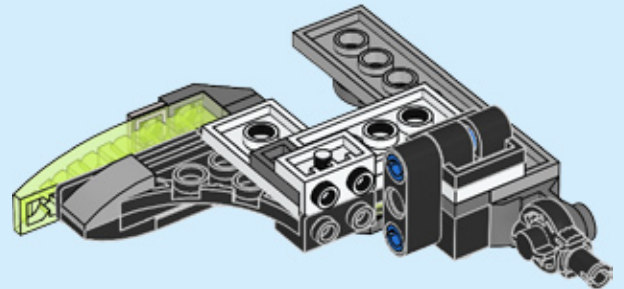



93

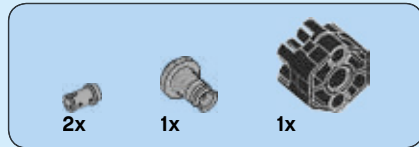
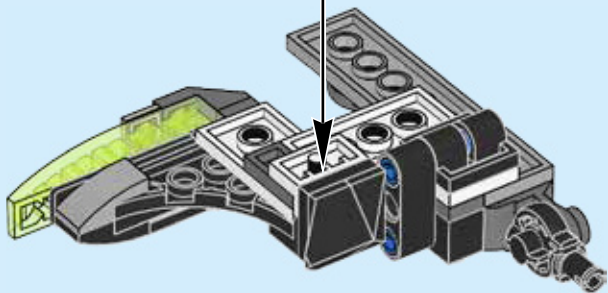
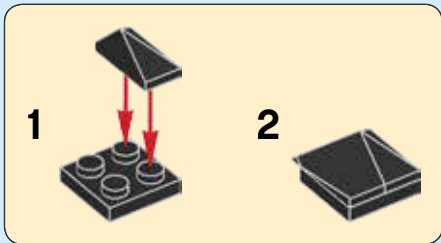

94

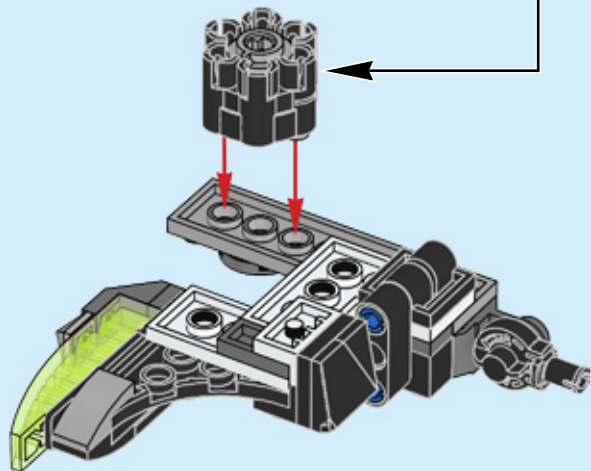
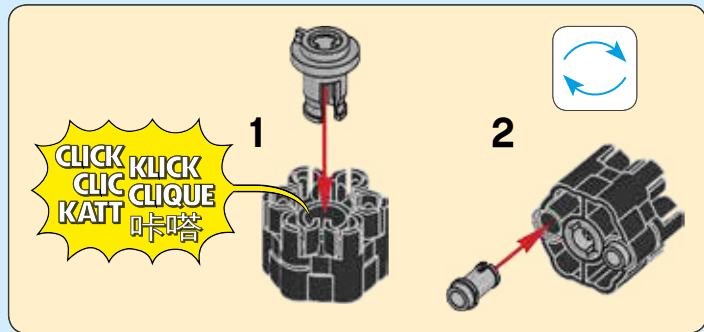

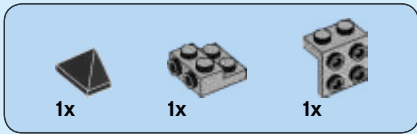

95

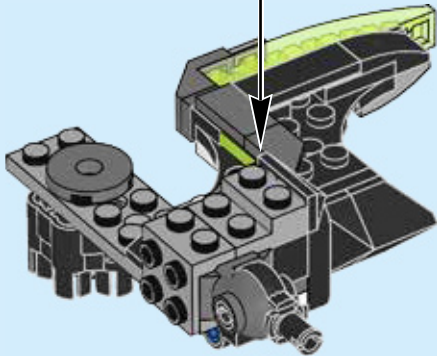
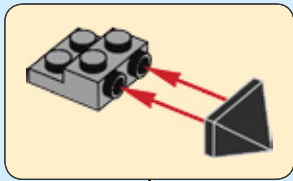
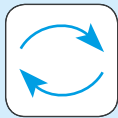

96

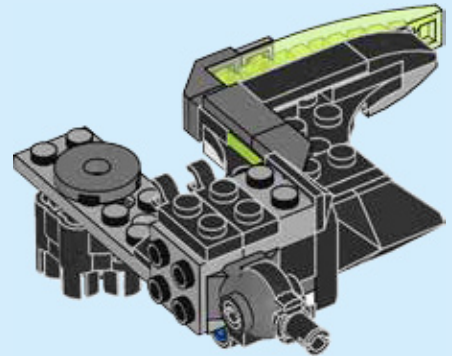



1x

97

1



2

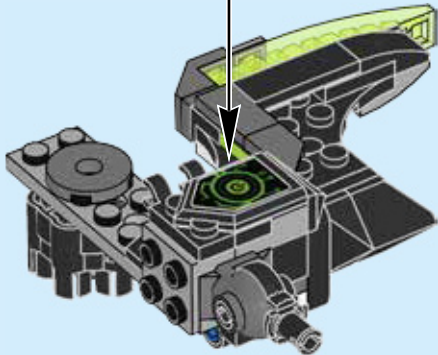
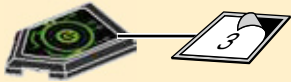

1x



2x

98

1



2

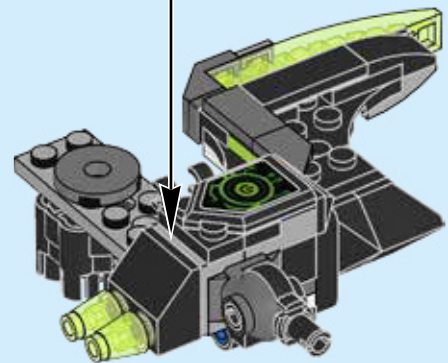

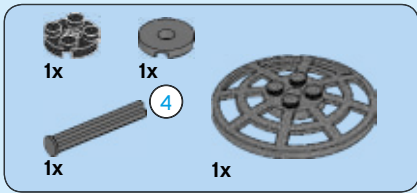

99

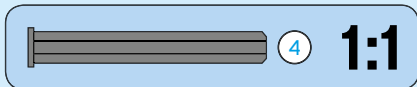
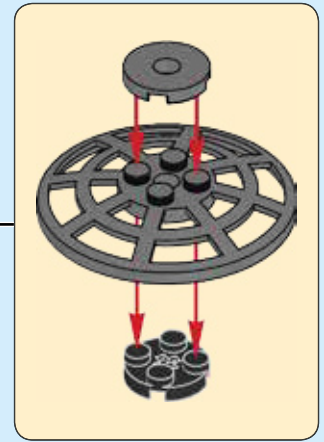
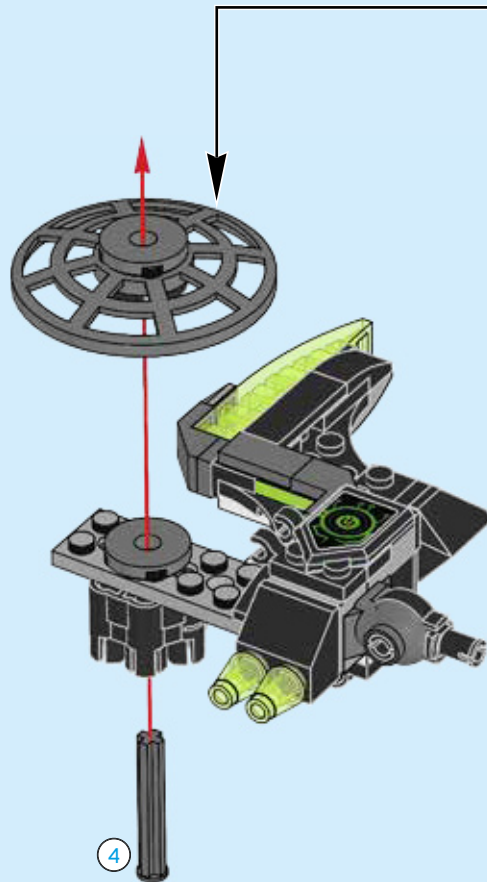

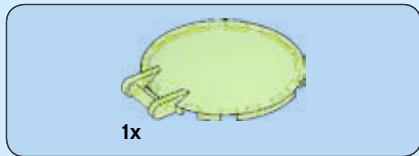

100

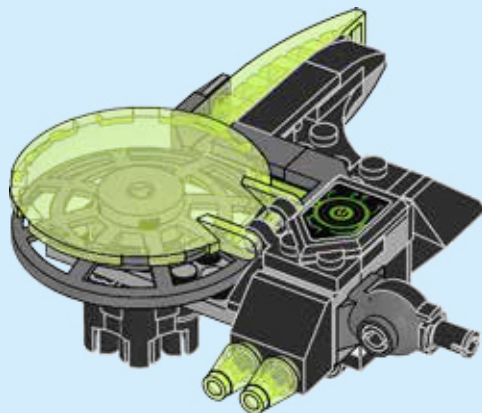

101

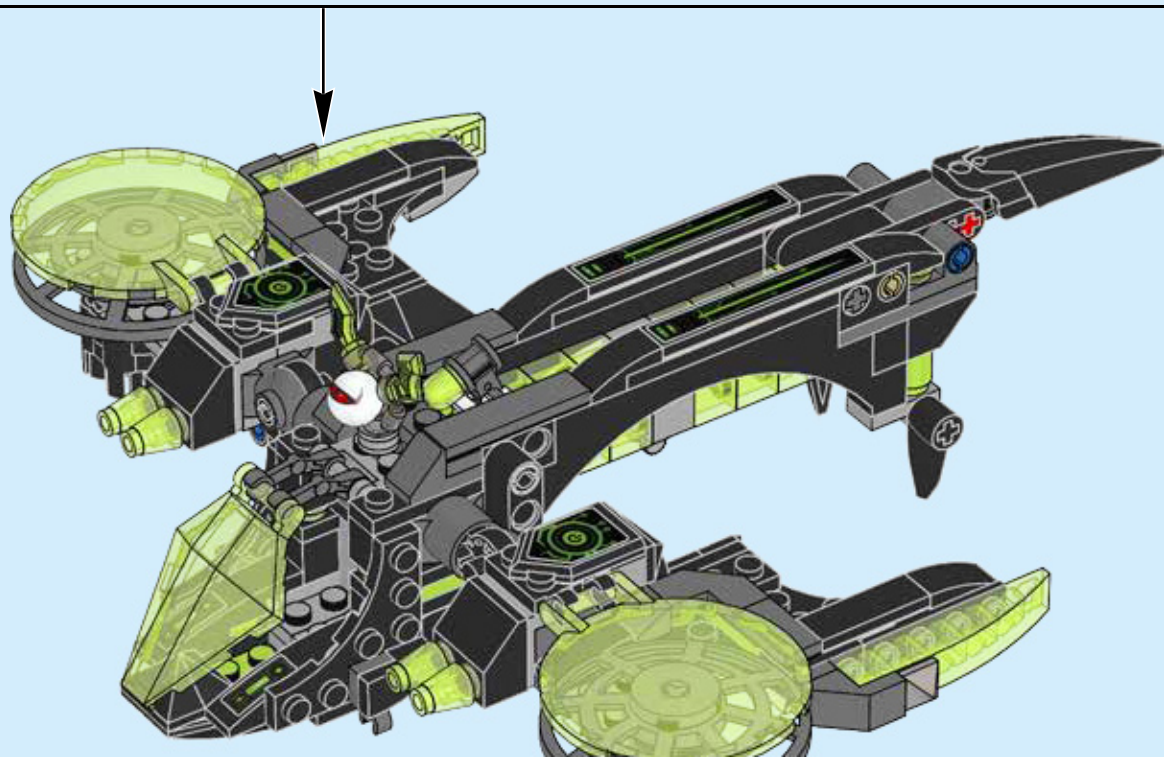

18x

102

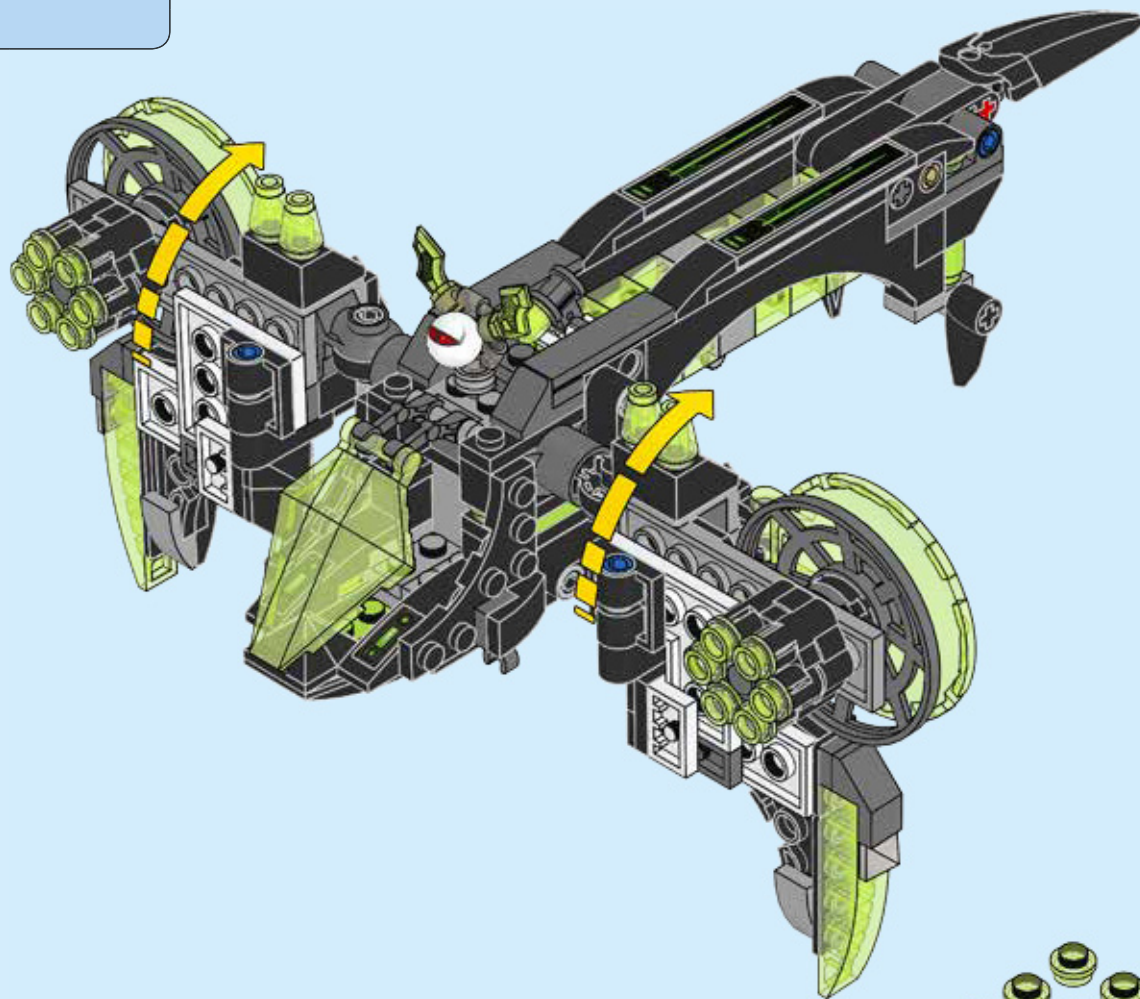

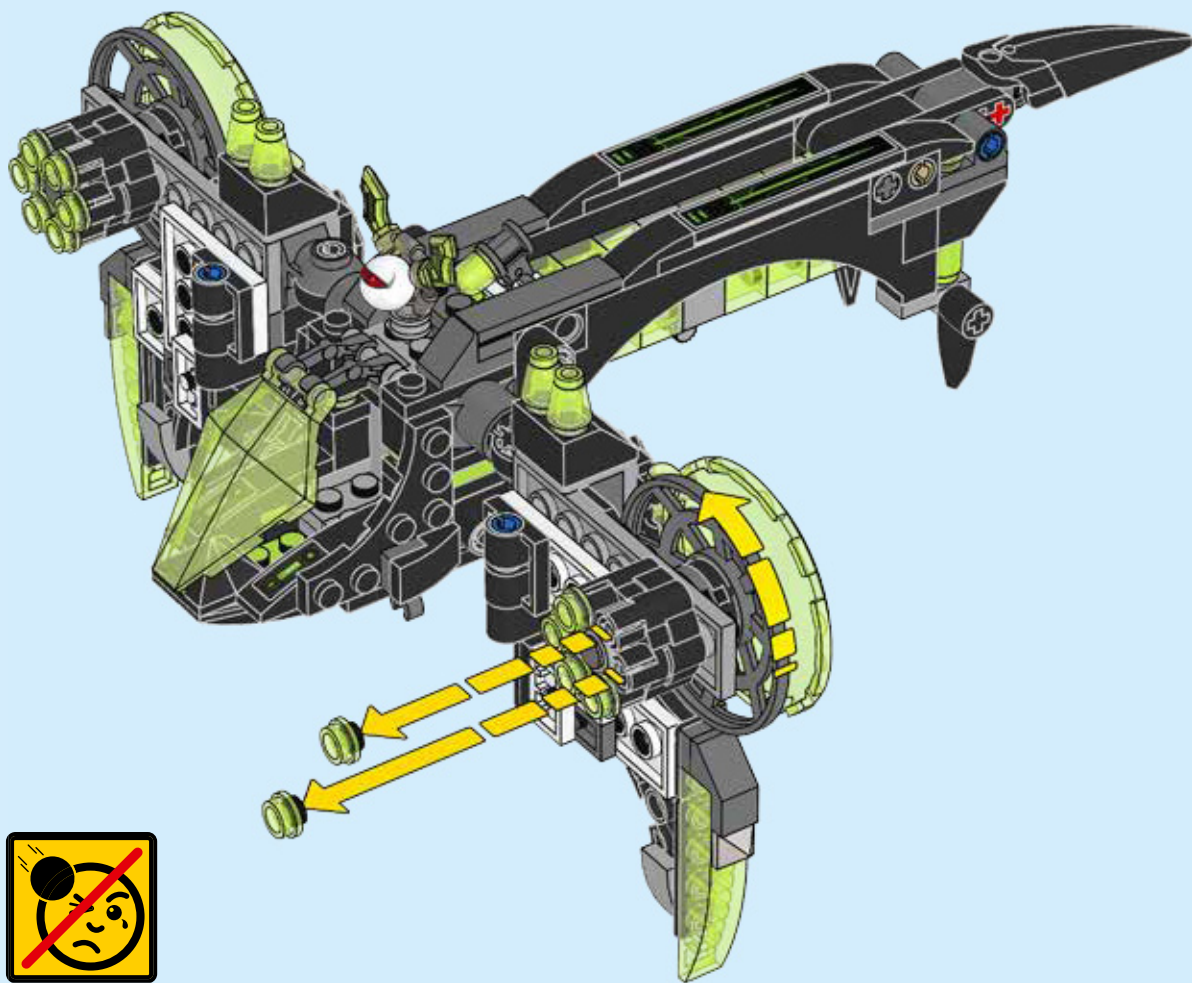

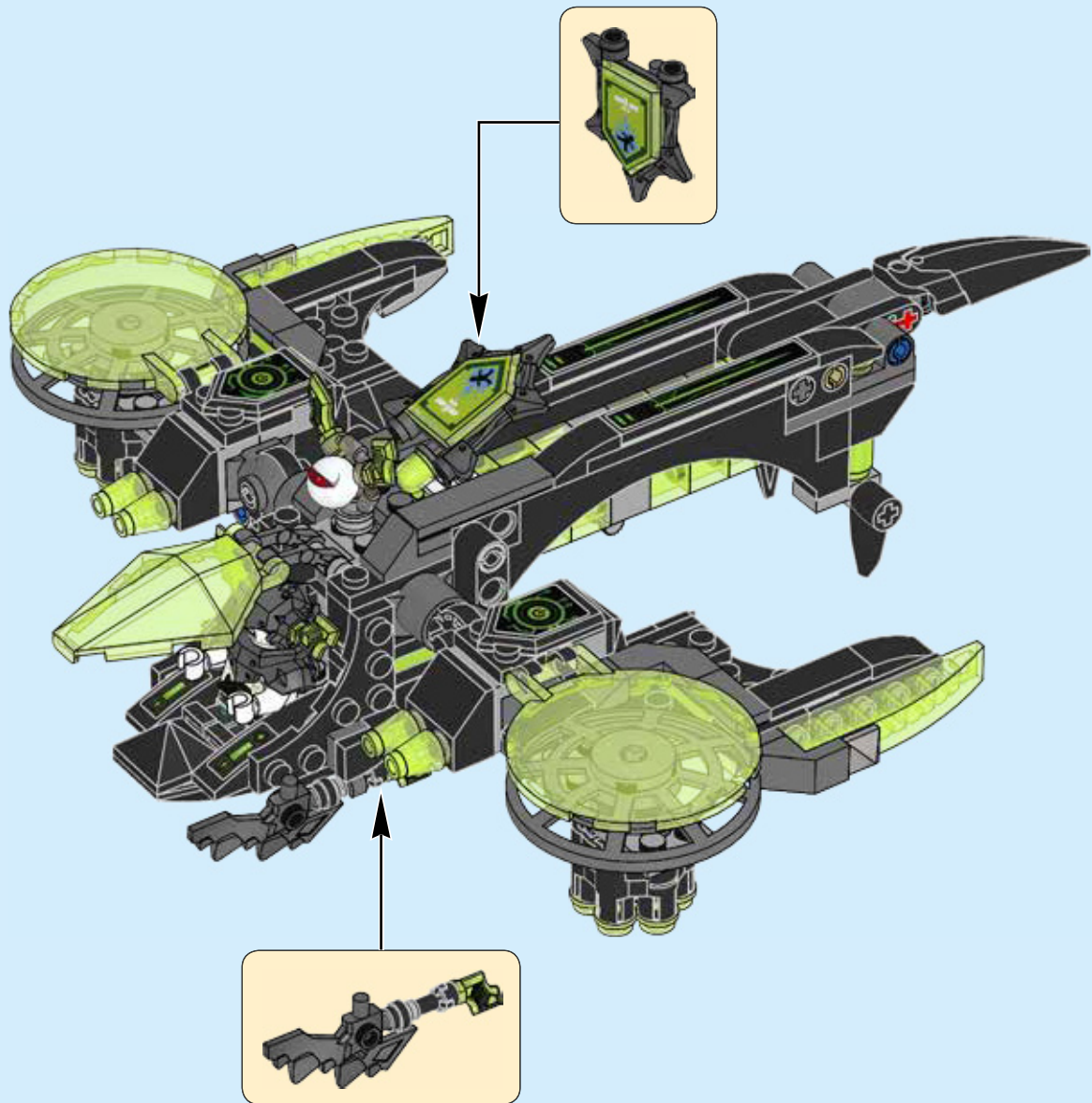

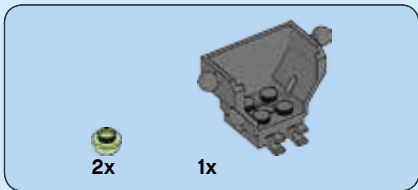

1

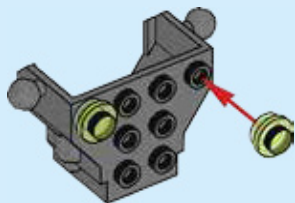

2

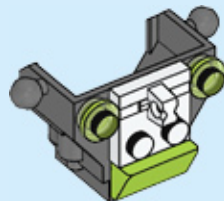

3

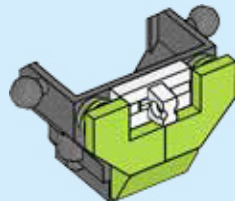

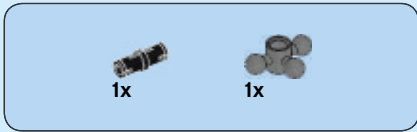

4

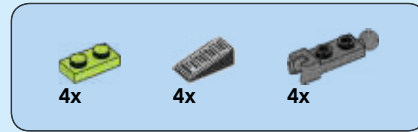
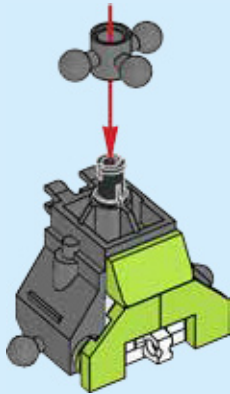
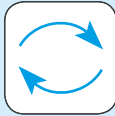

5

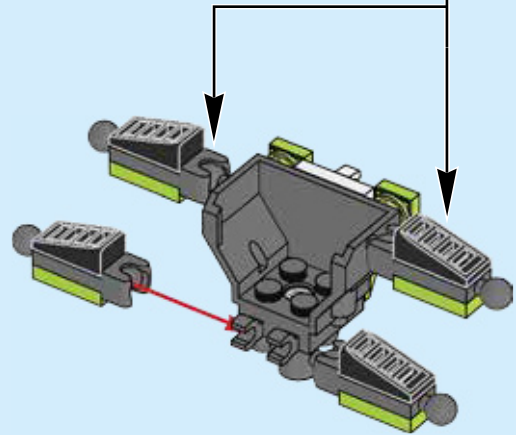
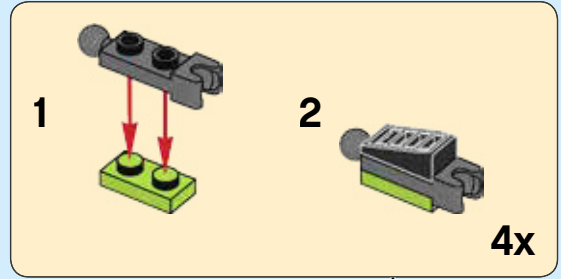
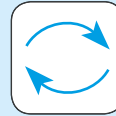



6

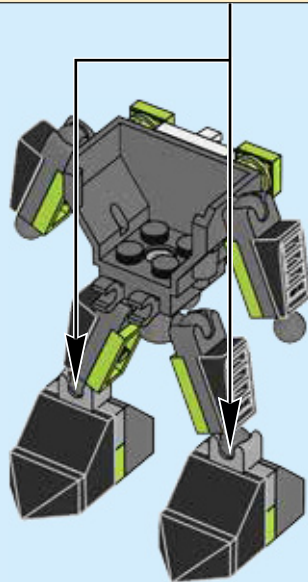



7

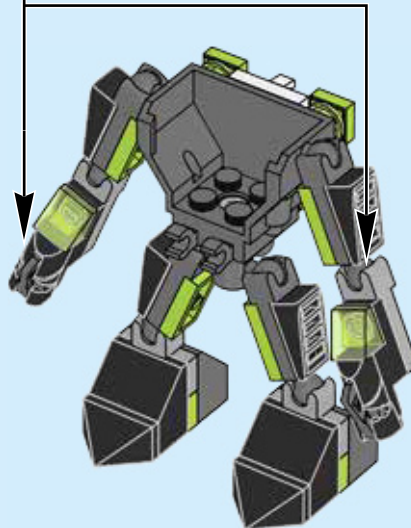
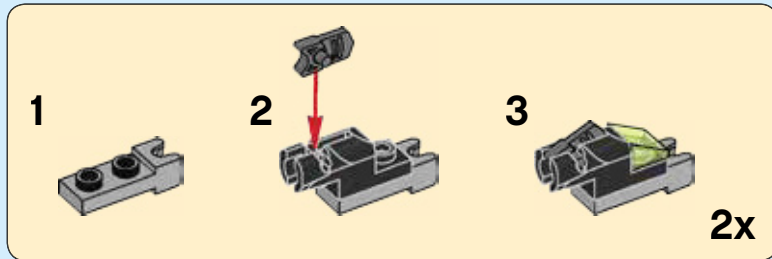

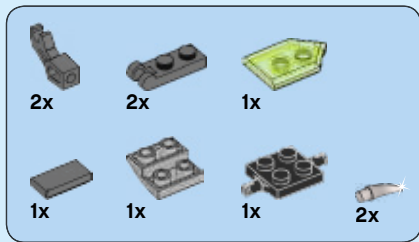

8

1

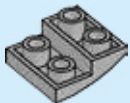

2

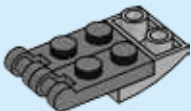

3

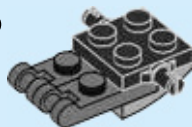

4

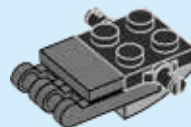

5



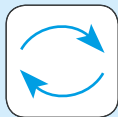

6

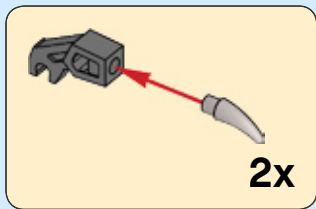
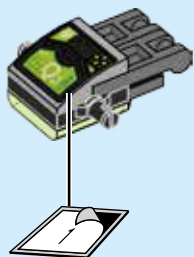

7

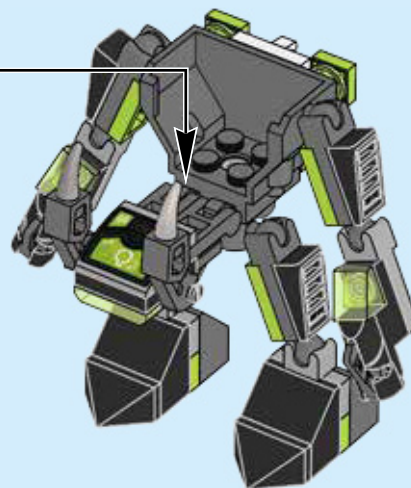
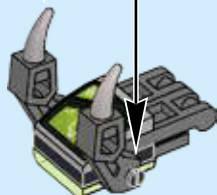



3x



3x

9

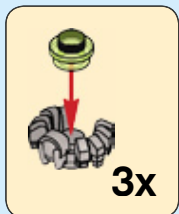

3x

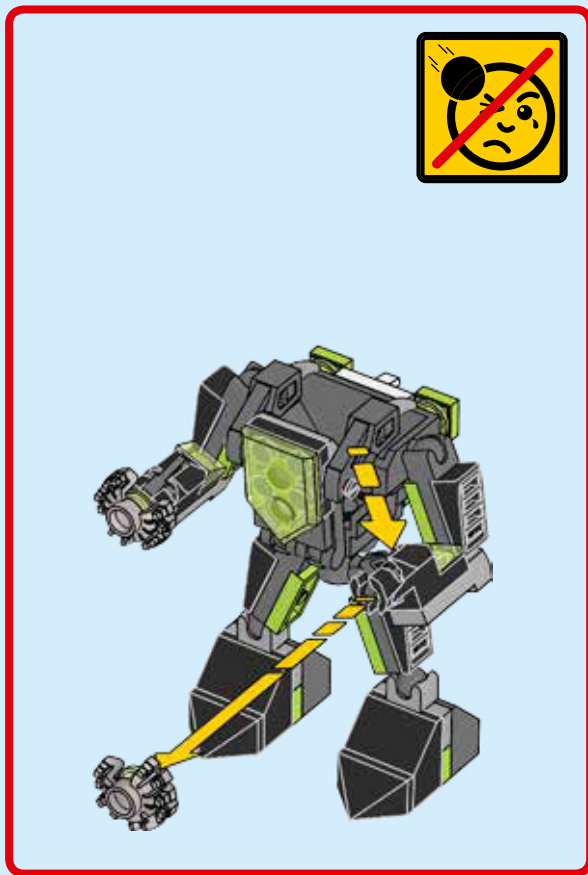
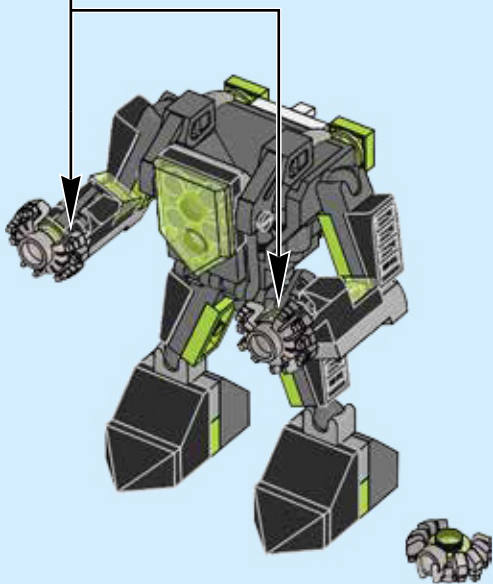

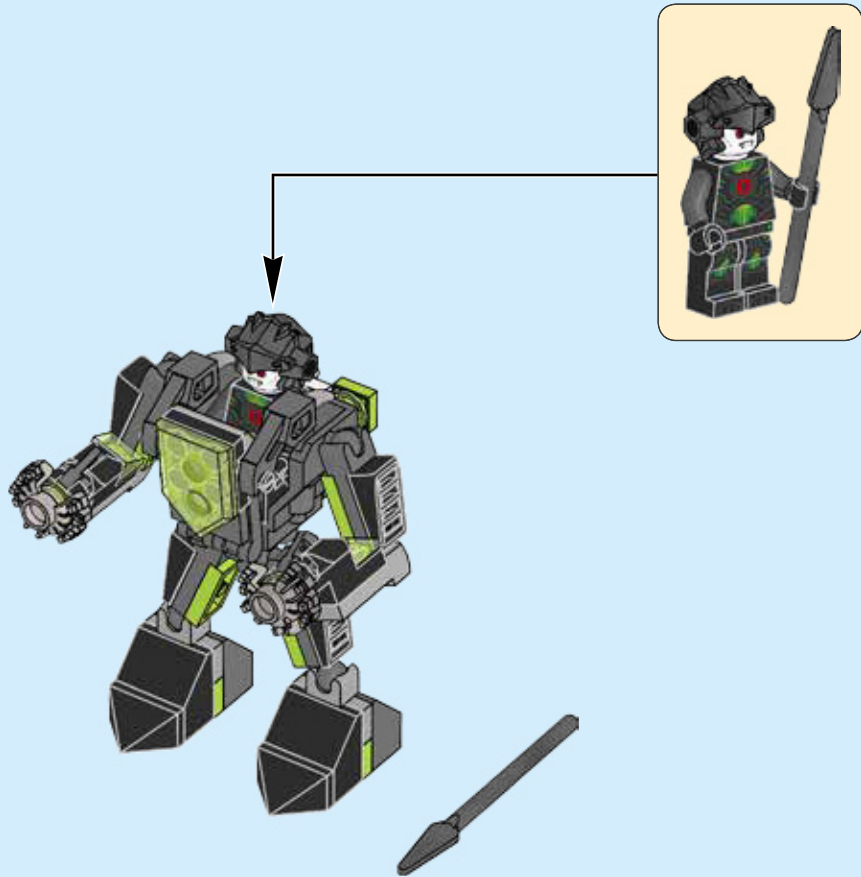

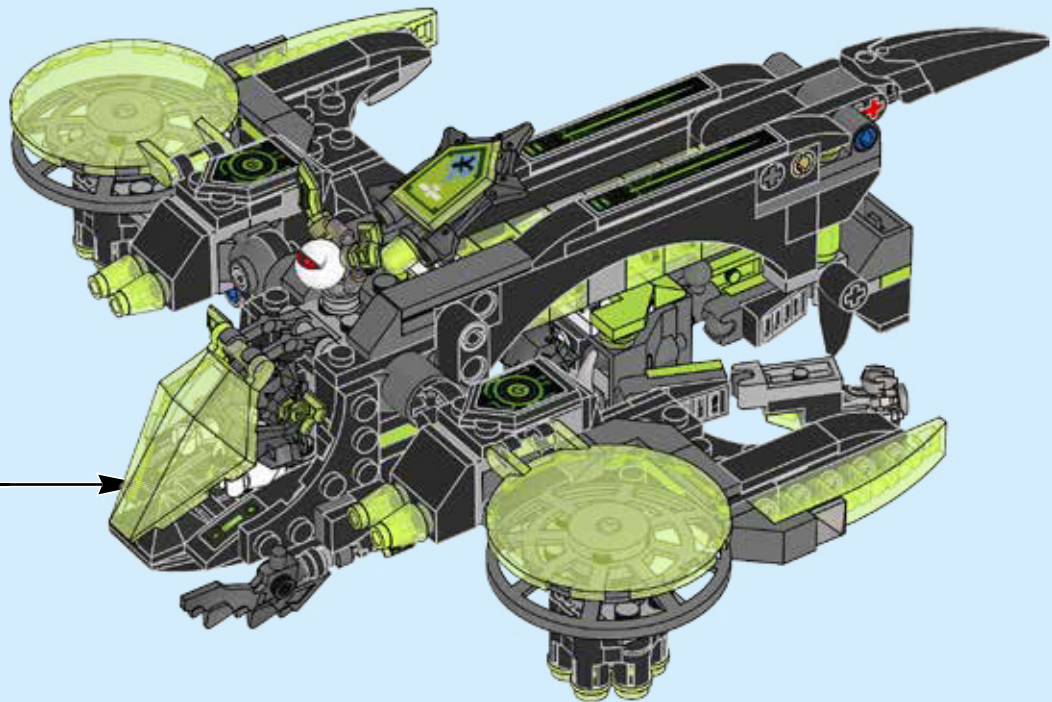
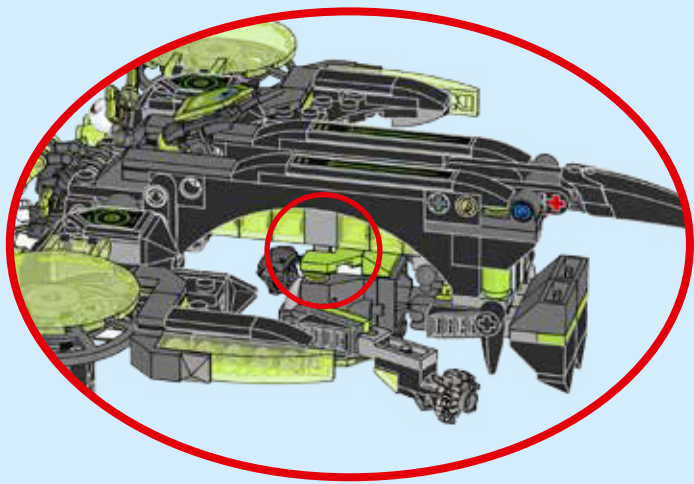



 1x 6211812	 4x 4541191	 2x 366526	 6x 362326	 1x 4188534	 1x 4298617	 1x 4621548	 2x 6168633
 1x 6210573	 10x 6047276	 2x 370026	 2x 4558170	 3x 4142823	 2x 4142865	 2x 4212454	 2x 6117967
 1x 6211802	 6x 3200026	 4x 6016172	 1x 6211963	 1x 370626	 1x 6211419	 1x 6025026	 1x 4244627
 2x 6070698	 1x 4598897	 2x 4540065	 1x 460026	 2x 366626	 1x 6105976	 13x 4164037	 1x 6185676
 1x 4556152	 4x 4558954	 4x 4535739	 2x 6100104	 2x 663626	 1x 6109312	 2x 4537937	 1x 4237084
 1x 4613762	 8x 6051508	 2x 4213374	 2x 6089577	 6x 6208787	 3x 6166891	 2x 6166895	 2x 6043639
 1x 246001	 2x 403226	 2x 281726	 1x 370126	 1x 6056377	 2x 6124858	 1x 4211573	 4x 4654577
 1x 6211938	 2x 403226	 4x 303926	 2x 6037746	 1x 4180469	 4x 3005747	 4x 4211483	 1x 6093870
 2x 4144138	 9x 4121715	 2x 4142822	 2x 6037746	 4x 3006347	 4x 3006347	 2x 4211508	 1x 6093058
 1x 370101	 2x 6211946	 2x 6102734	 2x 6030286	 1x 6161317	 1x 6161317	 2x 6097090	 1x 6012653
 4x 4508662	 2x 4220539	 2x 6128992	 2x 302026	 2x 6189061	 1x 6120914	 2x 6144138	 2x 4211449

6





Customer Service
Kundenservice
Service Consommateurs
Servicio Al Consumidor

LEGO.com/service or dial

00800 5346 5555 : 

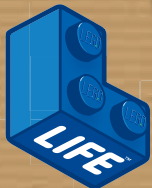
1-800-422-5346 : 



The LEGO logo is positioned in the top left corner, featuring the word "LEGO" in white, bold, sans-serif font on a red rectangular background.

NEXO KNIGHTS

The Nexo Knights logo shield is located to the right of the main title. It is a yellow shield with a black border, containing a black silhouette of a knight's helmet and a sword.

POWER UP YOUR BRICK PLAY

HOL DIR NOCH MEHR KRAEFTE FÜR'S SPIELEN MIT DEINEN SETS
AUGMENTE LA PUISSANCE DE TON JEU
POTENZIA IL TUO GIOCO CON I MATTONCINI
MÁS DIVERSIÓN CON TUS LADRILLOS
TORNA O TEU JOGO DE PEÇAS MAIS PODEROSO
ERŐSÍTSD MEG A KOCKÁ JÁTEKODATI!
为您的积木拼搭“能量升级”

BATTLE WITH MERLOK POWERS

ERLEBE SPANNENDE ACTION MIT MERLOK KRÄFTEN
BATS-TOI AVEC LES POUVOIRS DE MERLOK
COMBATTI CON I POTERI DI MERLOK
LUCHA CON LOS PODERES DE MERLOK
COMBATE COM PODERES MERLOK
HARCOLJ MERLOK ERÖKKELI
借助梅洛克能量进行战斗



HOL DIR NOCH MEHR KRÄFTE FÜR'S DIGITALE SPIEL
AMELIORÉ TON EXPERIENCE DE JEU
POTENZIA IL TUO GAME PLAY
MEJORAS EN EL JUEGO DIGITAL
FAZ UM UPGRADE DO TEU JOGO
FEJLESZD A JÁTEKOD!
升级您的游戏体验

UPGRADE YOUR GAME PLAY



LEGO® NEXO KNIGHTS™: MERLOK 2.0



LEGO.COM/DEVICECHECK

WIN

GO TO WWW.LEGO.COM/PRODUCTFEEDBACK AND
GIVE US YOUR SHORT **FEEDBACK** ABOUT THIS
LEGO® SET FOR A CHANCE TO WIN
A COOL LEGO PRIZE.

Terms & Conditions apply

LEGO.com/productfeedback



GEWINNE

Erzähle uns auf
www.LEGO.com/productfeedback

etwas über die Erfahrungen, die du mit
diesem LEGO® Set gemacht hast, und
sichere dir die Chance auf einen coolen
LEGO Preis!

Es gelten die Teilnahmebedingungen

GAGNE

Rends-toi sur
www.LEGO.com/productfeedback

et donne-nous quelques commentaires
sur ce produit LEGO® pour avoir une
chance de gagner un prix LEGO !

Voir Conditions Générales

GANAN

Visita
www.LEGO.com/productfeedback

y envíanos tu opinión acerca de este set
LEGO®. ¡Participarás en el sorteo de un
premio LEGO!

Términos y Condiciones aplicables

获取奖品

登录
www.LEGO.com/productfeedback

给出关于此乐高®套装的简短反馈，
就有机会获得炫酷乐高奖品

《条款及条件》适用

LEGO, the LEGO logo and NEXO KNIGHTS are trademarks of the LEGO Group. ©2018 The LEGO Group.

6225101