



BRICK SKETCHES™

40391



Disney

STAR WARS

First Order Stormtrooper™

Some time ago I was a part of an artists' group on a popular social media platform. Many of the artists were doing marker sketches on small cardstock as a way to engage with their fans. I thought this was a fantastic idea, but I wanted to put my own spin on it using LEGO® bricks. This led to the creation of the very first Brick Sketch. I posted it to my social media channels with some apprehension, not entirely sure how my fans would react. Thankfully, they loved the concept and wanted to see more!

After some experimenting, I nailed down the basics: Brick Sketches would be plate-based artwork that featured a front-facing character on a 12x16 canvas. Given that Brick Sketches are somewhat three-dimensional, it was also important that they have correct relief wherever possible; for example, the character's chin shouldn't extend further out than the nose. The challenge was to use LEGO pieces creatively to build detailed character artwork on a relatively small canvas.

Brick Sketches became far more popular than I ever expected. Fans loved suggesting new characters and often asked me to create instructions so that they could build their favourites. It was difficult to set aside the concept when I started working at the LEGO Group, but through an amazing series of events, Brick Sketches are now available from the LEGO Group itself. It's a dream come true.



LEGO® designer Chris McVeigh

Booklet available in English on
Heft in deutscher Sprache erhältlich auf
Livret disponible en français sur
Libretto disponibile in italiano su
Folleto disponible en español en
如需中文版手册, 请访问

[LEGO.com/service/buildinginstructions](https://www.lego.com/service/buildinginstructions)



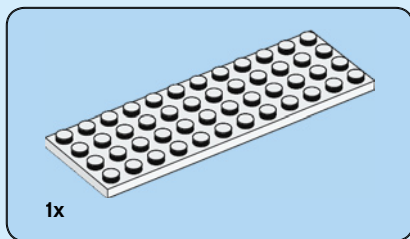

1

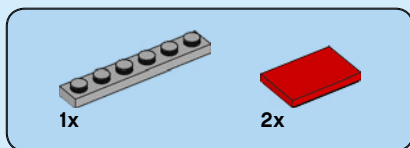
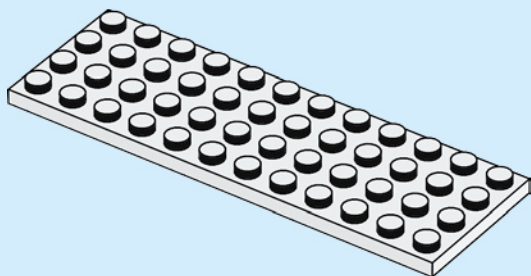

2

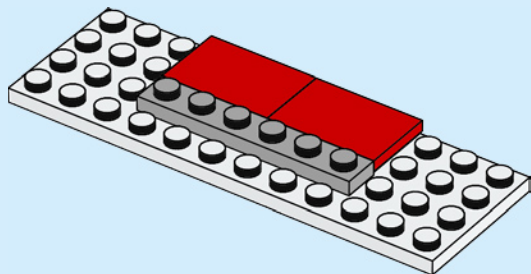



2x



2x

3

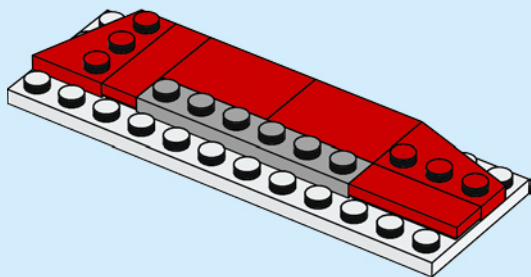

1x

4

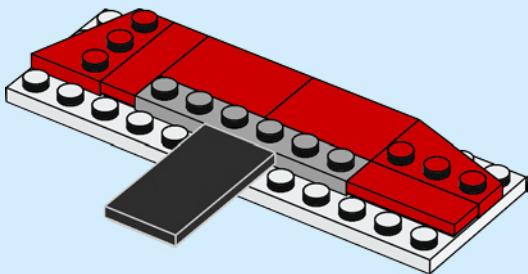

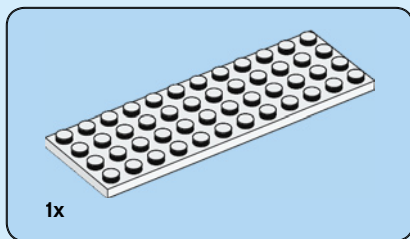

5

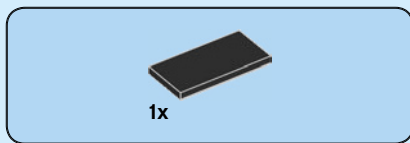
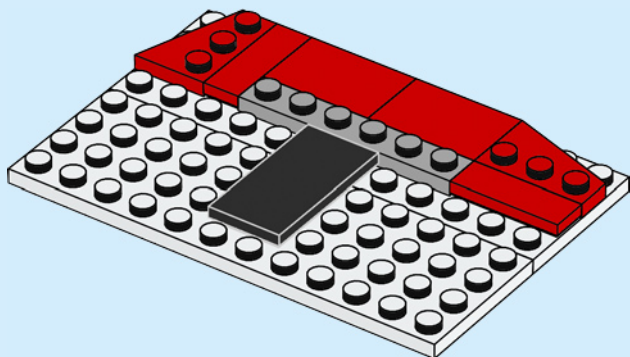

6

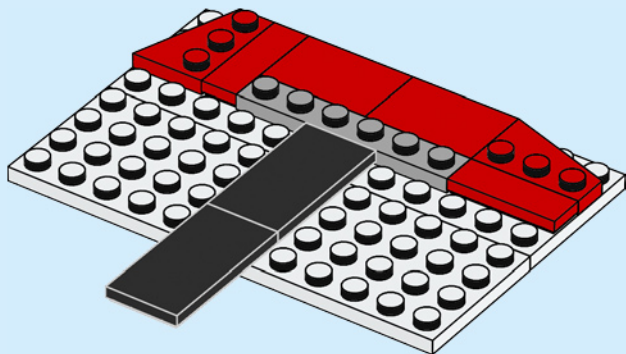

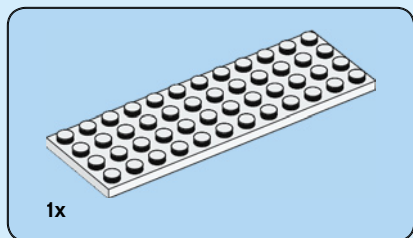

7

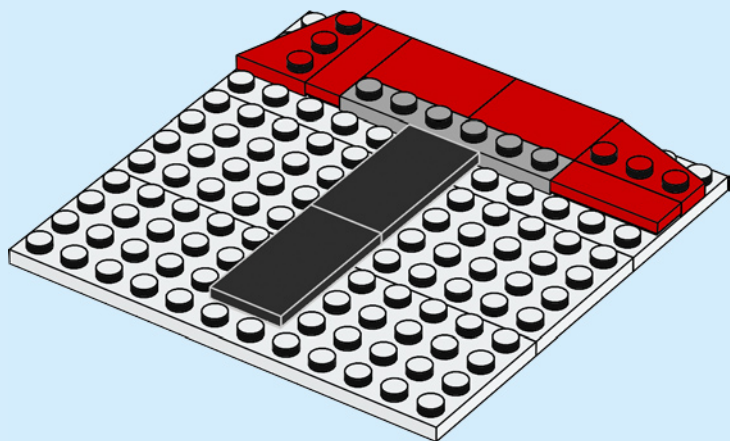

8

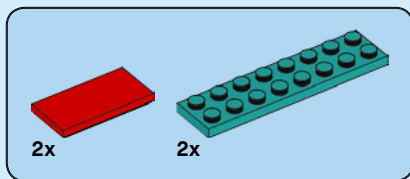

8

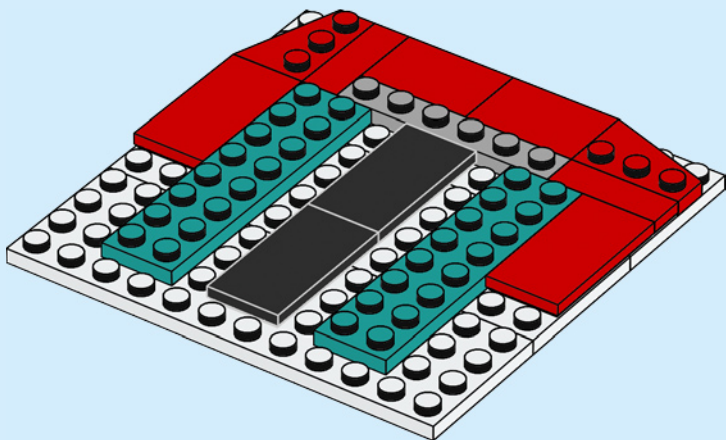



2x



2x



2x

9

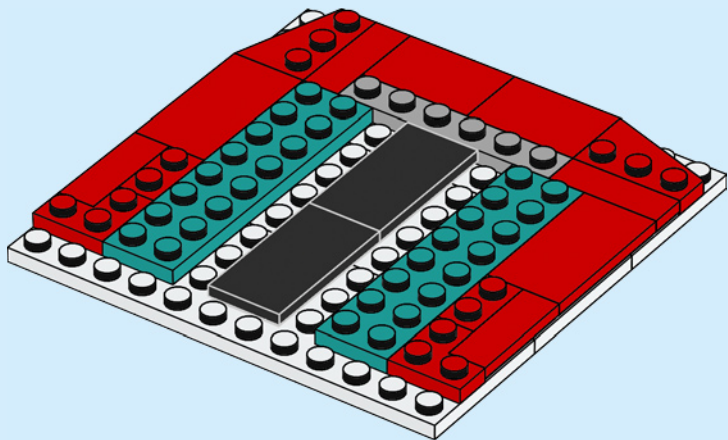

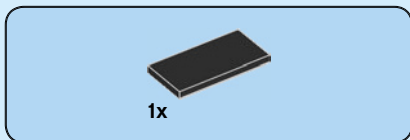

10

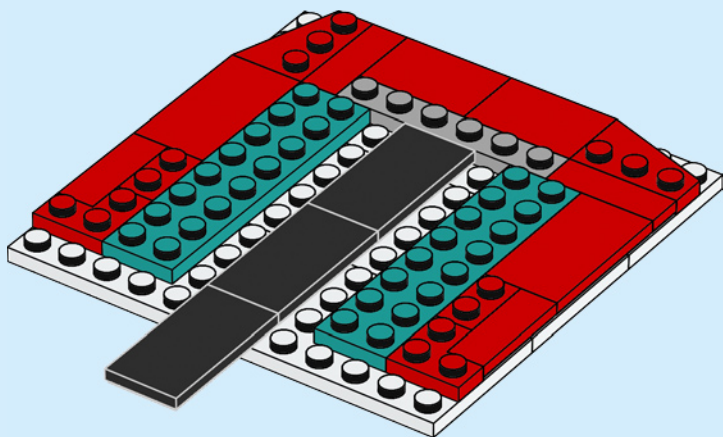

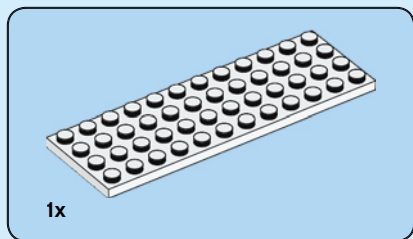

11

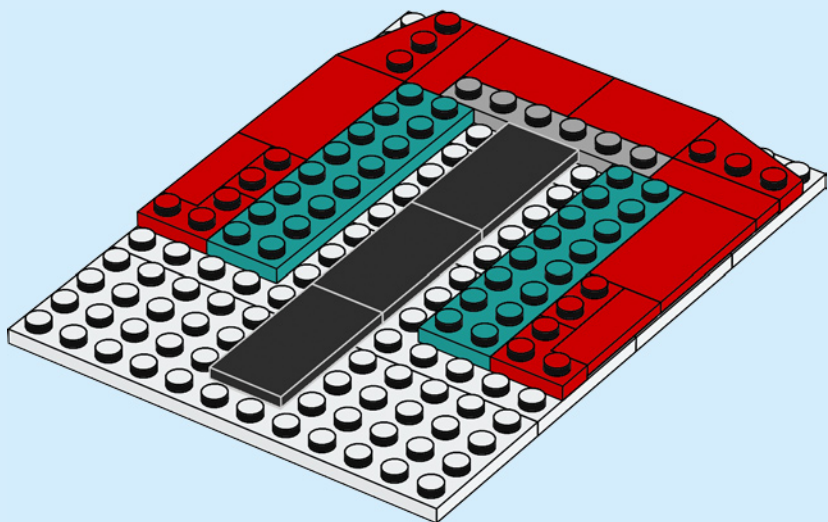

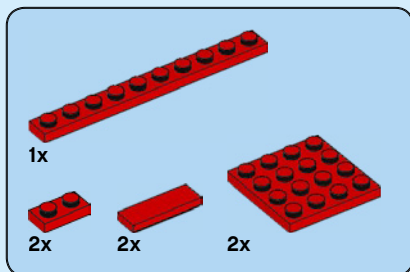

12

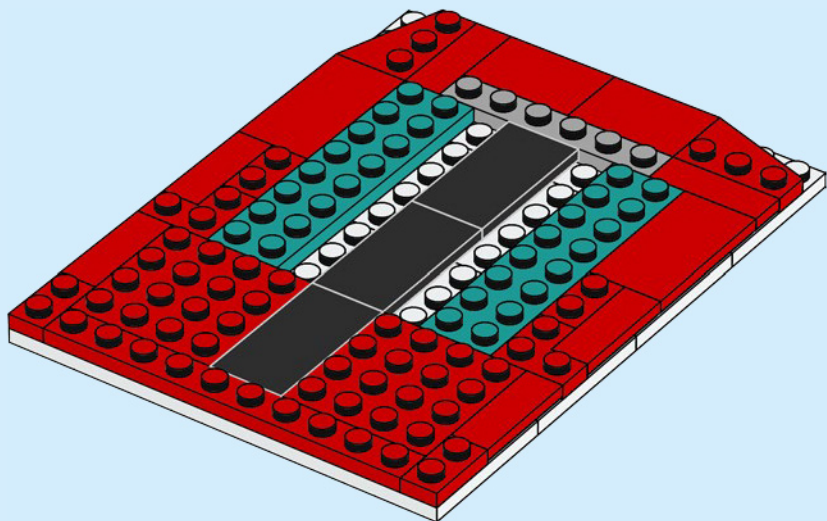

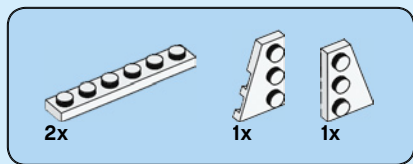

13

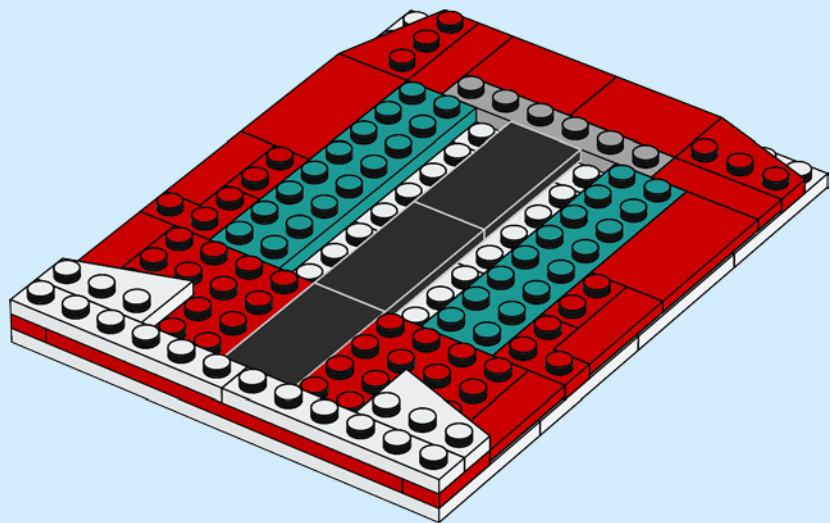

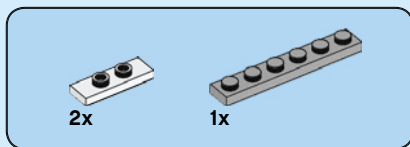

14

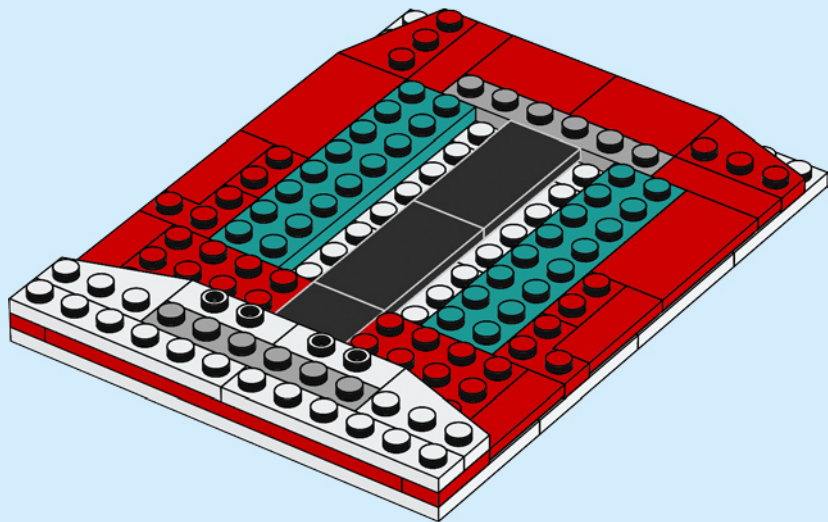

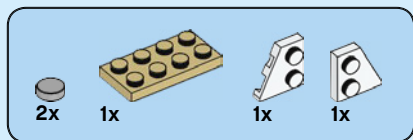

15

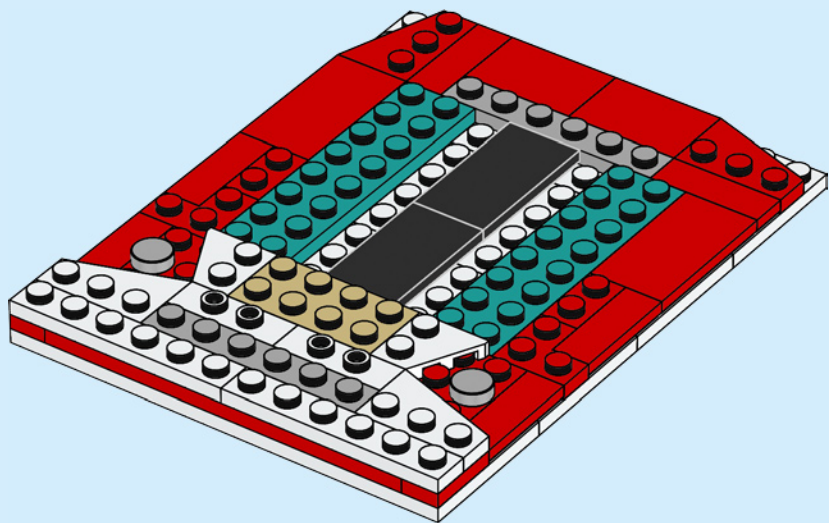

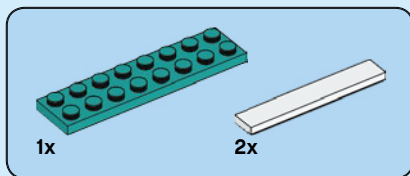

16

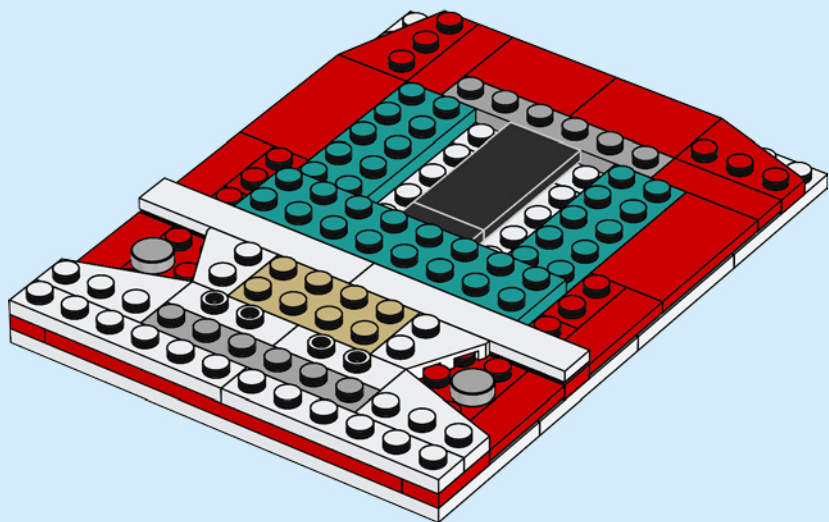

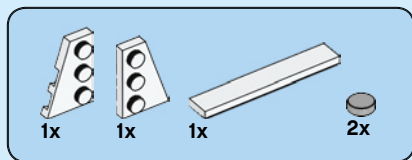

17

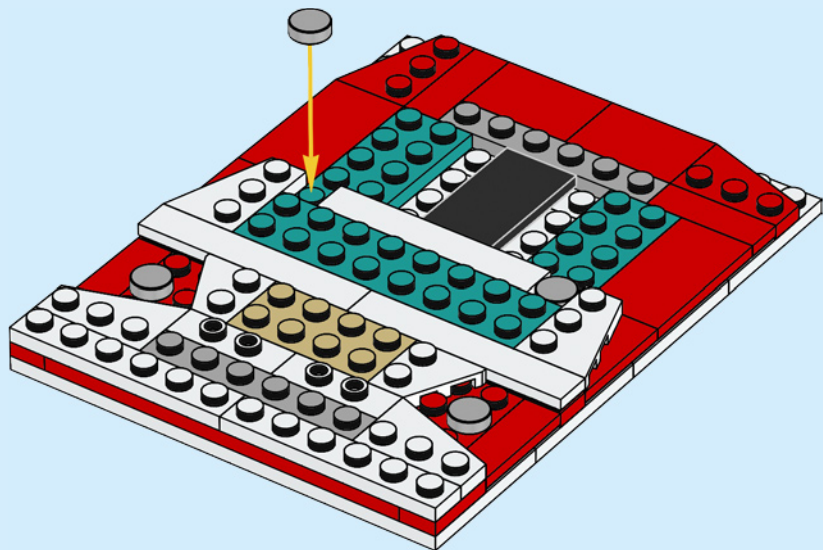

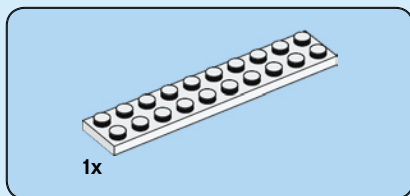

18

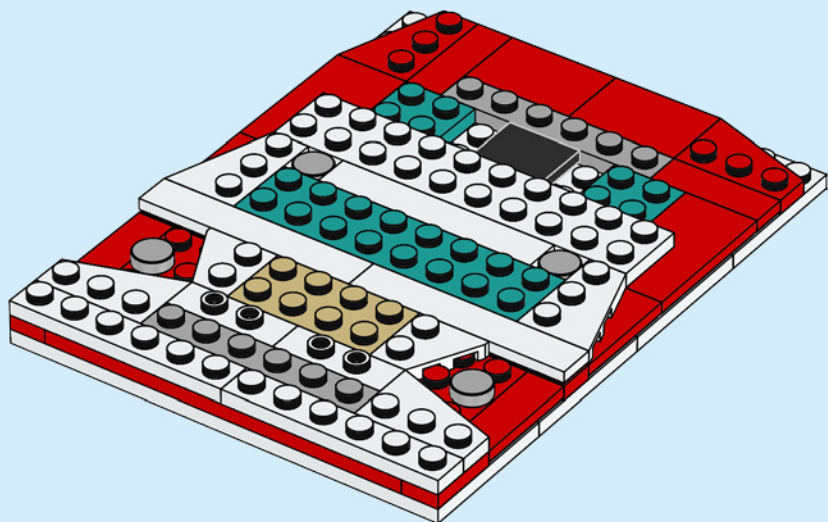

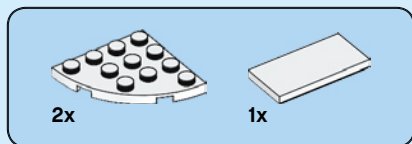

19

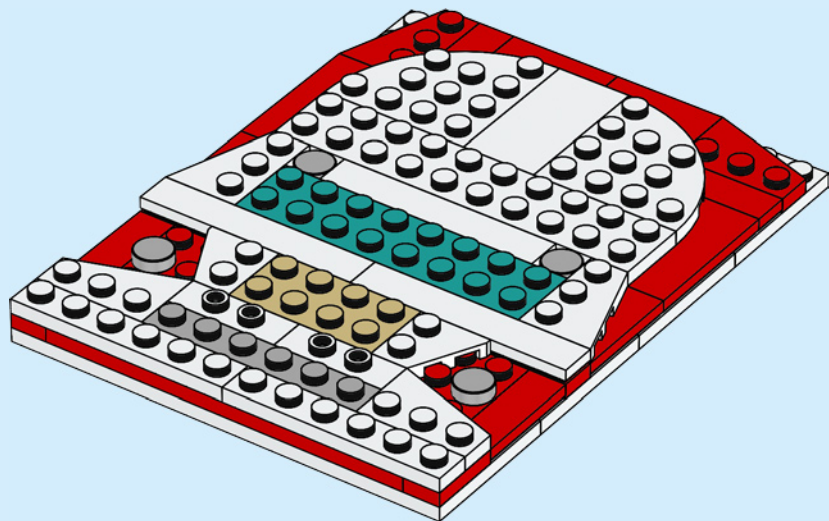

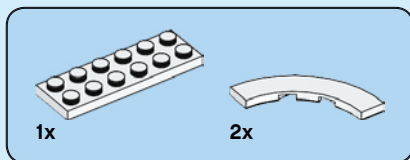

20

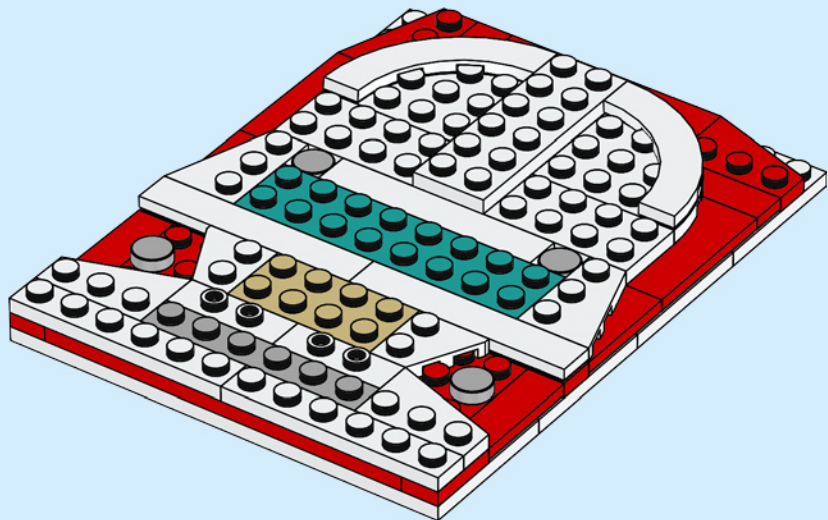

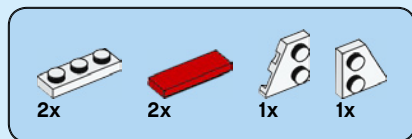

21

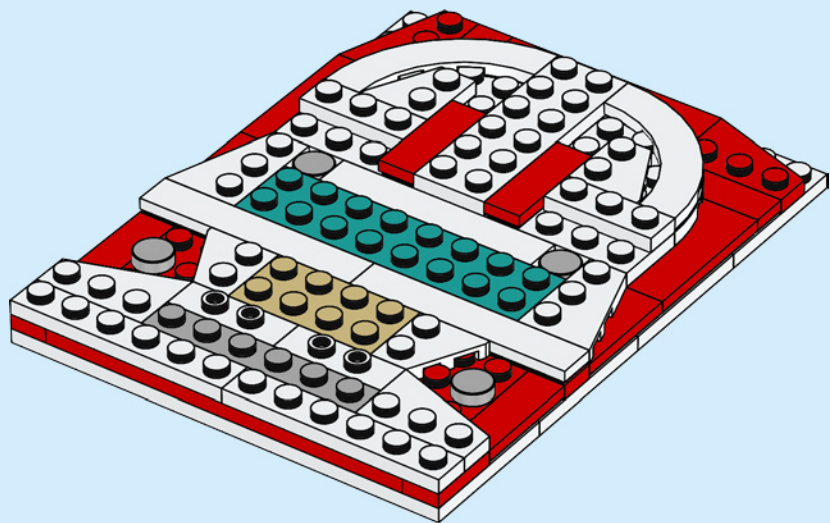

22

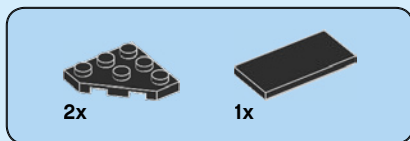

22

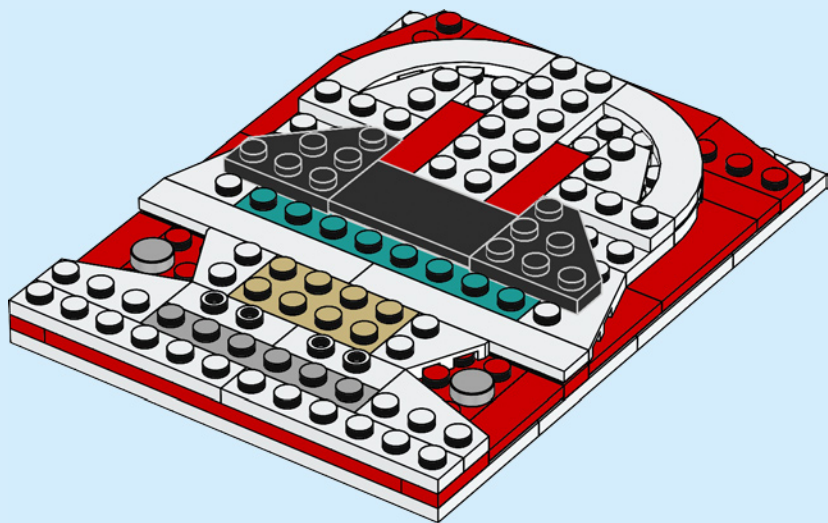

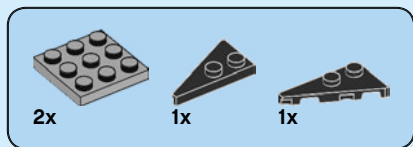

23

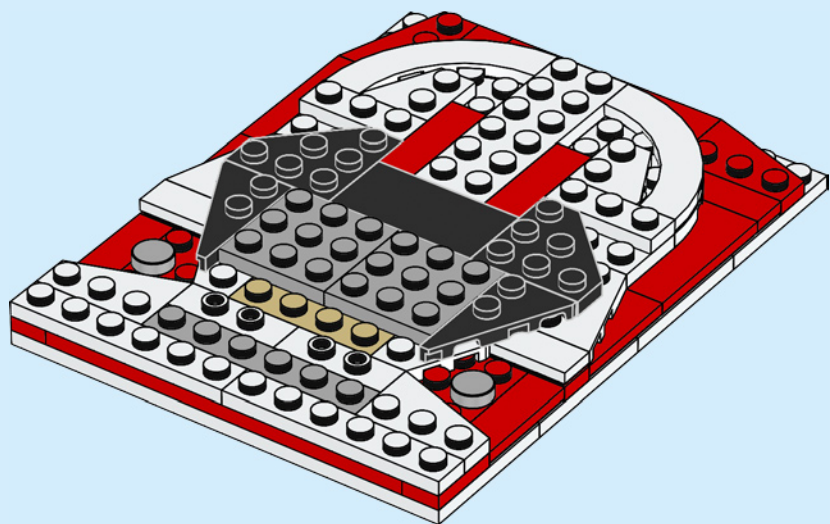



2x

24

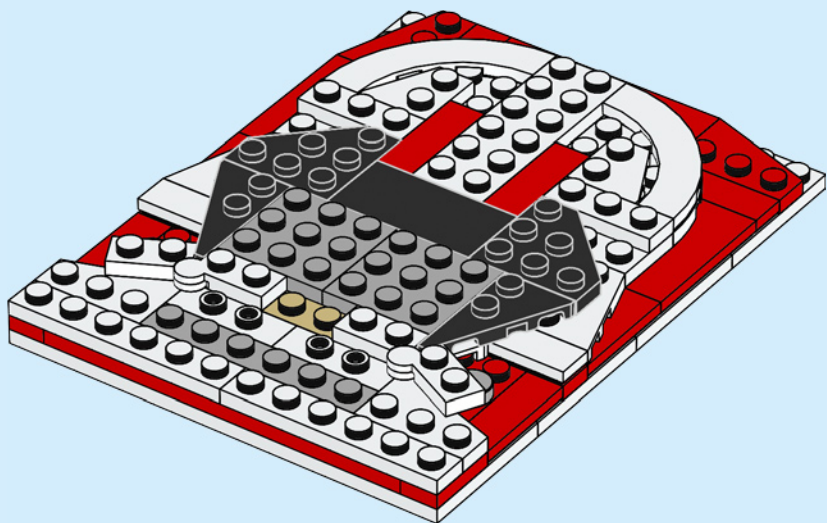



1x



2x

25

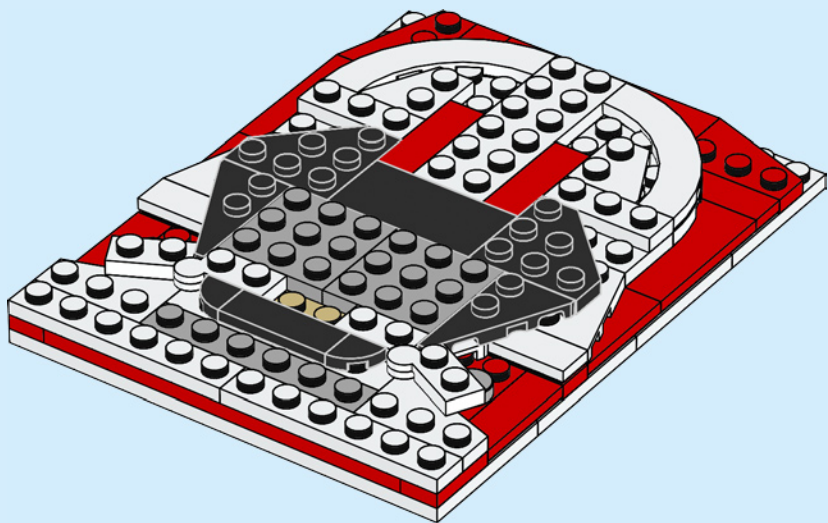

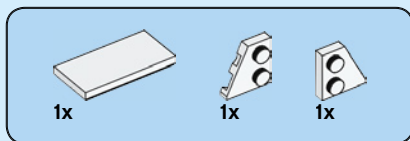

26

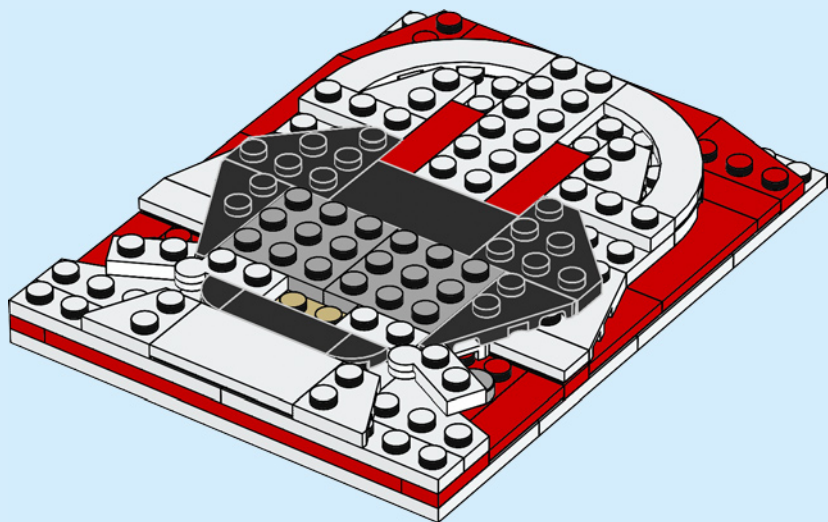

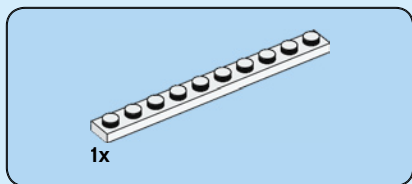

27

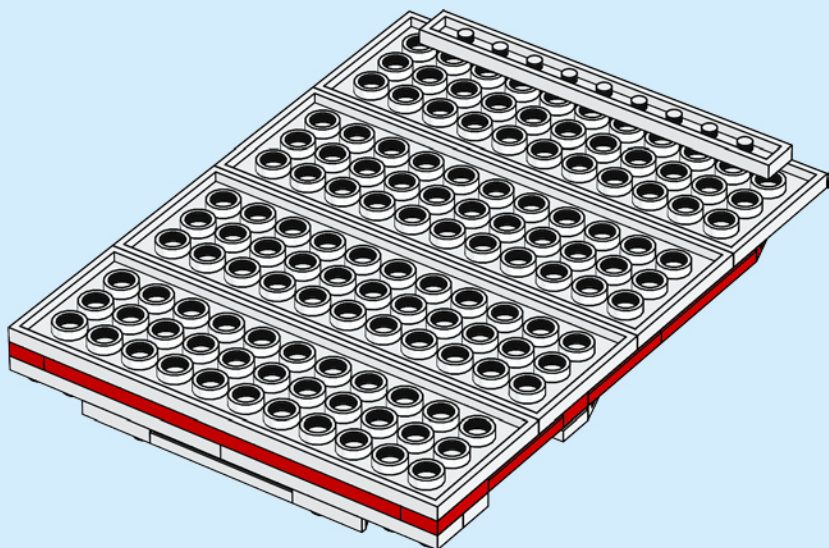



2x



1x

28

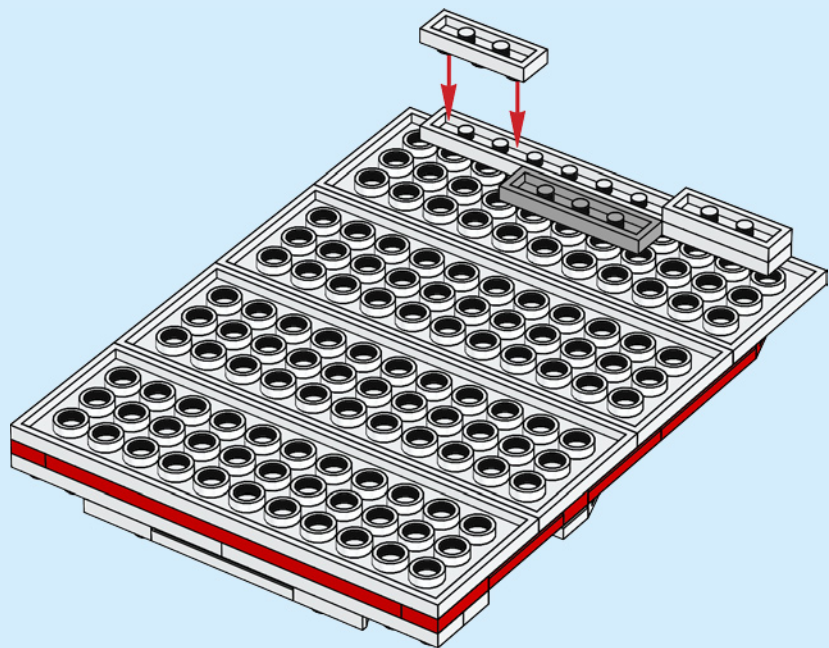



1x



2x

29

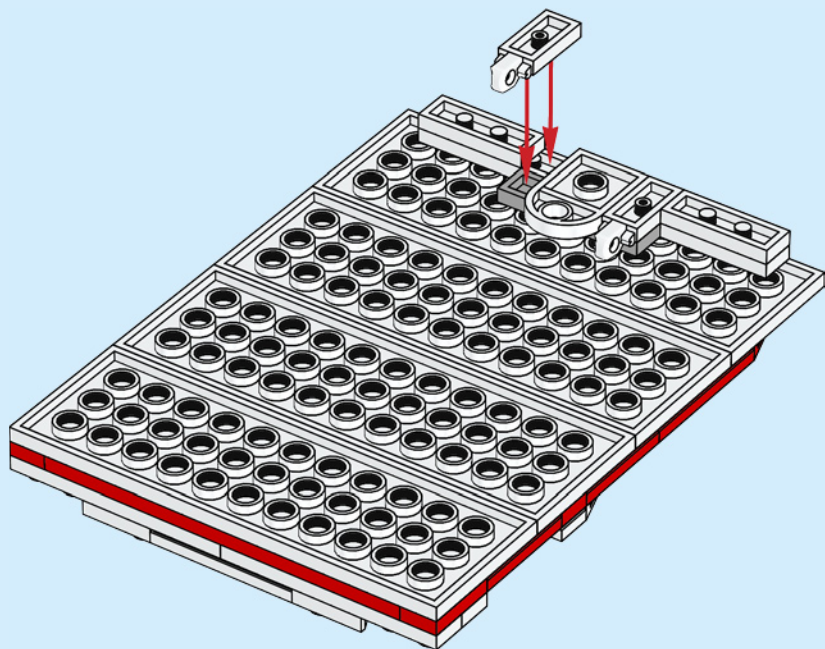

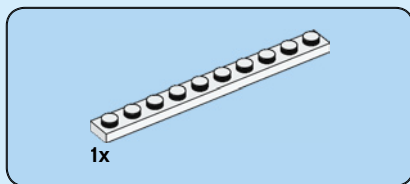

30

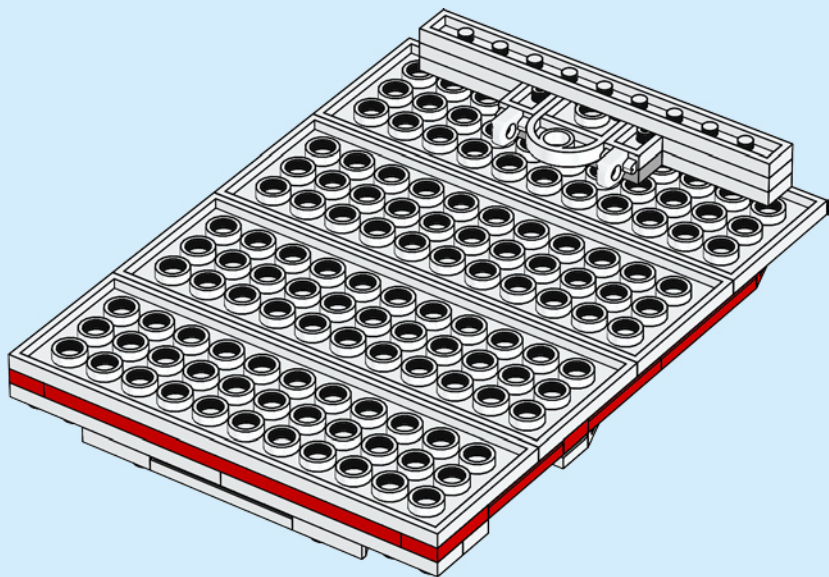

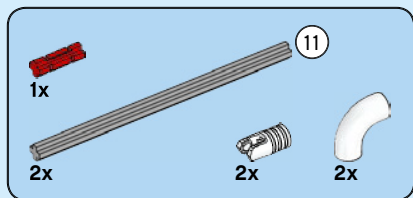

31

1

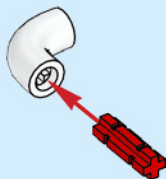

2



3

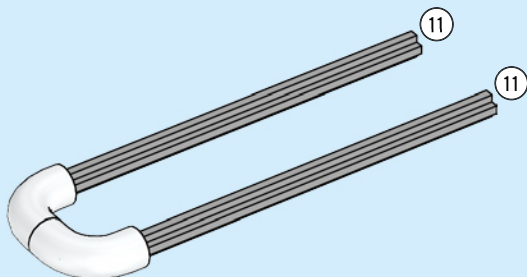



11

1:1

4

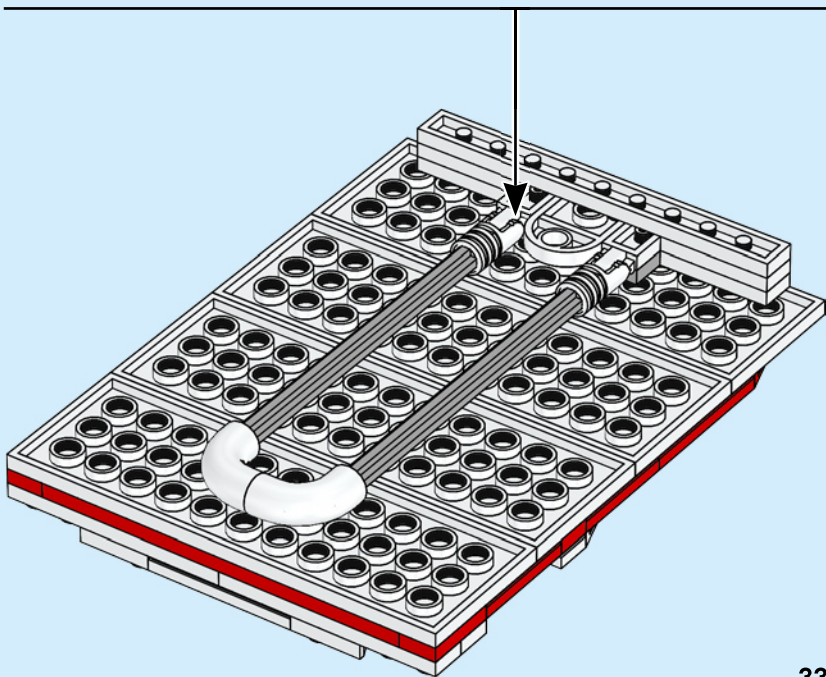
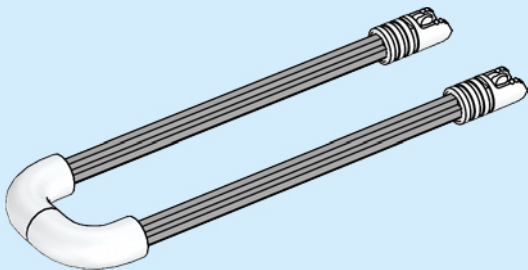

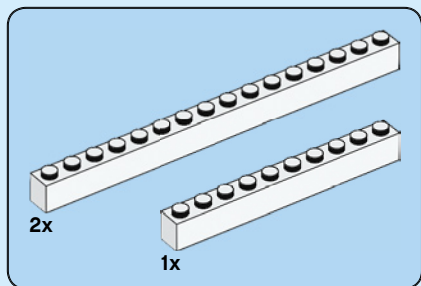

32

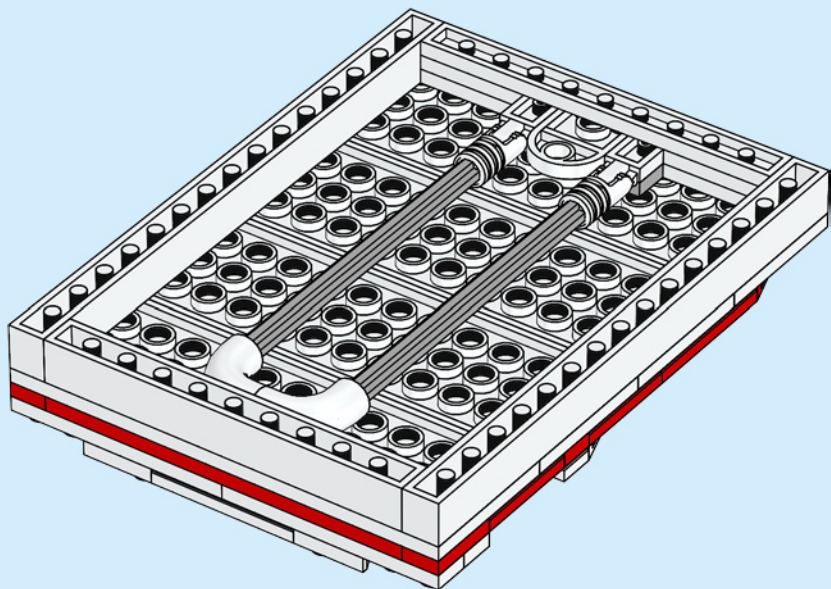



4x

33

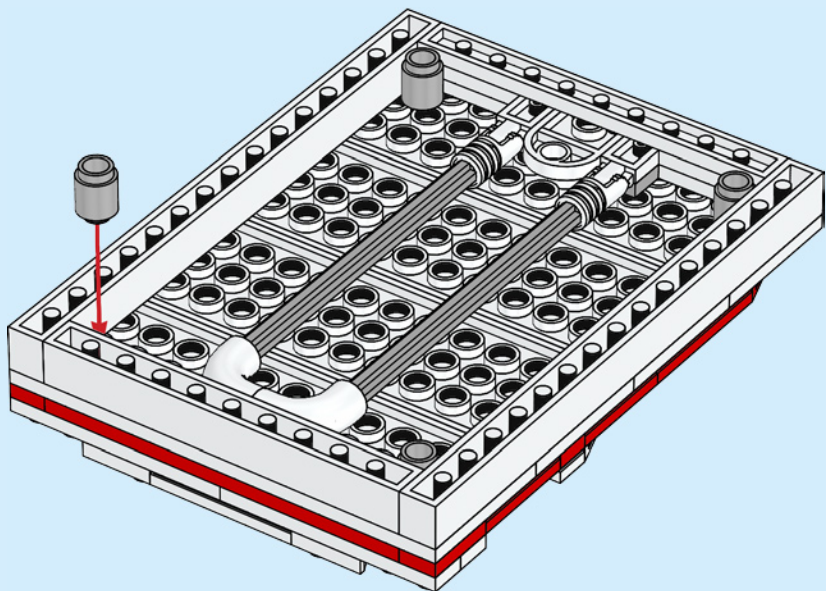



4x

34

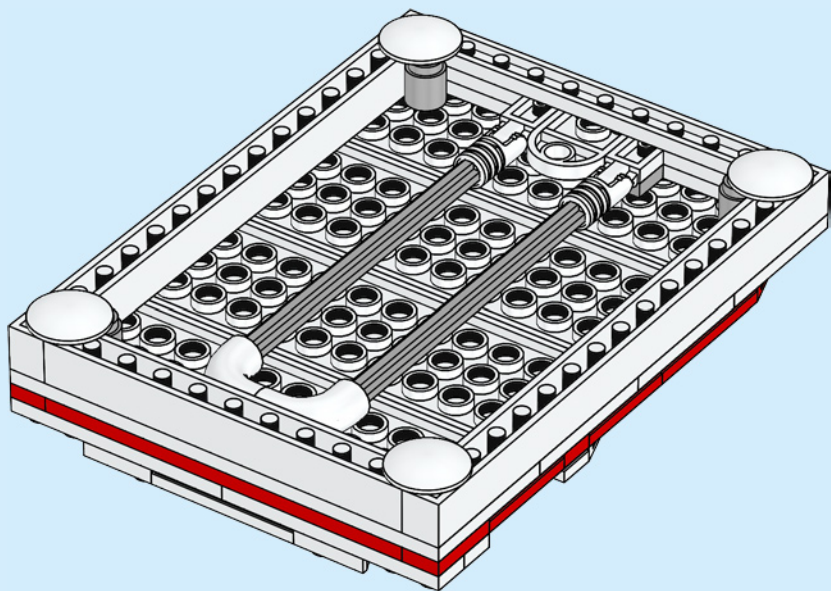



2x

35

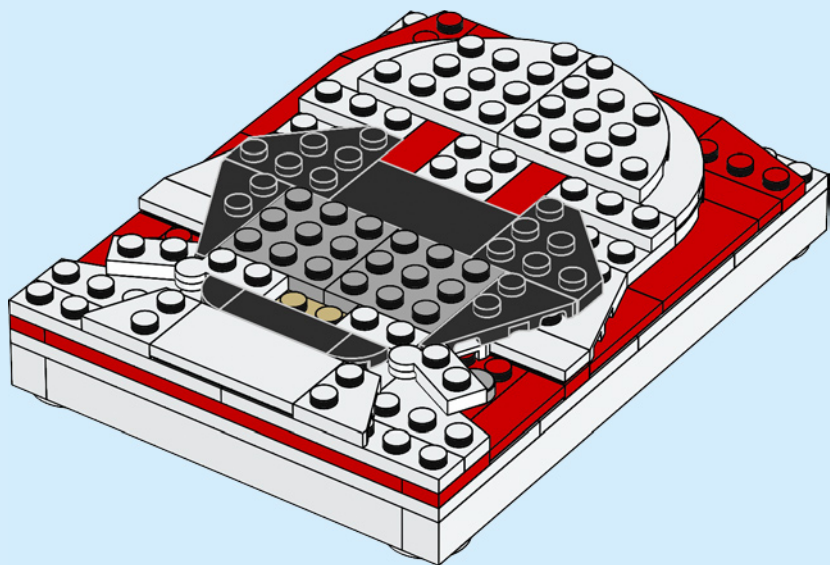



2x



1x

36

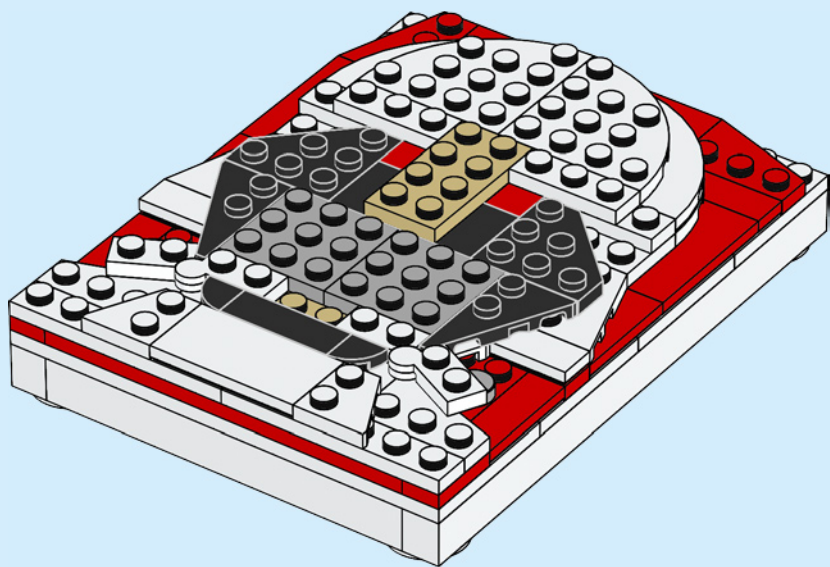



2x



2x

37

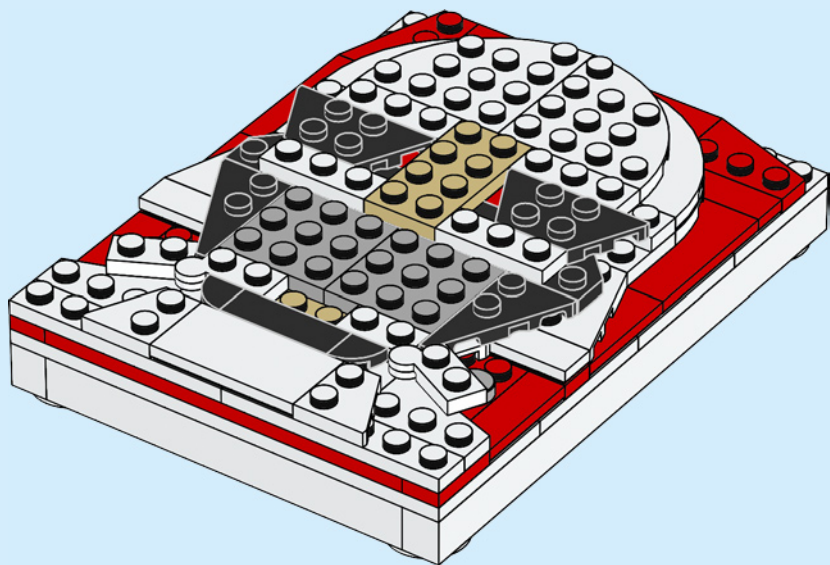

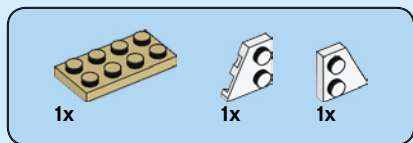

38

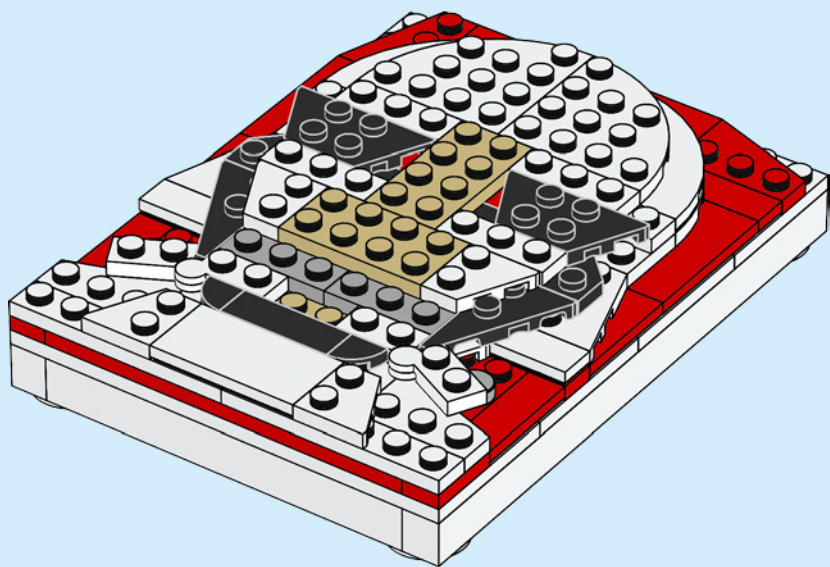



1x



4x

39

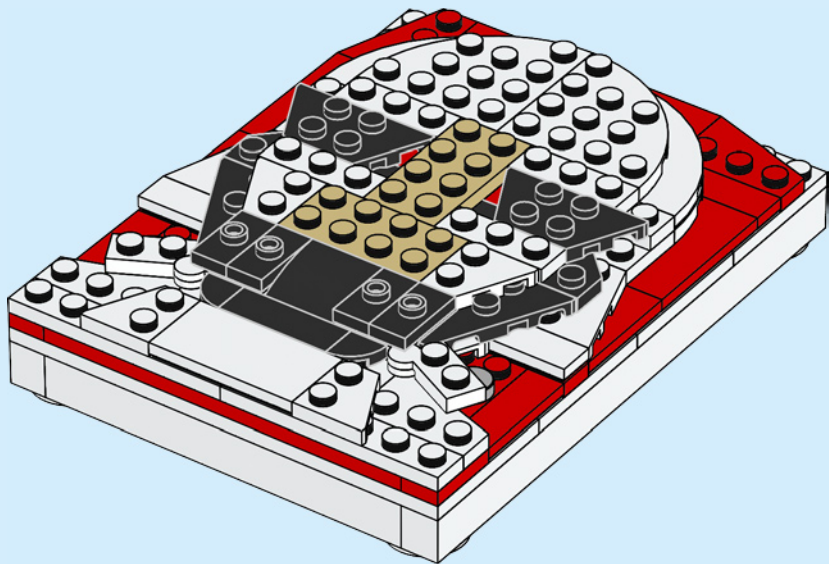

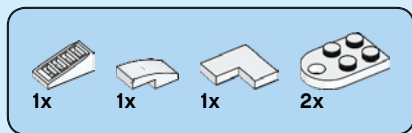

40

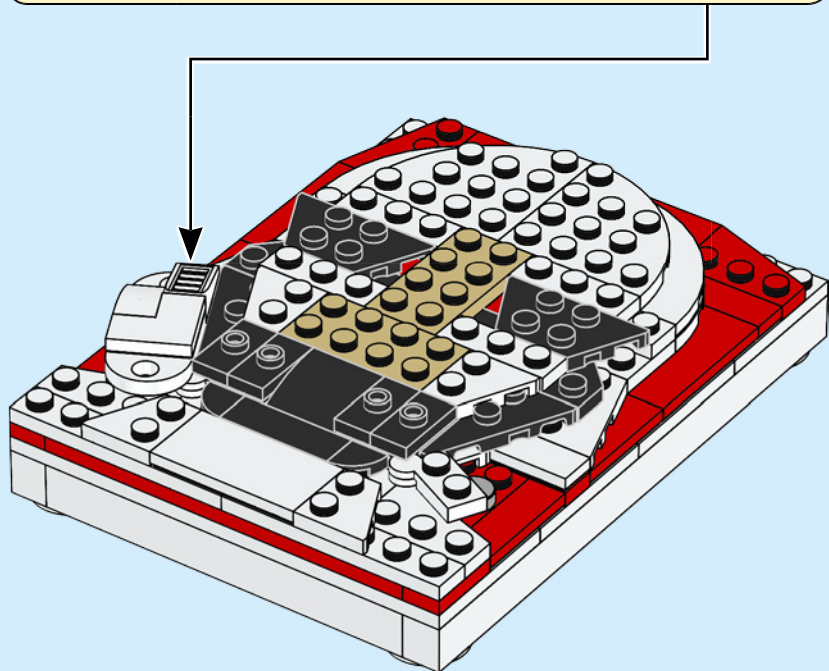
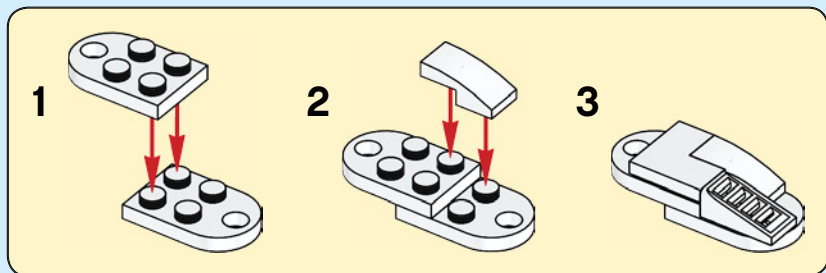

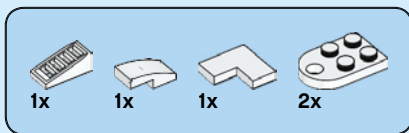

41

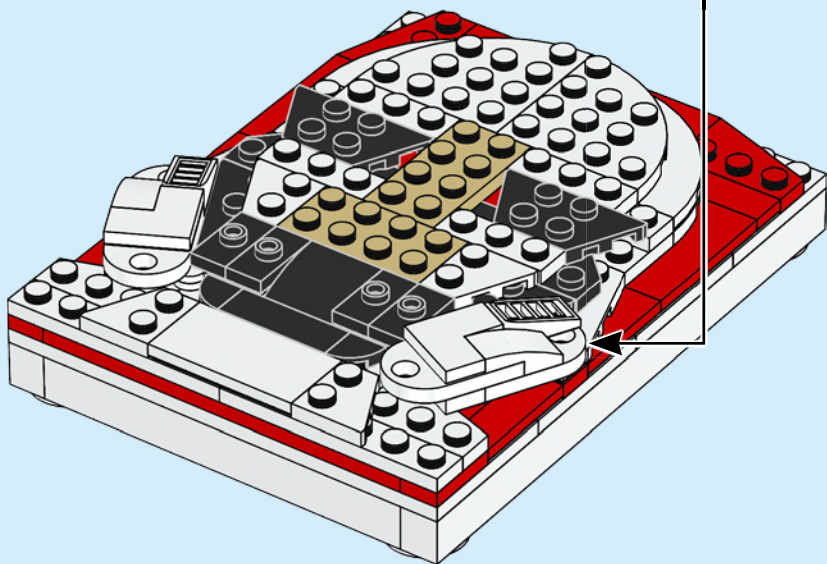
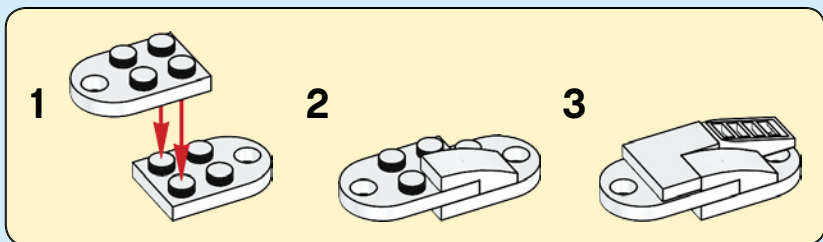

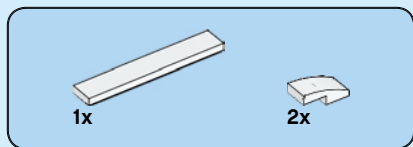

42

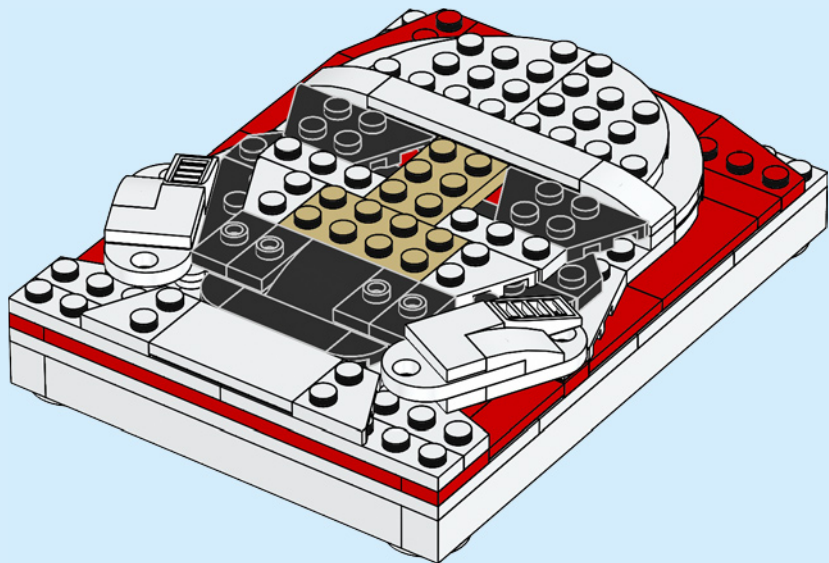

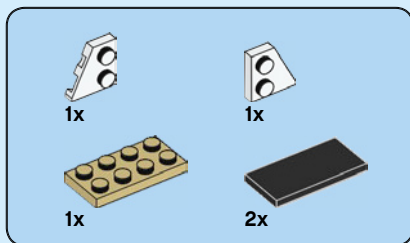

43

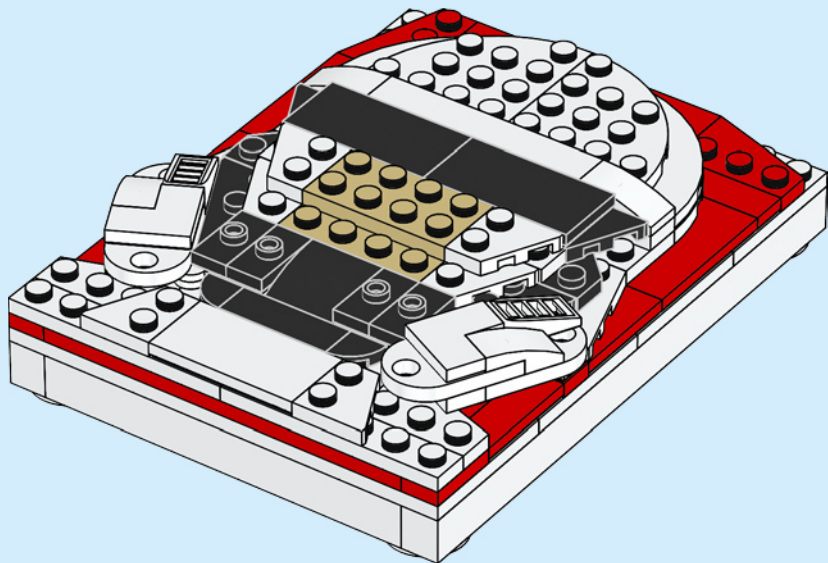

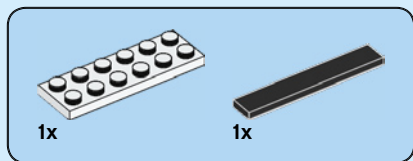

44

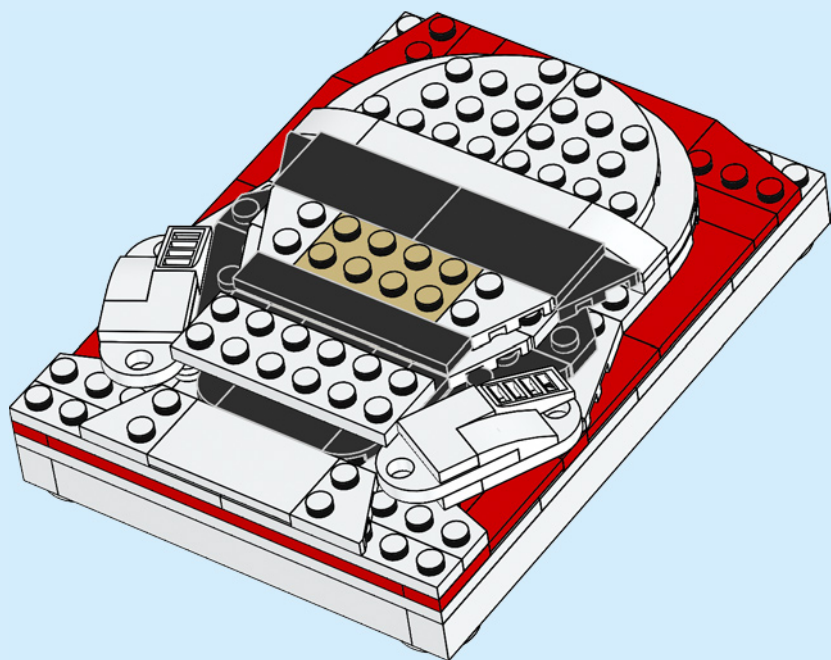



2x



2x

45

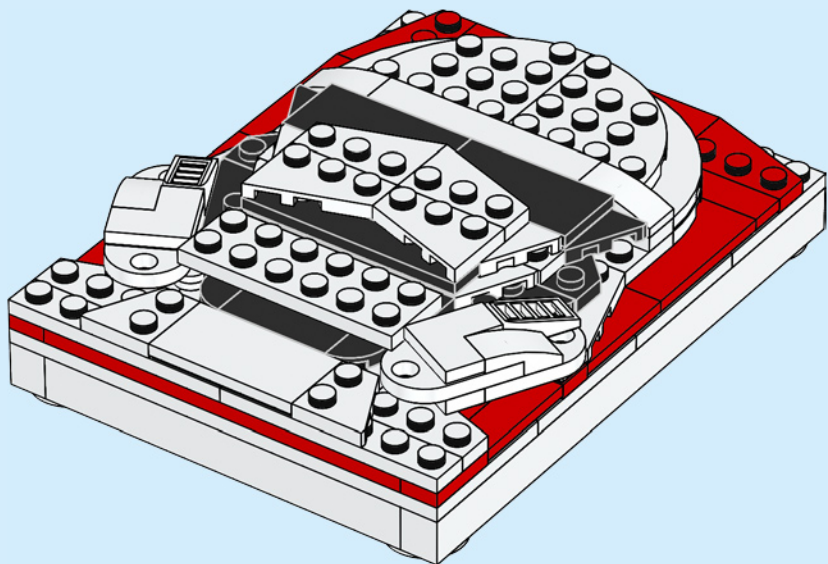

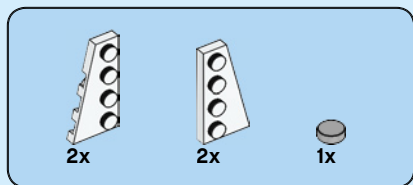

46

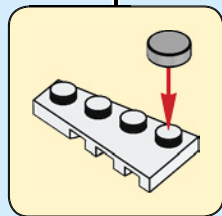
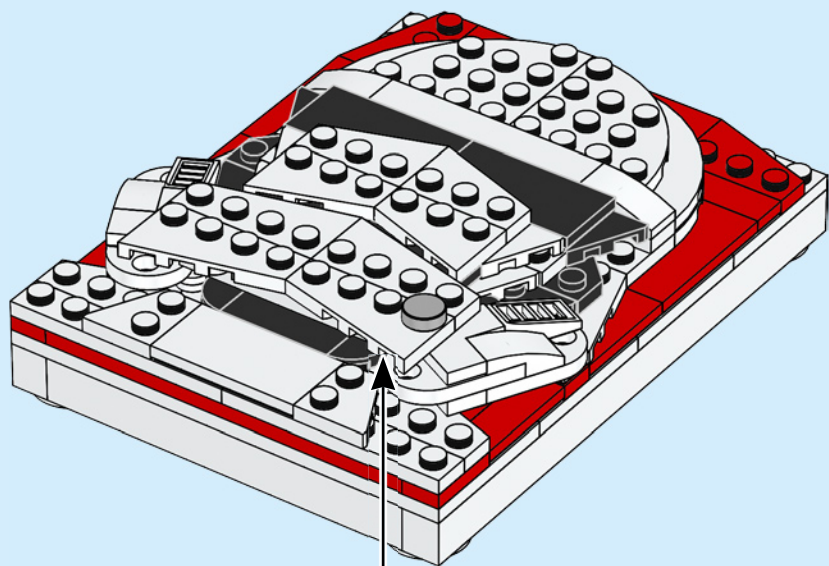

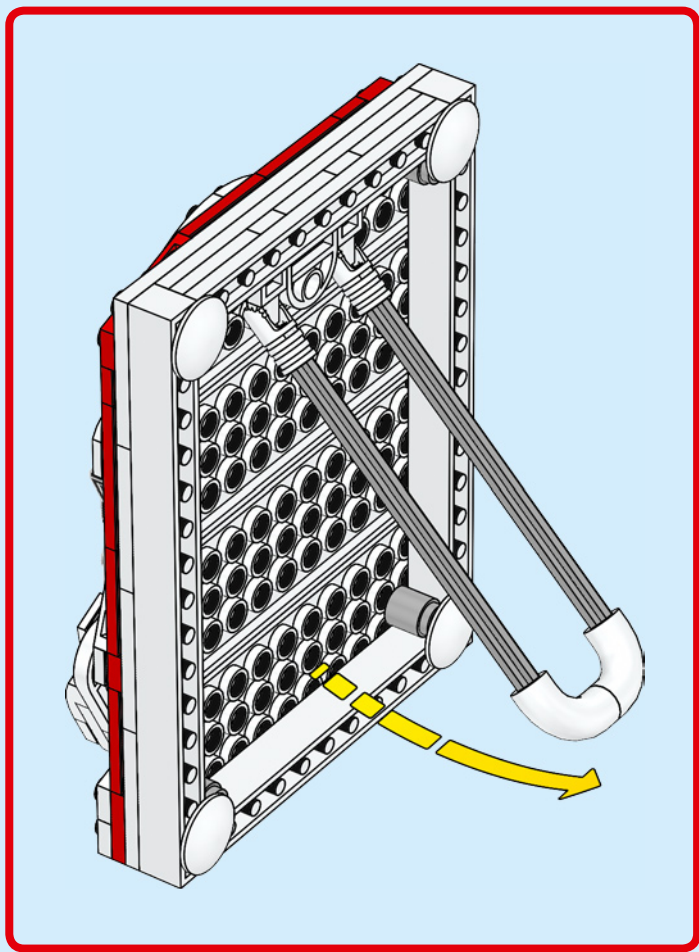

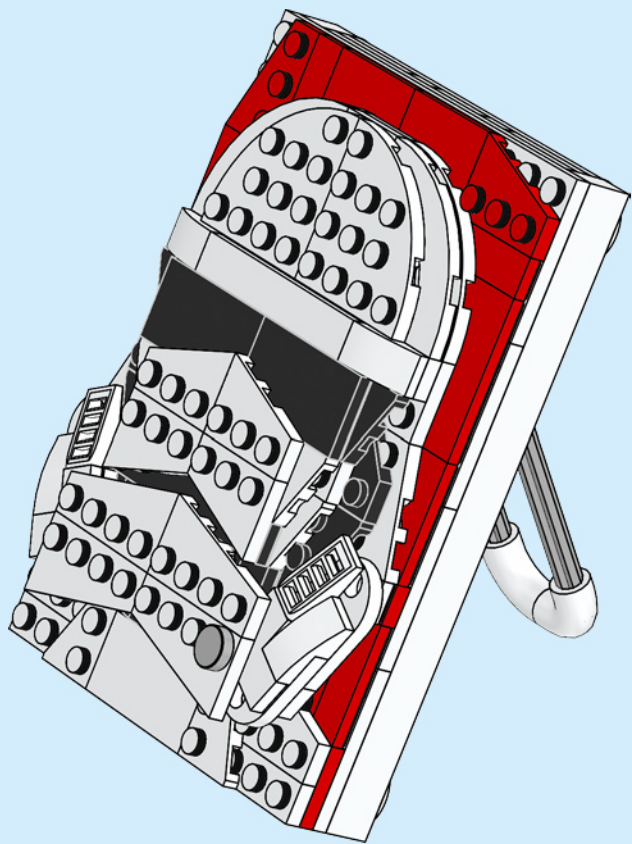

2x
6023804

4x
6034044

2x
6266219

2x
6058329

2x
6195371

8x
362301

5x
6089696

2x
6102776

2x
4560178

2x
366601

4x
663601

2x
6195358

4x
4178429

2x
379501

1x
611101

2x
447701

1x
383201

4x
4168072

2x
246501

4x
4211412

5x
6284071

1x
4211445

2x
6015347

2x
4211438

2x
6178172

1x
447721

5x
6132203

5x
6132204

4x
4179875

2x
4160857

2x
6194851

4x
4179874

2x
4161326

4x
4278271

2x
6271540

2x
4180533

4x
302321

2x
242021

8x
4533742

2x
6189130

2x
4560179

2x
4243814

4x
4114309

3x
6257063

2x
6172383

4x
6092585

1x
6053077

1x
6295293

1x
4558170

2x
4531412

1x
6295295

2x
4227684

6x
4560182

1x
663626

11



Customer Service

Kundenservice

Service Consommateurs

Servicio Al Consumidor

LEGO.com/service or dial



: 00800 5346 5555

: 1-800-422-5346

WIN

GO TO WWW.LEGO.COM/PRODUCTFEEDBACK
AND GIVE US YOUR SHORT **FEEDBACK**
ABOUT THIS LEGO® SET FOR A CHANCE
TO WIN A COOL LEGO PRIZE.

Terms & Conditions apply



LEGO.com/productfeedback

GEWINNE

Erzähle uns auf
www.LEGO.com/productfeedback

etwas über die Erfahrungen, die du mit
diesem LEGO® Set gemacht hast, und
sichere dir die Chance auf einen coolen
LEGO Preis!

Es gelten die Teilnahmebedingungen

GAGNE

Rends-toi sur
www.LEGO.com/productfeedback

et donne-nous quelques commentaires
sur ce produit LEGO® pour avoir une
chance de gagner un prix LEGO !

Voir Conditions Générales

GANA

Visita
www.LEGO.com/productfeedback

y envíanos tu opinión acerca de este
set LEGO®. ¡Participarás en el sorteo
de un premio LEGO!

Términos y Condiciones aplicables

获取奖品

登录
www.LEGO.com/productfeedback

给出关于此乐高®套装的简短反馈，
就有机会获得炫酷乐高奖品

《条款及条件》适用

경품 당첨 기회

www.LEGO.com/productfeedback

페이지로 이동하여 이 레고® 세트에 대한
간략한 피드백을 보내 주시고 멋진 레고
경품을 탈 수 있는 기회도 잡으십시오

약관 적용

ЗАПОЛНИ АНКЕТУ И ПОЛУЧИ ПРИЗ

Перейди по ссылке
www.LEGO.com/productfeedback

ответь всего на несколько во-
просов об этом наборе LEGO®,
и у тебя появится шанс выиграть за-
мечательный приз от компании LEGO.

Применяются Условия и правила
участия

LEGO and the LEGO logo are trademarks of the LEGO Group. ©2020 The LEGO Group.
STARWARS.COM © & ™ Lucasfilm Ltd.

6327485