

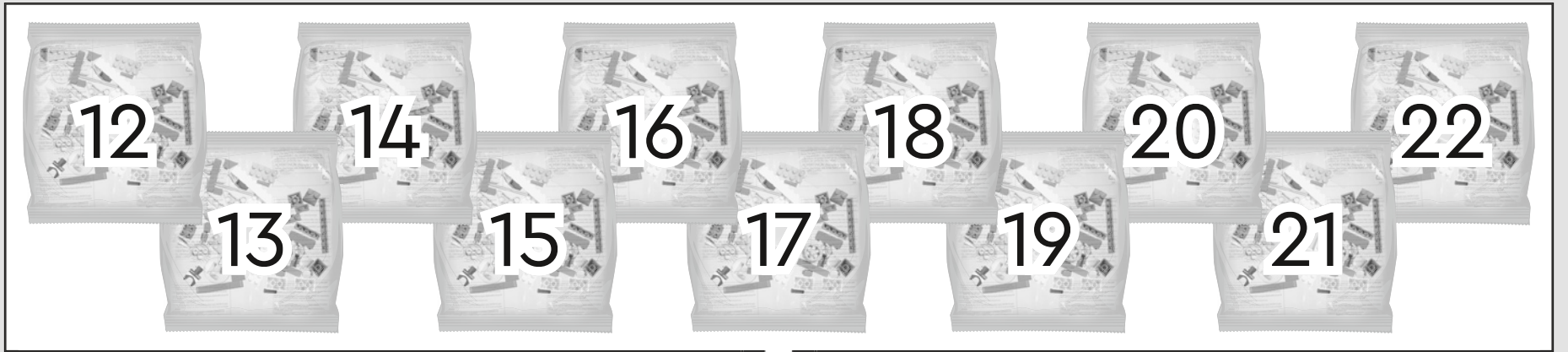

Harry Potter



WIZARDING  
WORLD





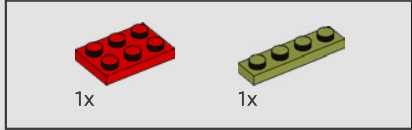
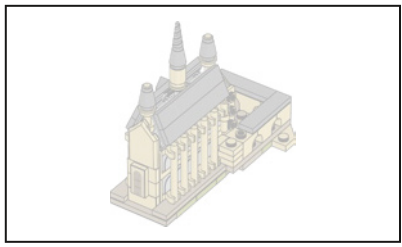

309

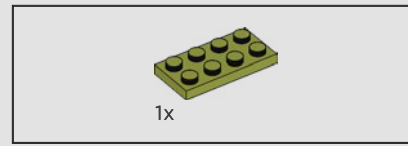
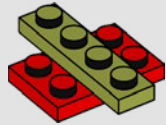

310

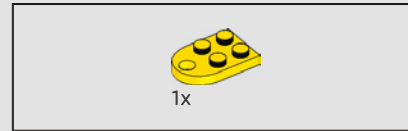
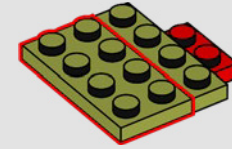

311

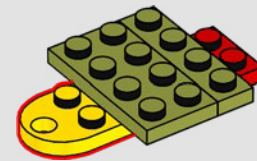

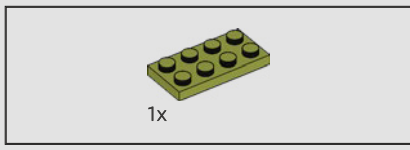

312

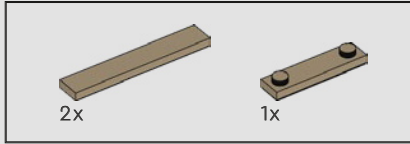
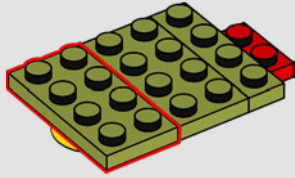

313

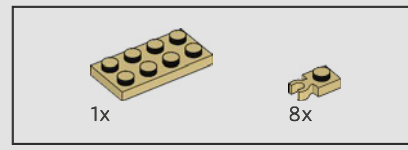
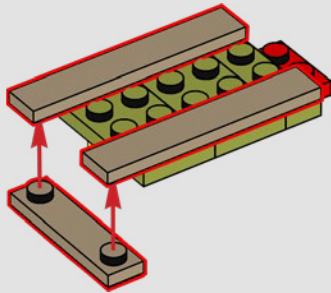

314

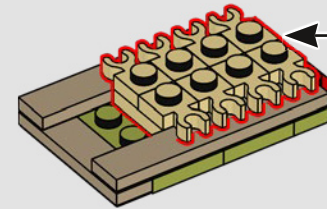
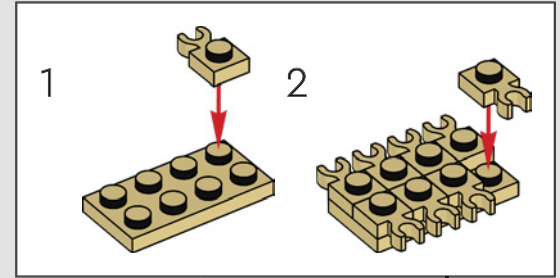

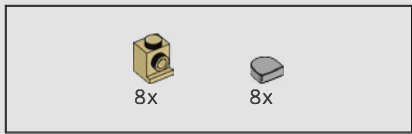

315

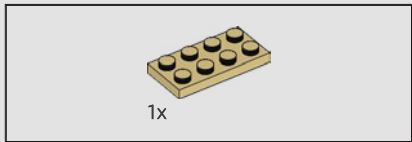
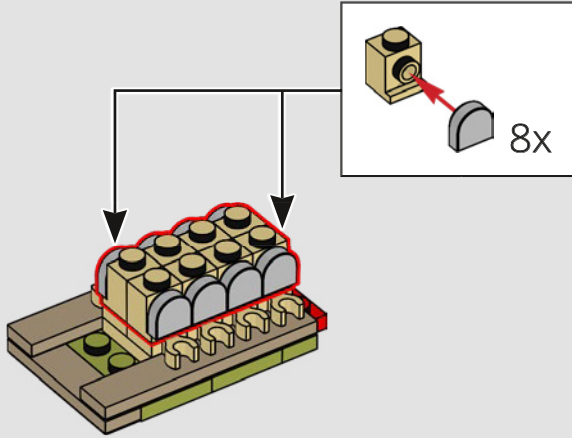

316

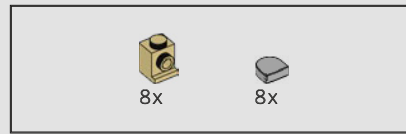
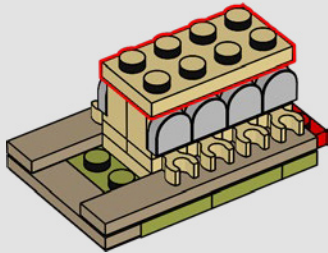

317

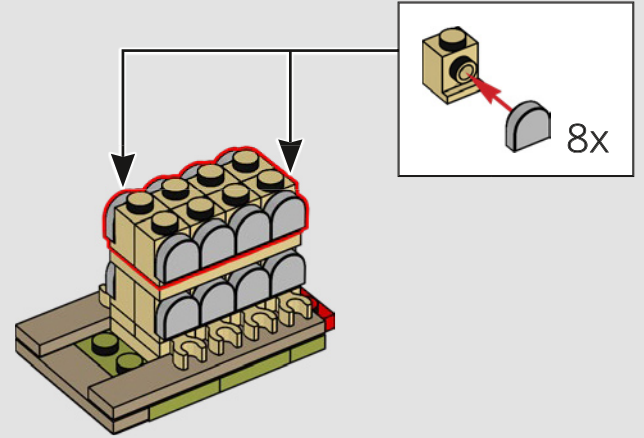

318

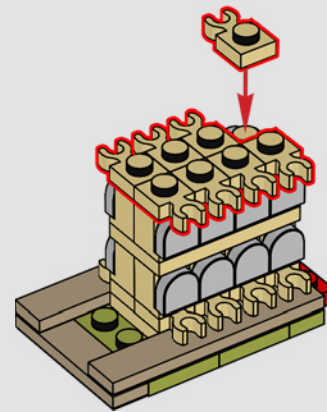

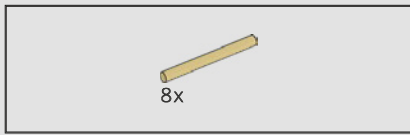

319

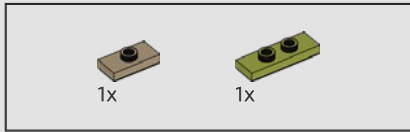
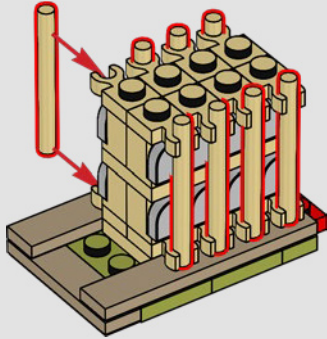

320

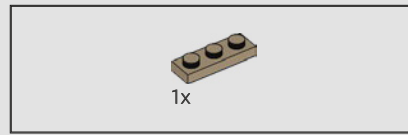
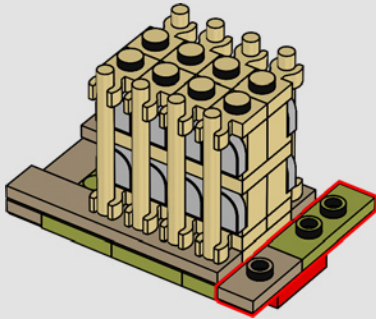

321

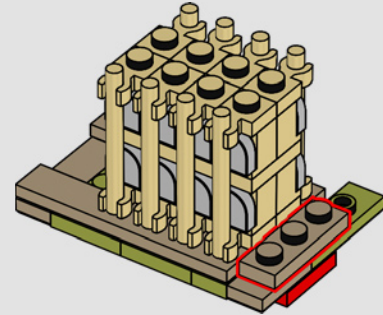

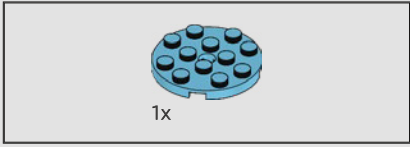
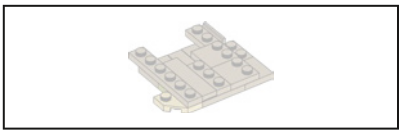

322

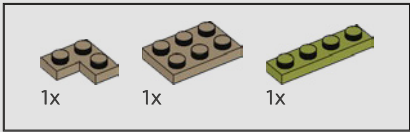
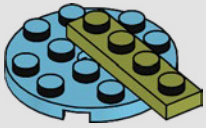

323

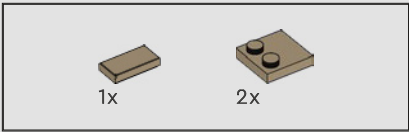
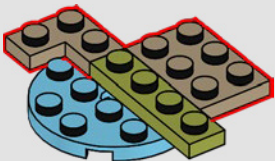

324

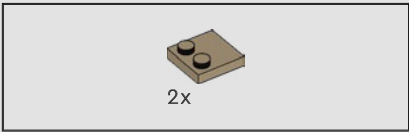
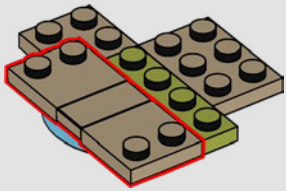

325

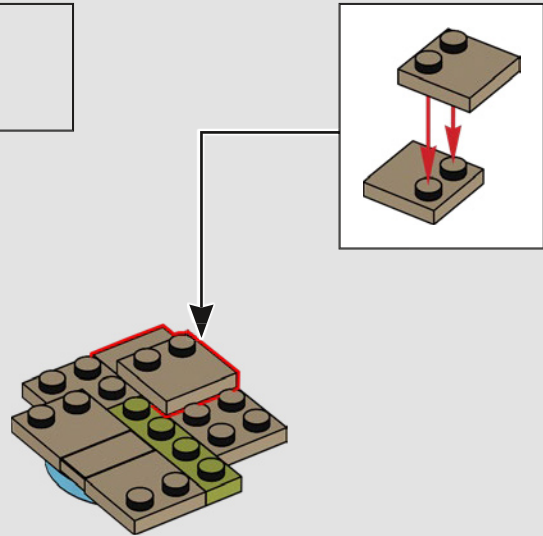



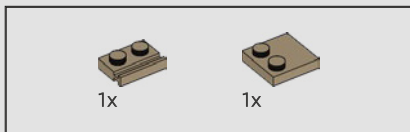

326

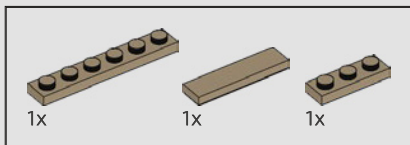
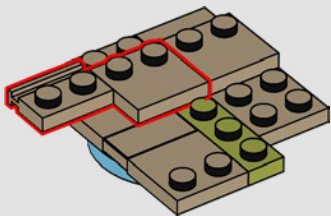

327

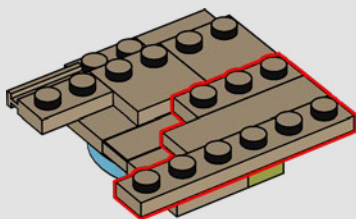

328

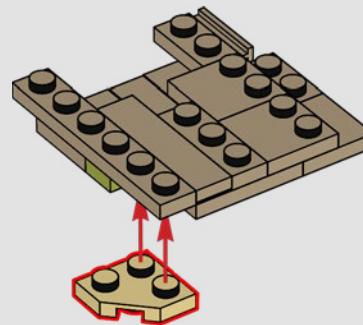

329

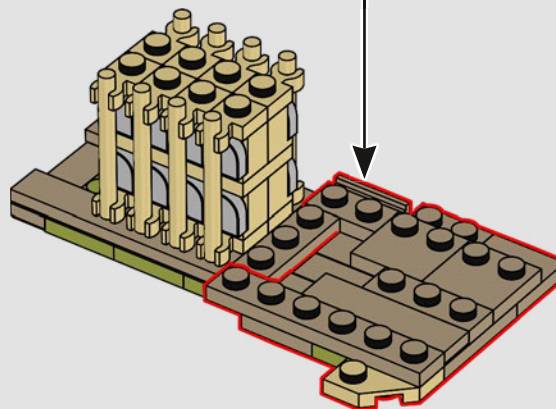

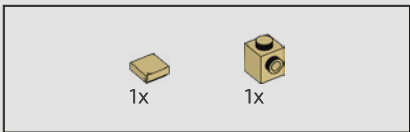

330

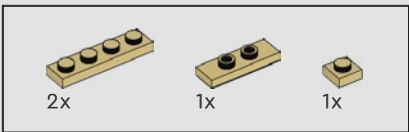
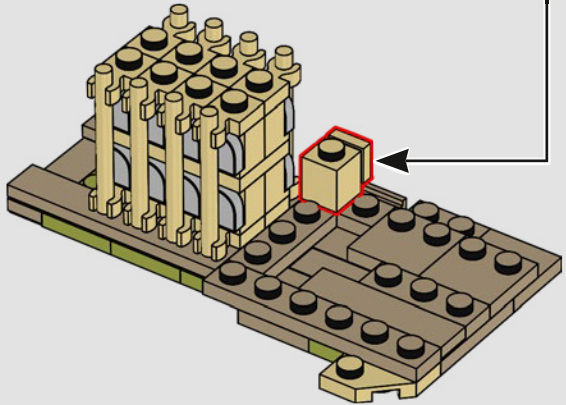
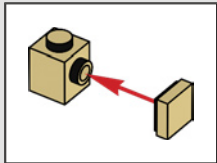

331

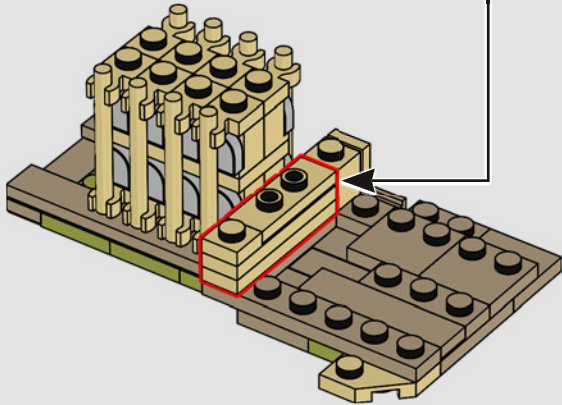
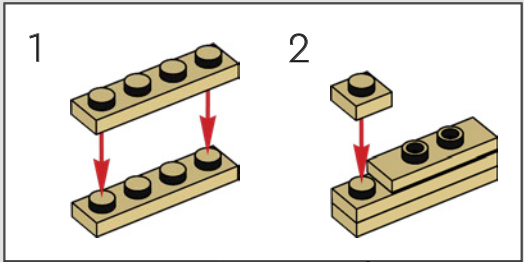

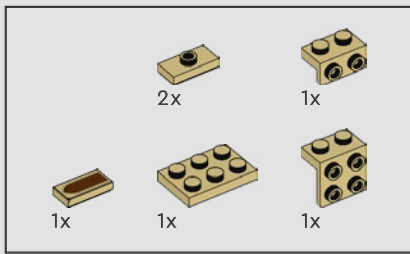

332

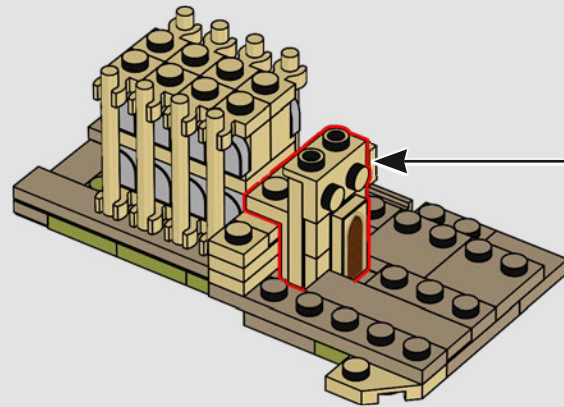
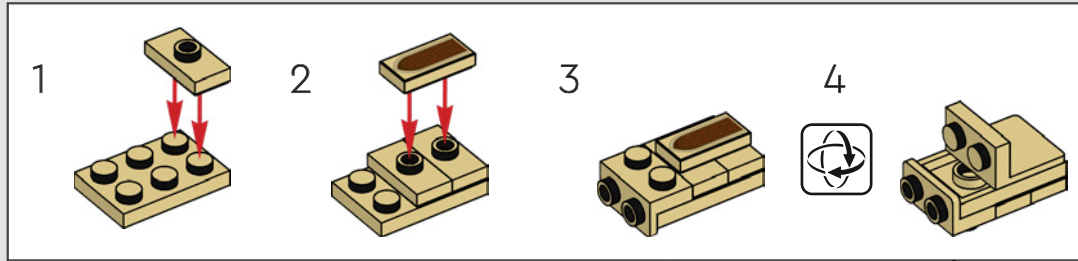



333

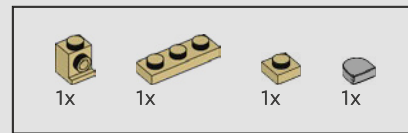
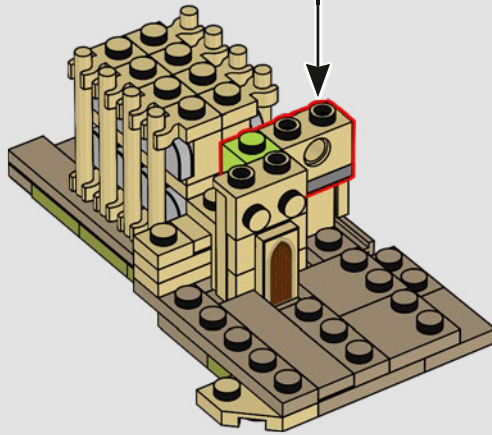
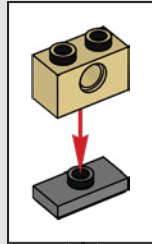

334

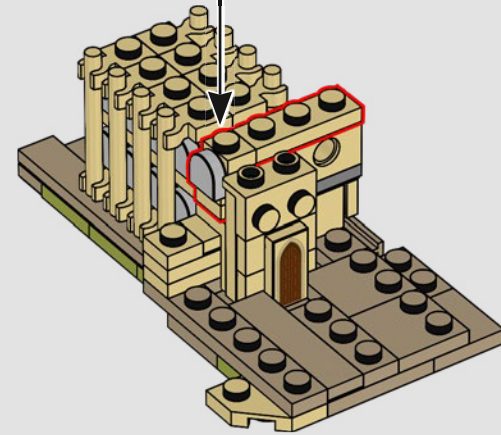
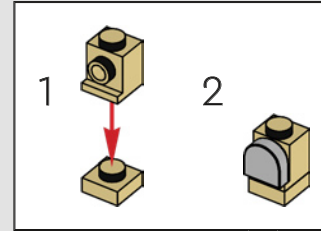



335

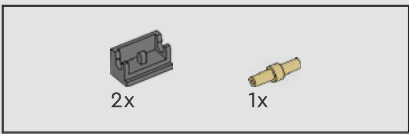
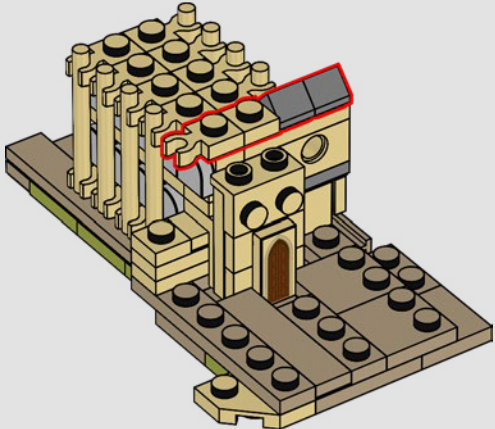

336

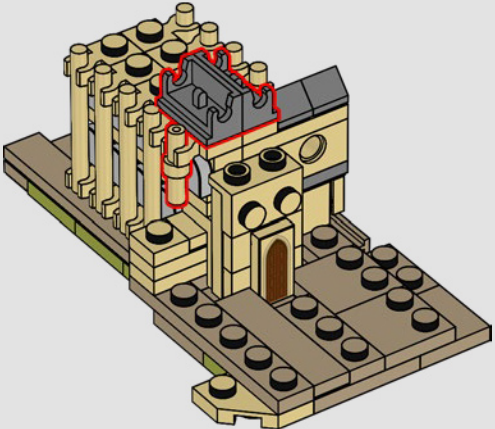

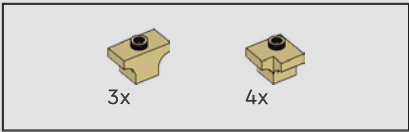

337

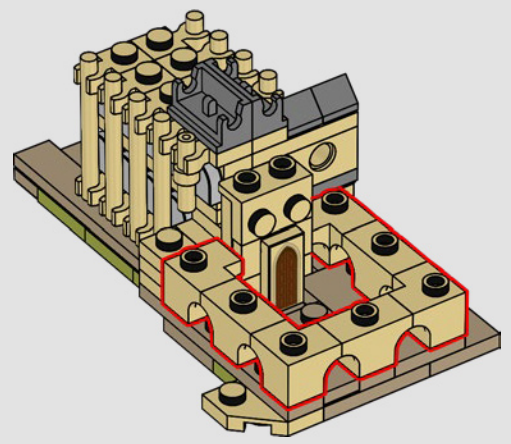

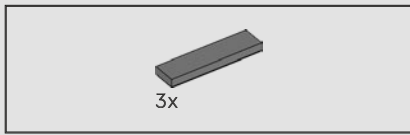

338

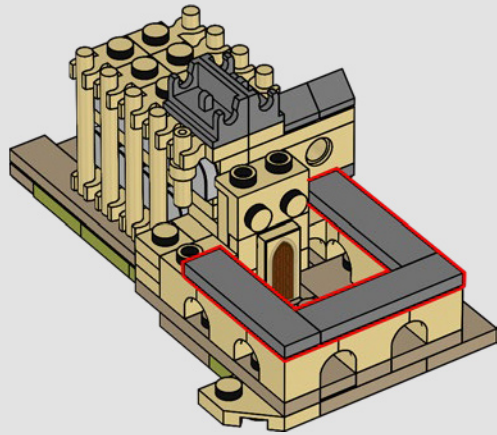

339

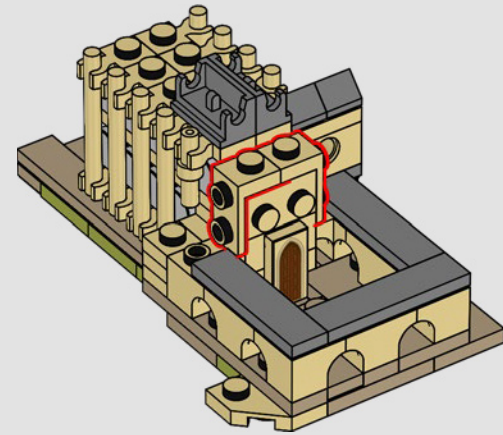



340

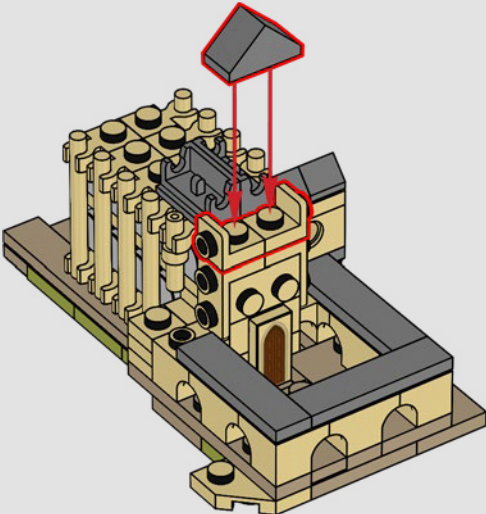

341

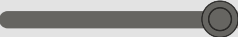
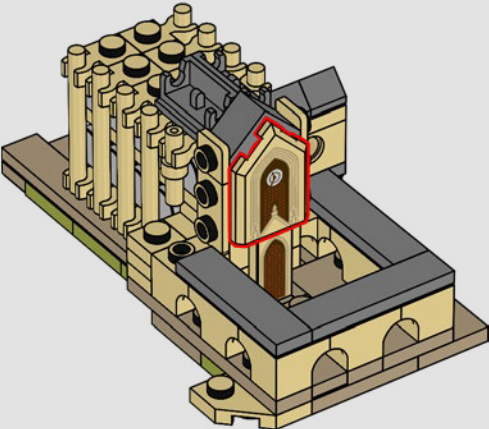



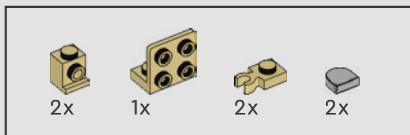

342

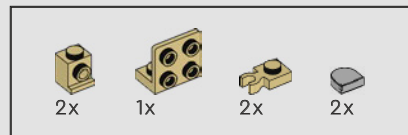
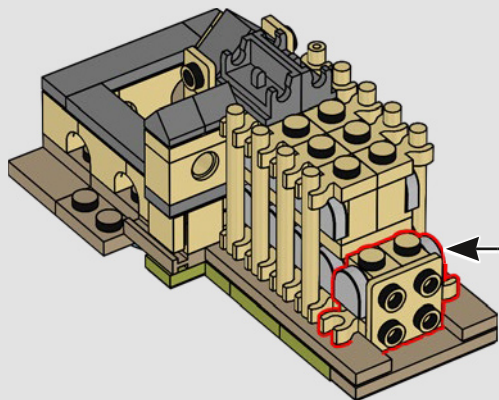
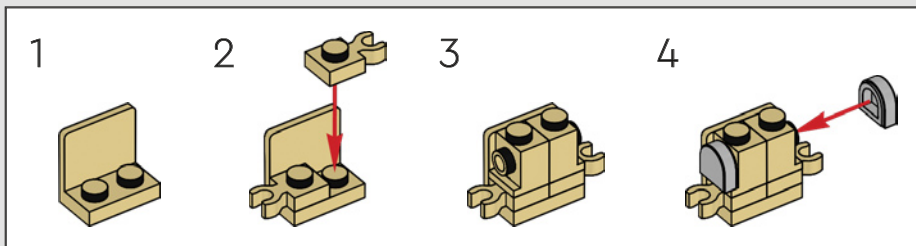

343

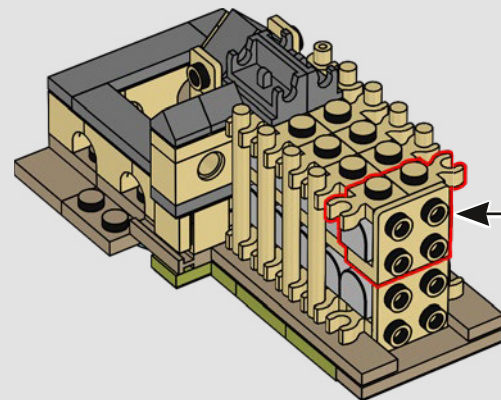
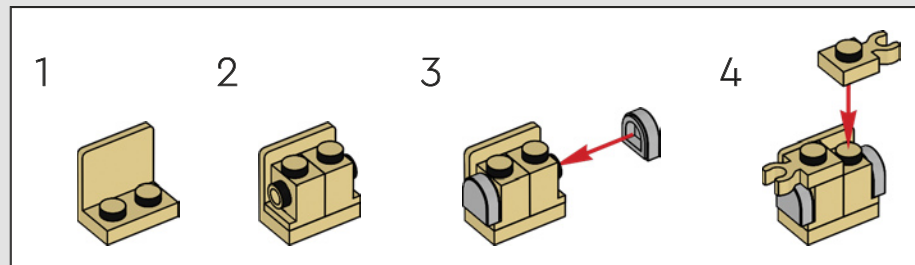



344

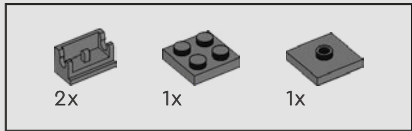
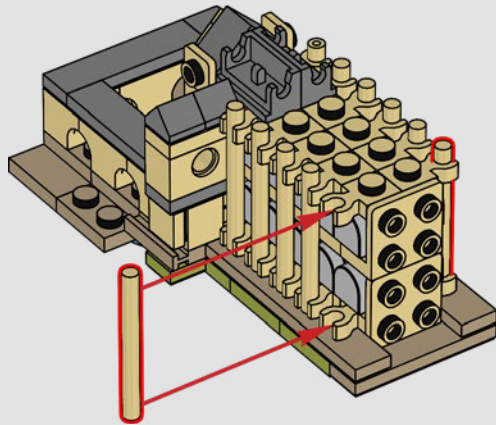

345

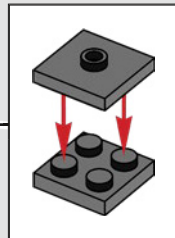
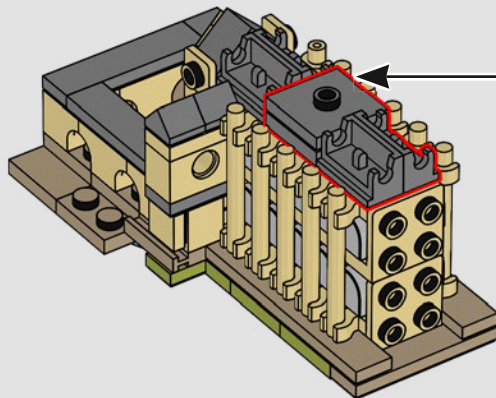

346

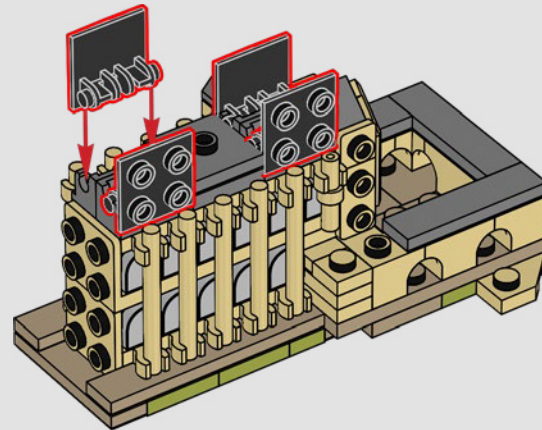

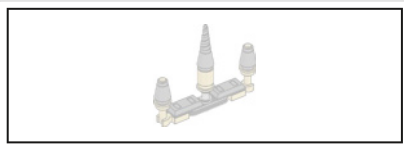

1x

347

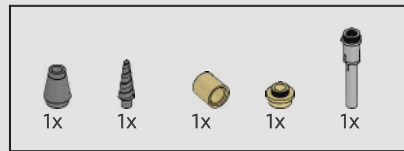
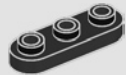

348

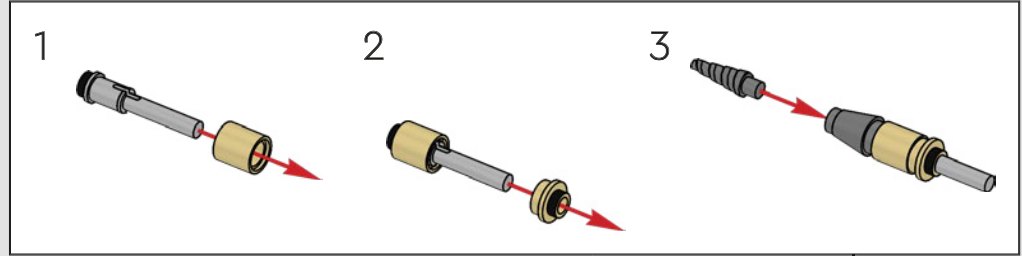



349

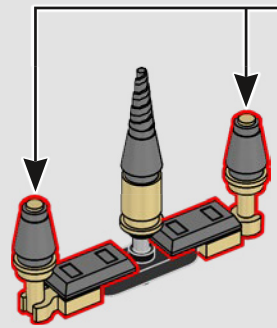
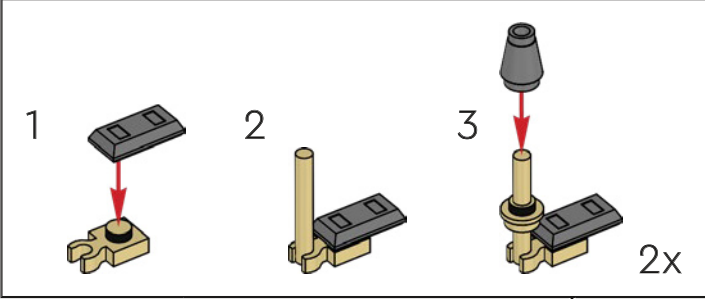

350

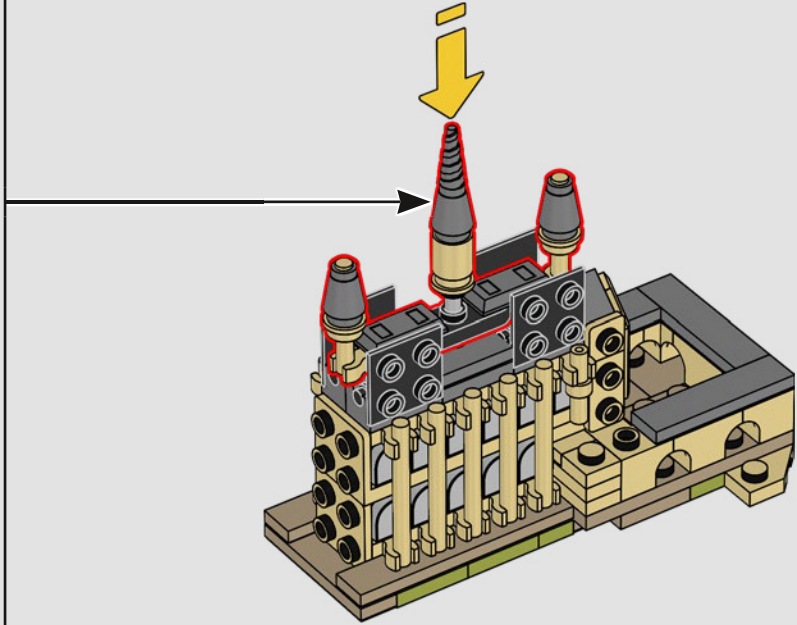

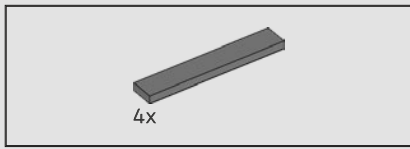

351

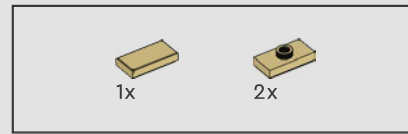
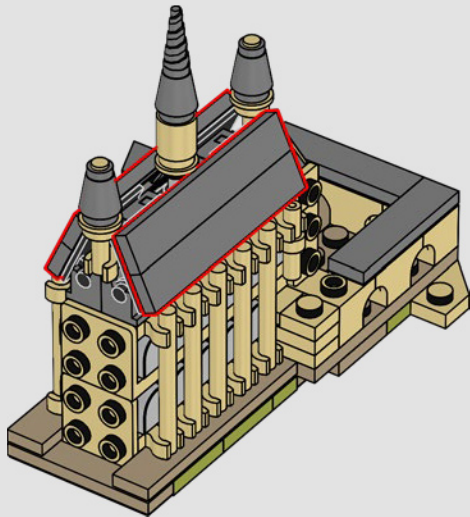

352

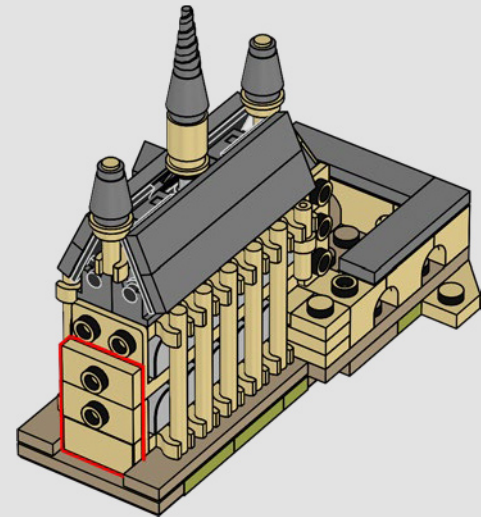

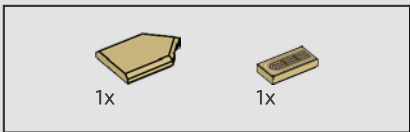

353

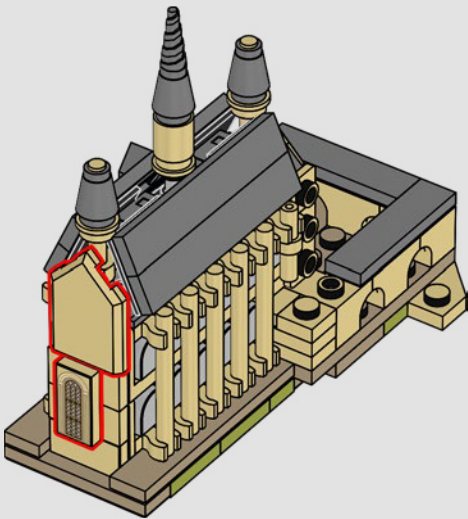

The ceiling in the Great Hall can be enchanted to mimic the night sky.

354

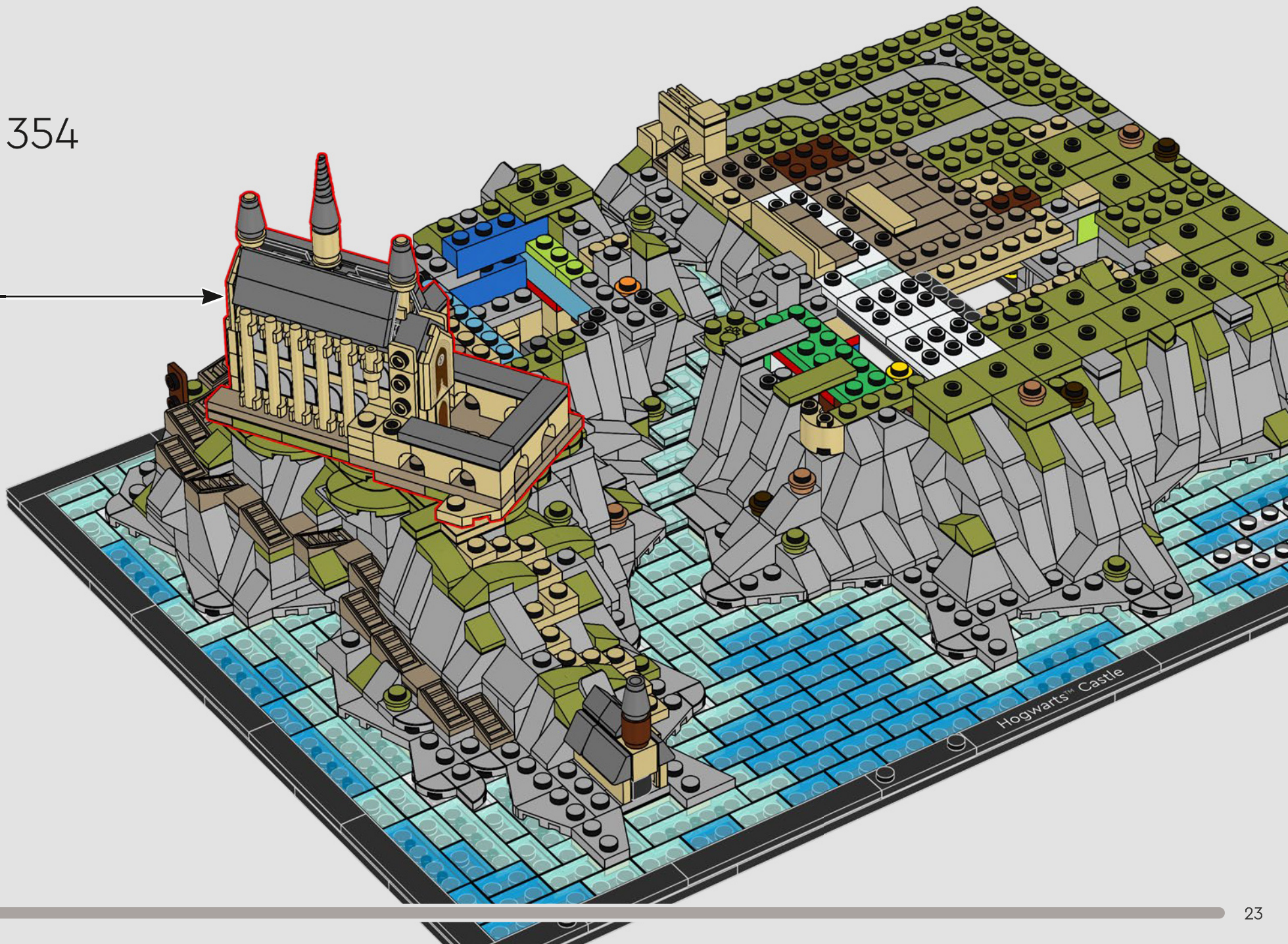

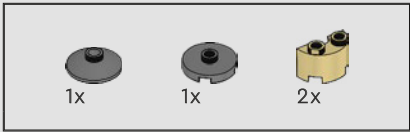

355

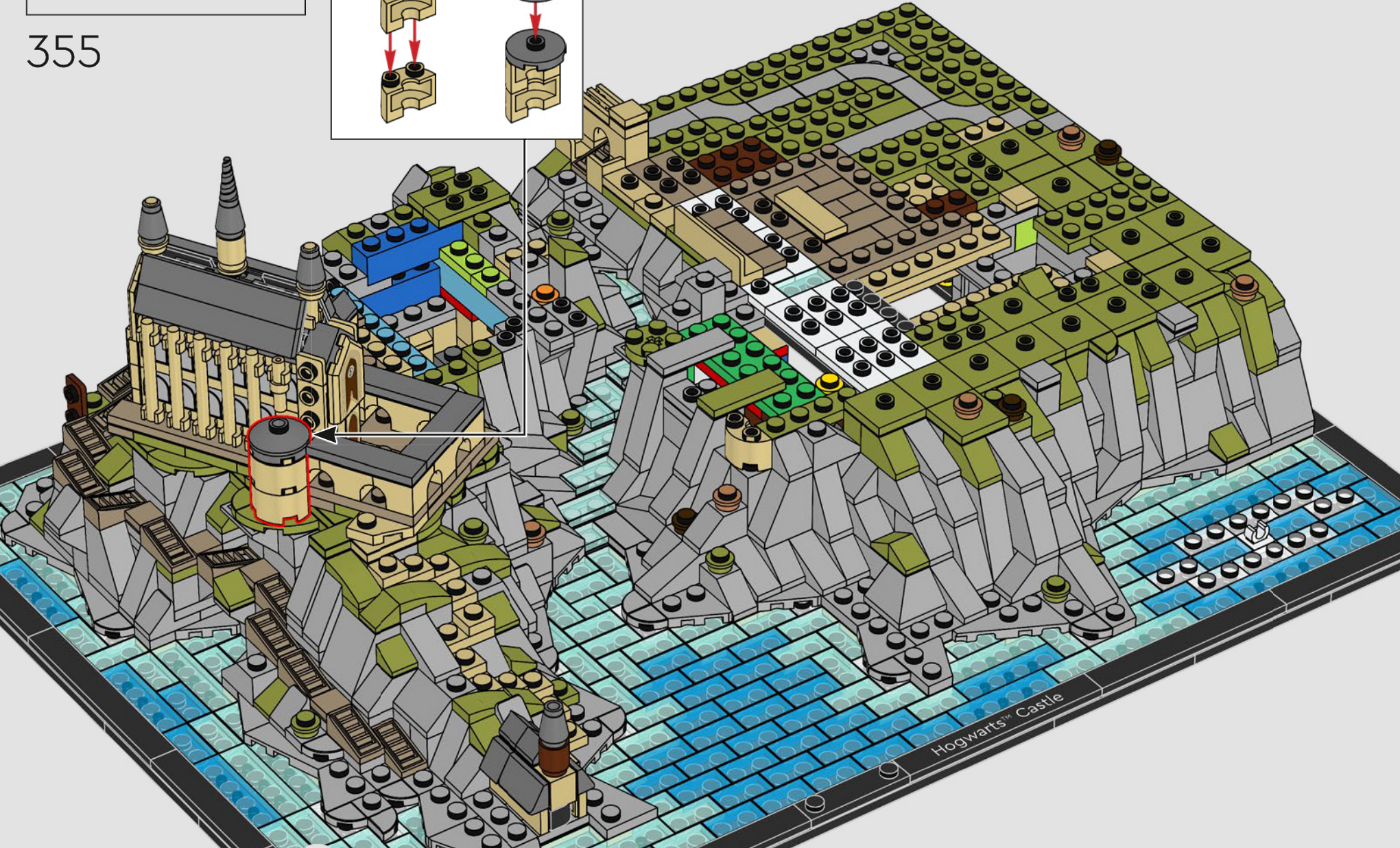
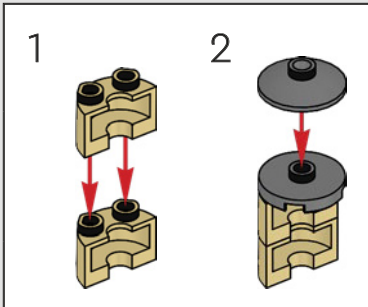



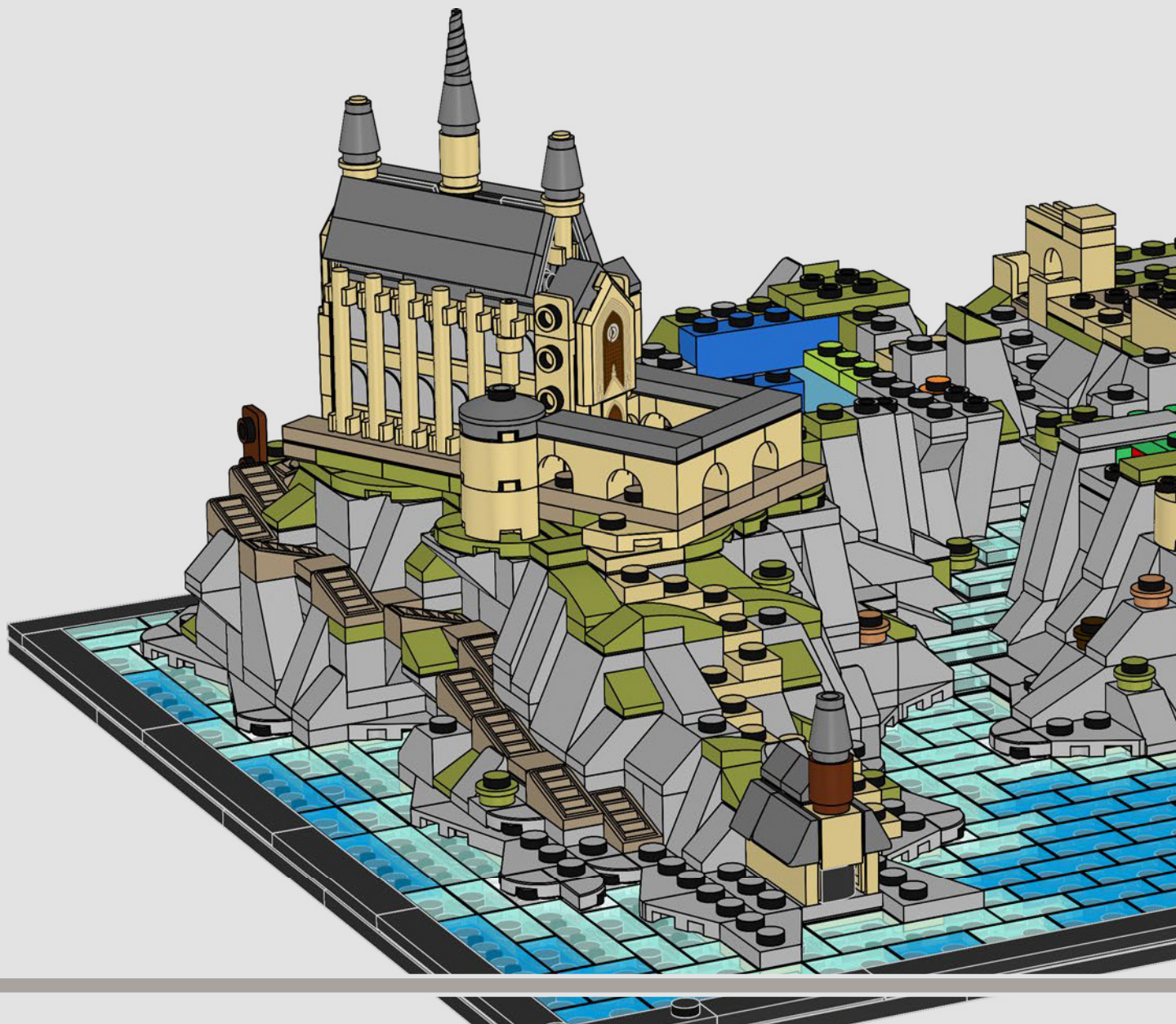

Immediately after arriving at Hogwarts™, first-year students are shown to the Great Hall where The Sorting Hat™ determines which house will be their home away from home.



356



The trees are built with LEGO® crystal and ice cream elements (and a little magic).

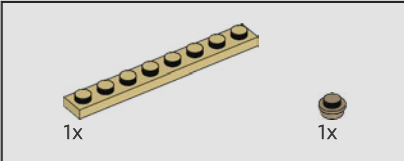
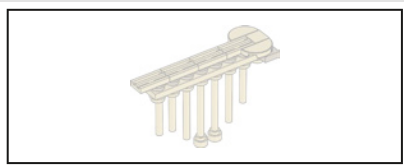

357

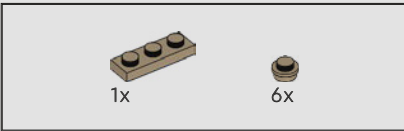
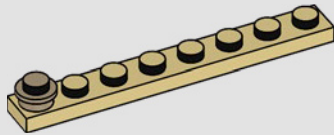

358

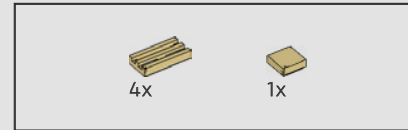
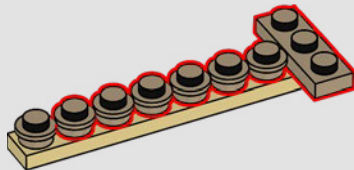

359

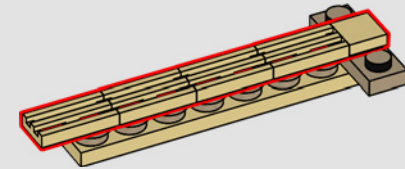

360

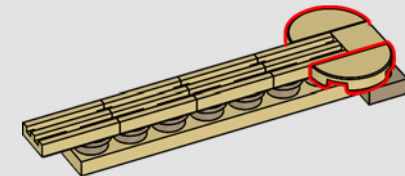

8x

361

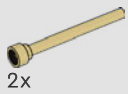
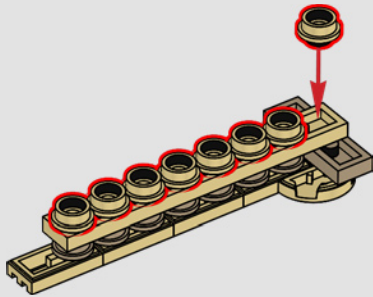

2x

362

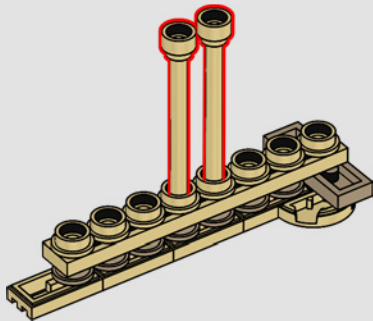

2x

3x

363

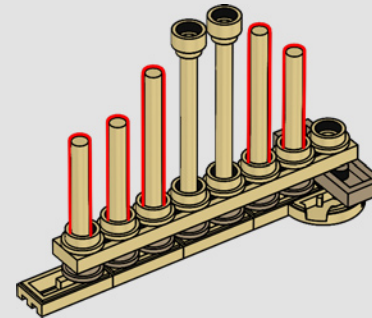

364



Hogwarts™ Castle

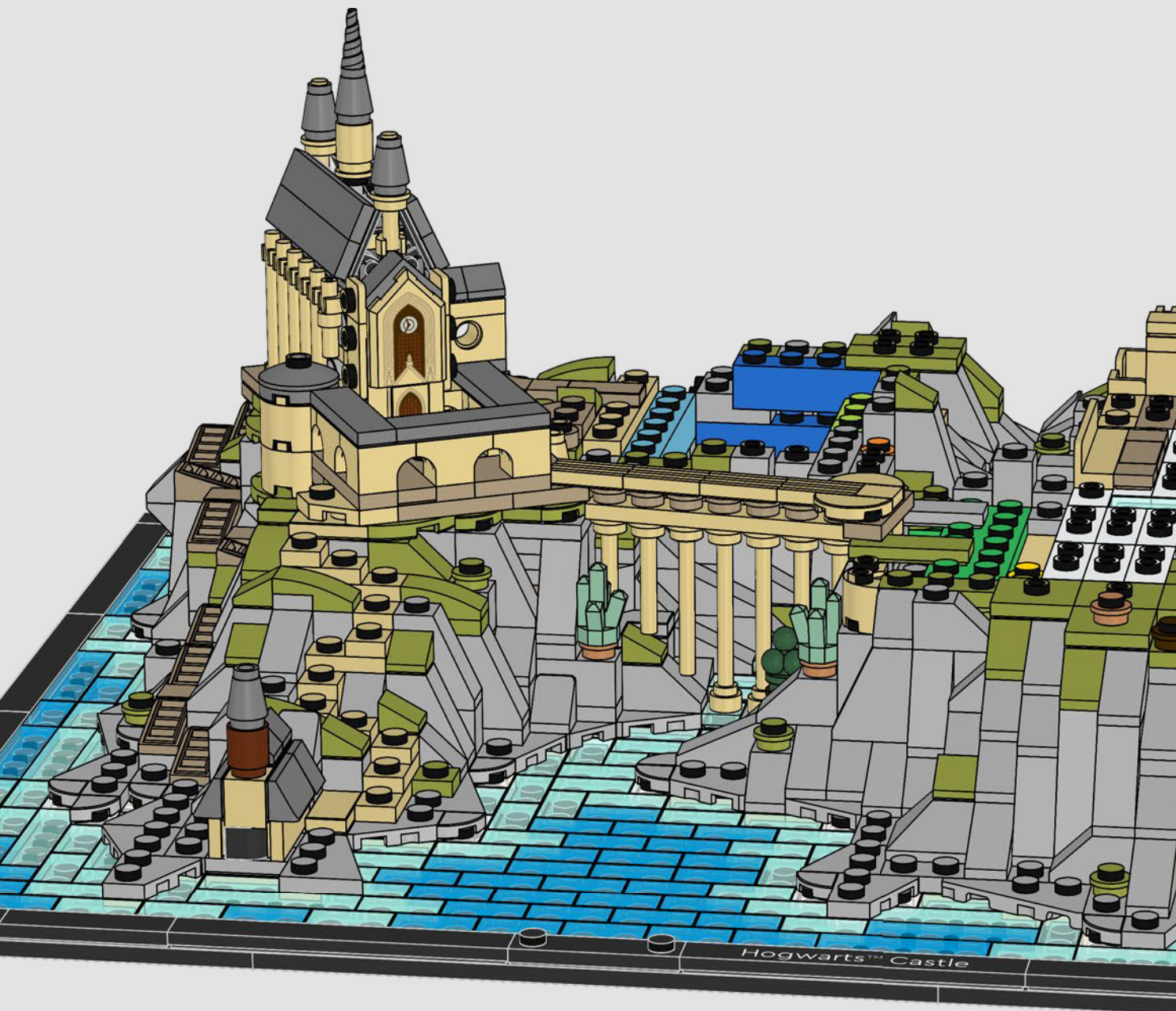

The Viaduct Bridge is not only iconic to the Hogwarts™ silhouette but is the location of a few key moments through the series – when Harry talks with Professor Lupin about his parents, when the Hungarian Horntail chases after Harry in the First Task of the Triwizard Tournament, and when Neville has a shining moment against Scabior in the final battle of Hogwarts.





365







2x

366

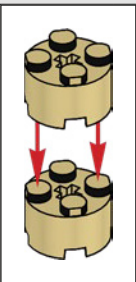
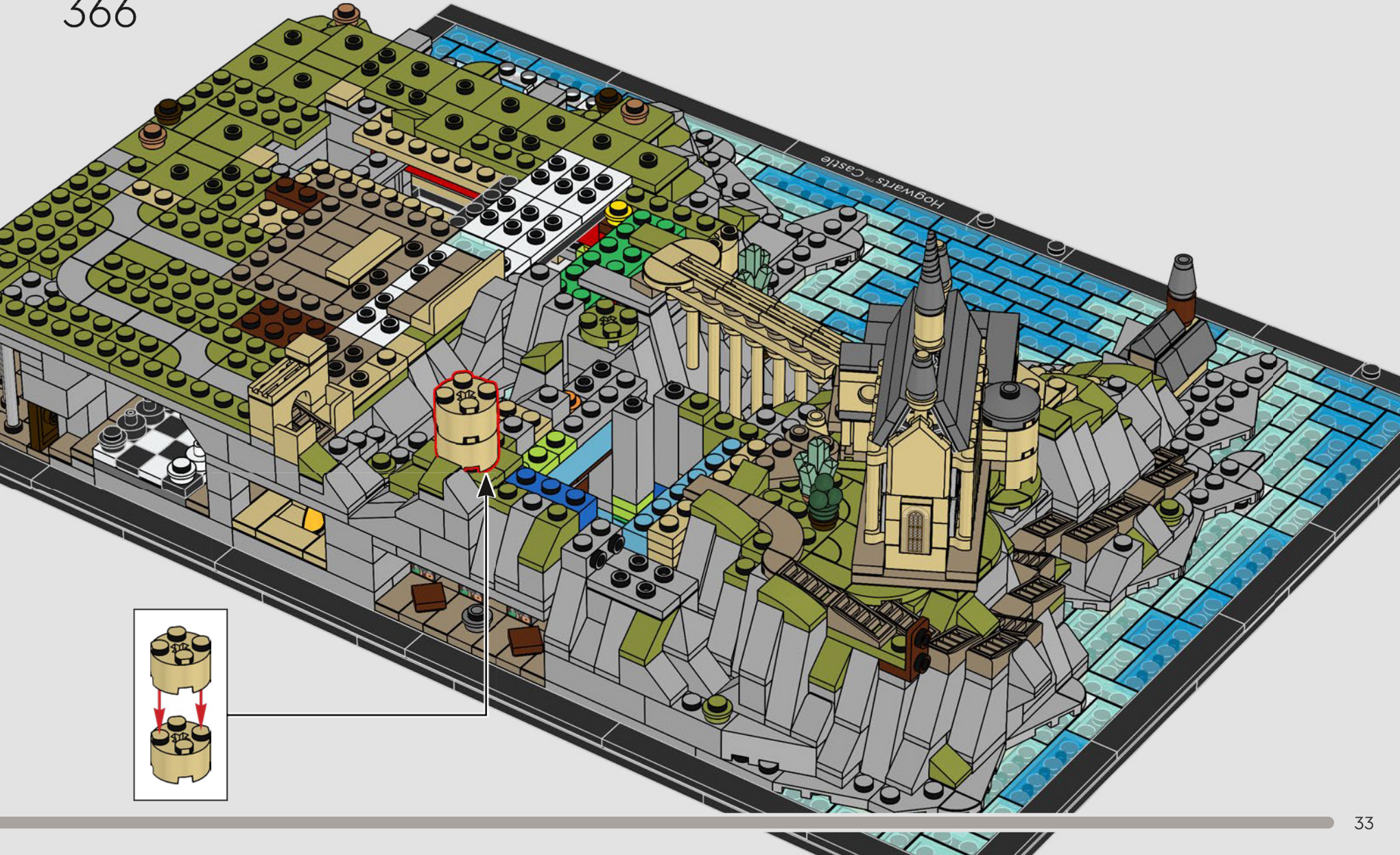

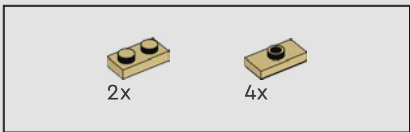

367

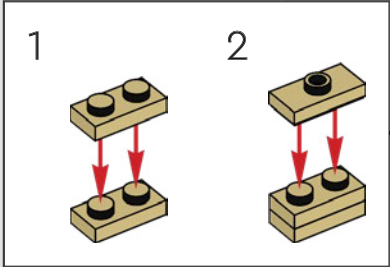
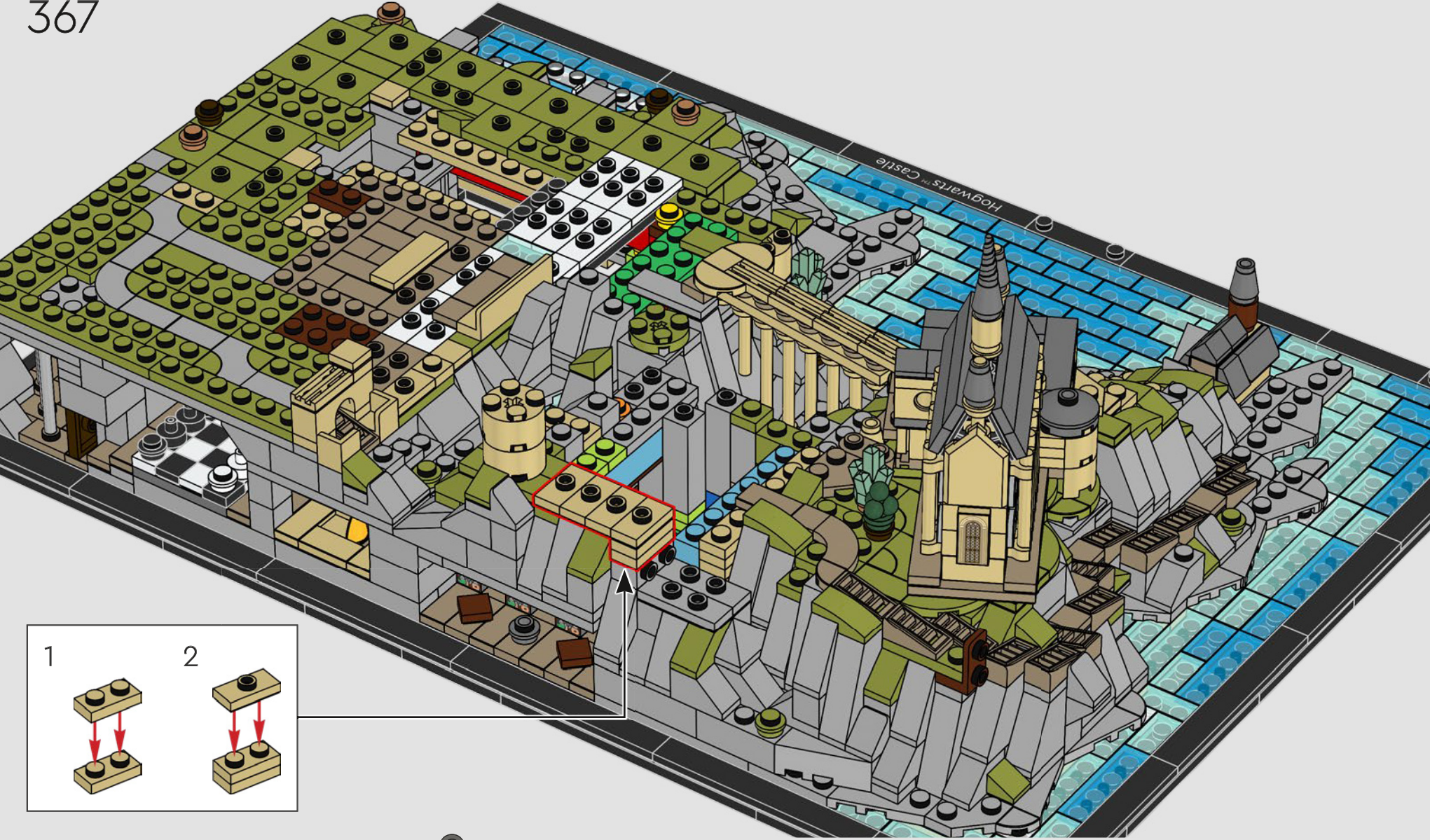

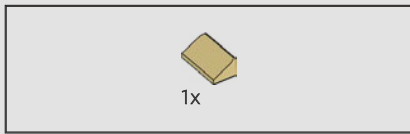

368

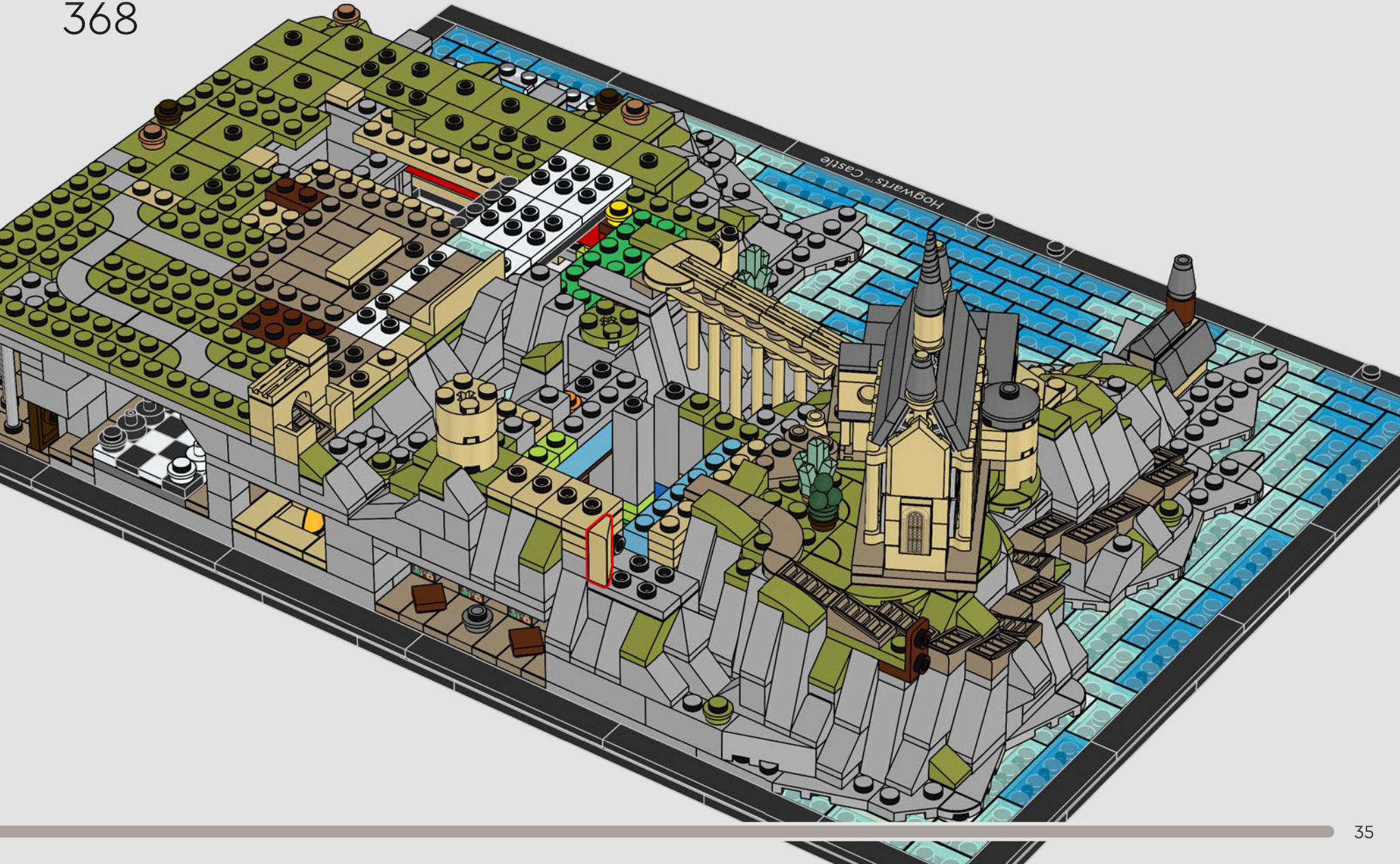

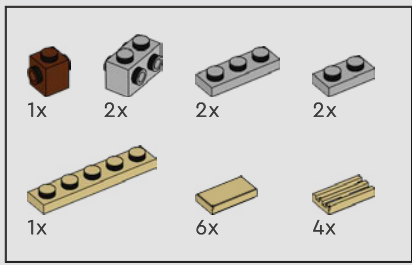

369

1

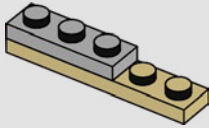

2

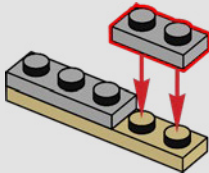

3

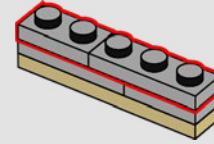

4

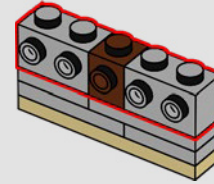

5

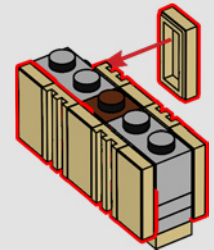

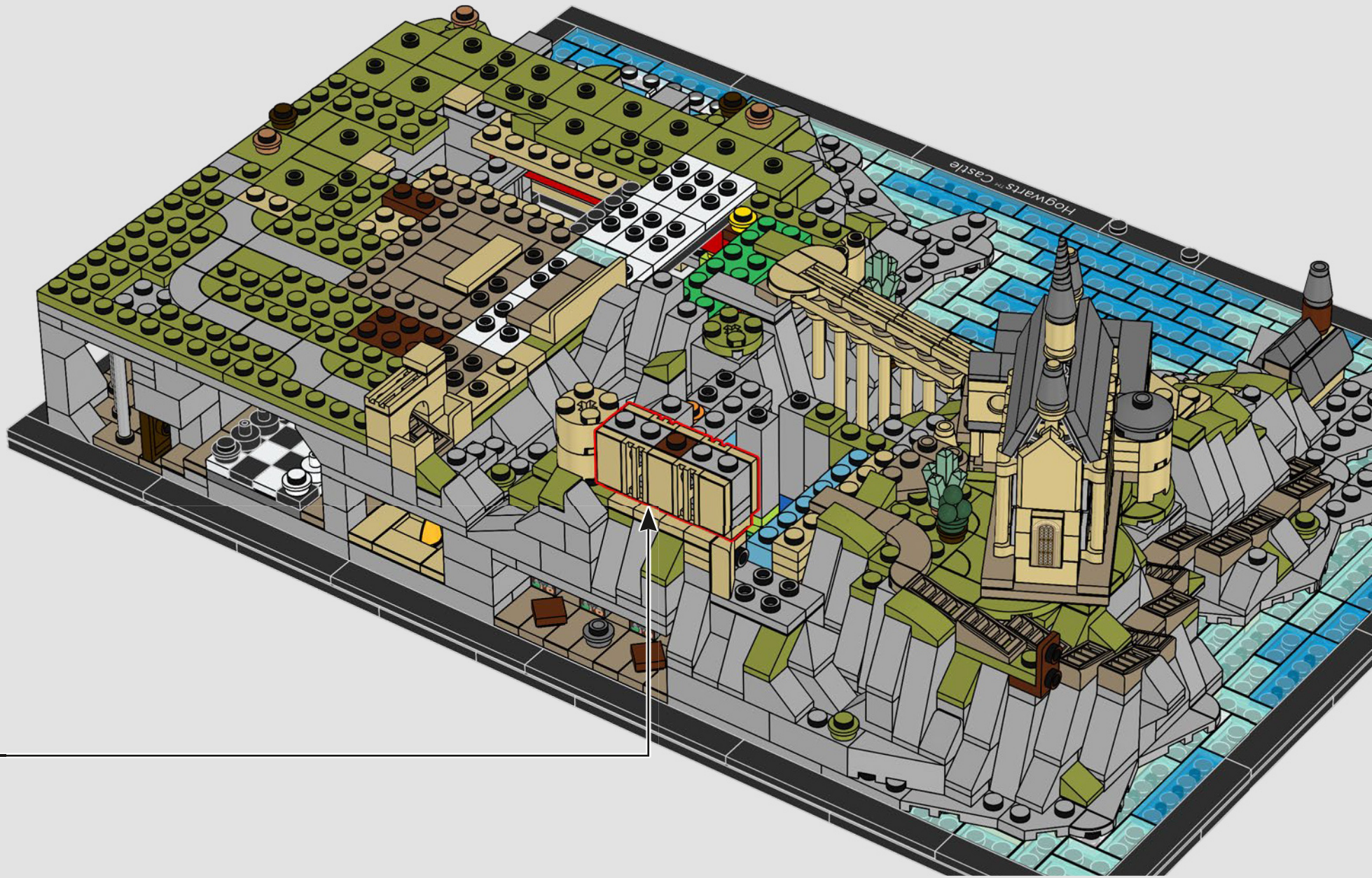

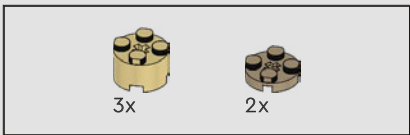

370

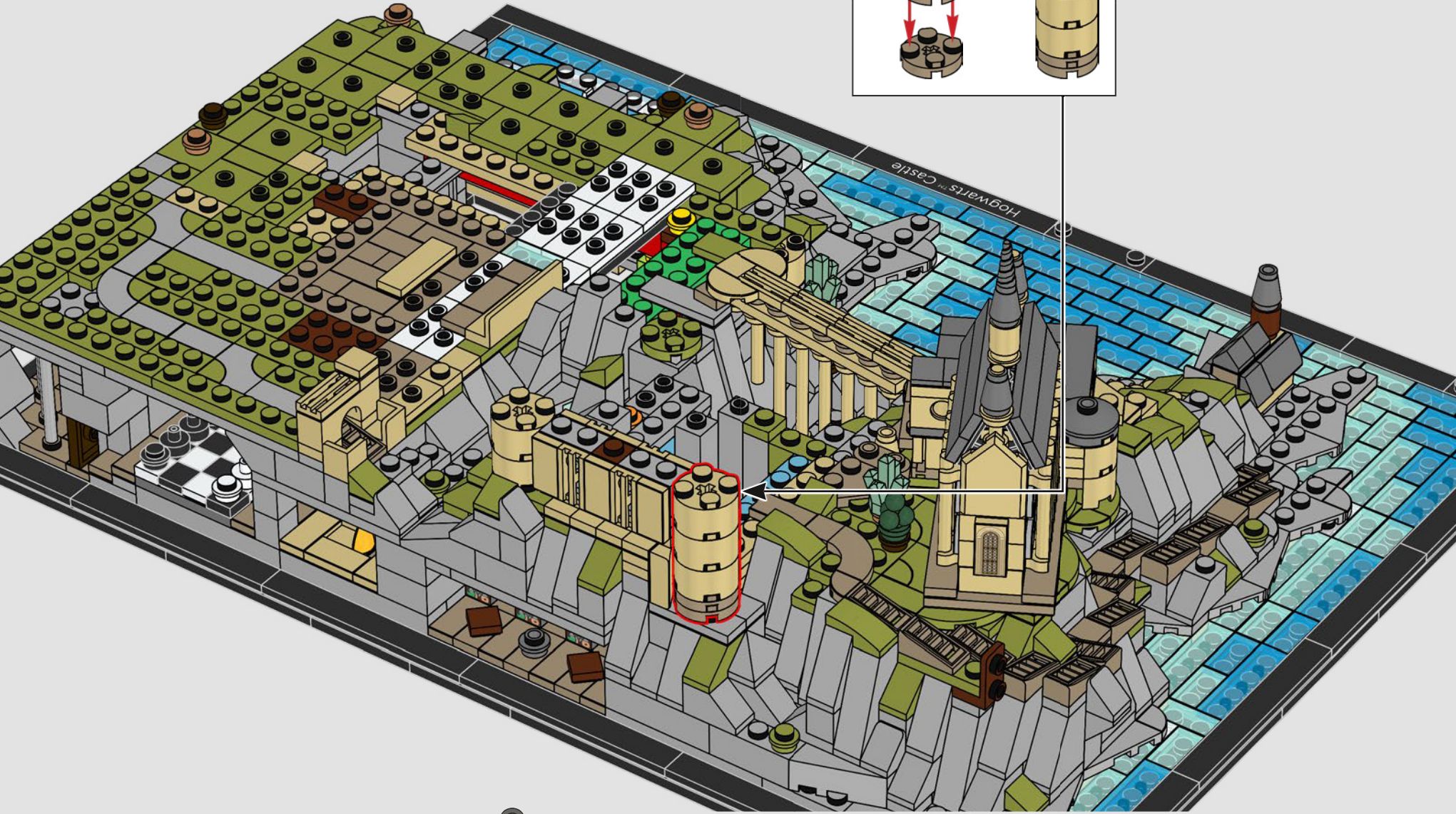
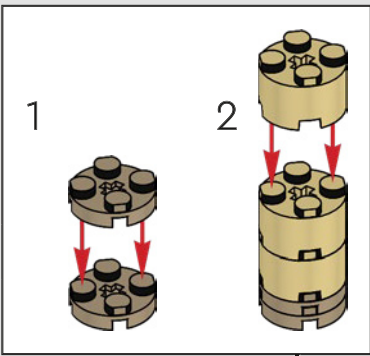

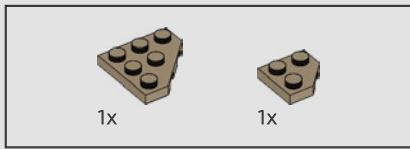

371

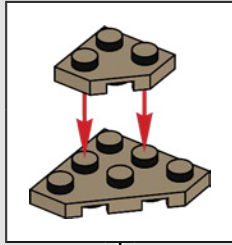

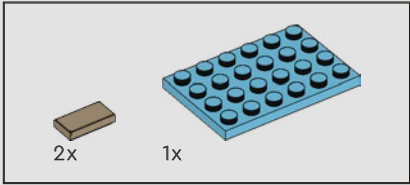
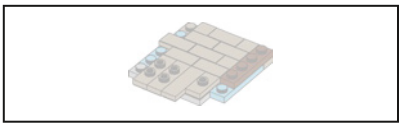

372

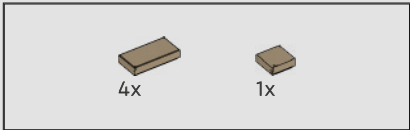
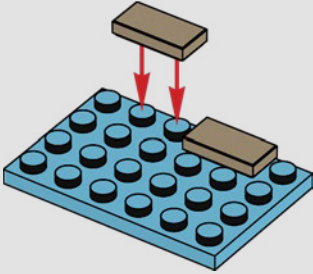

373

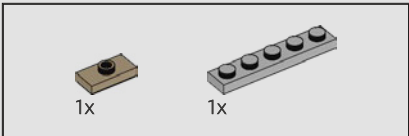
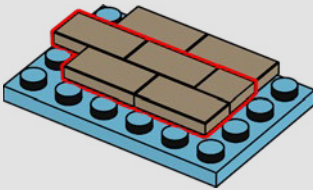

374

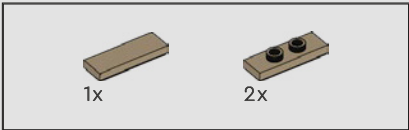
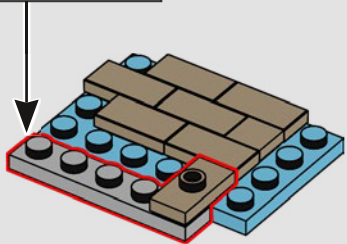
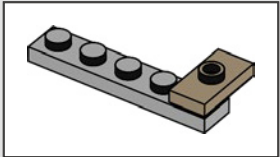

375

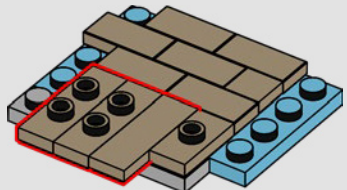



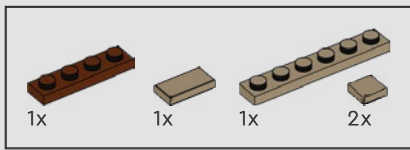

376

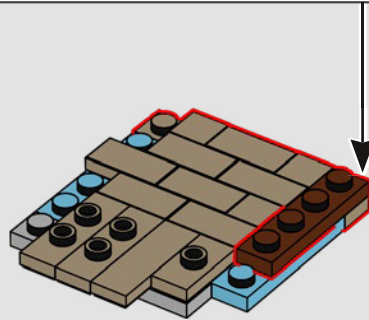
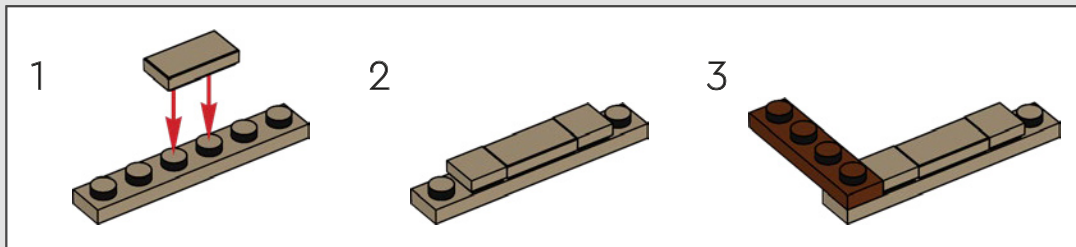

377



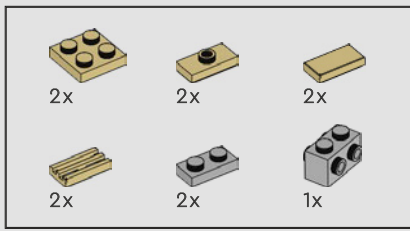

378

1

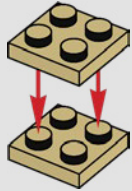

2

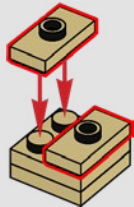

3

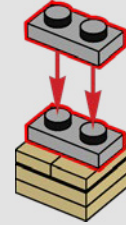

4

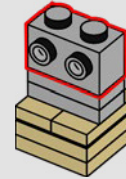

5

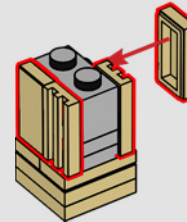



Hogwarts™ Castle

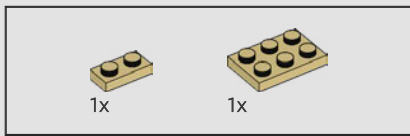

379

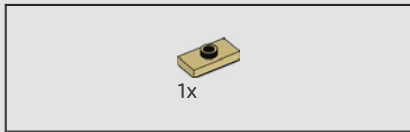
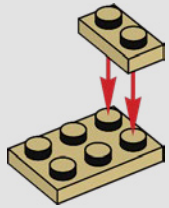

380

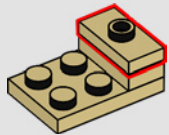

381

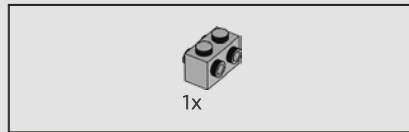
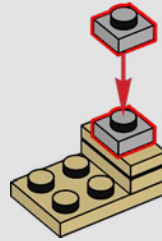

382

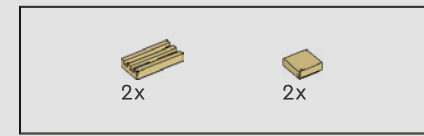
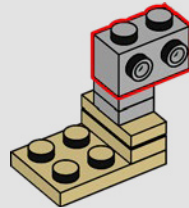

383

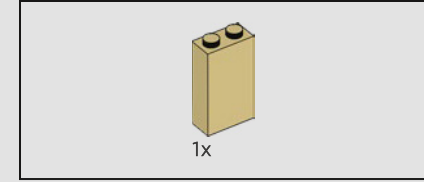
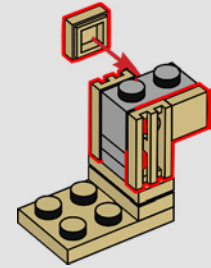

384

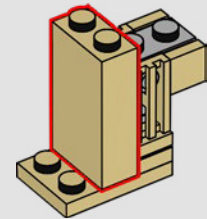

385

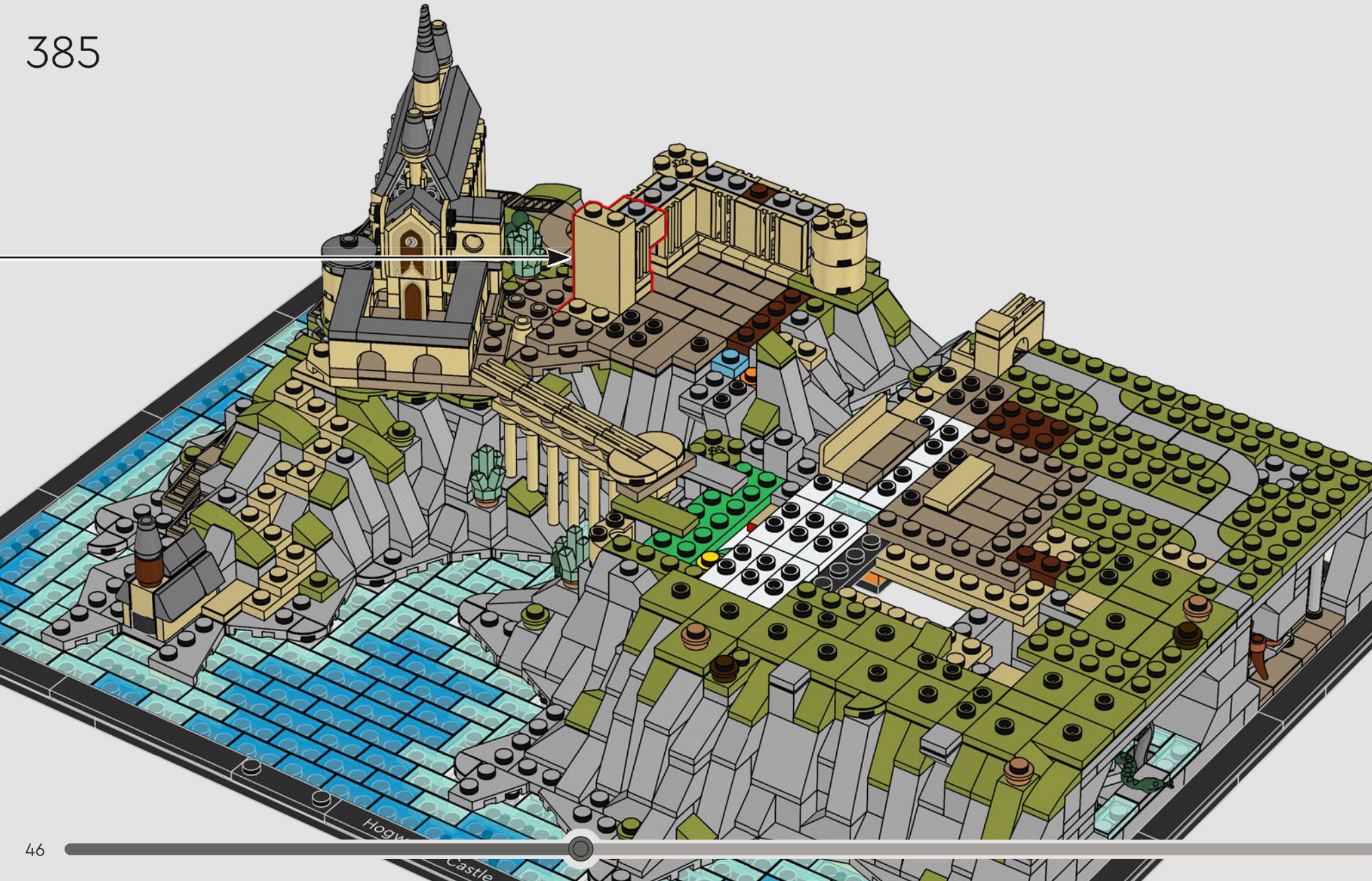

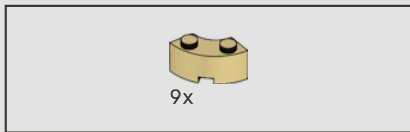

386

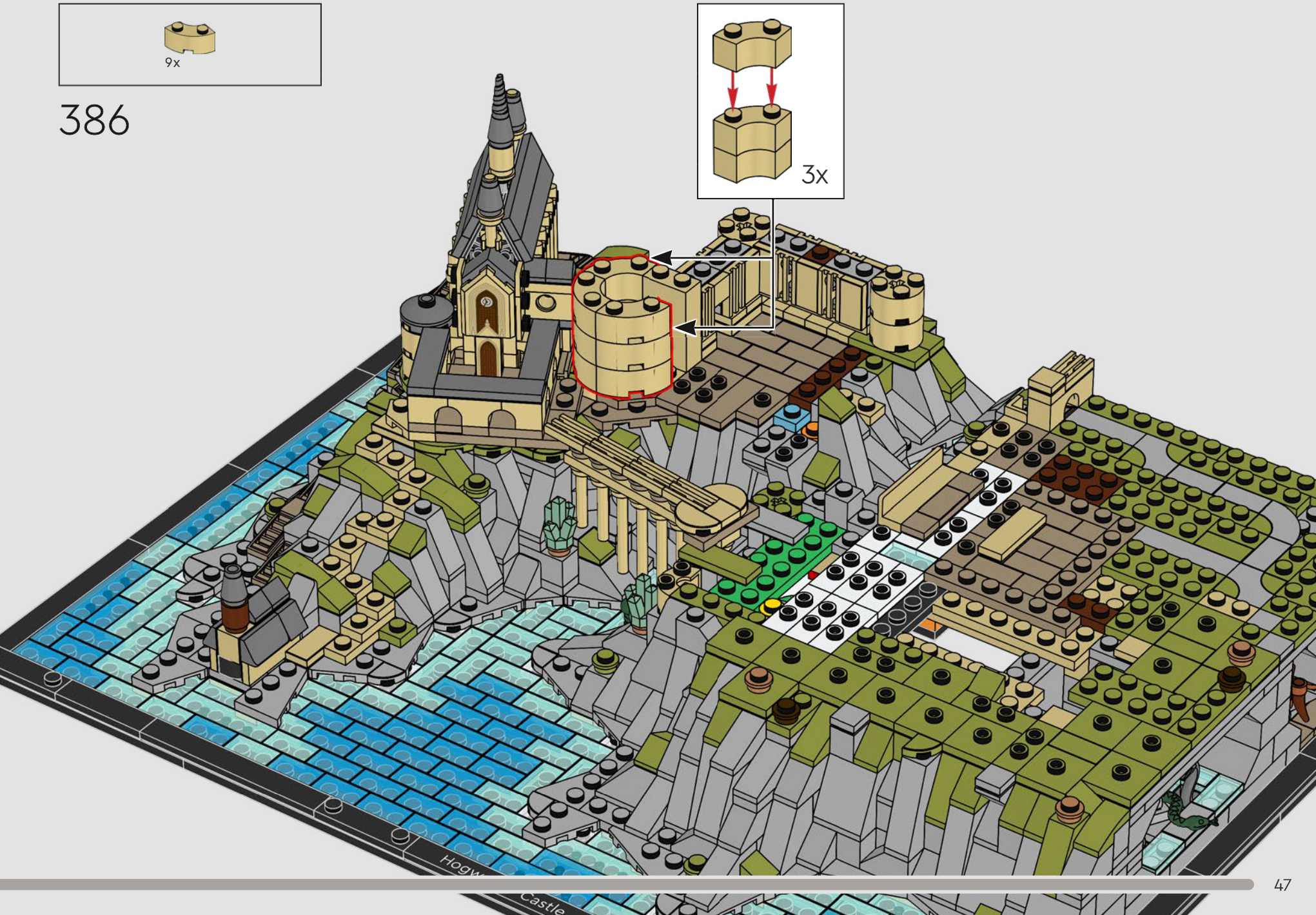
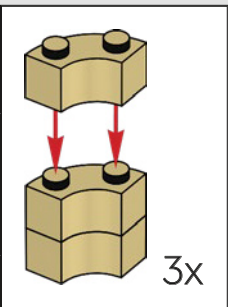

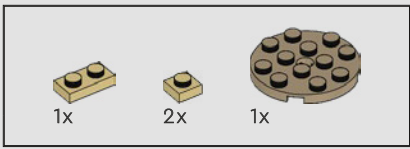

387

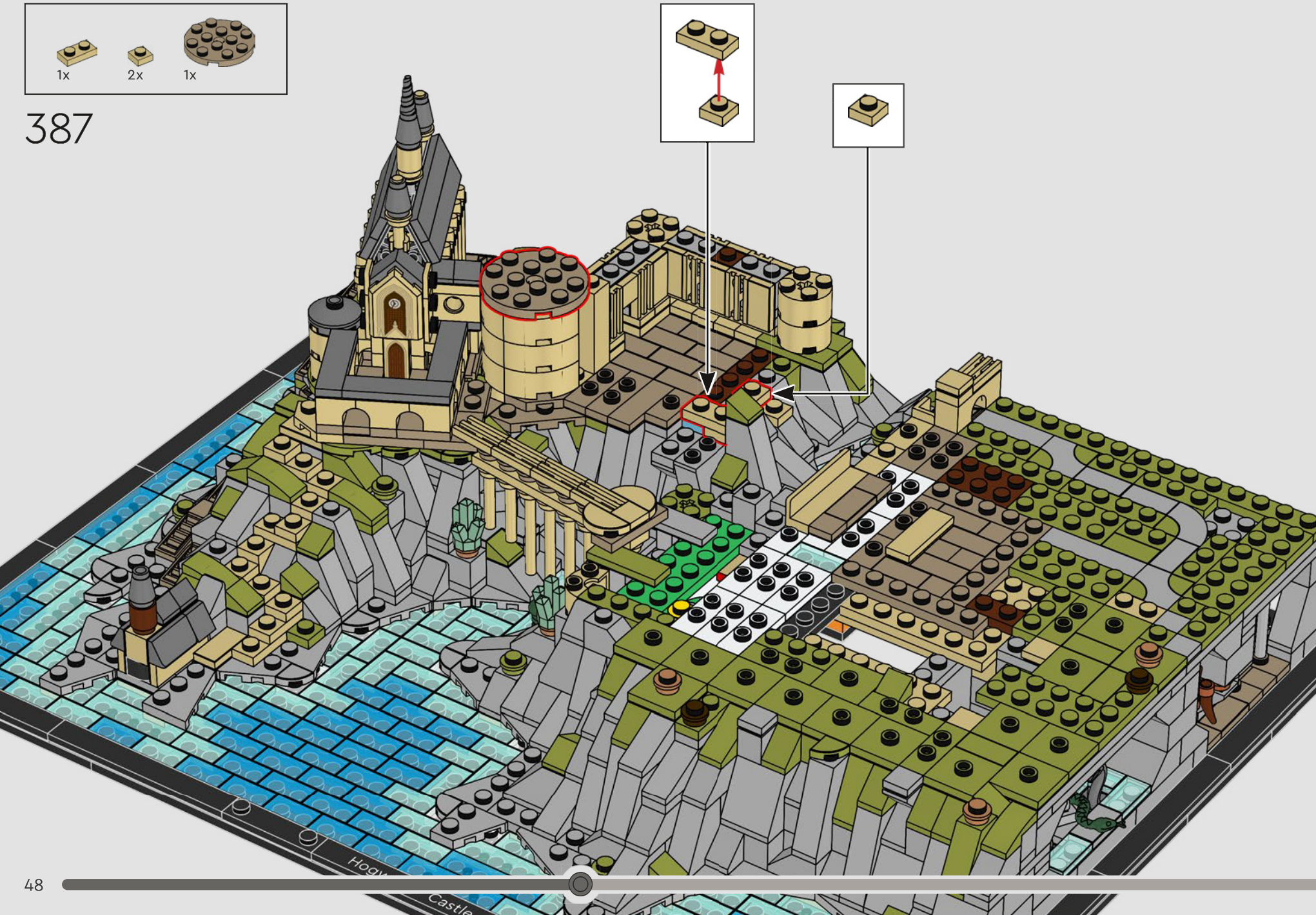
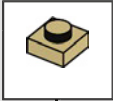
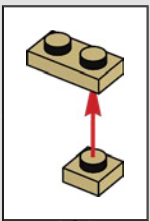



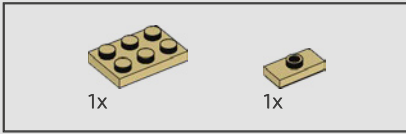
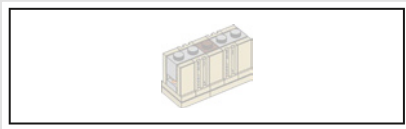

388

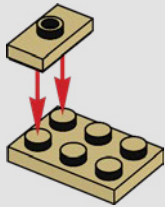

389

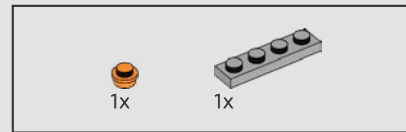
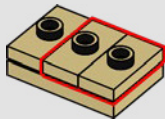

390

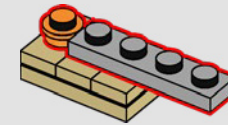

391

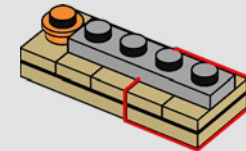
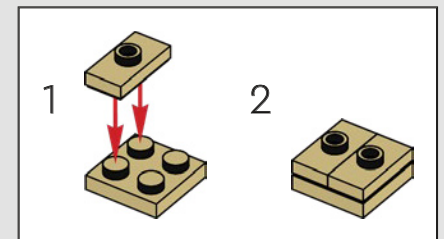

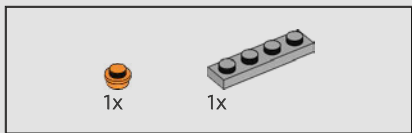

392

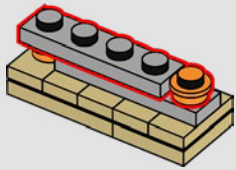

393

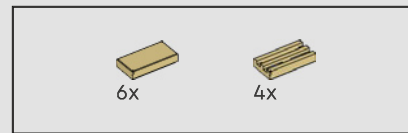
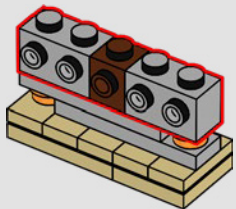

394

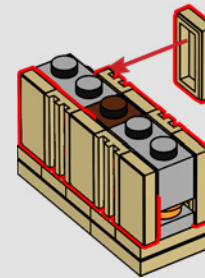

395

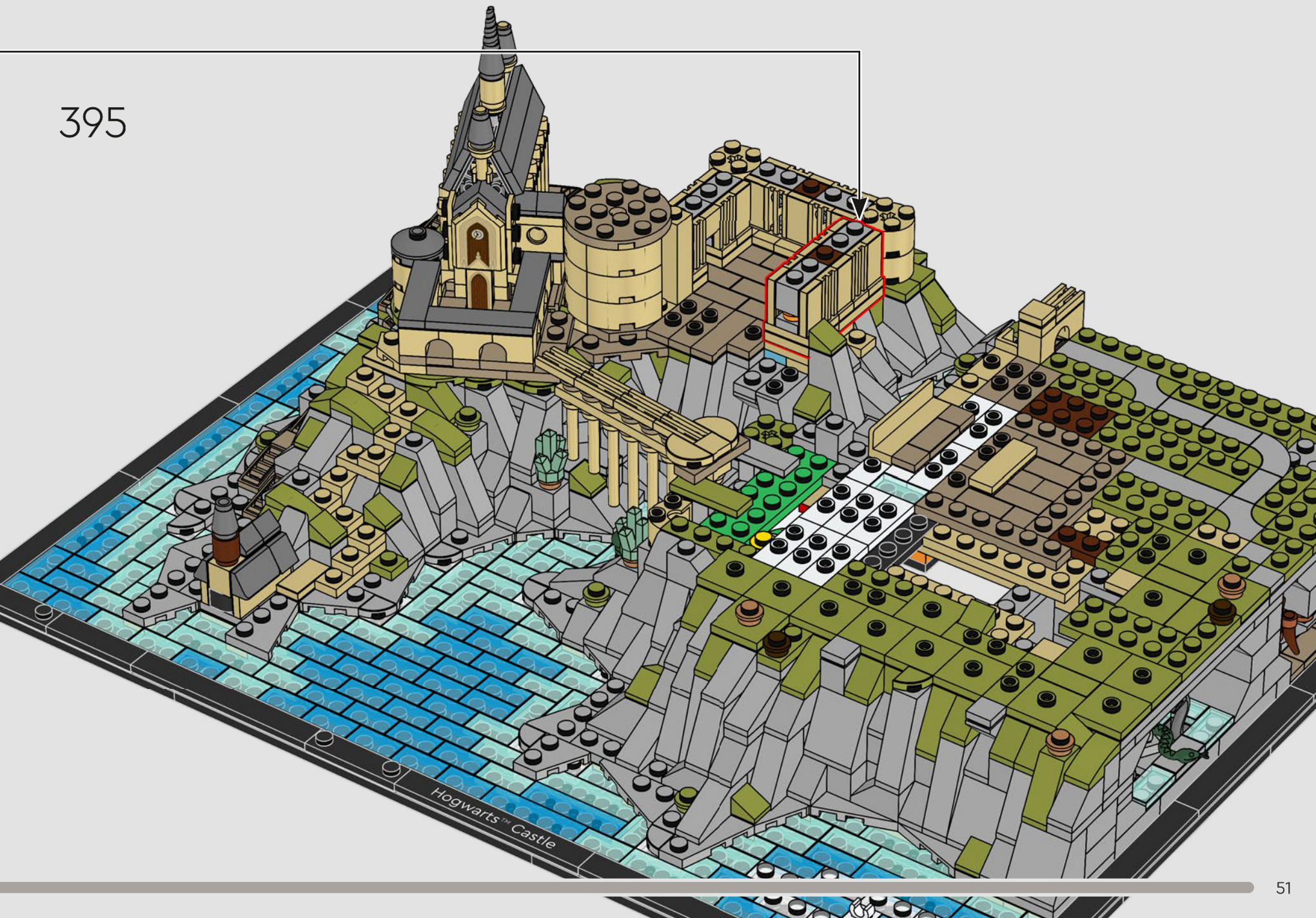

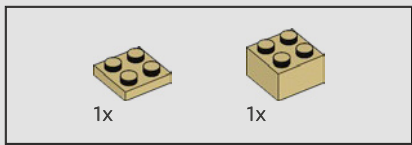

396

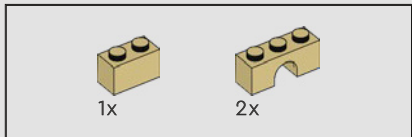
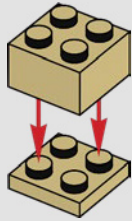

397

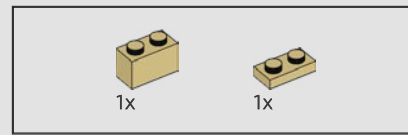
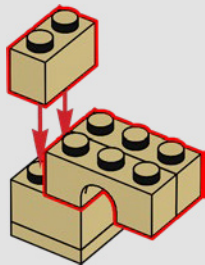

398

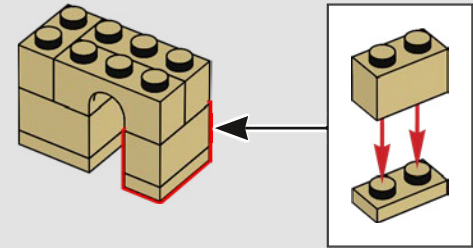

399

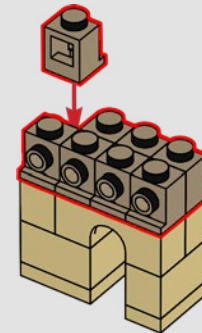

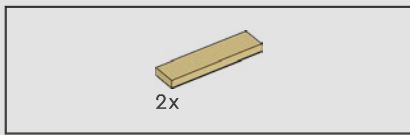

400

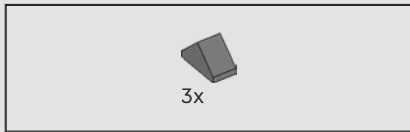
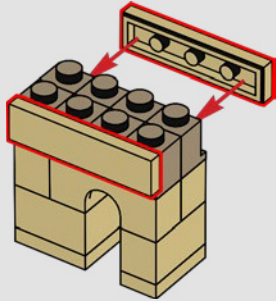

401

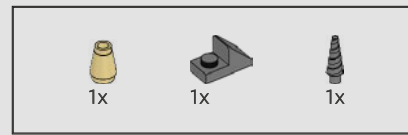
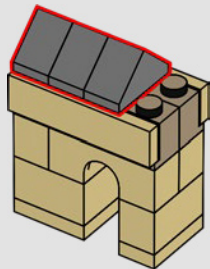

402

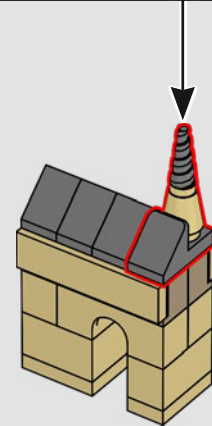
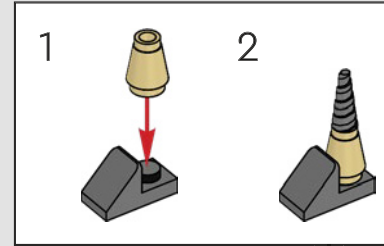

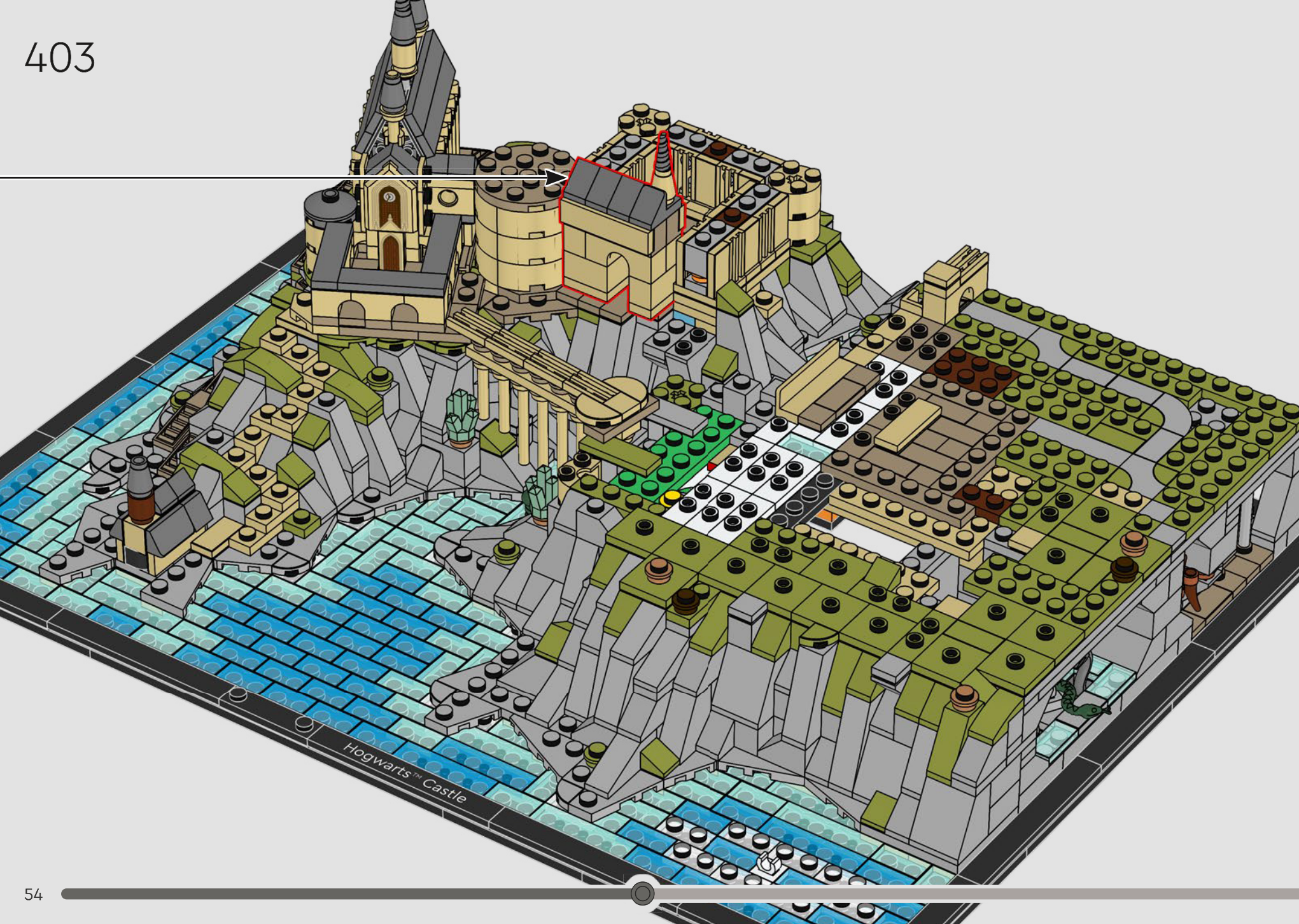

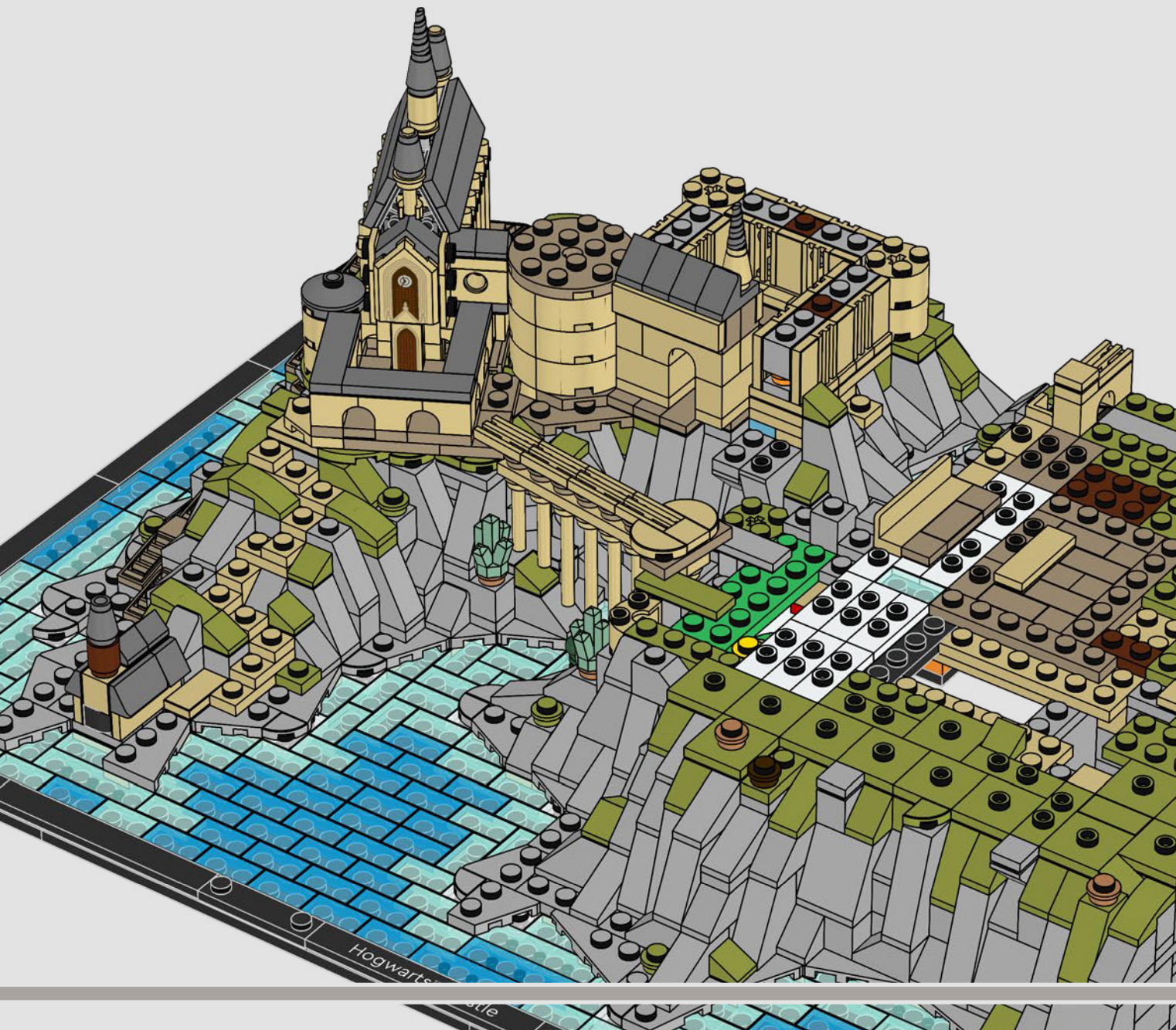

The Quad is the home to some emotional moments – to name a few, Harry's joy when he first flies his new broomstick, and his heartbreak when Sirius needs to go into hiding.

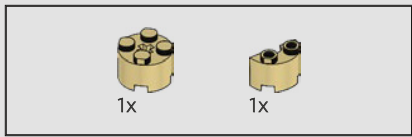

404

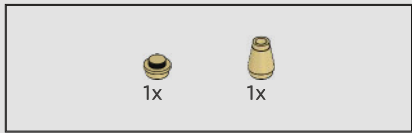
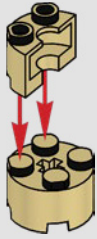

405

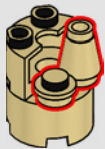

406

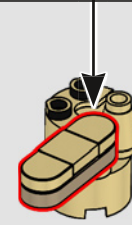
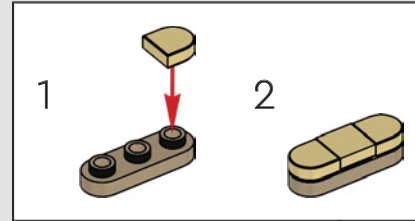

407

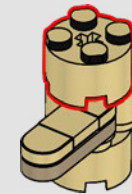



408







409

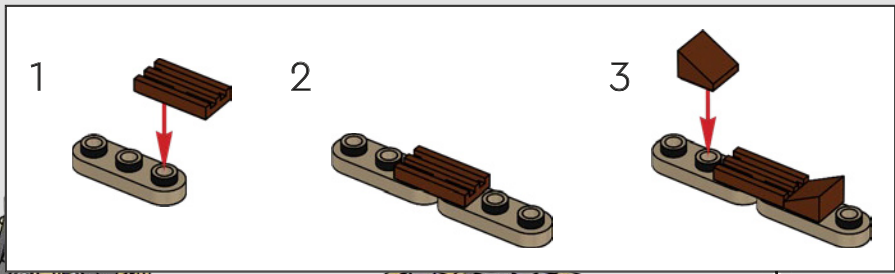



410

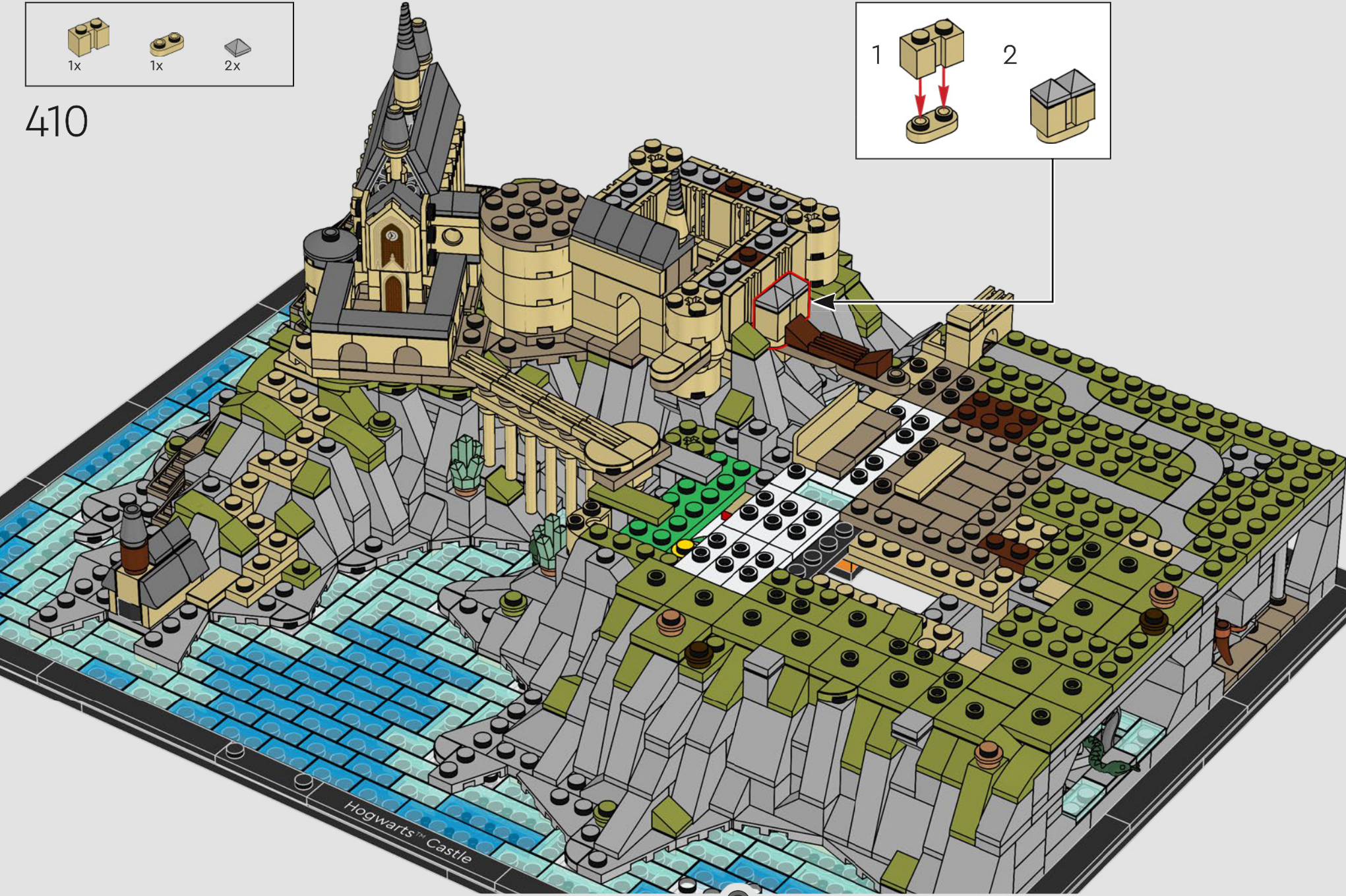
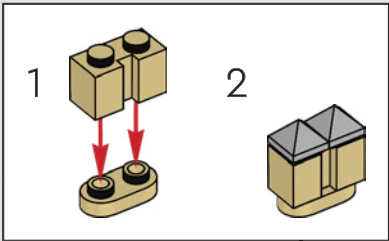

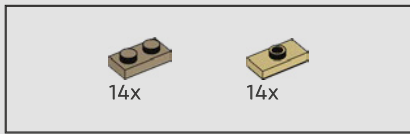

411

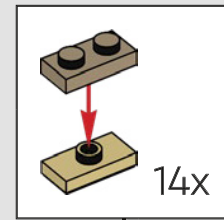

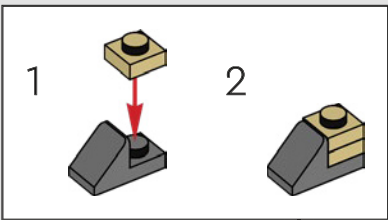
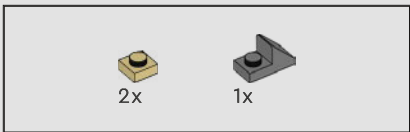

412

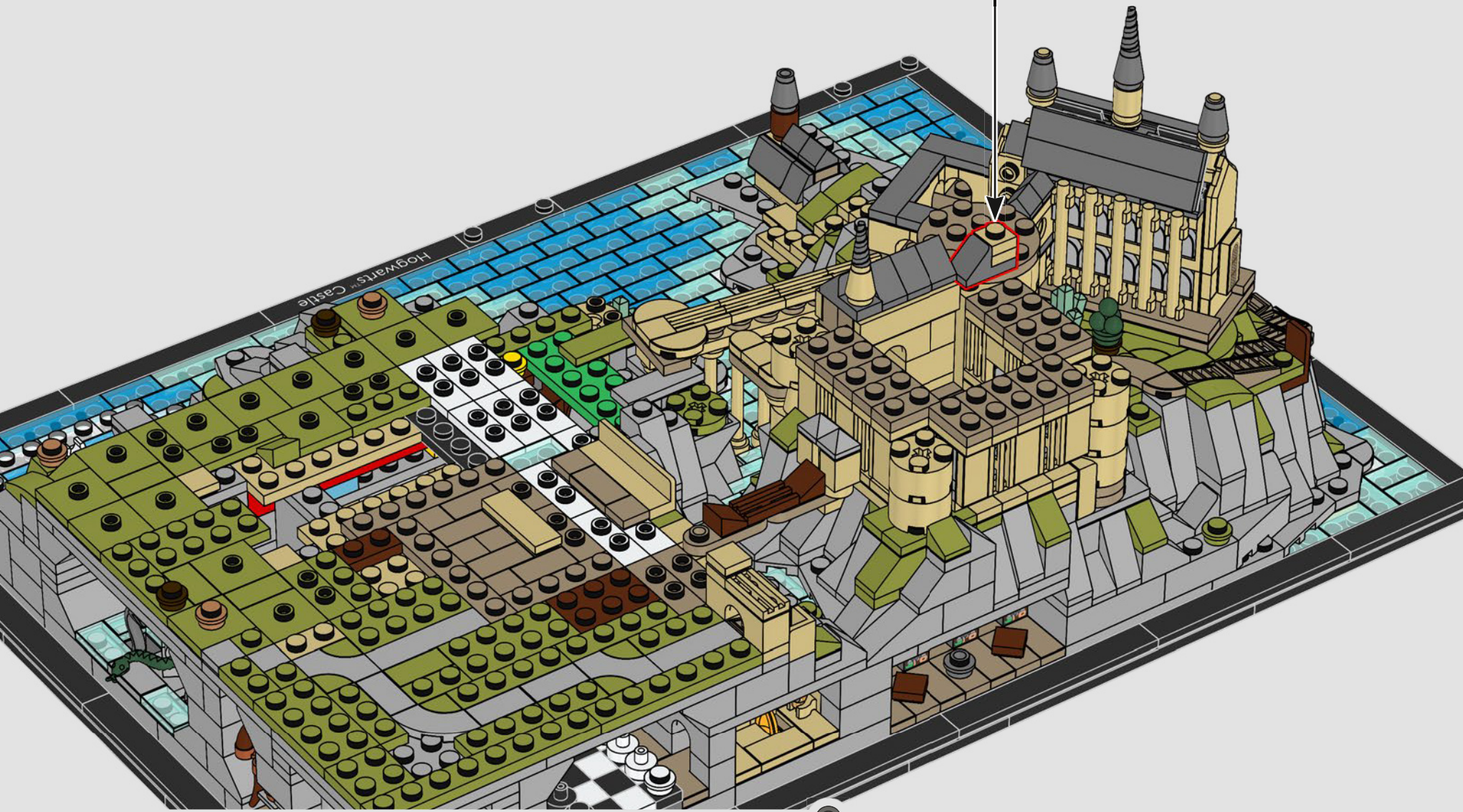

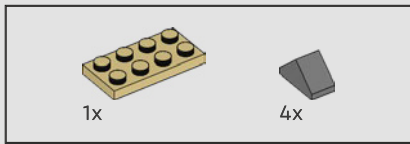

413

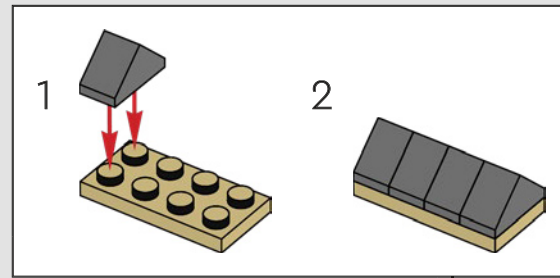

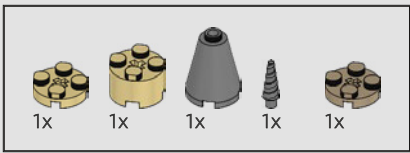

414

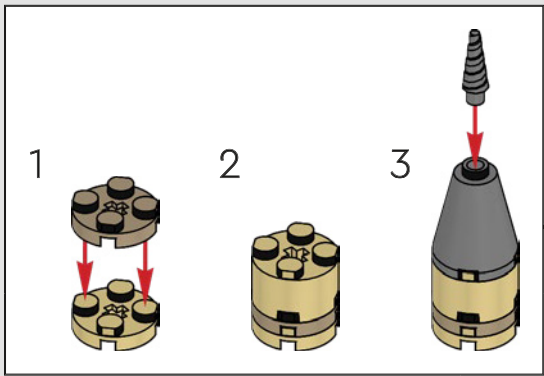



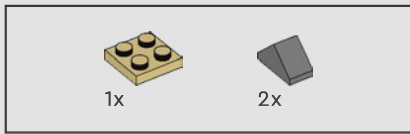

415

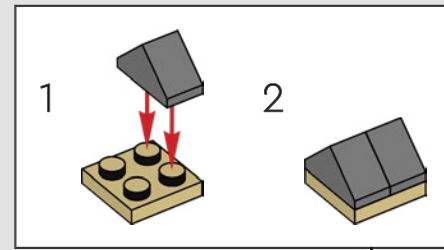

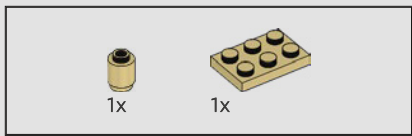

416

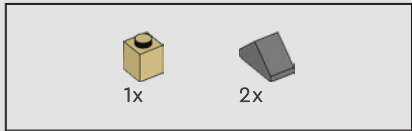
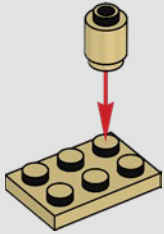

417

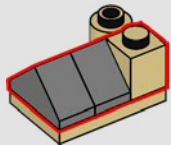

418

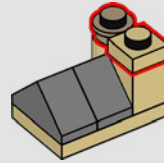

419

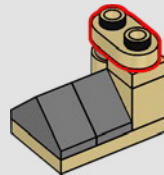

420

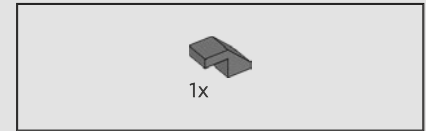
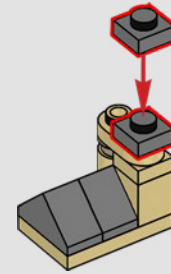

421

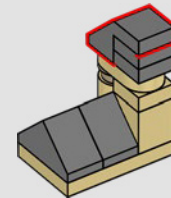

422

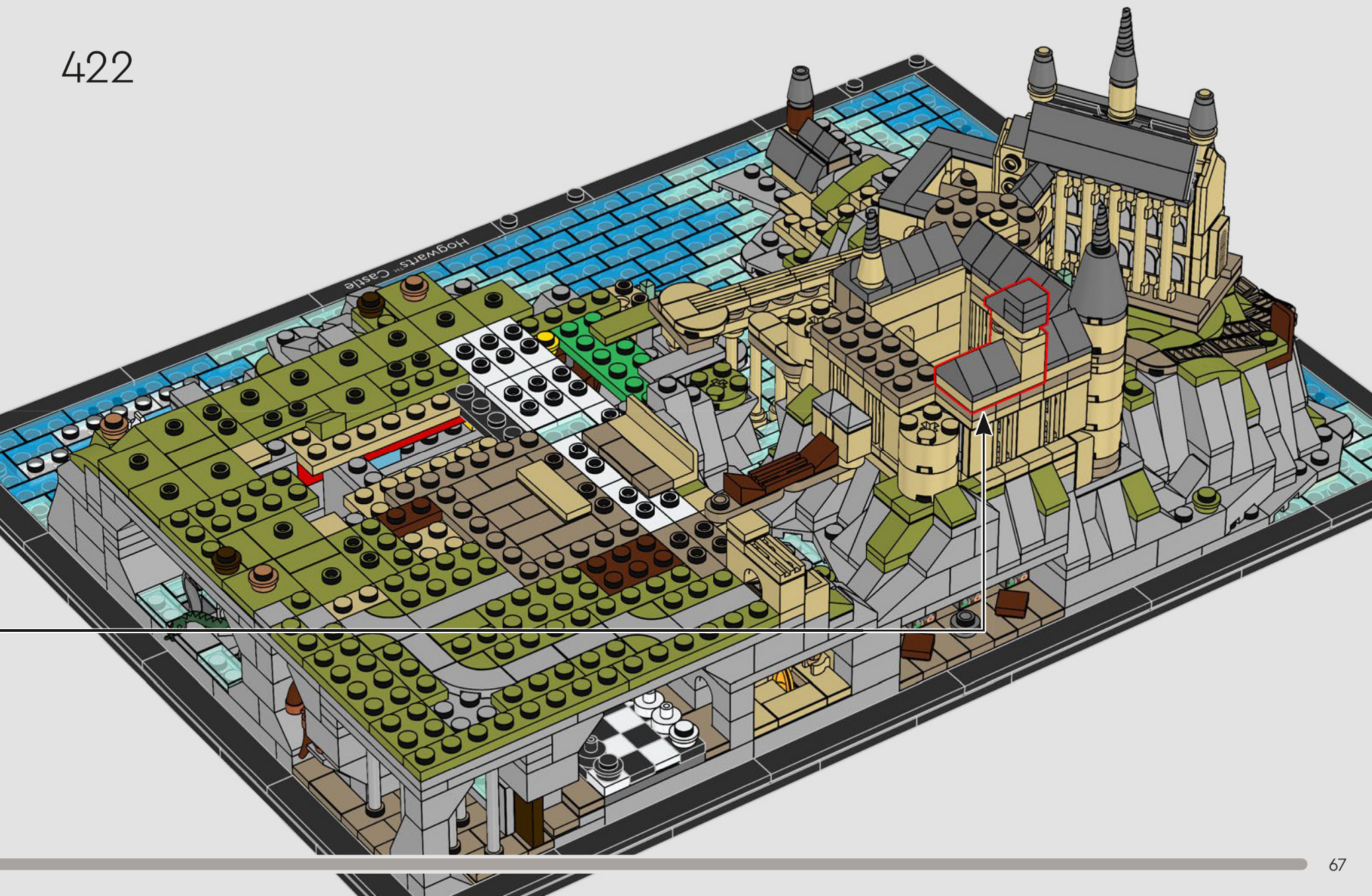

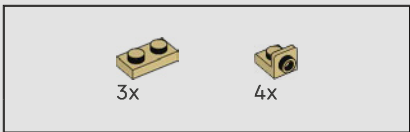

423



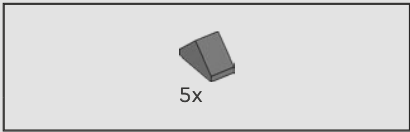

424



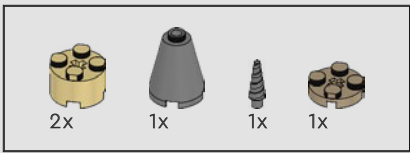

425

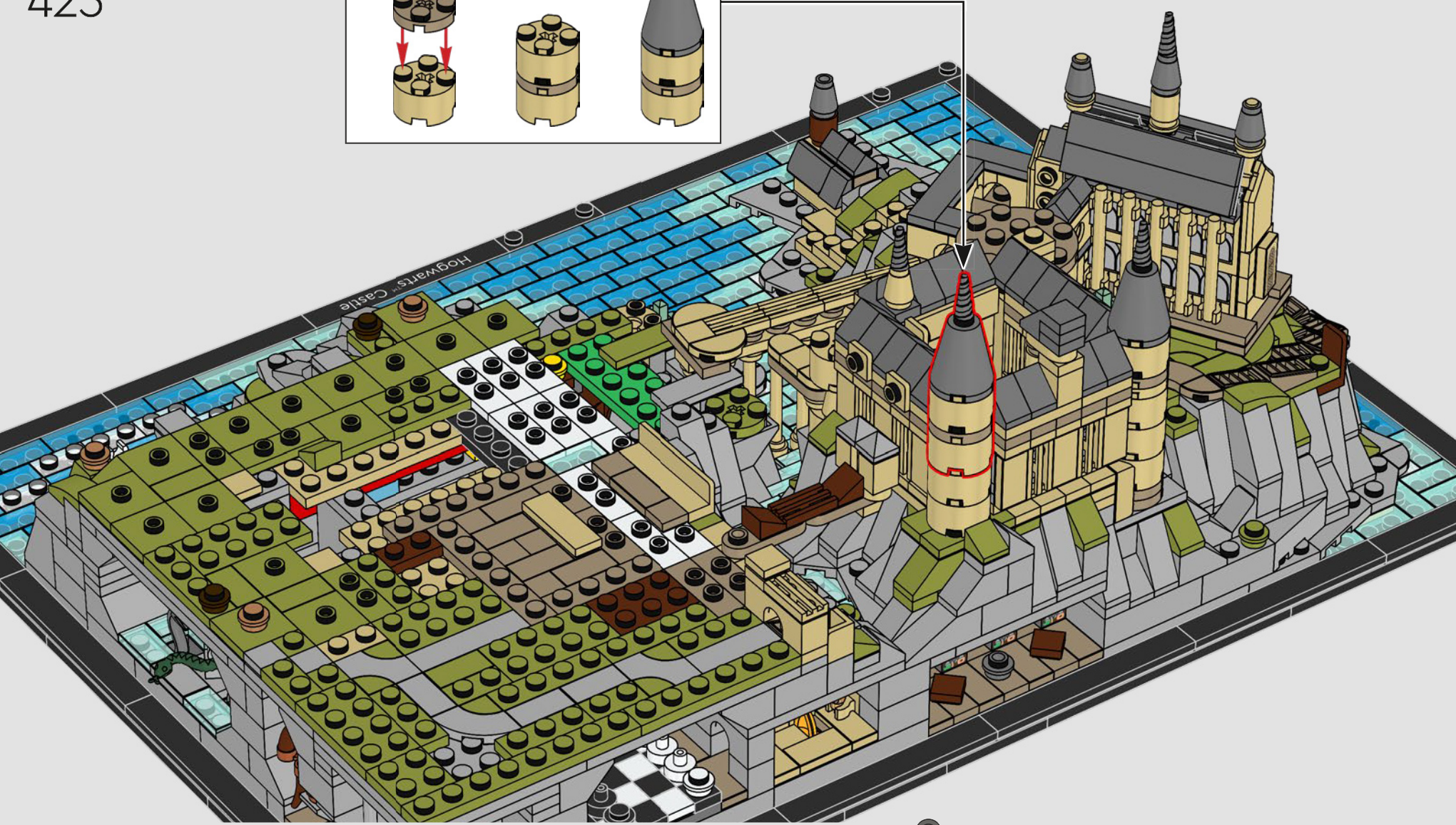
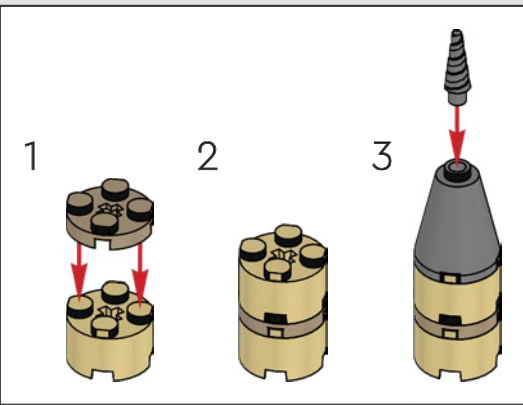

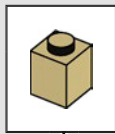
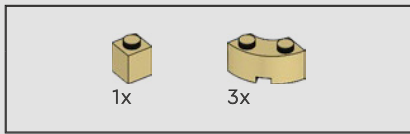

426

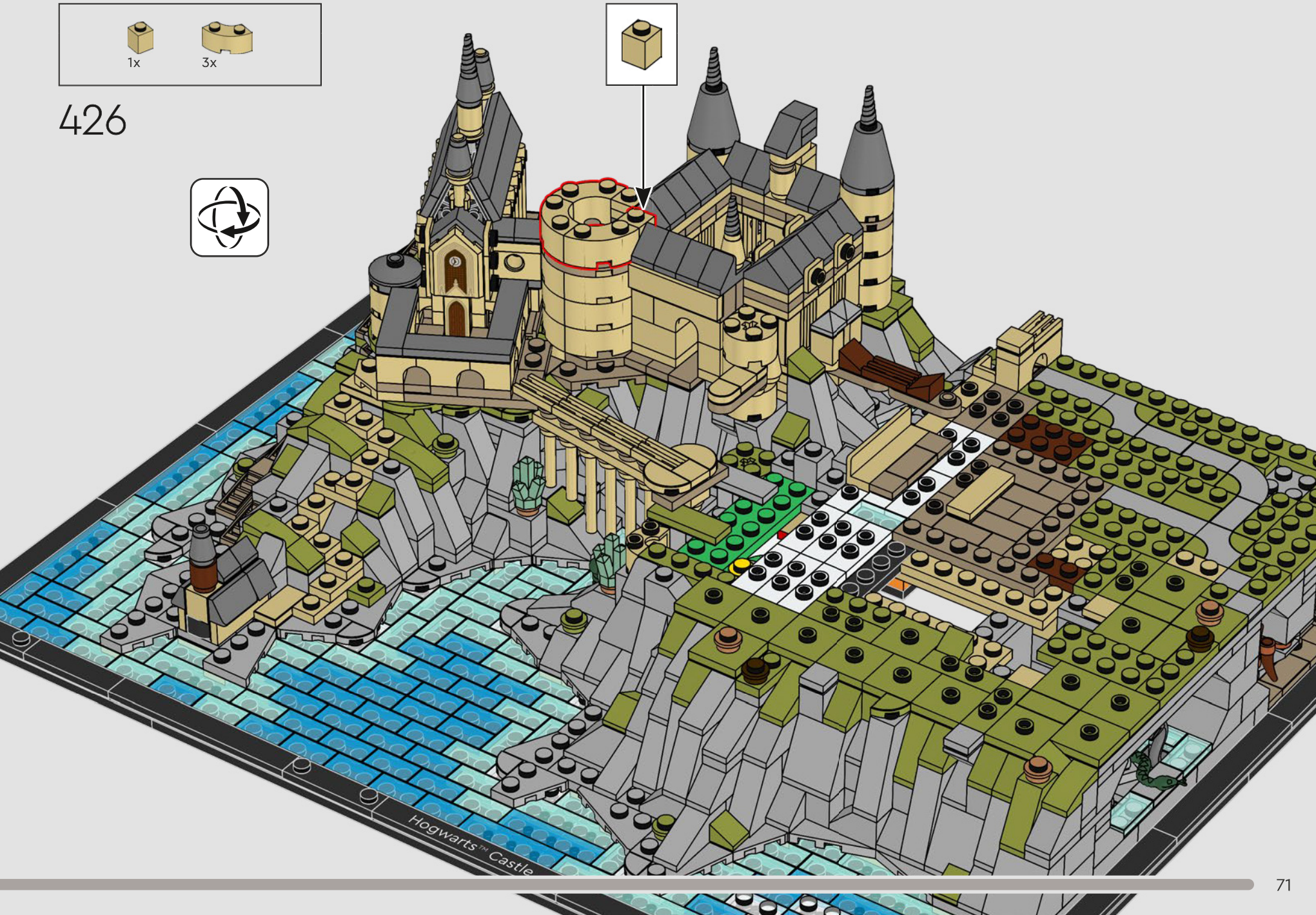

Hogwarts™ Castle

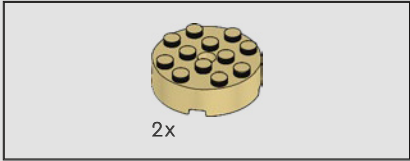
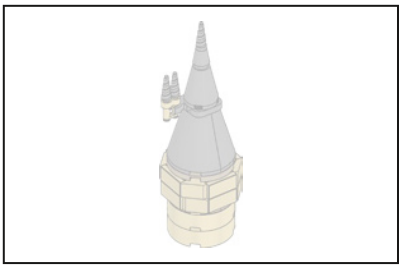

427

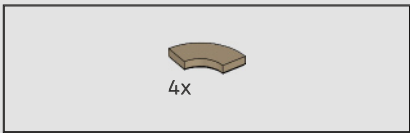
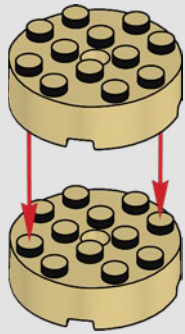

428

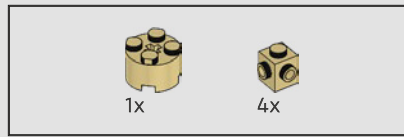
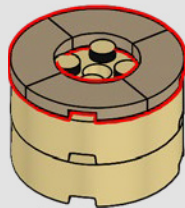

429

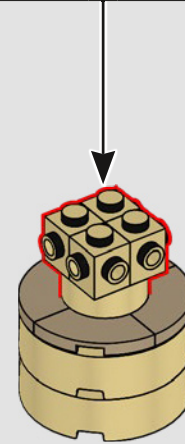
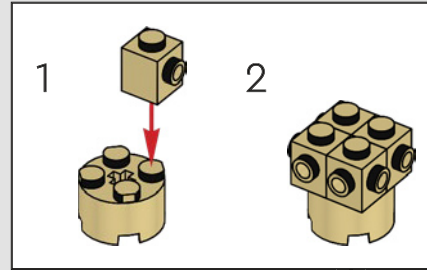



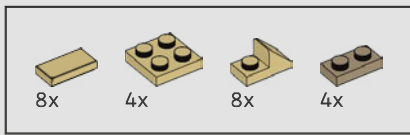

430

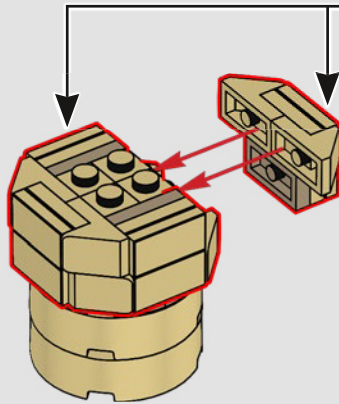
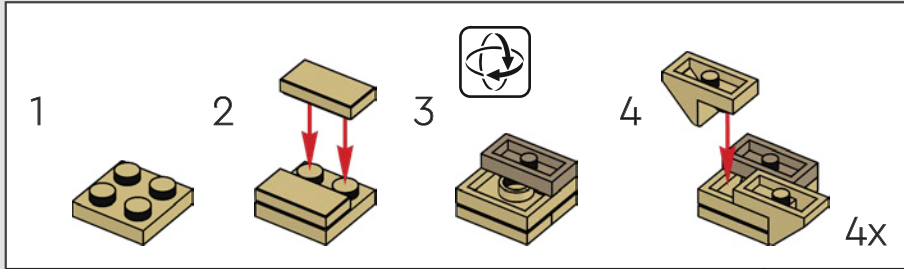

431

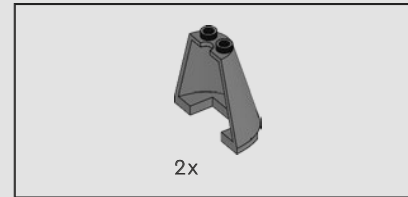
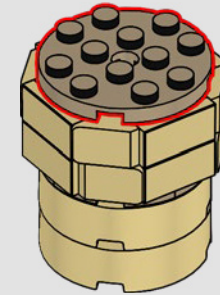

432

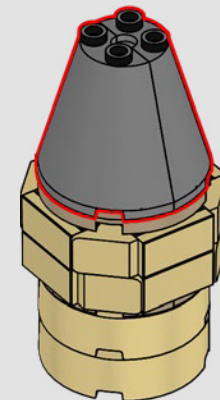

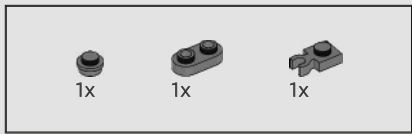

433

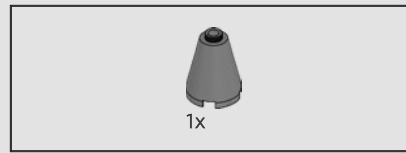
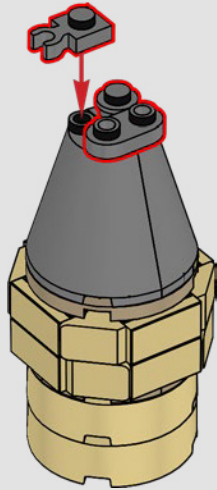

434

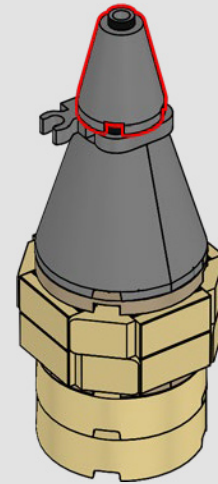

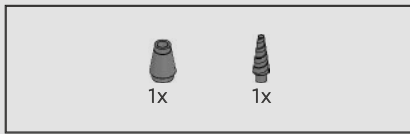

435

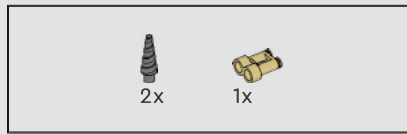
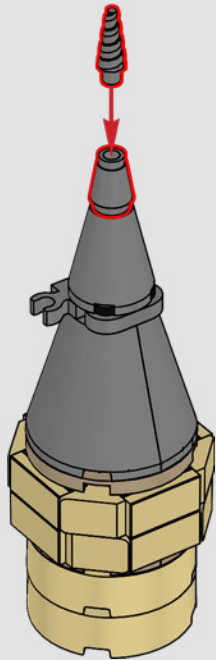

436

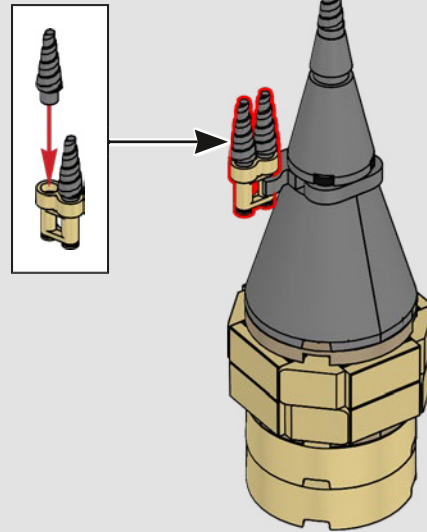

The office of Albus Dumbledore™, the small towers on the main tower, is built with a LEGO® telescope element.



437

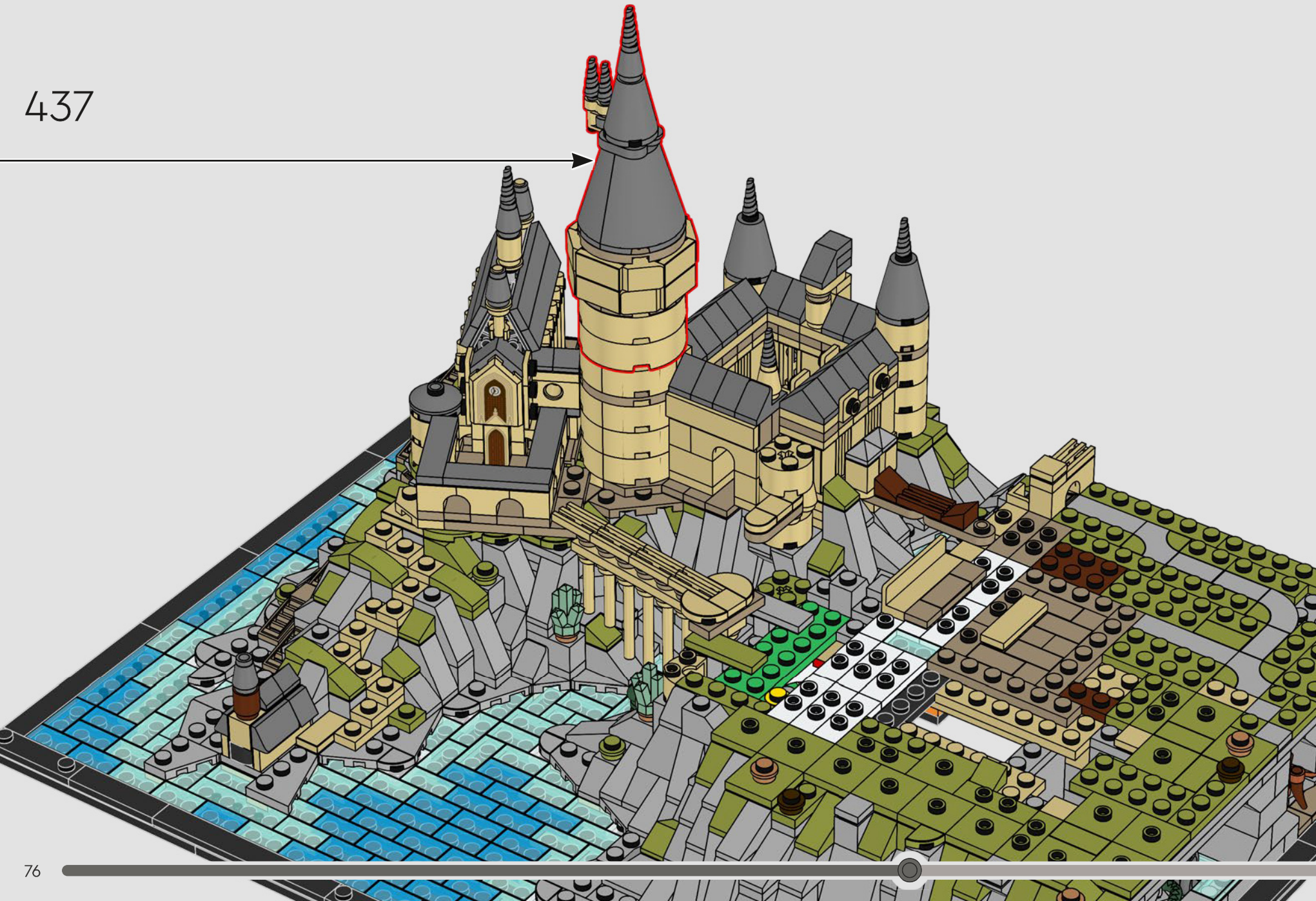

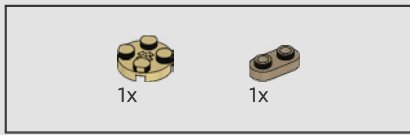

438

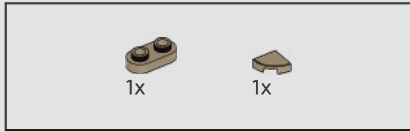
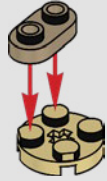

439

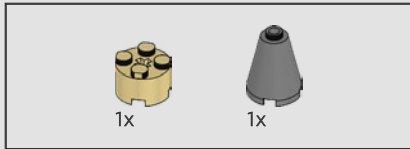
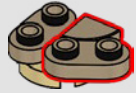

440

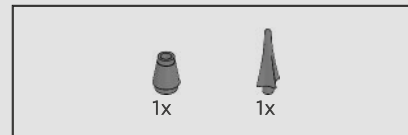
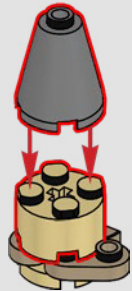

441

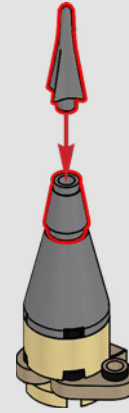

442

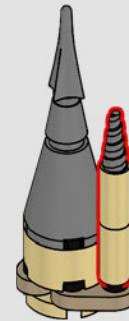
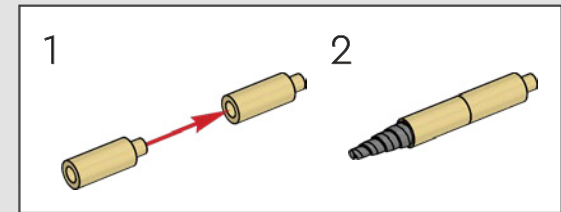

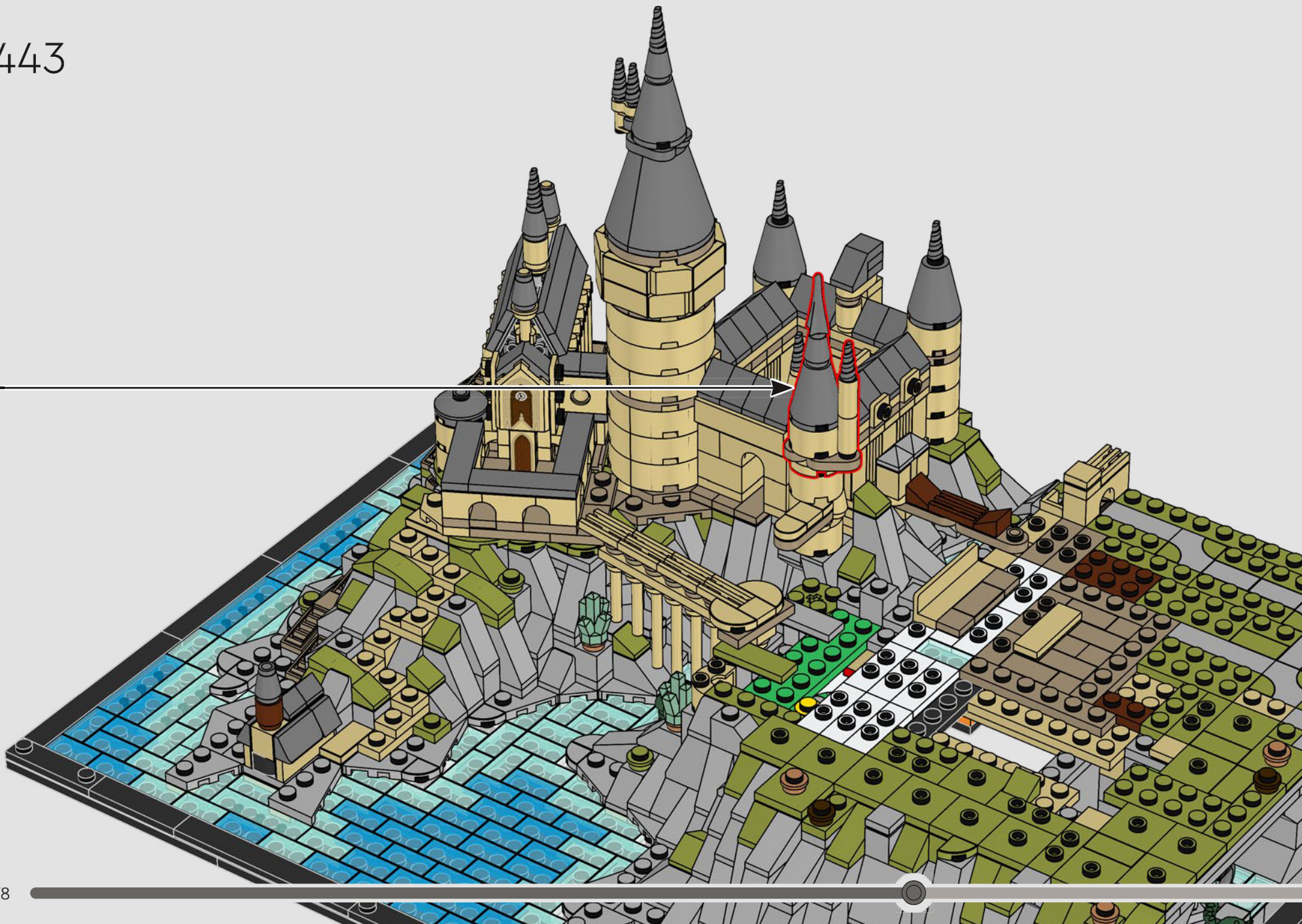



You wouldn't think the sprouting towers on the Headmaster's Tower could be an architecturally sustainable structure – but of course, at Hogwarts™ everything is possible!





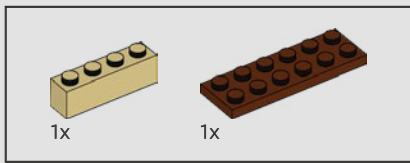

444

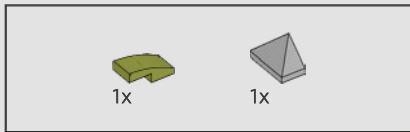
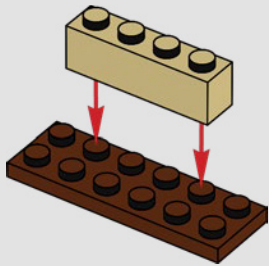

445

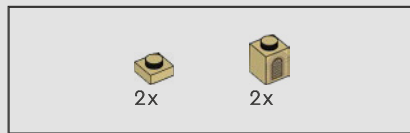
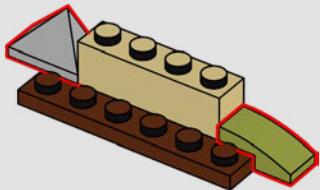

446

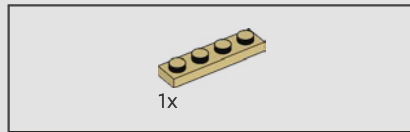
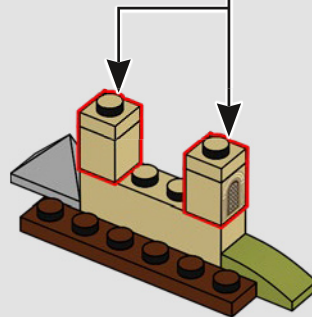
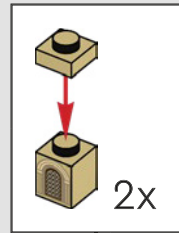

447

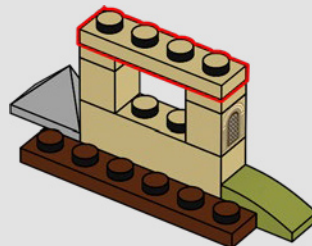

448

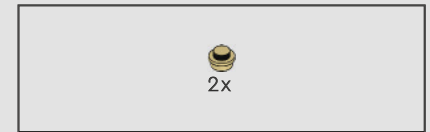
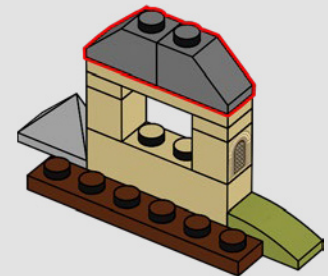

449

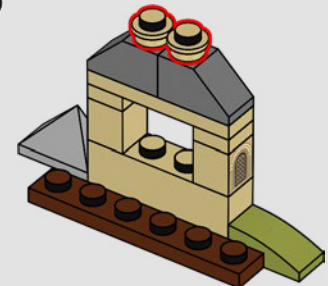

450

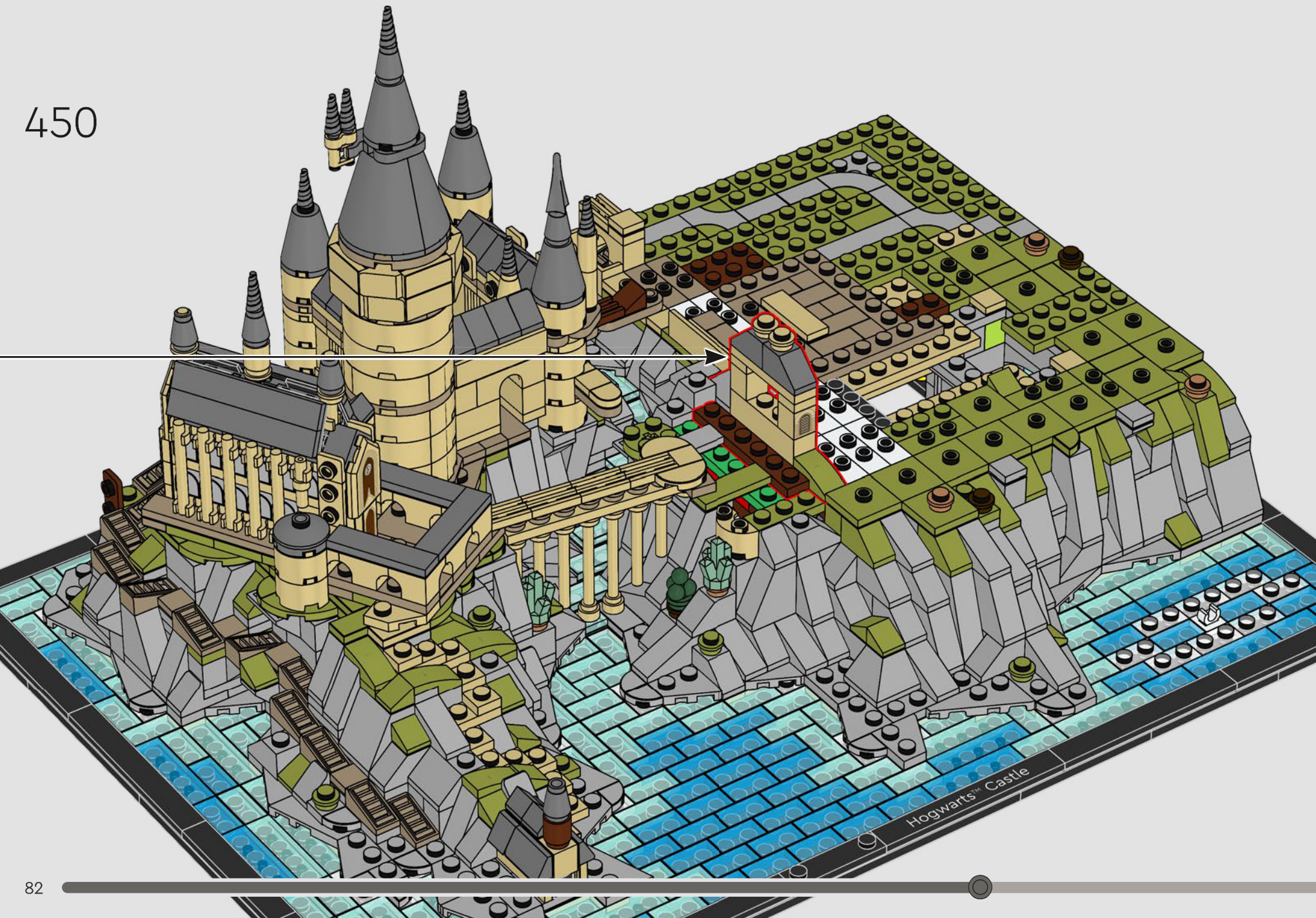

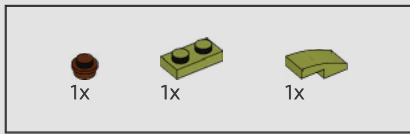

451

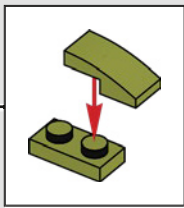
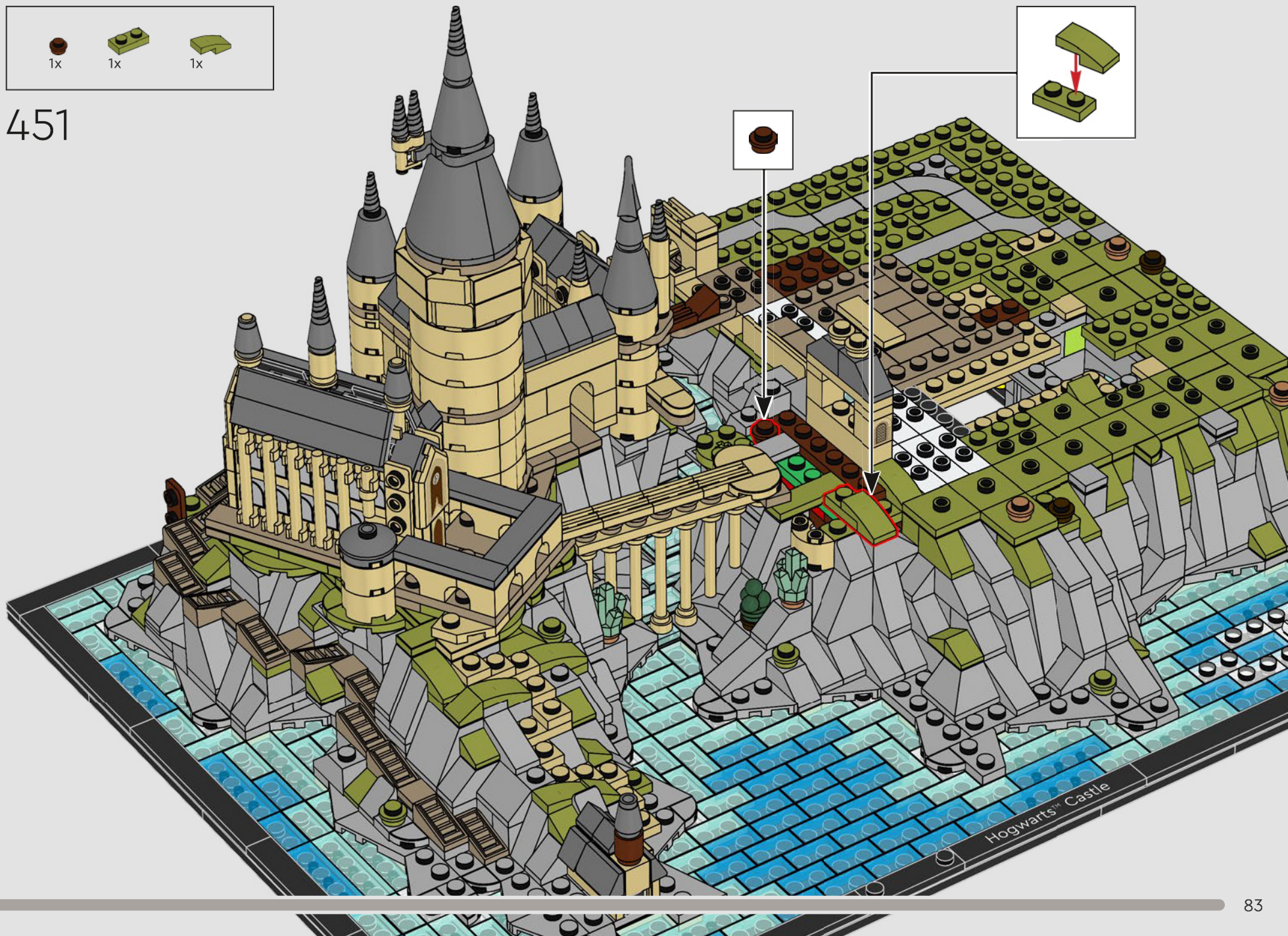

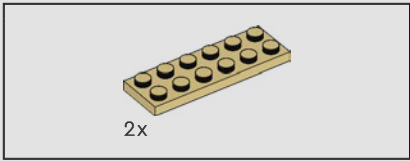

452

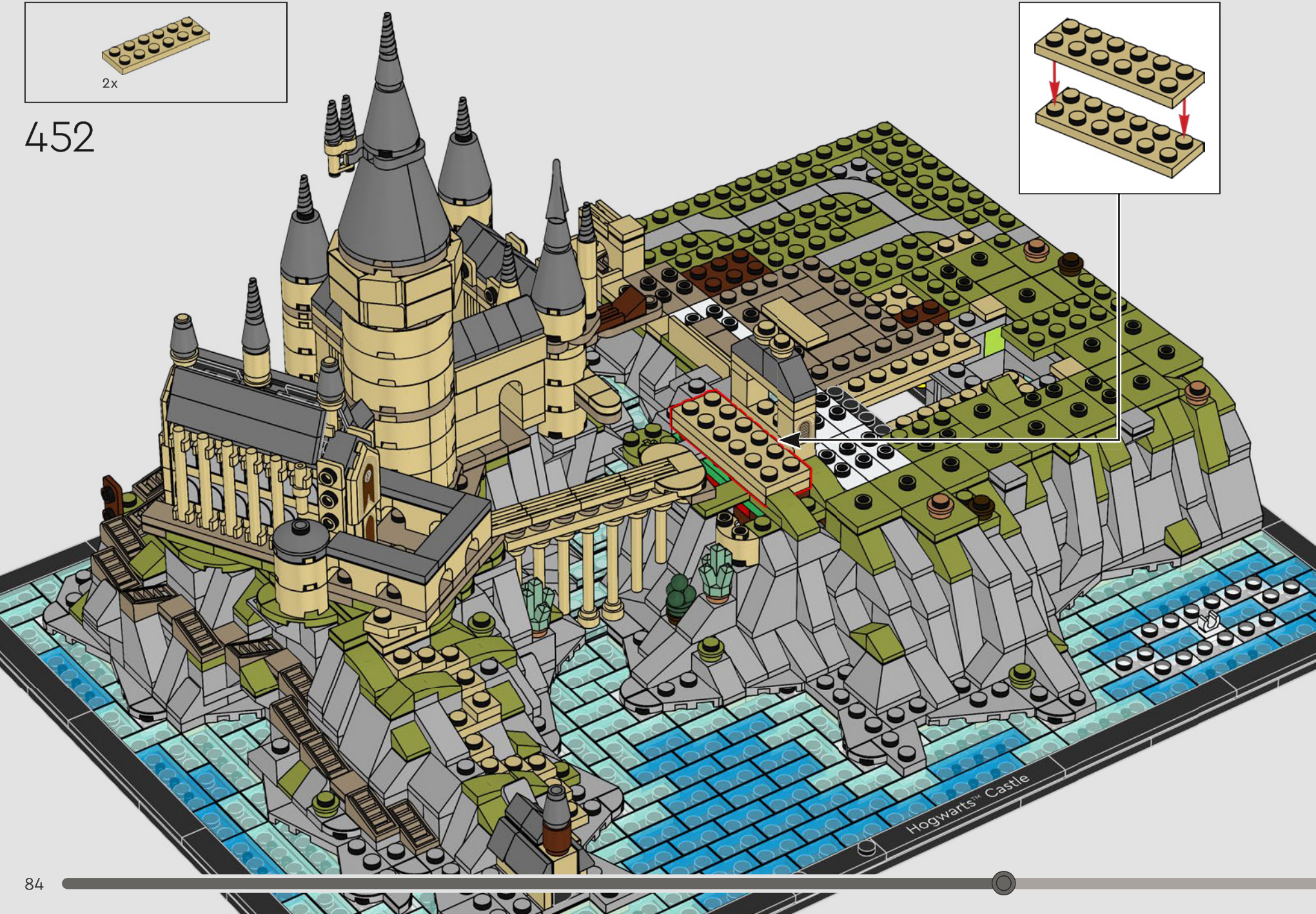
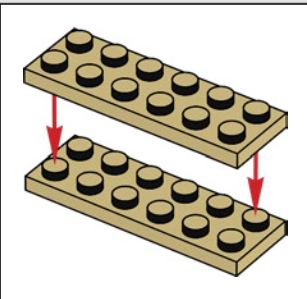



453

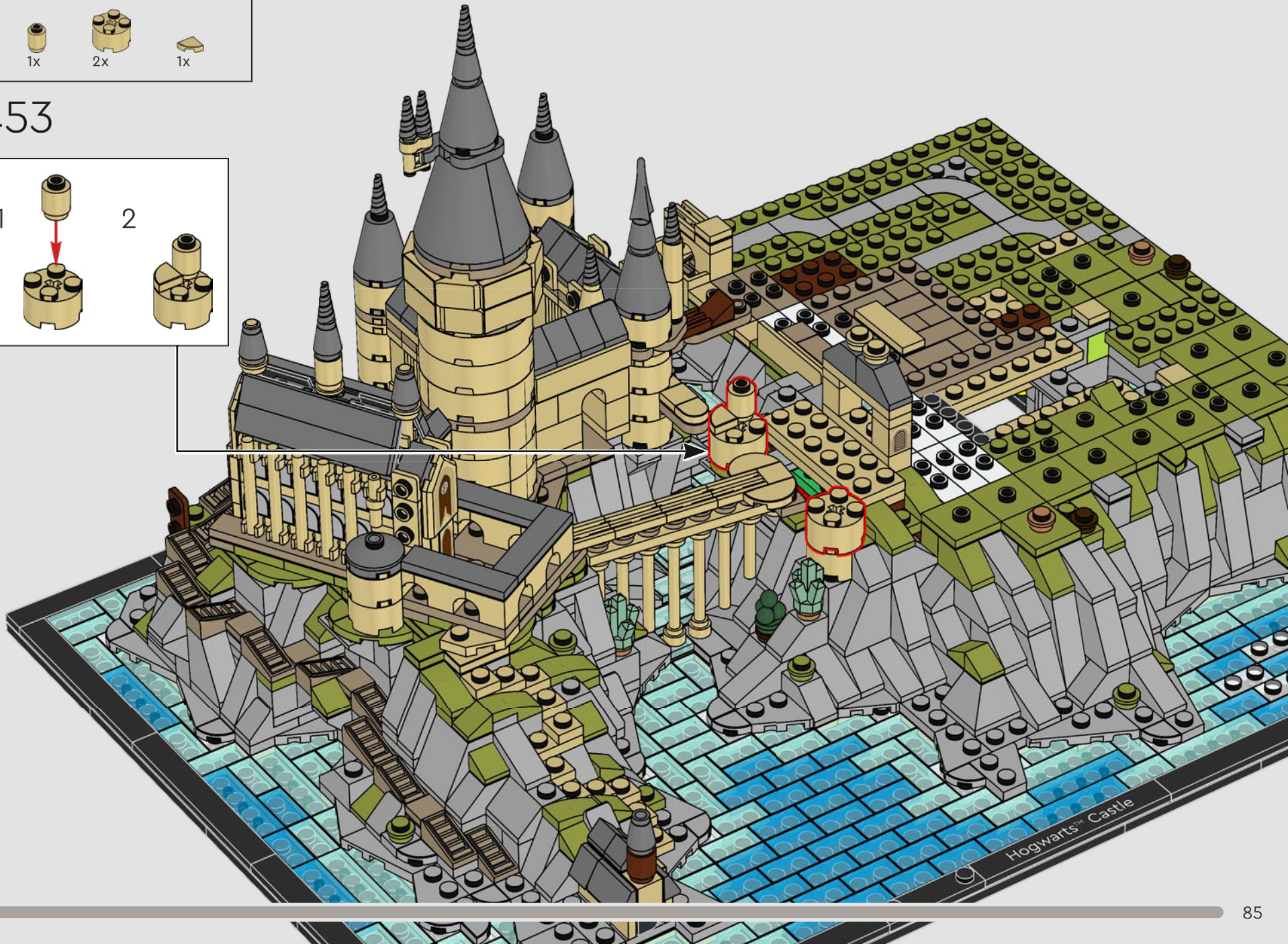
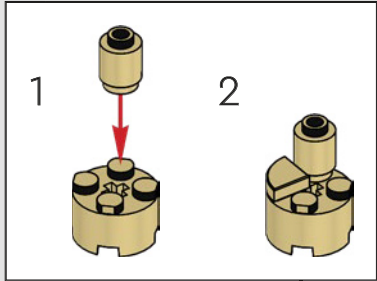



3x

454

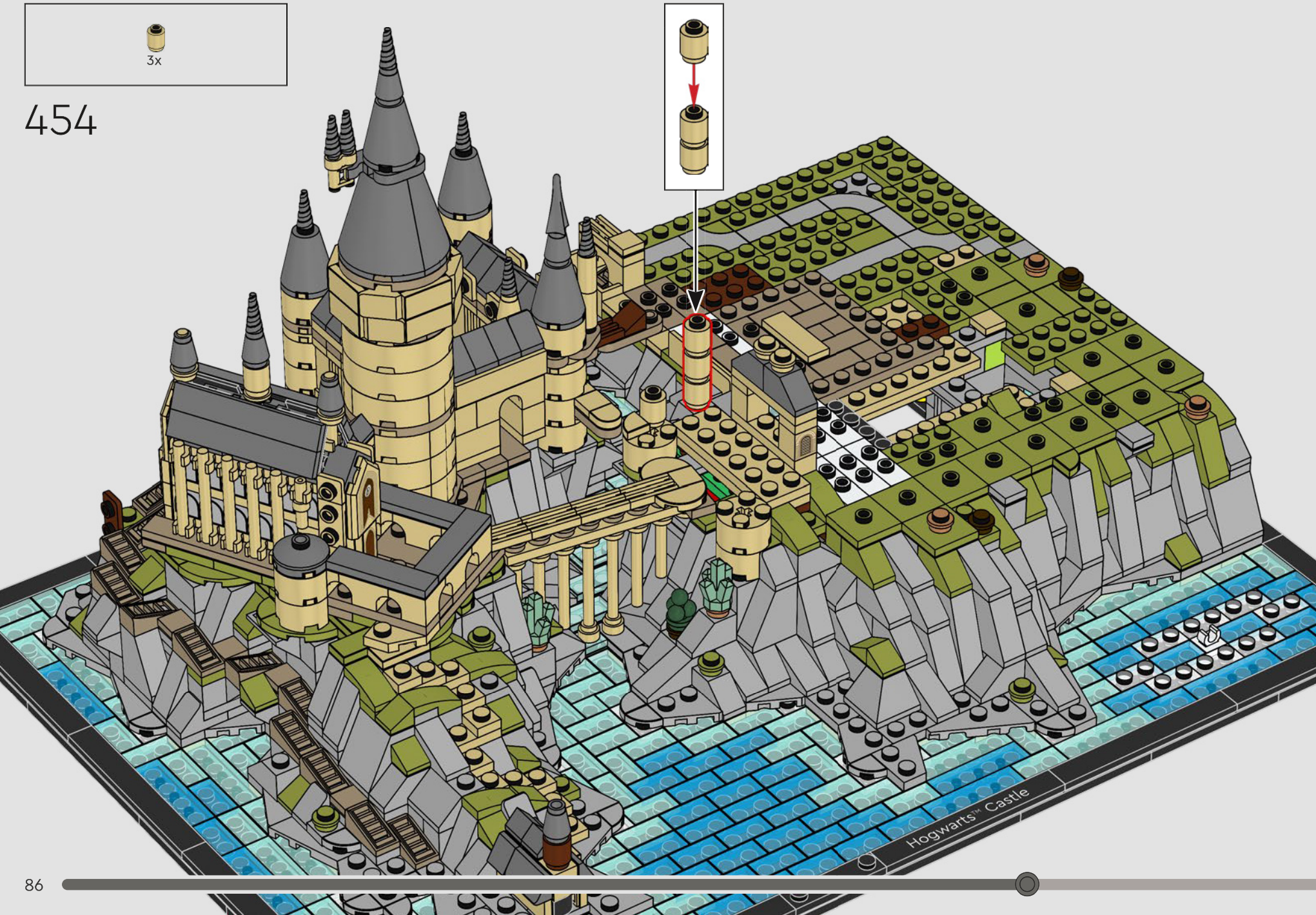
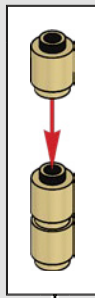

Hogwarts™ Castle

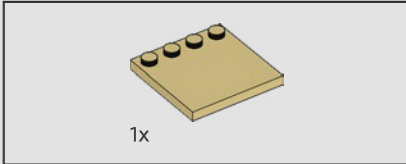
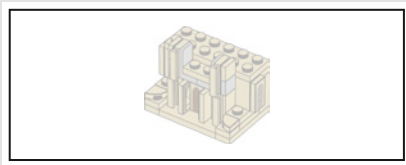

455

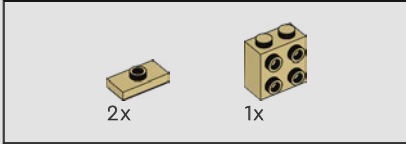
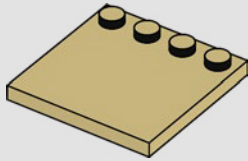

456

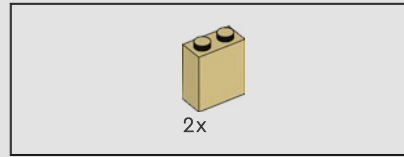
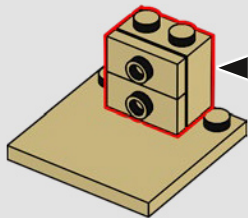
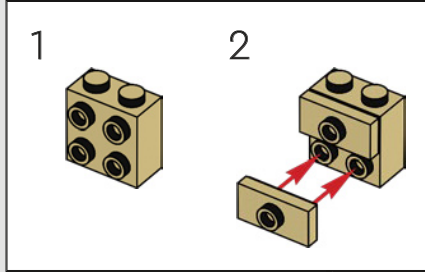

457

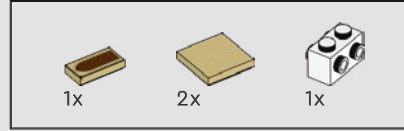
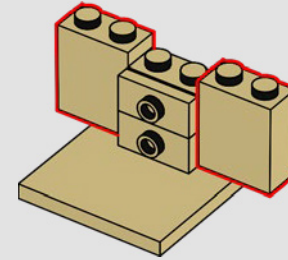

458

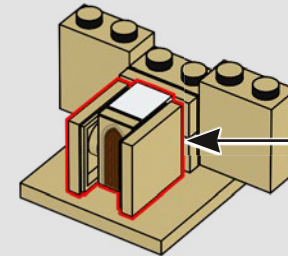
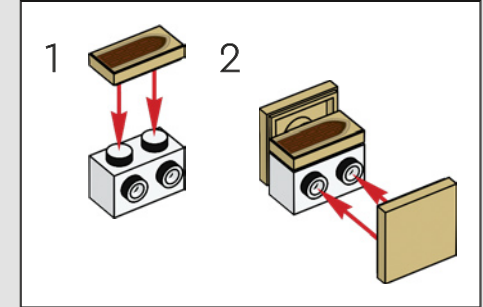

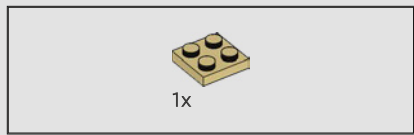

459

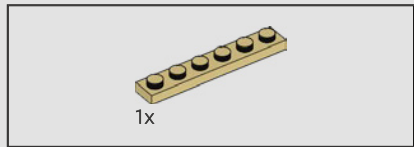
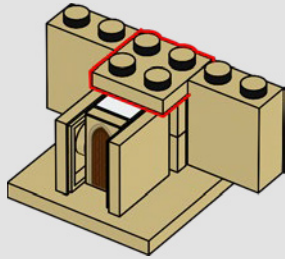

460

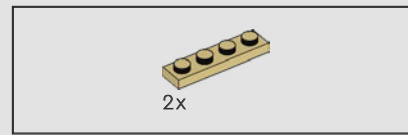
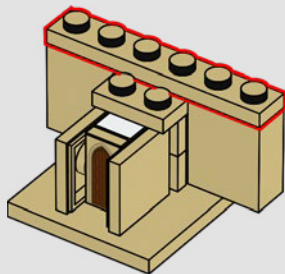

461

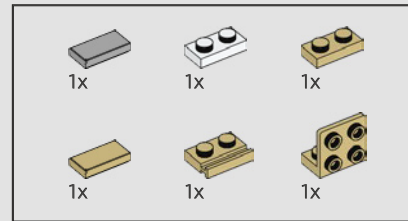
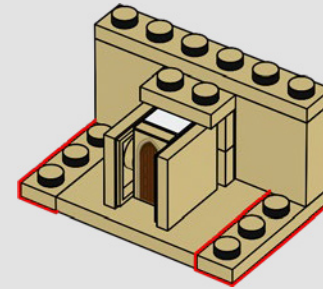

462

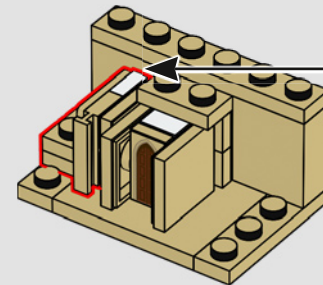
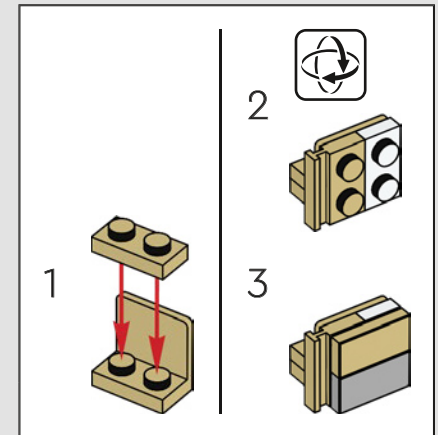



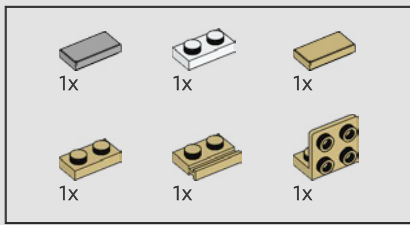

463

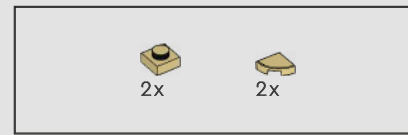
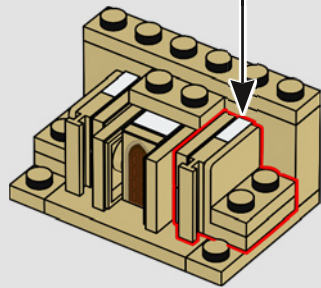
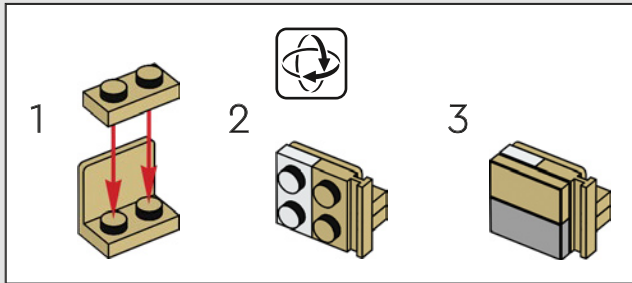

464

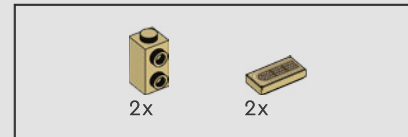
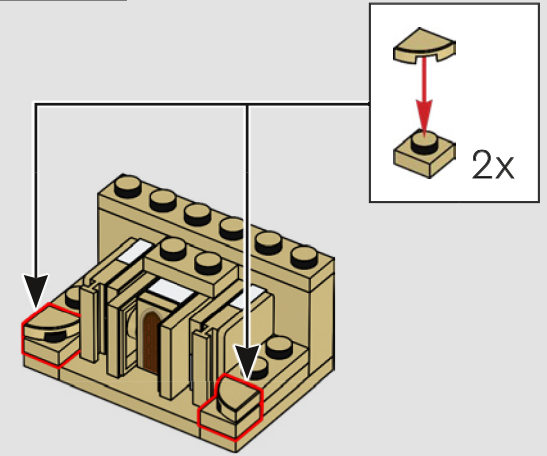

465

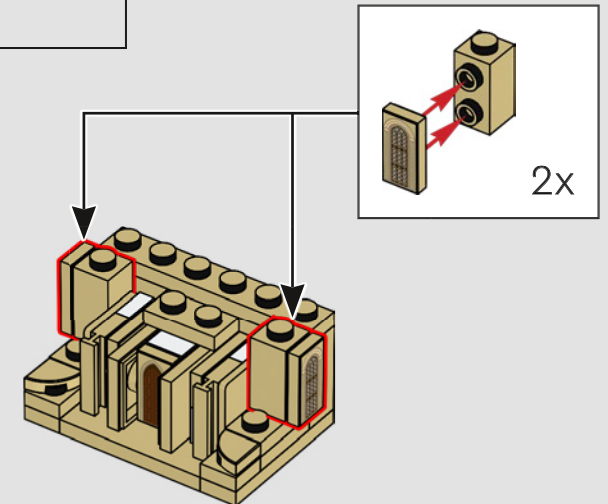

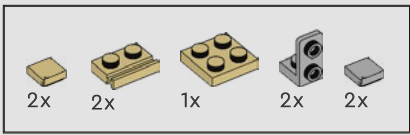

466

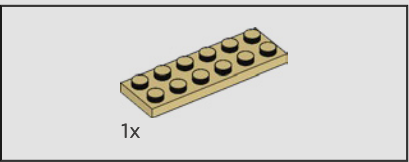
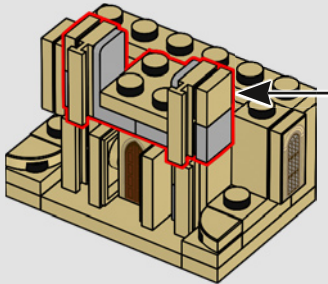
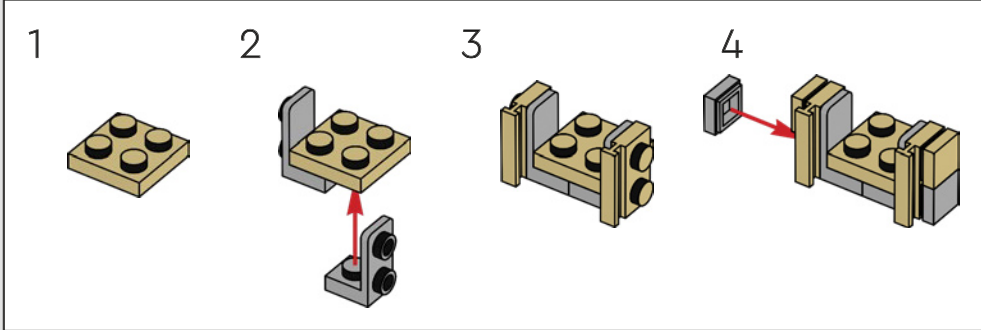

467

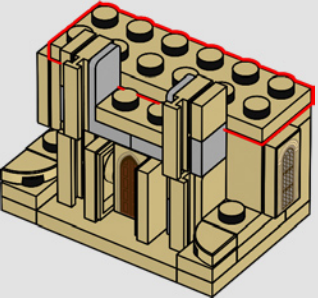

468

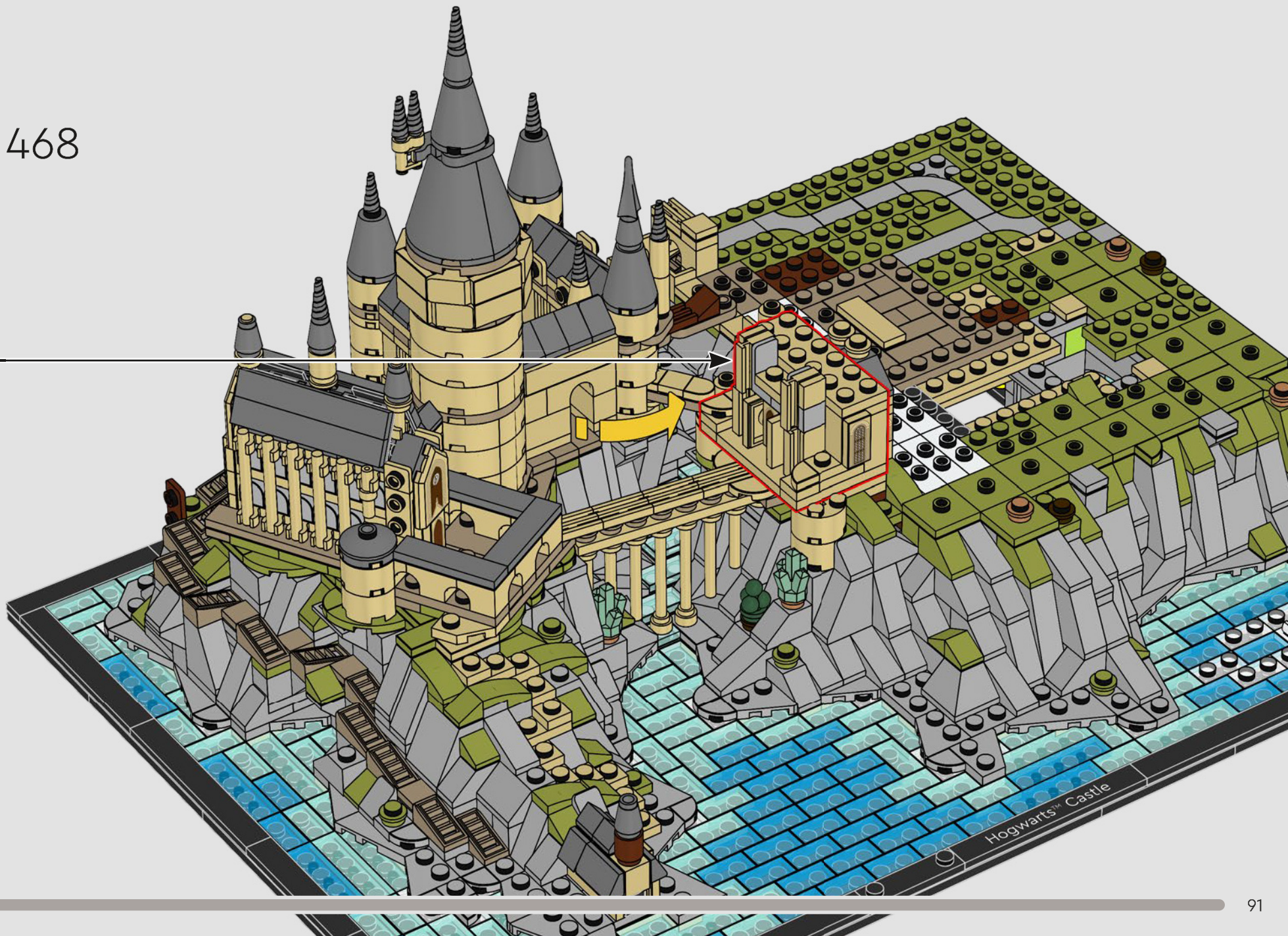

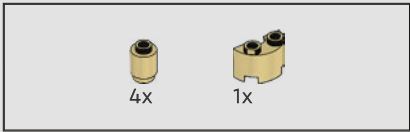

469

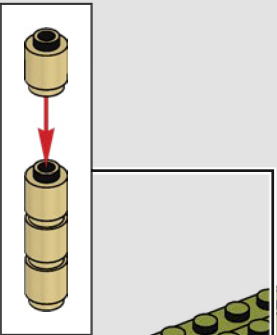

Hogwarts™ Castle



470

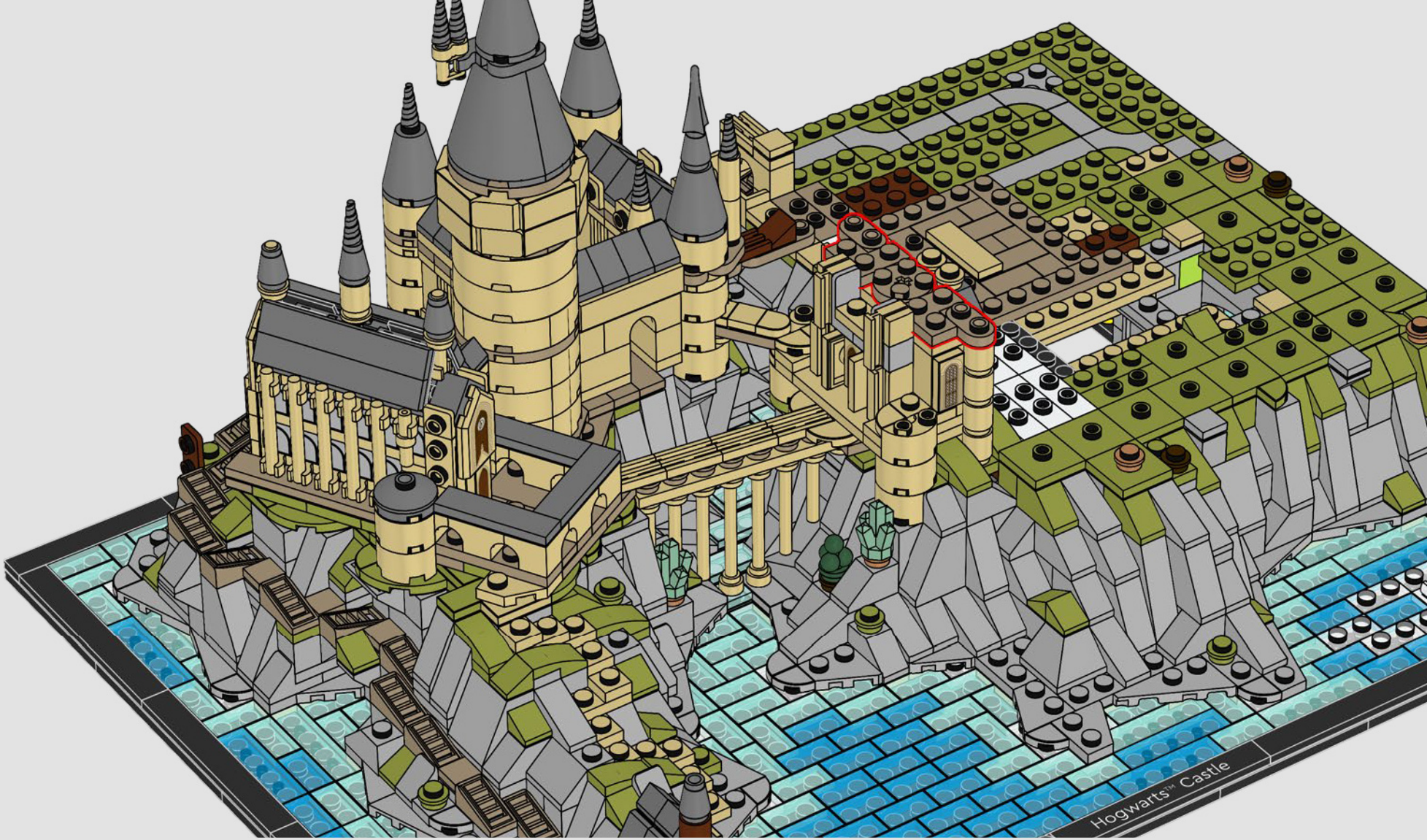

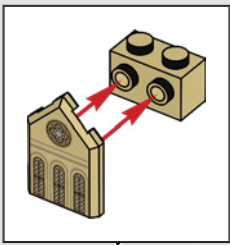
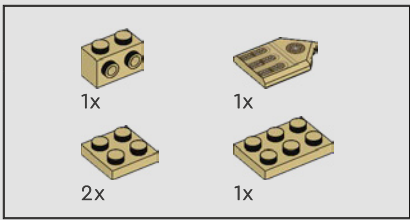

471

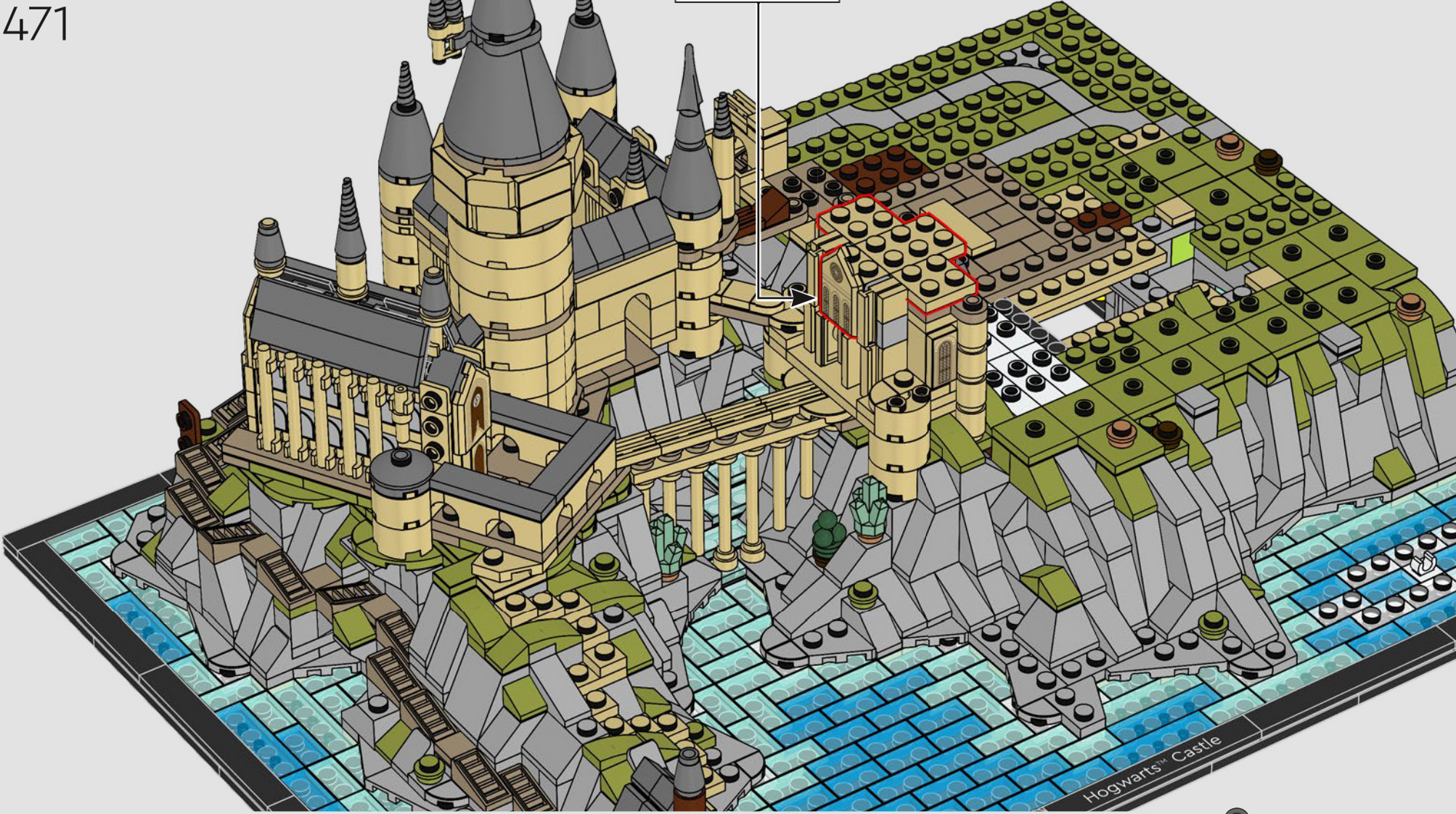

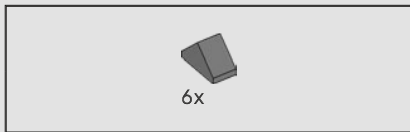

472

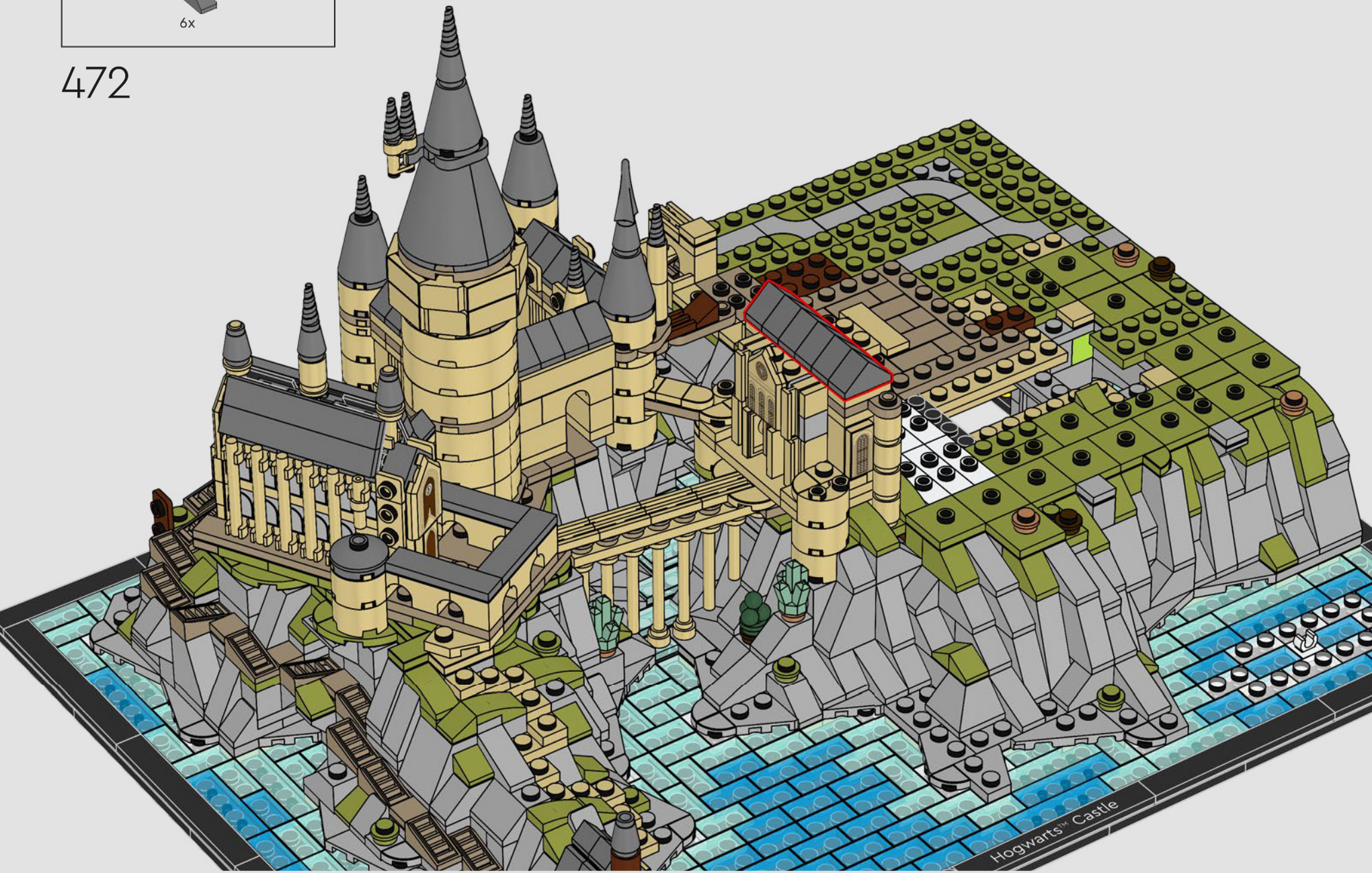

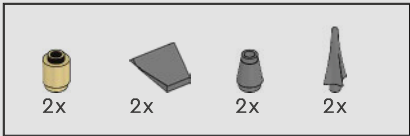

473

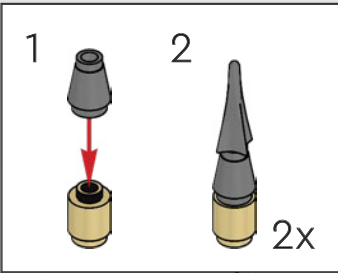



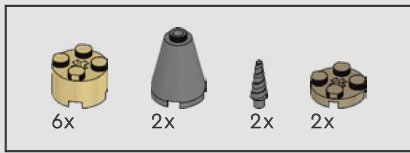

474

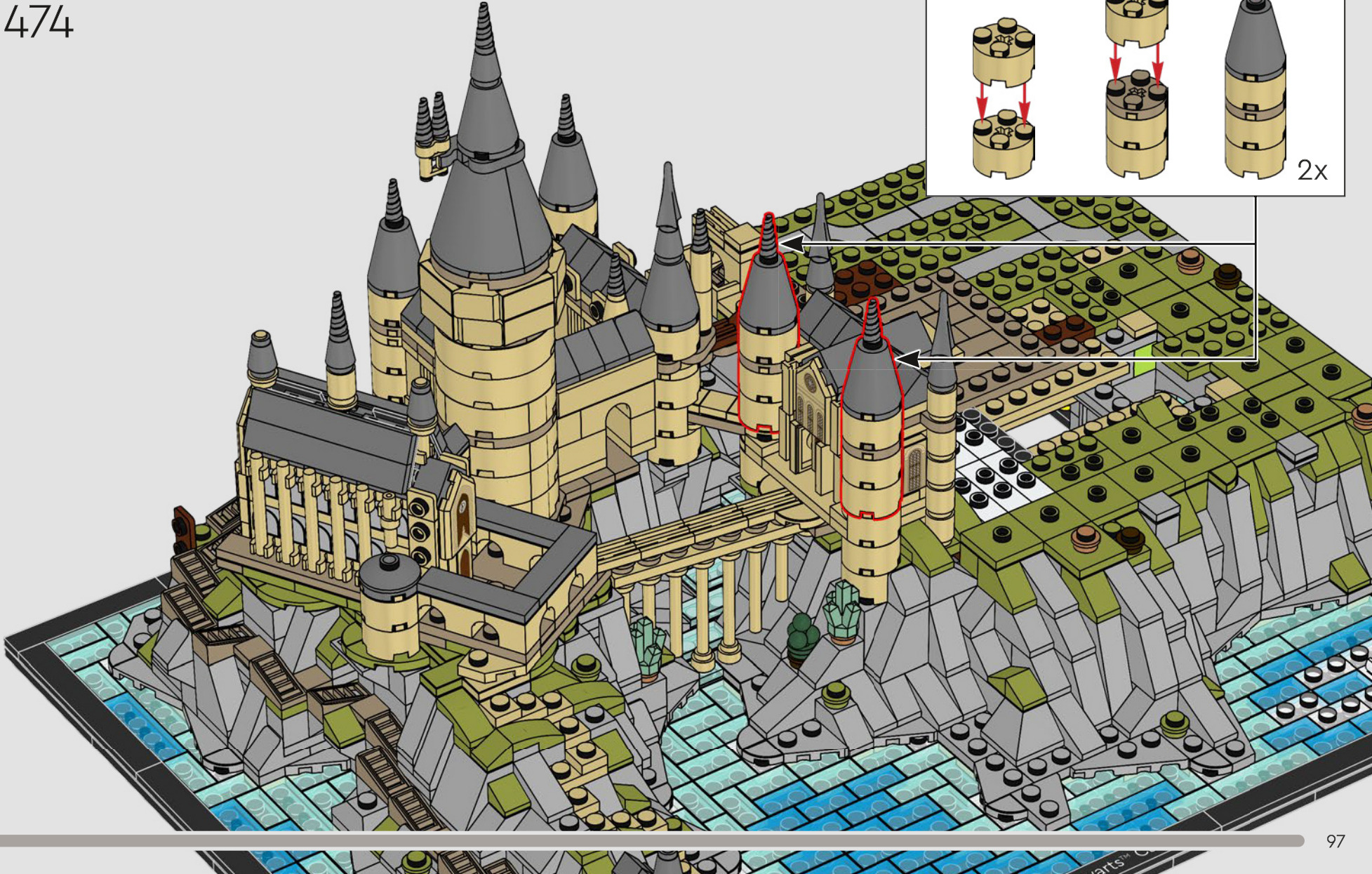
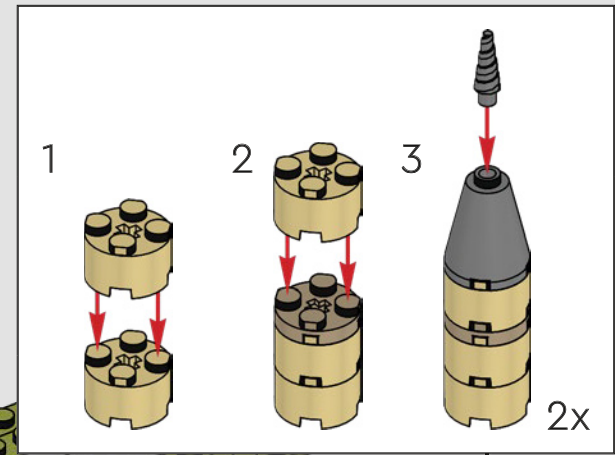

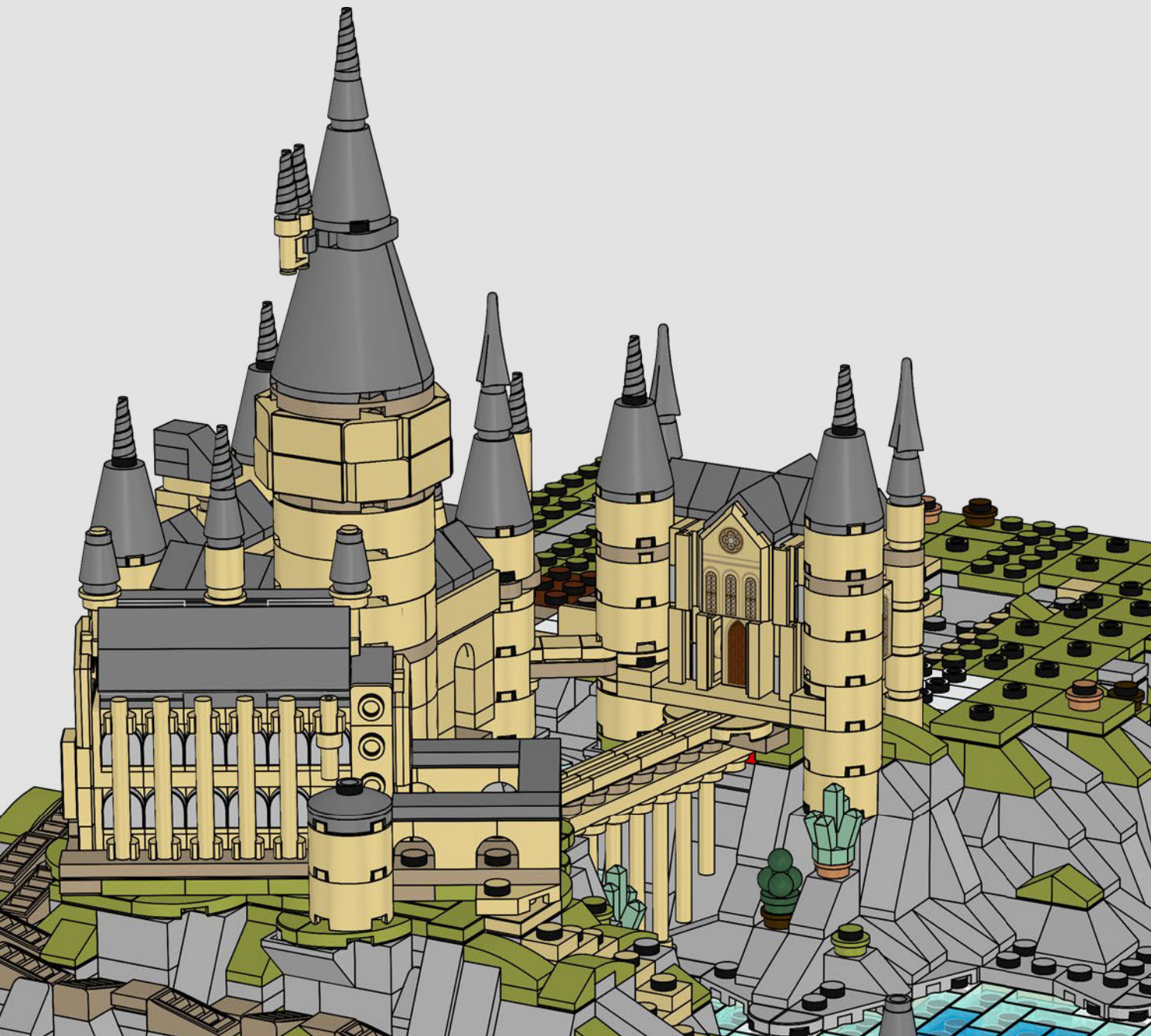

The girls' lavatories are located in this part of the castle. Maybe Moaning Myrtle™ will stop by as you build. Just watch out for trolls.





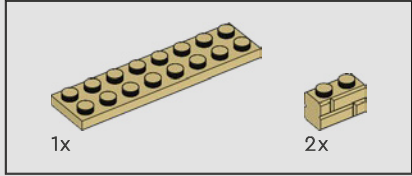
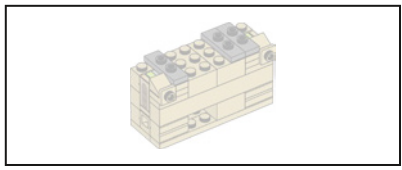

475

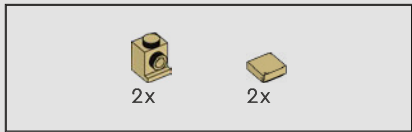
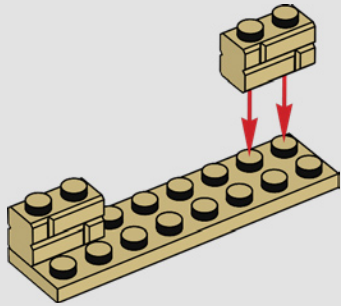

476

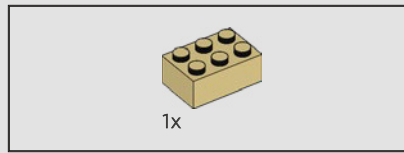
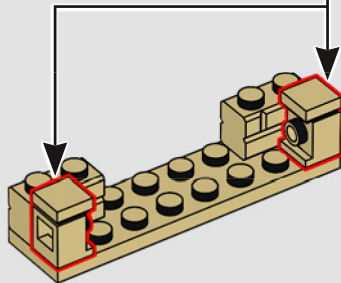
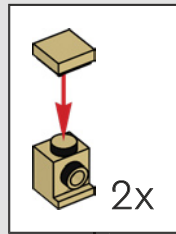

477

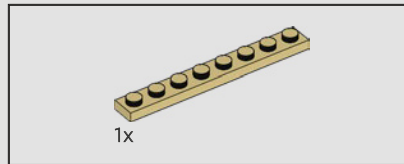
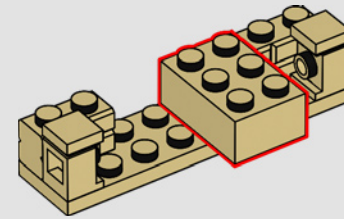

478

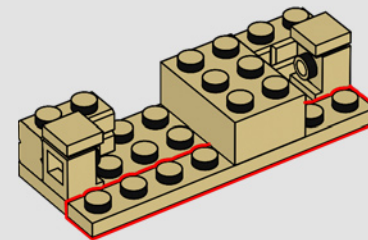

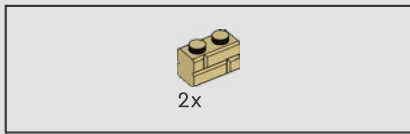

479

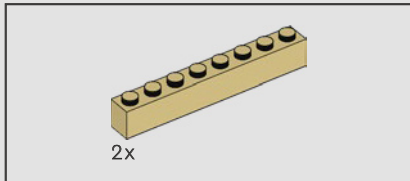
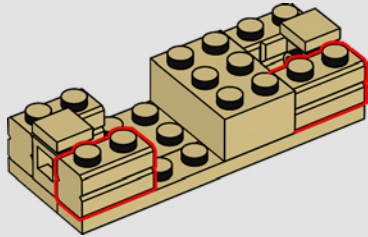

480

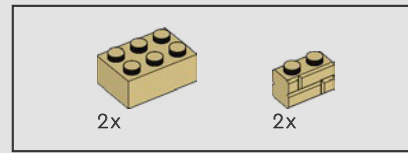
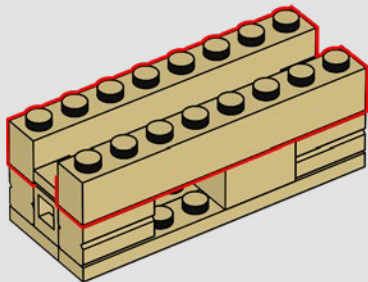

481

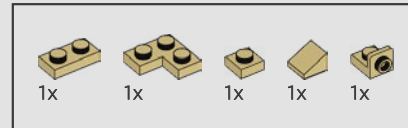
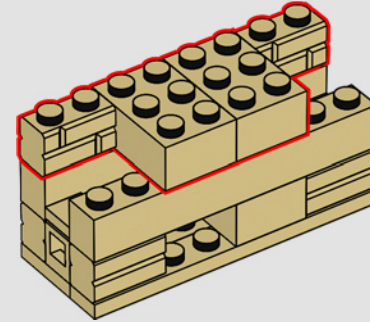

482

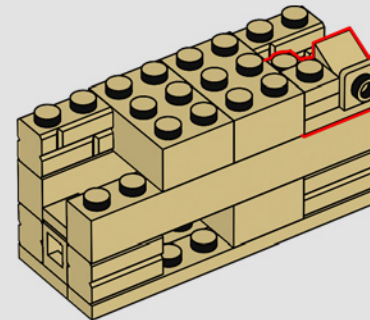
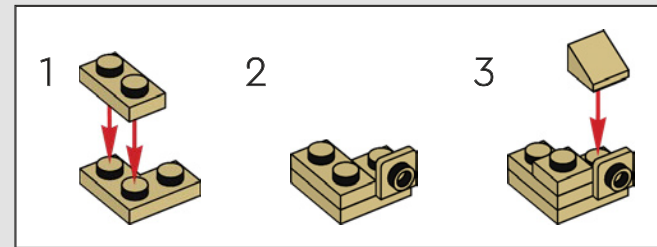

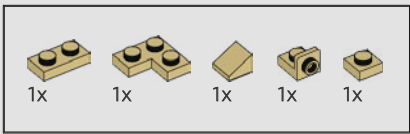

483

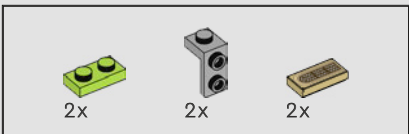
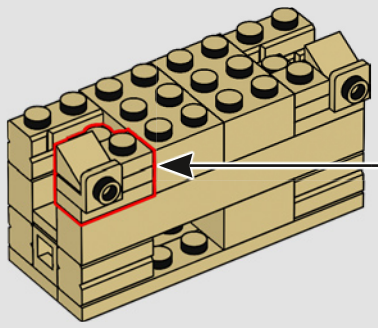
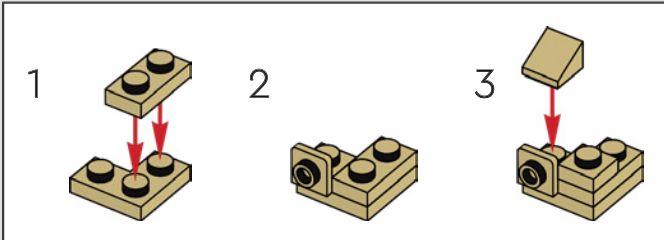

484

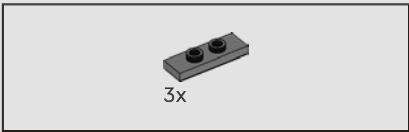
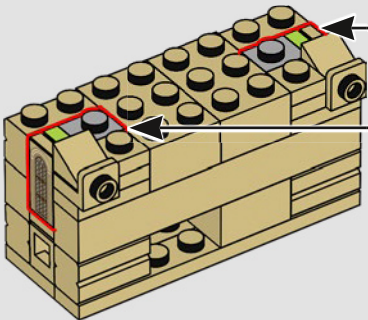
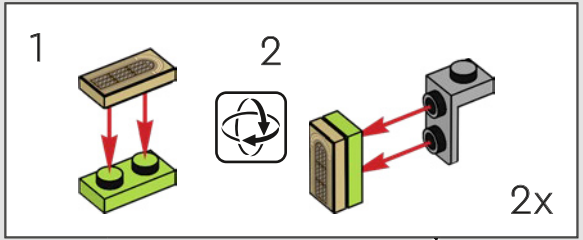

485

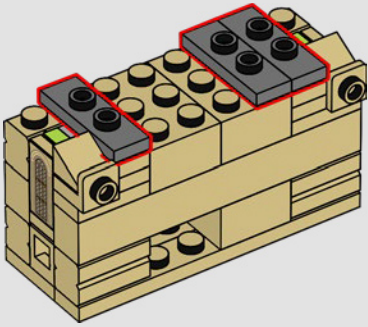

486



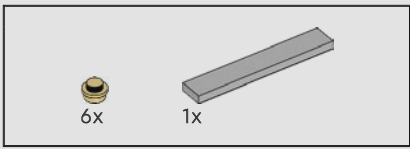

487

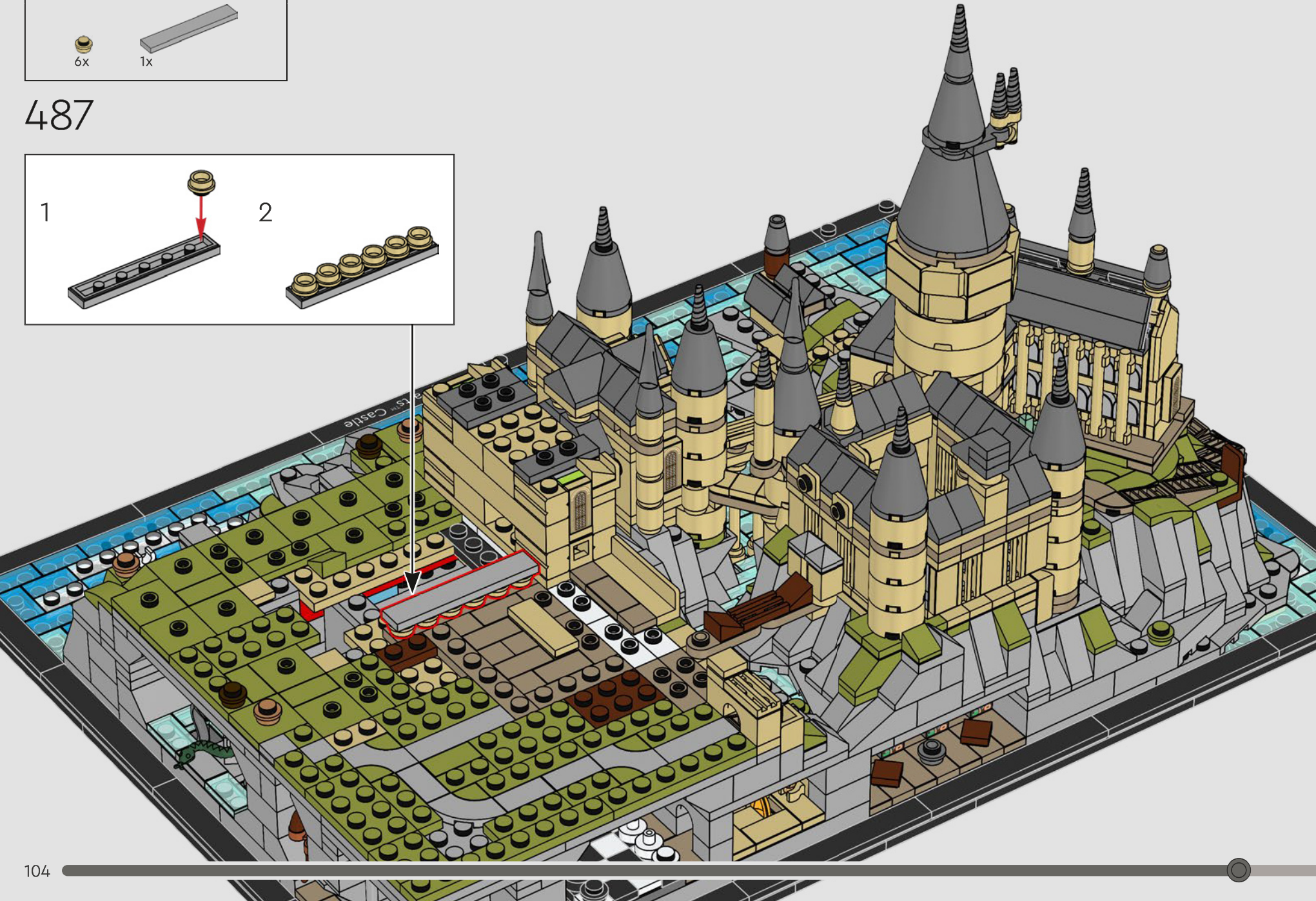
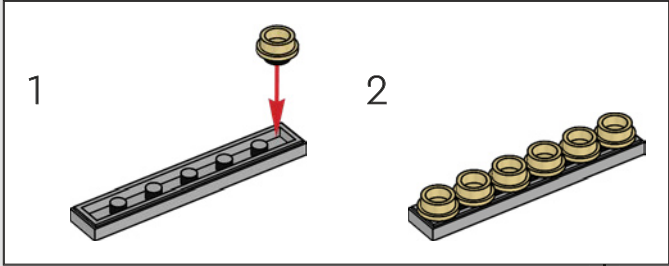



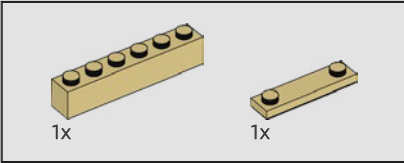
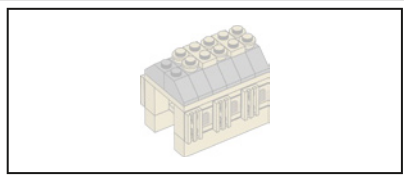

488

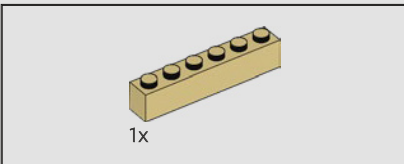
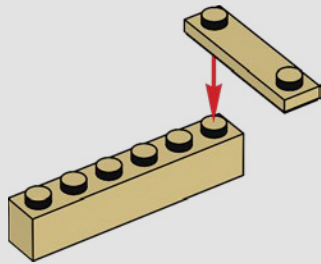

489

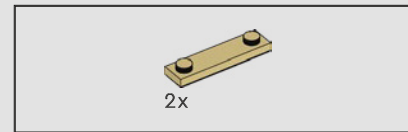
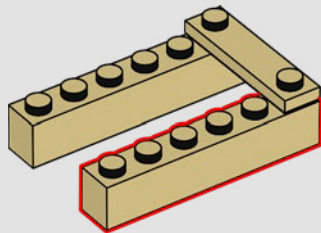

490

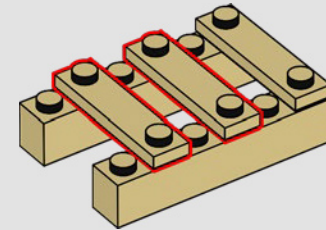

491

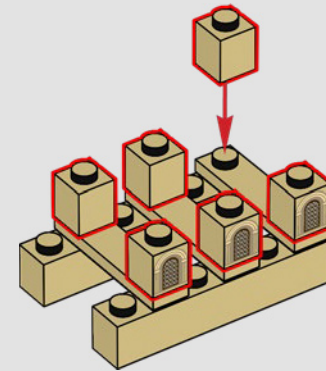

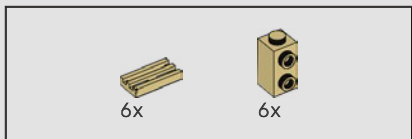

492

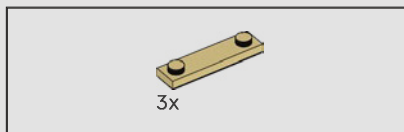
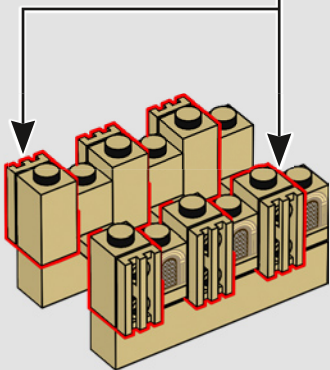
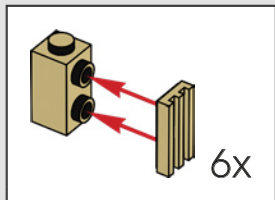

493

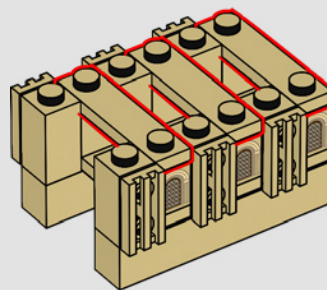

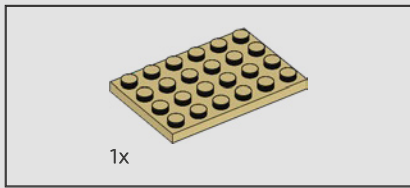

494

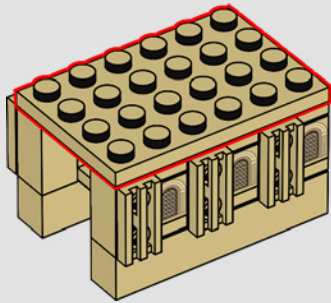

495

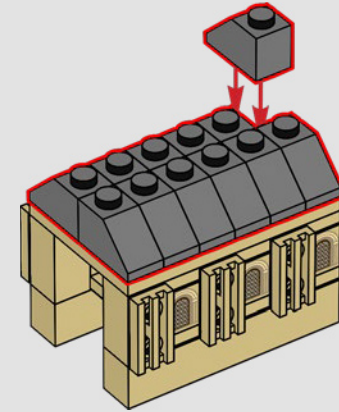

496

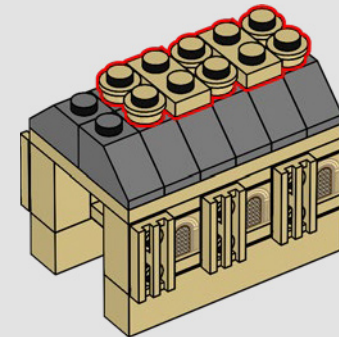

497

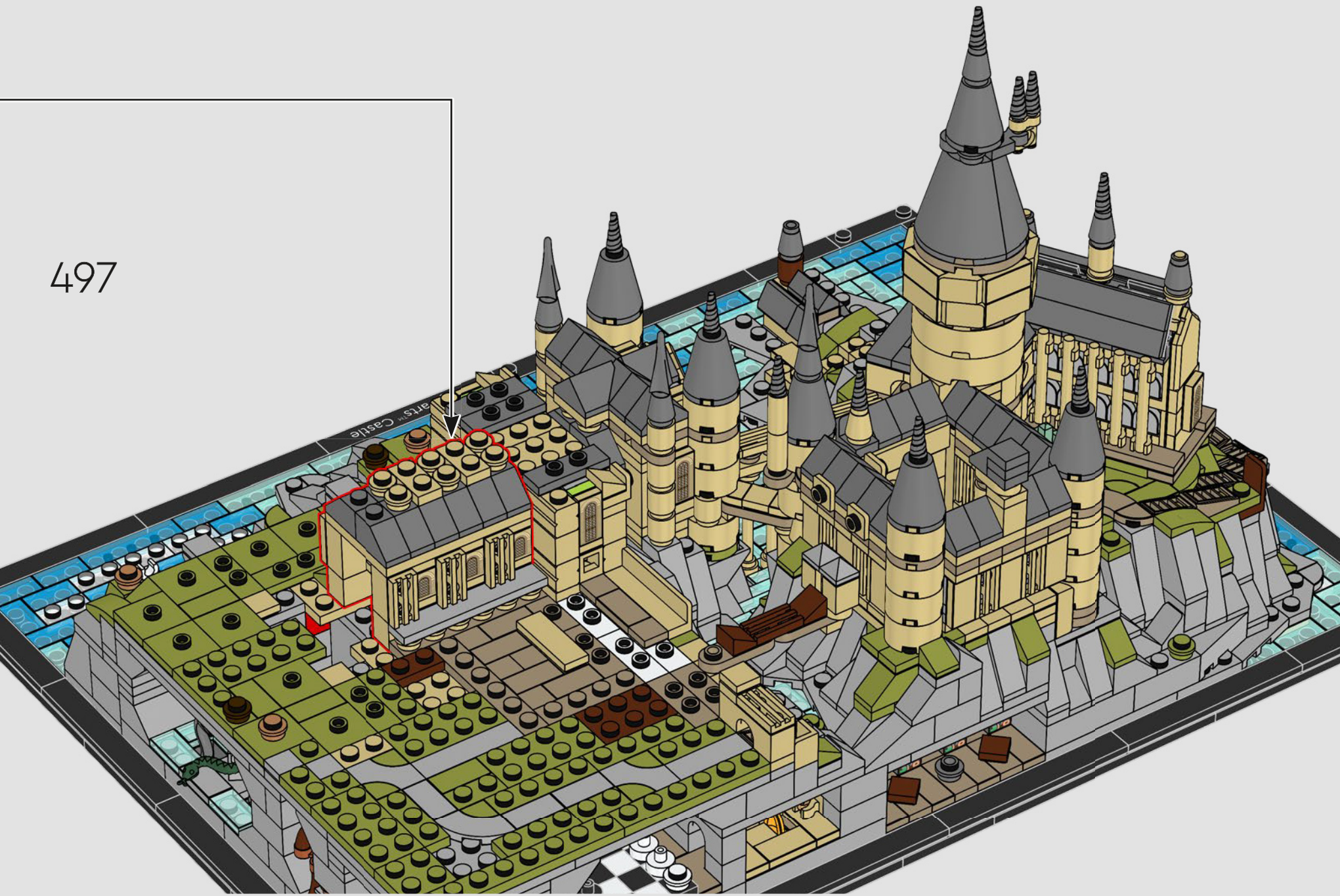

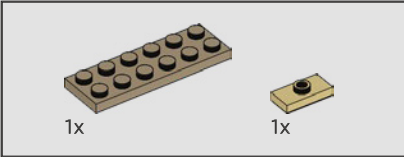
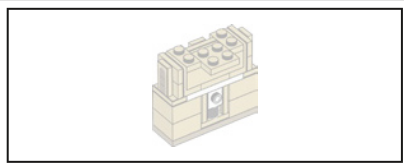

498

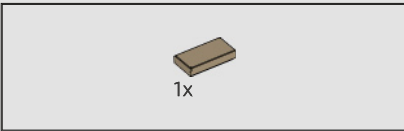
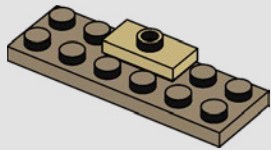

499

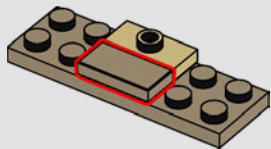

500

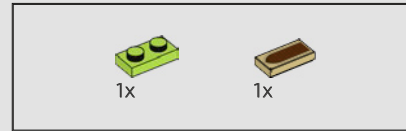
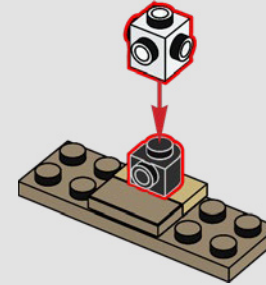

501

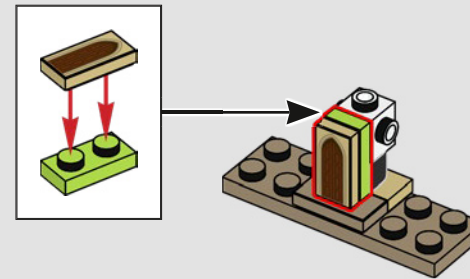

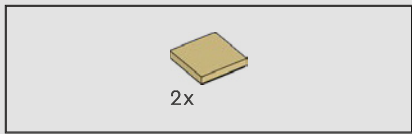

502

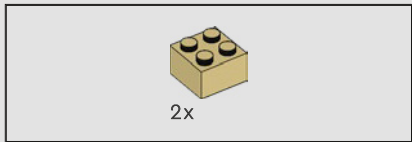
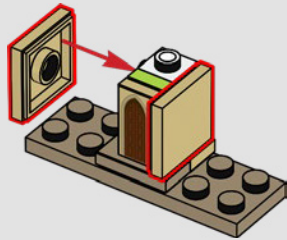

503

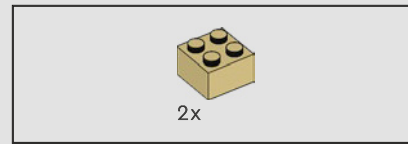
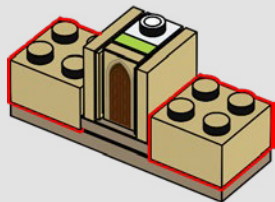

504

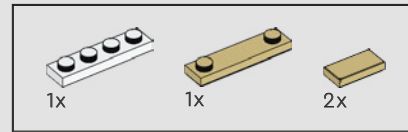
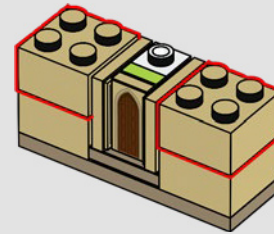

505

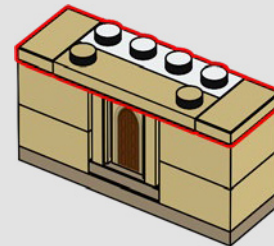

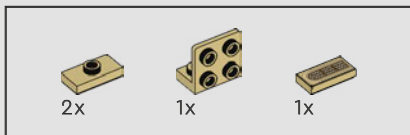

506

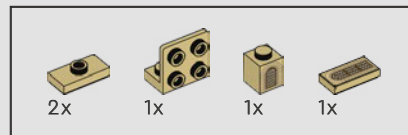
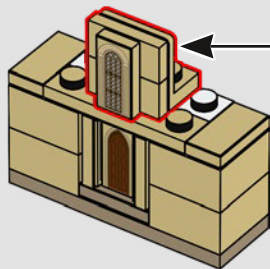
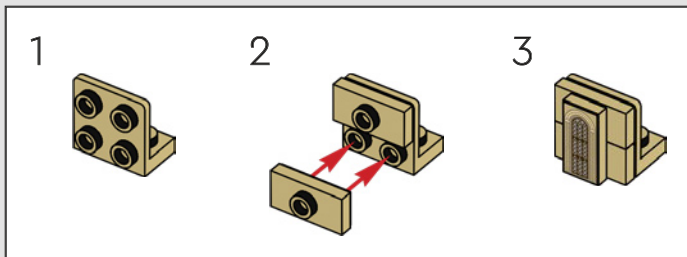

507

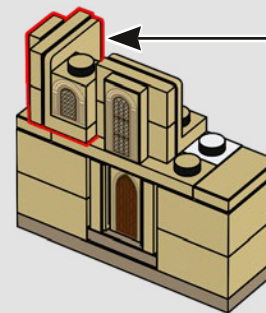
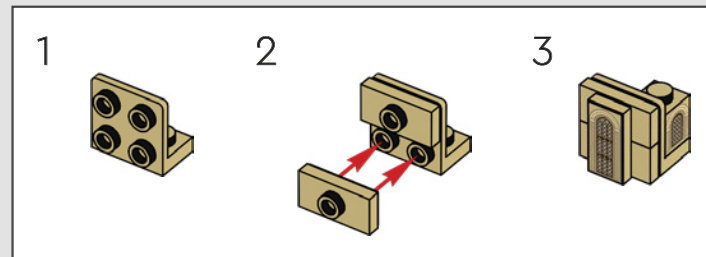

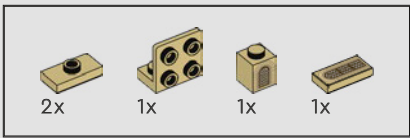

508

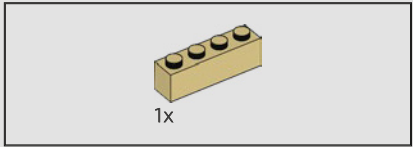
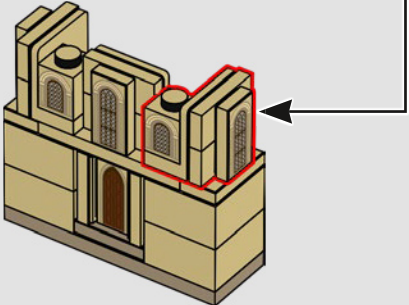
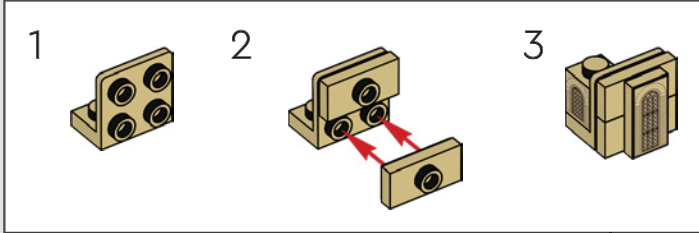

509

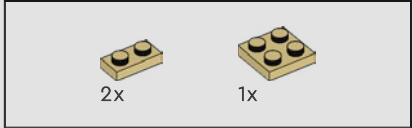
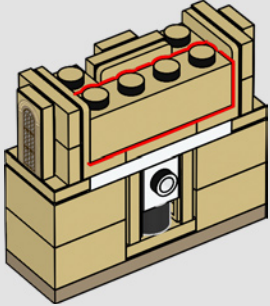

510

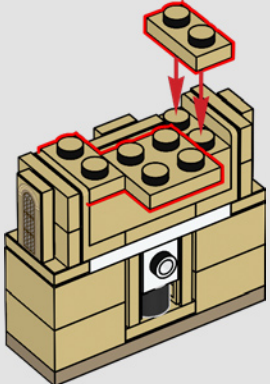



511





2x



2x



2x



2x



2x



2x



2x



2x



2x

512

1

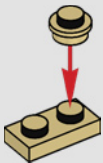

2

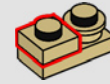

3

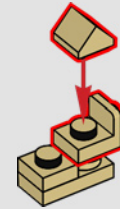

4

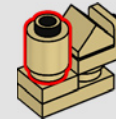

5

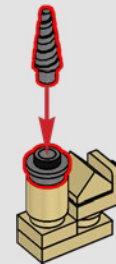

2x



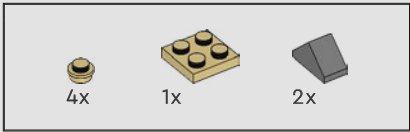

513

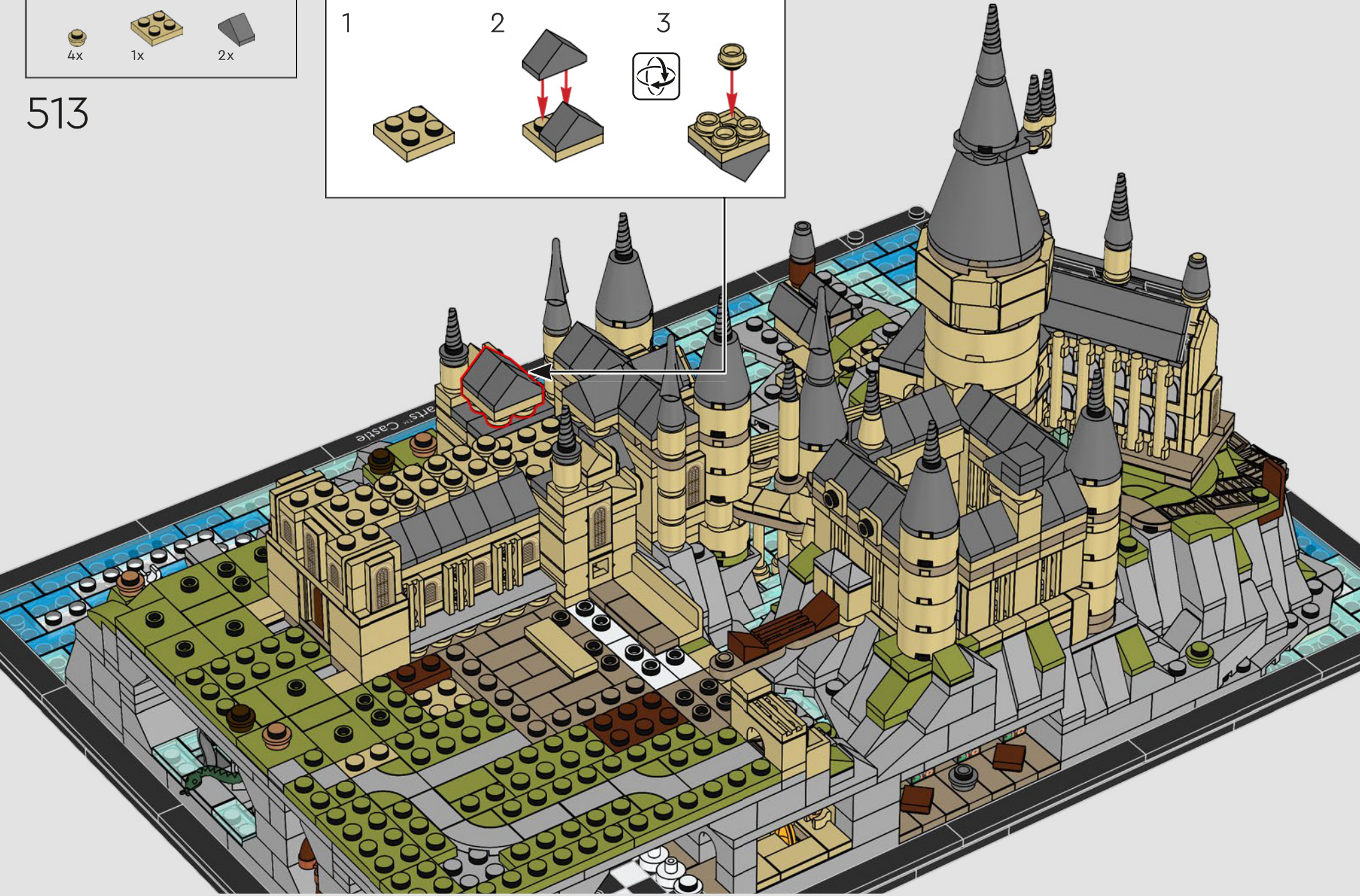
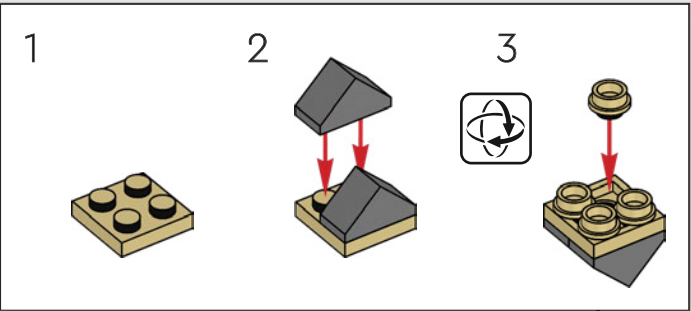

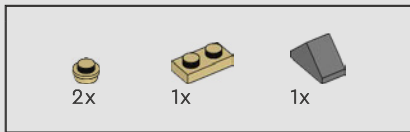

514

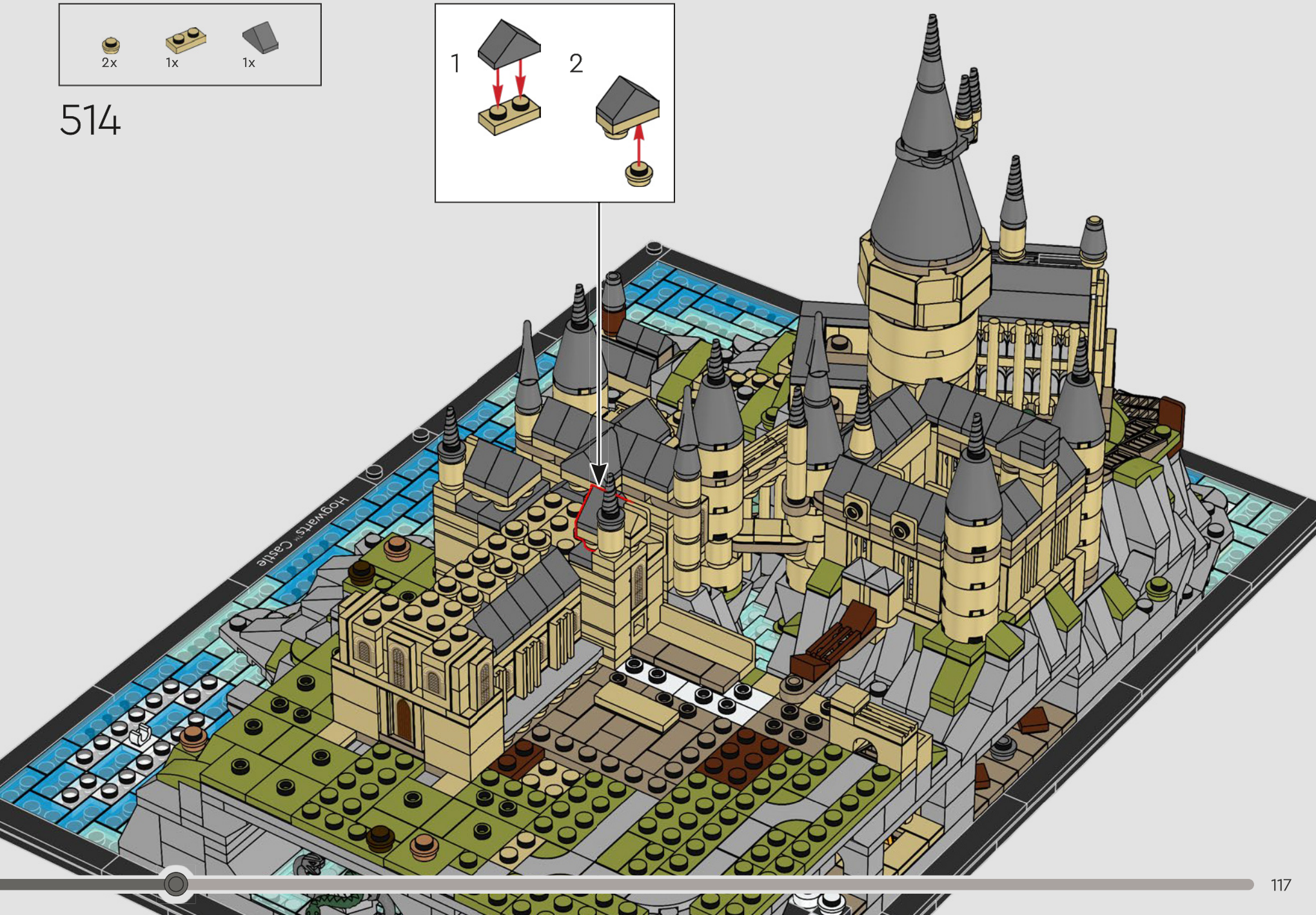
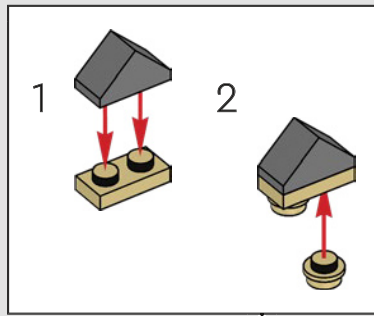

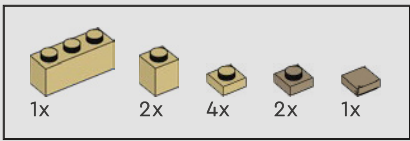

515

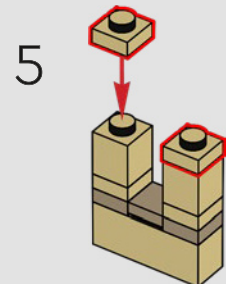
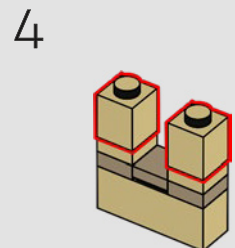
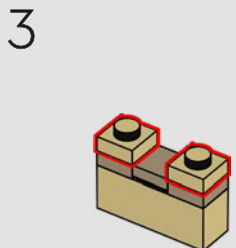
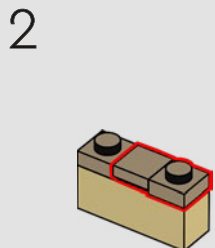
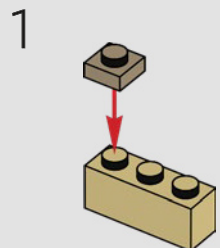

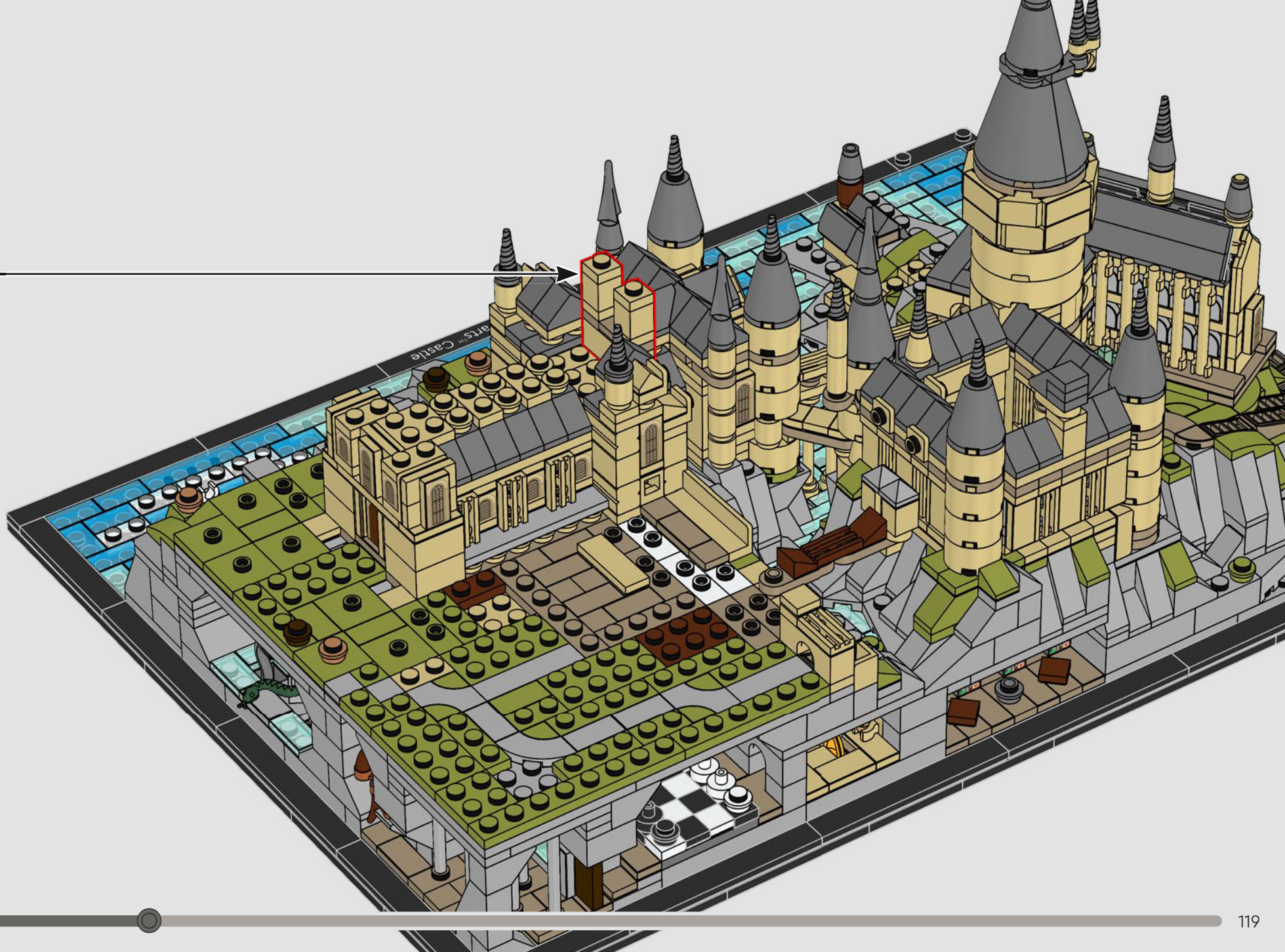

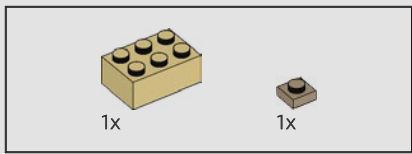

516

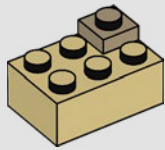

517

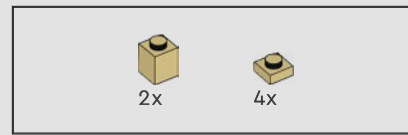
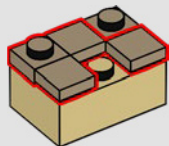

518

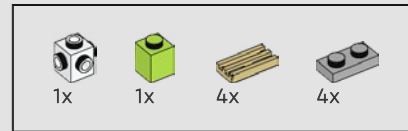
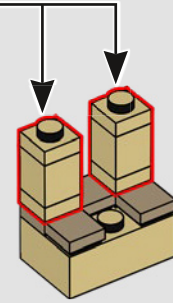
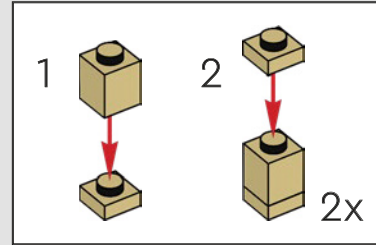

519

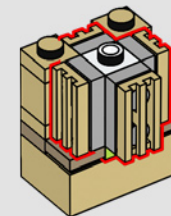
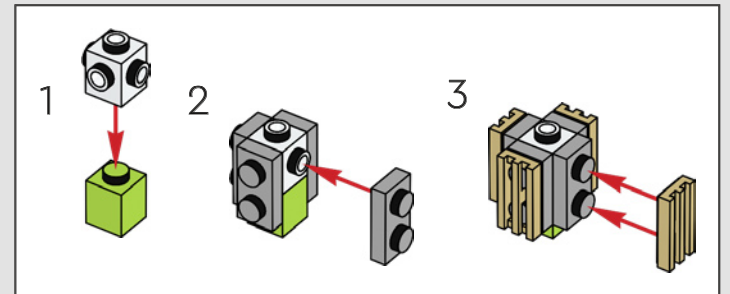



520

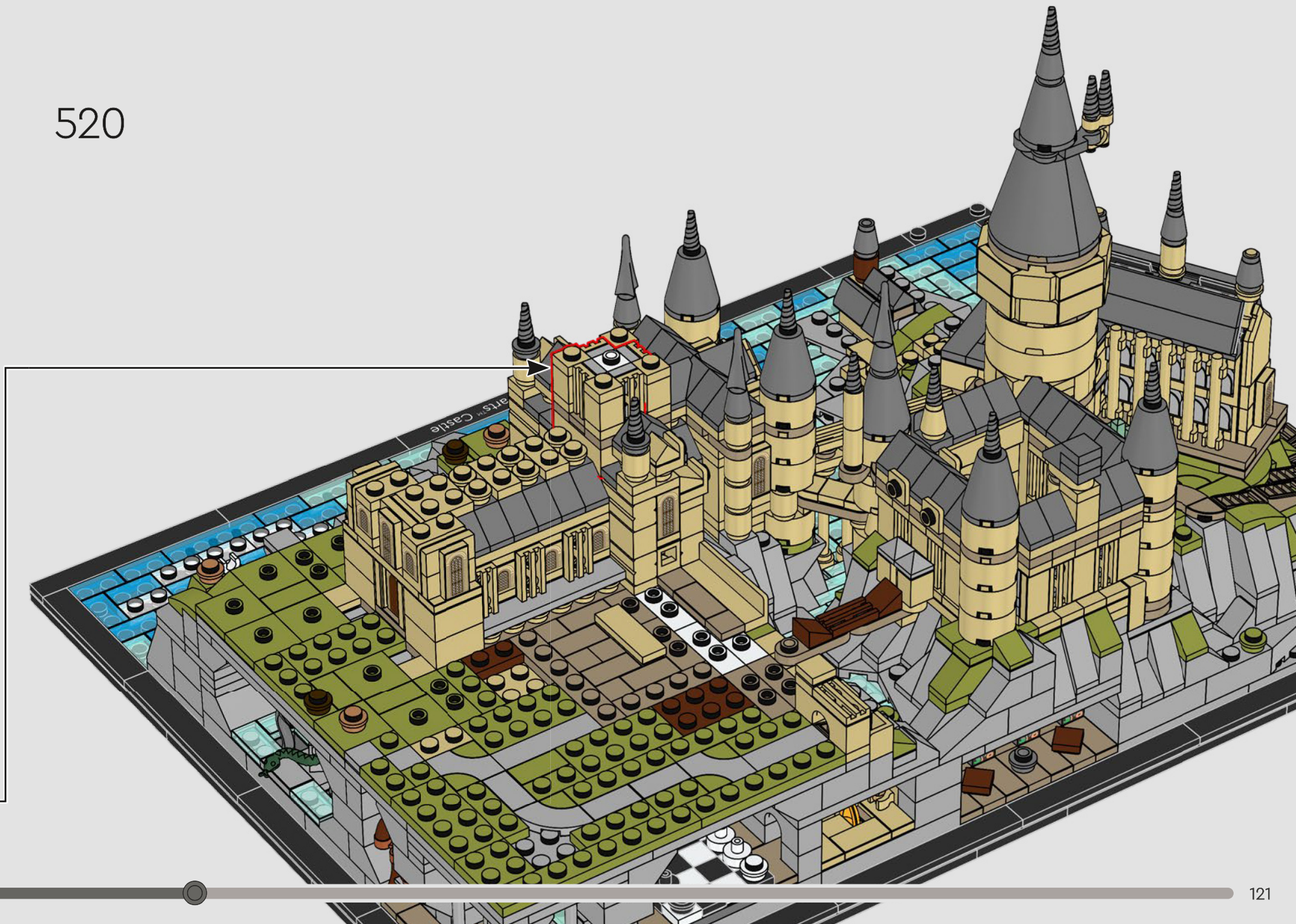

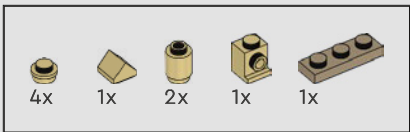

521

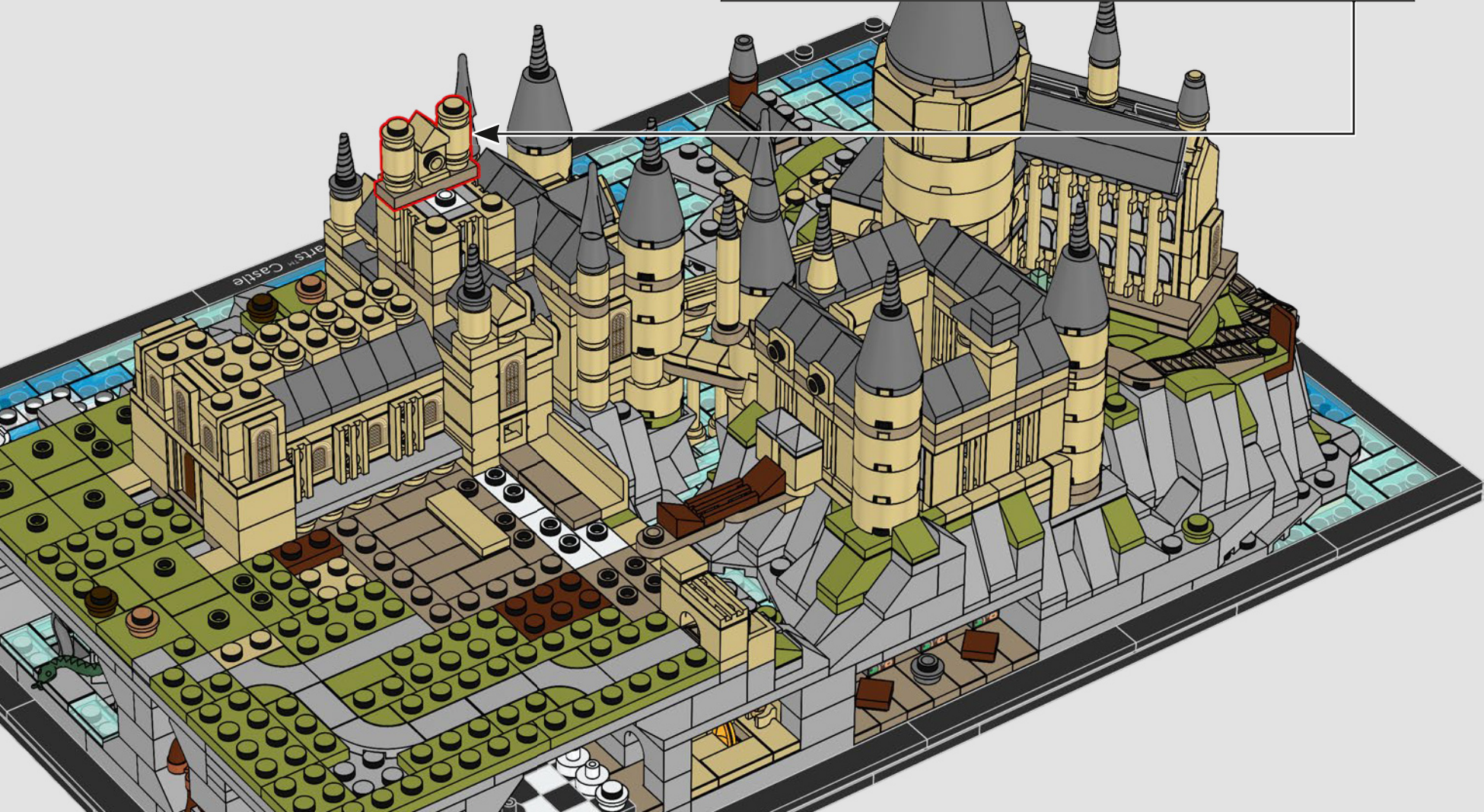
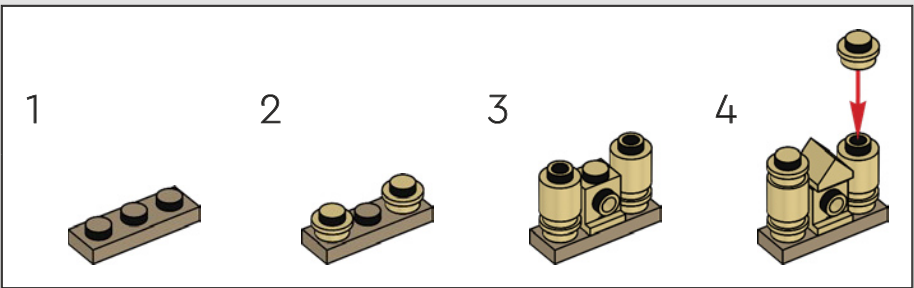

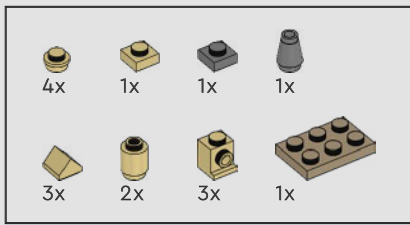

522

1

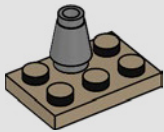

2

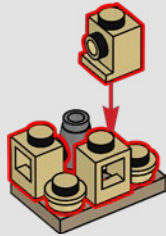

3

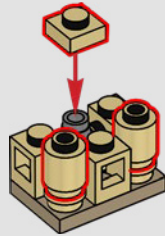

4

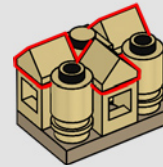

5

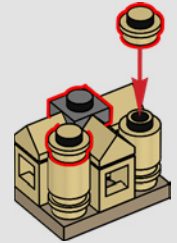

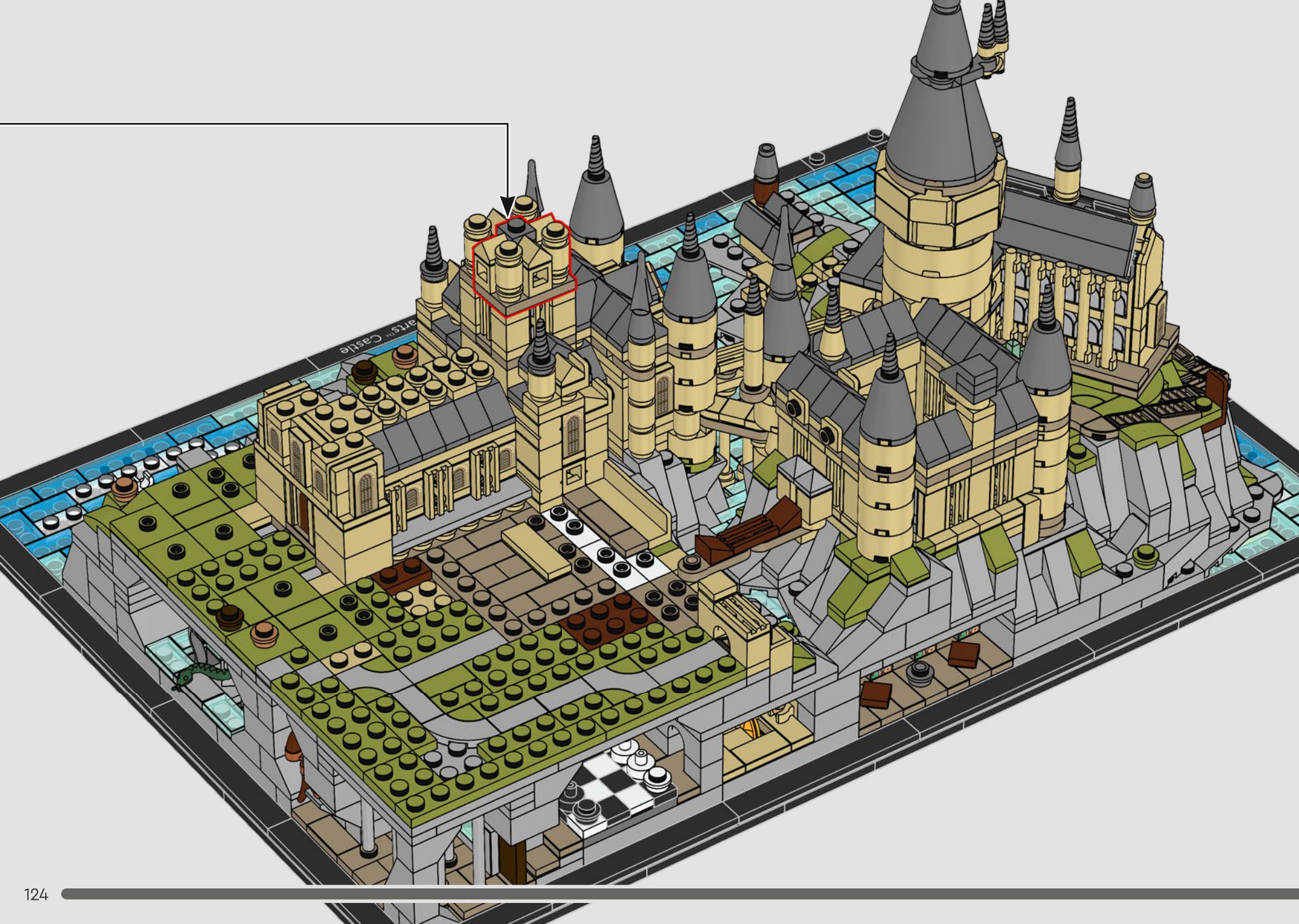

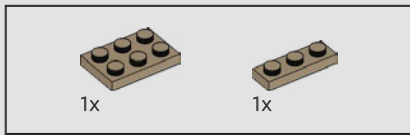

523



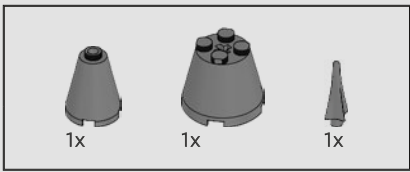

524

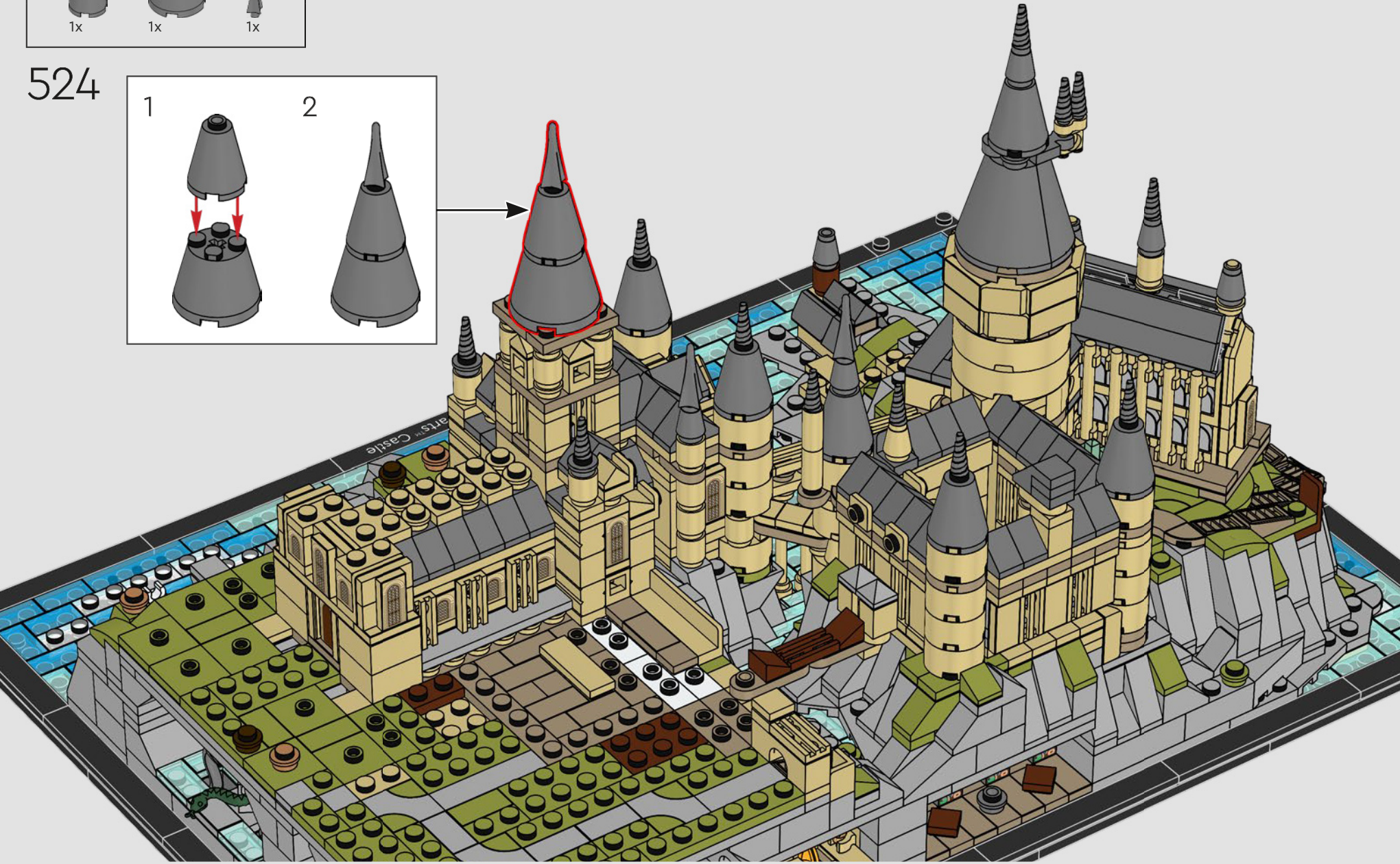
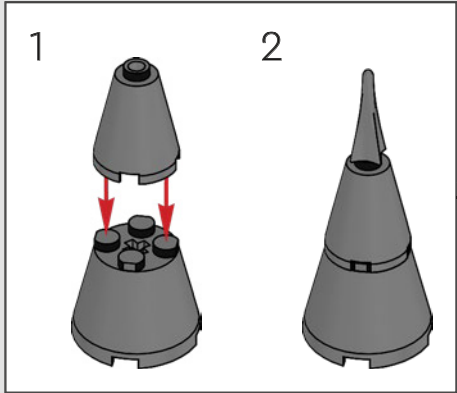

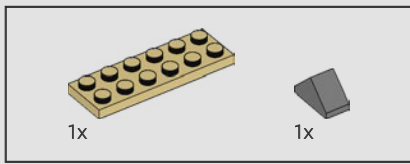

525

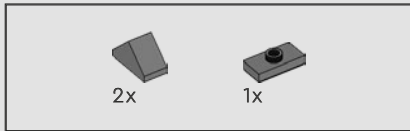
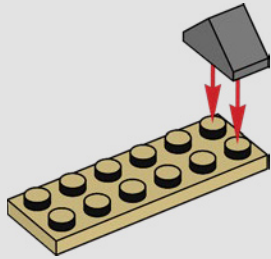

526

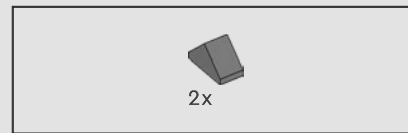
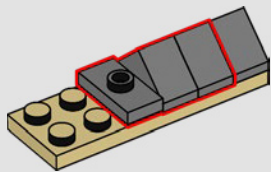

527

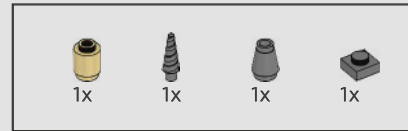
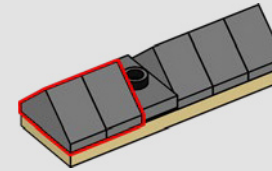

528

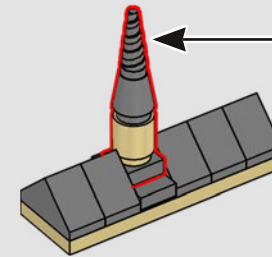
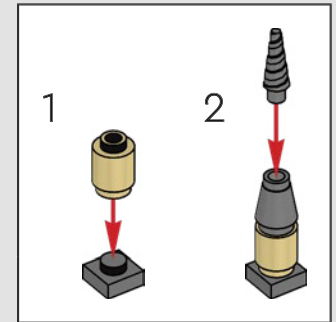

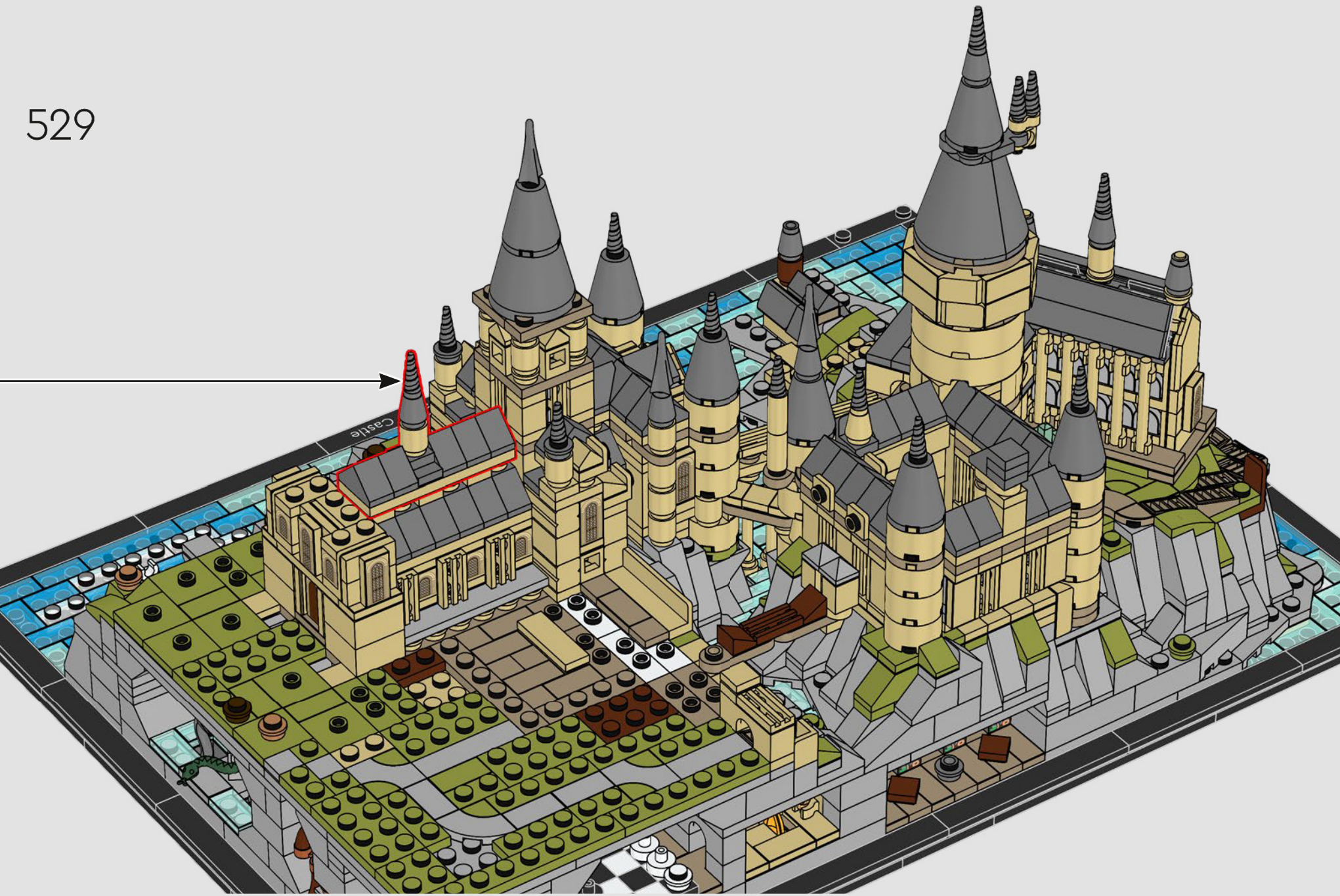



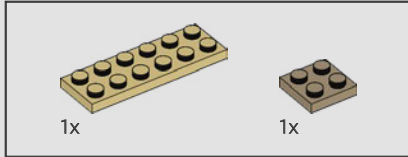
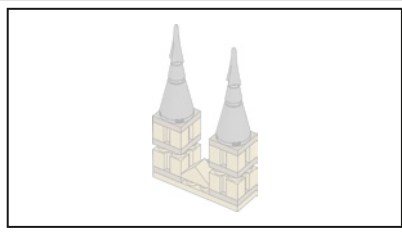

530

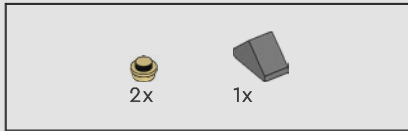
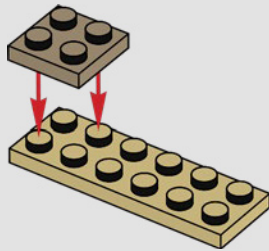

531

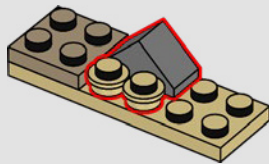

532

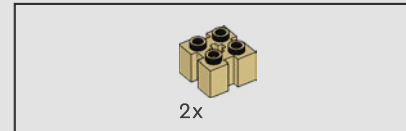
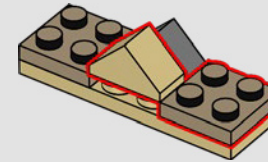

533

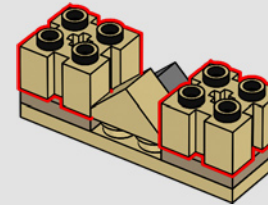



8x

534

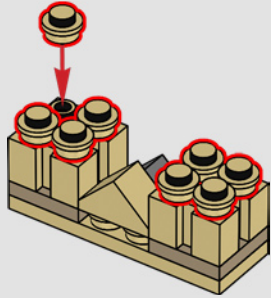

2x

535

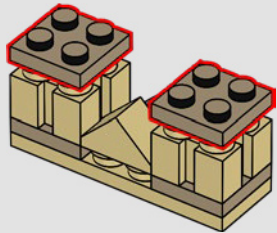

2x

536

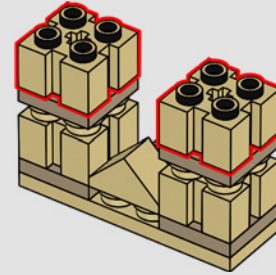

2x

537

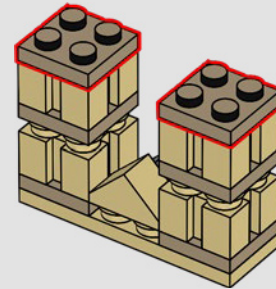

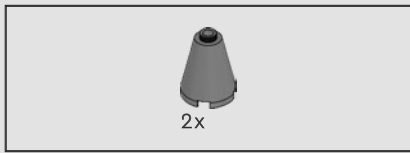

538

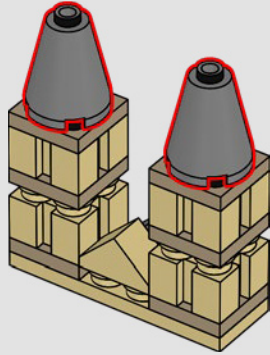

539

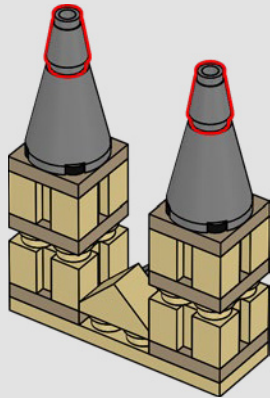

540

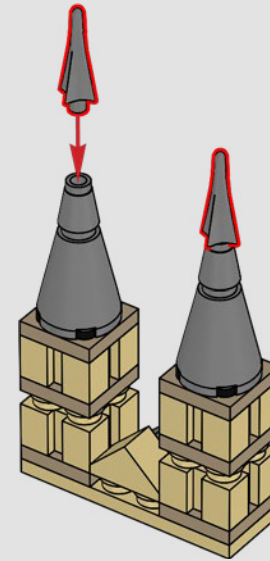



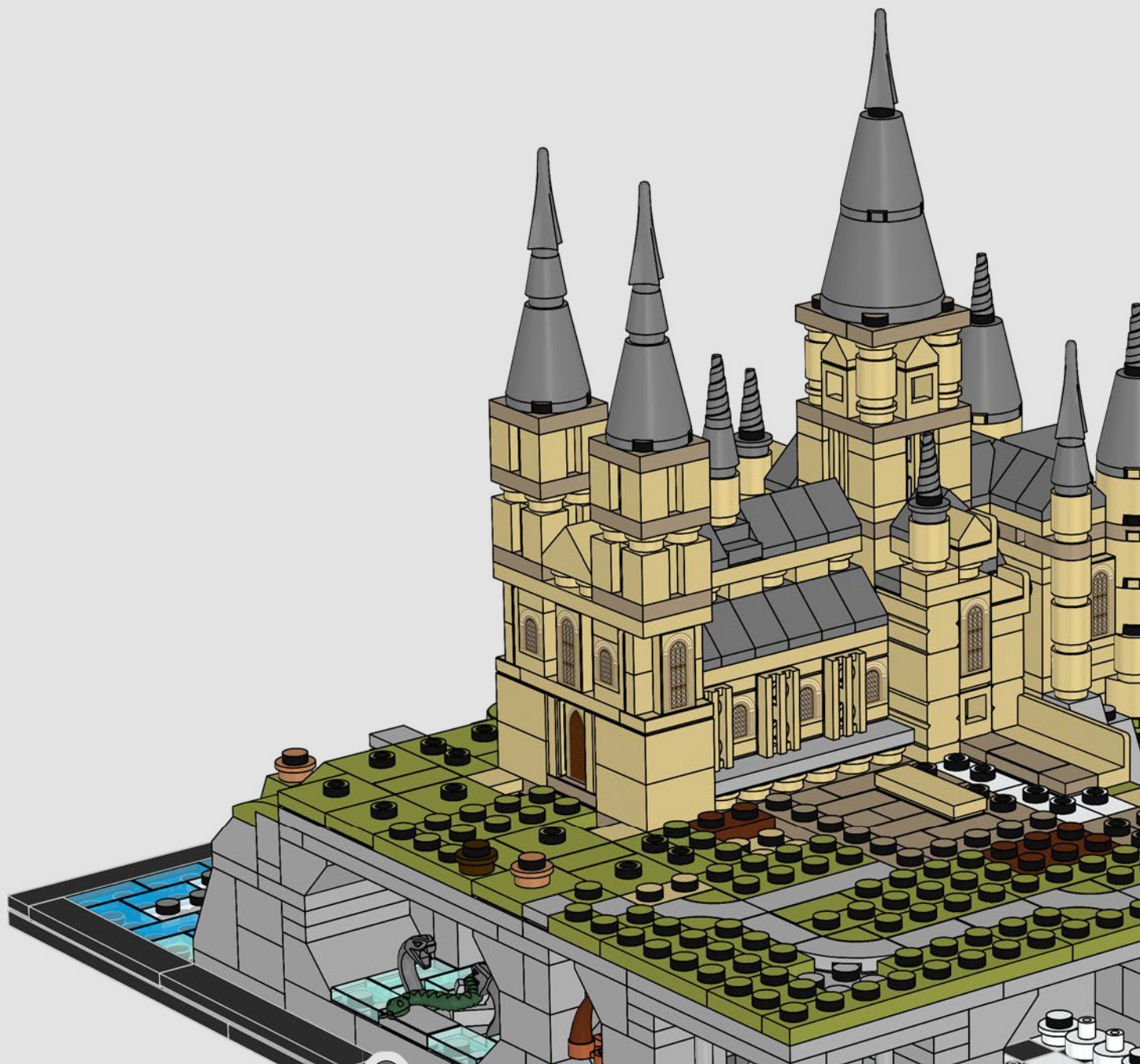

No matter what a Hogwarts™ student's favourite subjects are, they will likely spend a great deal of their time in the East Wing, where many of the classrooms are located.



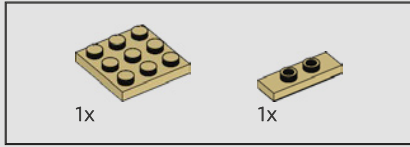
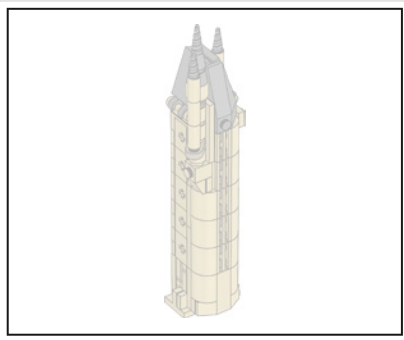

542

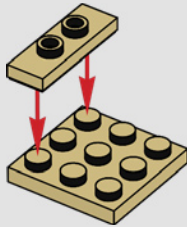

543

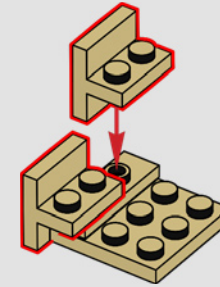

544

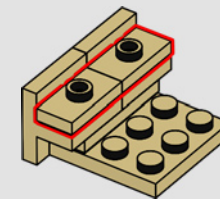



2x

545

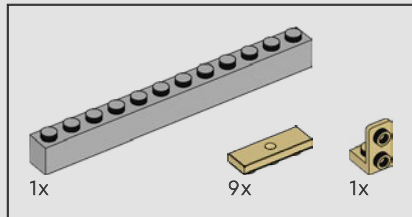
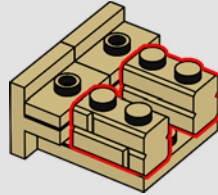

546

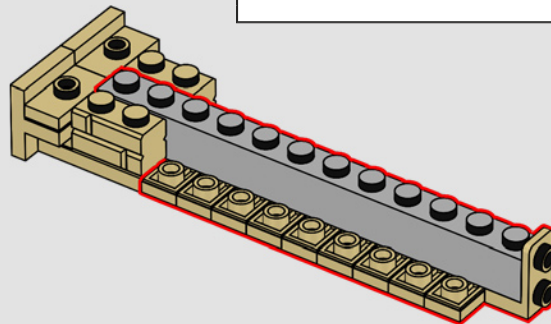
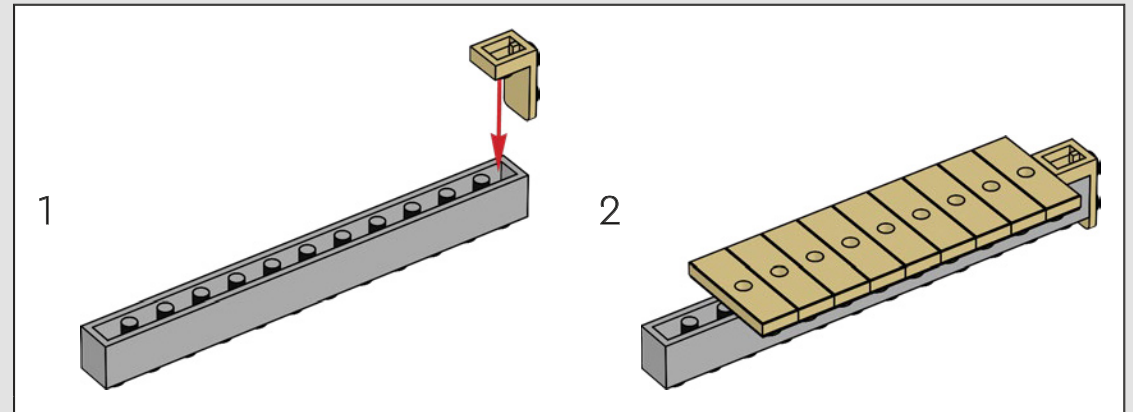



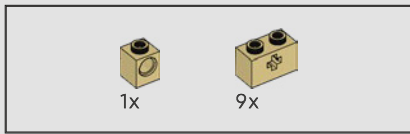

547

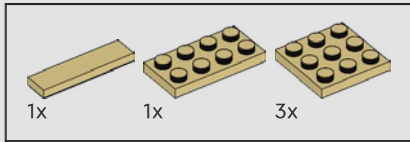
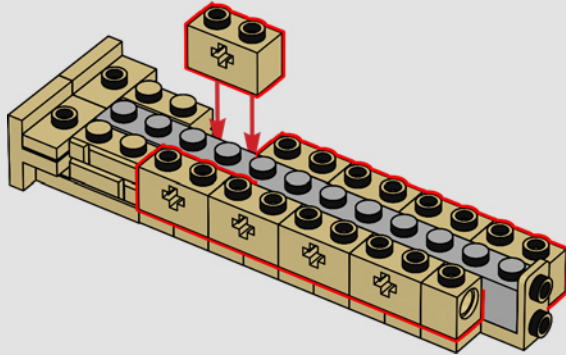

548

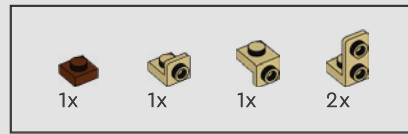
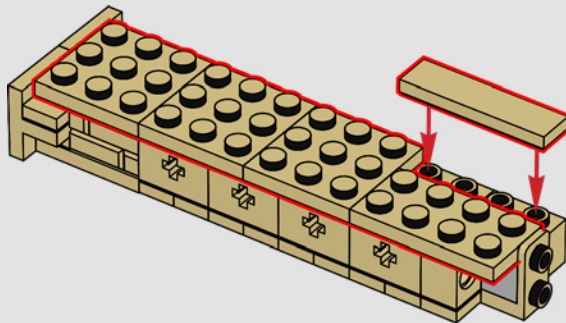

549

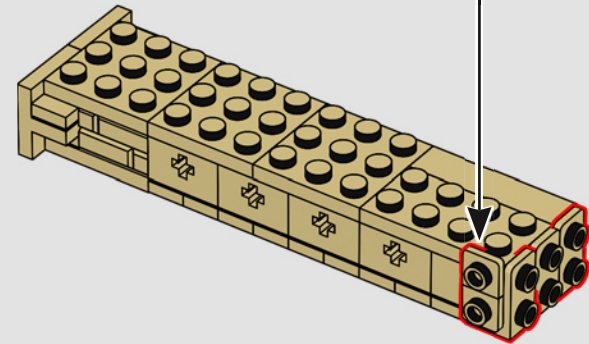
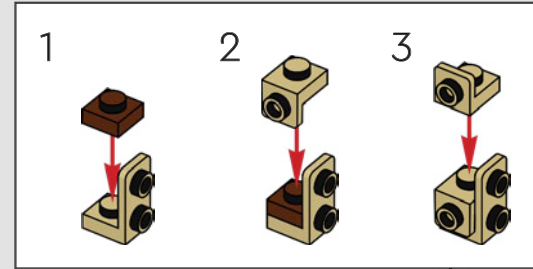

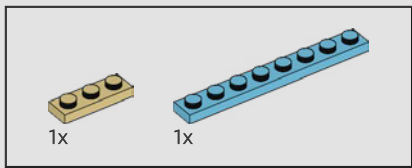

550

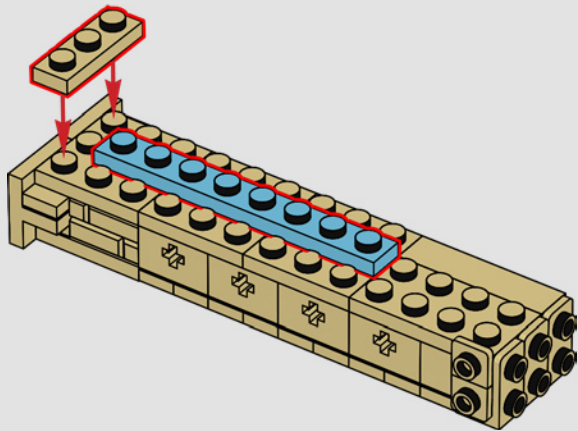

551

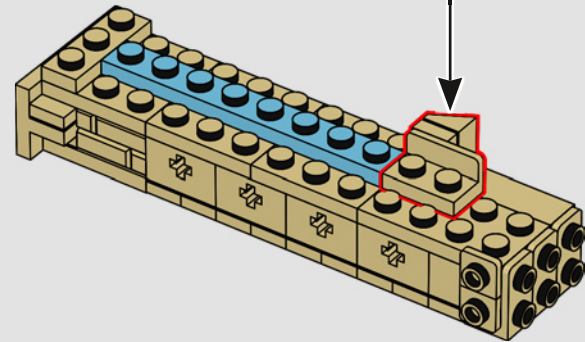
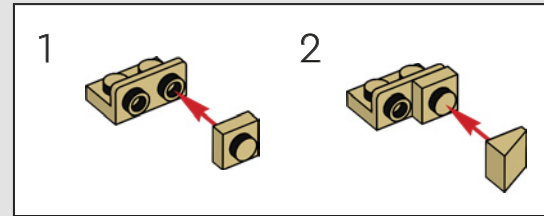

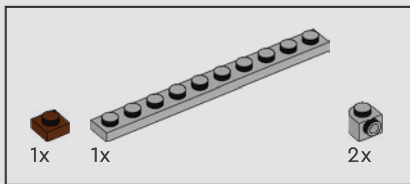

552

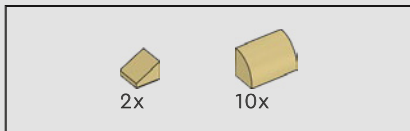
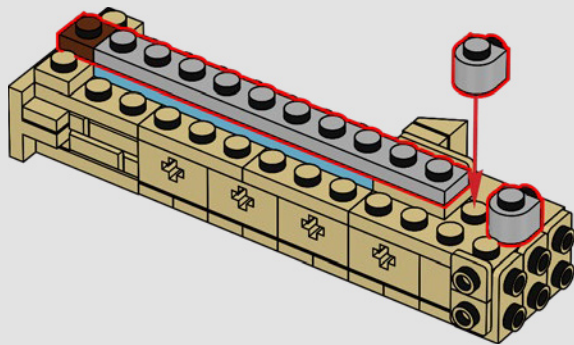

553

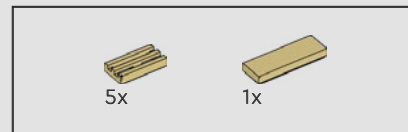
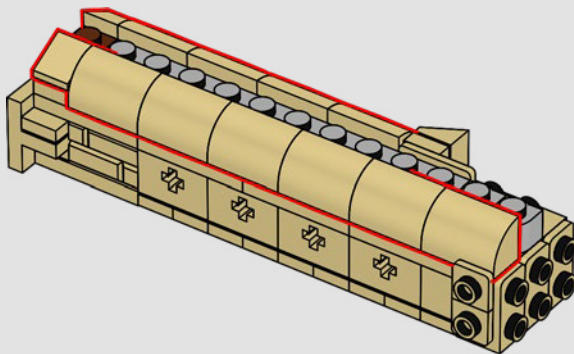

554

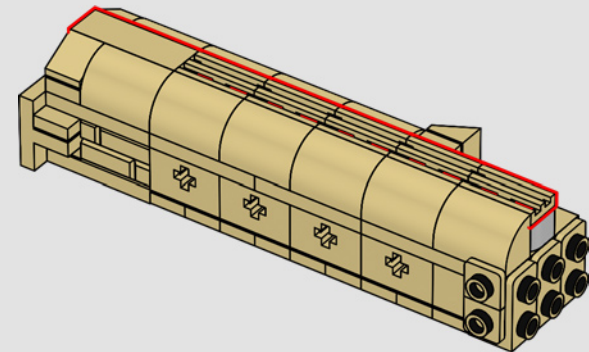



1x

555

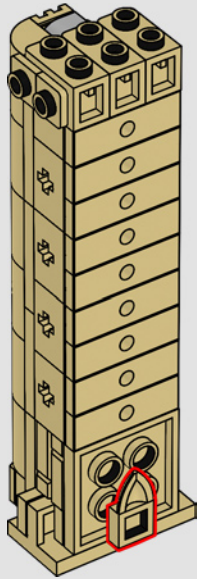

2x

556

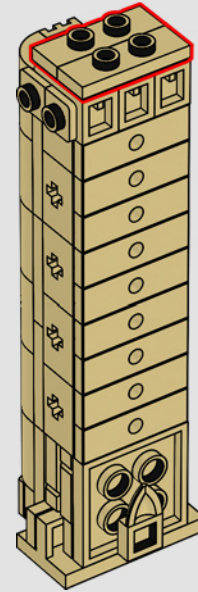

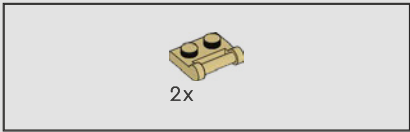

557

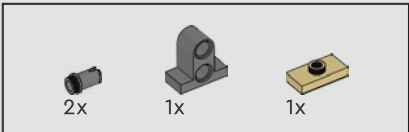
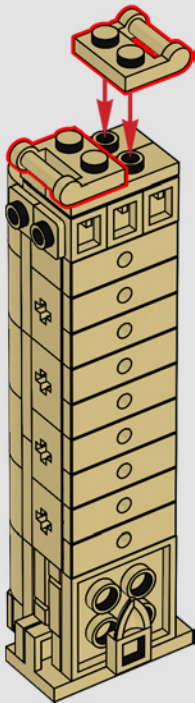

558

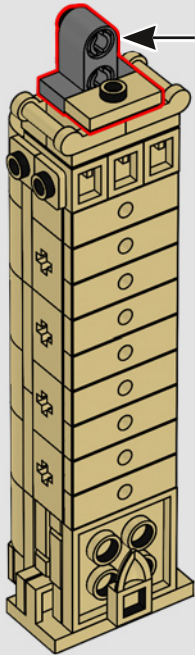
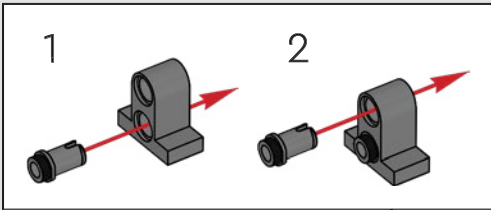



559

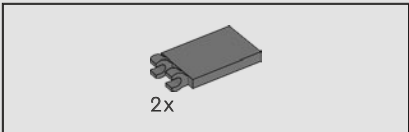

560

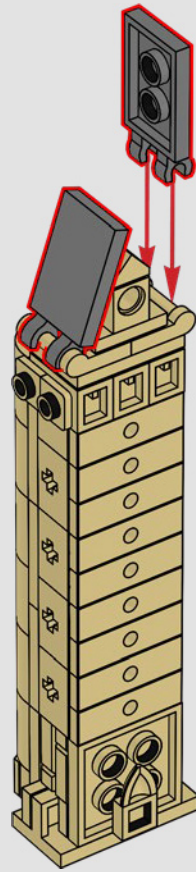



561

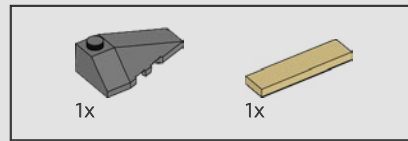
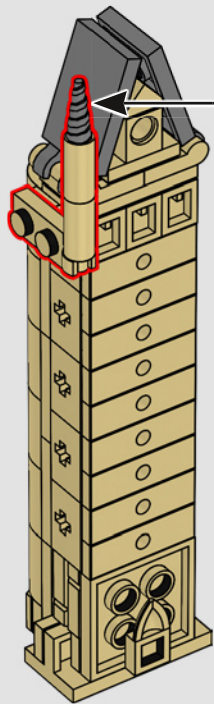
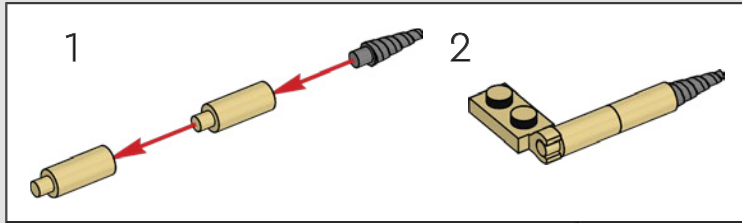

562

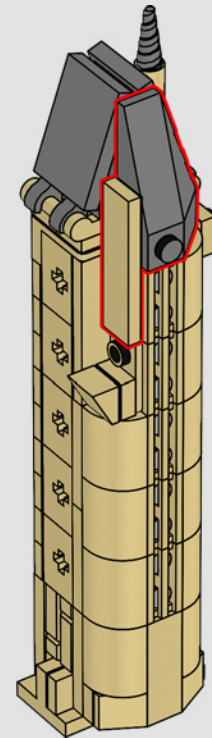

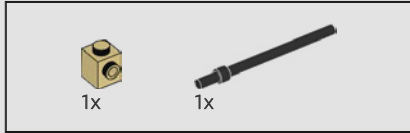
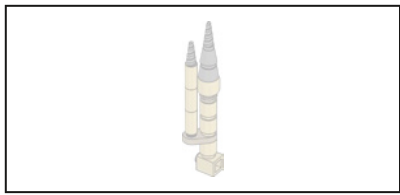

563

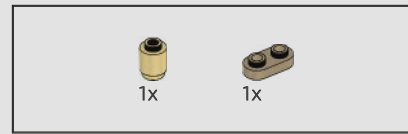

564

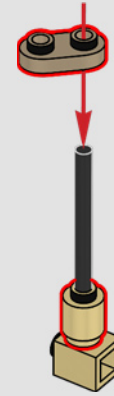

565







566

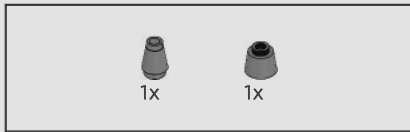

567

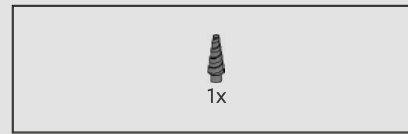
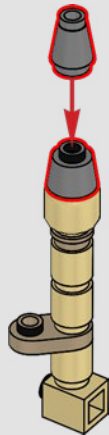

568

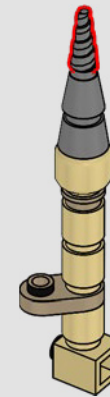

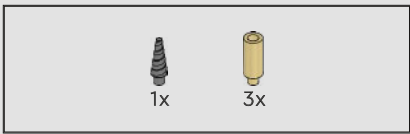

569

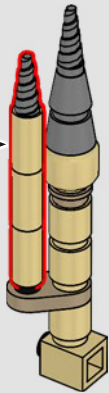
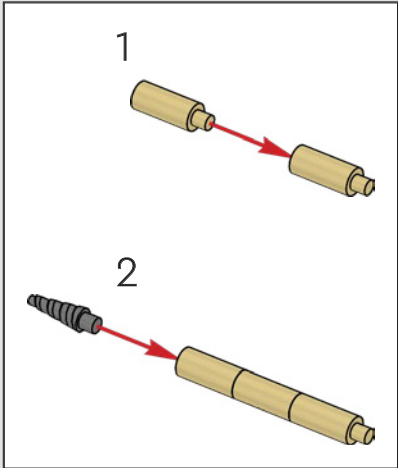

570

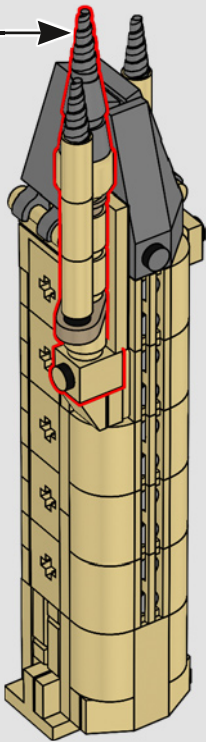

571



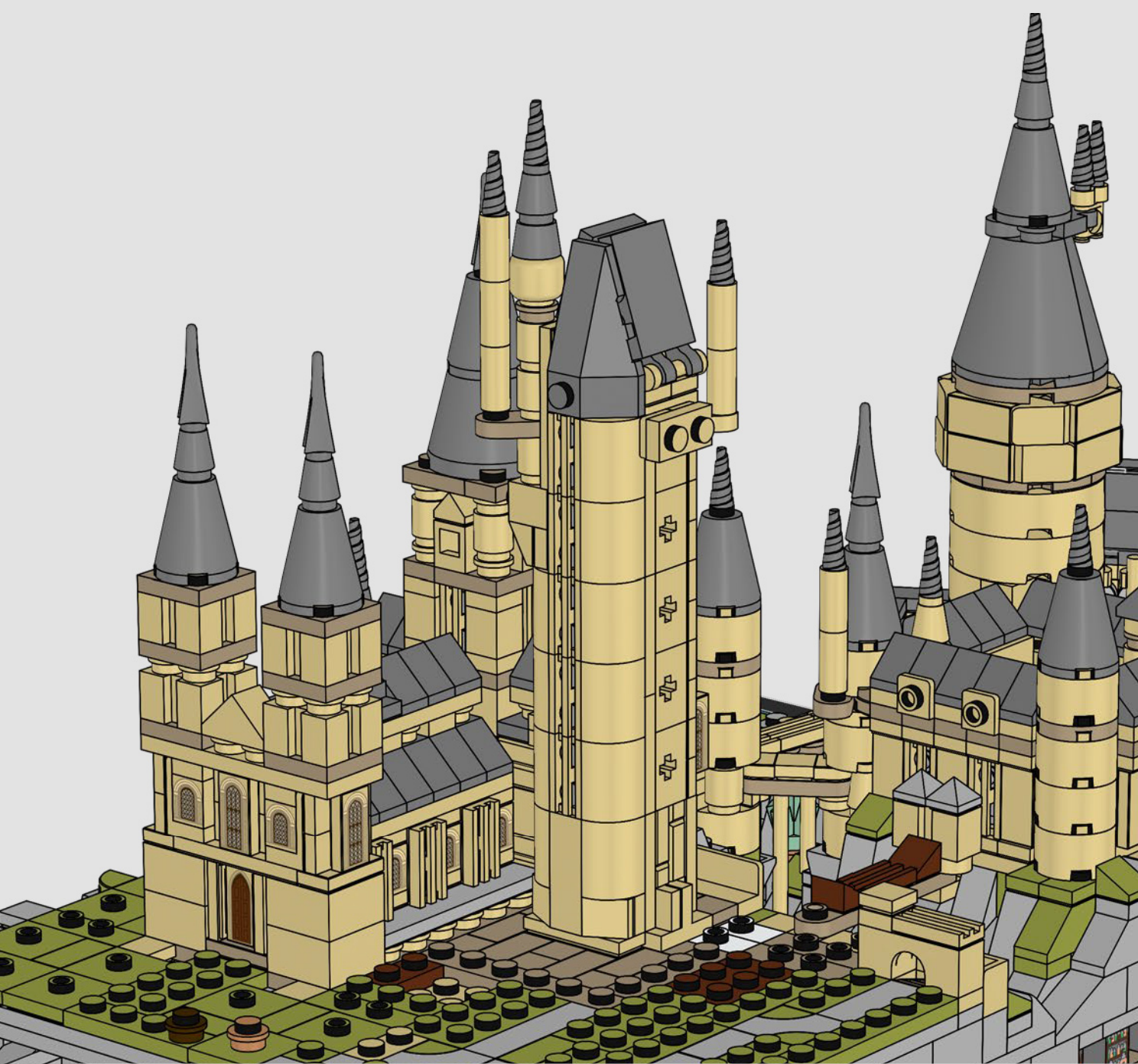

You might think the main tower would be the tallest point of the Hogwarts™ castle – but it is actually the Astronomy Tower.



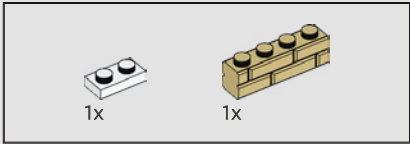
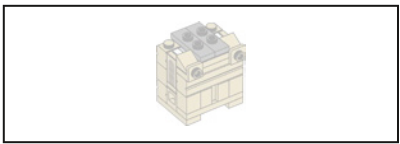

572

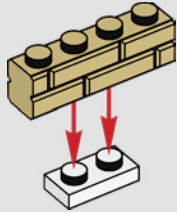

573

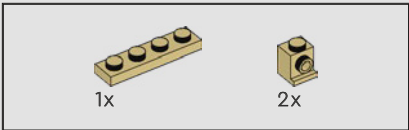
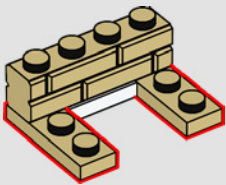

574

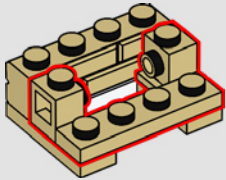

575

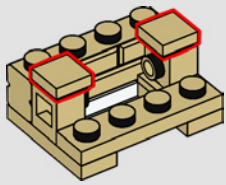

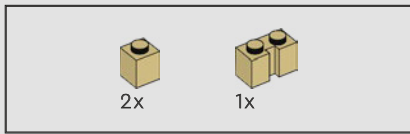

576

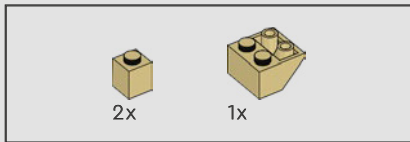
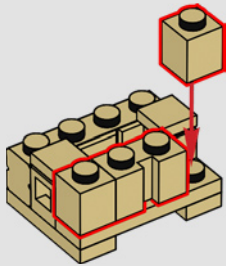

577

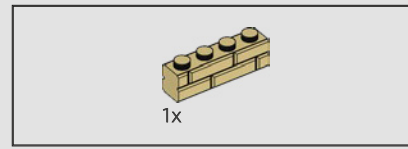
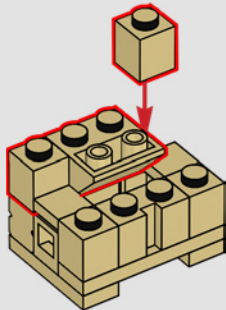

578

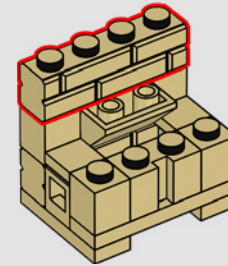

579

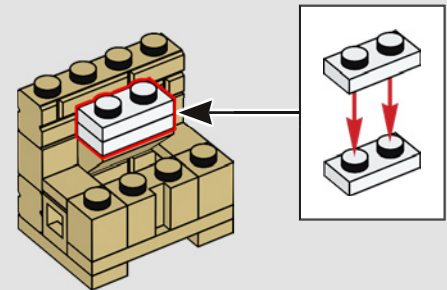

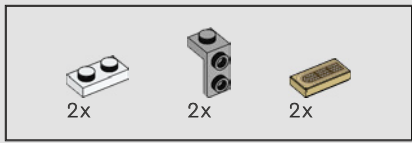

580

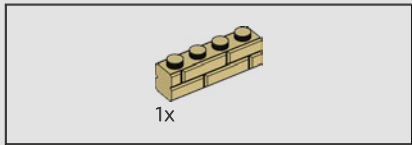
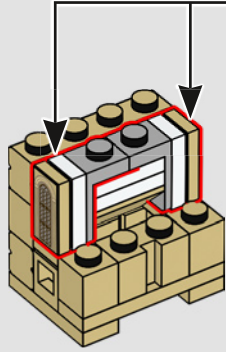
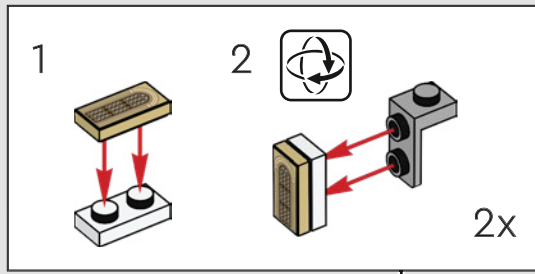

581

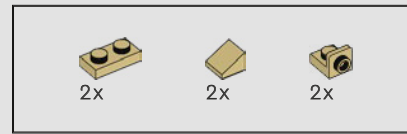
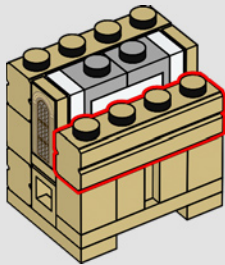

582

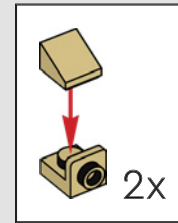
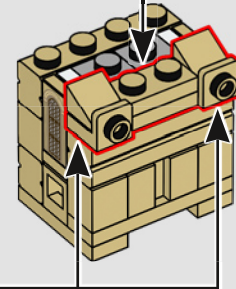
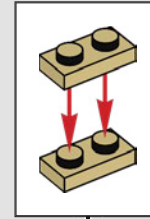

583

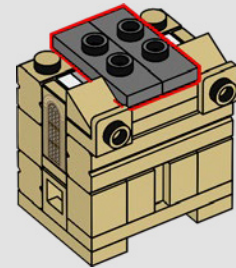



584

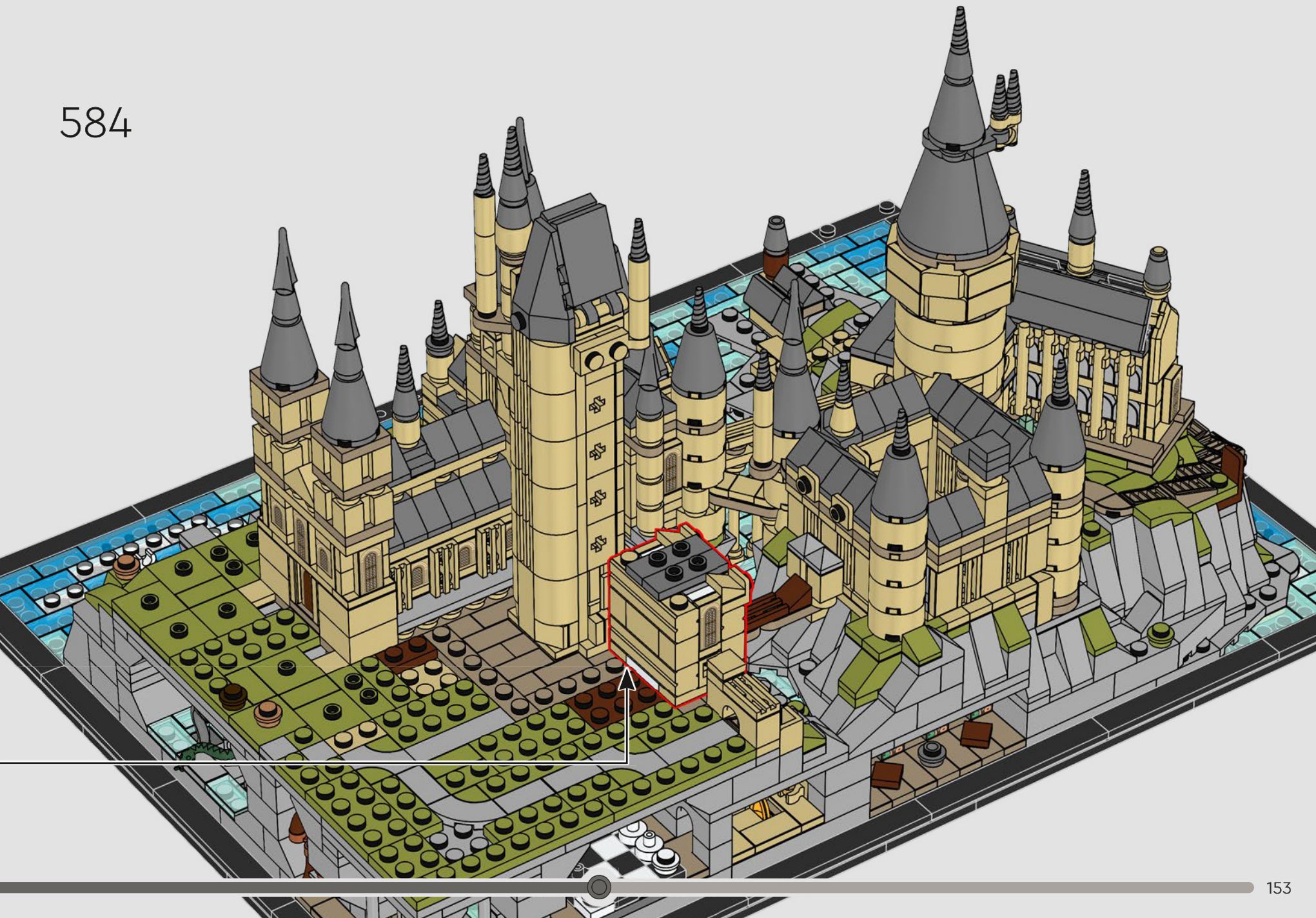

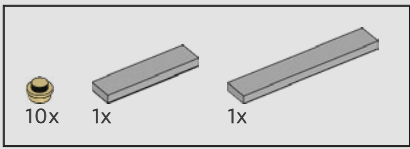

585

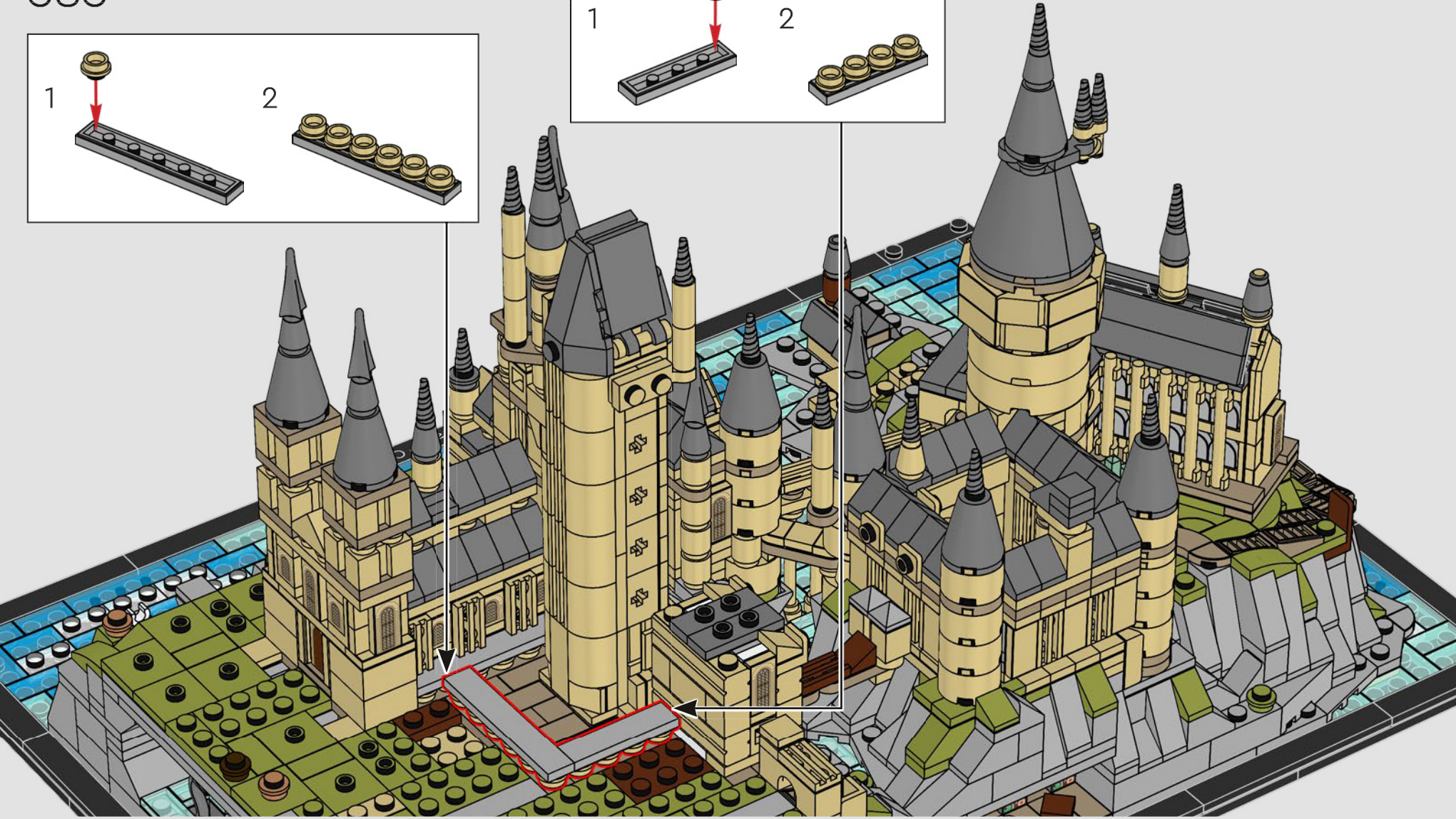
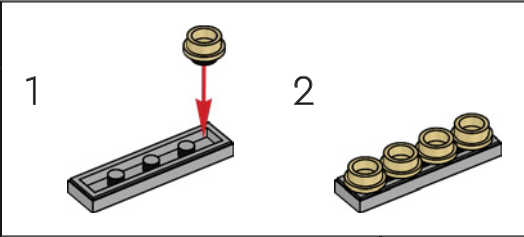
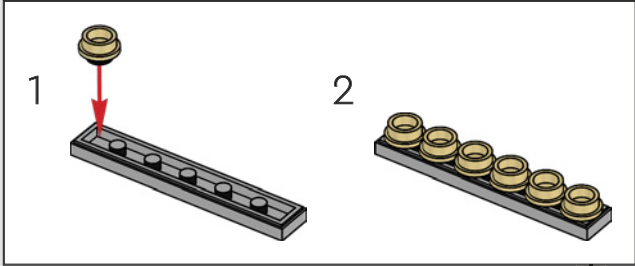

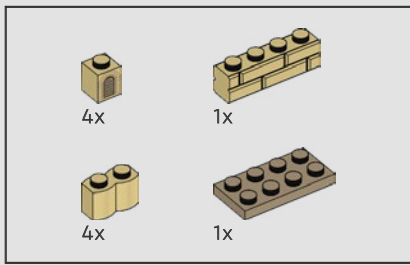

586

1

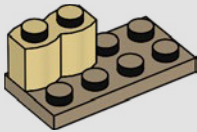

2

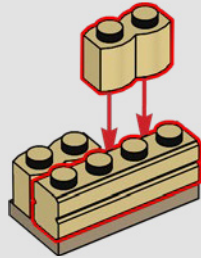

3

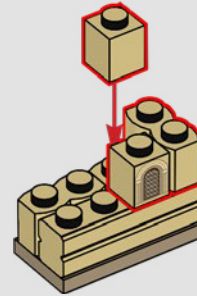

4

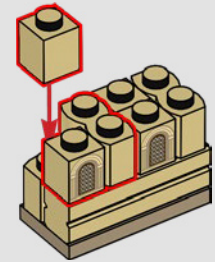





587



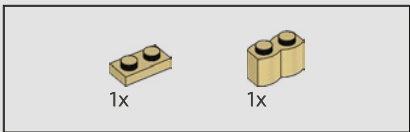

588

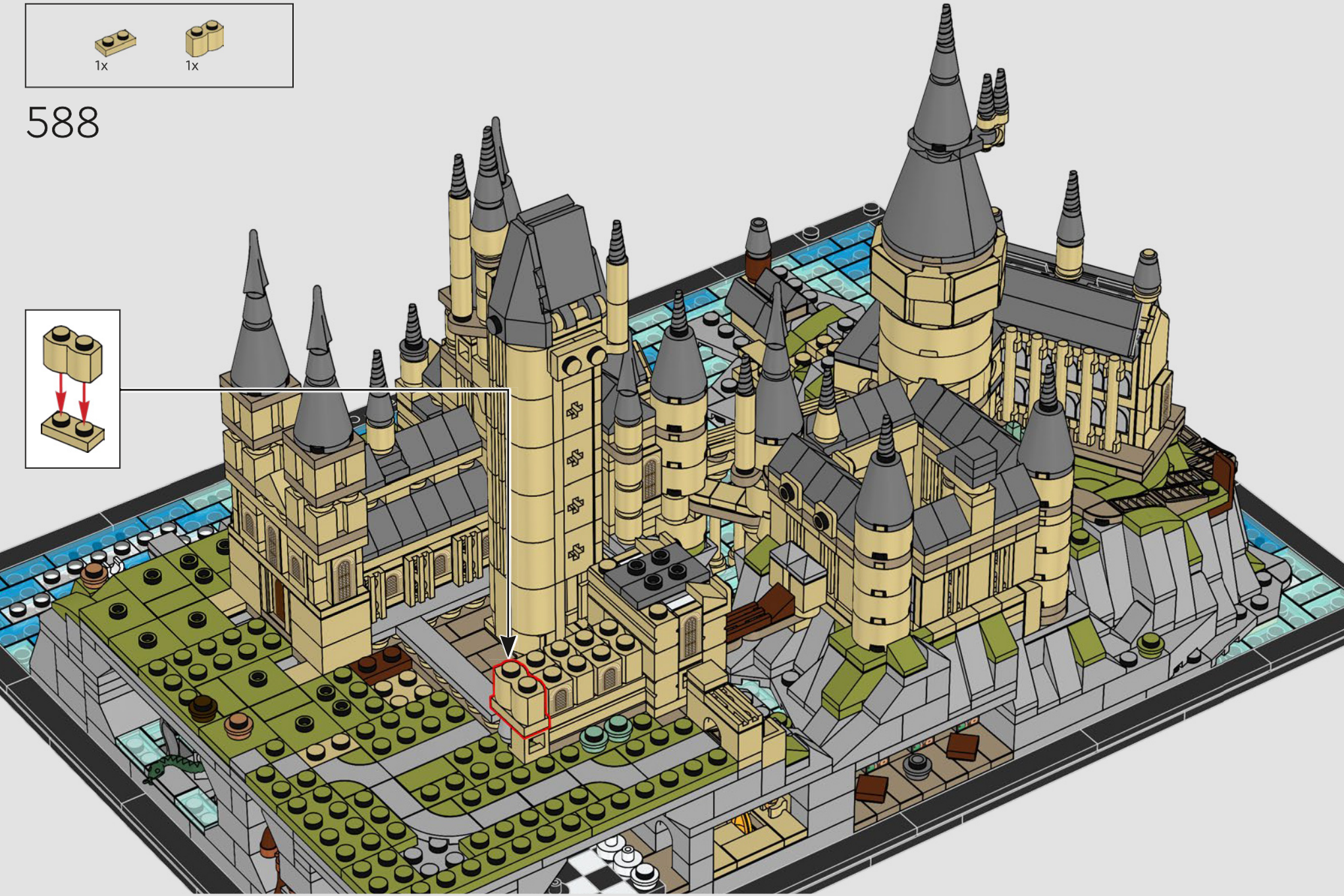
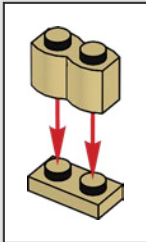

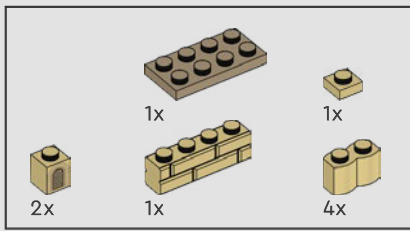

589

1

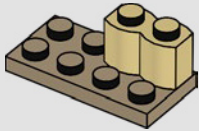

2

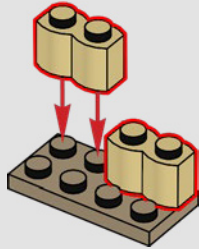

3

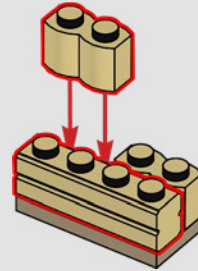

4

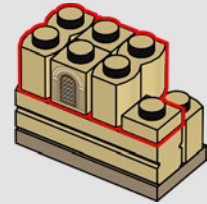

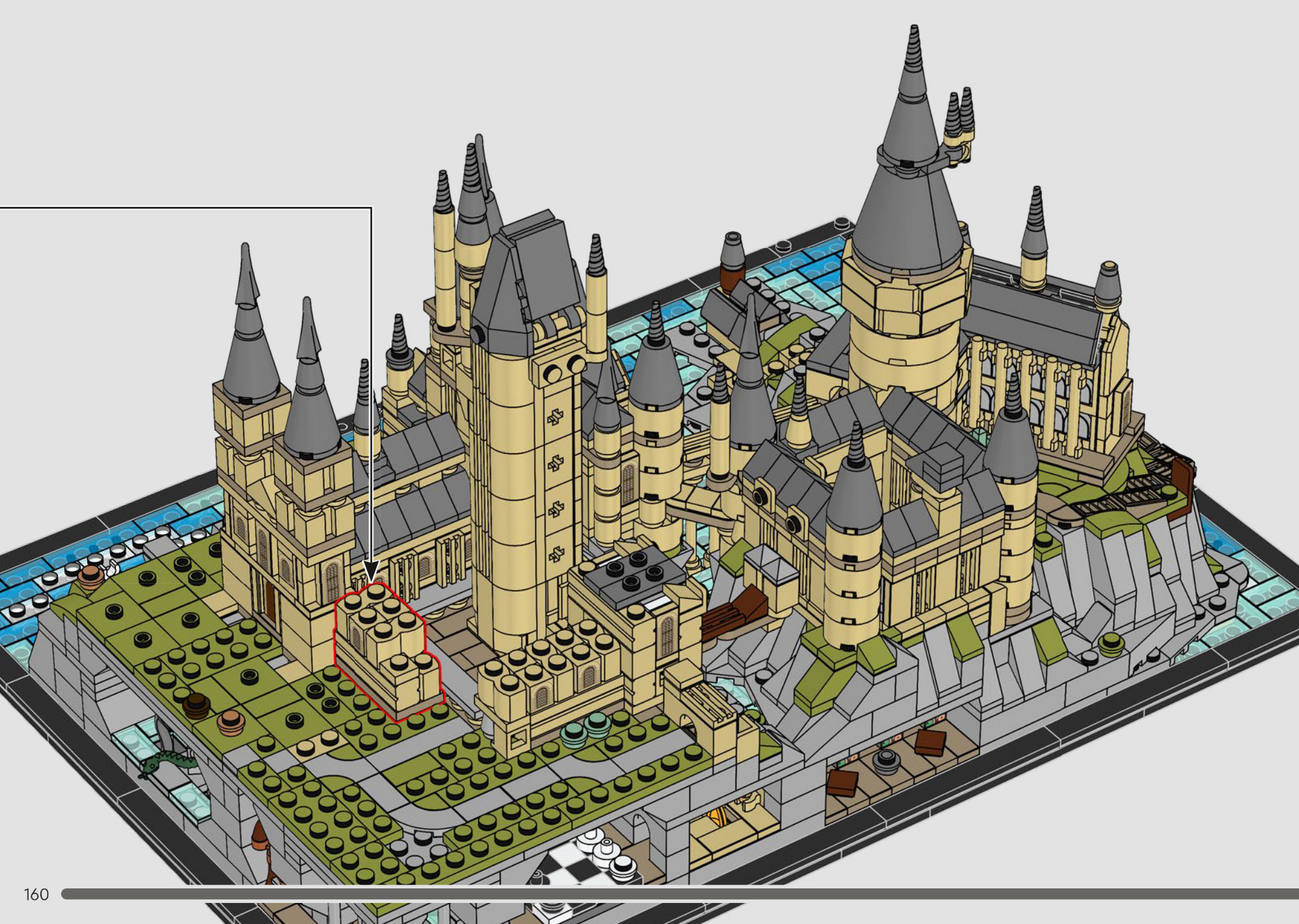



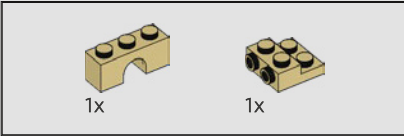
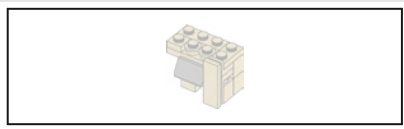

590

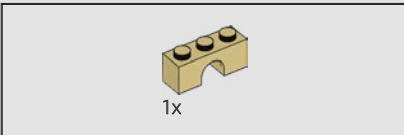
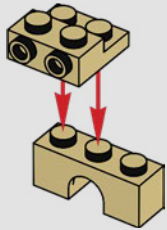

591

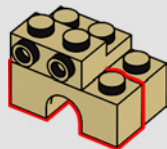

592

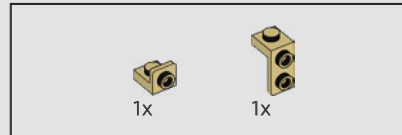
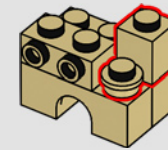

593

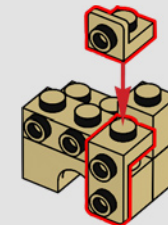

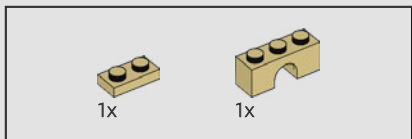

594

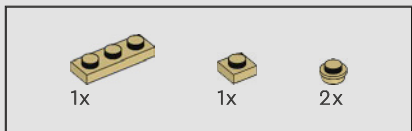
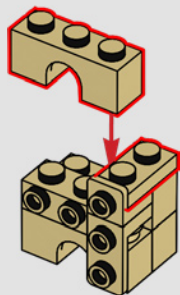

595

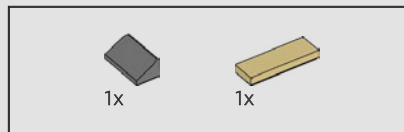
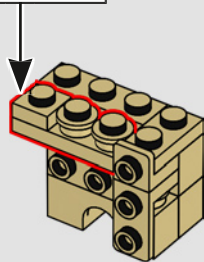
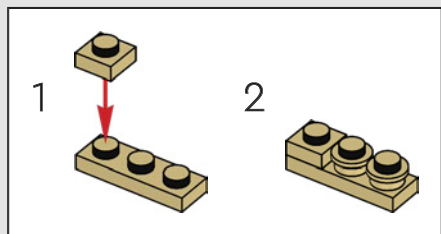

596

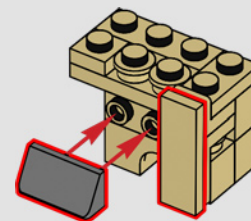

597



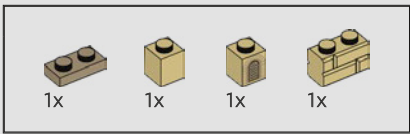

598

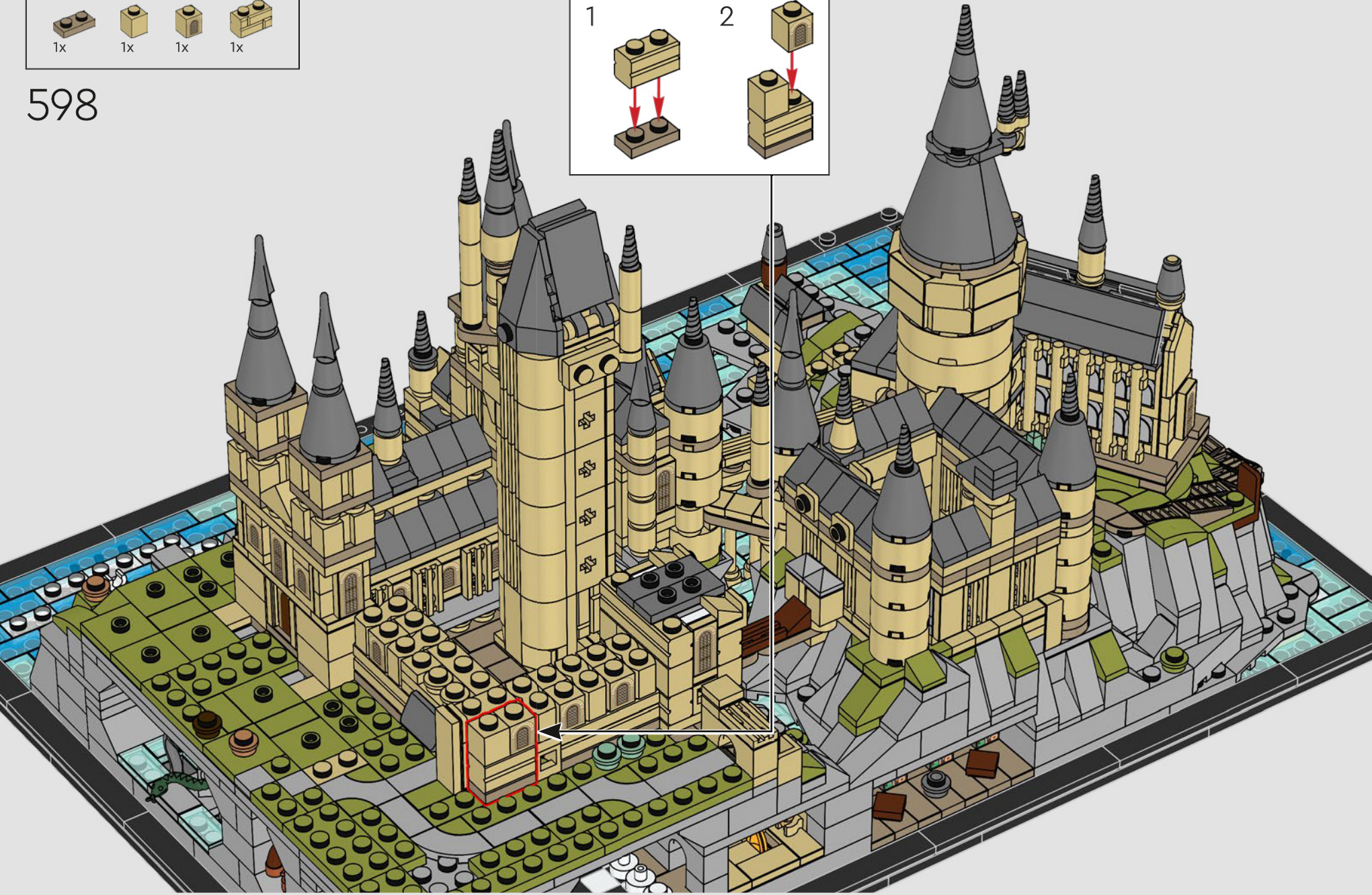
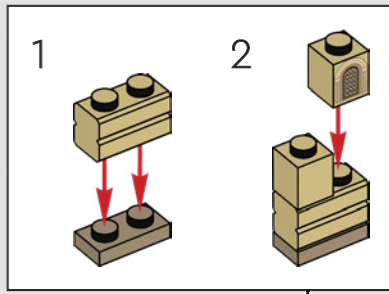

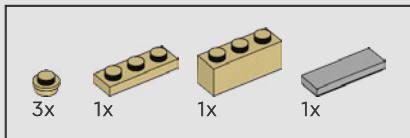

599

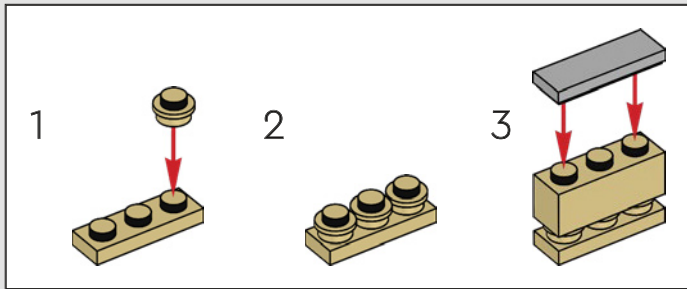

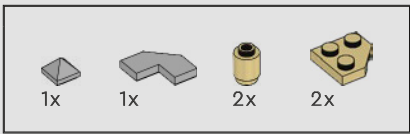

600

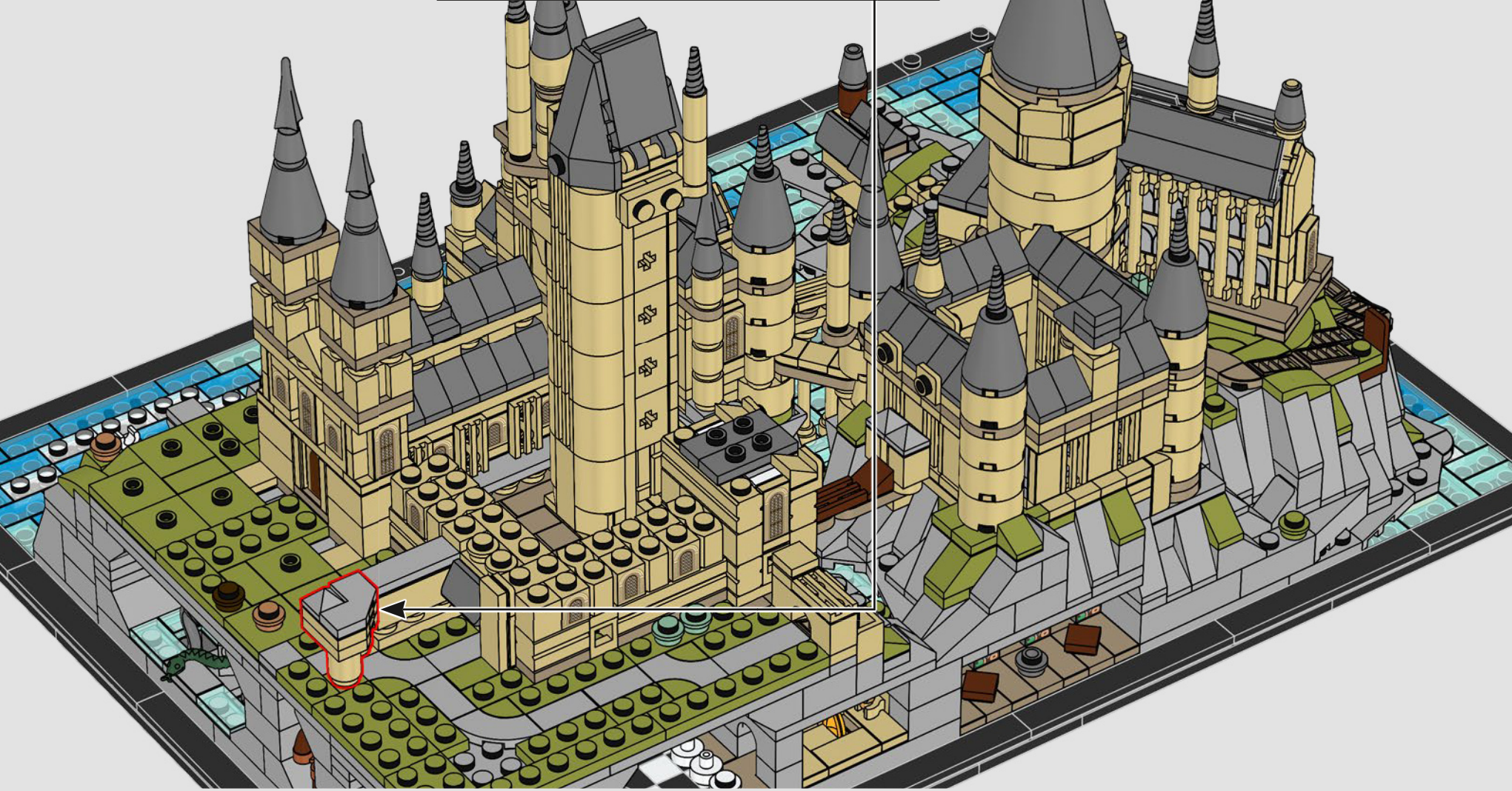
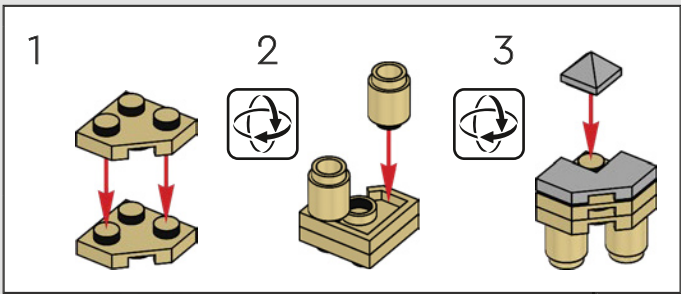

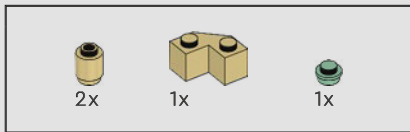

601

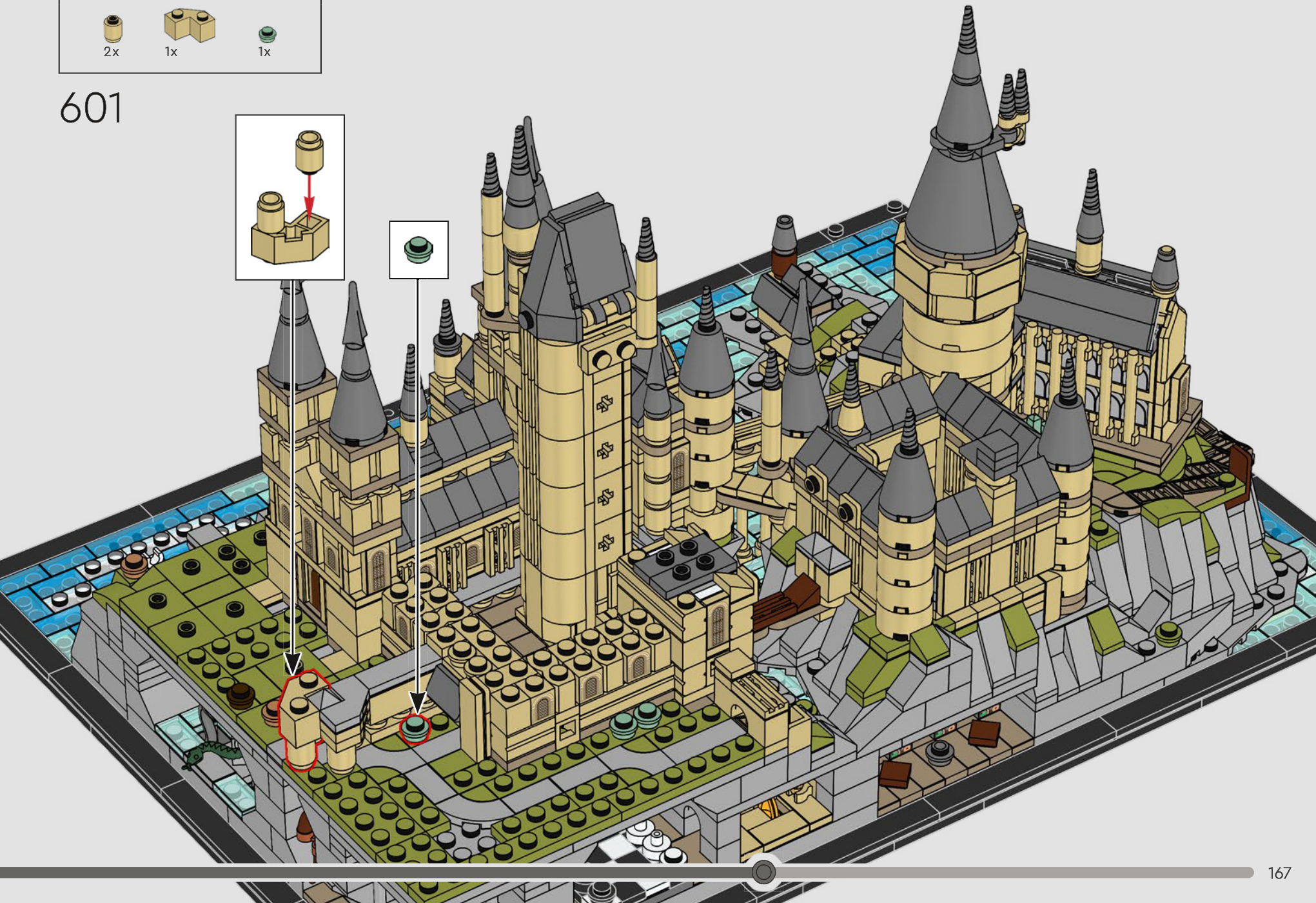
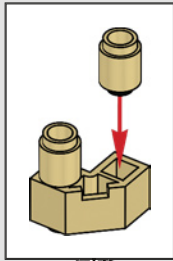





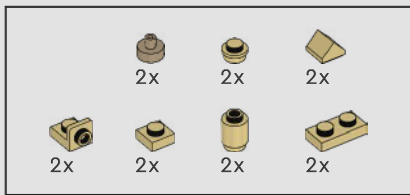

602

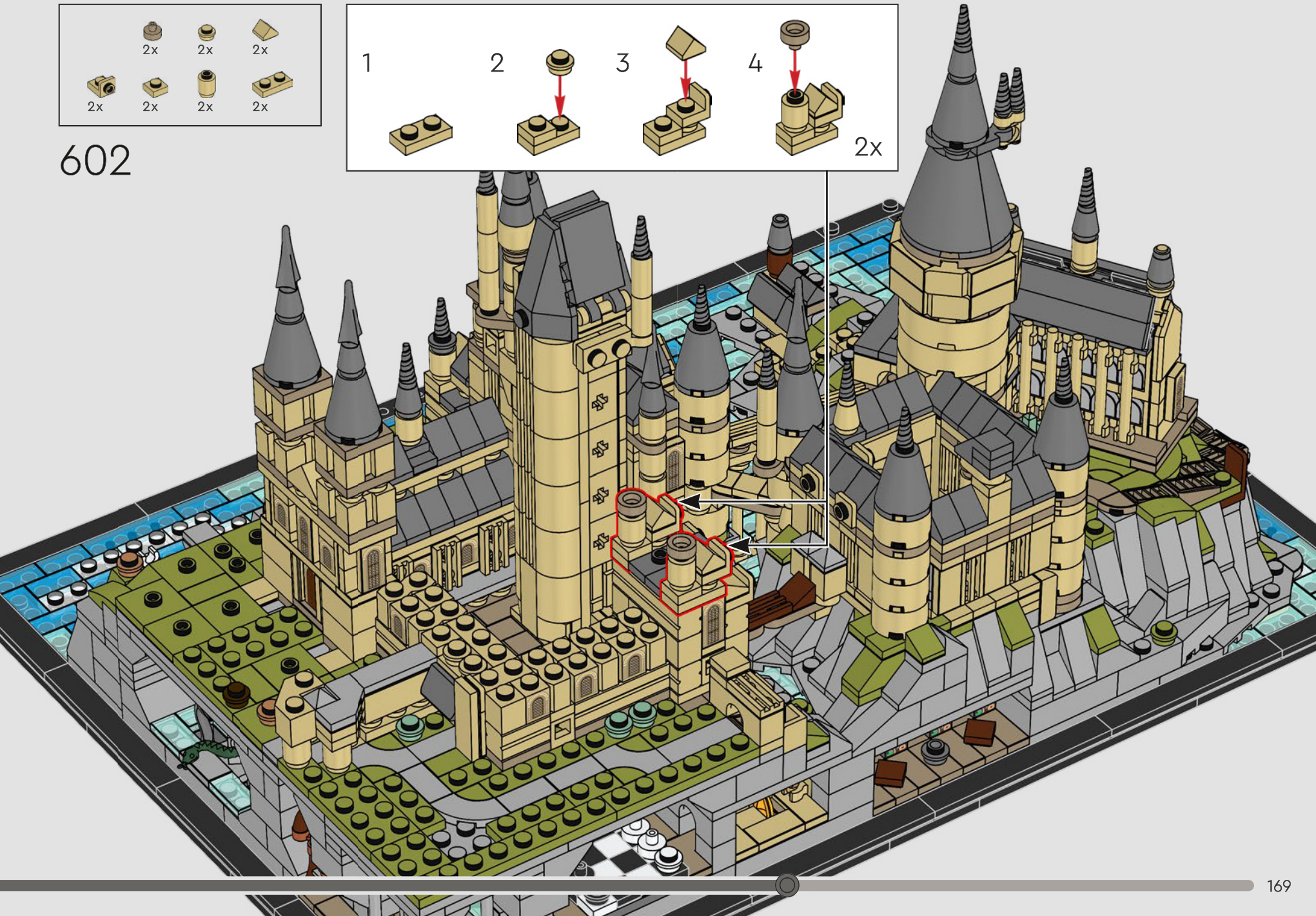
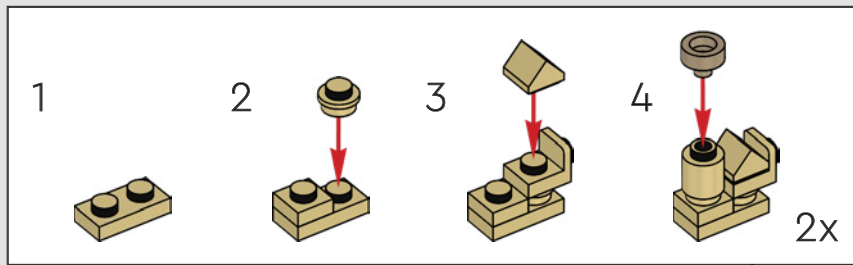

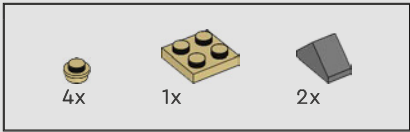

603

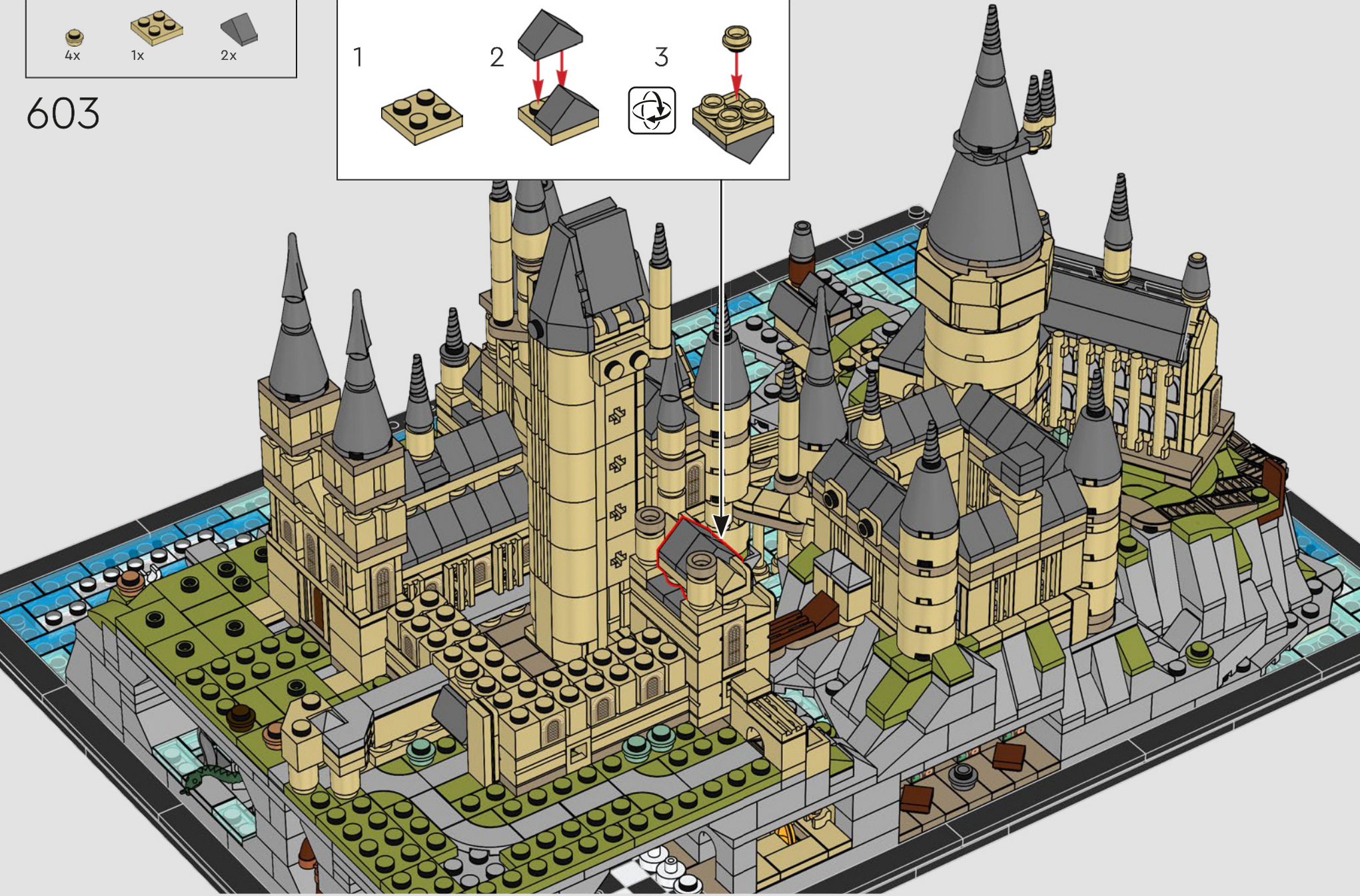
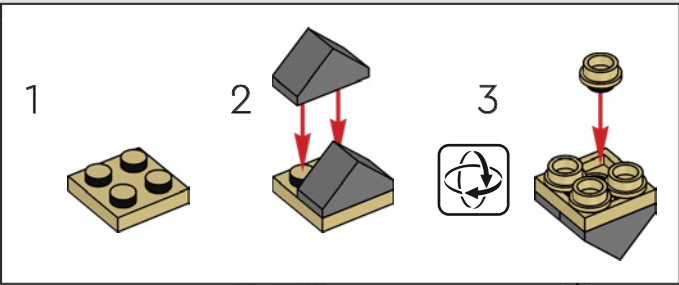

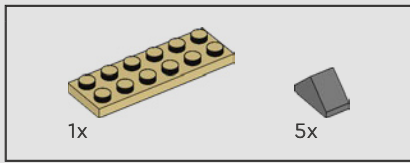

604

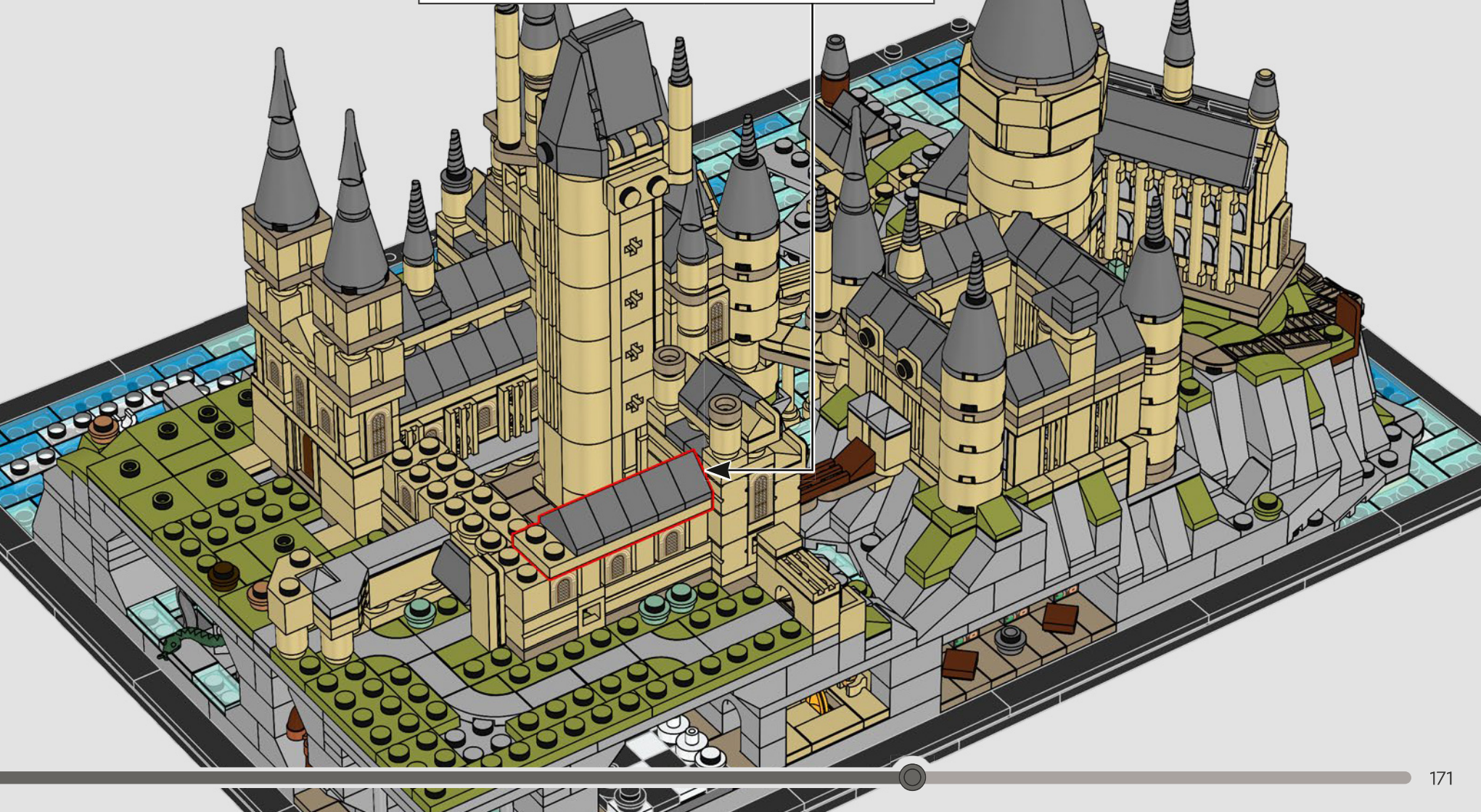
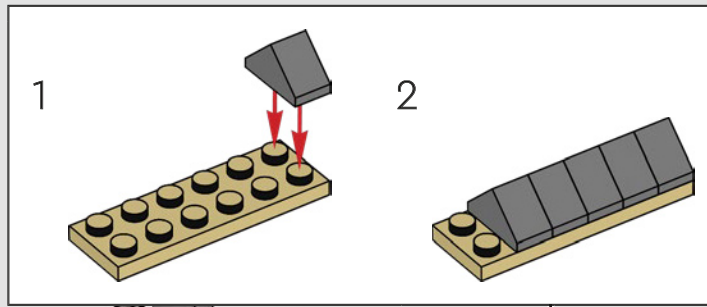

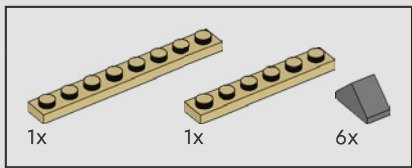

605

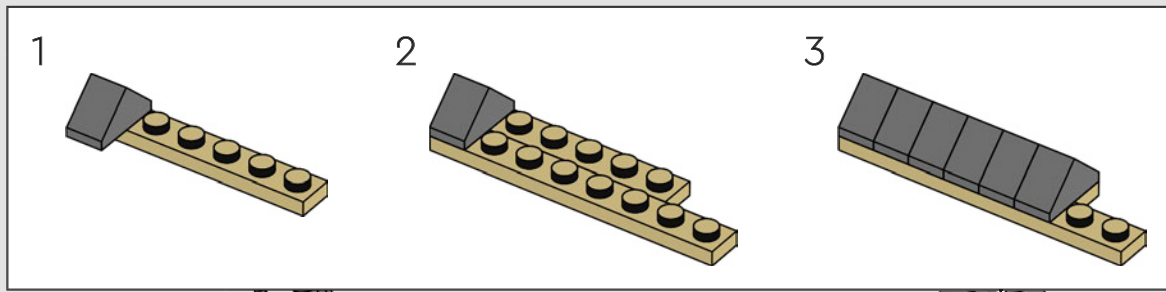

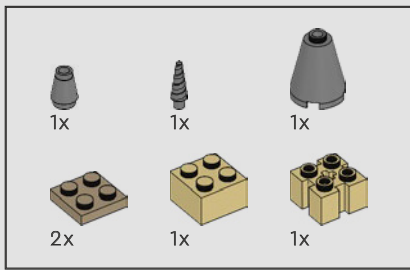

606

1

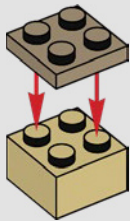

2

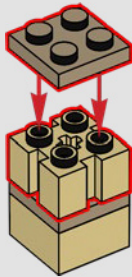

3

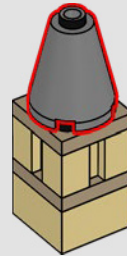

4

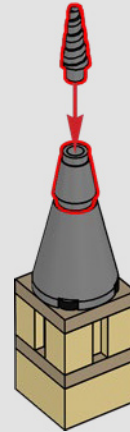





Hogwarts™ is a huge castle, where it can be tricky to find your way. But did you know that the castle has 142 staircases? With the staircases constantly changing, it doesn't make it easier finding your way around.

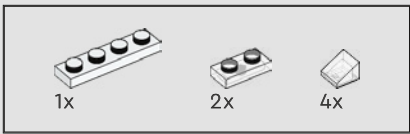

607

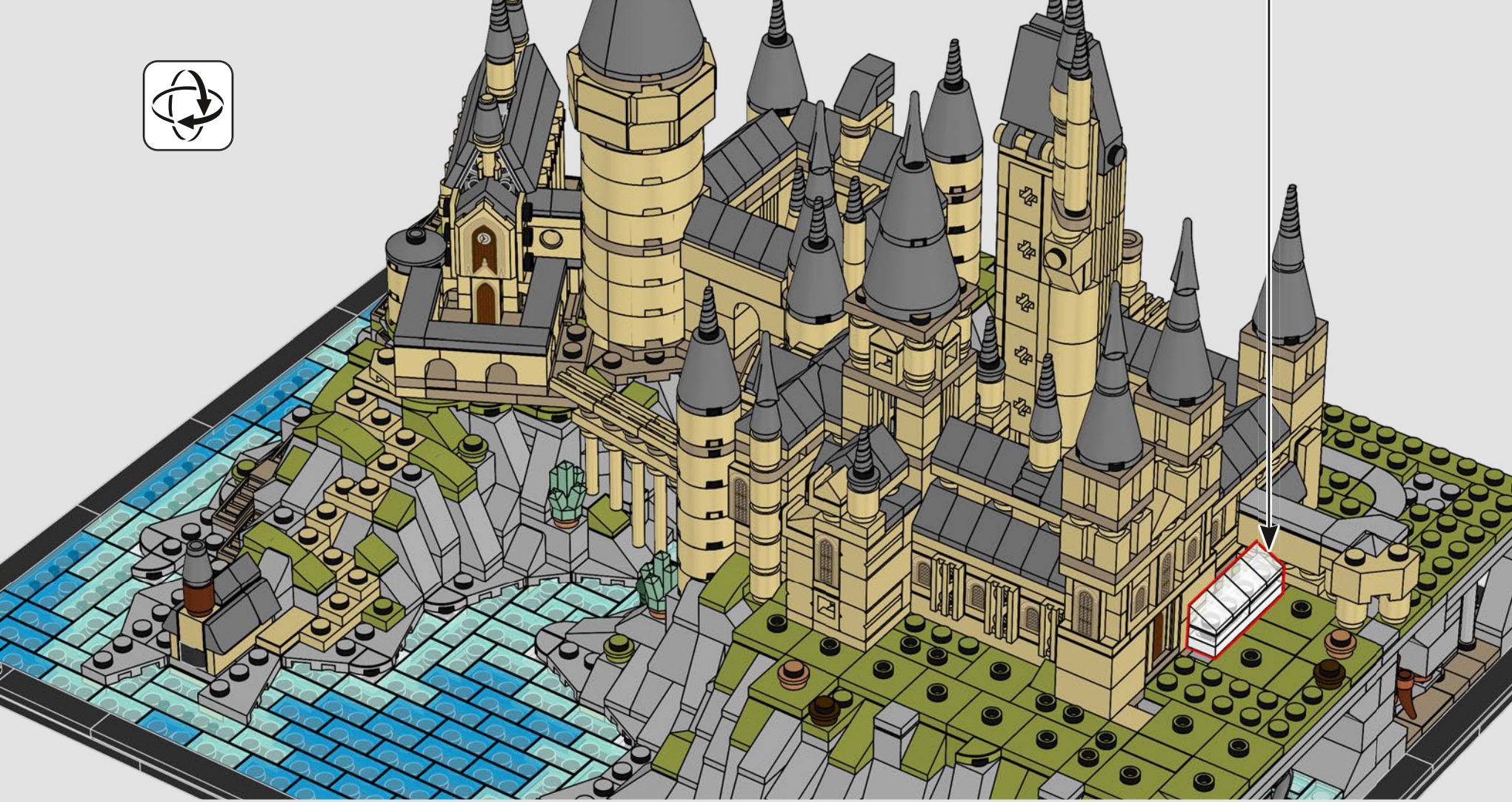
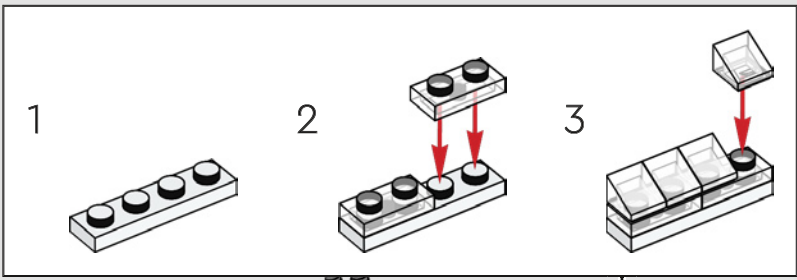



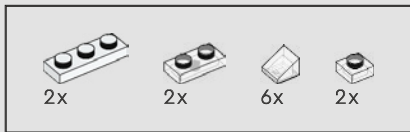

608

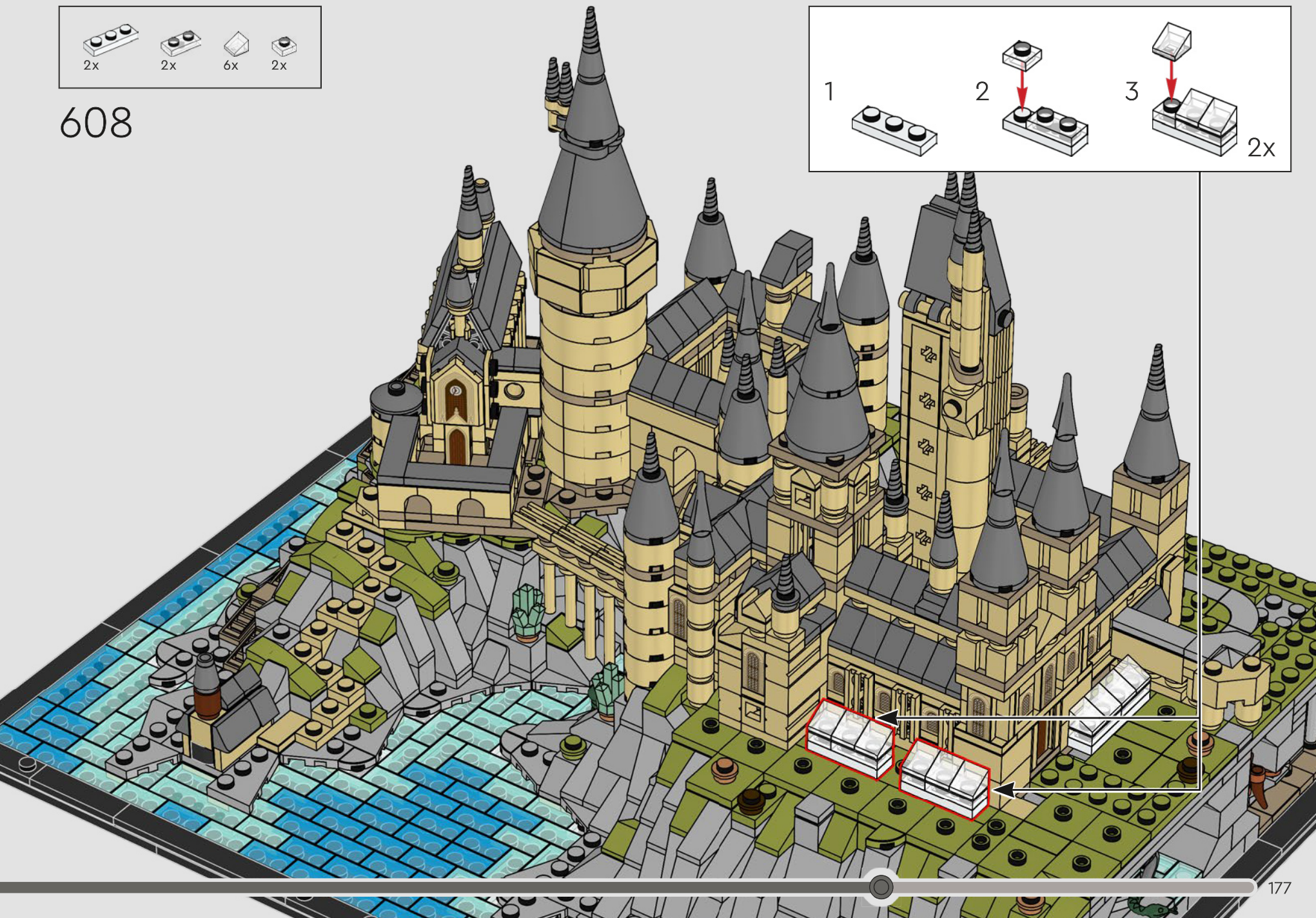
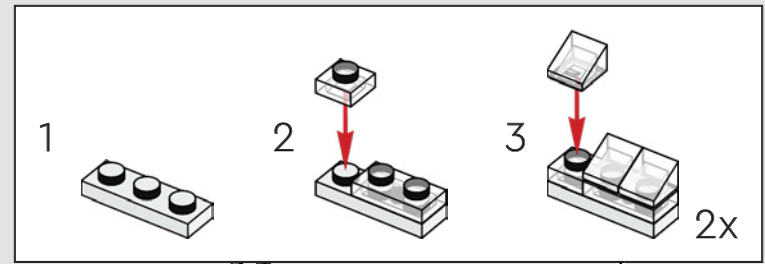



609

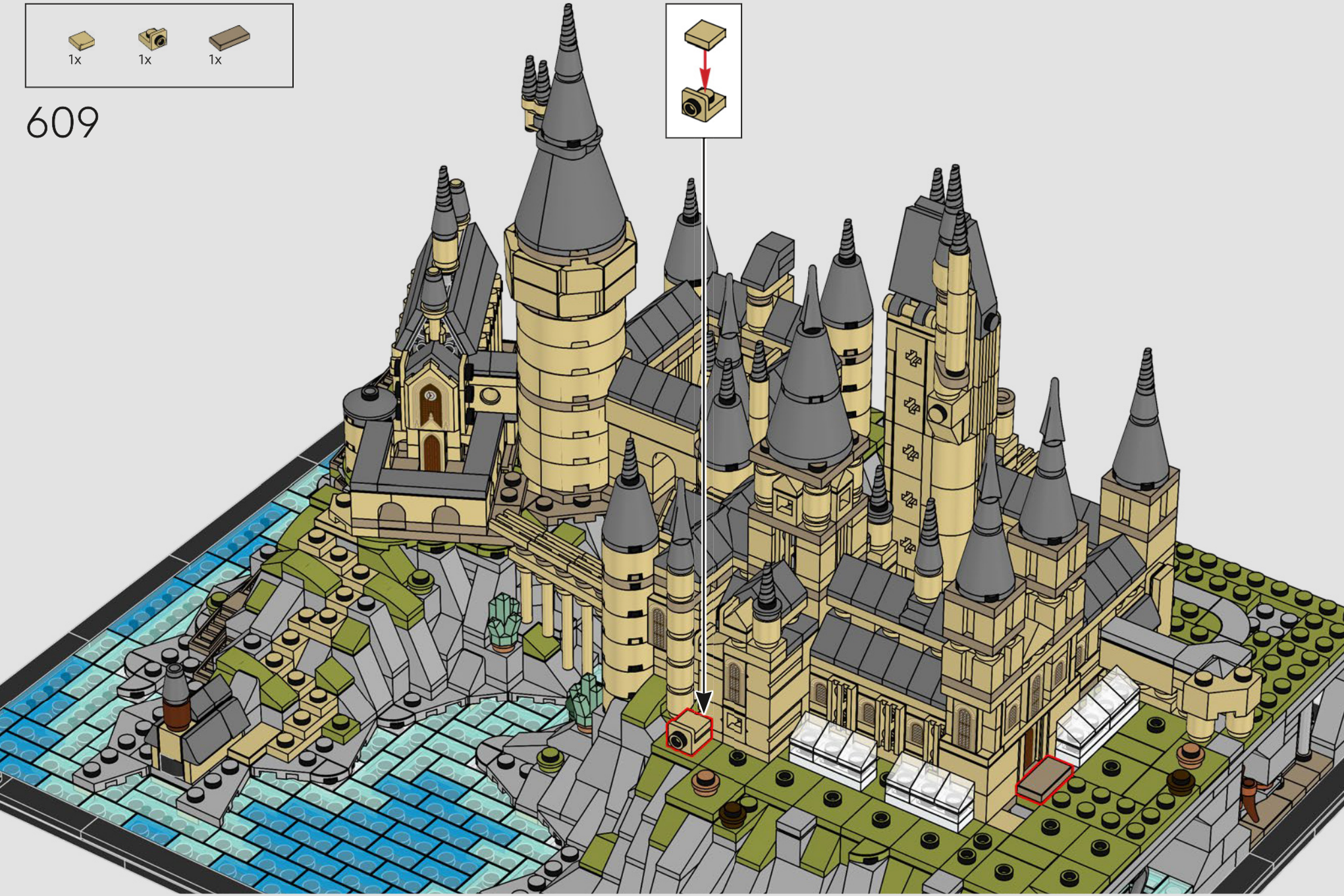
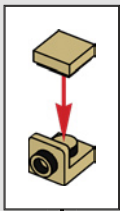



610

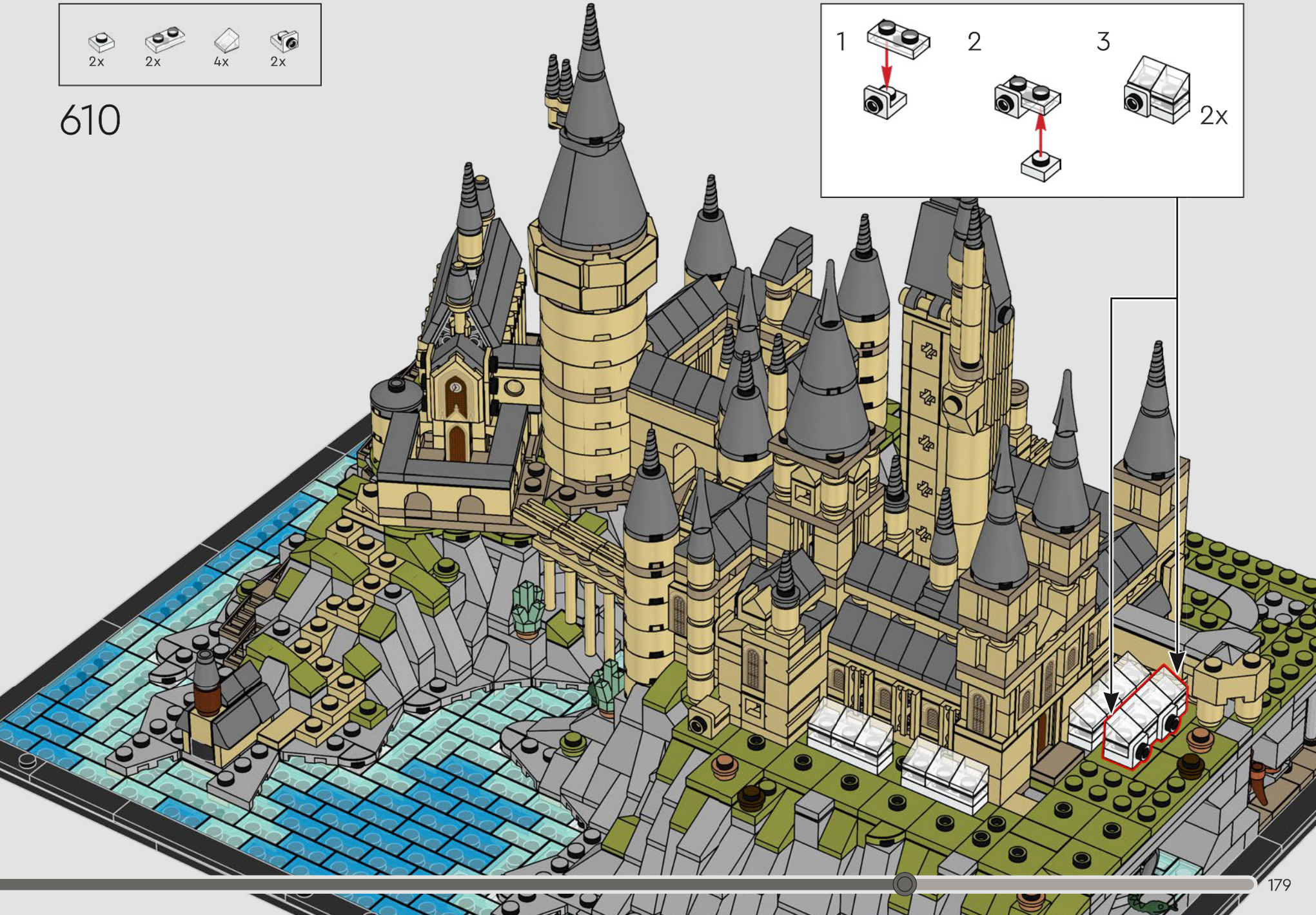
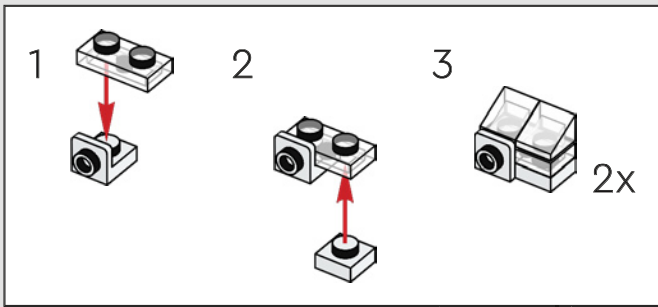

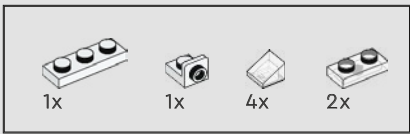

611

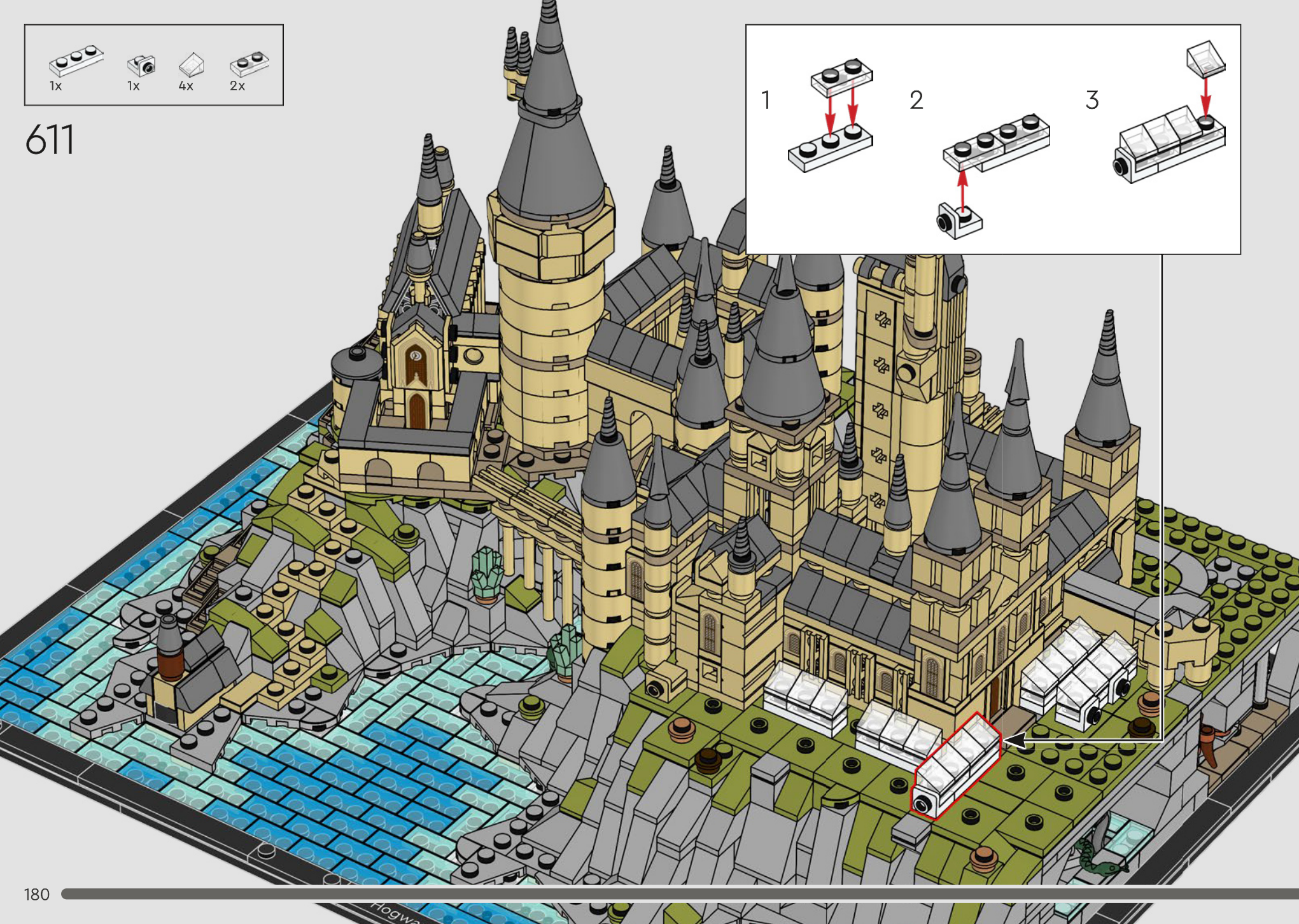
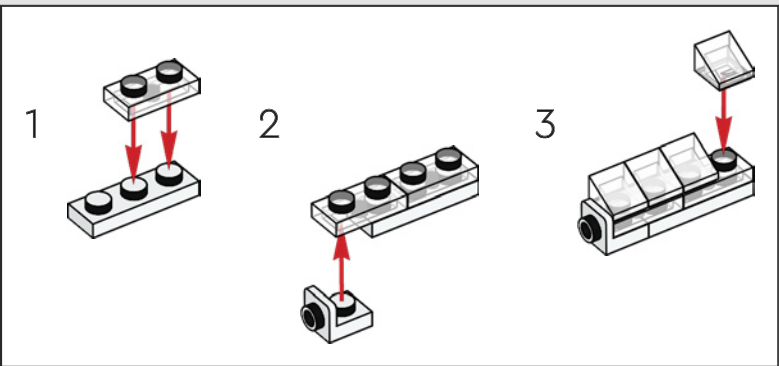

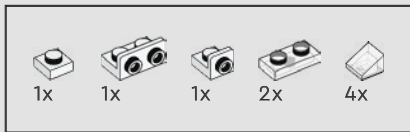

612

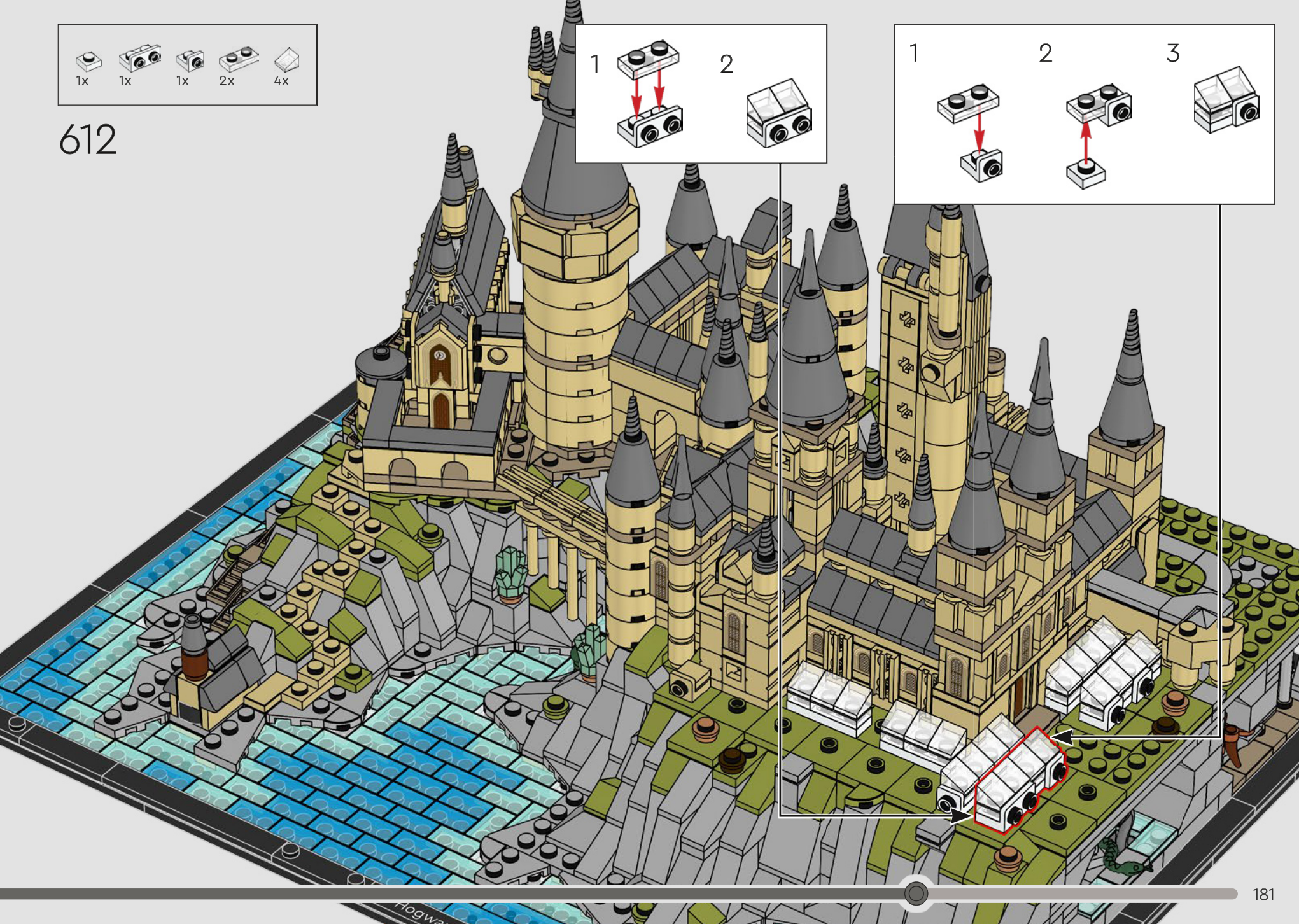
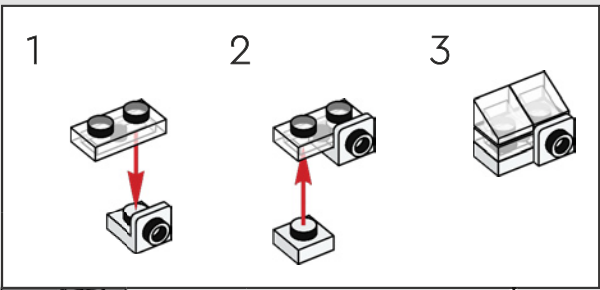
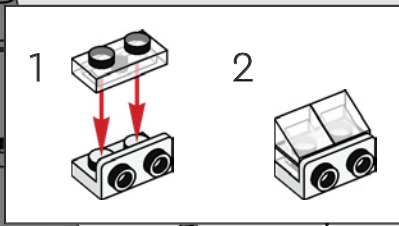

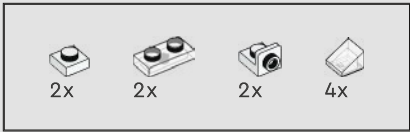

613

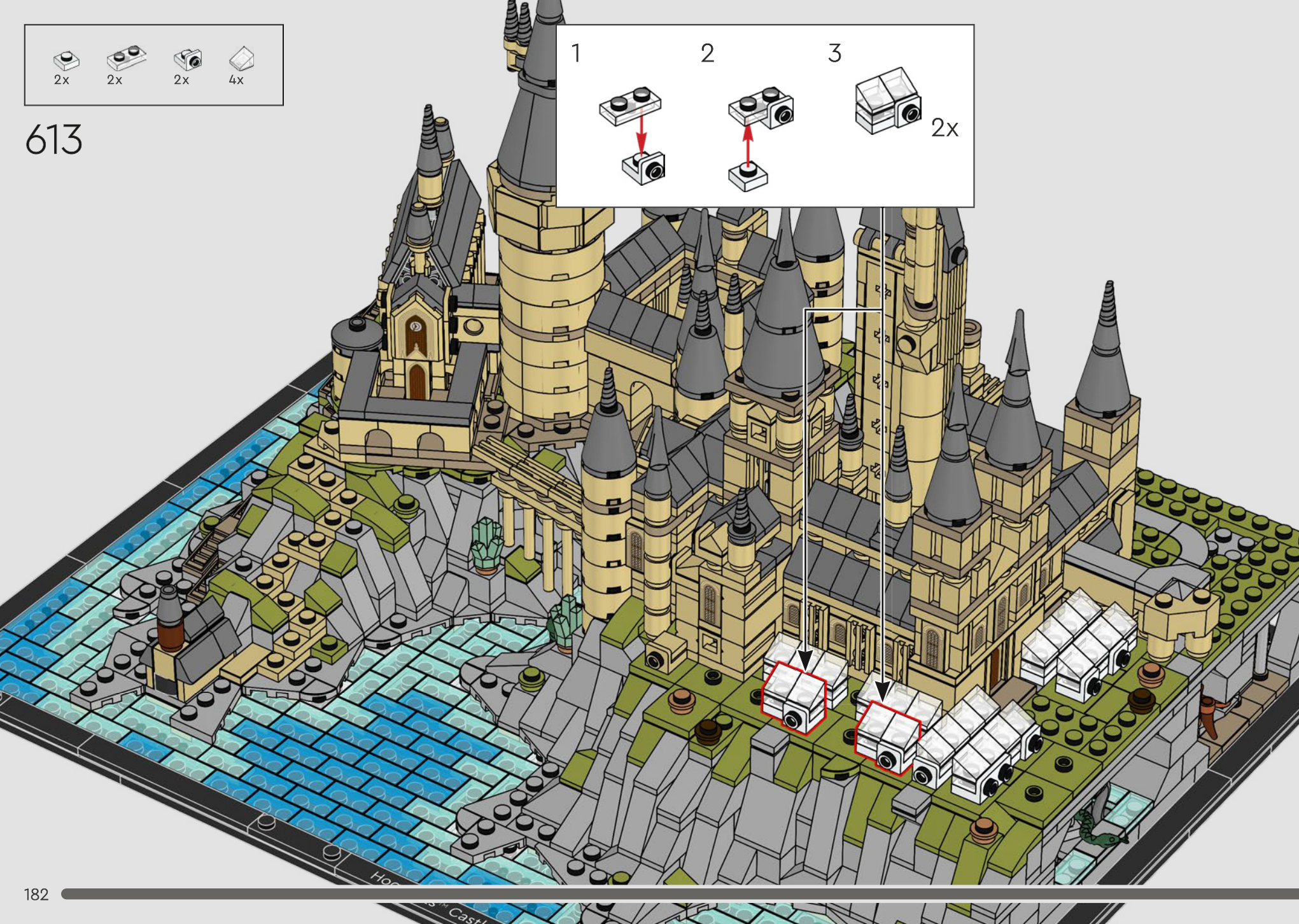
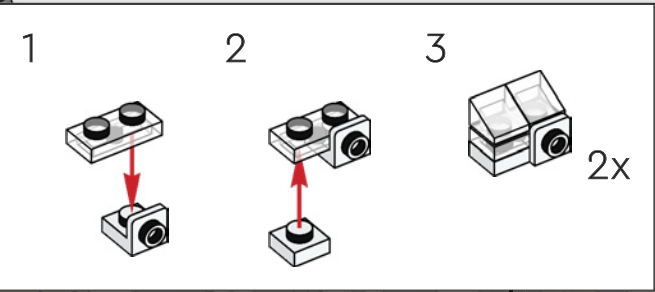



614

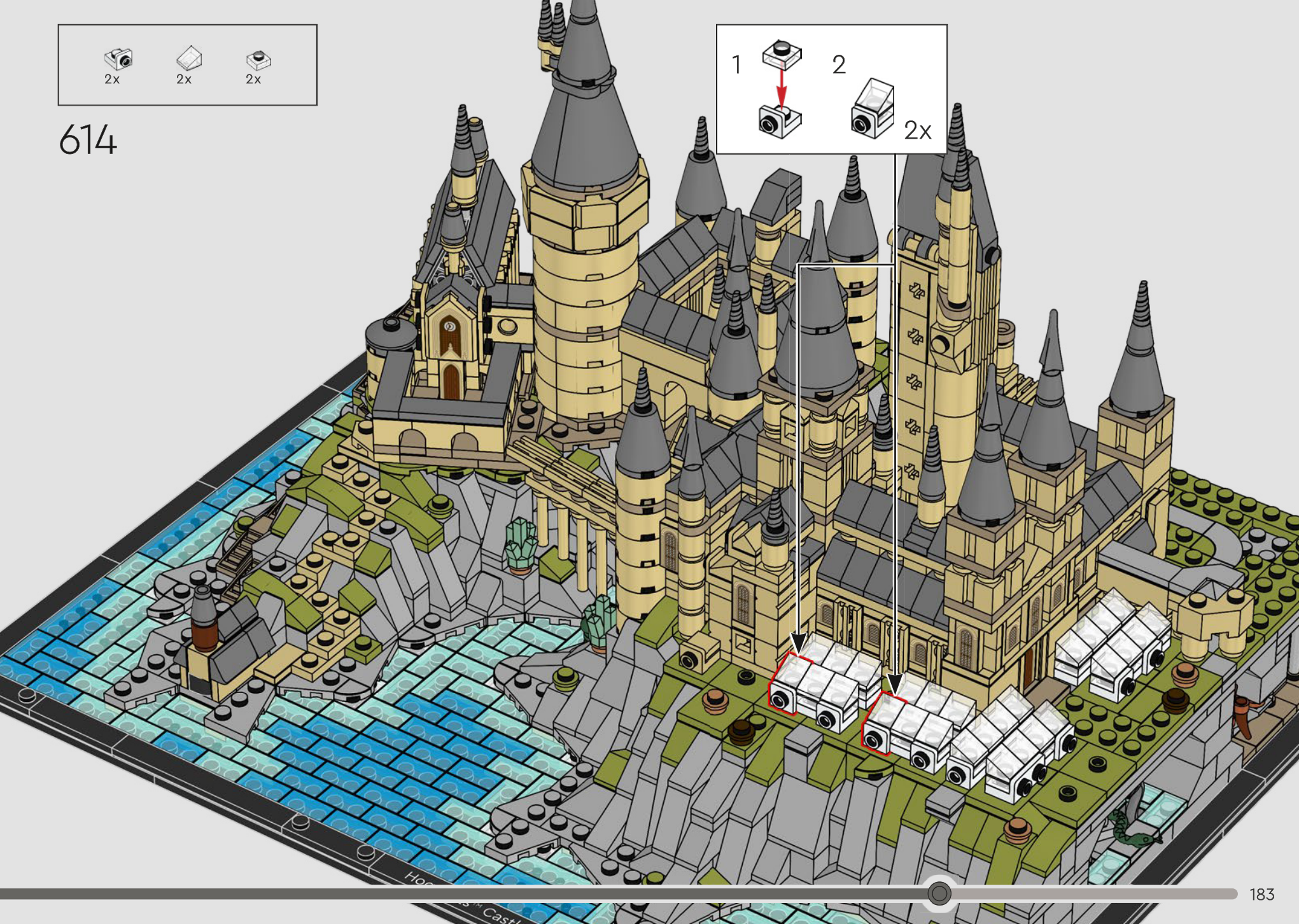
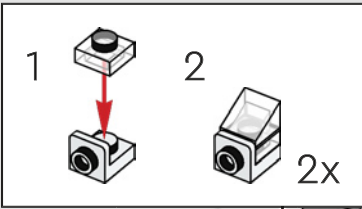

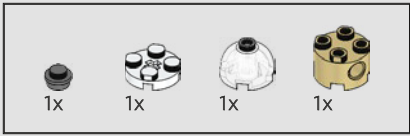

615

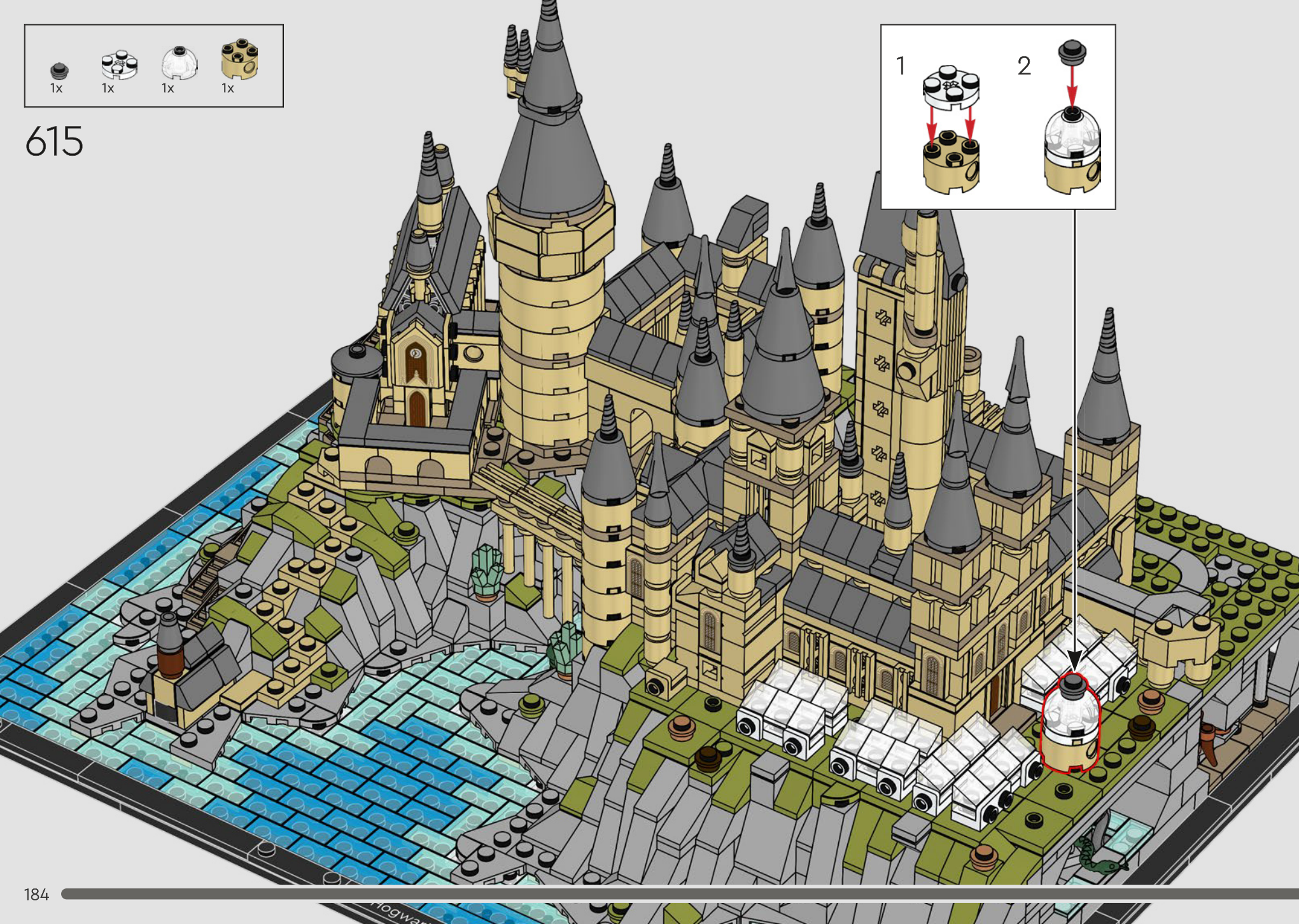
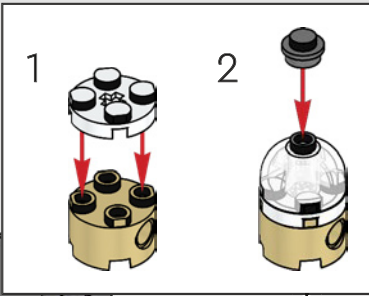



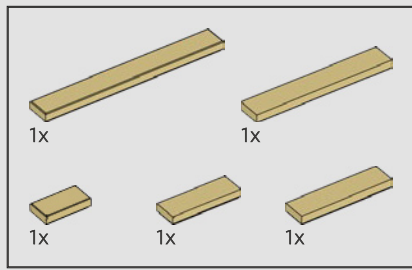

616

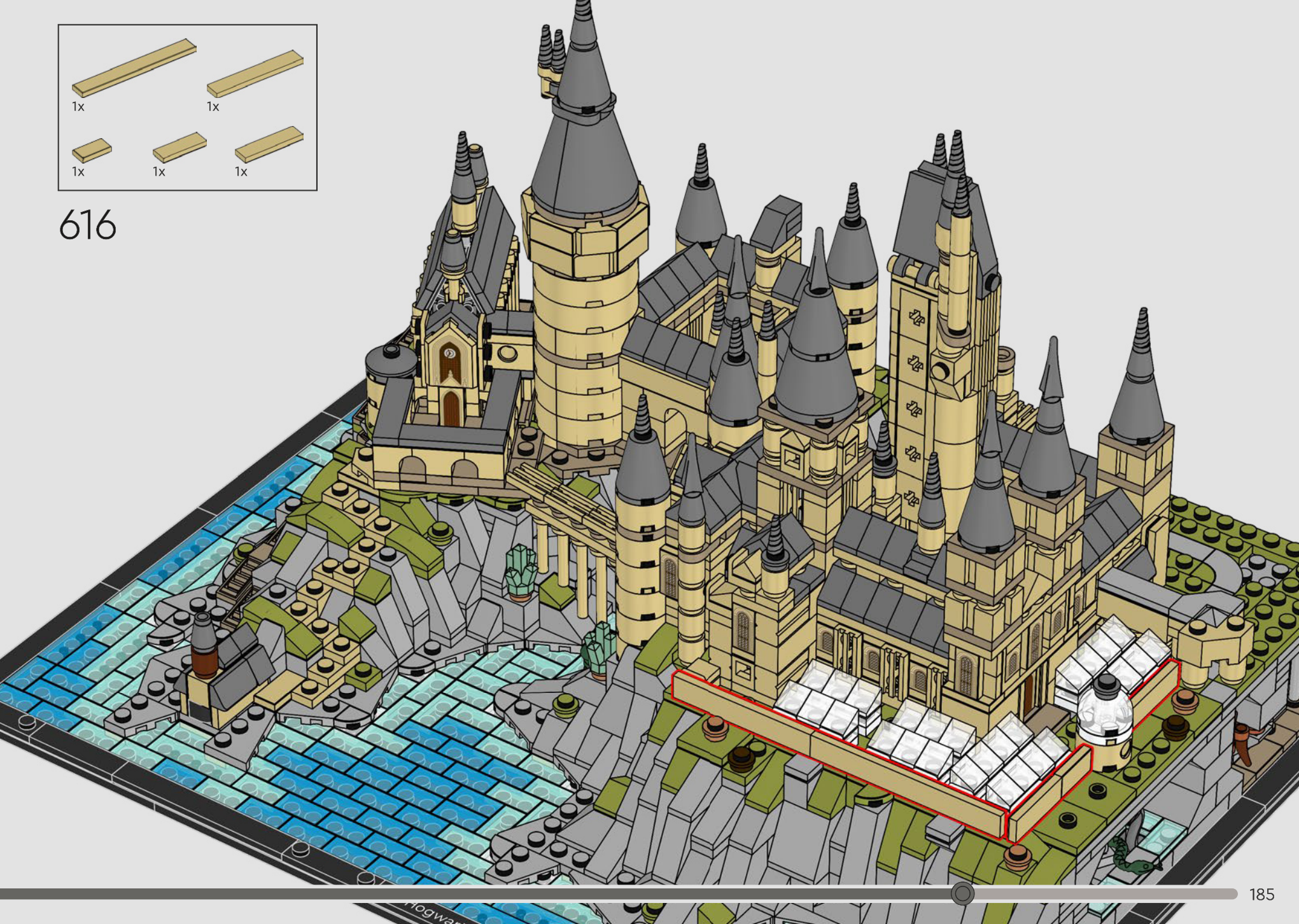



617

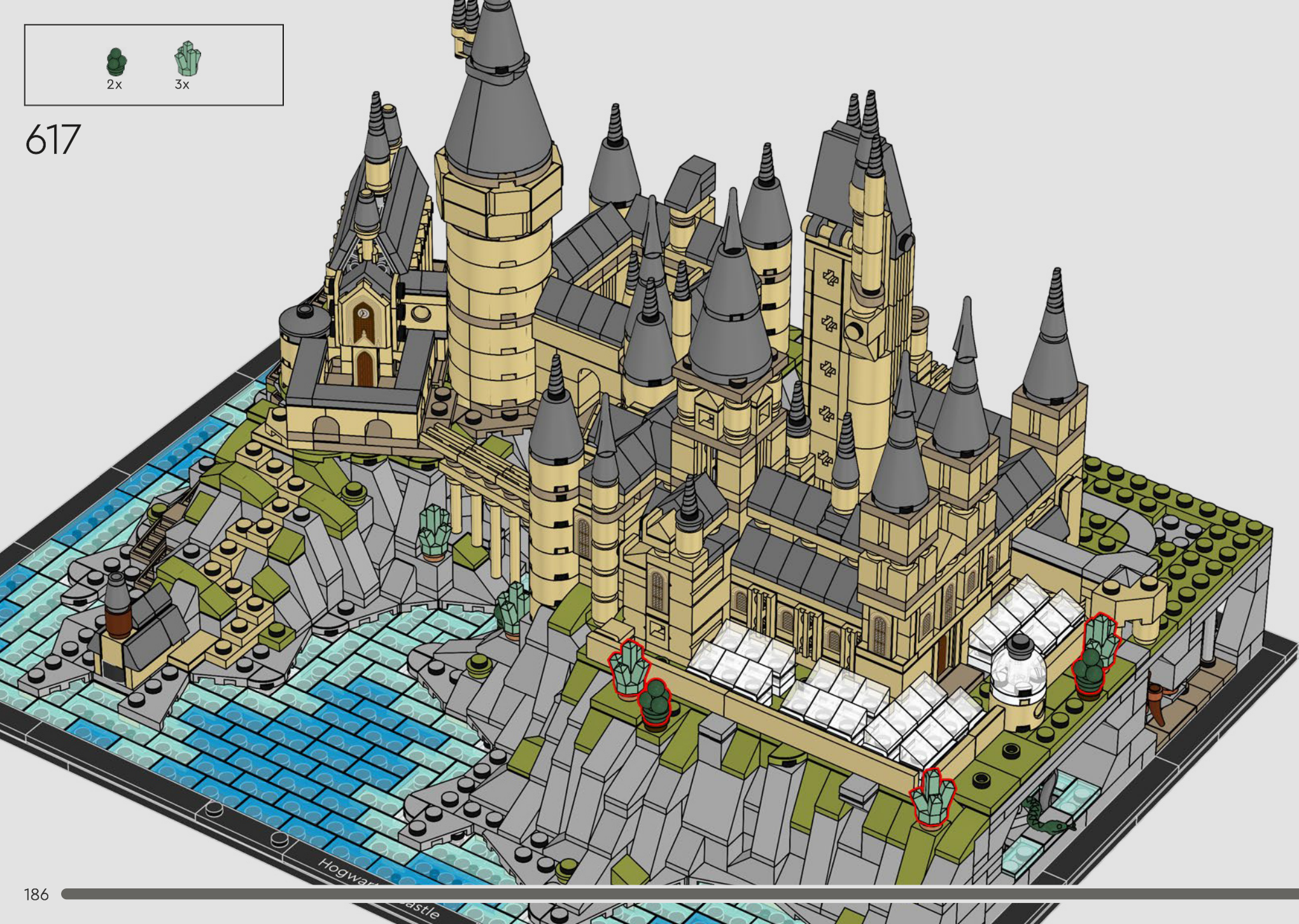

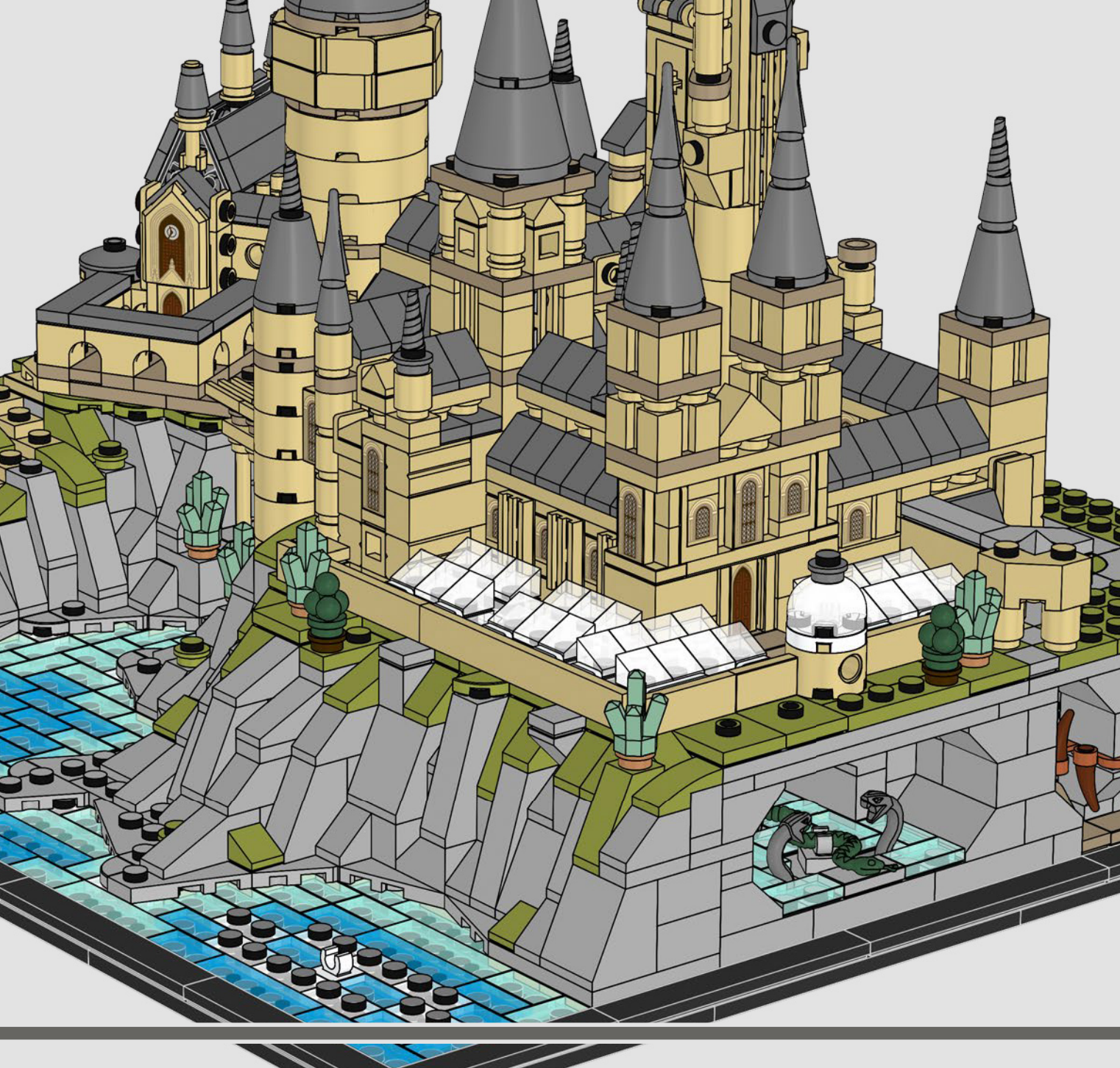

The greenhouses are where Professor Sprout, Head of the Hogwarts™ Herbology department, guides students safely through the care and use of magical plants. Now, if only everyone would use their earmuffs...



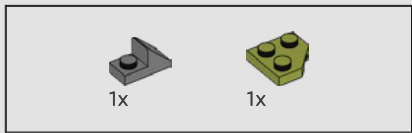

618

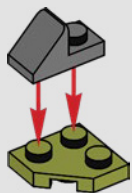

619

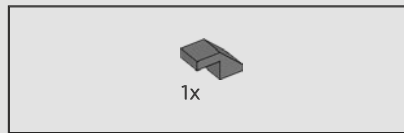
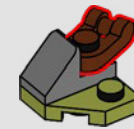

620

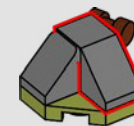

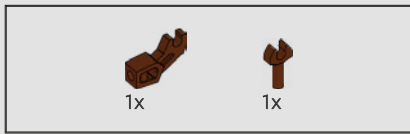

621

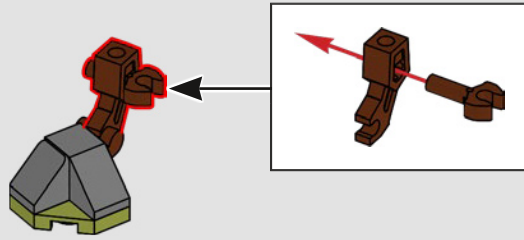

622



623

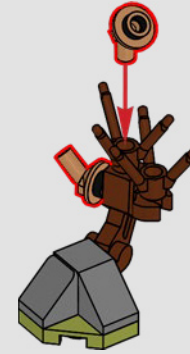

624

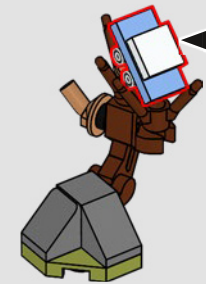
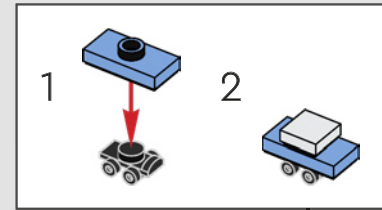



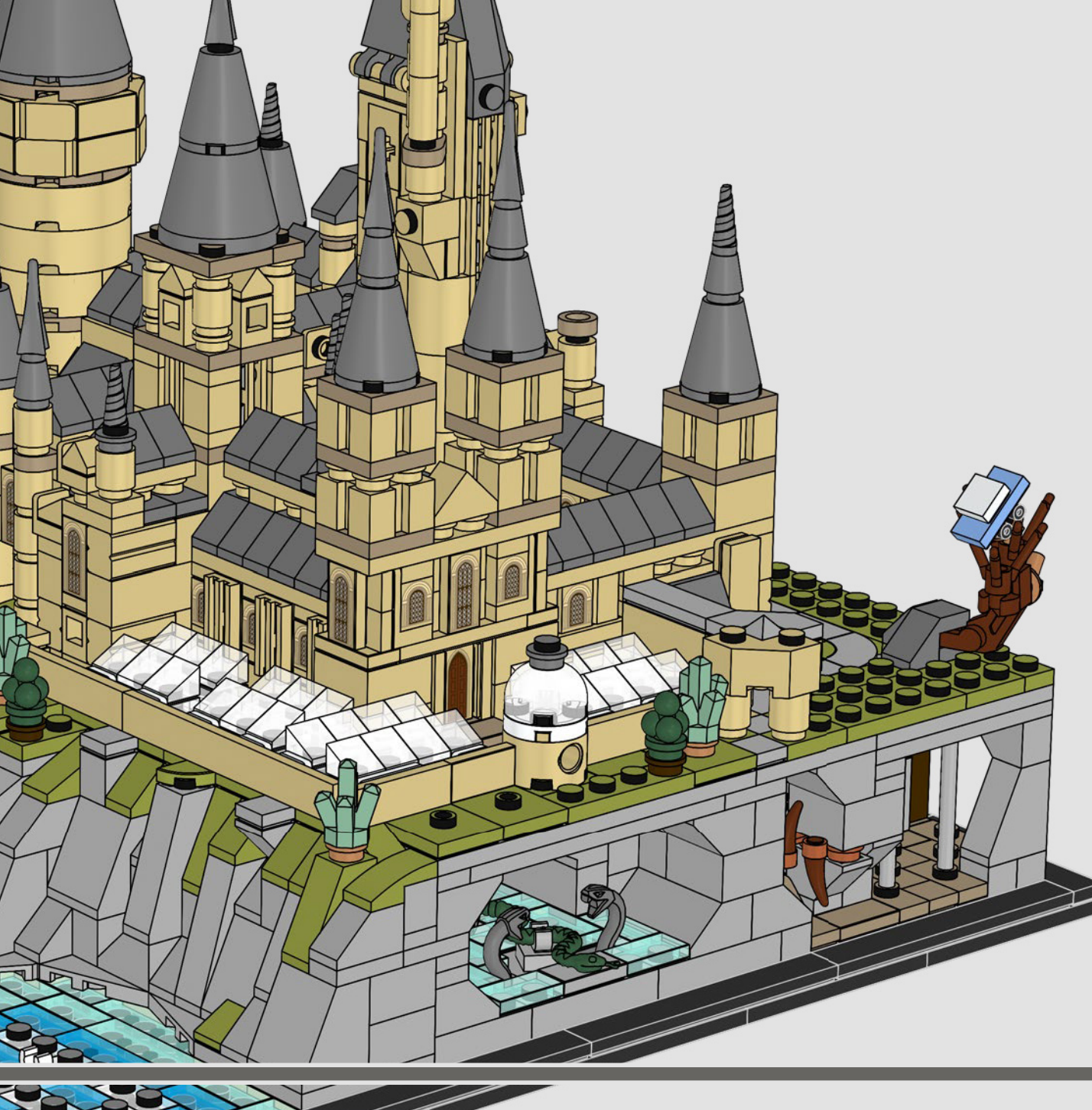

The Whomping Willow™ was planted to give Professor Lupin a safe escape during his full-moon werewolf episodes. It hides a secret tunnel leading to the Shrieking Shack where Lupin would stay until he transformed back into human form.





626

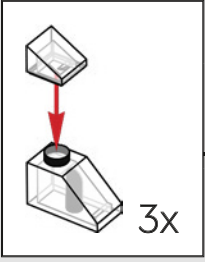
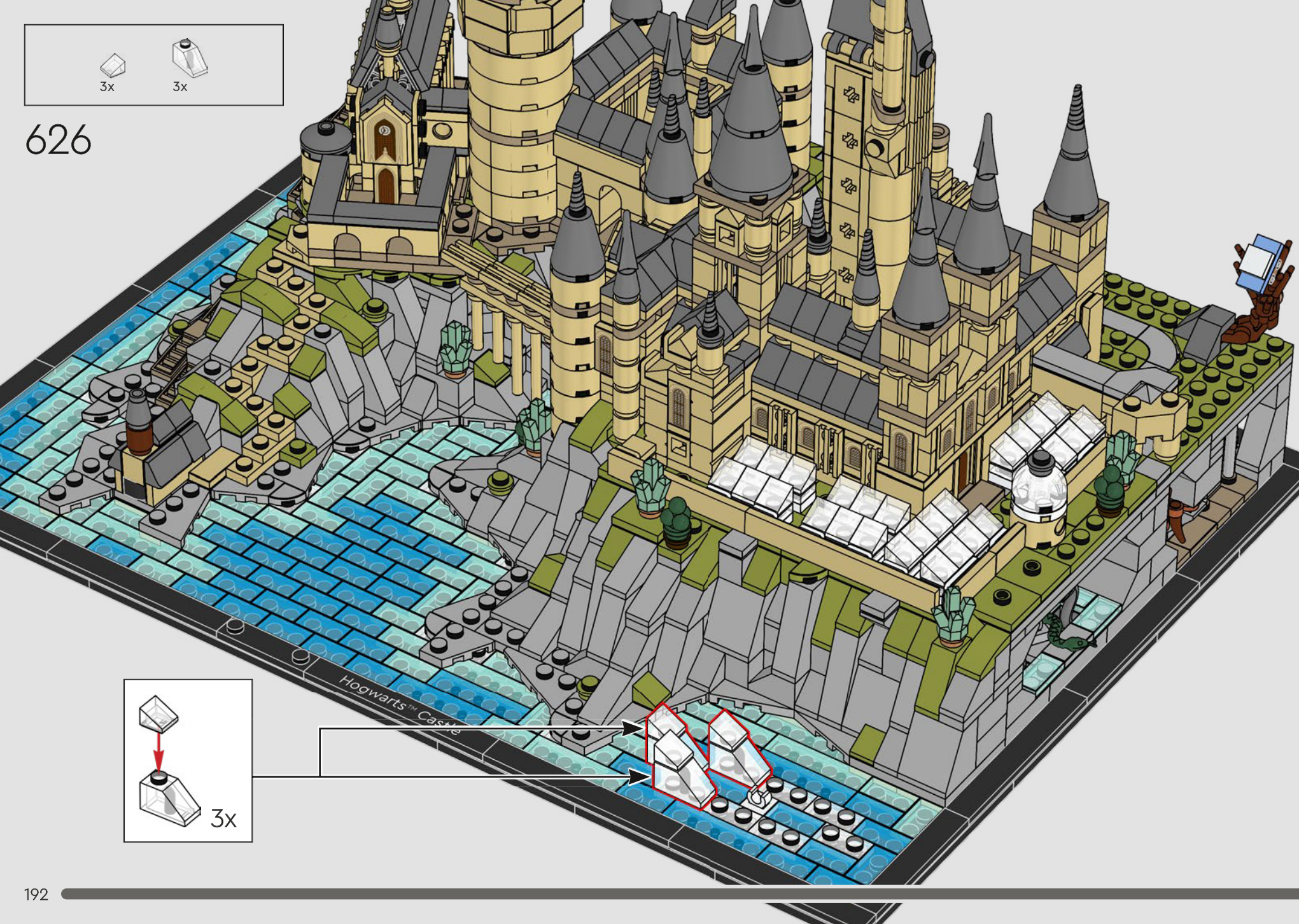





627

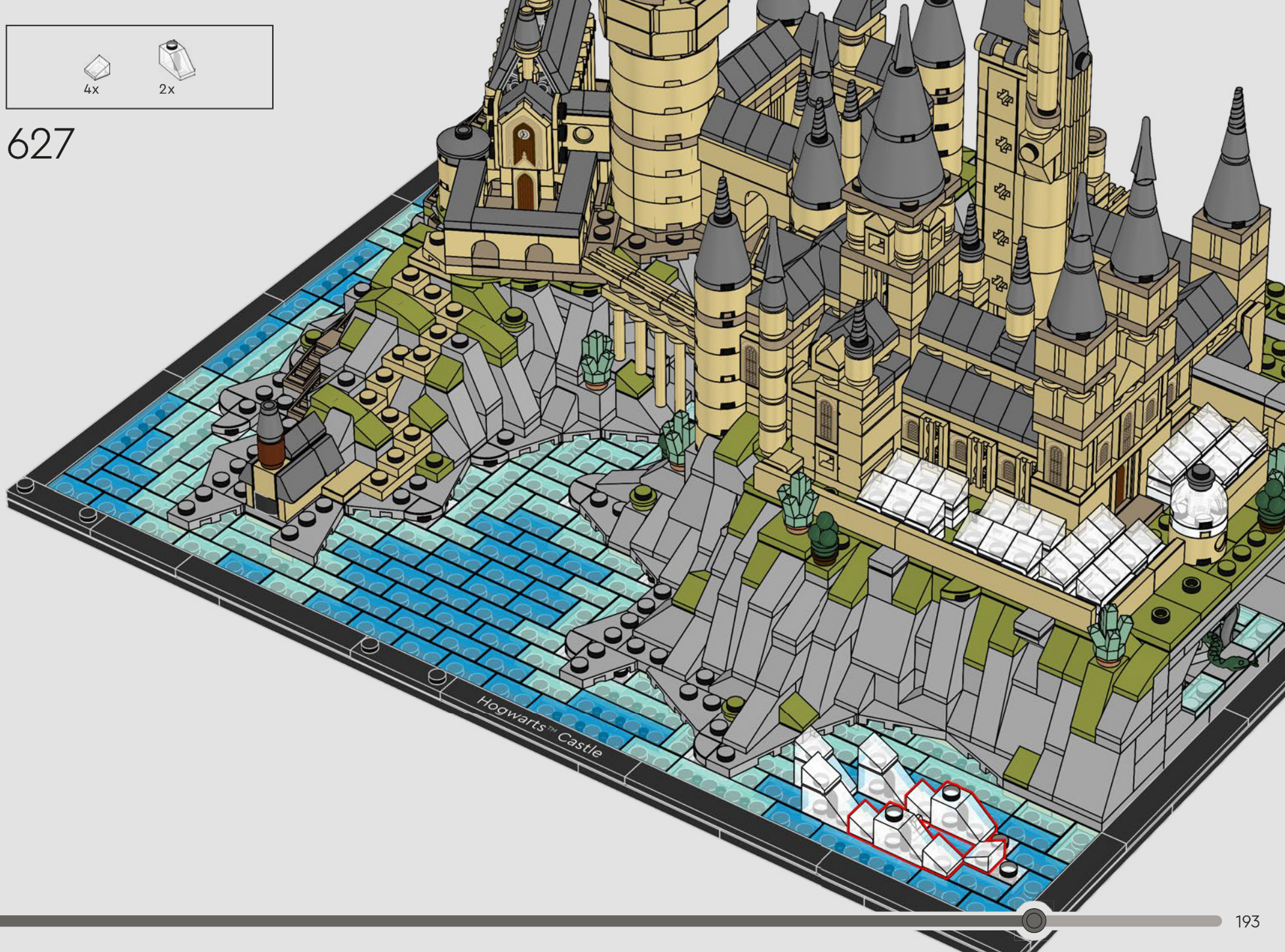

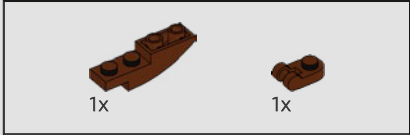
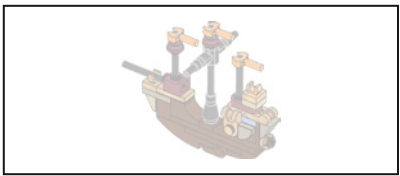

628

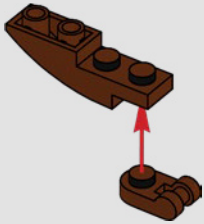

629

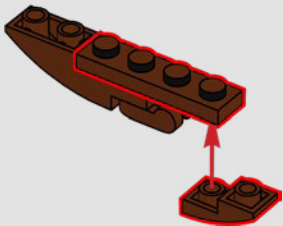

630

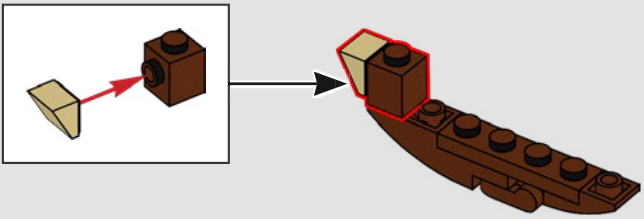

631

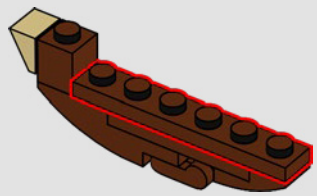

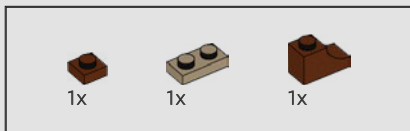

632

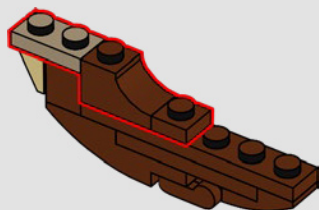

633

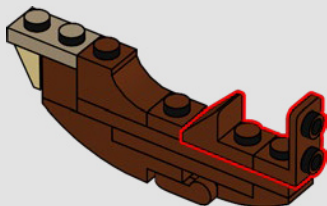

634

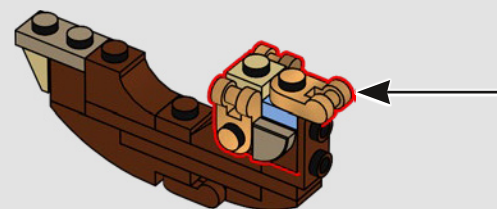
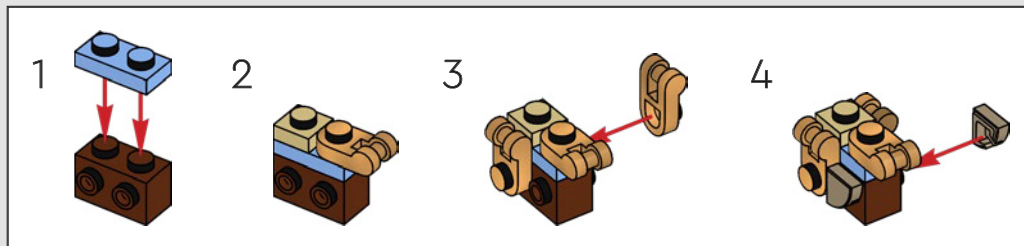



635

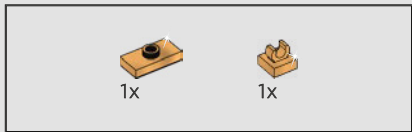
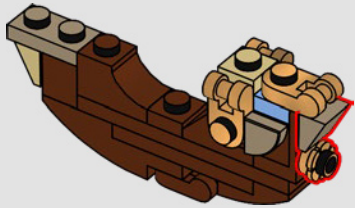

636

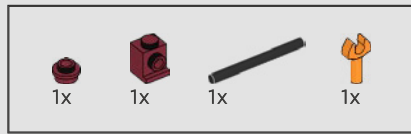
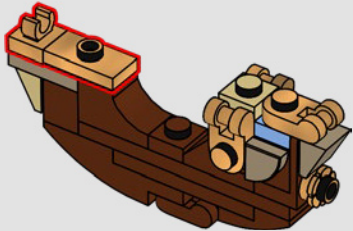

637

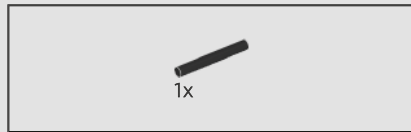
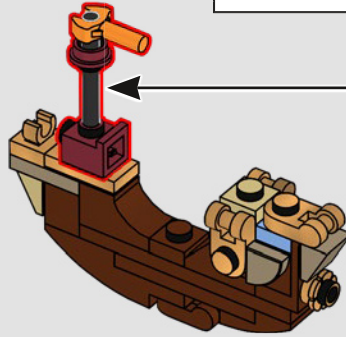
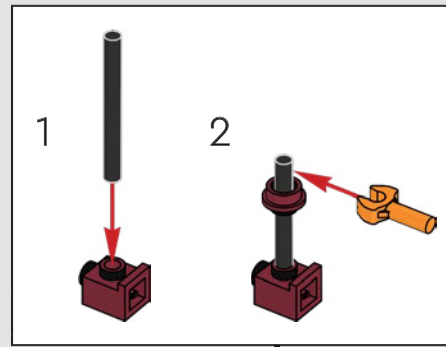

638

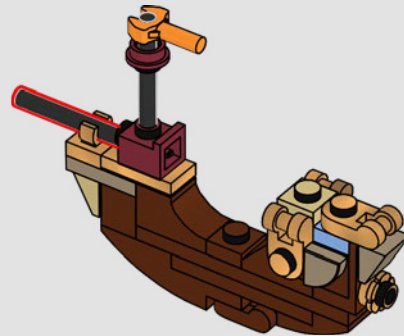

The magical Durmstrang Ship was used to travel between the Durmstrang Institute and Hogwarts™ for the Triwizard Tournament. But have you ever wondered how the ship got from the North Sea into the Black Lake?



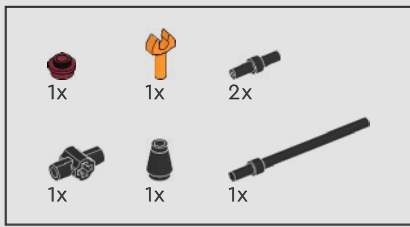

639

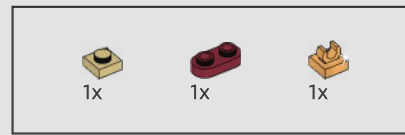
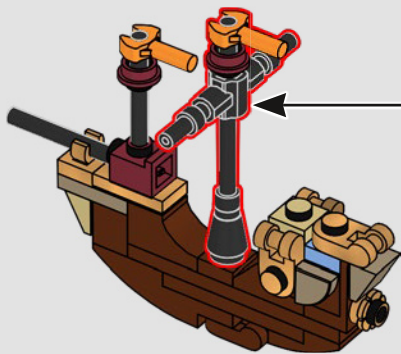
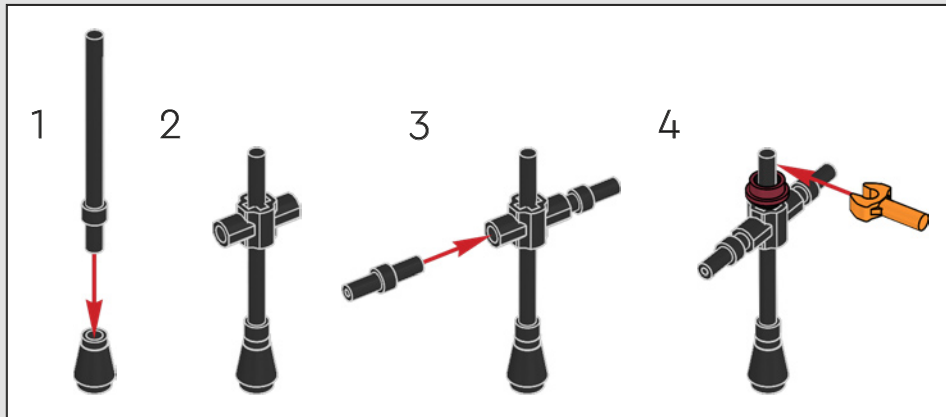

640

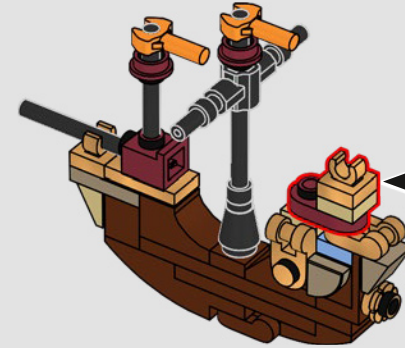
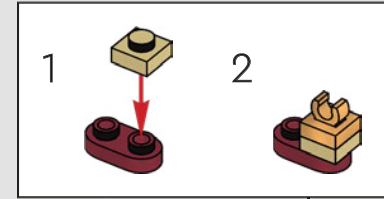

641

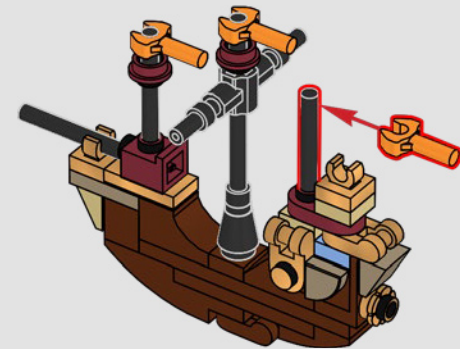



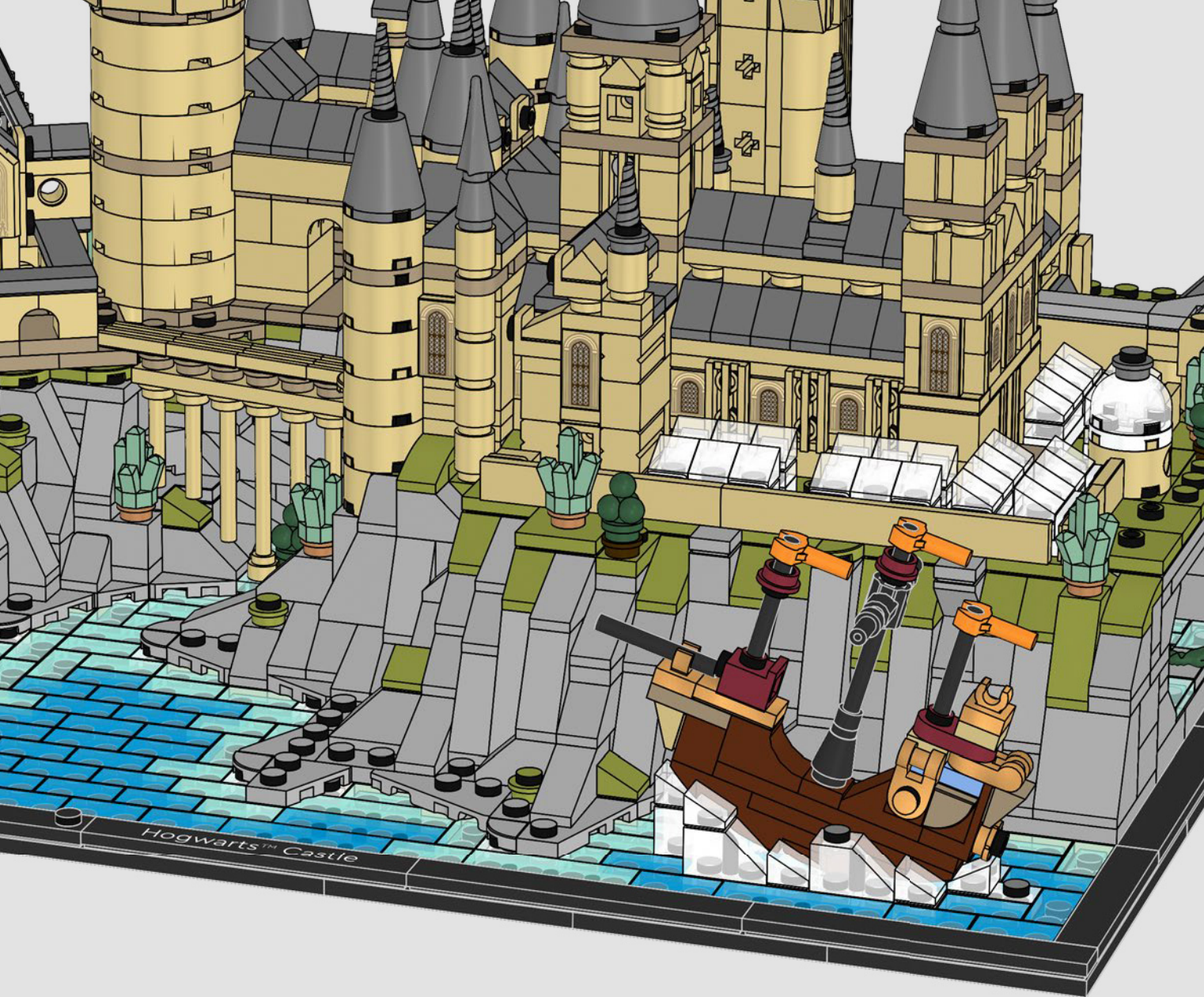

The Durmstrang Ship arrived in the lake through a magical shortcut created between the lake and other bodies of water – truly magical!

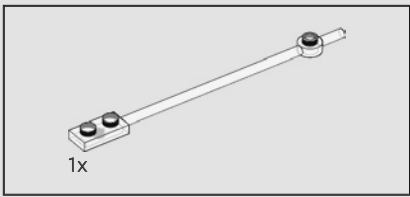

643

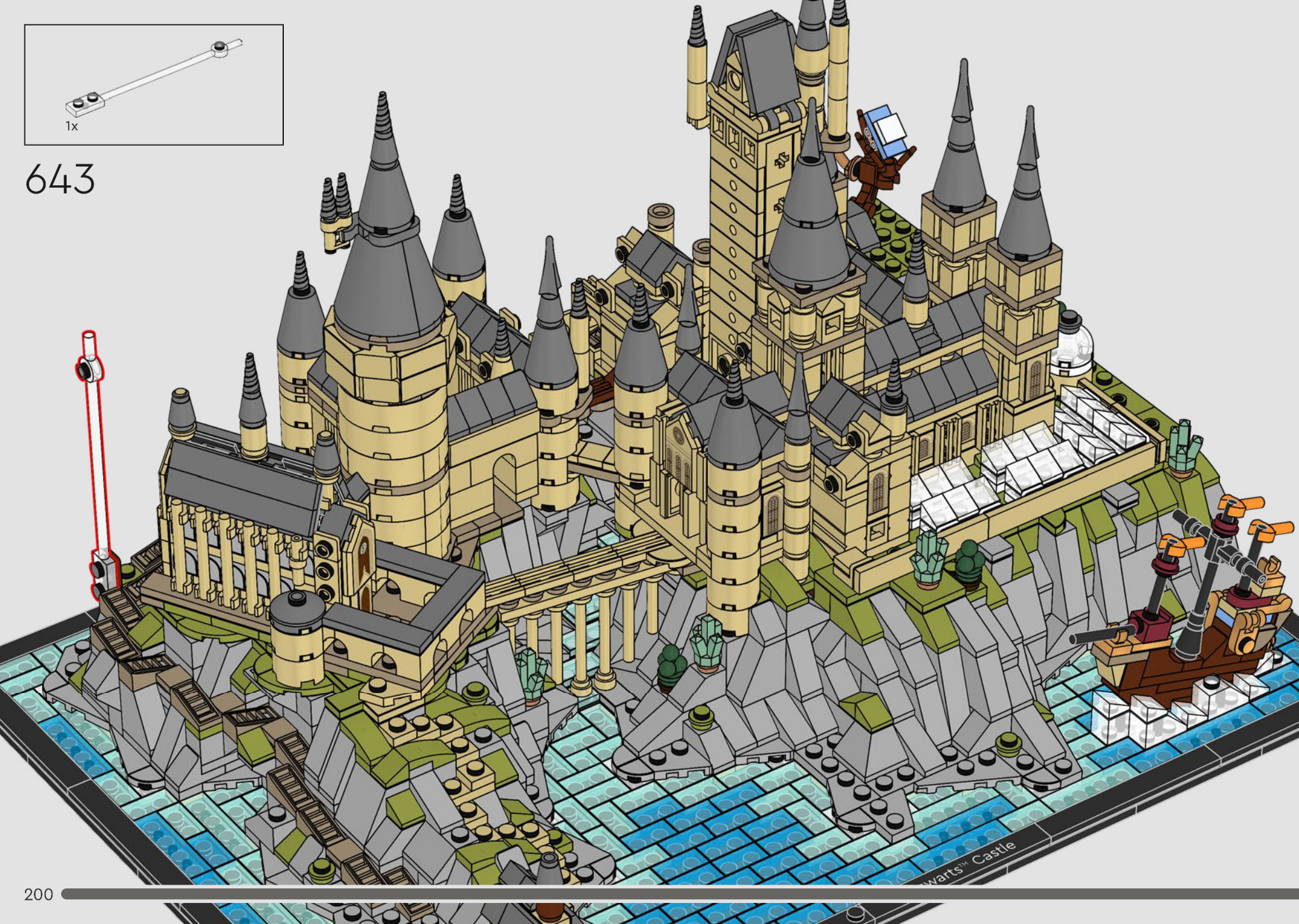







647

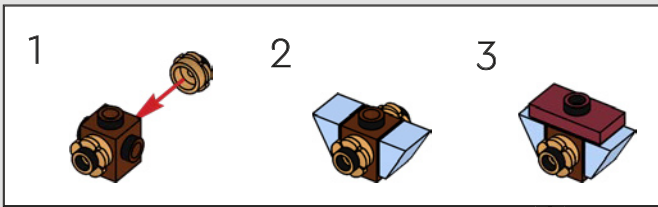

648

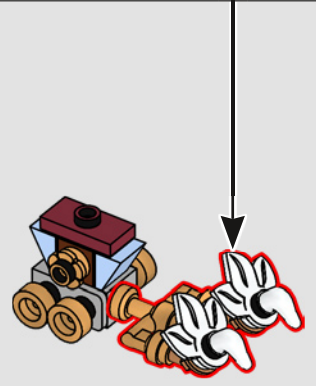
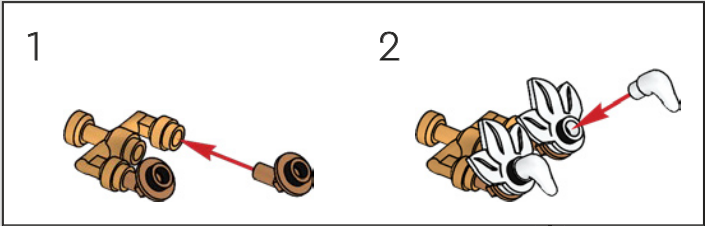

649

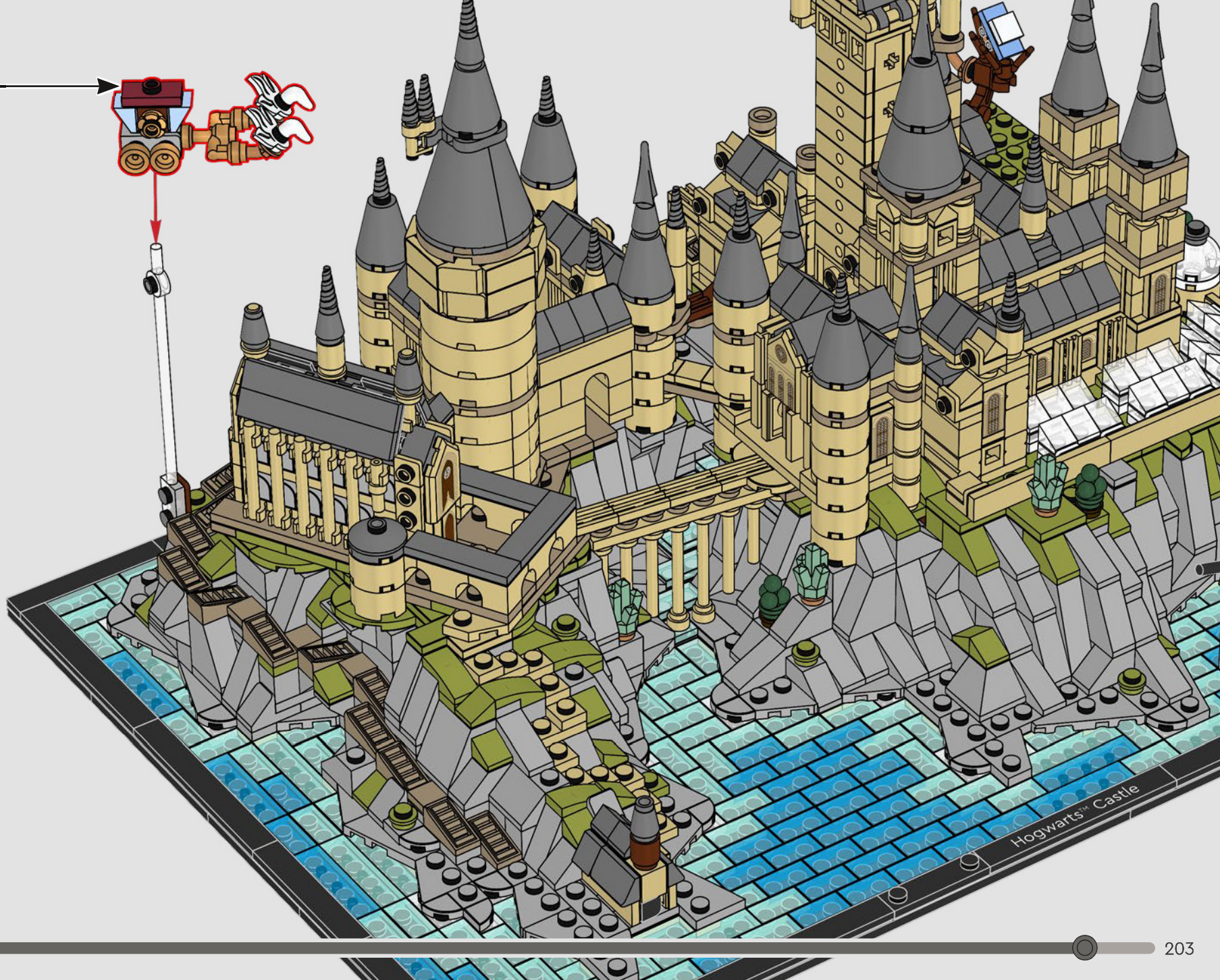

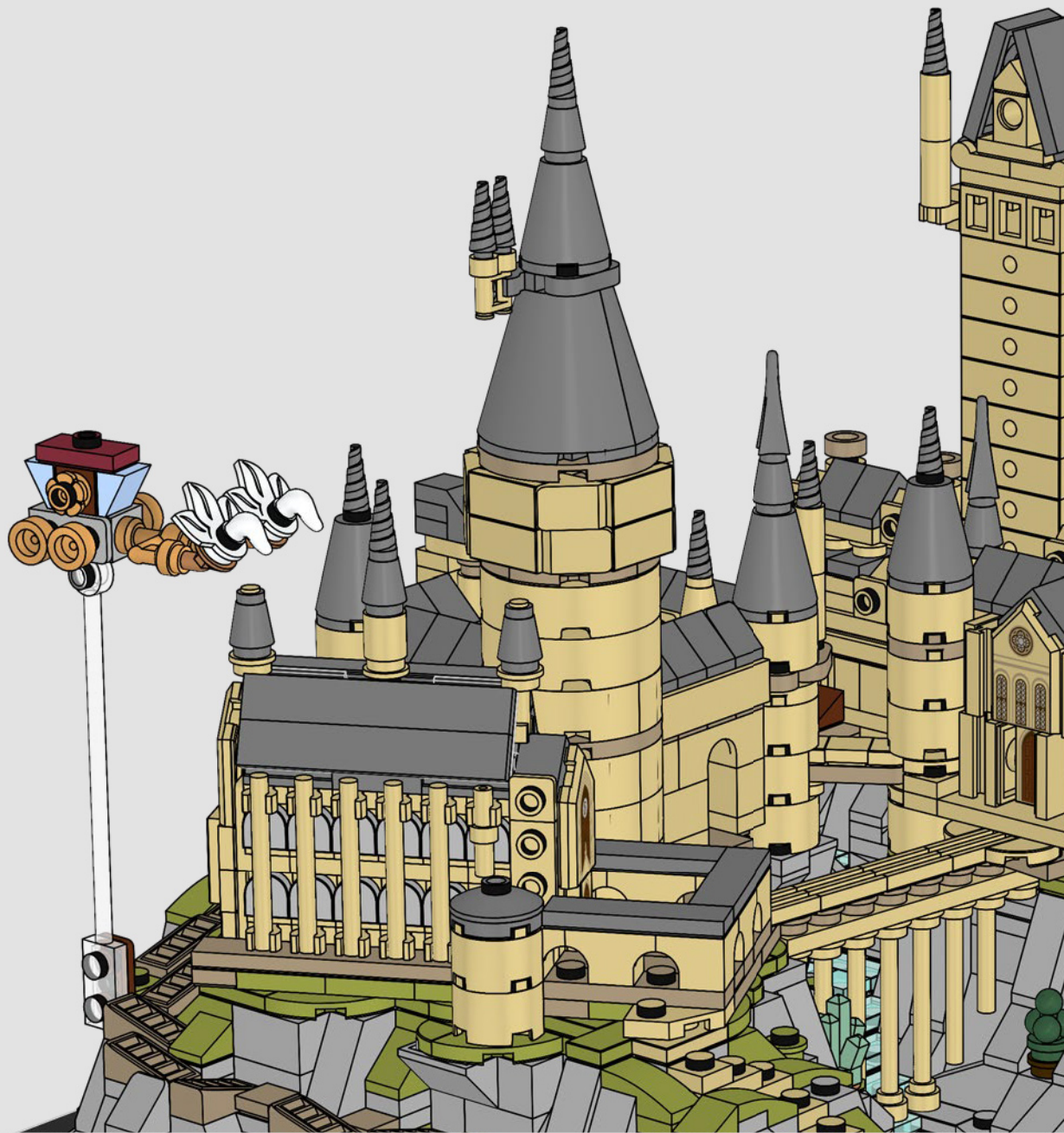

The Pegasus of the Beauxbatons' Carriage is built with white LEGO® horn and leaf elements. Notice the reins? They are actually a magically transformed candleholder!

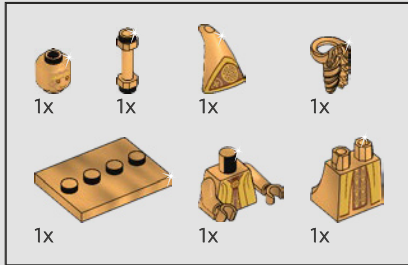

650

1

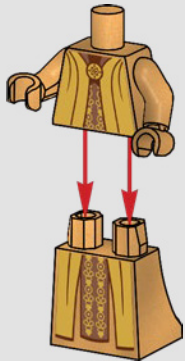

2

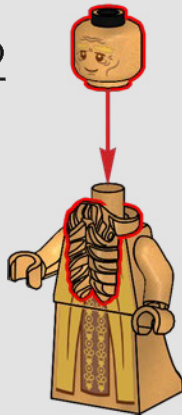

3

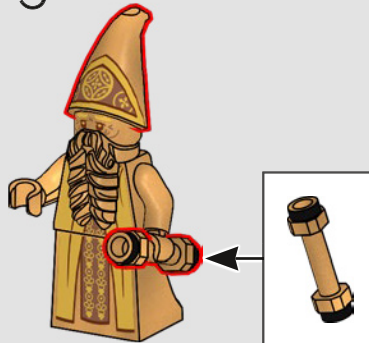

4



The Architect of Hogwarts™ Castle minifigure was created exclusively for this set, with a new beard element, and a Hogwarts model and blueprint scroll in his hand.

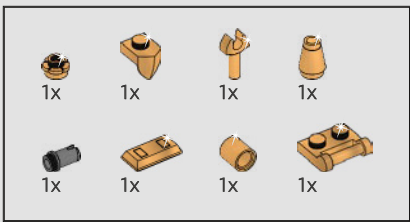

651

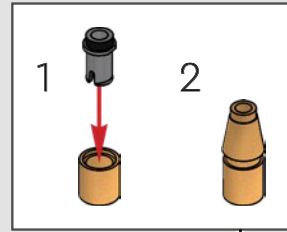

1

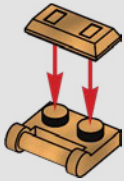

2

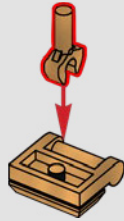

3

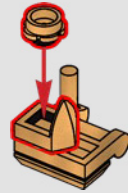

4





The Architect of  
Hogwarts™ Castle was  
active in the years  
around the turn of the  
tenth century. Not  
much is known about  
his life or other works.





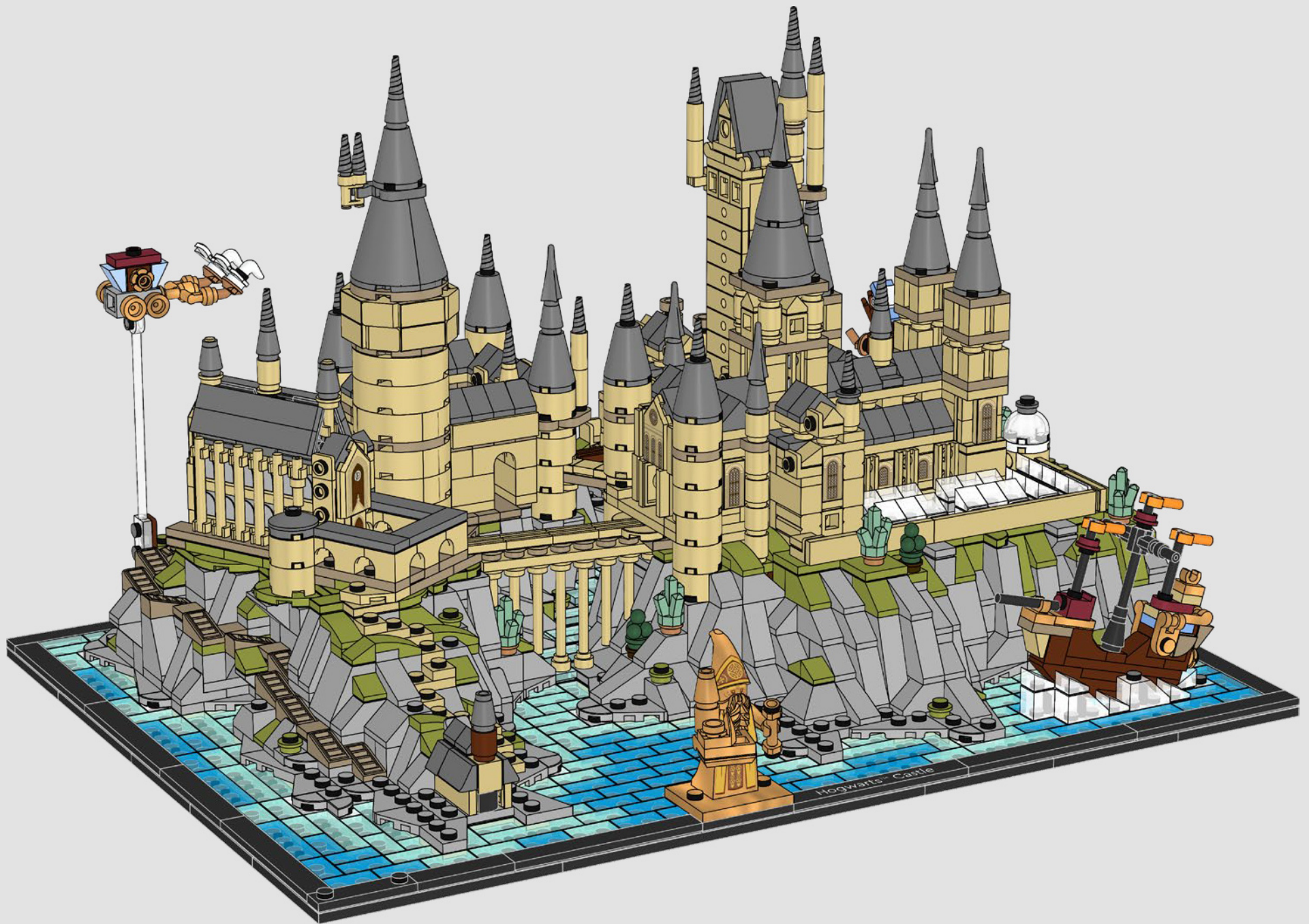

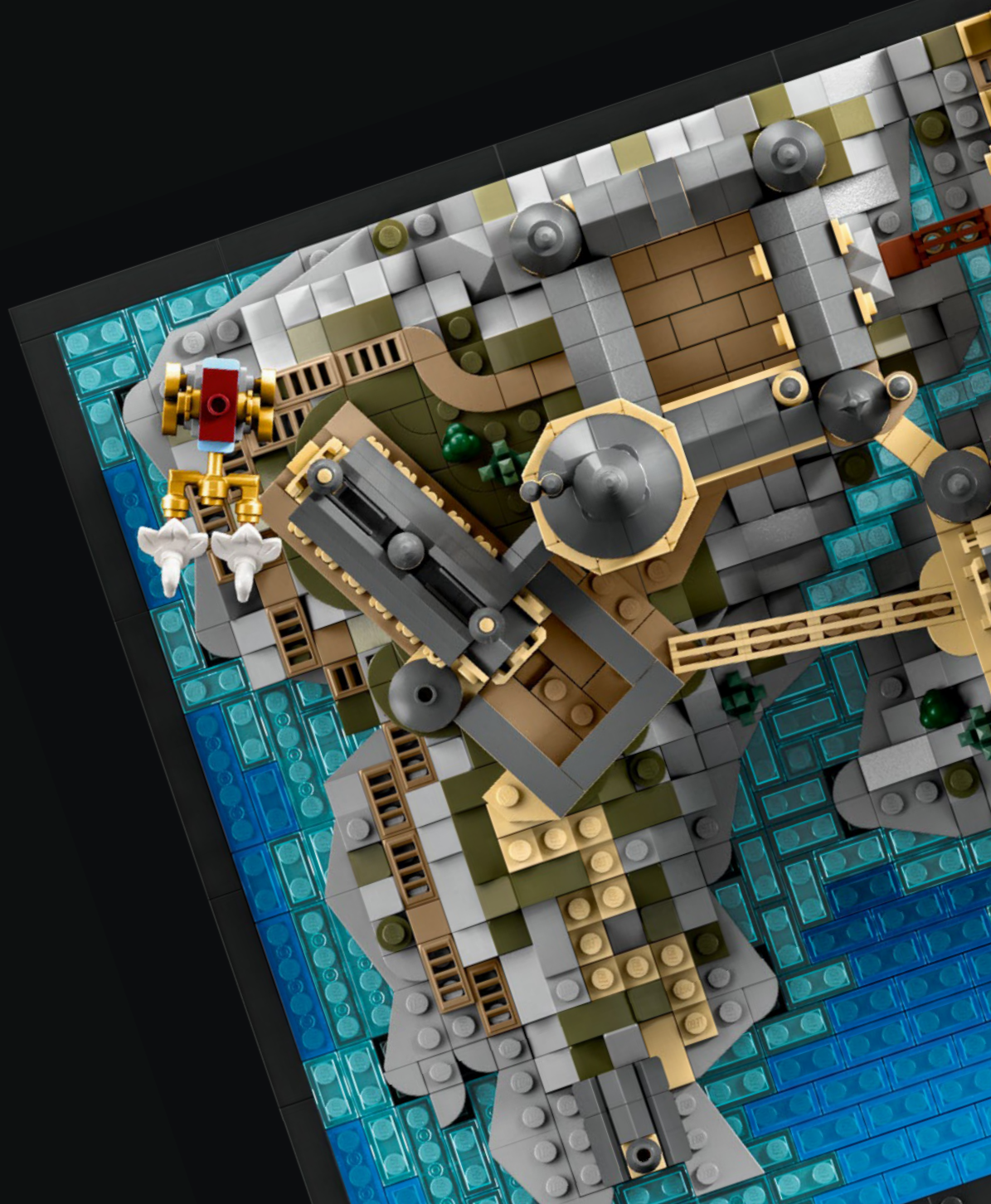

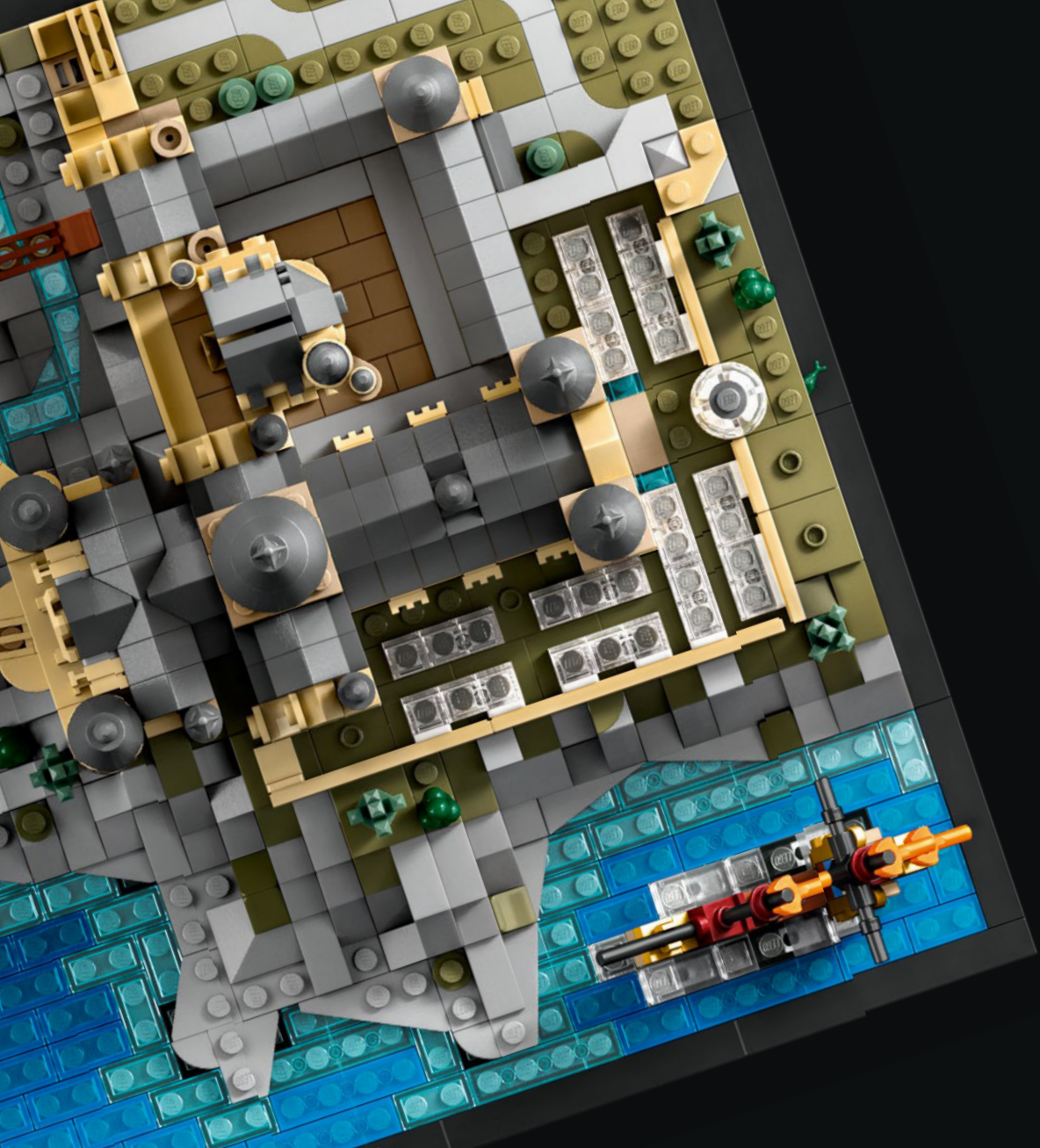

Hogwarts™ Castle



- 2x 614101
- 2x 6186681
- 2x 6328195
- 5x 307001
- 9x 302401
- 1x 6348055
- 8x 6242241
- 2x 4111971
- 2x 6382783
- 1x 6044691
- 1x 403201
- 1x 4667575
- 7x 302301
- 1x 6070698
- 3x 362301
- 11x 6195371
- 1x 4550745
- 1x 246501
- 3x 300201
- 2x 371001
- 2x 300101
- 1x 6222425
- 1x 366601
- 7x 6454936
- 27x 4117070
- 3x 4529237
- 63x 4161734
- 11x 6443061
- 2x 6353196
- 1x 4569547
- 1x 6167923
- 19x 4113915
- 20x 6454440
- 30x 4118793
- 9x 6230284
- 41x 4159553
- 16x 4125253
- 10x 4516055
- 8x 6232135
- 2x 4612603
- 3x 6145570
- 3x 4529237
- 63x 4161734
- 11x 6443061
- 2x 6353196
- 1x 4569547
- 1x 6167923
- 1x 4213568
- 1x 4224793
- 1x 6360037
- 1x 6454941
- 2x 6212758
- 5x 6351413
- 2x 6408047
- 1x 6447501
- 1x 6262018
- 1x 4624086
- 2x 4140562
- 2x 4579260
- 2x 4179771
- 4x 6175968
- 17x 6365720
- 3x 6374151
- 1x 6374192
- 1x 4213568
- 1x 4224793
- 1x 6360037
- 1x 6454941
- 2x 6212758
- 5x 6351413
- 2x 6408047
- 1x 6447501
- 1x 6262018
- 1x 4624086
- 2x 4140562
- 2x 4579260
- 2x 4179771
- 4x 6175968
- 17x 6365720
- 3x 6374151
- 6x 6236425
- 40x 4113917
- 34x 4114026
- 9x 6148262
- 43x 6092587
- 36x 4124456
- 10x 6455327
- 3x 6236914
- 8x 6069165
- 4x 4109995
- 1x 6024495
- 1x 6214334
- 2x 4159279
- 5x 6236423
- 1x 6445058
- 3x 6455326
- 10x 6391523
- 9x 6219794
- 2x 6103001
- 1x 4205107
- 7x 6174925
- 1x 6313611
- 1x 6117975
- 1x 6249809
- 2x 6253003
- 4x 4160483
- 1x 6374166
- 2x 4217562
- 5x 6443062
- 2x 4124455
- 6x 4114077
- 6x 4114306
- 2x 6221467
- 5x 6454937
- 16x 4114084
- 4x 4185177
- 1x 4188866
- 1x 6148265
- 12x 6055868
- 1x 6469454
- 1x 6458487
- 1x 6454439
- 11x 4121921
- 6x 6131896
- 2x 4162465
- 7x 4618651
- 1x 6058093
- 4x 6211966
- 9x 6410762
- 1x 6245271
- 1x 4543858
- 12x 6116614
- 9x 4118790
- 4x 4159739
- 2x 6175367
- 10x 4113233
- 5x 6232136
- 7x 6257600
- 5x 4550324
- 23x 6352222
- 2x 4113916
- 1x 6213676
- 2x 6294592
- 4x 6115031
- 2x 6454935
- 10x 4114309
- 1x 6351905
- 7x 4124067
- 6x 4112982
- 1x 4157277
- 3x 4243824
- 1x 6383728
- 7x 4113993
- 2x 4181134
- 4x 4114324
- 2x 4159774
- 1x 4544139
- 4x 4114001
- 4x 4113988
- 1x 6075179
- 1x 4624185
- 2x 447721
- 2x 611121
- 4x 614121
- 2x 362221
- 1x 302121
- 5x 371021
- 2x 6372124
- 4x 6315780
- 1x 6347604
- 5x 242023
- 5x 301023
- 2x 366623
- 17x 614124
- 6x 362224
- 3x 362324
- 1x 4188313
- 1x 6457333
- 1x 6350055
- 1x 6454443
- 3x 6212377
- 1x 6207933
- 1x 6092594
- 1x 6326425
- 1x 6454437
- 1x 4585493
- 1x 6378168
- 4x 6209691
- 1x 4529247
- 4x 6186672
- 1x 6453281
- 1x 6454435
- 1x 6256803
- 2x 6262138
- 1x 6415995
- 1x 6083975

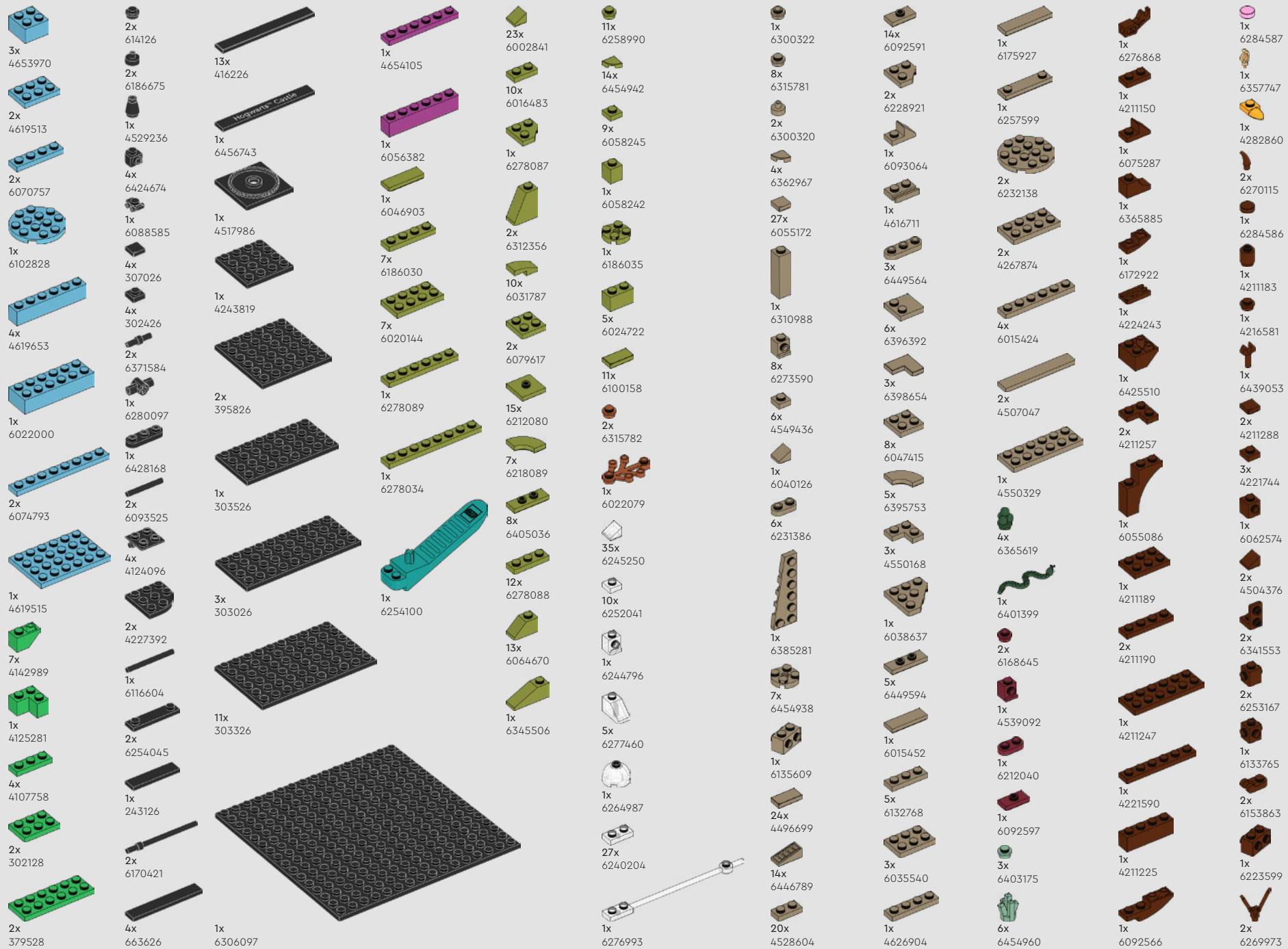

- 1x 4210763
- 2x 6168776
- 4x 4211066
- 2x 6331866
- 3x 4211094
- 1x 6126083
- 1x 6201630
- 10x 6092666
- 1x 6115080
- 1x 4211010
- 2x 6174938
- 17x 6445056
- 6x 6269969
- 15x 4529240
- 2x 6331689
- 1x 4210867
- 2x 4211100
- 8x 4210719
- 1x 4243831
- 1x 6186635
- 2x 4211103
- 3x 6231765
- 2x 4210633
- 1x 6431826
- 3x 6395635
- 4x 6454438
- 1x 4211098
- 5x 6343852
- 4x 4210651
- 4x 6262021
- 2x 4504378
- 2x 6234583
- 2x 6235153
- 7x 6167641
- 4x 6400315
- 51x 6251289
- 8x 6252050
- 1x 4179825
- 1x 6092601
- 1x 6221607
- 1x 6296892
- 45x 4226221
- 3x 4567887
- 14x 4211135
- 1x 4211088
- 3x 6069164
- 2x 6092572
- 3x 4211053
- 1x 4526932
- 9x 4211394
- 1x 4529241
- 1x 6284071
- 3x 6448793
- 21x 6250597
- 1x 6455328
- 5x 4521921
- 23x 4211389
- 5x 6362975
- 12x 6176433
- 3x 6345639
- 2x 6433942
- 12x 6163478
- 6x 4211415
- 2x 4211489
- 1x 4526932
- 9x 4211394
- 1x 6420741
- 6x 4211791
- 5x 4211794
- 1x 6234738
- 18x 4211399
- 1x 6225242
- 46x 4211614
- 1x 6347715
- 3x 6258381
- 2x 4568637
- 2x 6075075
- 15x 4211488
- 2x 6211969
- 12x 4211428
- 7x 6116608
- 4x 6066097
- 5x 6186657
- 1x 4216248
- 3x 6308012
- 4x 6065824
- 1x 4651063
- 1x 6469440
- 1x 6269049
- 40x 4515374
- 12x 4211437
- 20x 4211388
- 6x 4657459
- 2x 4211773
- 10x 4211445
- 13x 6093859
- 11x 4211494
- 46x 4211398
- 9x 4211414
- 2x 6170387
- 1x 4211564
- 2x 6123809
- 5x 4234535
- 8x 4211353
- 2x 4211410
- 1x 6163990
- 11x 4211396
- 2x 4211356
- 1x 6213378
- 13x 6435857
- 14x 4211349
- 11x 4211387
- 1x 4216250
- 3x 4211397
- 1x 6177078
- 1x 6126082
- 18x 4211429
- 8x 4211386
- 2x 6435930
- 1x 6306729
- 4x 6163477
- 1x 4645397
- 3x 4558169
- 1x 6075066
- 3x 4211438
- 2x 4211393
- 1x 4618874
- 2x 4243797
- 2x 4211549
- 1x 6015347
- 7x 4211385
- 2x 4211395
- 1x 6372029
- 1x 4211392
- 6x 4211404
- 1x 6037399
- 1x 4211474
- 3x 4251149
- 2x 4211521
- 2x 4211407
- 3x 6059033
- 3x 4211452
- 1x 4211795
- 2x 4211425
- 6x 4157103
- 3x 6439042
- 3x 4173805
- 16x 4121739
- 17x 4220634
- 23x 4164037
- 10x 6254256
- 85x 6251295
- 3x 6343877
- 11x 6252049
- 1x 4211522
- 1x 4211402
- 1x 4211405



 [LEGO.com/service](https://www.LEGO.com/service)



# YOU COULD WIN



## YOU COULD WIN

Your feedback will help shape the future development of this product series.

Visit:

## DU KÖNNTEST GEWINNEN

Dein Feedback trägt zur Weiterentwicklung dieser Produktreihe bei.

Geh auf:

## VOUS POURRIEZ GAGNER

Vos commentaires nous aideront à concevoir les futurs produits de cette gamme.

Visitez :

## POTRESTI VINCERE TU

La tua opinione ci aiuterà a migliorare la creazione futura di questa linea di prodotti.

Visita:

## PUEDES GANAR

Tu opinión contribuirá al futuro de esta serie de productos.

Visita:

## 轻松获奖

您的反馈将有助于我们在今后改进本产品系列。

请访问:

---

**[LEGO.com/productfeedback](https://www.lego.com/productfeedback)**

---

You also have the chance to win a LEGO® set.

Terms and conditions apply.\*

Außerdem hast du die Chance, ein LEGO® Set zu gewinnen.

Es gelten die Teilnahmebedingungen.\*

Vous pourriez également gagner un ensemble LEGO®.

Des conditions s'appliquent.\*

Hai anche la possibilità di vincere un set LEGO®.

Termini e condizioni sono applicabili.\*

También tienes la oportunidad de ganar un set LEGO®.

Aplican términos y condiciones.\*

您还有机会赢取乐高®套装。

条款和条件适用。\*

\*[LEGO.com/productfeedback-terms](https://www.lego.com/productfeedback-terms)

# II

LEGO and the LEGO logo are trademarks of the LEGO Group. ©2023 The LEGO Group. 6477033

WIZARDING WORLD and all related trademarks, characters, names, and indicia are  
© & ™ Warner Bros. Entertainment Inc. Publishing Rights © JKR. (s23)