

# BIONICLE MAHRI

TOA MATORO



8915

LEGO



1

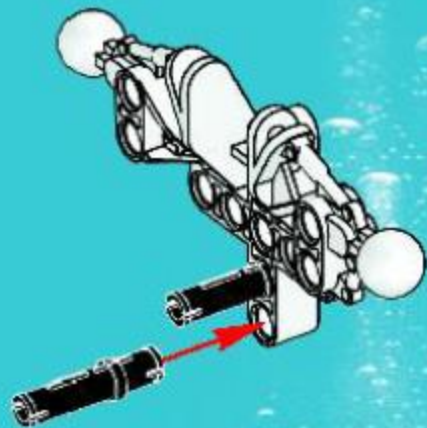

2

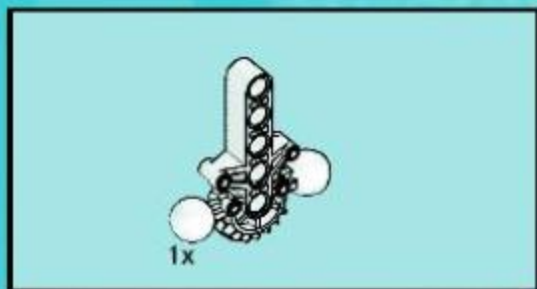

2

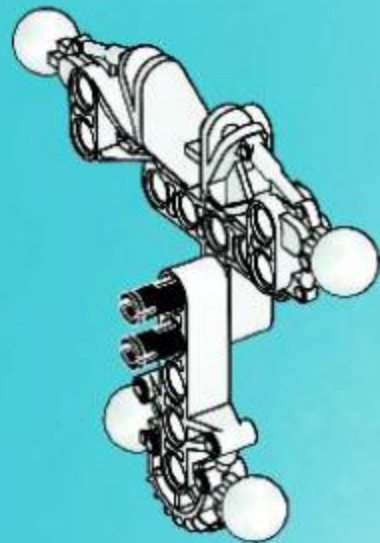

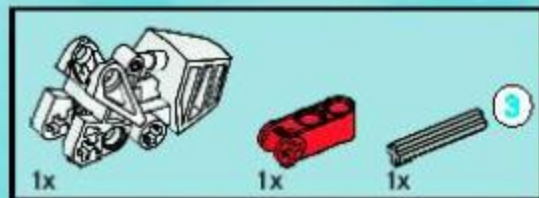

3

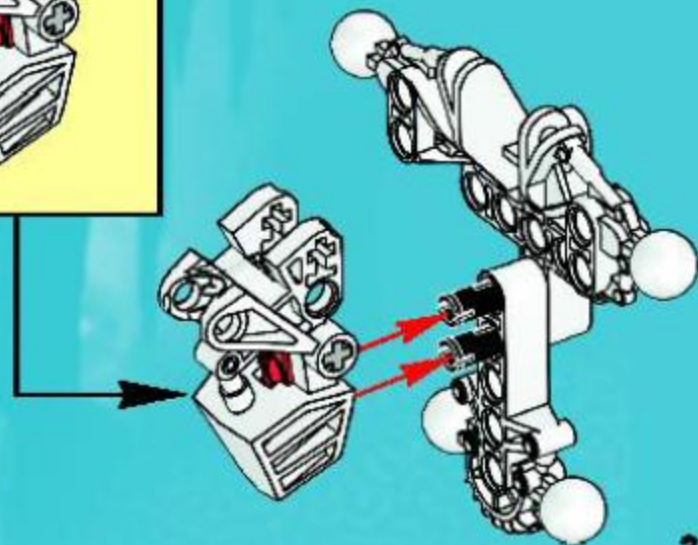
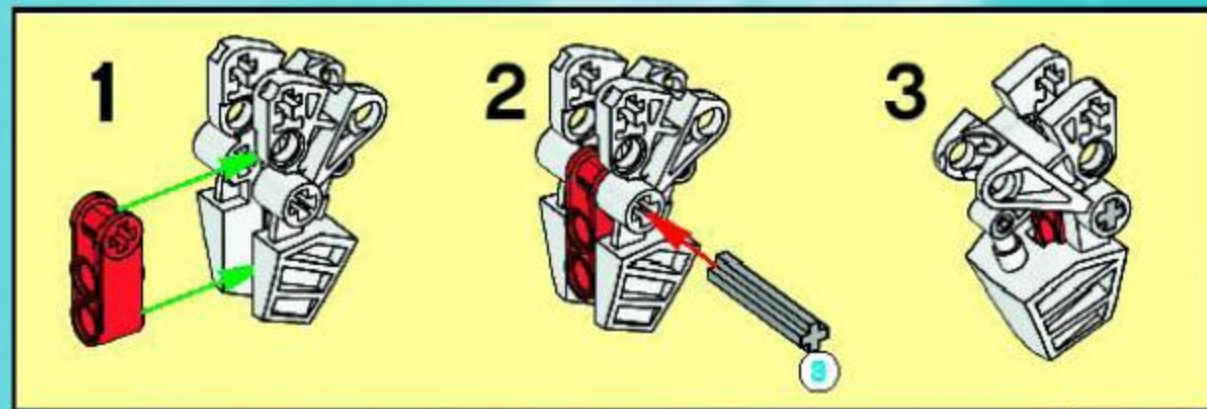

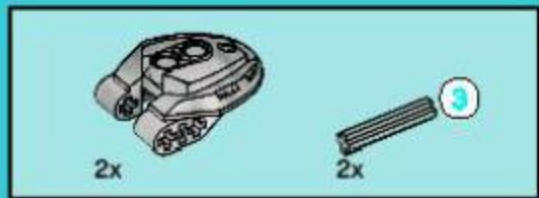

4

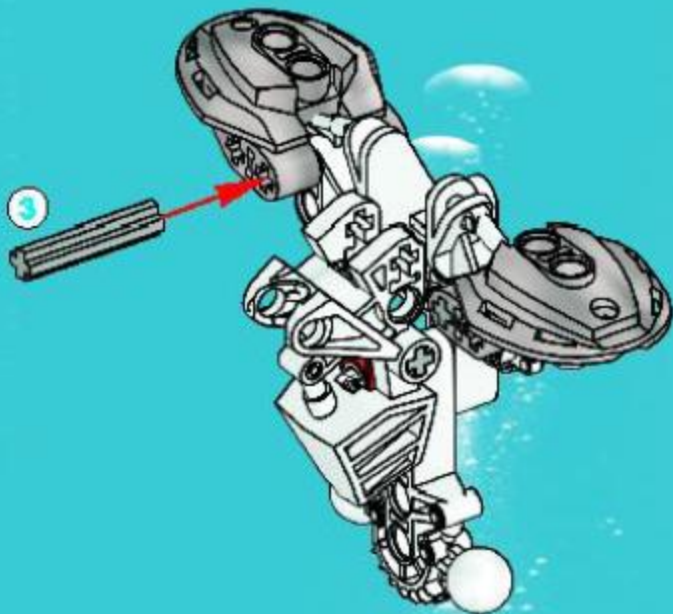

4



5

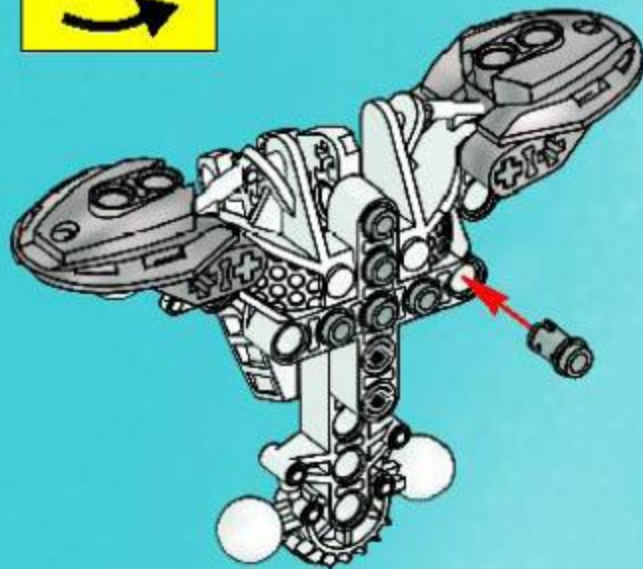

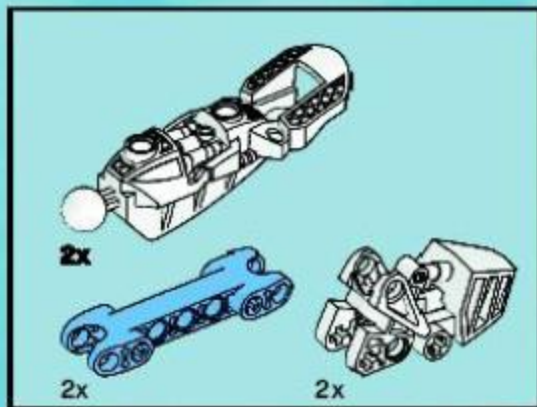

6

1



2



**3**



**2x**

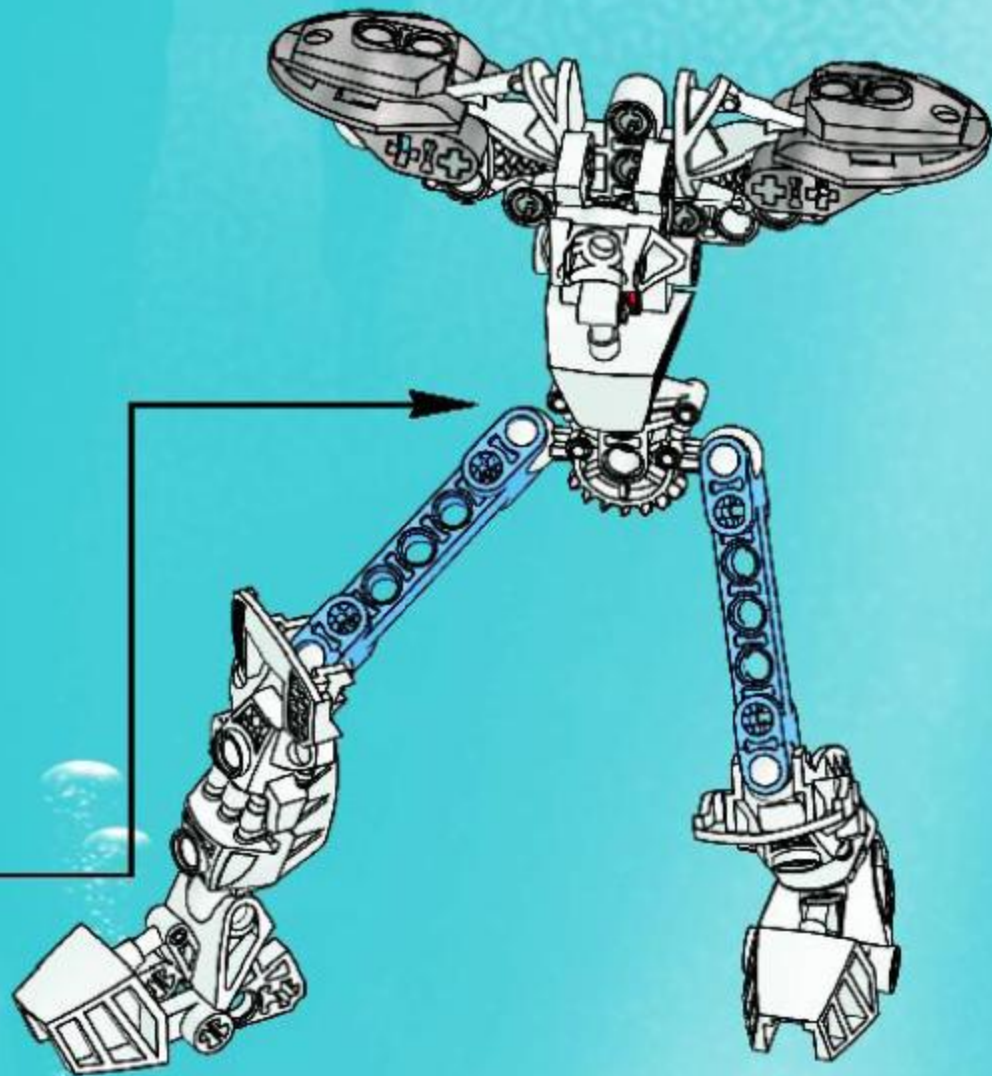

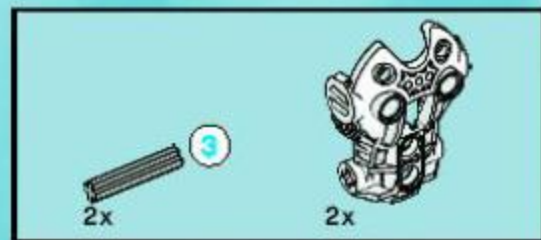

# 7

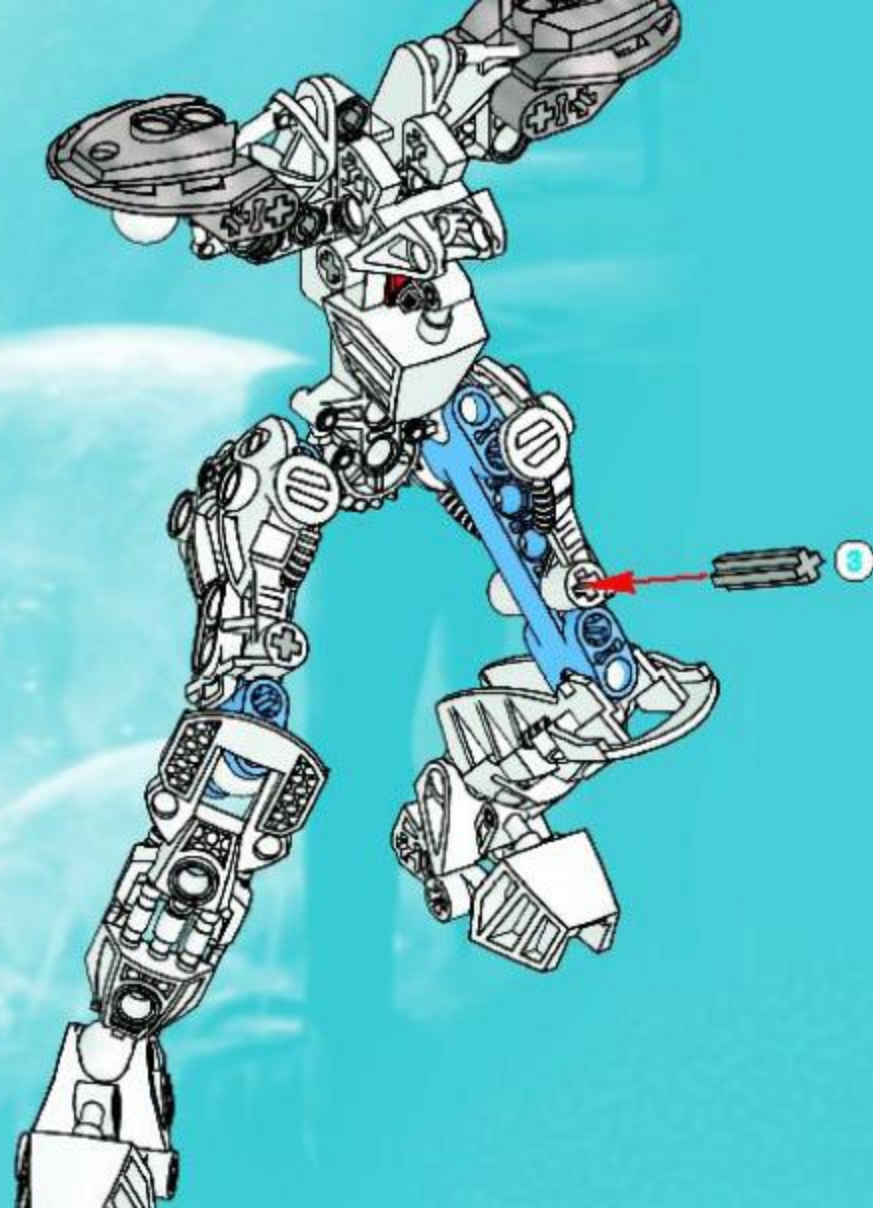

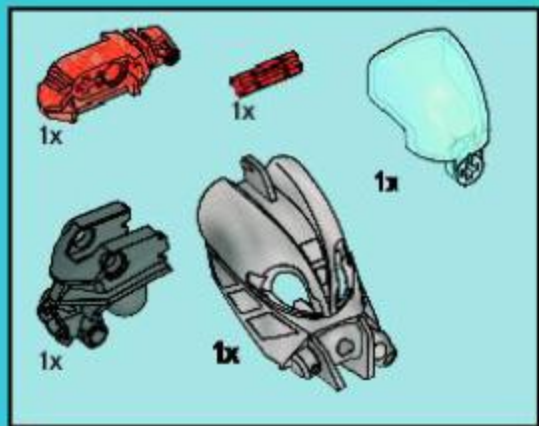

8

1

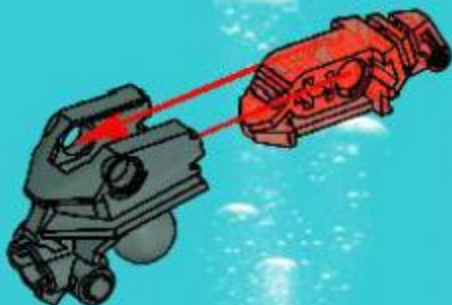

2

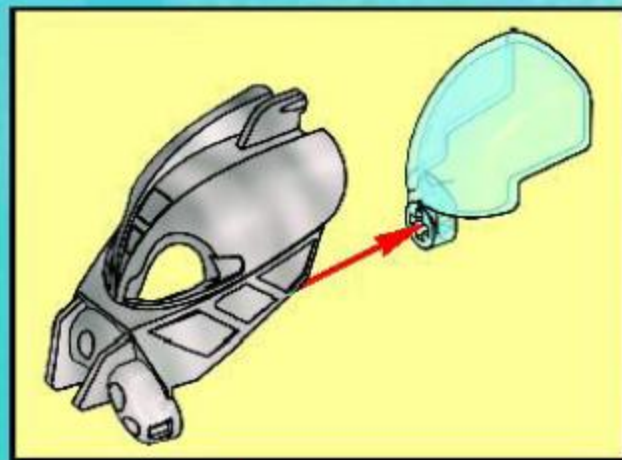

3

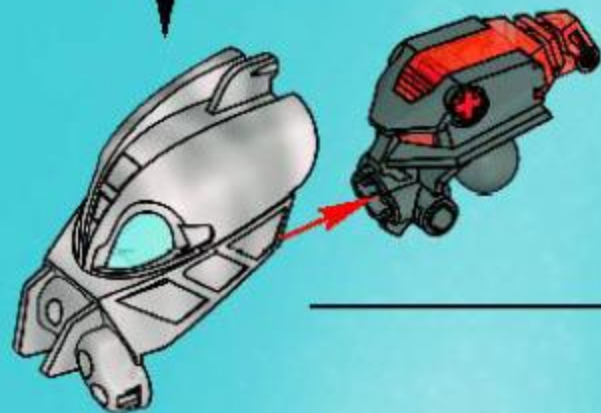



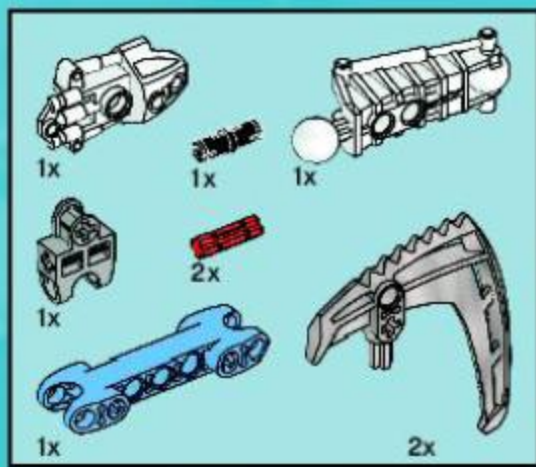
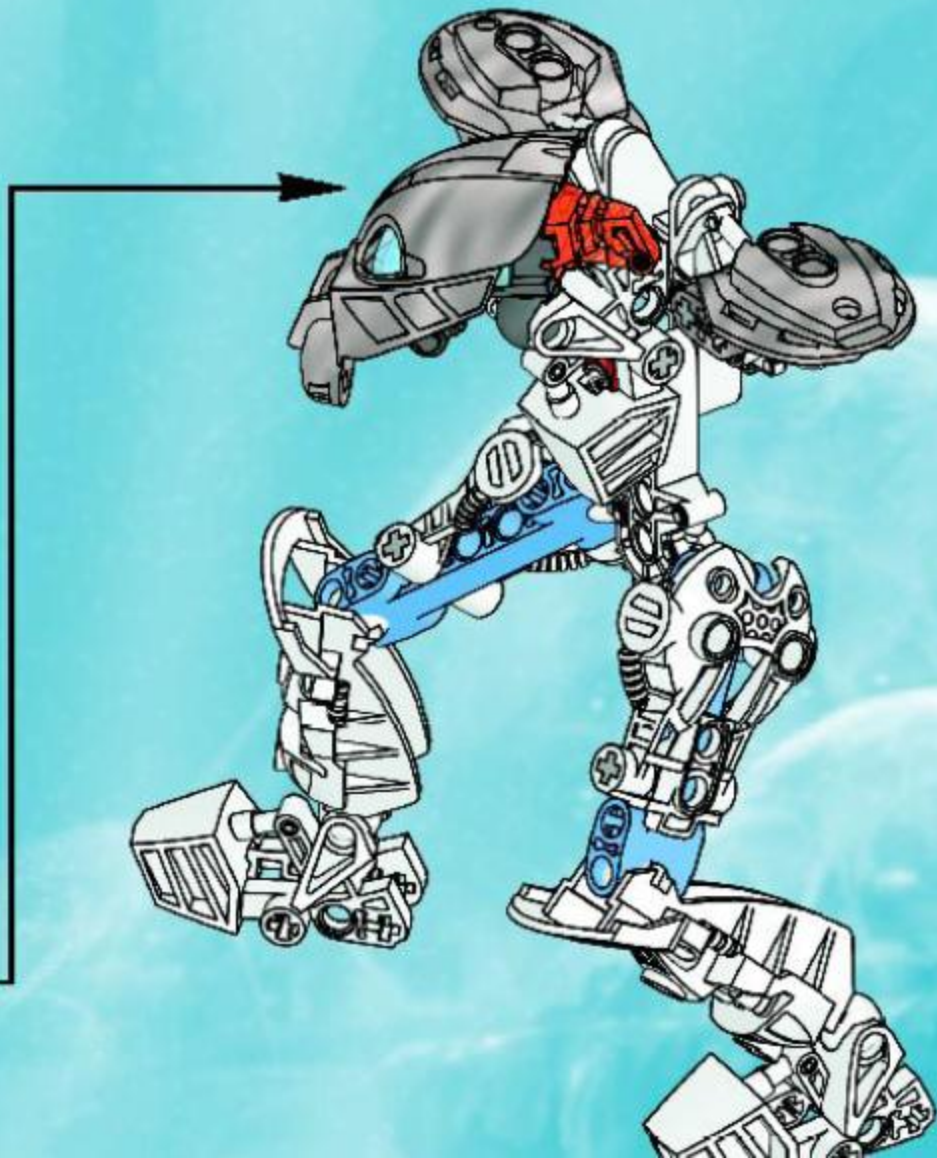

9

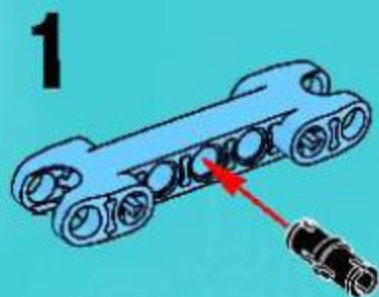

2

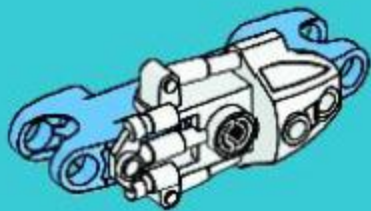

4

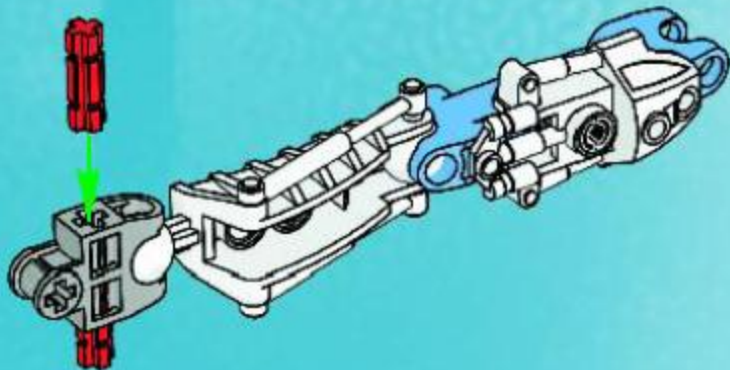

3

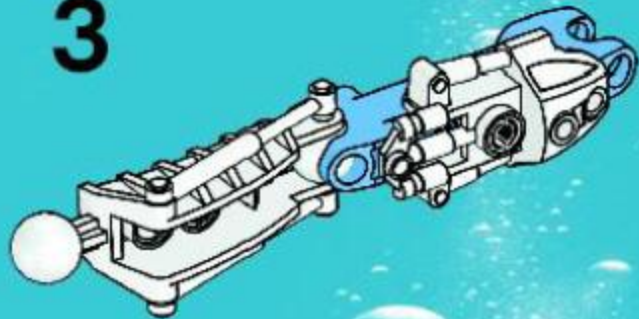

5

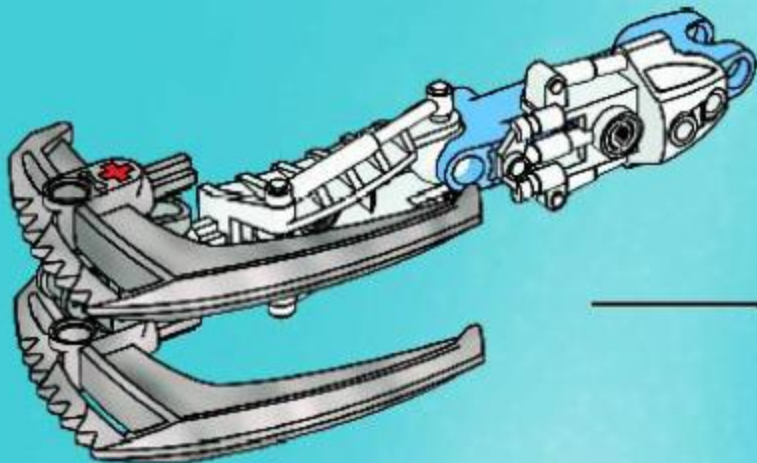

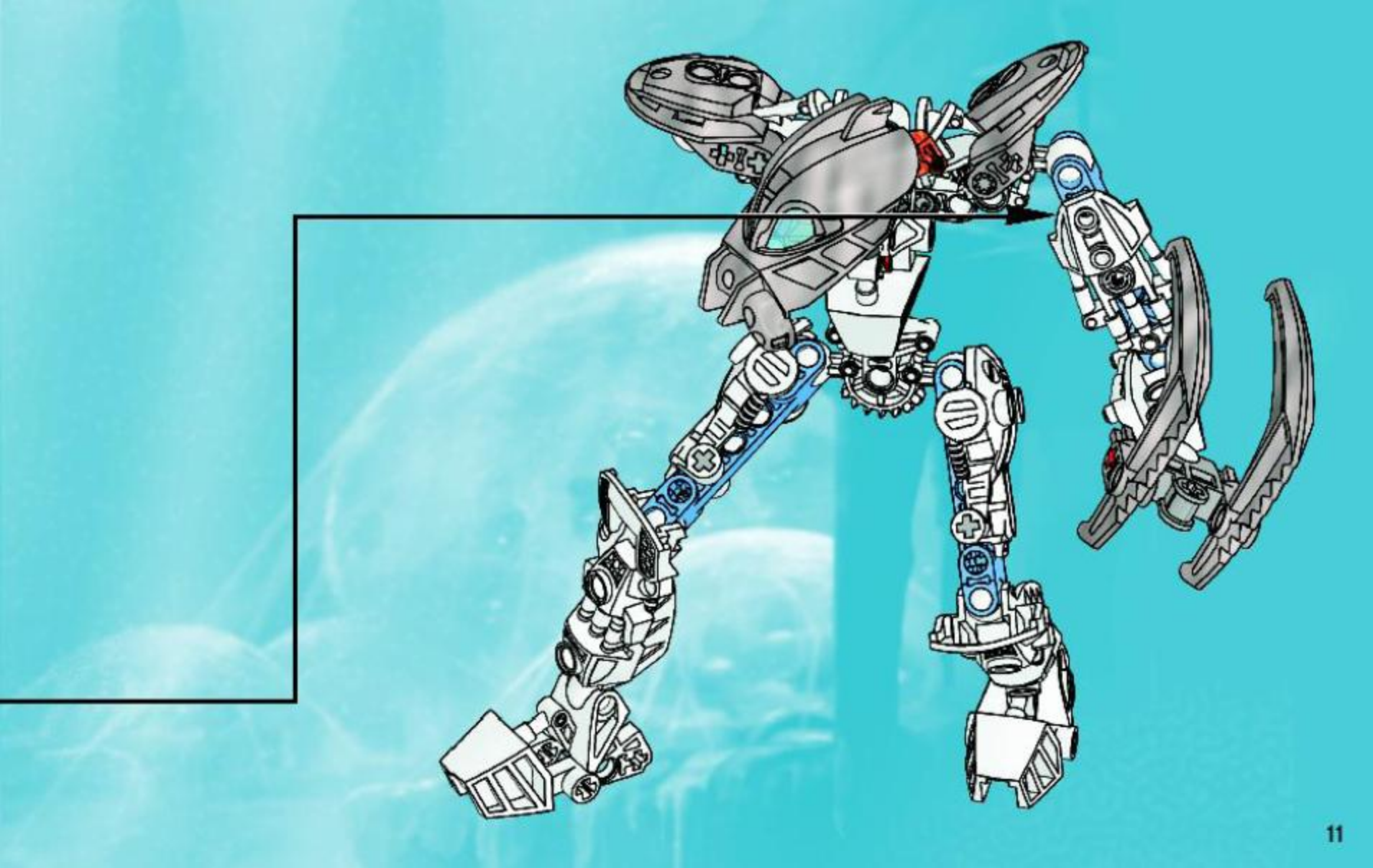

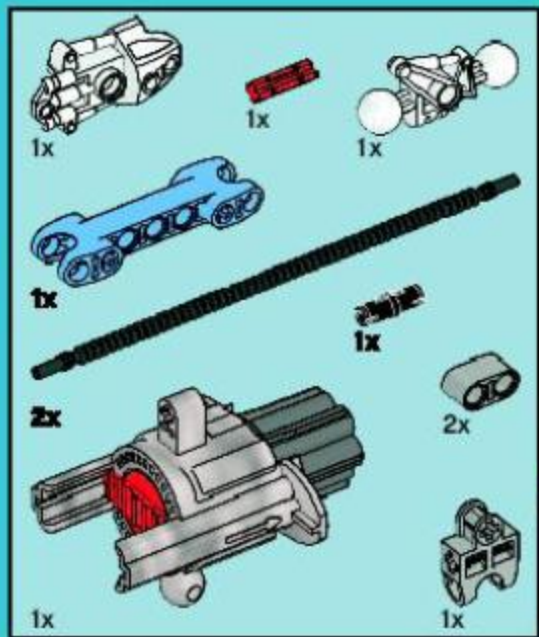

10



2

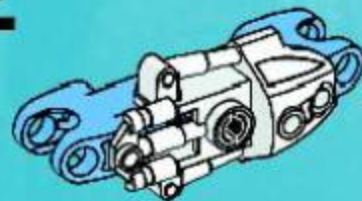

3

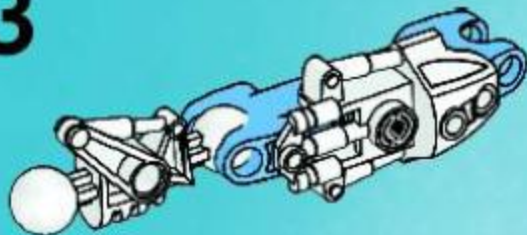

4



5

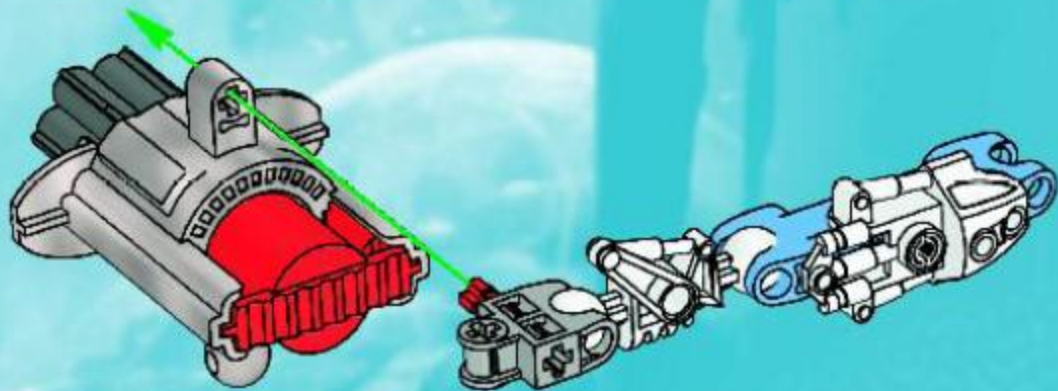

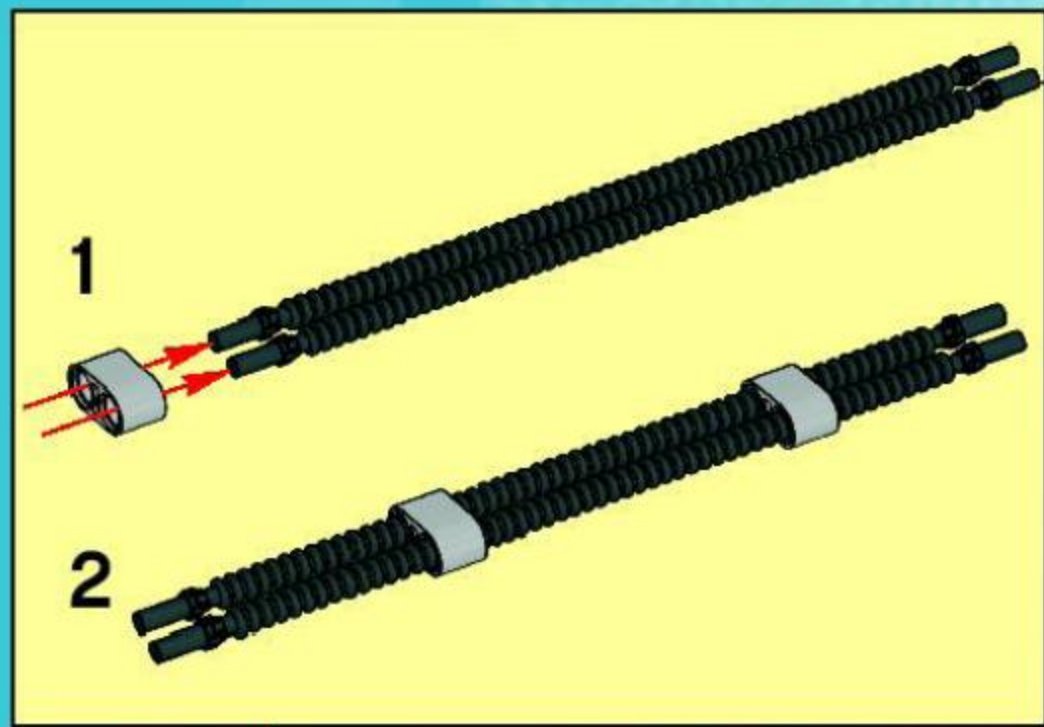
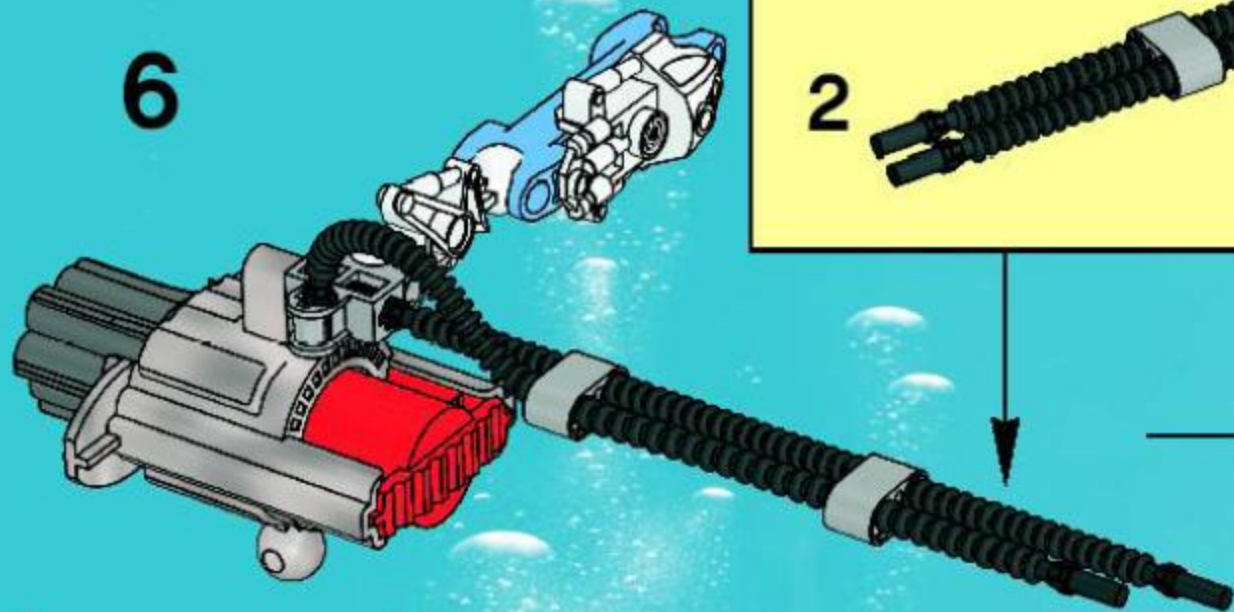

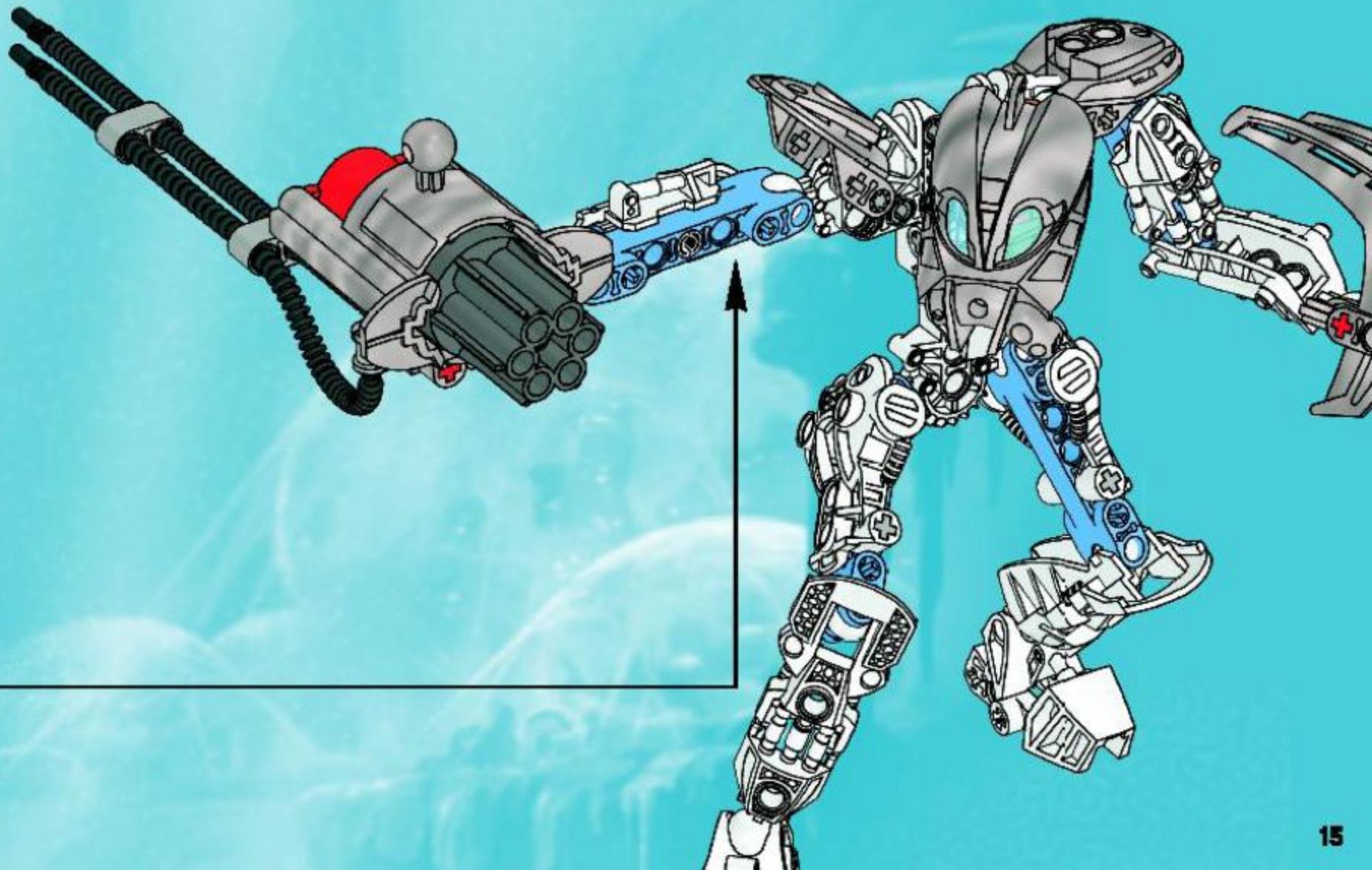

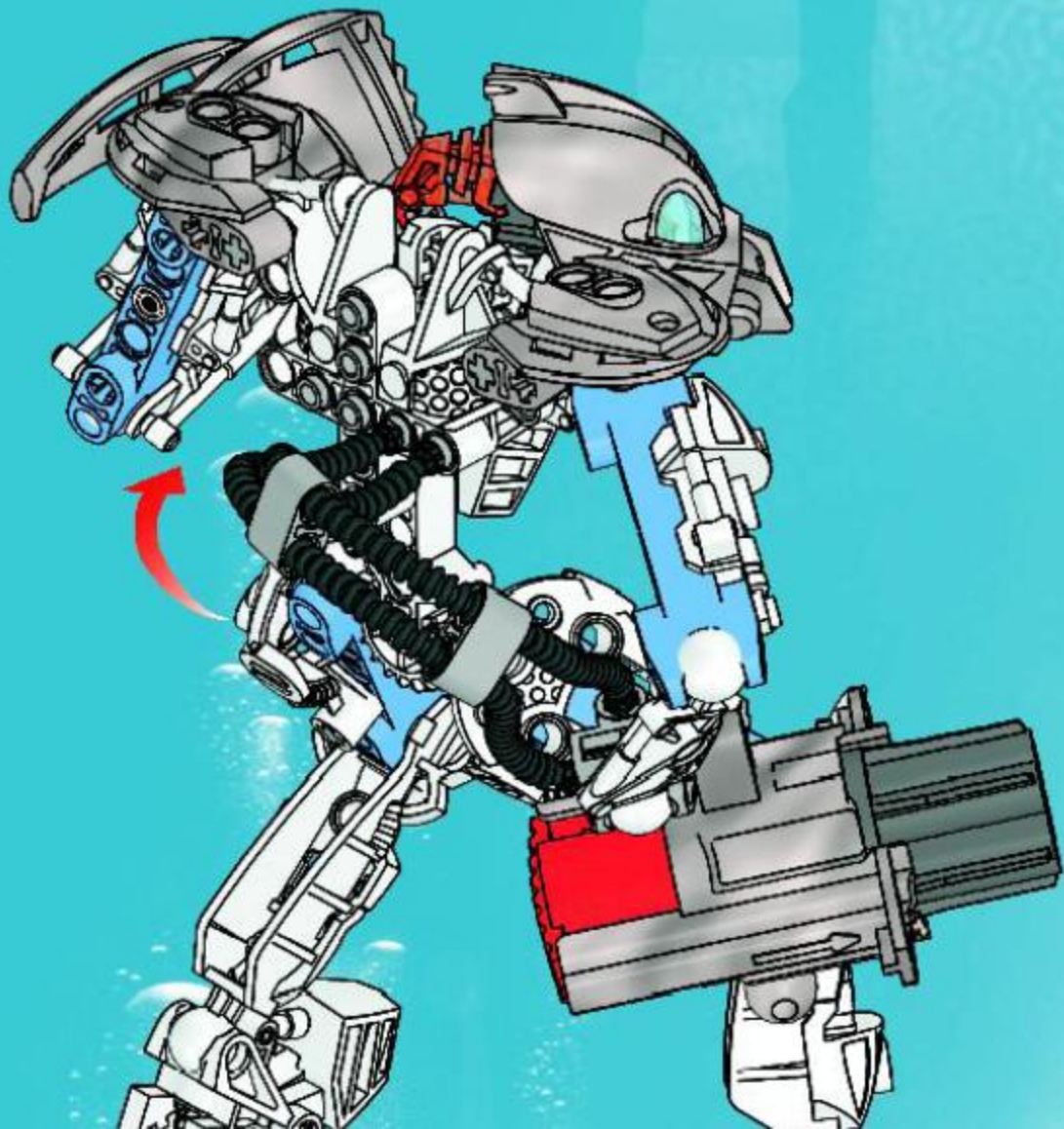



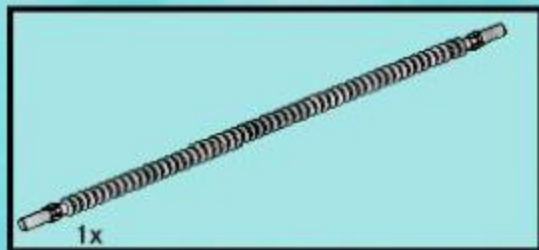

11

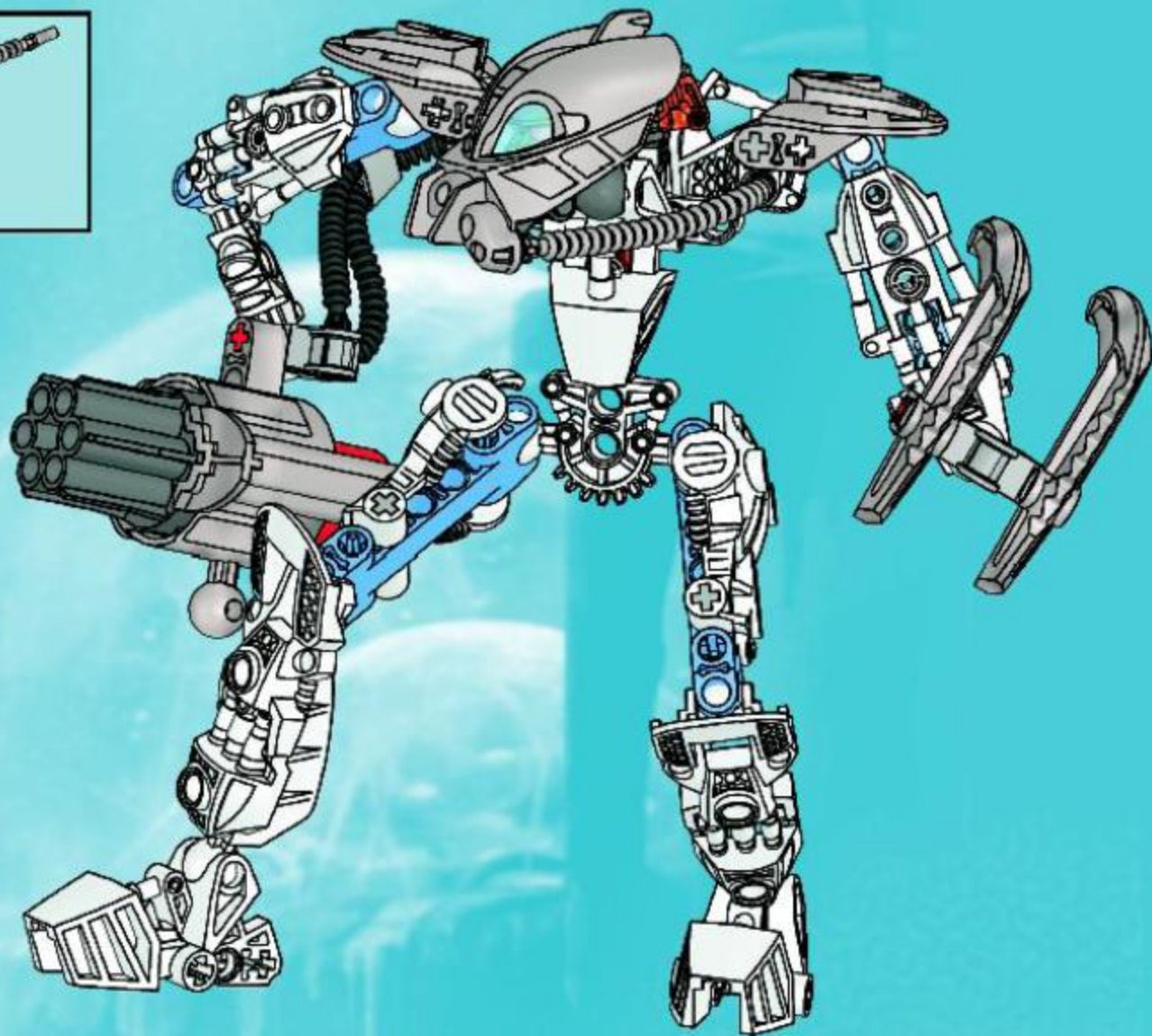



12

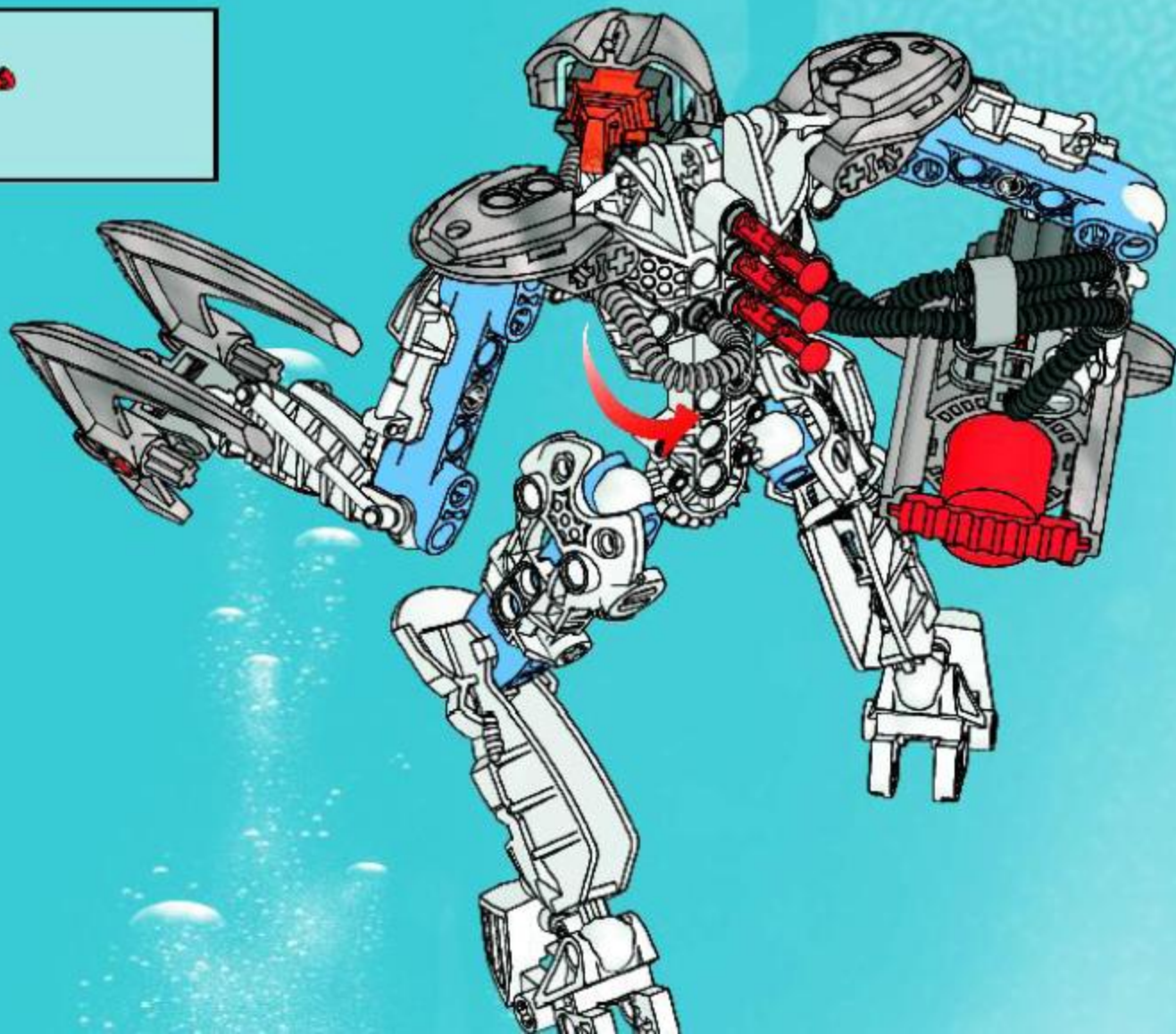

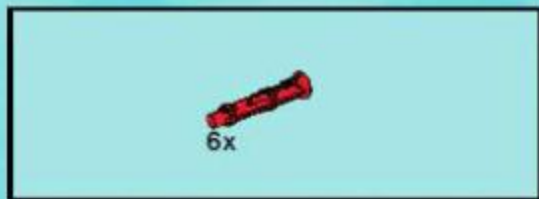

13

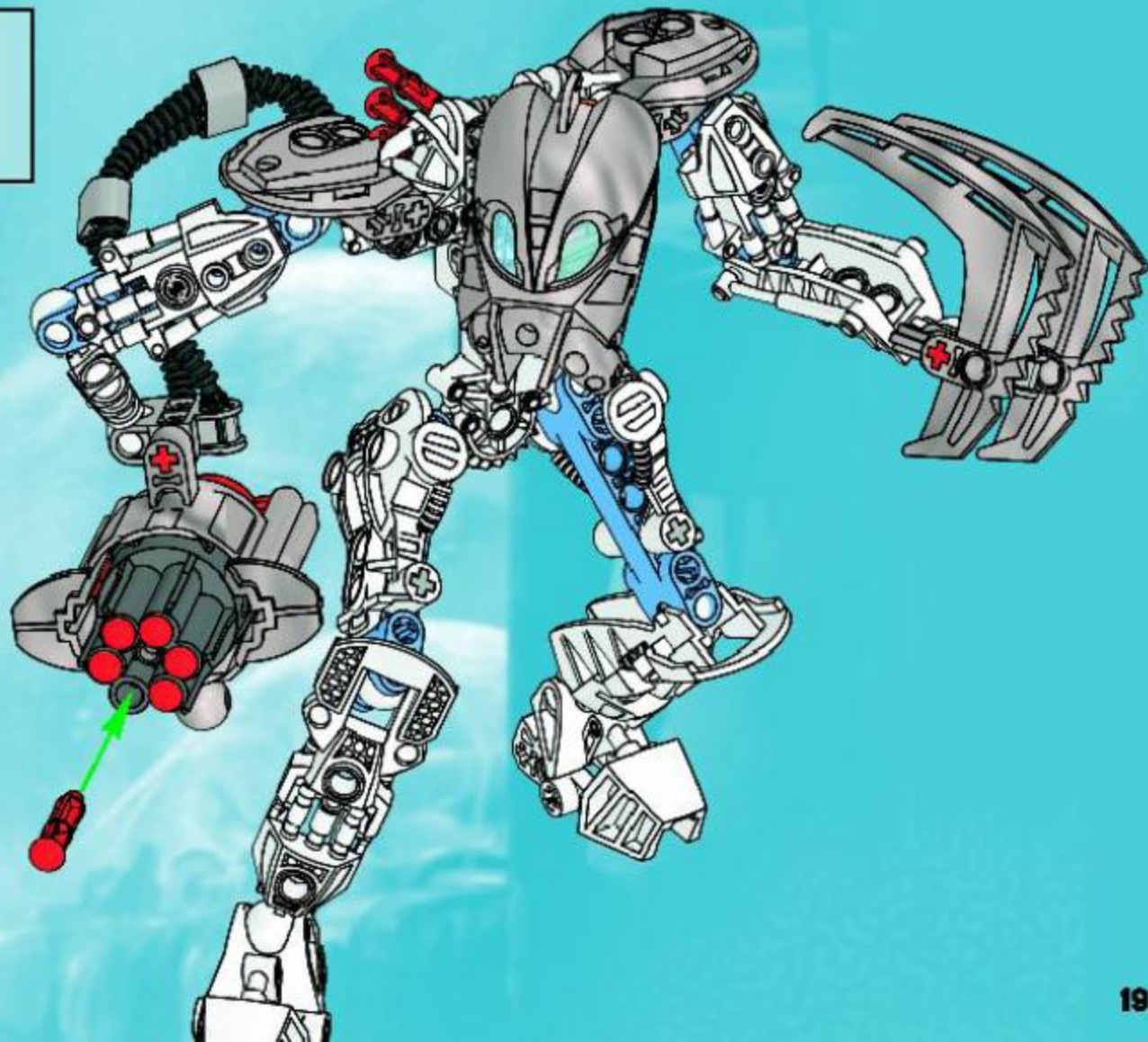

1



2



3





1x  
4278499



2x  
4281240



4x  
4252412



1x  
4504985



6x  
4211483



1x  
4278479



2x  
4292642



1x  
4505821



5x  
4211815



2x  
4504986



2x  
4292537



3x  
4143511



1x  
4238919



2x  
4240563



2x  
4504538



1x  
4506532



4x  
4142865



2x  
4121715



2x  
4211862

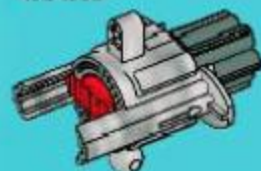

1x  
4504505



1x  
4278740



9x  
4497796



2x  
655826



1x  
4278473



1x  
4506460



1x  
4175442



2x  
655826



1x  
4278473



2x  
4504612

# Win! Gagne! 当たります Gewinne!

## Win LEGO products

We would like to know what you think about your new LEGO product. Log on to the web address below for further instructions.

## Gagne des produits LEGO

Nous aimerions savoir ce que tu penses de ton nouveau produit LEGO. Tu obtiendras davantage d'informations en visitant le site Internet indique ci-dessous.

## Gewinne LEGO produkte

Wir sind sehr an deiner Meinung über dein neues LEGO Produkt interessiert. Gehe einfach zu der unten angegebenen Webadresse – dort findest du weitere Informationen.

## Estimado usuario LEGO

Al contestar algunas preguntas en inglés, francés, alemán o japonés, en el sitio [www.acnielsen.aim.dk/lego](http://www.acnielsen.aim.dk/lego), podrás participar en el sorteo de algunos valiosos premios LEGO.

## Caro Consumidor da LEGO

Ao responder a algumas perguntas em Inglês, Francês, Alemão ou Japonês no endereço [www.acnielsen.aim.dk/lego](http://www.acnielsen.aim.dk/lego) irá participar num concurso para ganhar valiosos prémios da LEGO.

## Kedves ifjú LEGO Vásárló

Ha ellátogatsz a [www.acnielsen.aim.dk/lego](http://www.acnielsen.aim.dk/lego) honlapra és ott angol, francia, német vagy japán nyelven megválaszolsz néhány kérdést, akkor részt veszel egy versenyben, amelyben értékes LEGO díjakat nyerhetsz.

## 英語でLEGO製品が当たります

私たちは、皆さんが買いたいおもちゃのLEGO製品についてどんな意見をもちたいか、知りたく思っています。質問に答えて、楽しいLEGO製品の抽選に応募してください。アンケートの回答には、ほんの少額ですがLEGOがもらえます！詳しくは、以下のウェブアドレスまでアクセスしてください。

[www.acnielsen.aim.dk/LEGO](http://www.acnielsen.aim.dk/LEGO)



Any questions regarding your new LEGO product, please contact:  
**Customer Service | Kundenservice | Service Consommateurs**  
**Servicio Al Consumidor at [www.lego.com/service](http://www.lego.com/service) or dial**

 :  
00800 5346 5555

 :  
1-800-422-5346





# club™

FREE LEGO Magazine • GRATUIT • GRATIS LEGO Magazin



**Join Today!**  
.....  
**Abonne-toi  
dès aujourd'hui !**  
.....  
**Meld je nu aan!**  
.....  
**Jetzt anmelden!**

  US & Canada only

1-866-534-6258 / 1-877-518-5346  
(en français)

00800 5346 5555      

[www.LEGOclub.com](http://www.LEGOclub.com)



VISIT THE  
WORLD'S BIGGEST  
LEGO® SHOP!  
[www.LEGOshop.com](http://www.LEGOshop.com)

BIONICLE

# MAHRI

©2007 The LEGO Group. 44022218

8913

8914

8915

8911

8912

8910

LEGO