



Santa Fe Super Chief

COLORADO

10020



NEW MOUNTAIN S

COLORADO

WISCONSIN ROUTE
Colored the status of State's first
Tourist during 1940s when it was
at first also State's first road that the
State's first for road that the
State

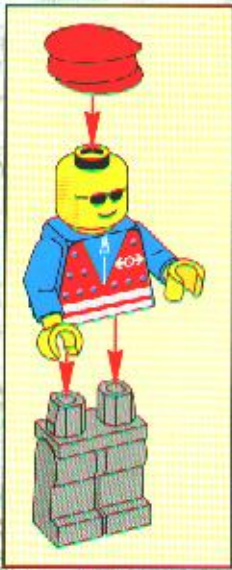

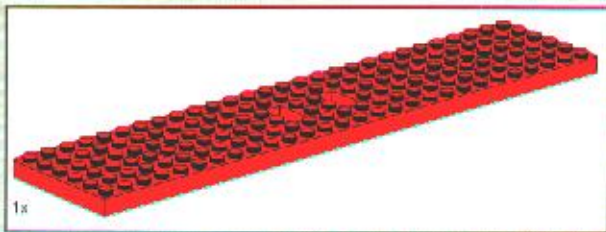

1x

1

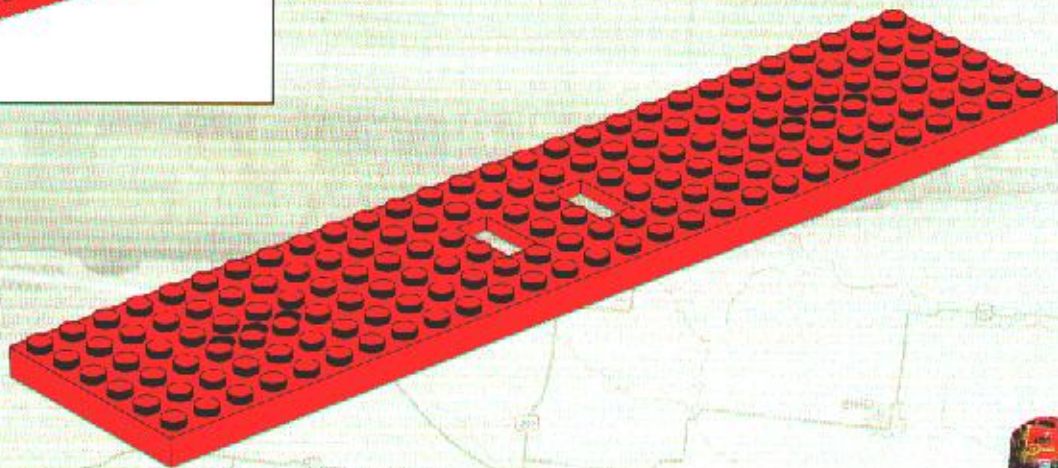

3

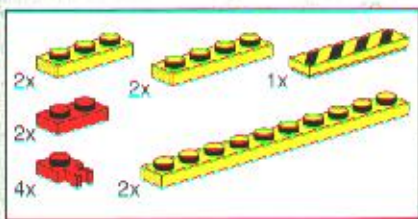

2

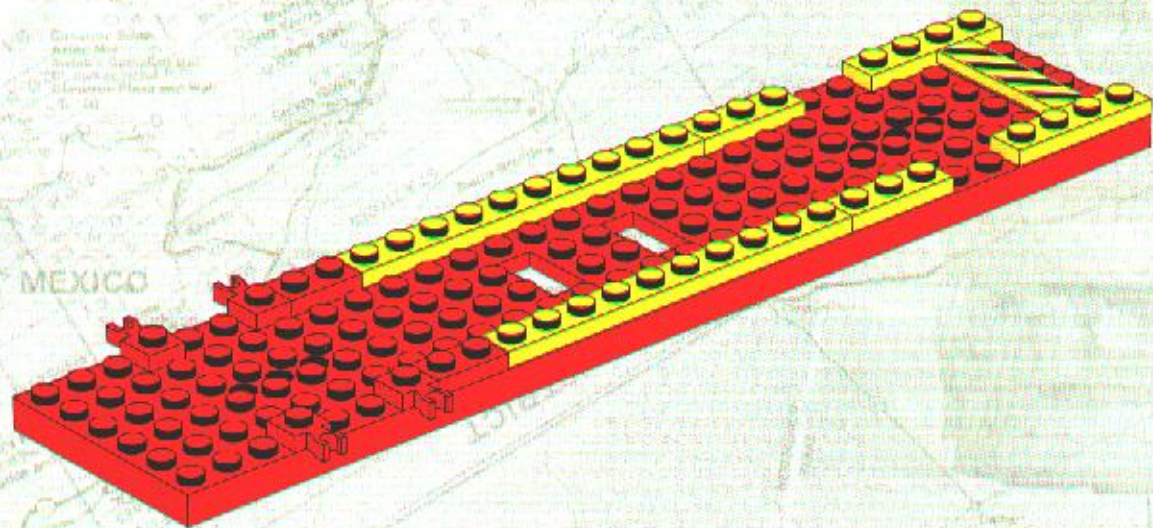

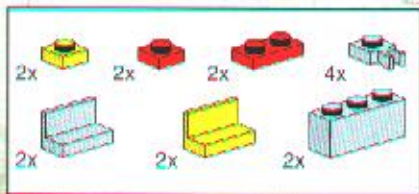

3

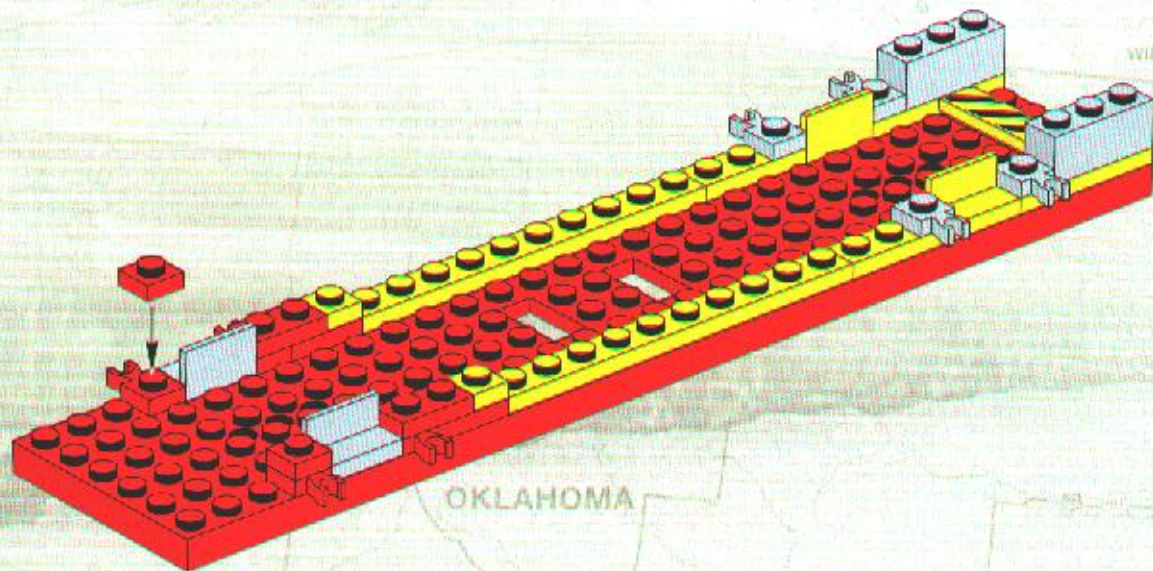

KANSAS

WICHITA

OKLAHOMA



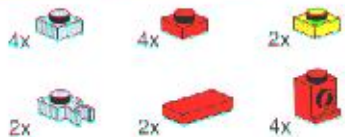

4

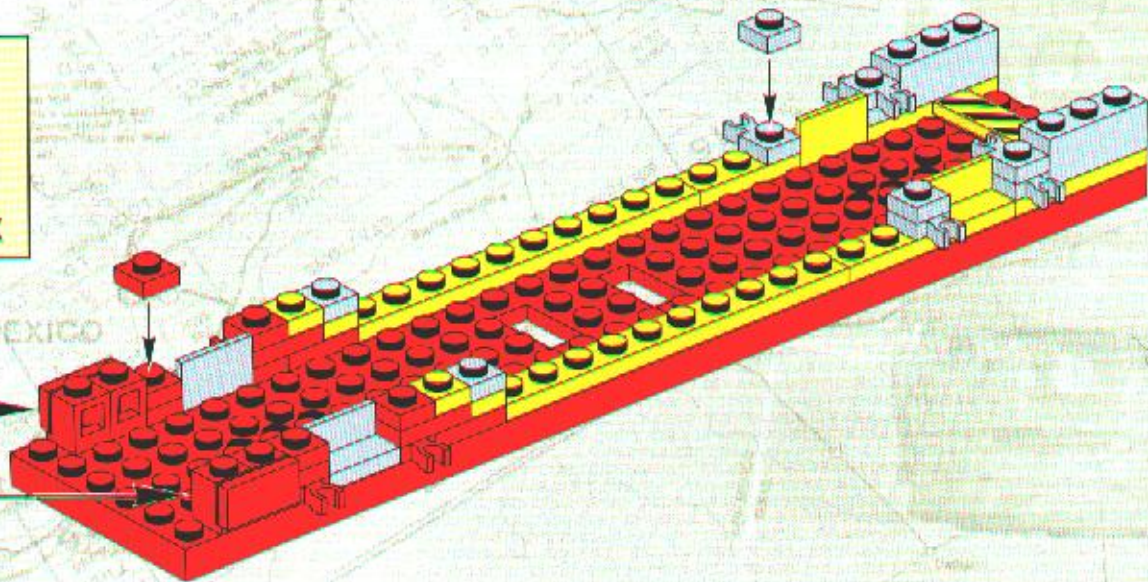
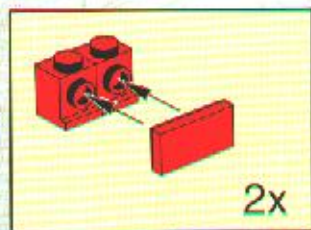

6



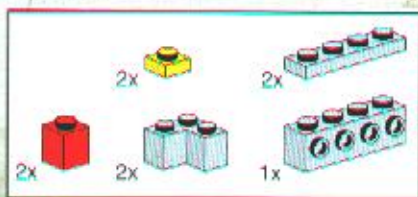

5

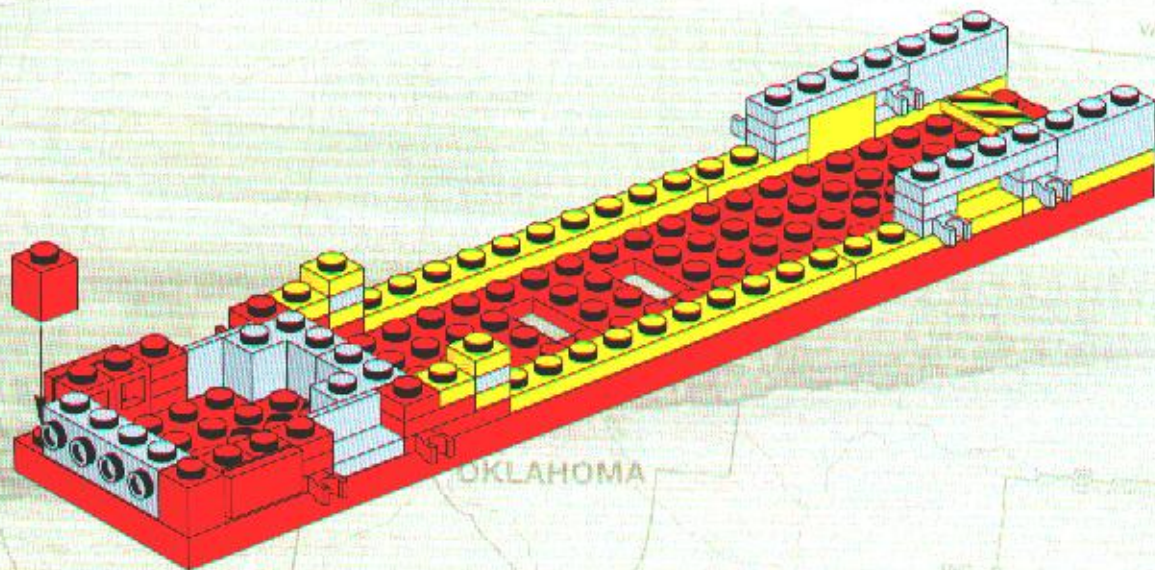

1x



2x



2x

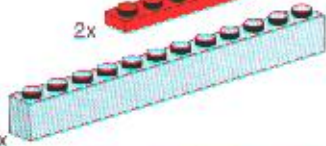

6

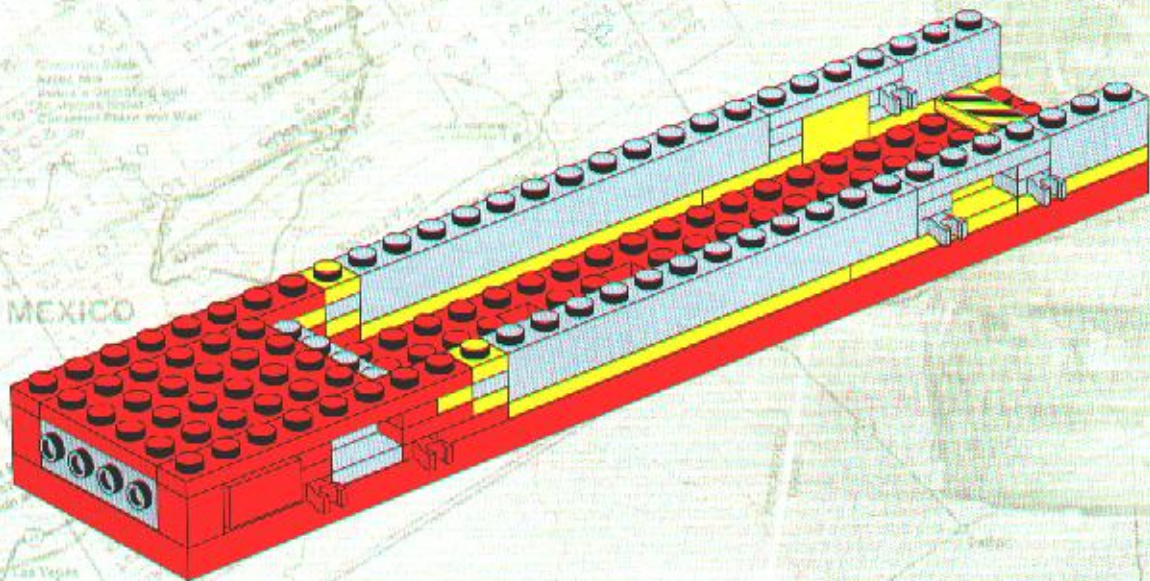

8



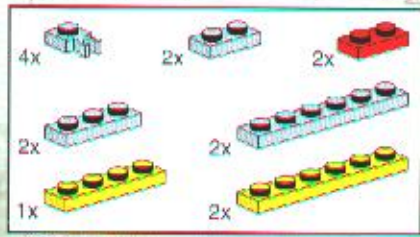

7

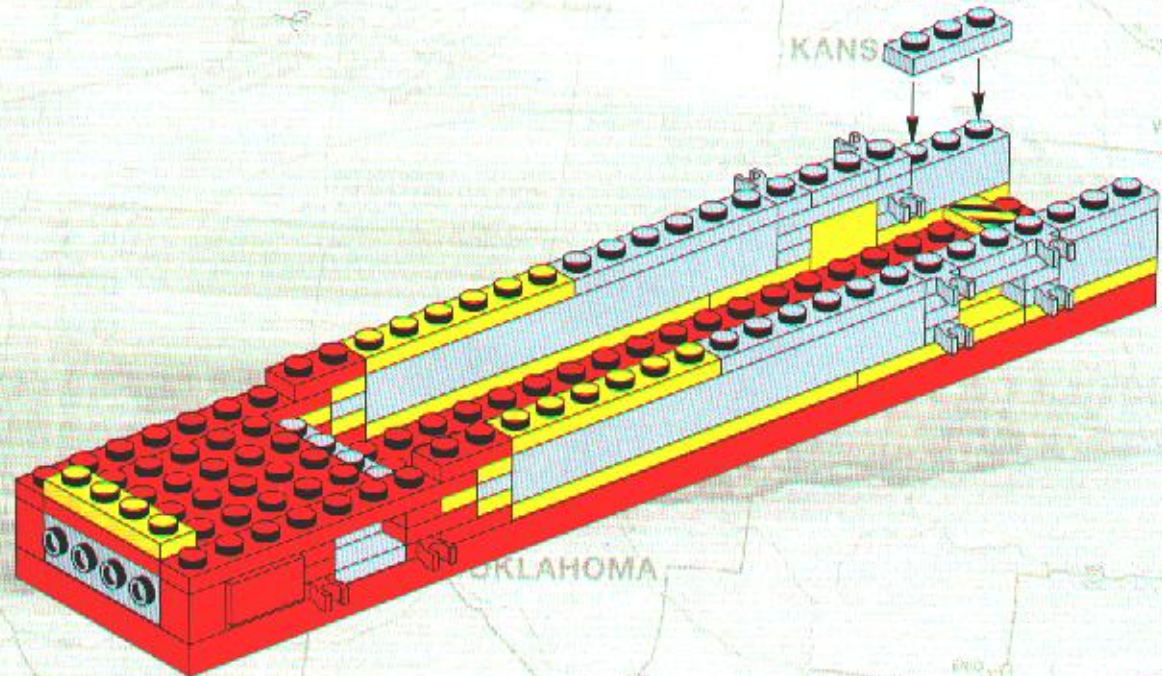

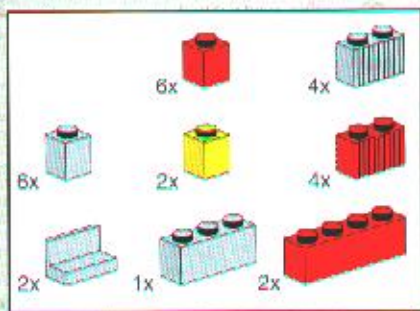

8

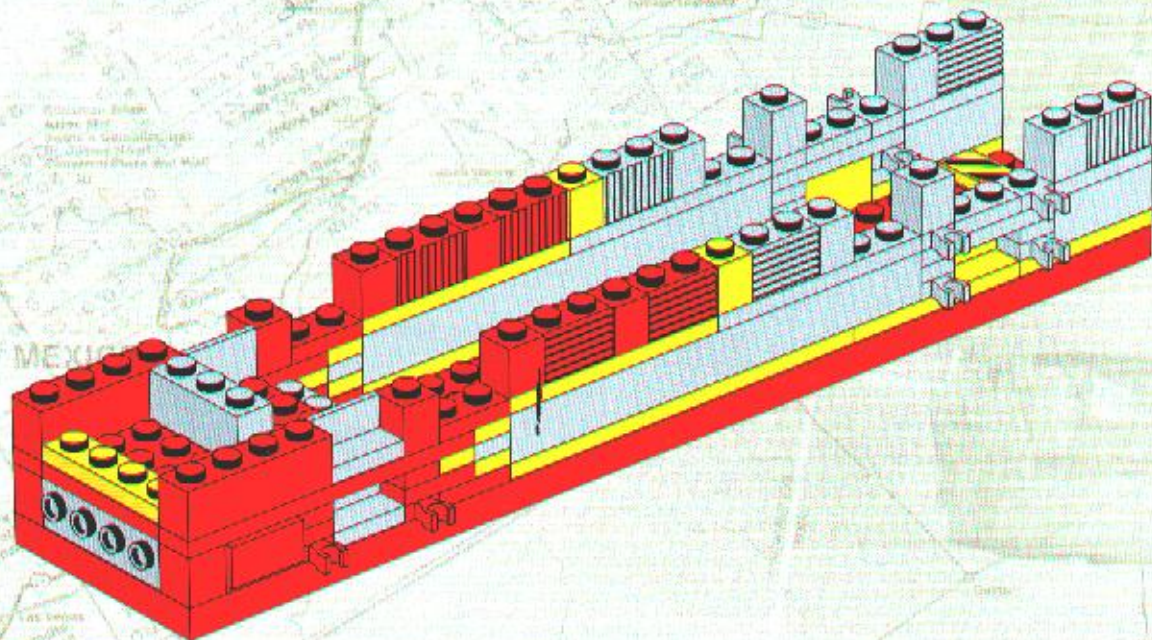

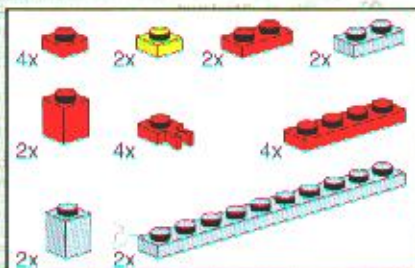

10

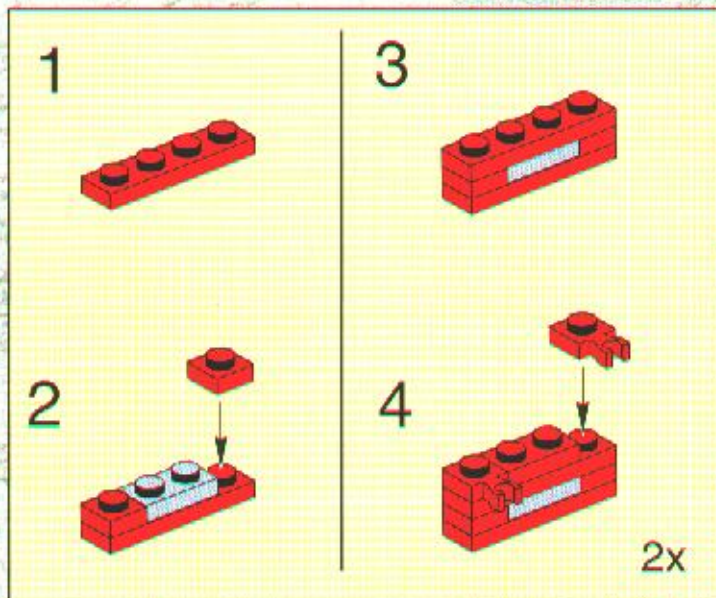

PLAIN

KANSAS

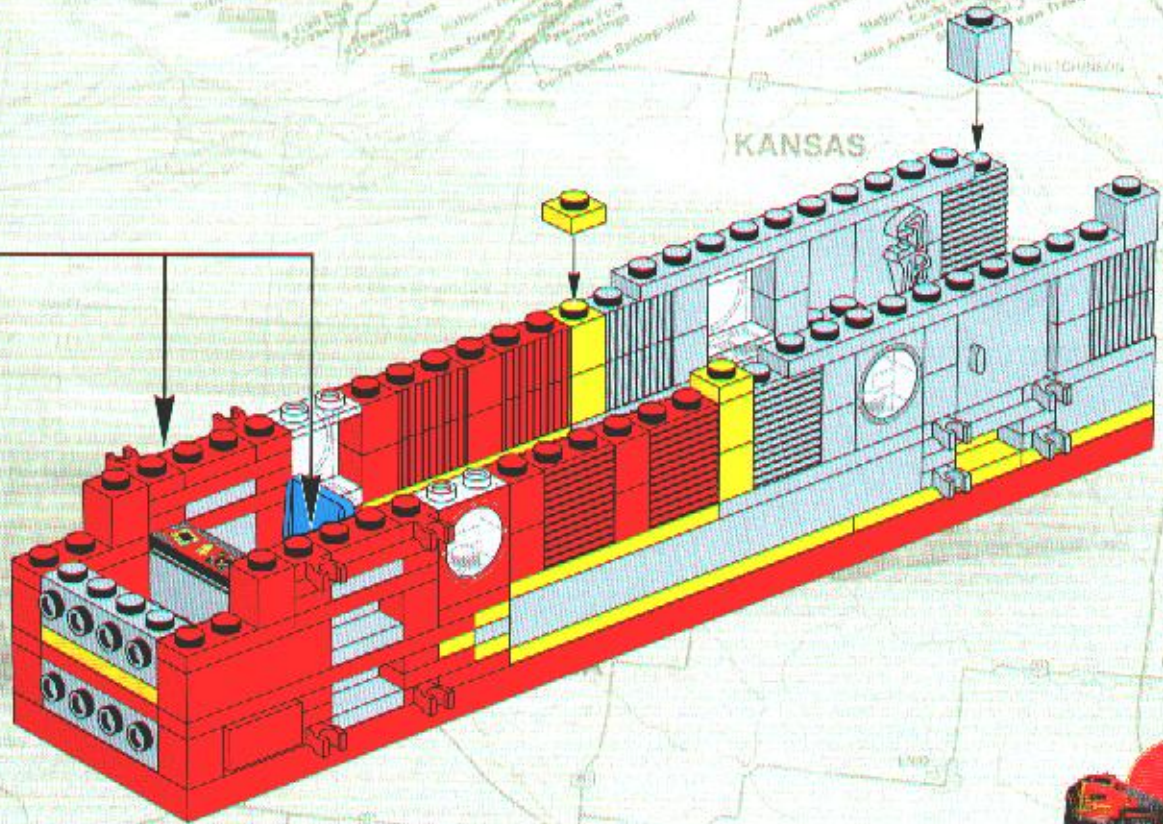

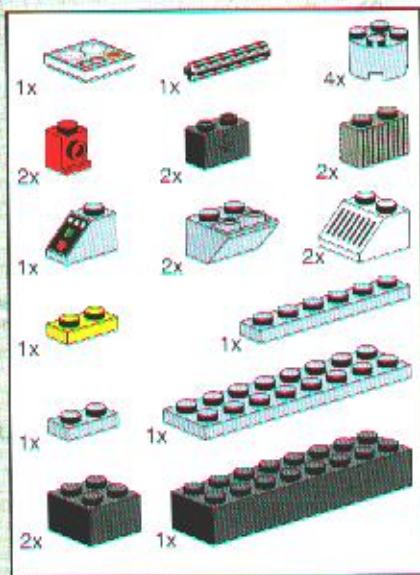

11

1

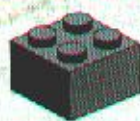

14



COLORADO

2

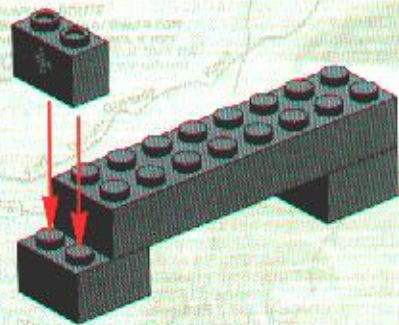

3

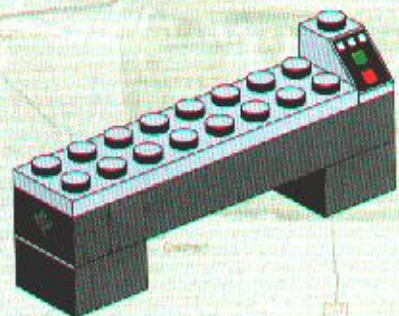

4

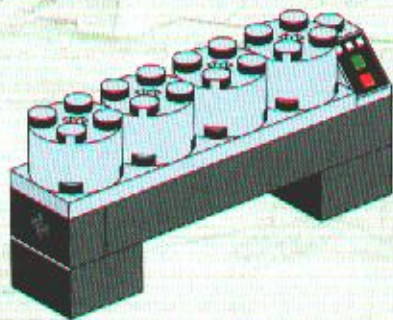

5

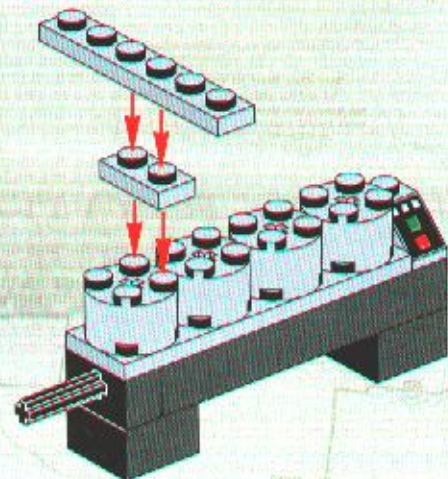

1

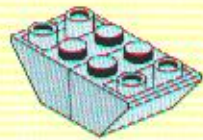

4

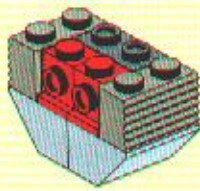

2

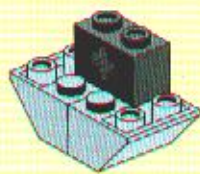

5

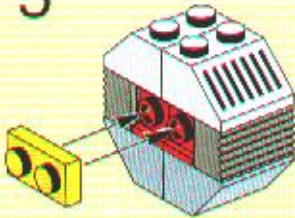

3

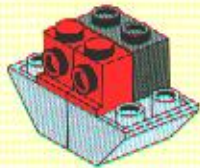

6

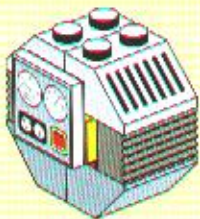

6

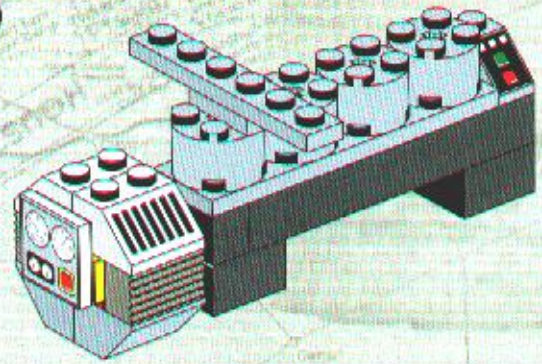

7

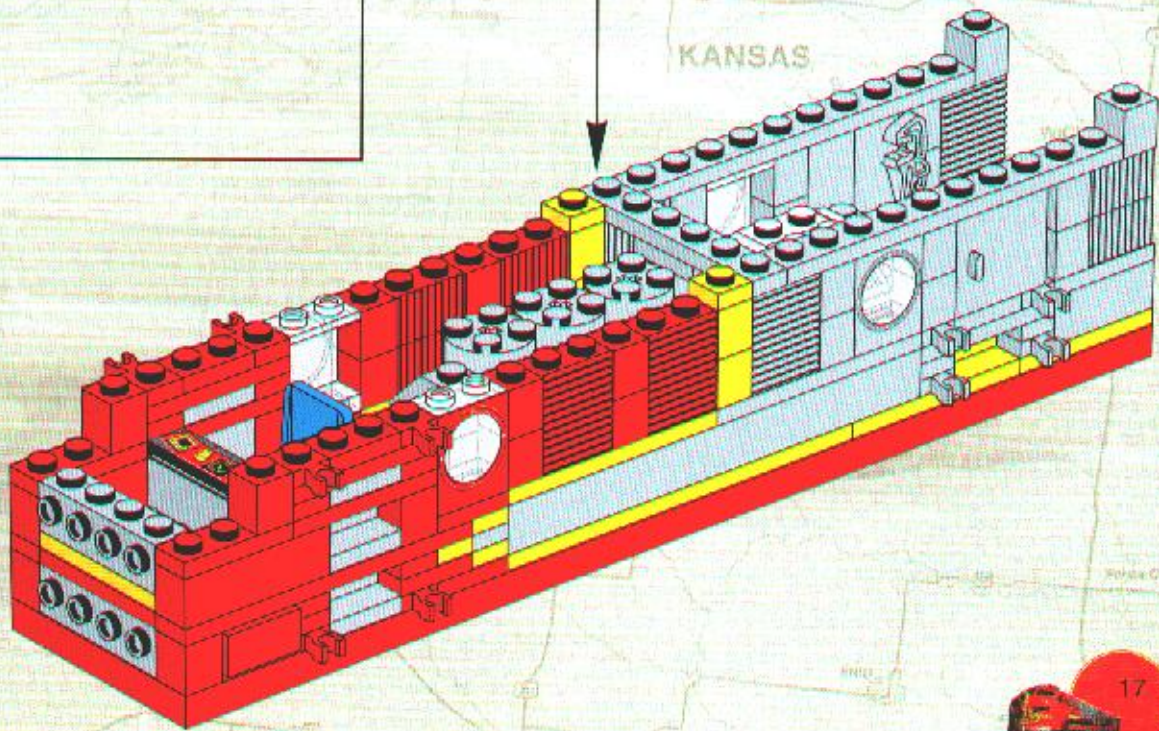
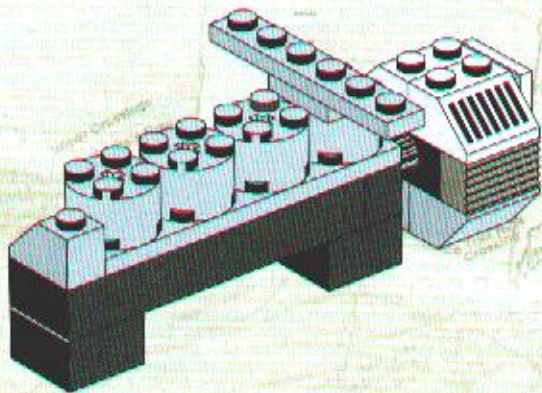

KANSAS



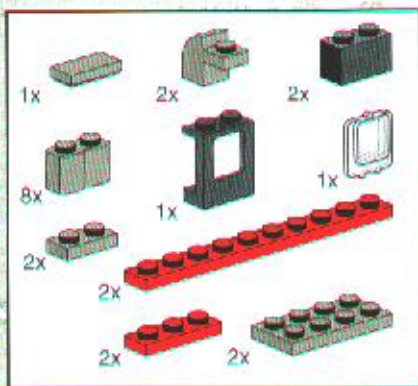

12

1

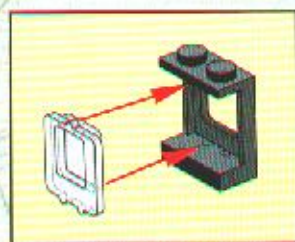

2



3



4

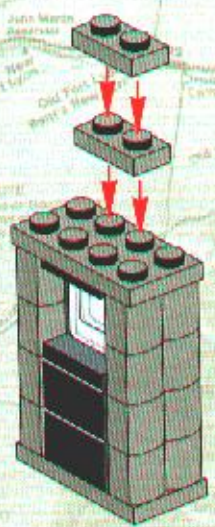

5

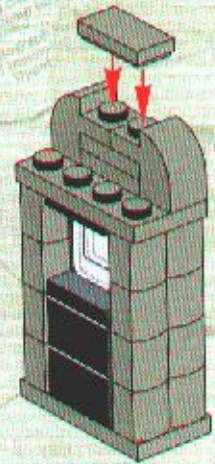

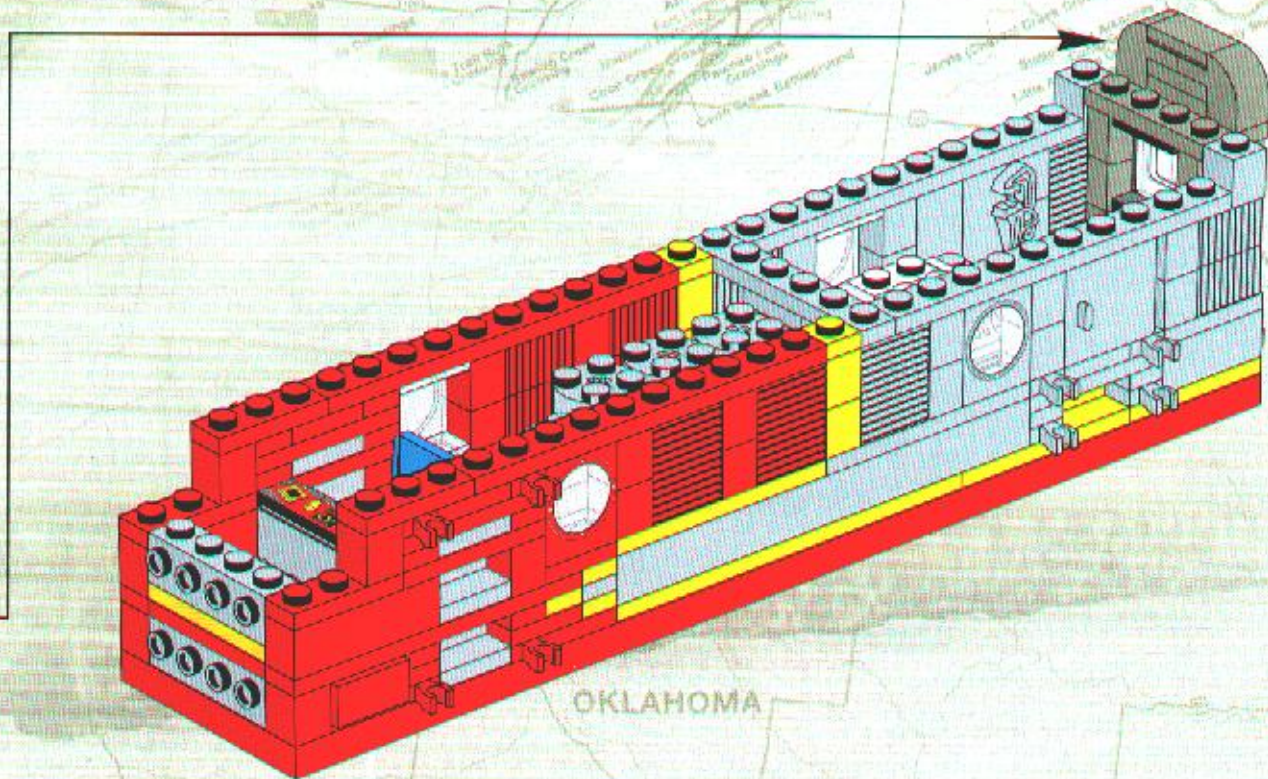

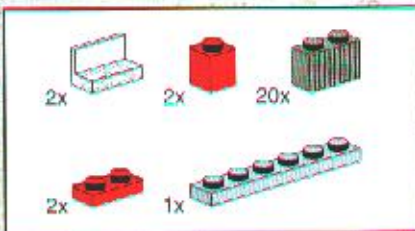

13

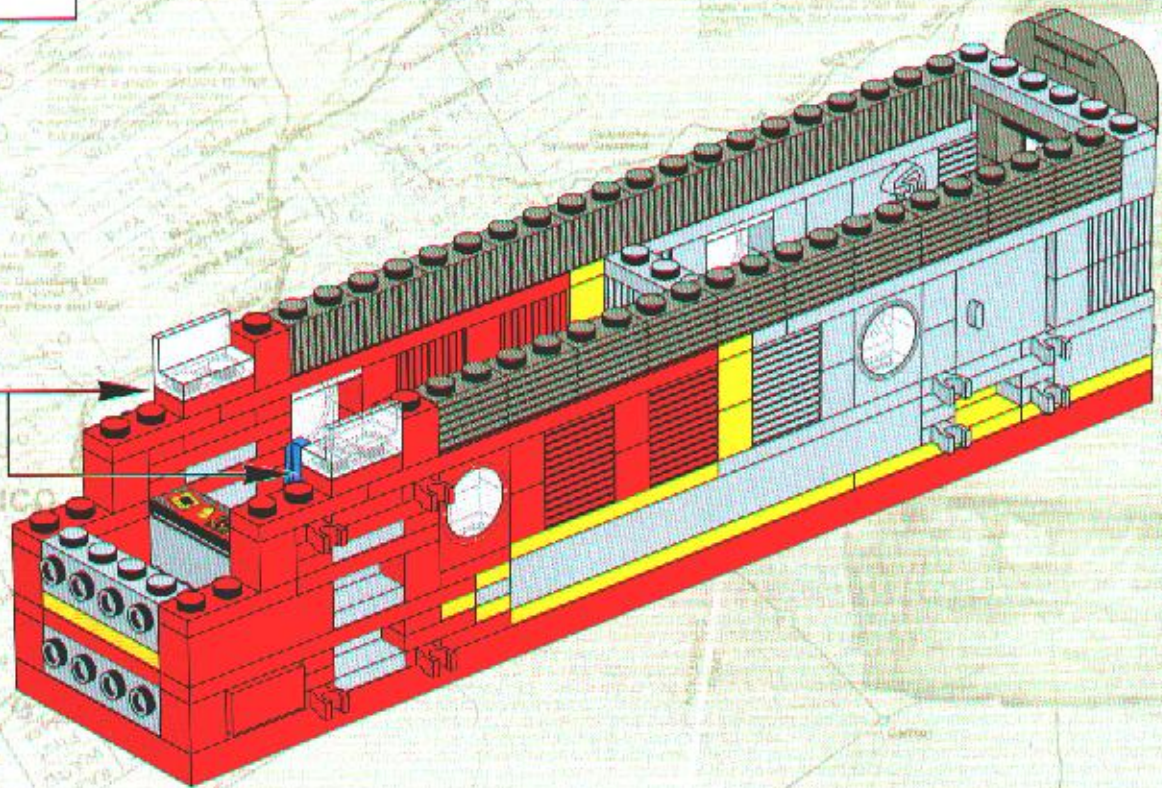
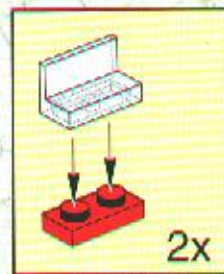

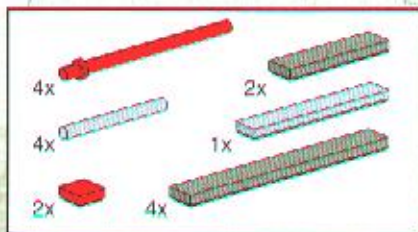

14

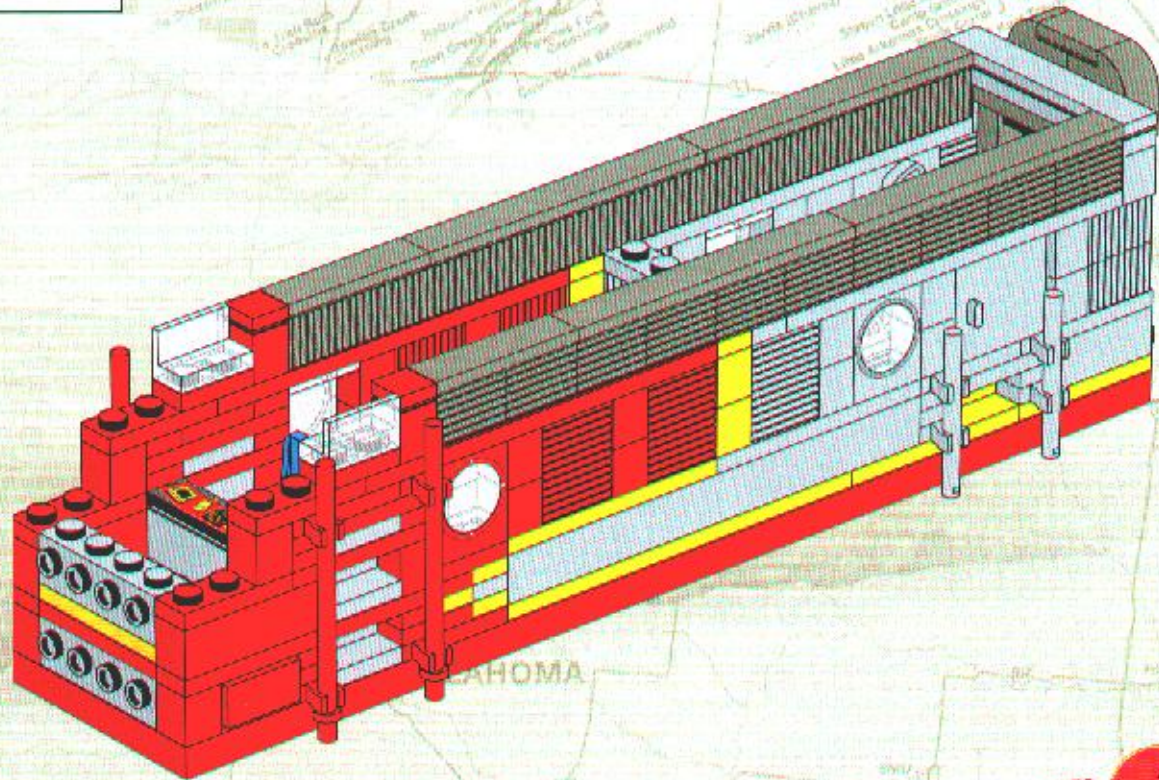

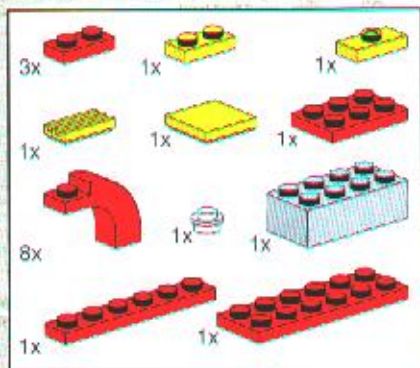

15

1

NEW

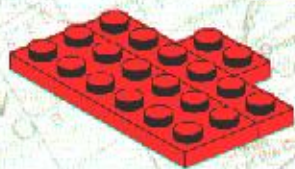

2

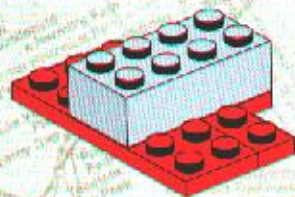

3

COLORADO



4

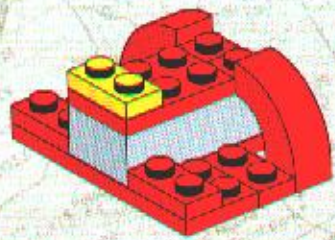

5

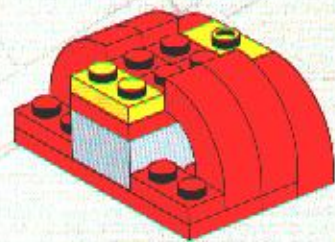

6

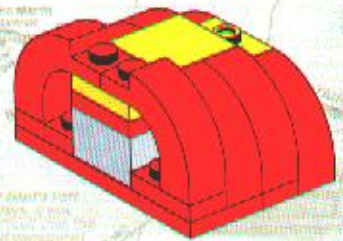

7

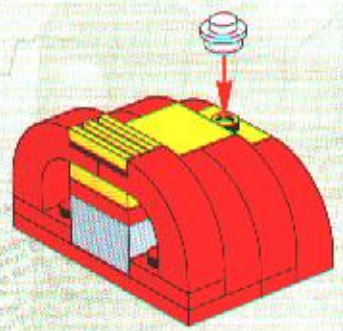

8

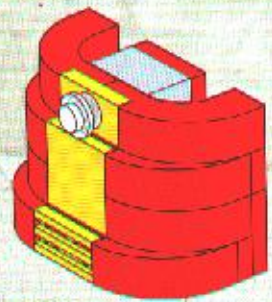

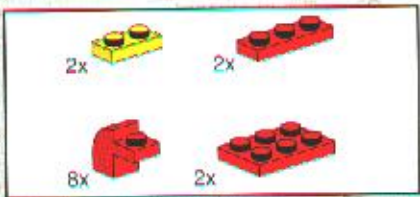

16

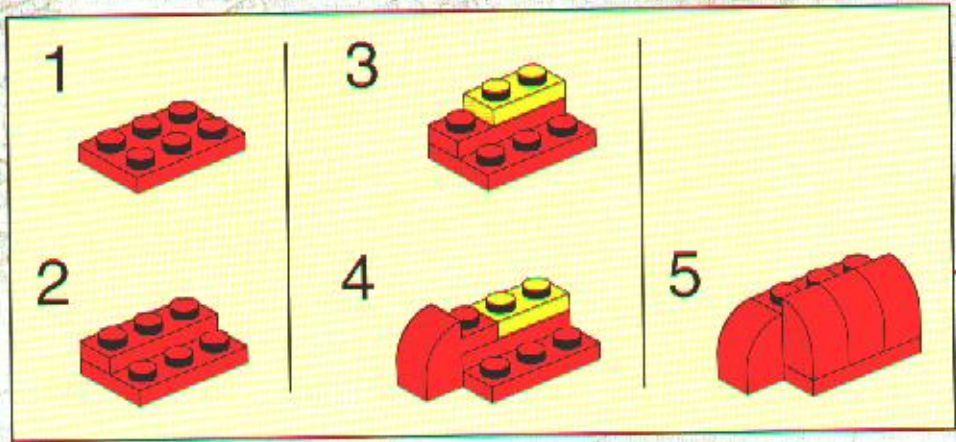
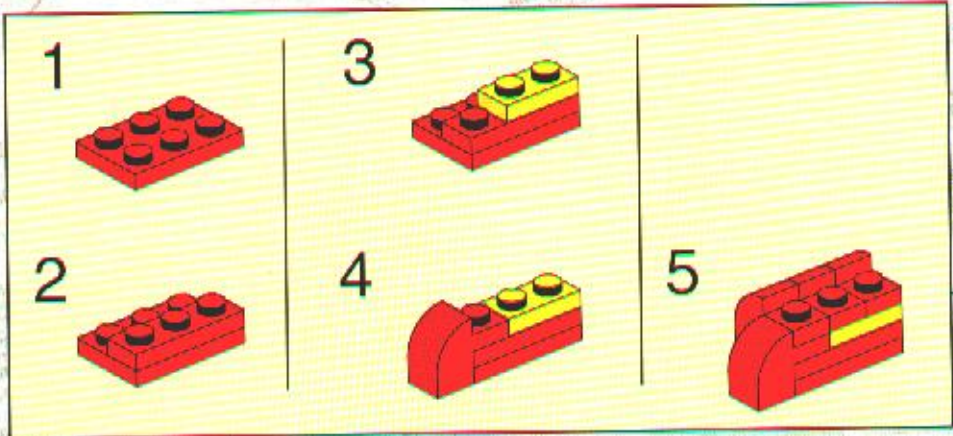

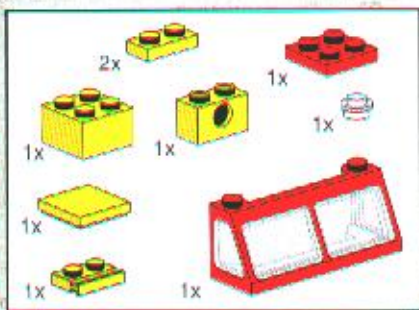

17

1



2

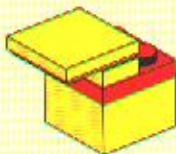

3

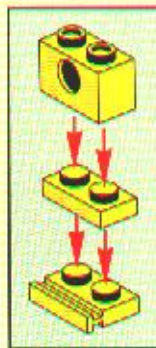

4

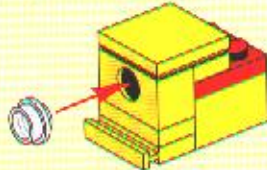

4x



1x



1x



2x



1x



18

1

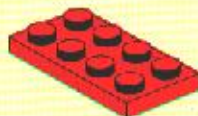

2

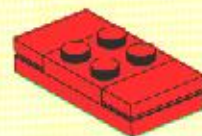

3

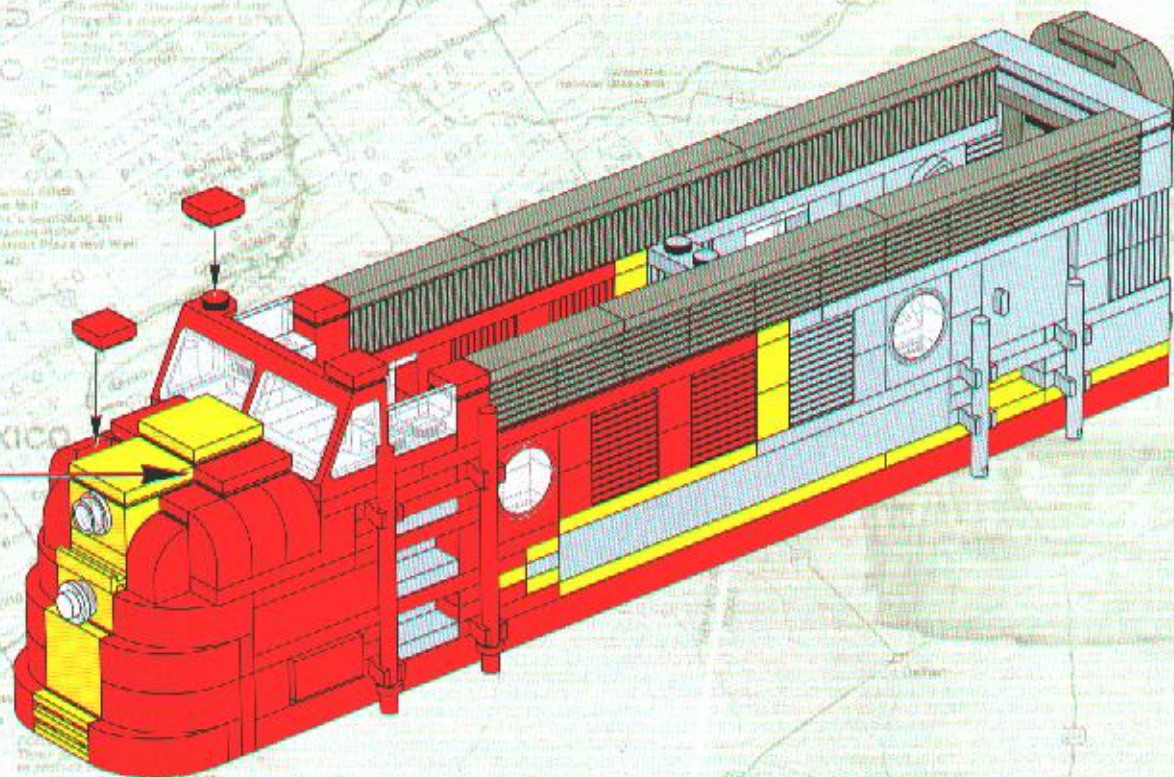
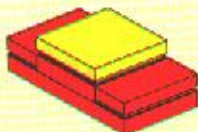

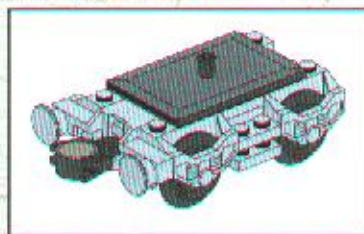
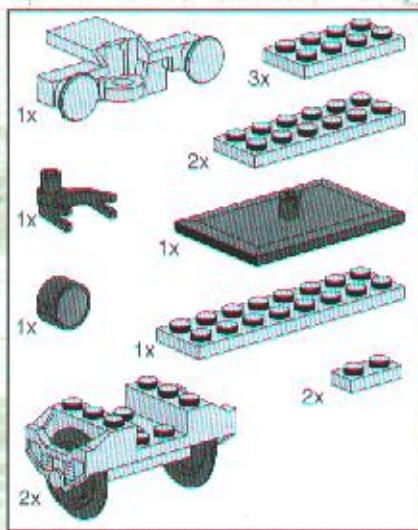

1

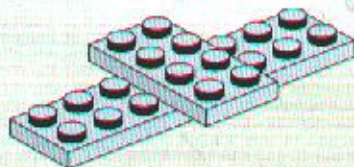

19

2

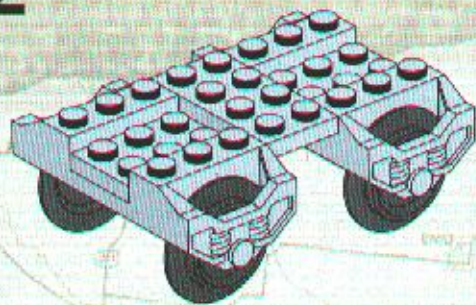

1

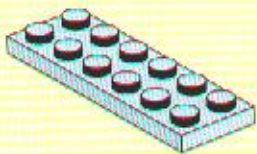

3

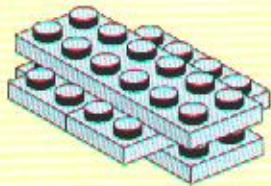

2

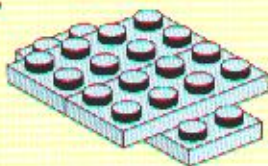

4

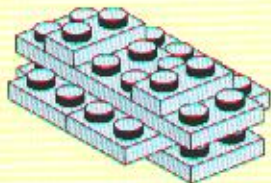

4

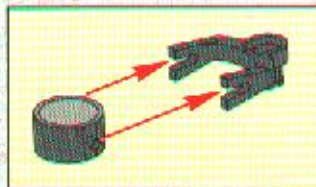
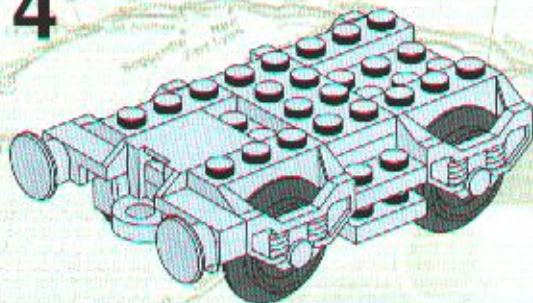

3

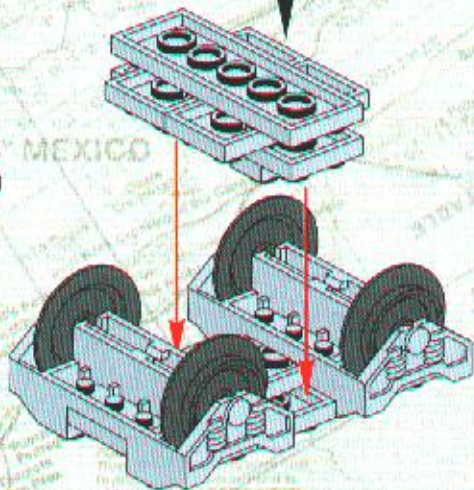

5

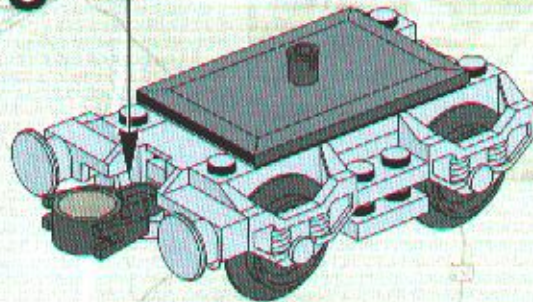

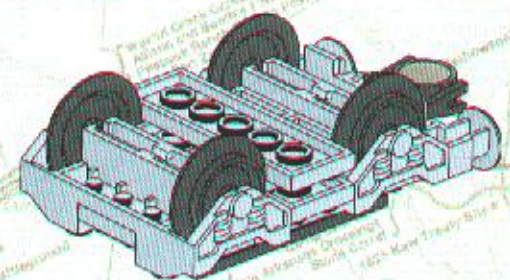
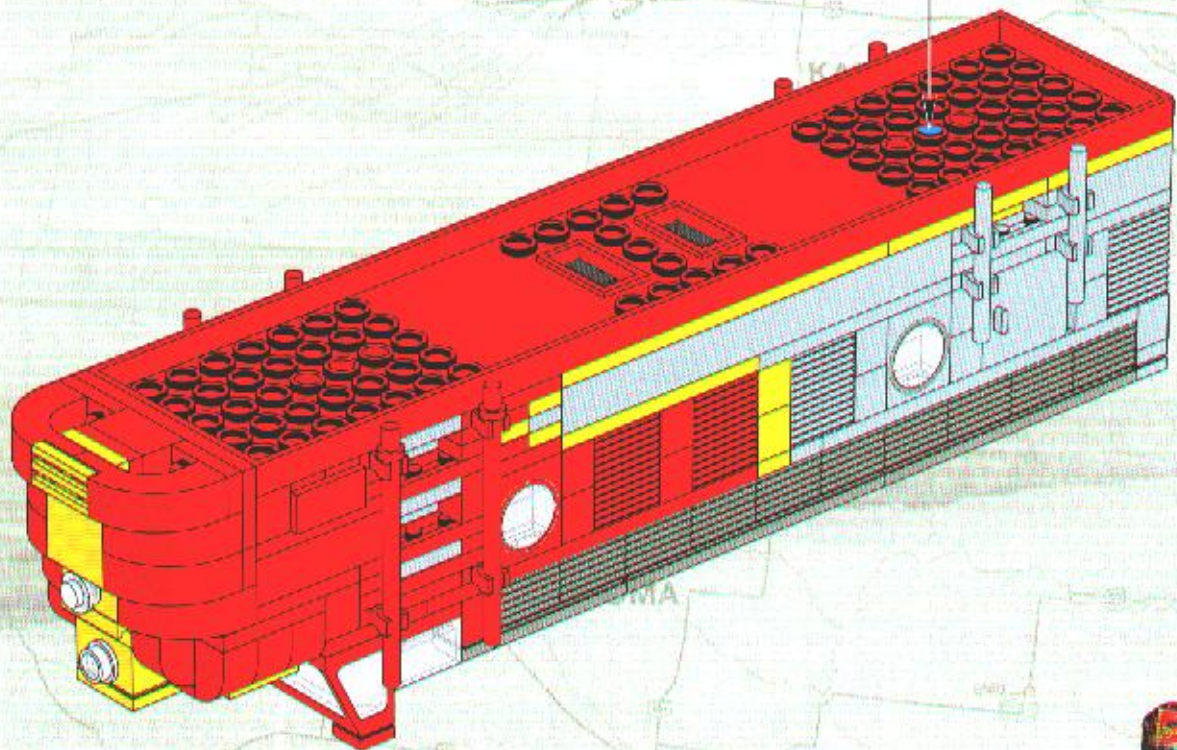

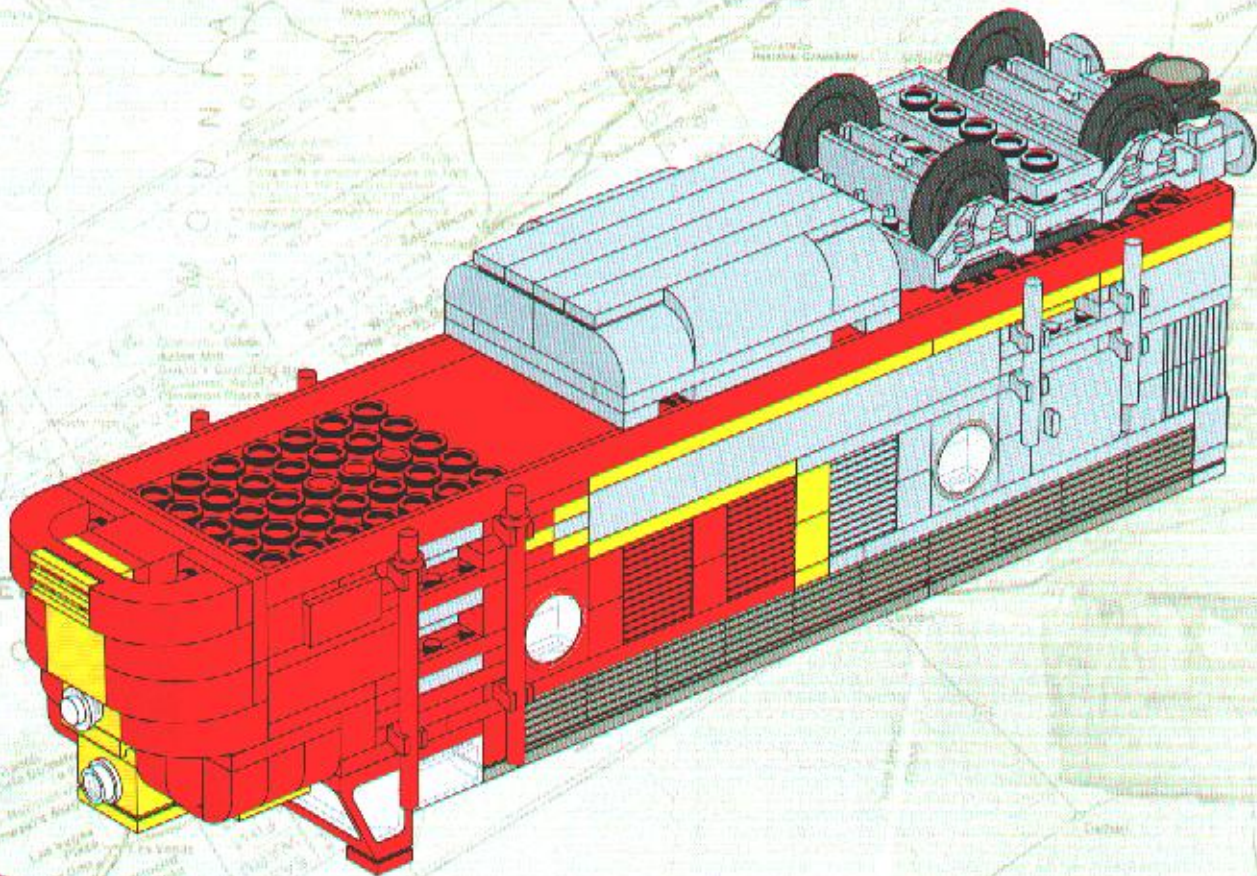

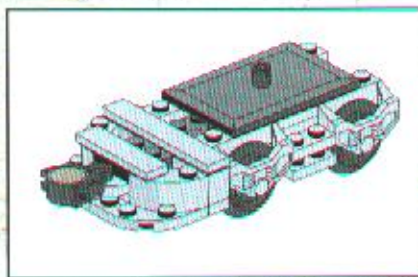
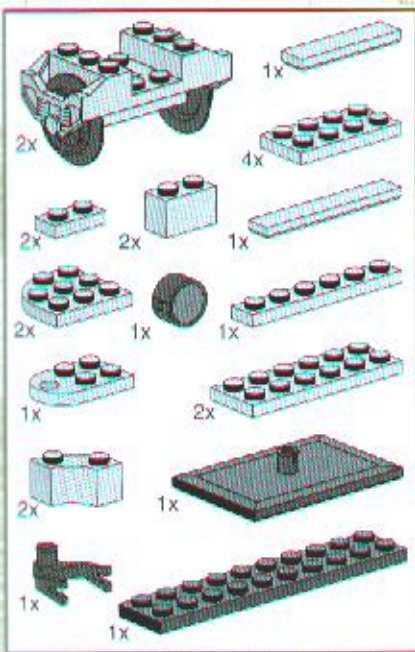

1



21

2

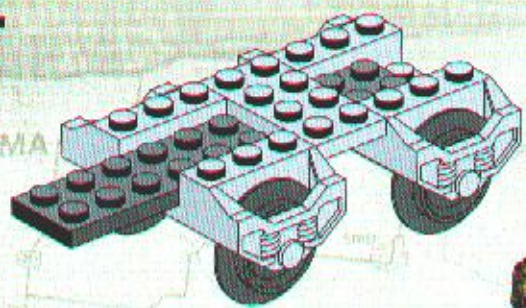

1

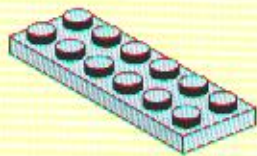

3

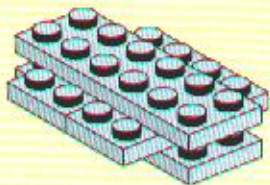

2

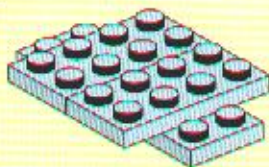

4

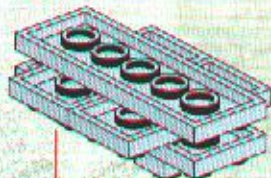
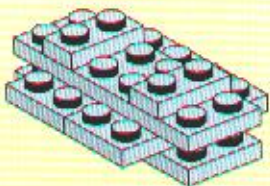

3

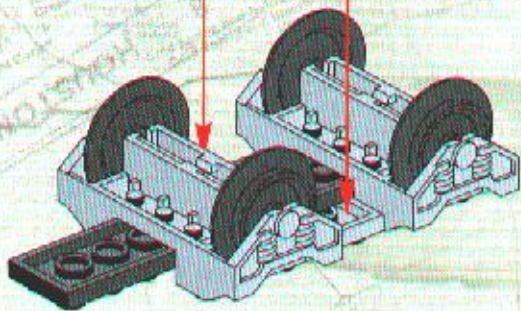

1

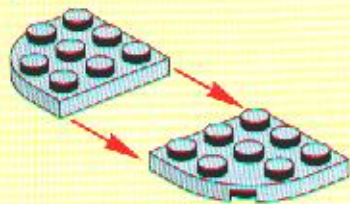

2

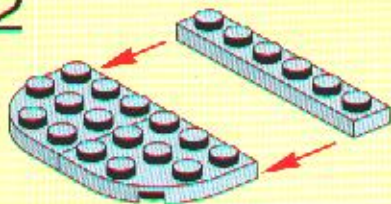

3

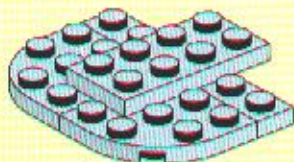

4

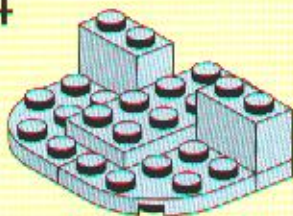

5

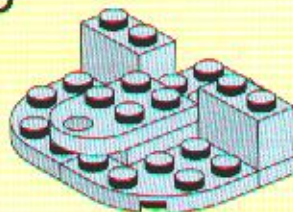

6

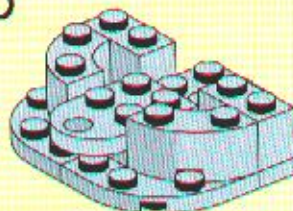

4

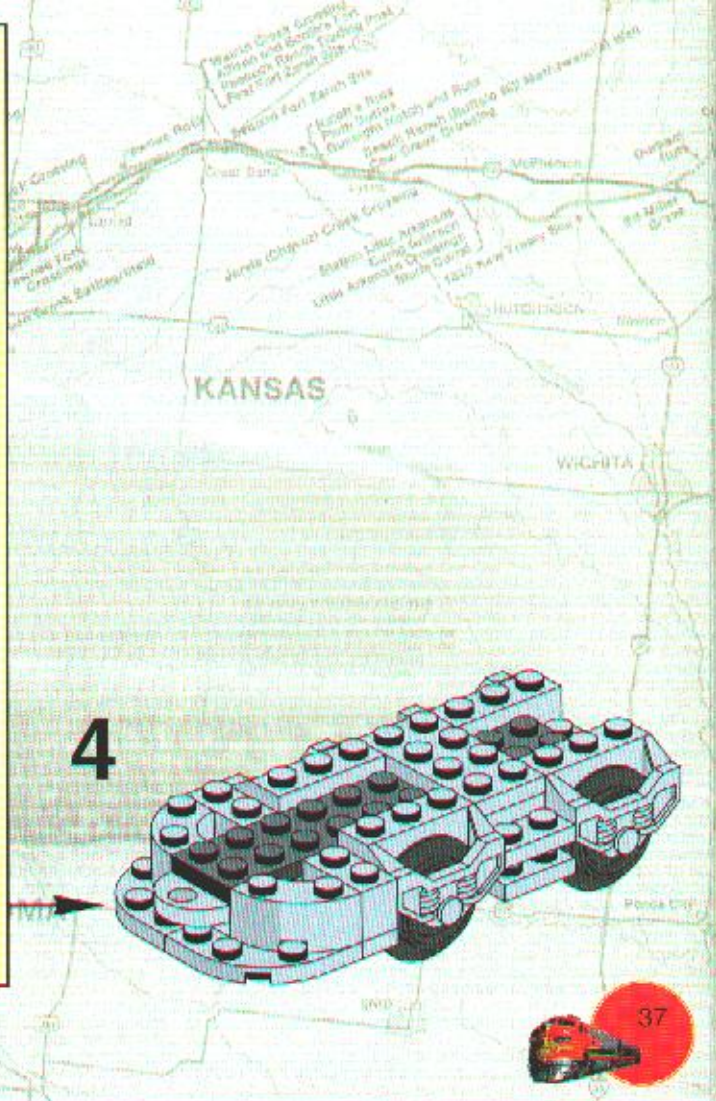
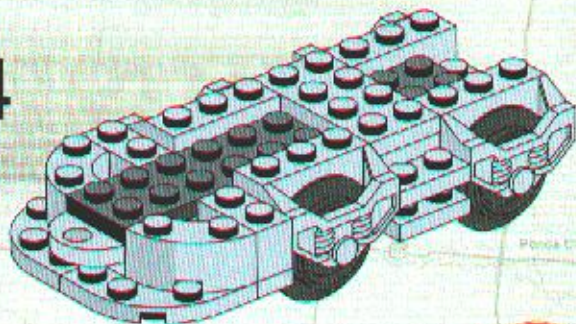

5

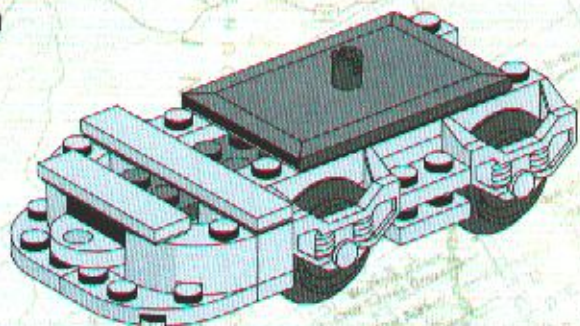

6

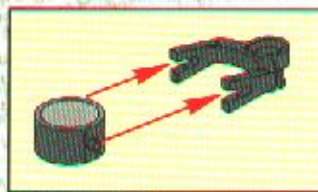
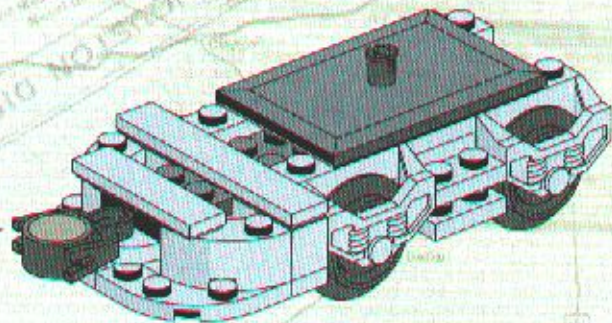

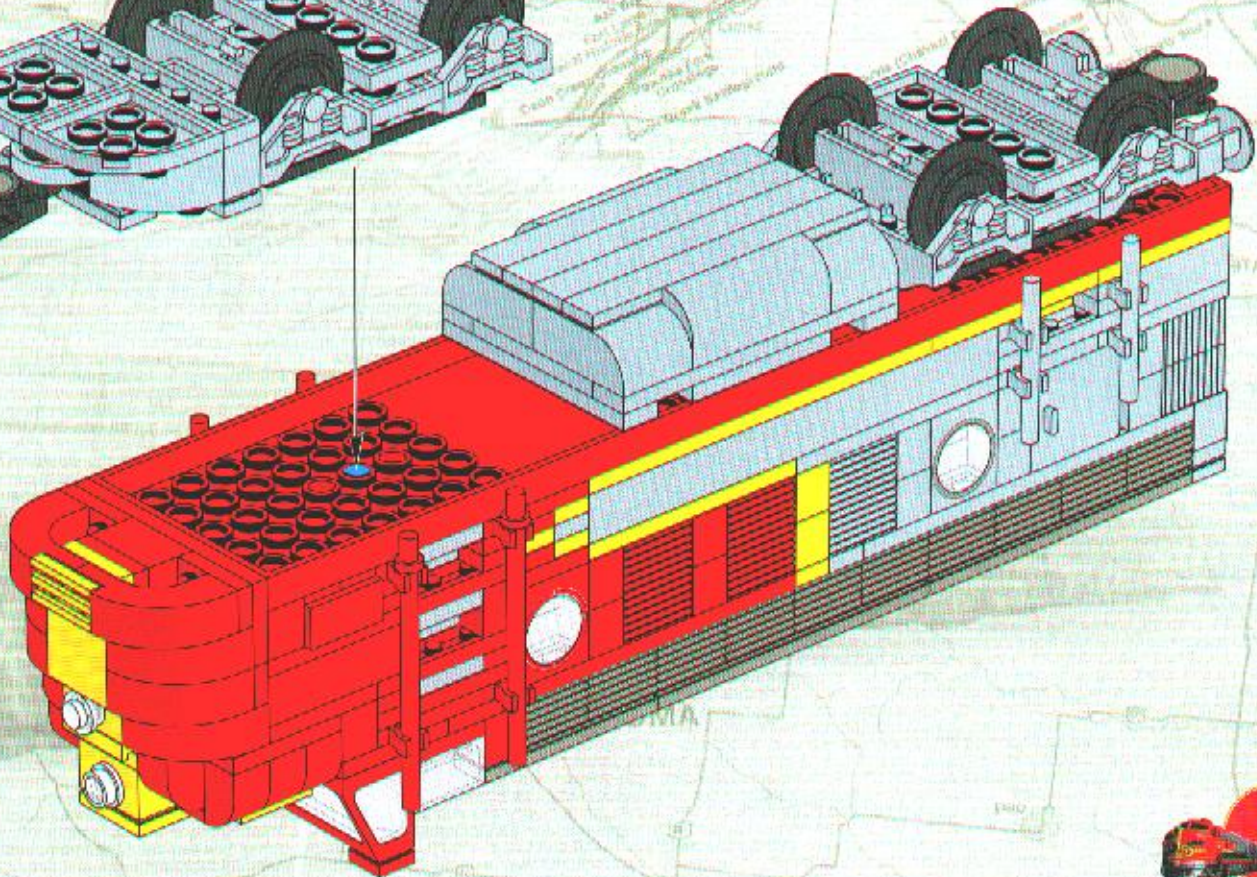
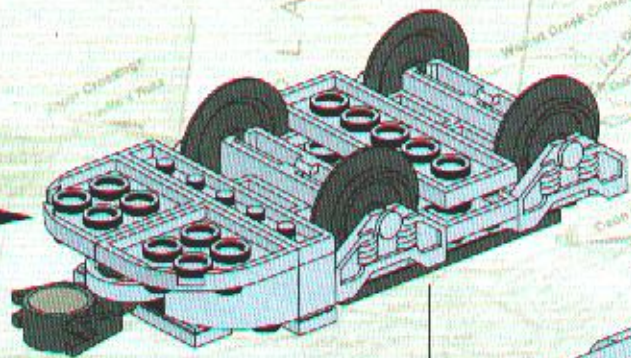

3

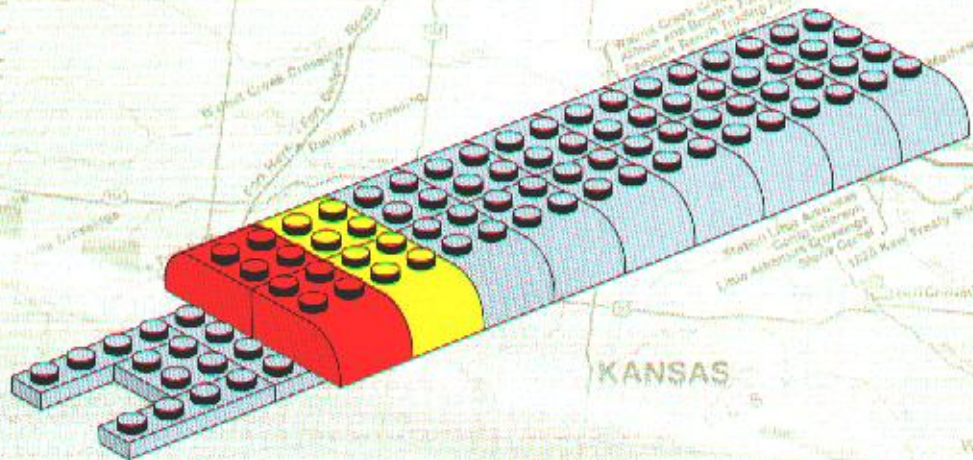

4

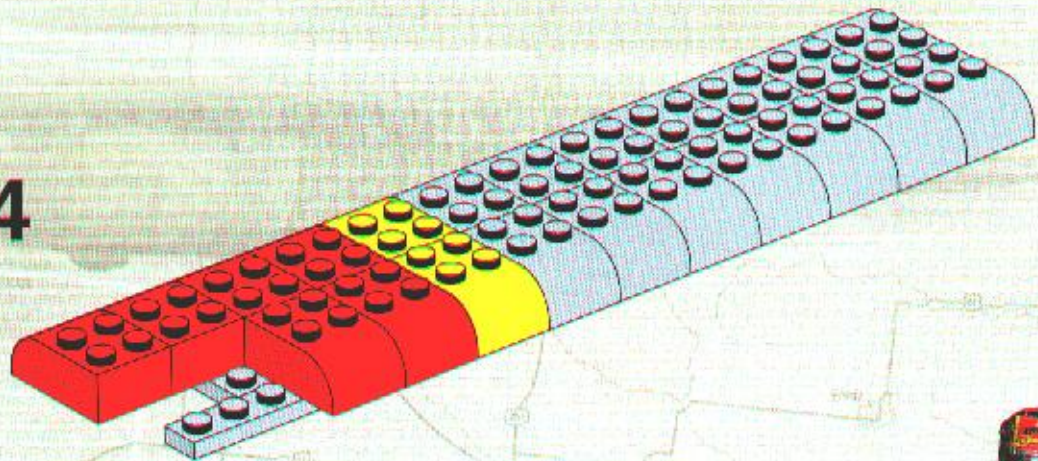

5

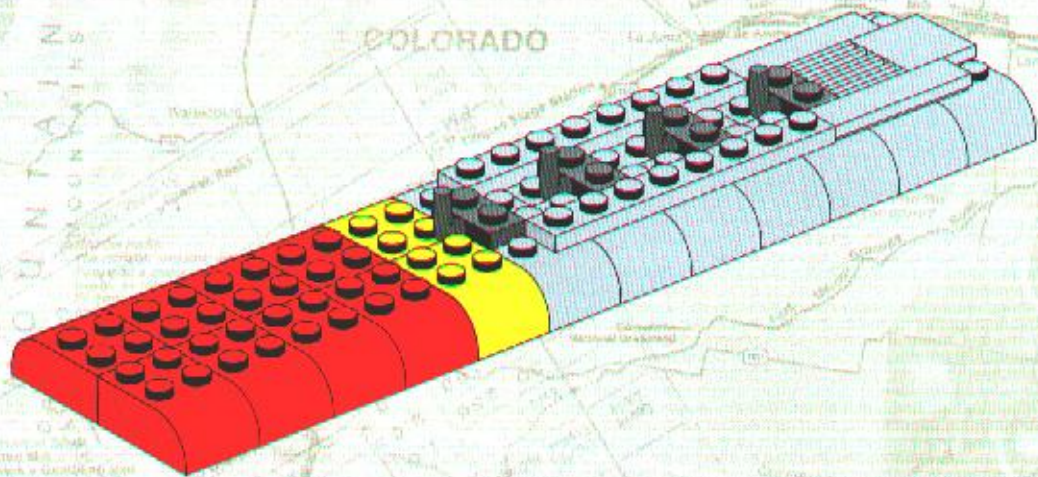

6

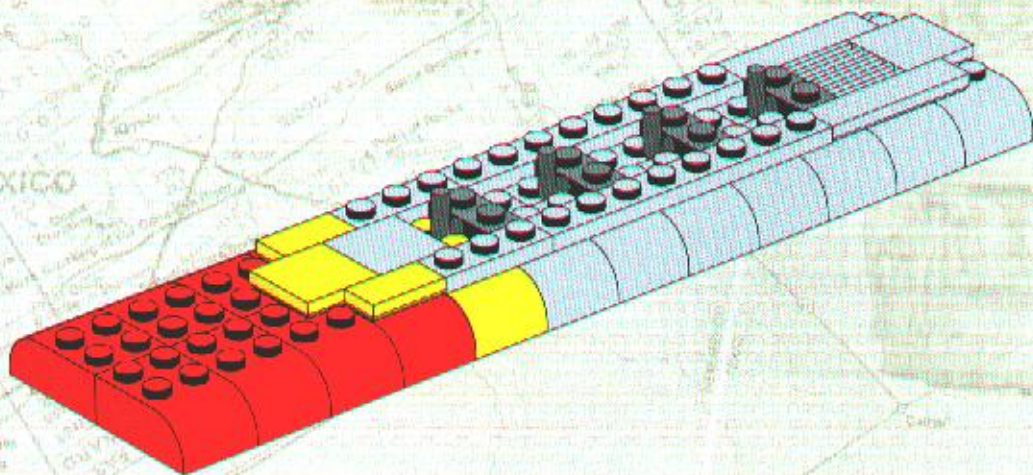

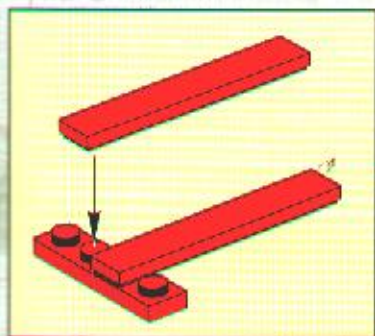

7

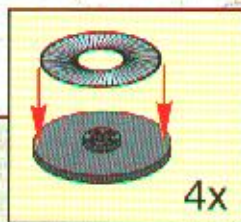
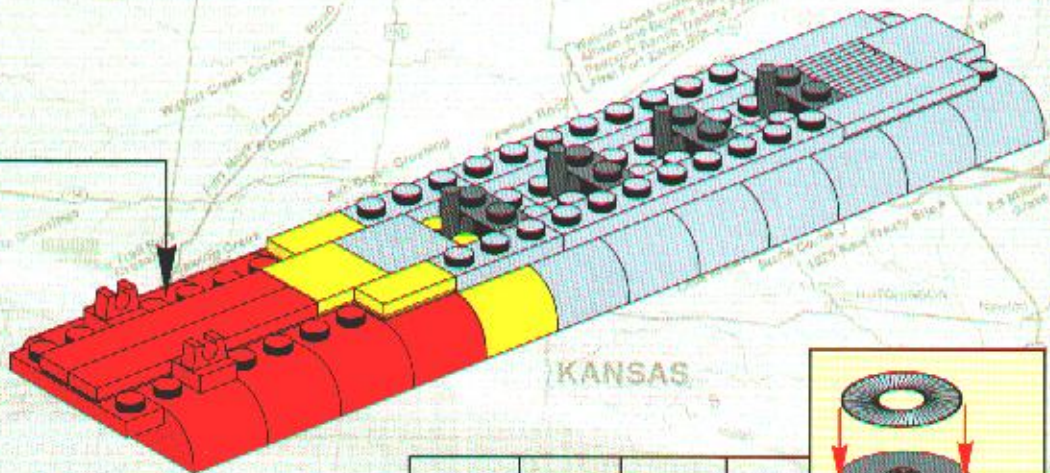

4x

8

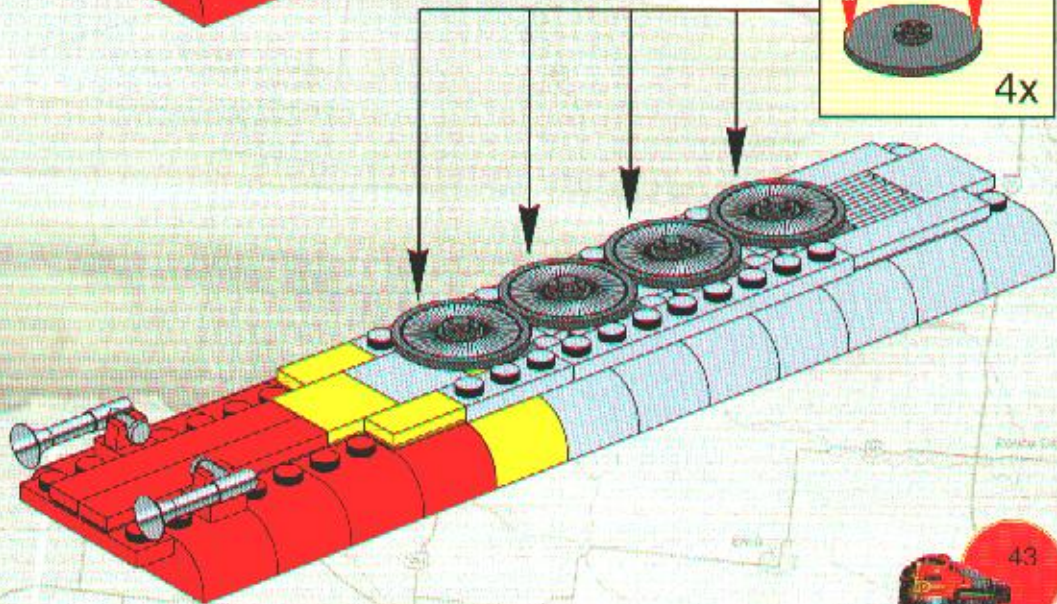

COLORADO

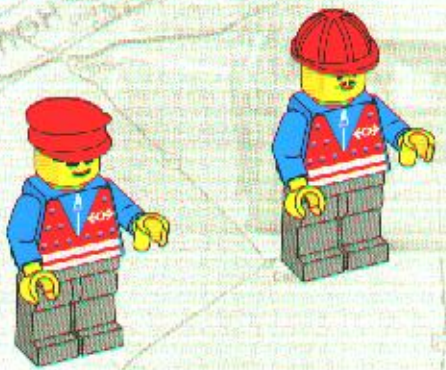
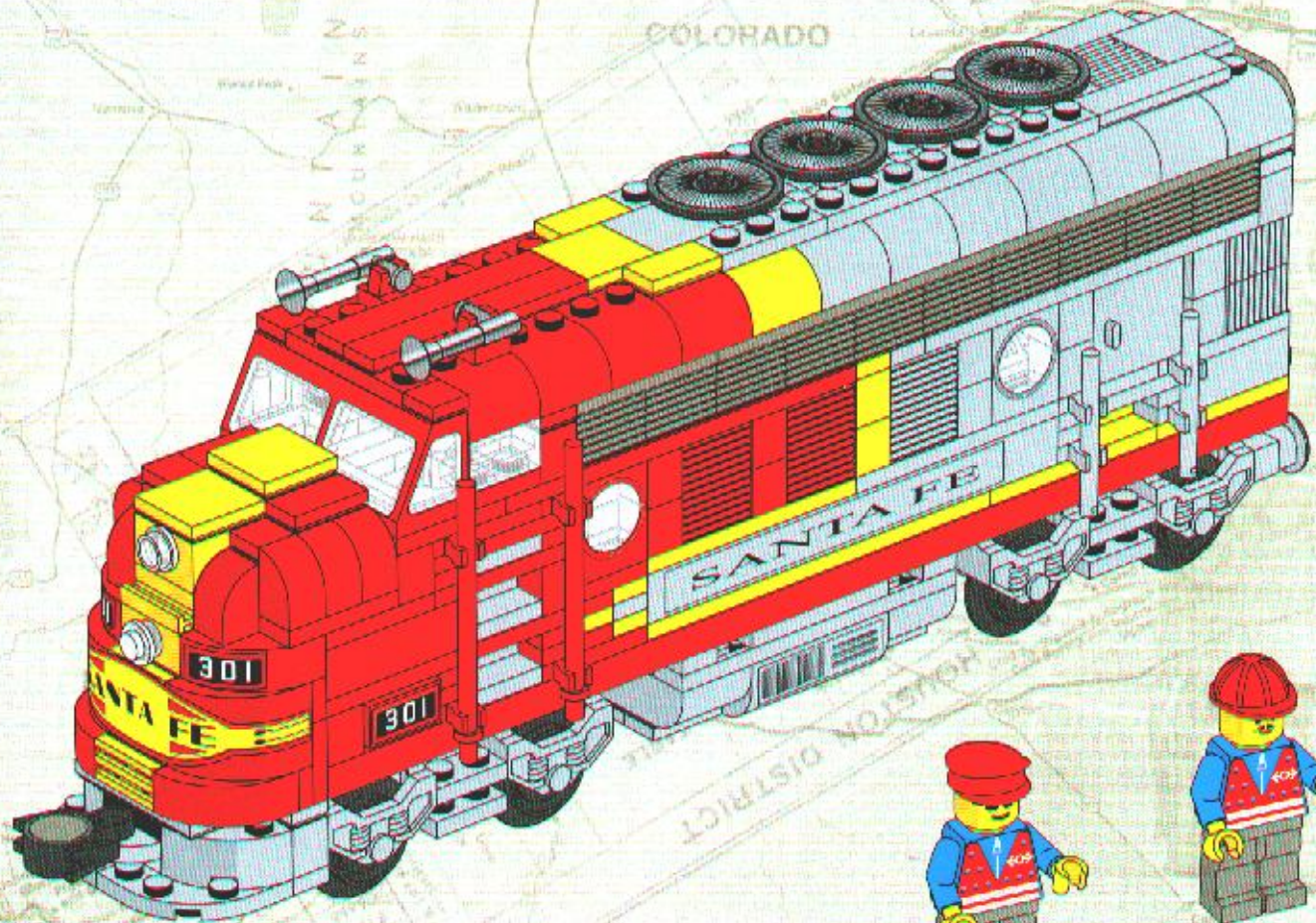

5300

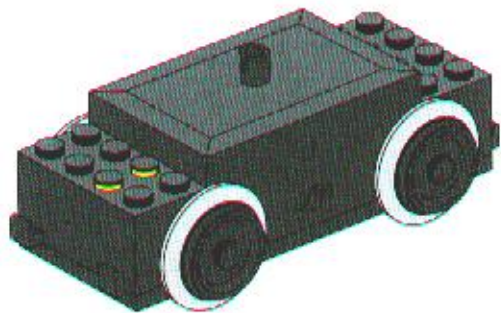

+

10020

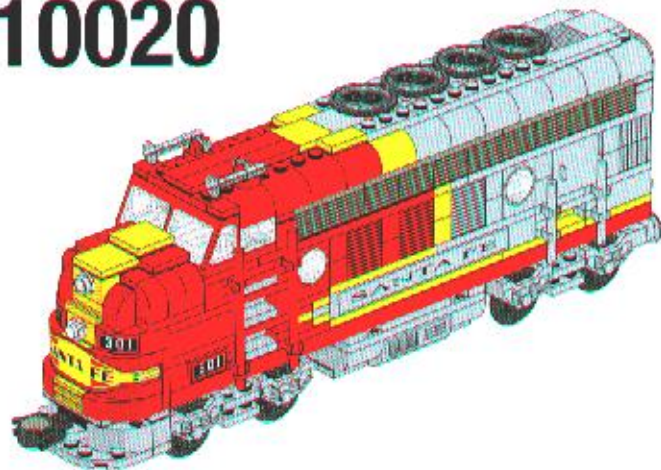

OKLAHOMA



1

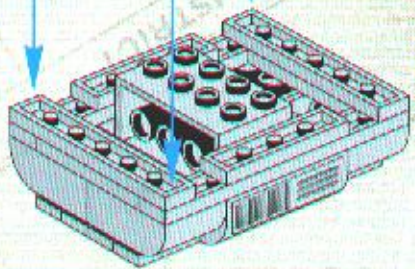
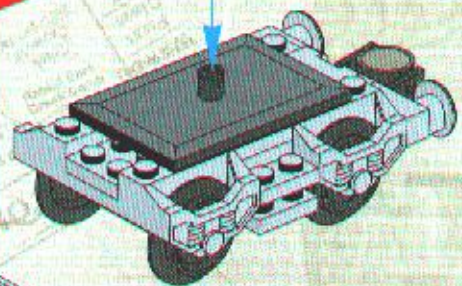
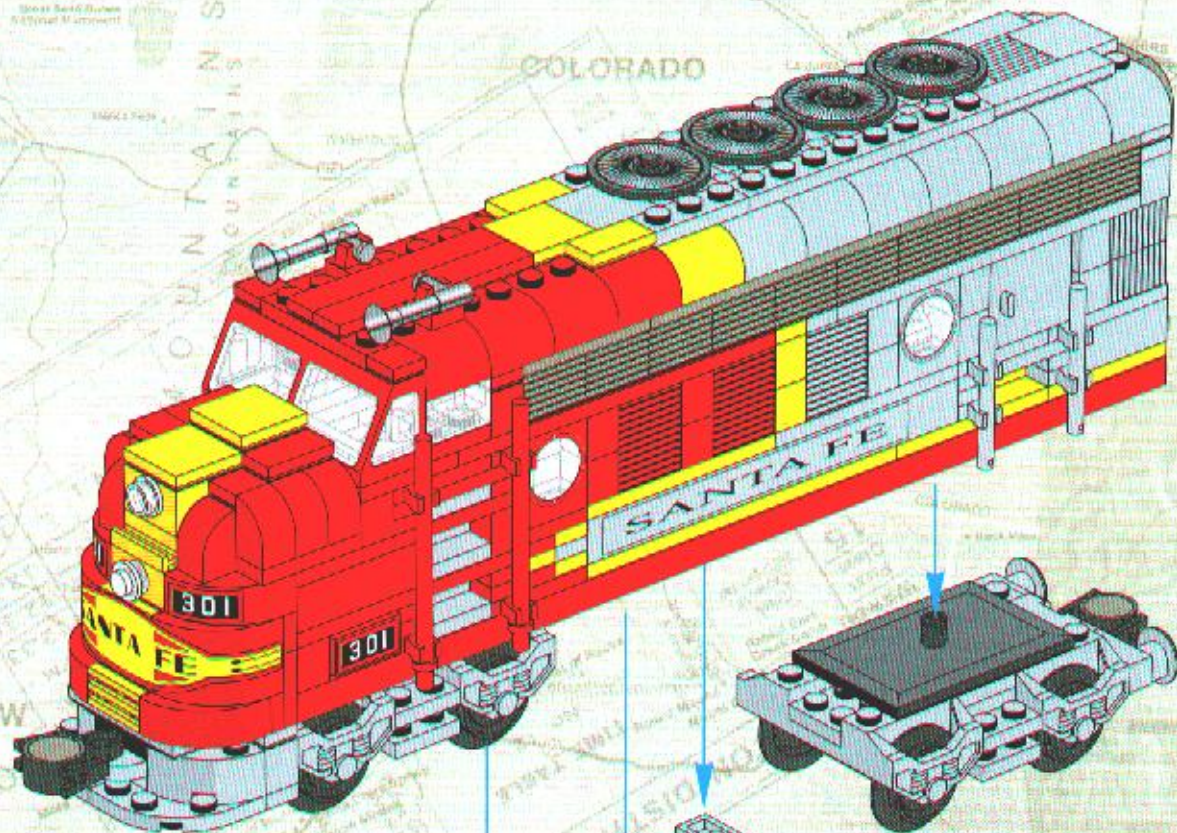

46



Small text and icons at the bottom left corner, including a small locomotive icon and some illegible text.

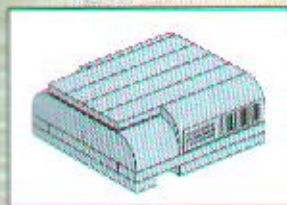
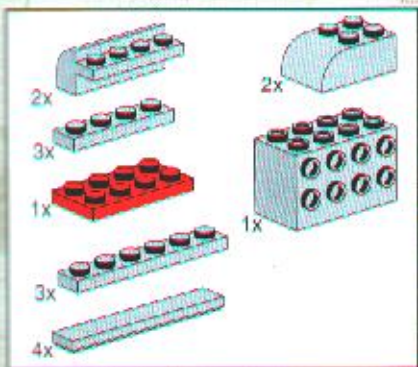

1

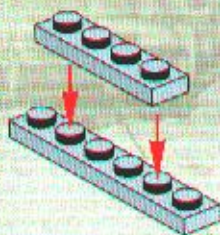

2

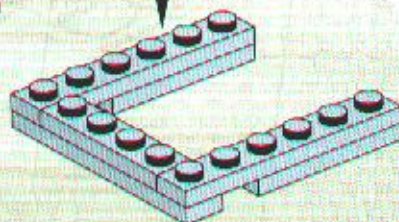

3

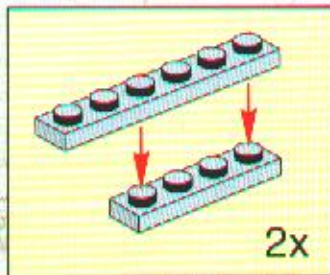
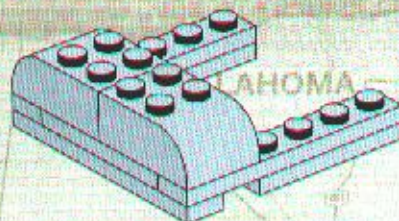

4

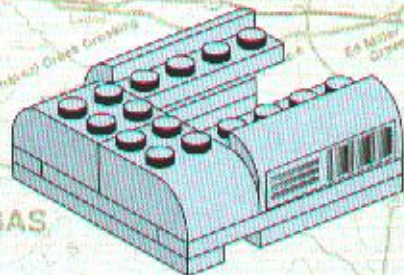

5

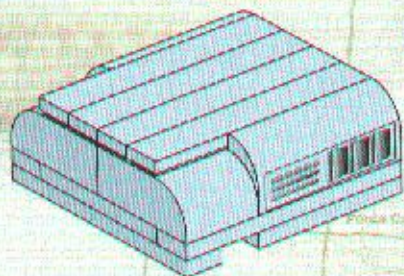

2

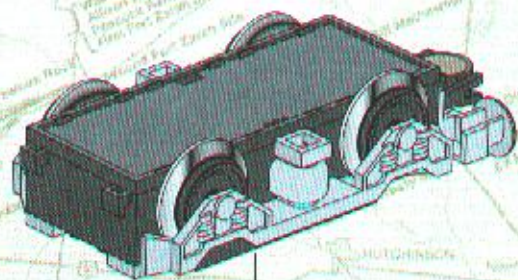
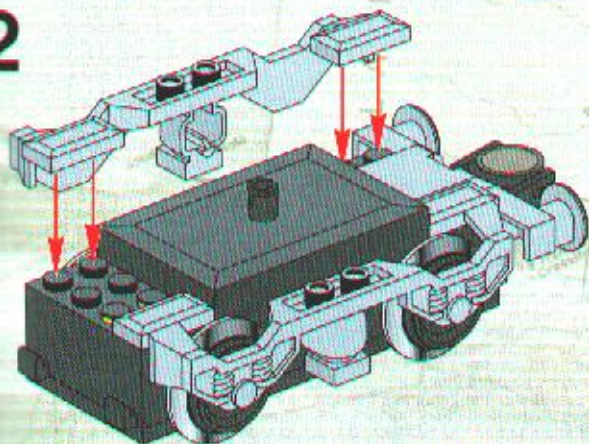

2

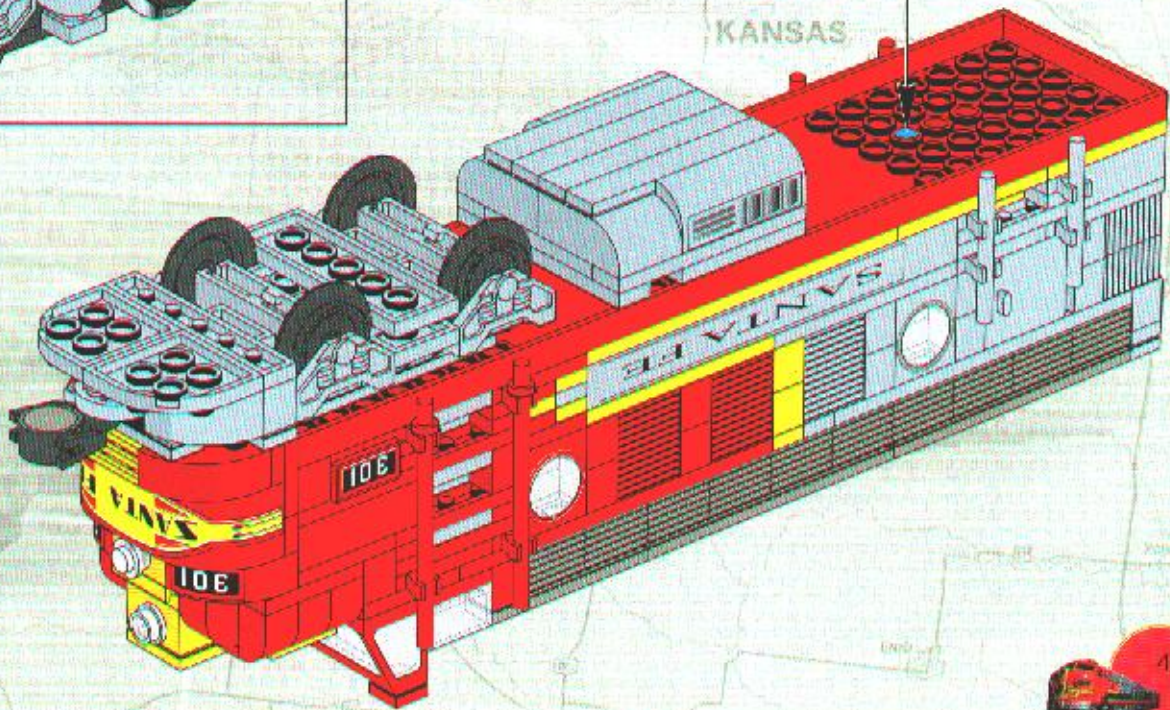

3

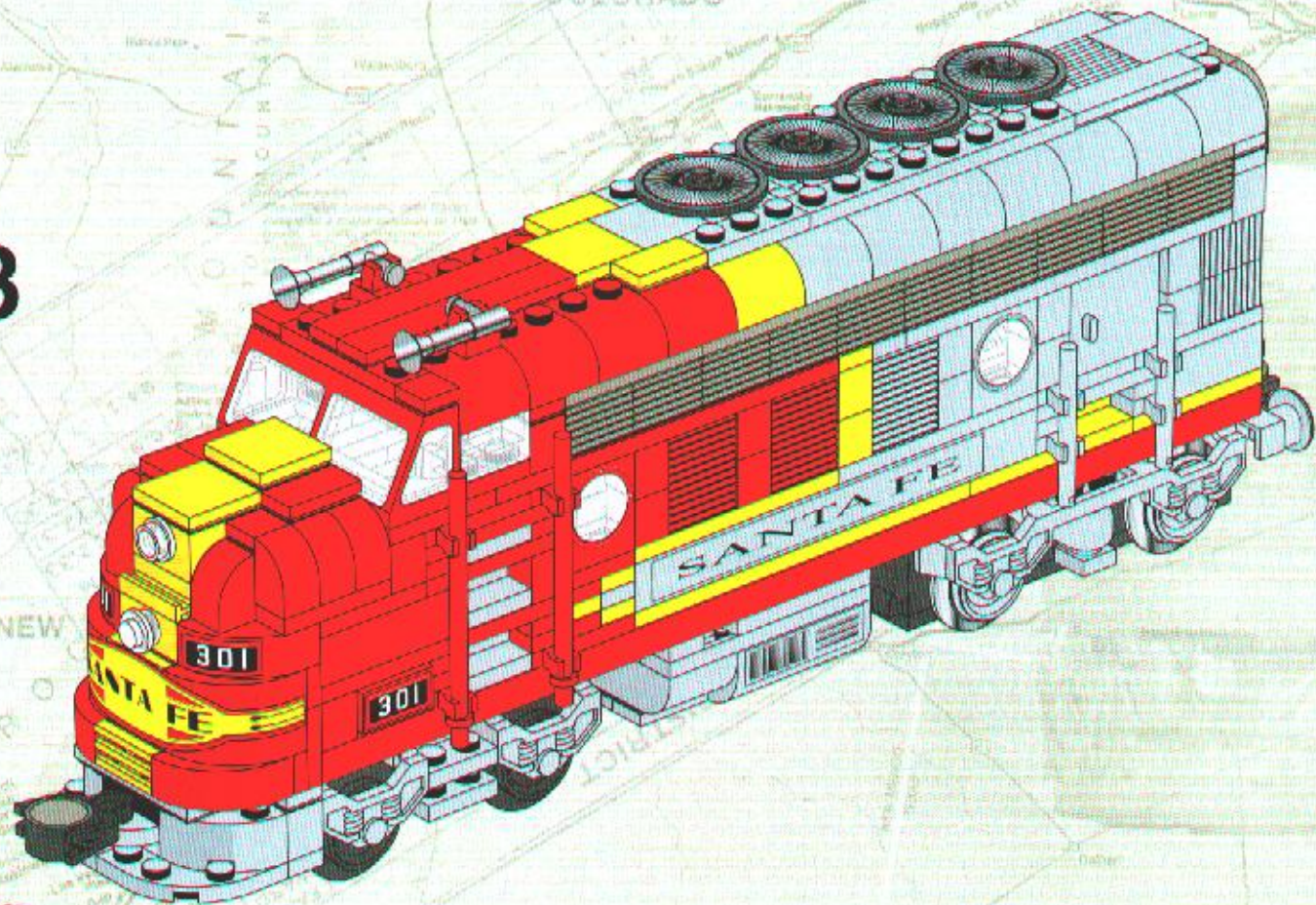

5300

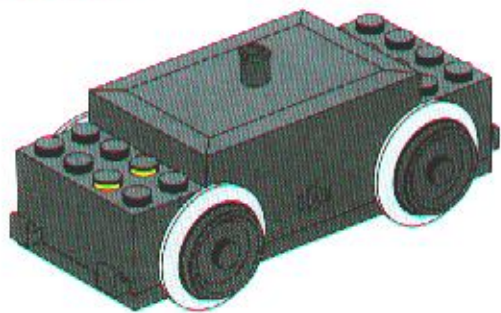

+

10020

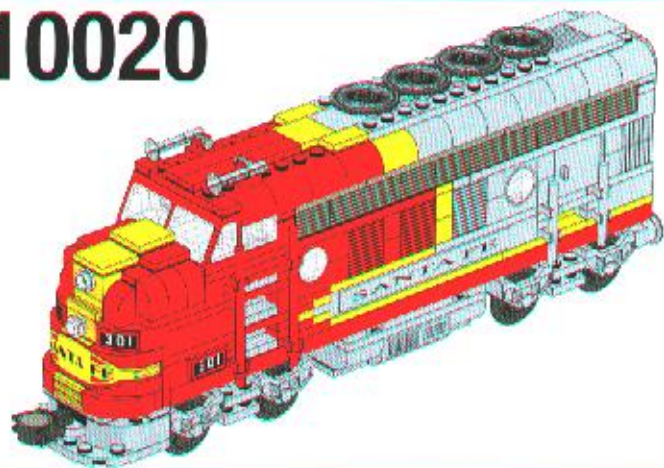

+

3748

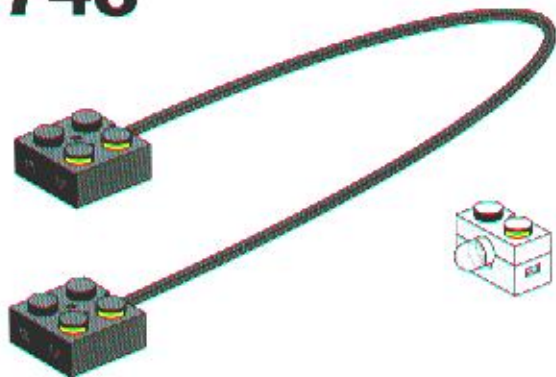

OKLAHOMA



2

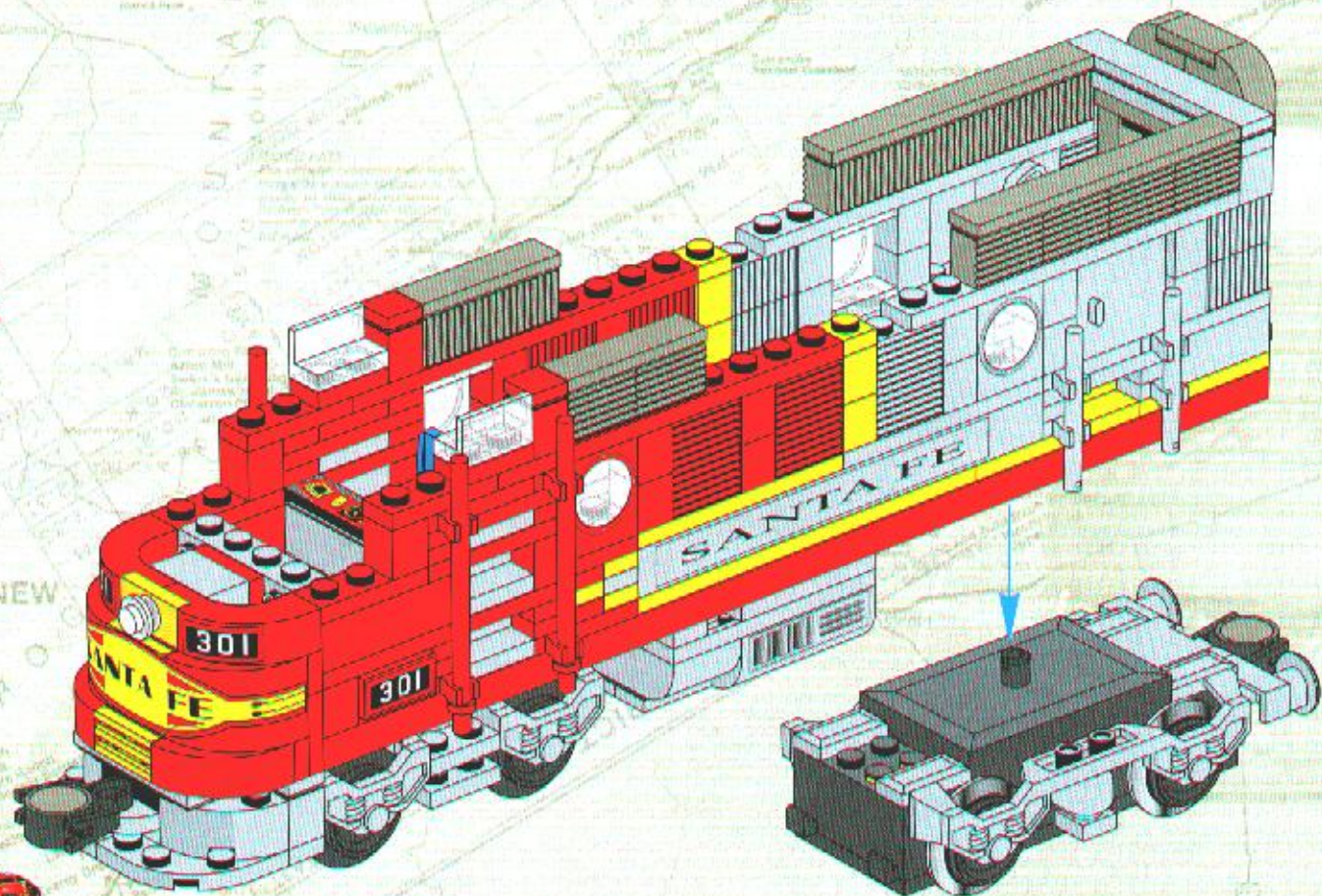

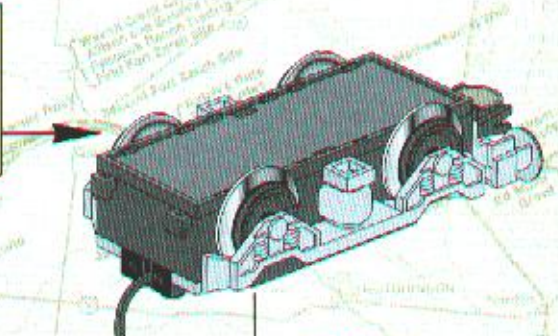
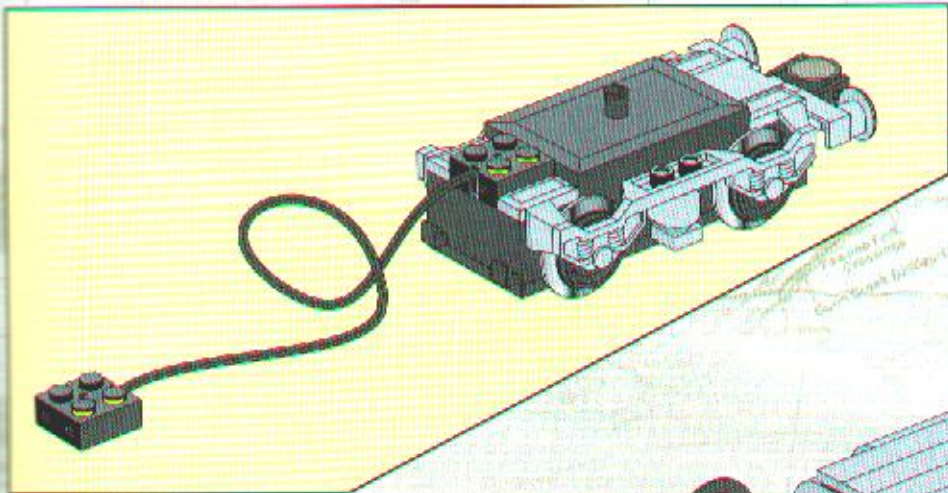

3

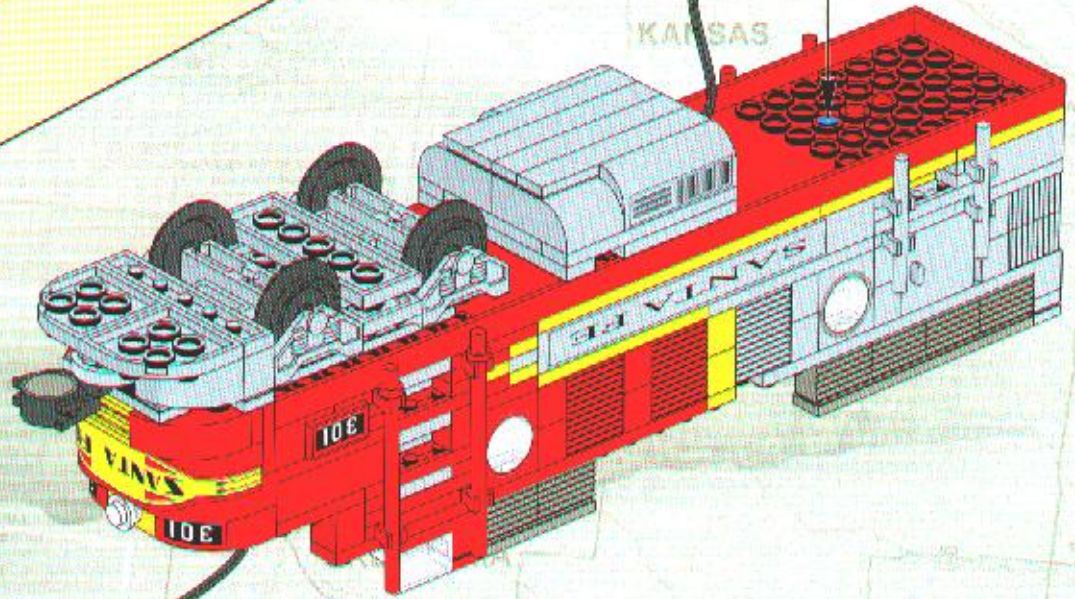

4

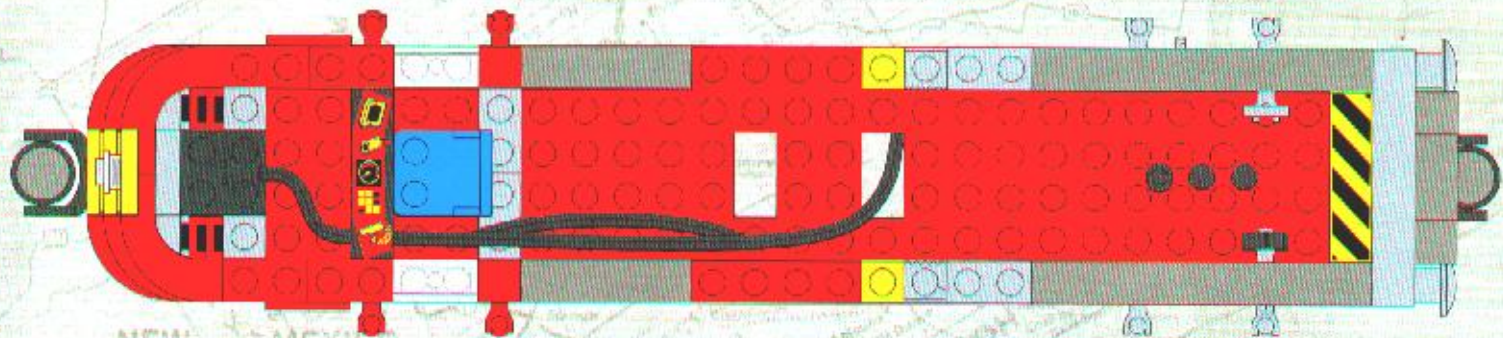

56



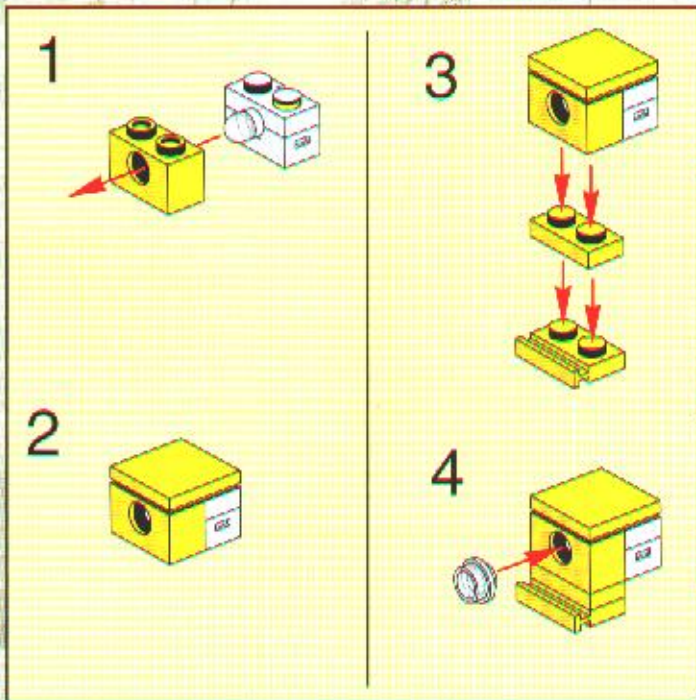
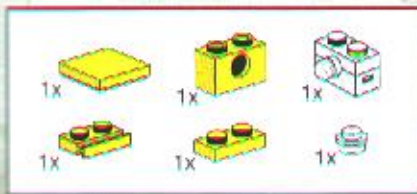

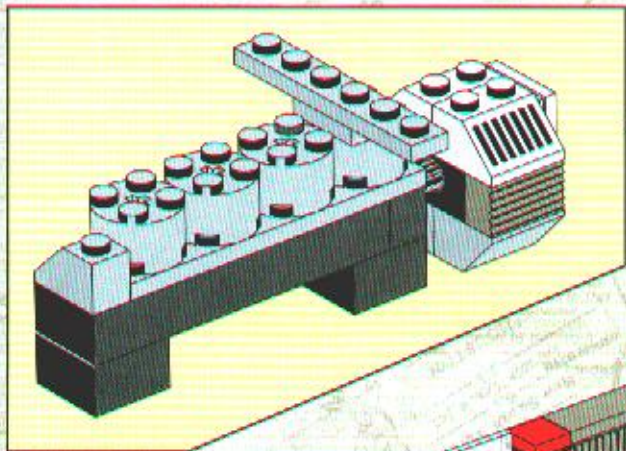

5

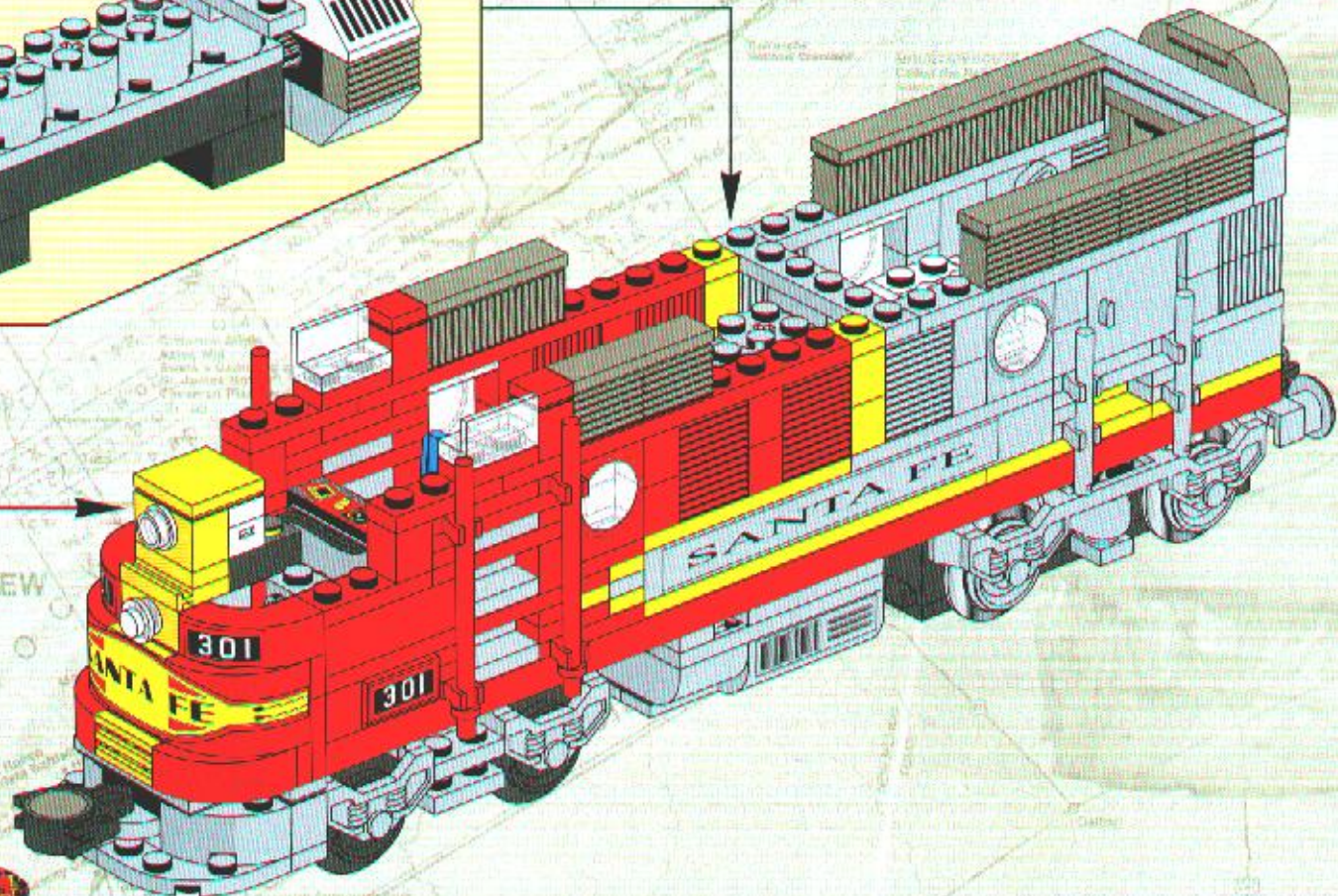

NEW



Always use the correct pins and connectors for the correct function. Always use the correct pins and connectors for the correct function.

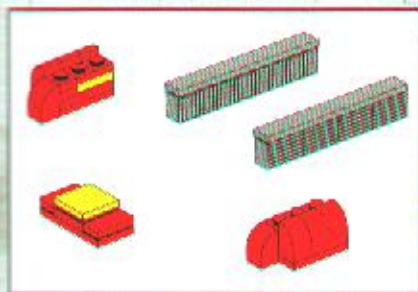

6

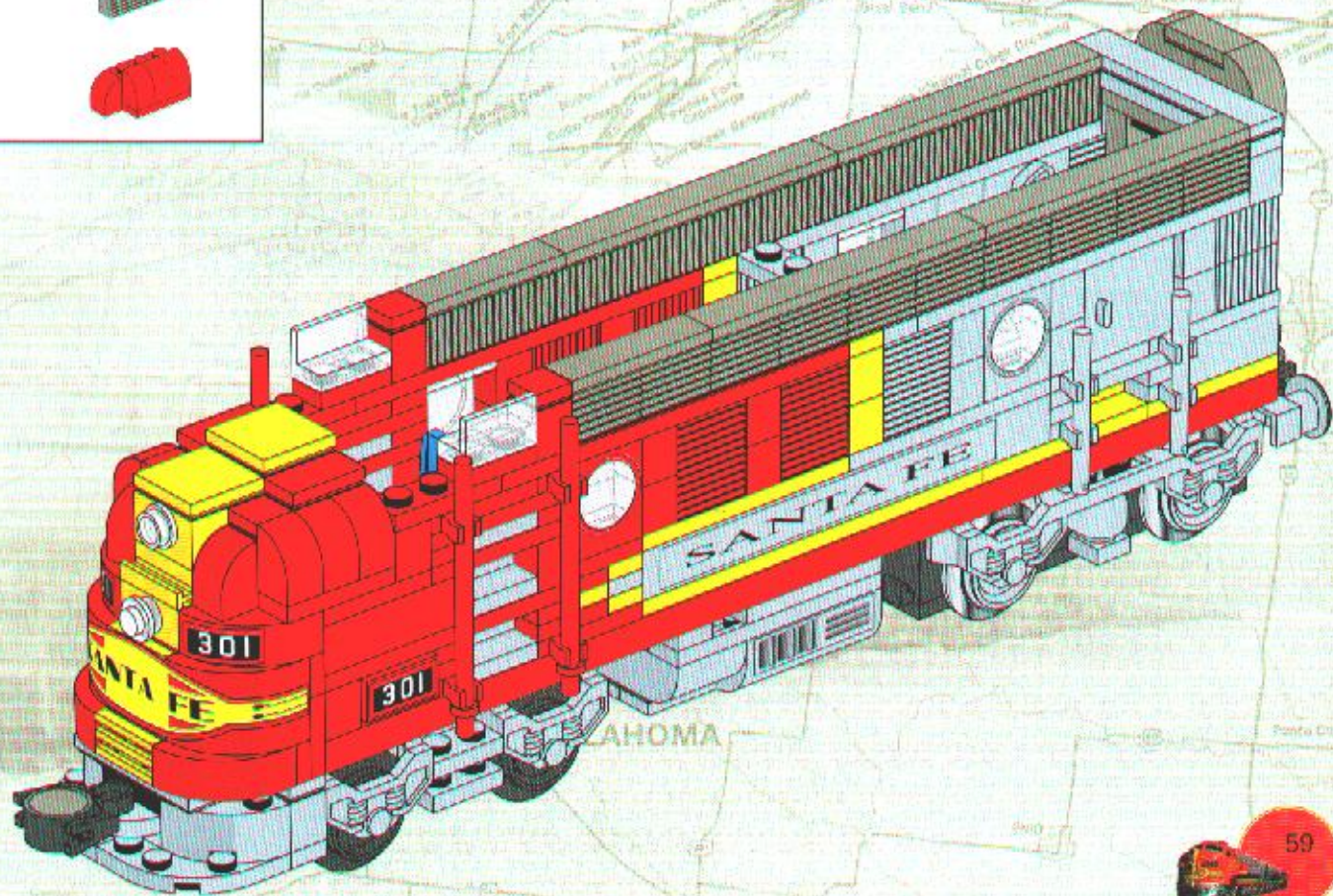

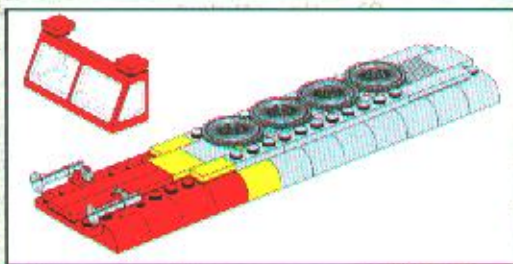

7

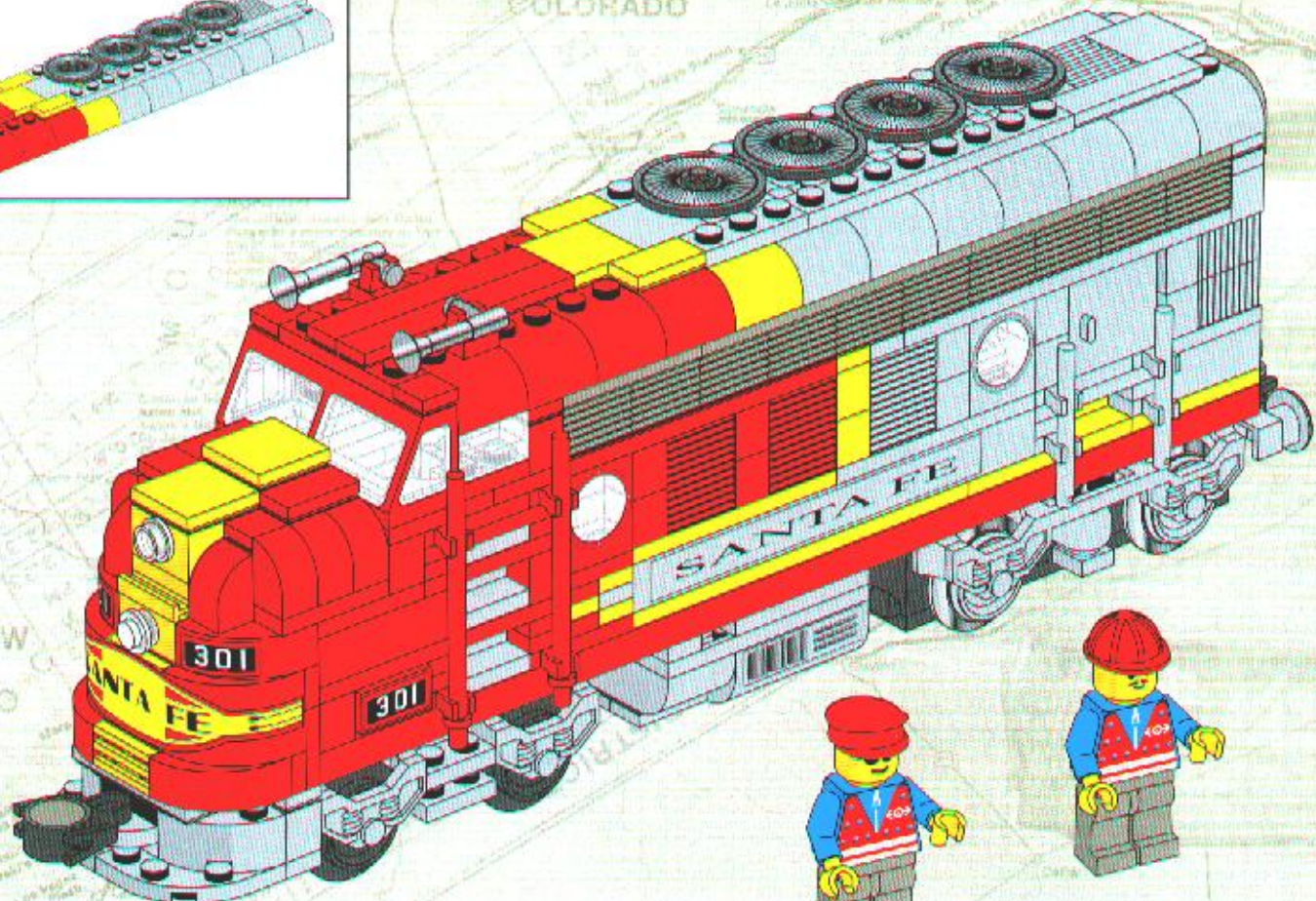

NEW

60



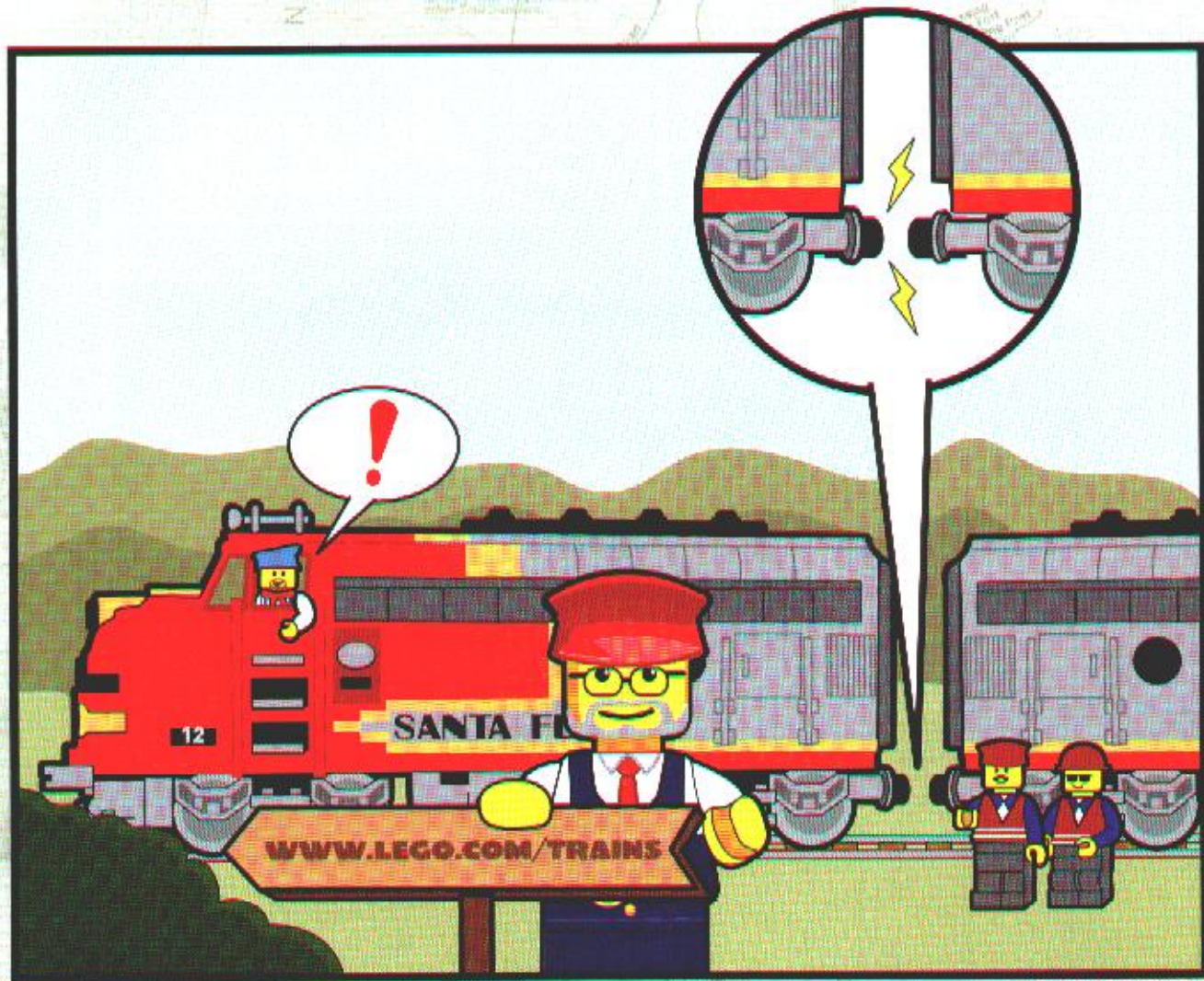

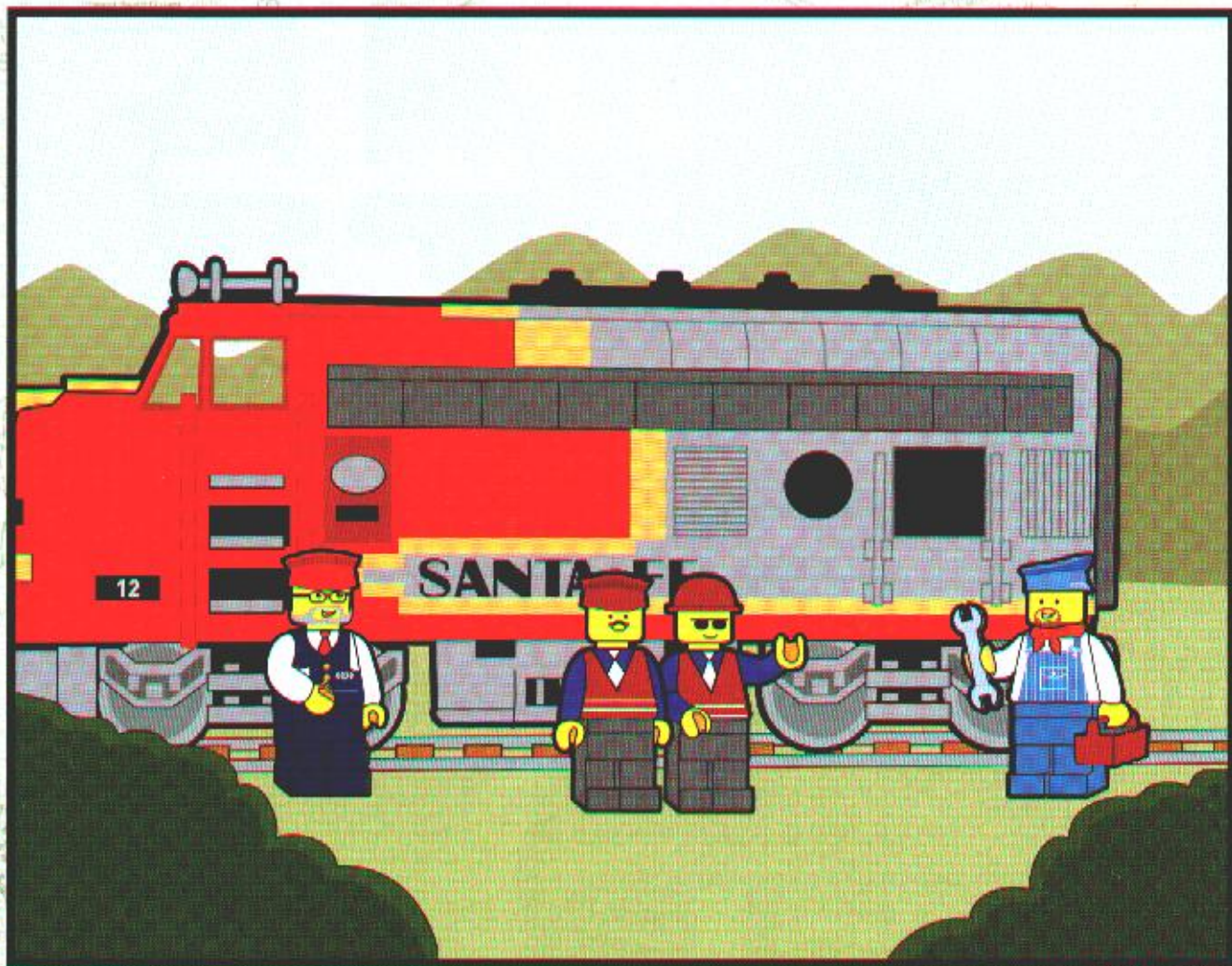

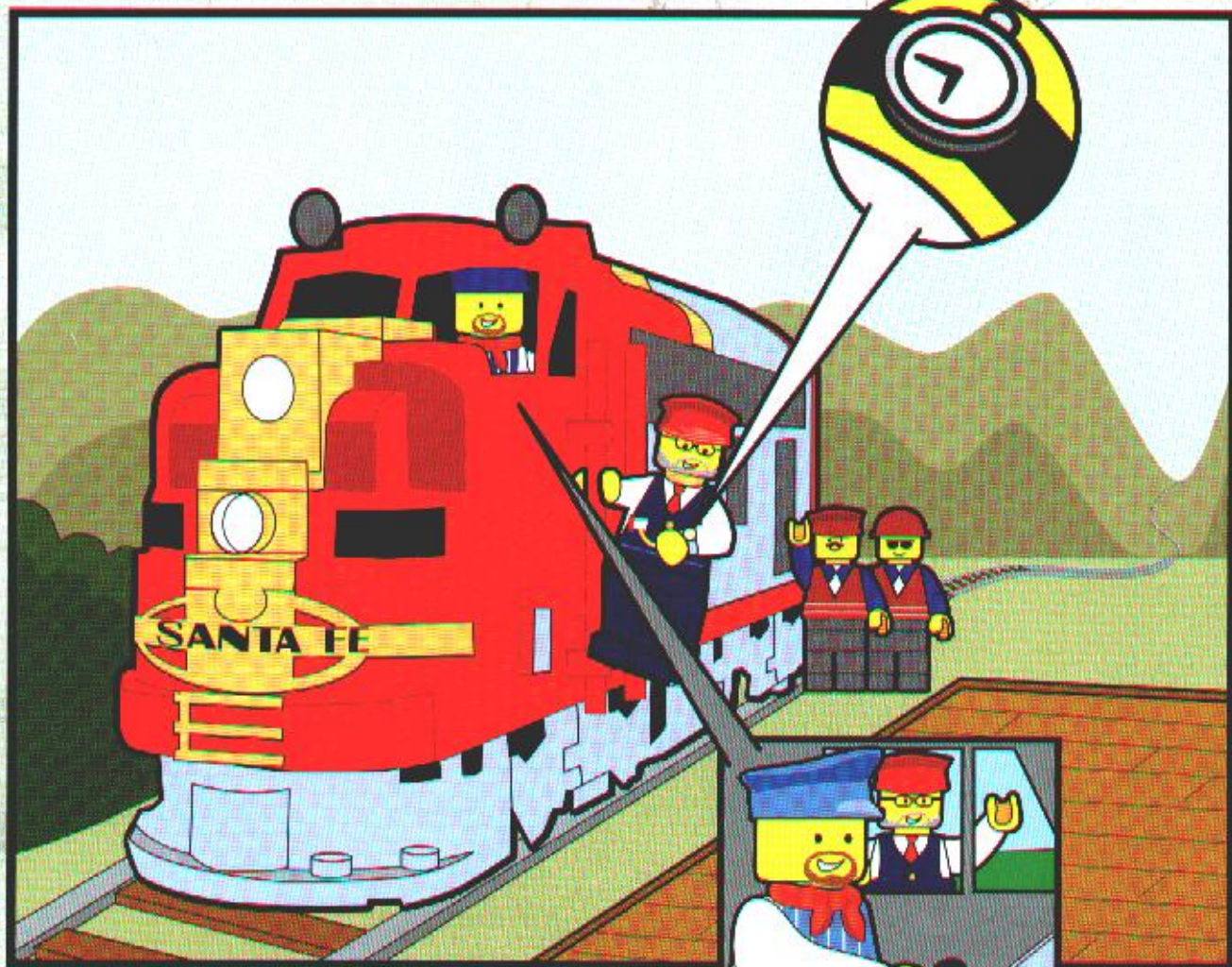

LEGO

just imagine...

10020



PORT LANSOP

Three successive forts were built to protect trail travelers and to serve as a major military supply depot for the Southwest.

TEXAS

©2002 The LEGO Group.



CONGRATULATIONS!
HERZLICHEN GLUECKWUNSCH!

SANTA FE

SUPER CHIEF

LIMITED EDITION
LIMITIERTE AUFLAGE

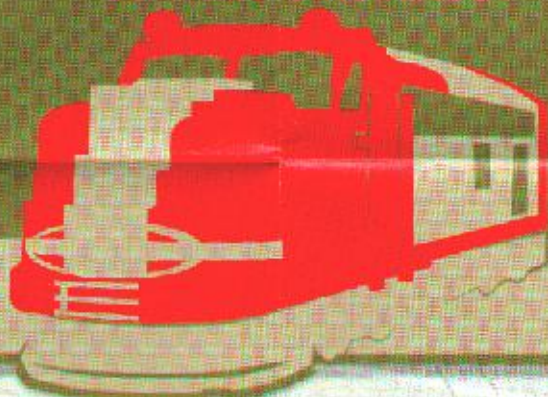

This document certifies that you are the owner of a first-edition LEGO® Santa Fe Super Chief model. A limited quantity of 10,000 of these distinguished diesel locomotive sets was produced under license from the Burlington Northern and Santa Fe Railway Company for the initial production run. A special tile included in each set displays your engine's unique production number.

Dieses Dokument bescheinigt den Besitz einer ersten Edition des LEGO® Santa Fe Super Chief Modells. In ihrer ersten Produktion wurde eine limitierte Auflage von 10000 Stück dieser aussergewöhnliche Diesellokomotive als Lizenzprodukt der 'Burlington Northern und Santa Fe Railway Company' gefertigt. Eine jedem Set speziell beiliegende Tafel zeigt die einzigartige Produktionsnummer deiner Lokomotive.

Kjeld Kirk Kristiansen

Kjeld Kirk Kristiansen

COLORADO

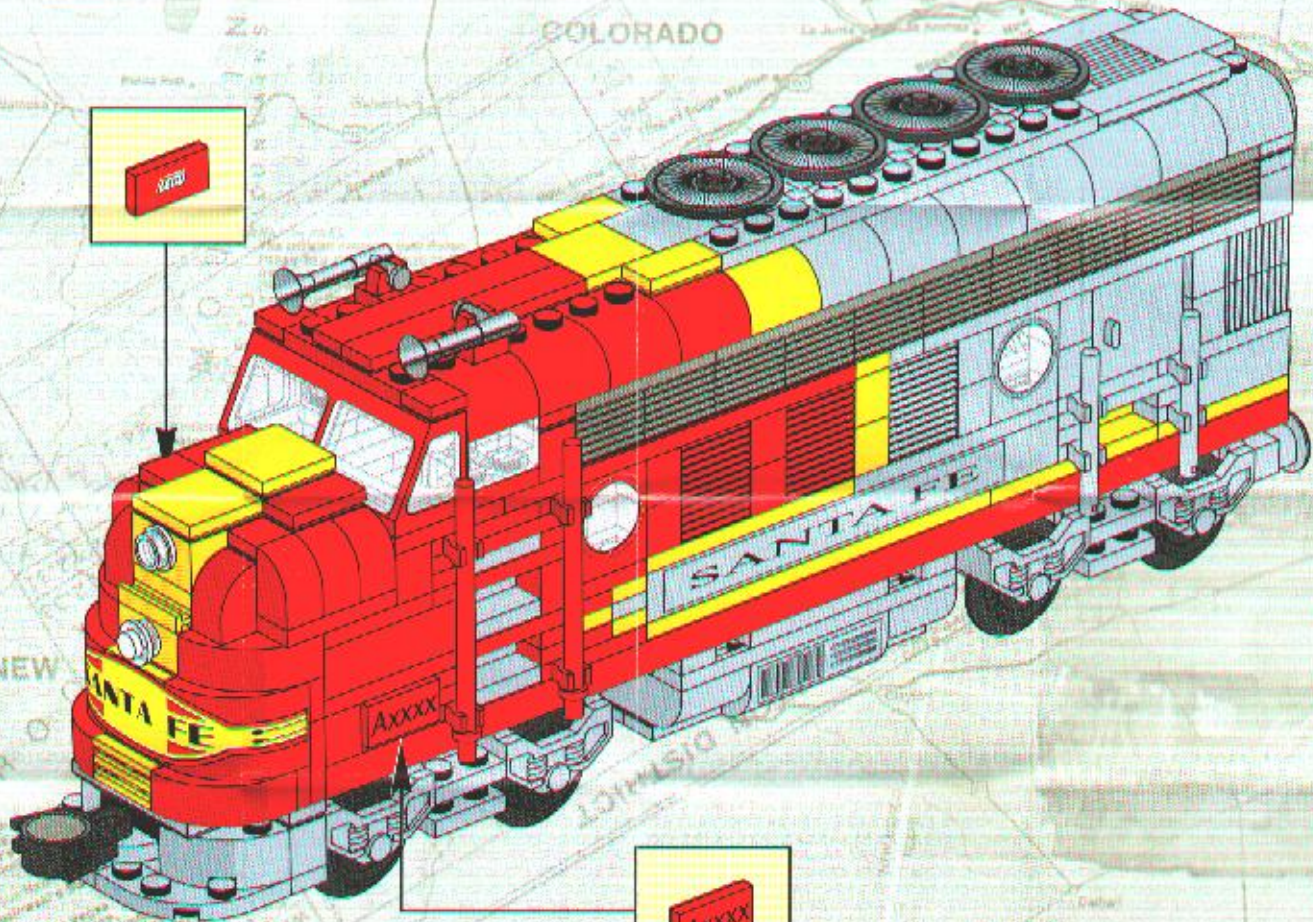

NEW

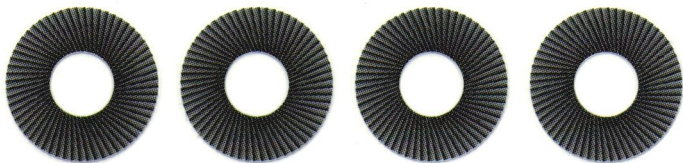

301 301

301 301

27 27

27 27

SANTA FE

SANTA FE

43822/4174735 © 2002 LEGO GROUP

