



# HEROFACTORY



# XPLODE

7147



# HEROFACTORY



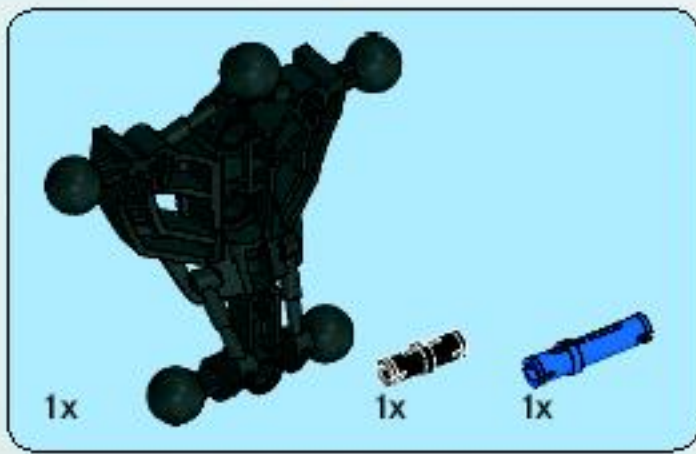

1

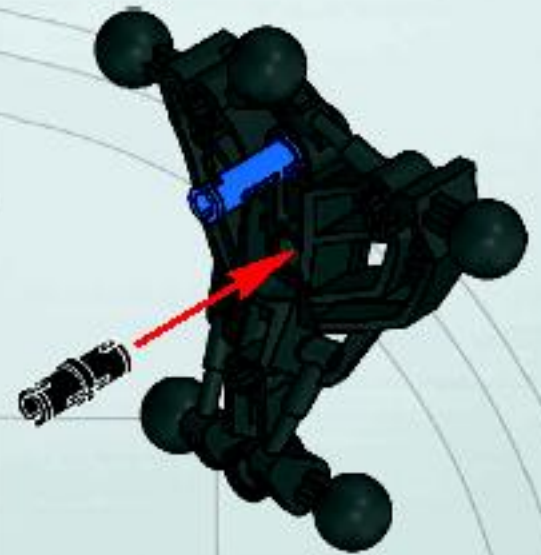

2



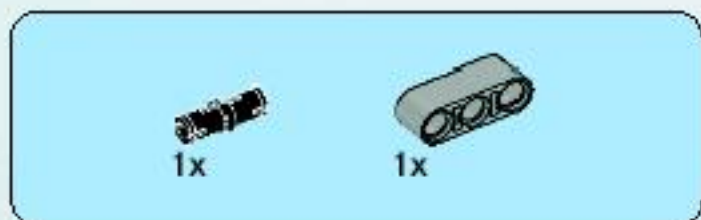

3



4



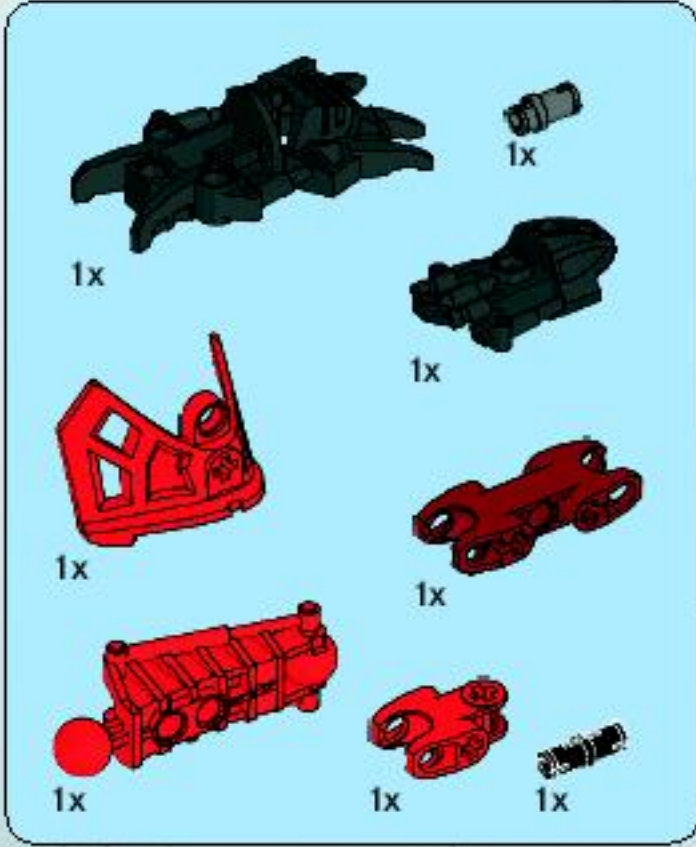

5



2



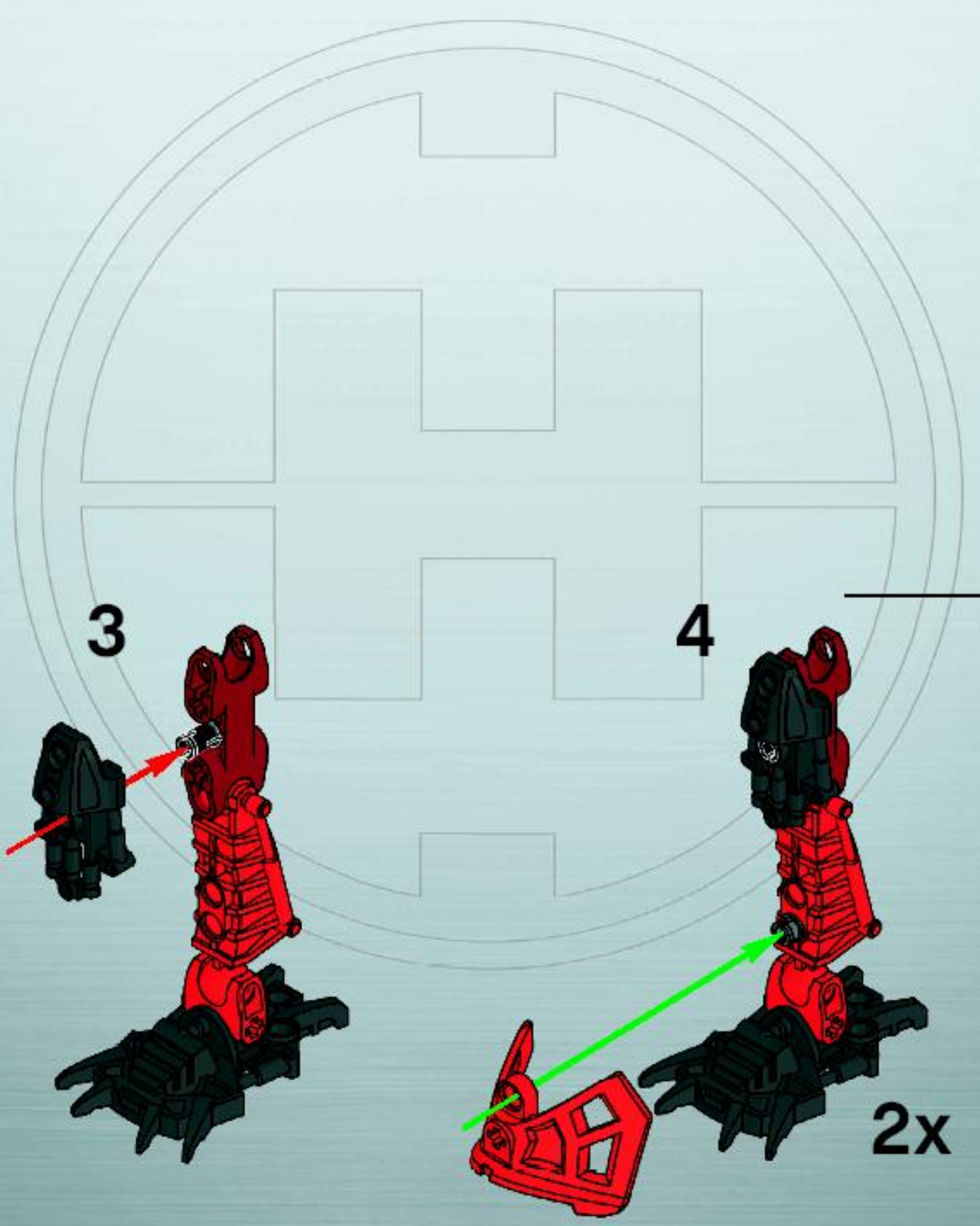

3

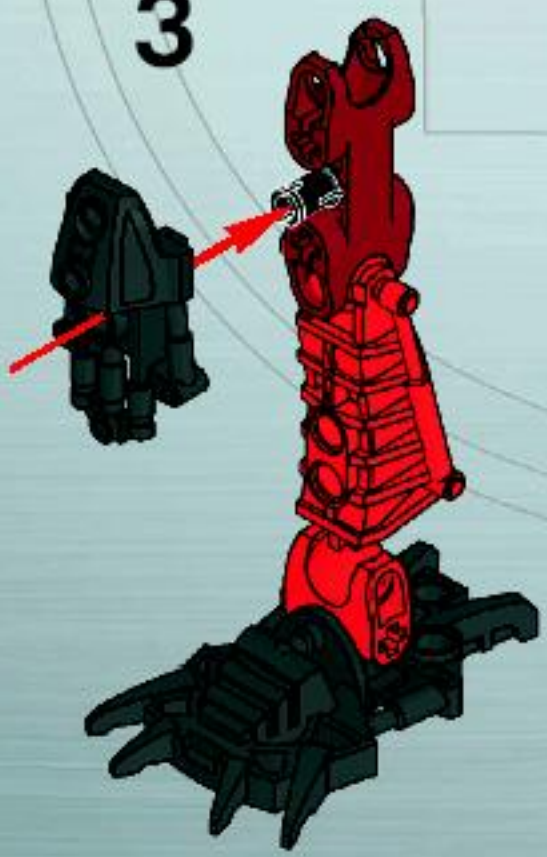

4

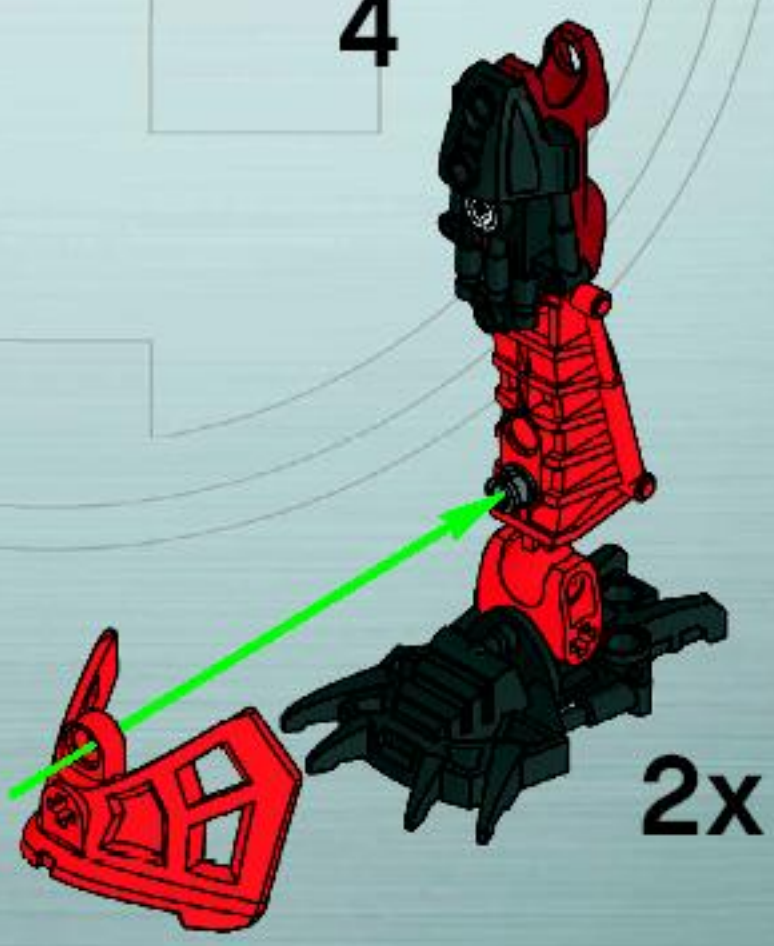

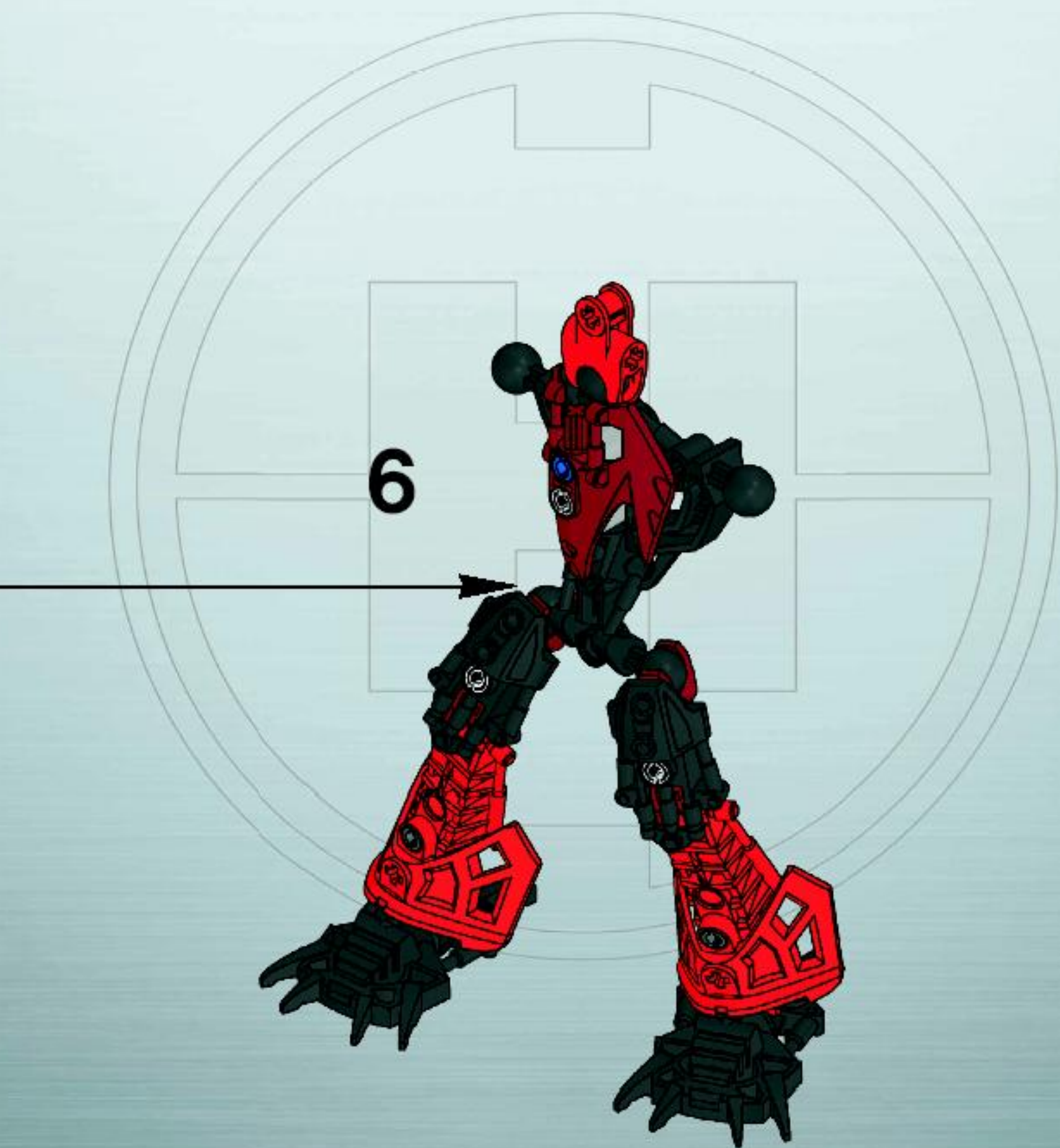

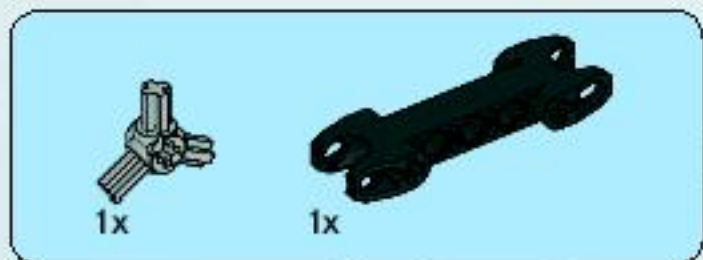

1

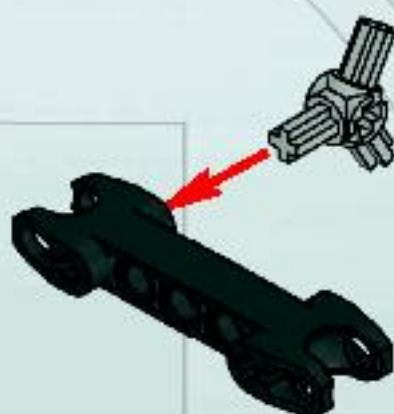

2

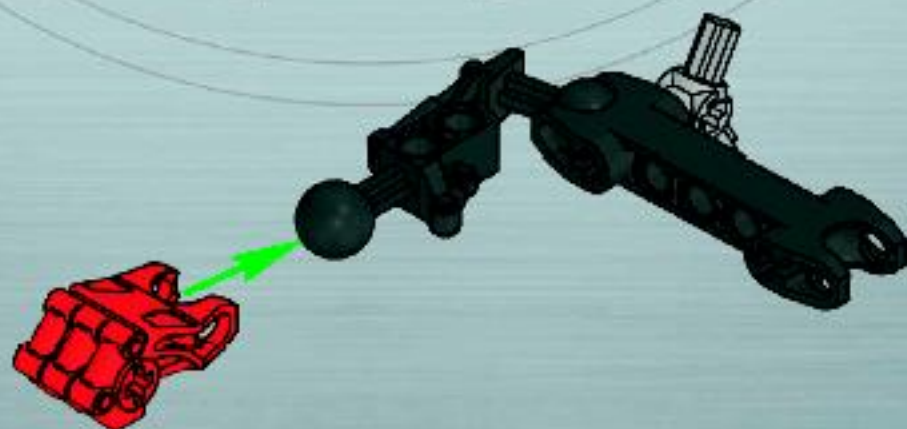



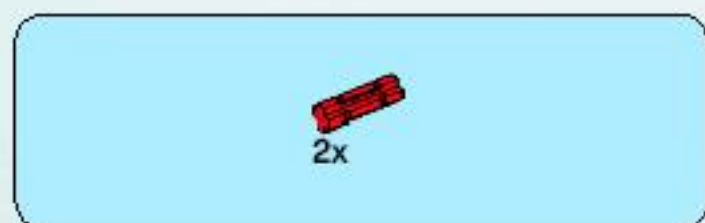

3

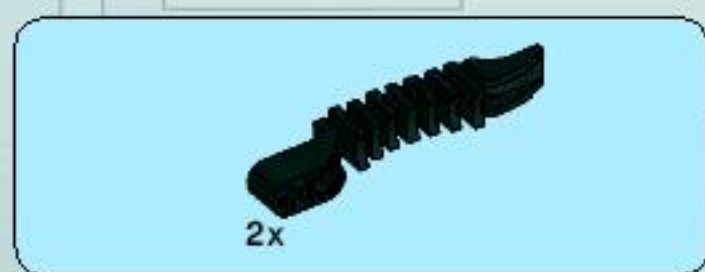

4

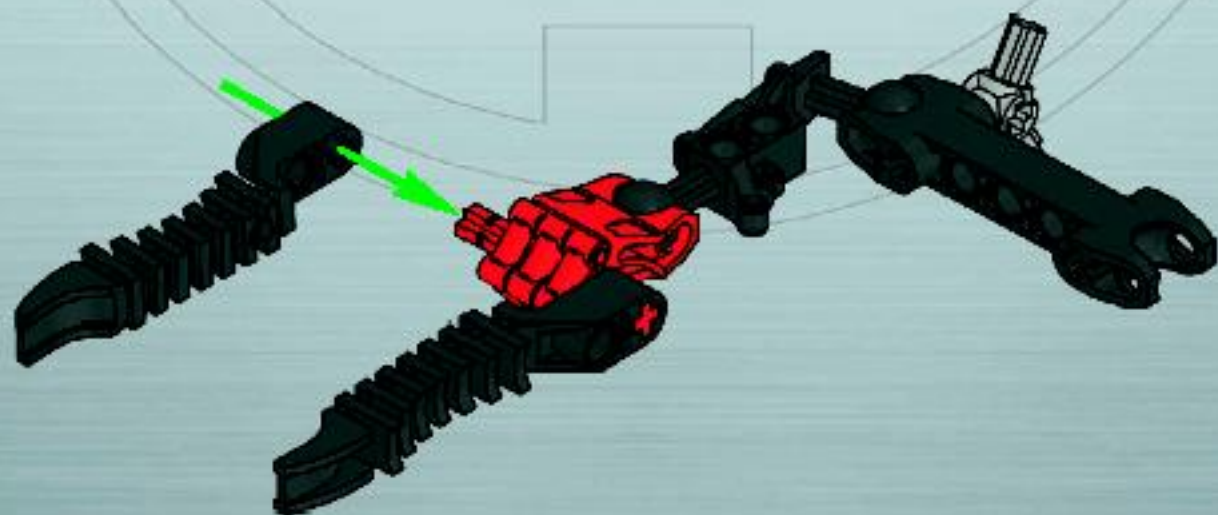

7

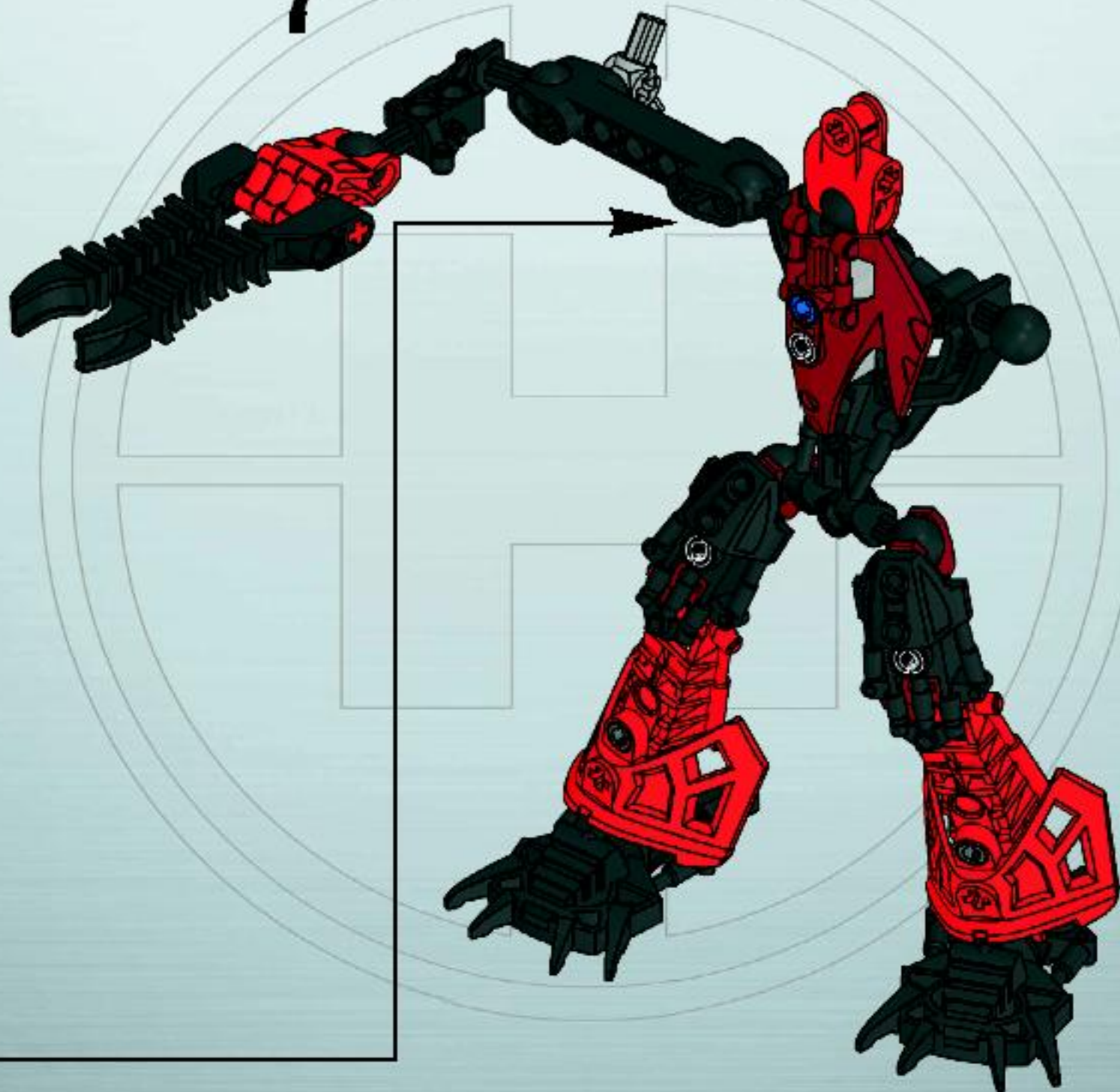

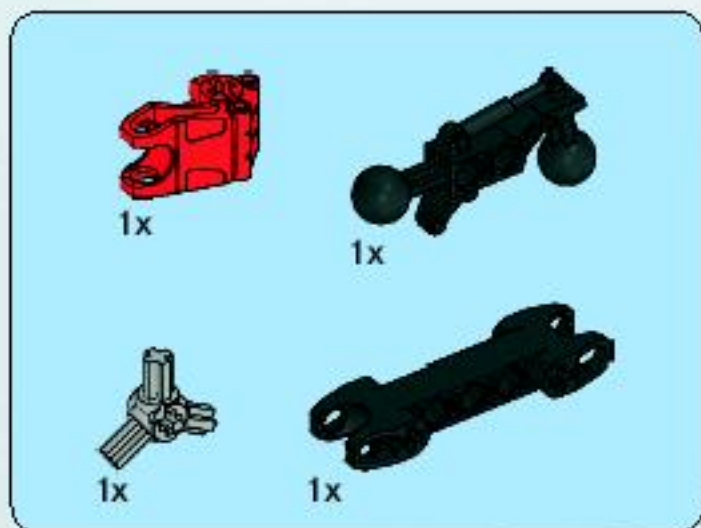

8

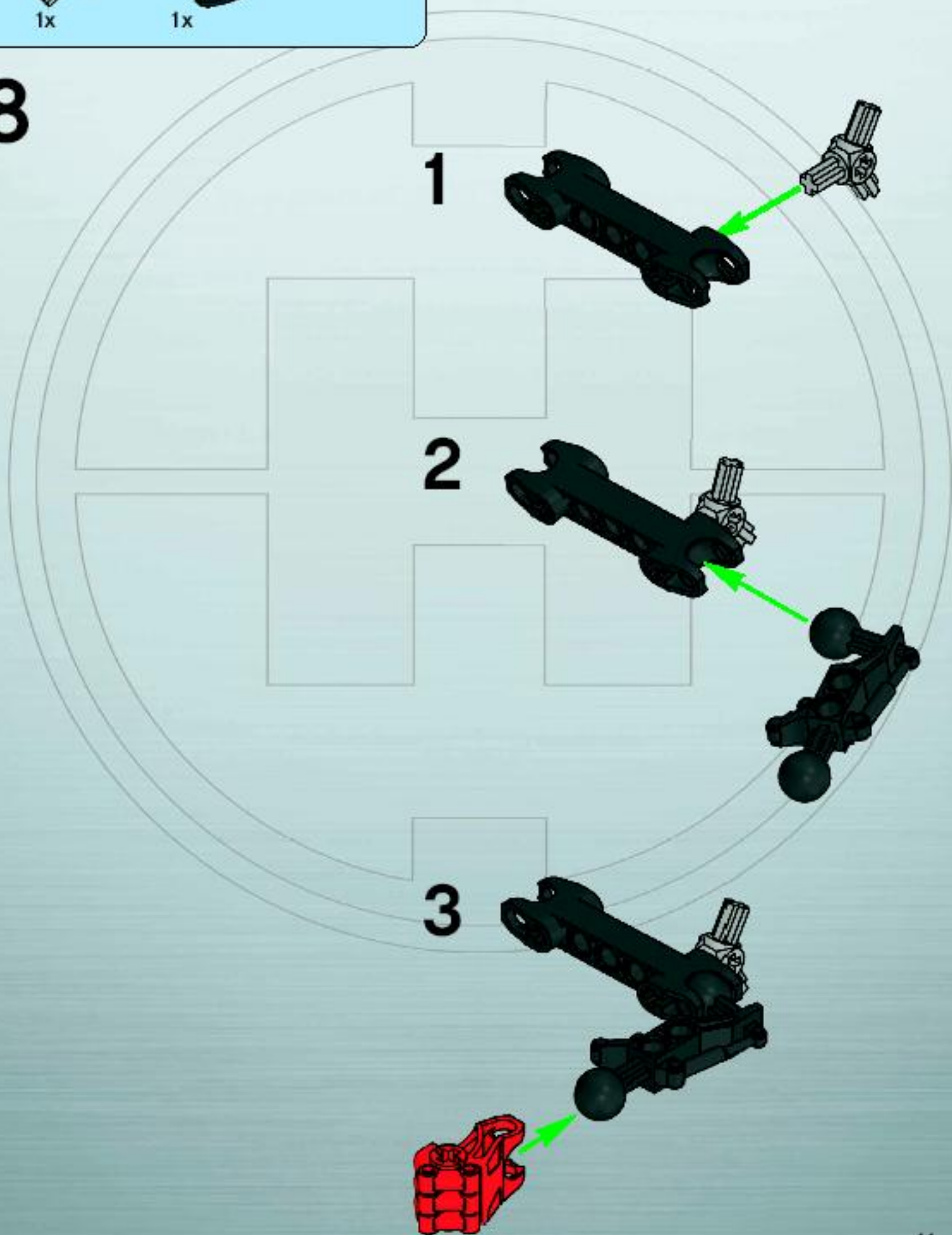

9

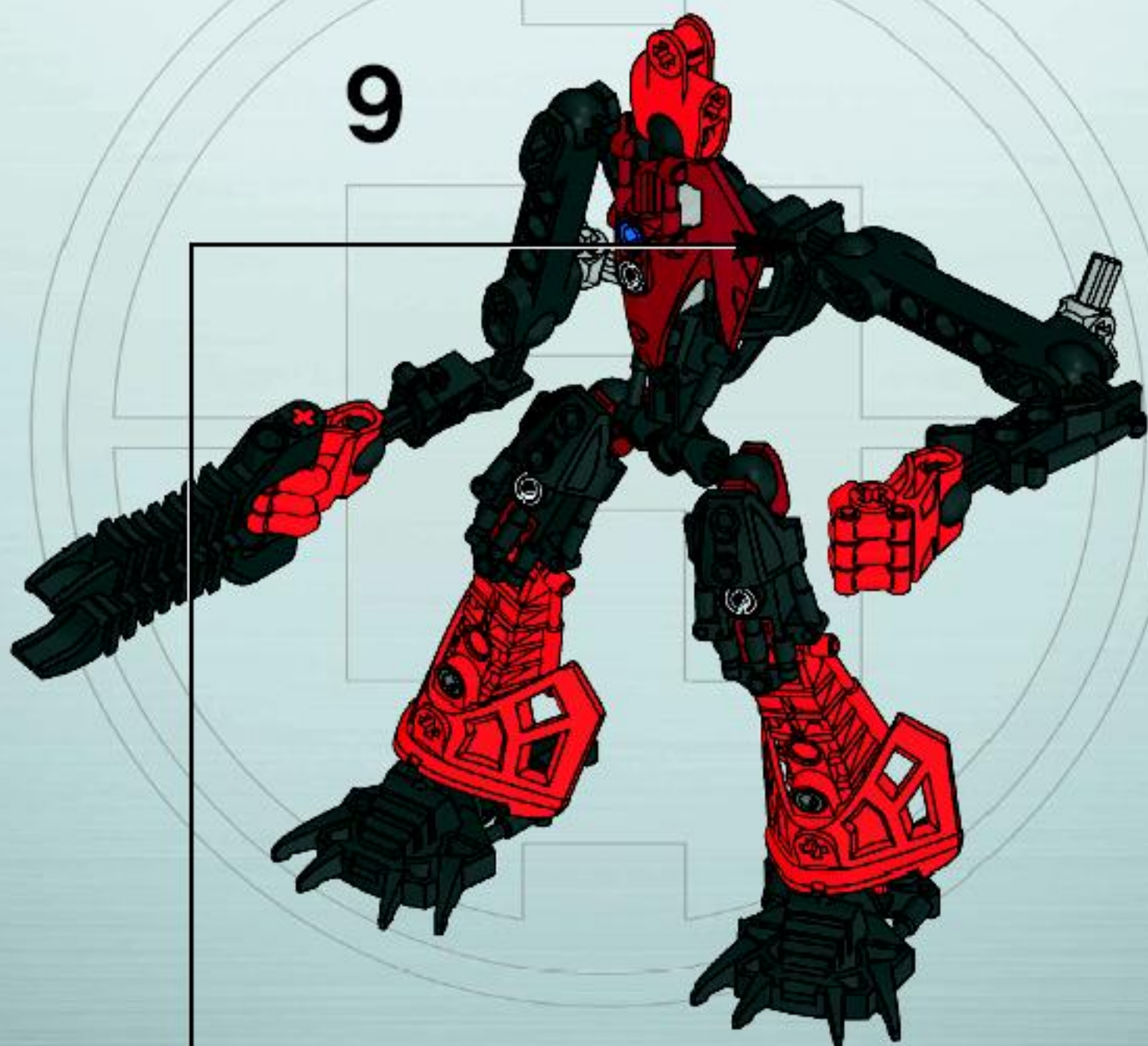

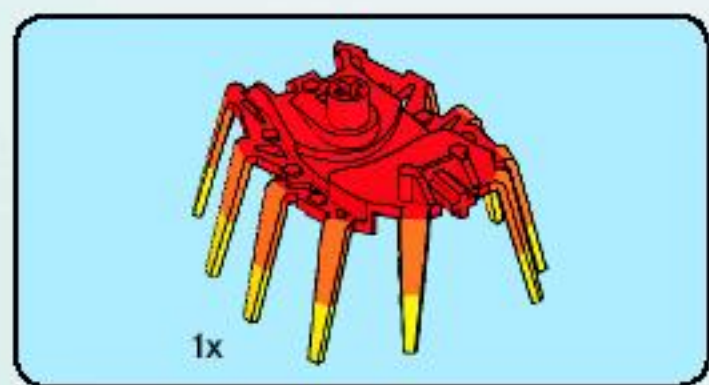

10

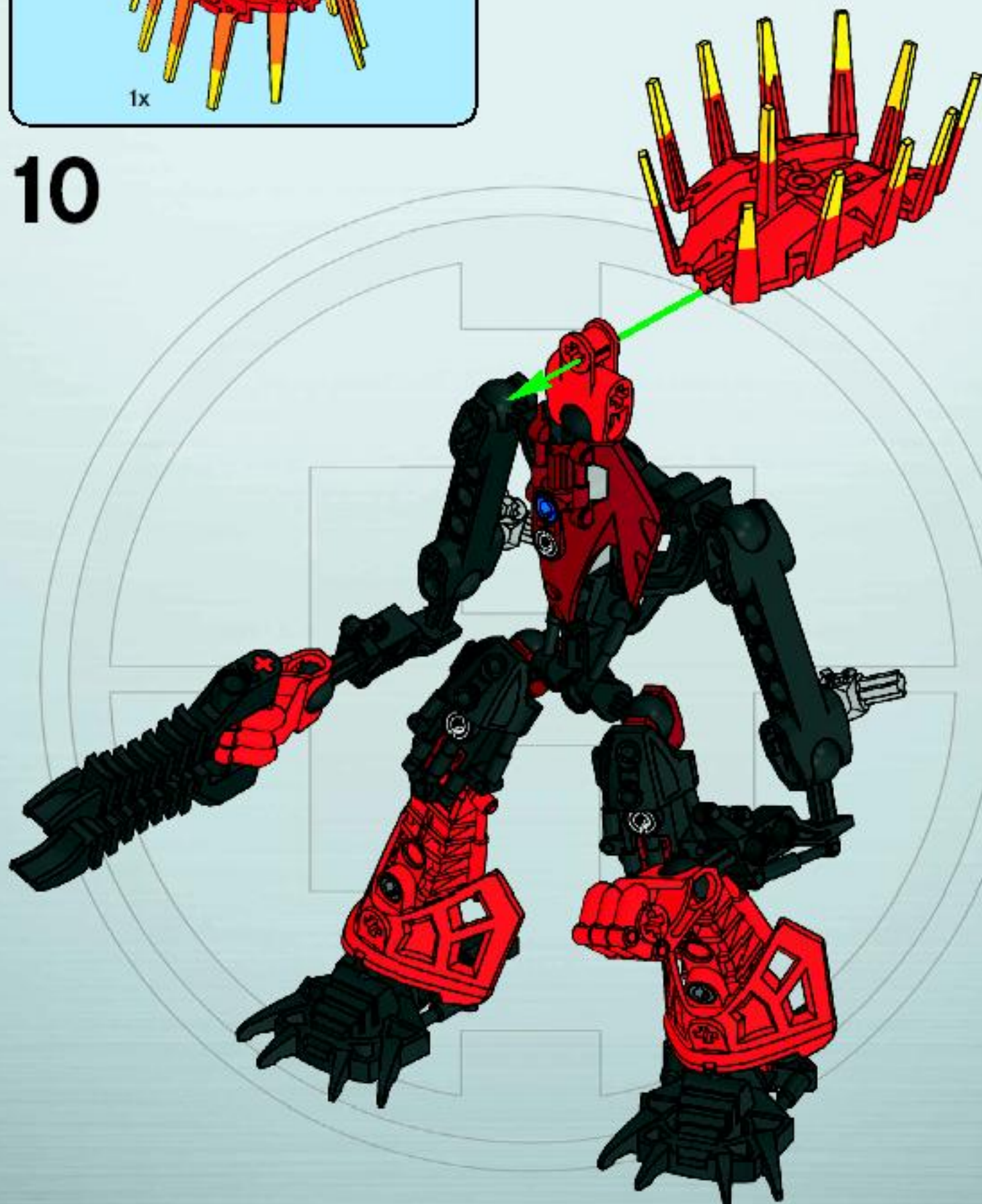

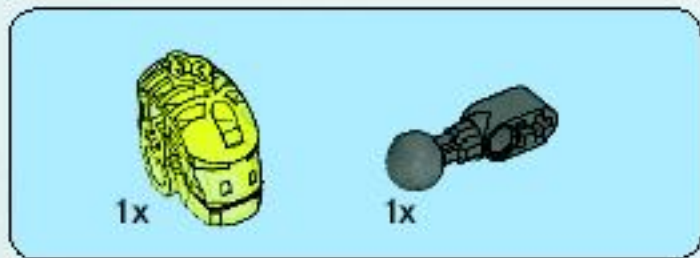

11

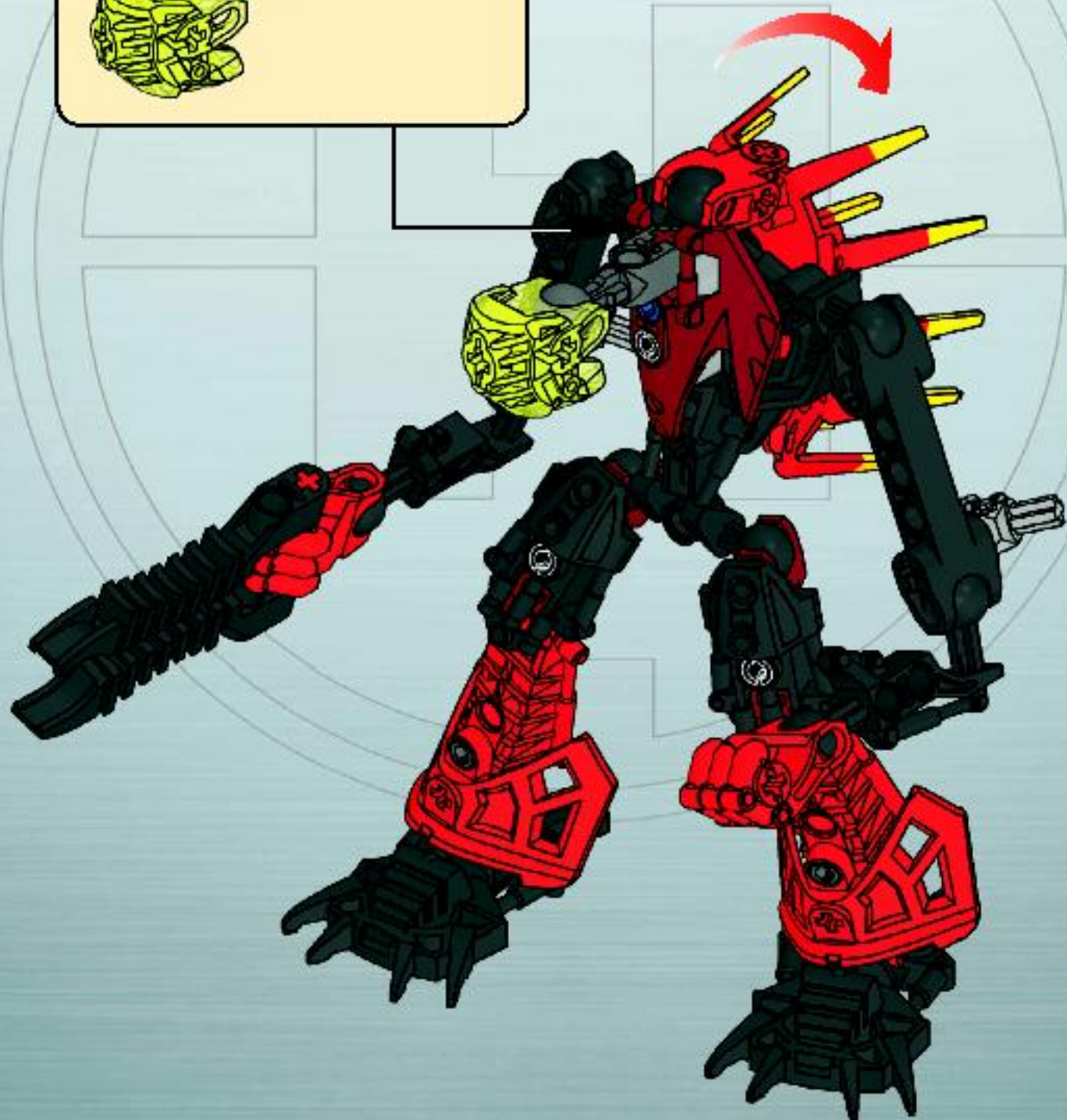
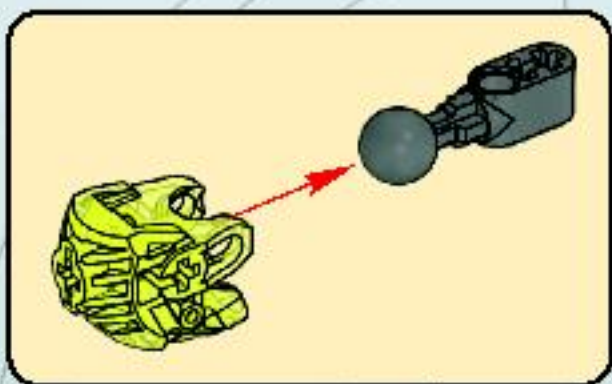

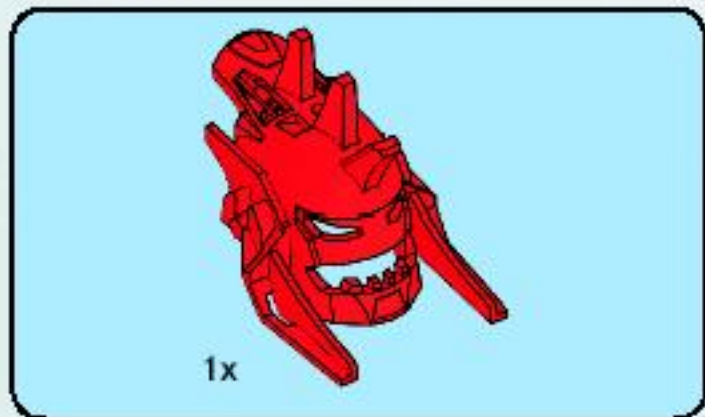

12

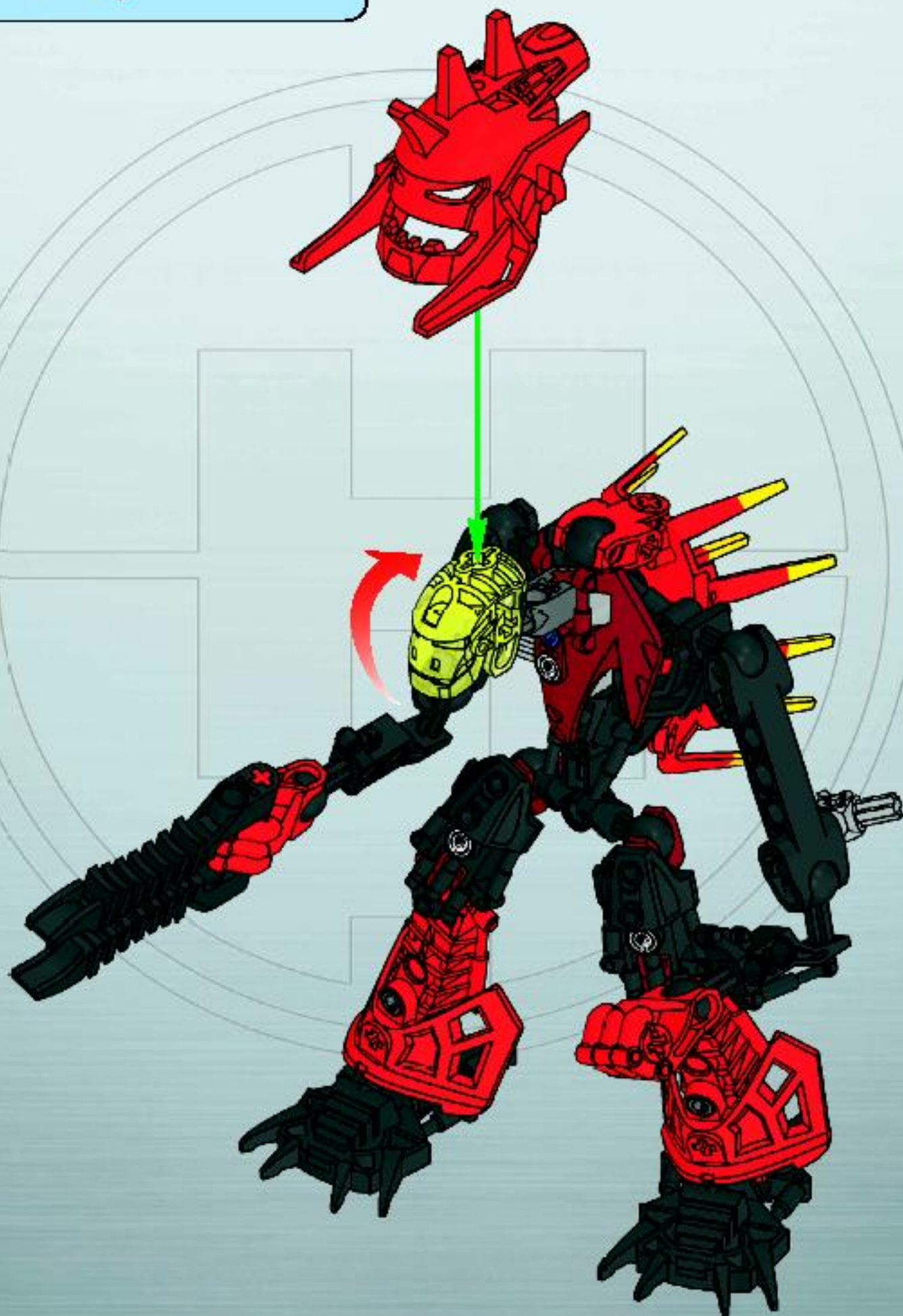

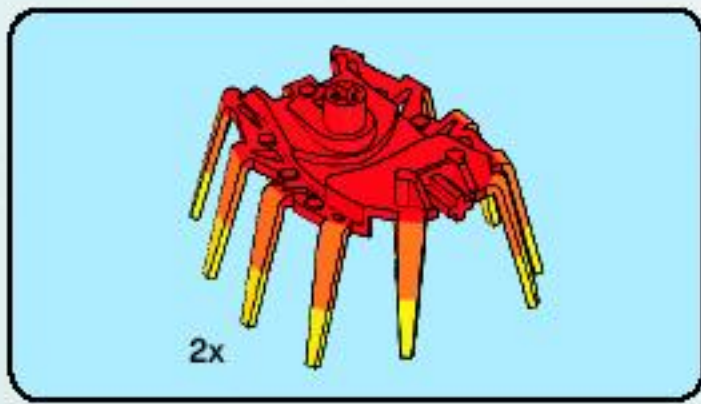

13





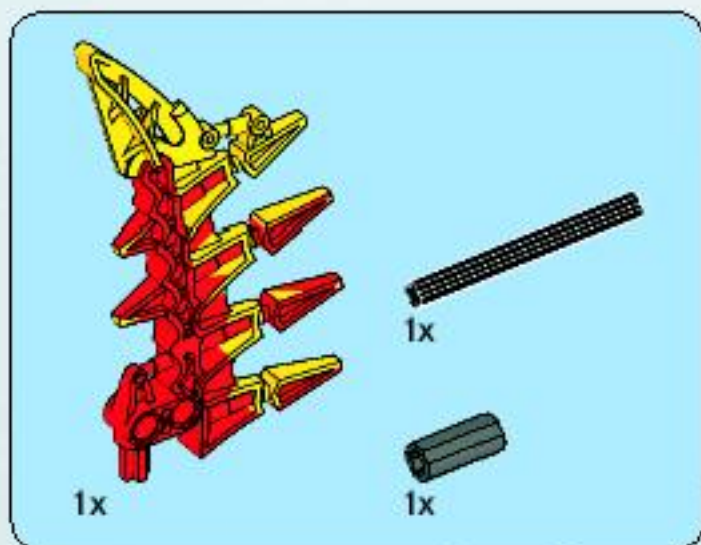

14

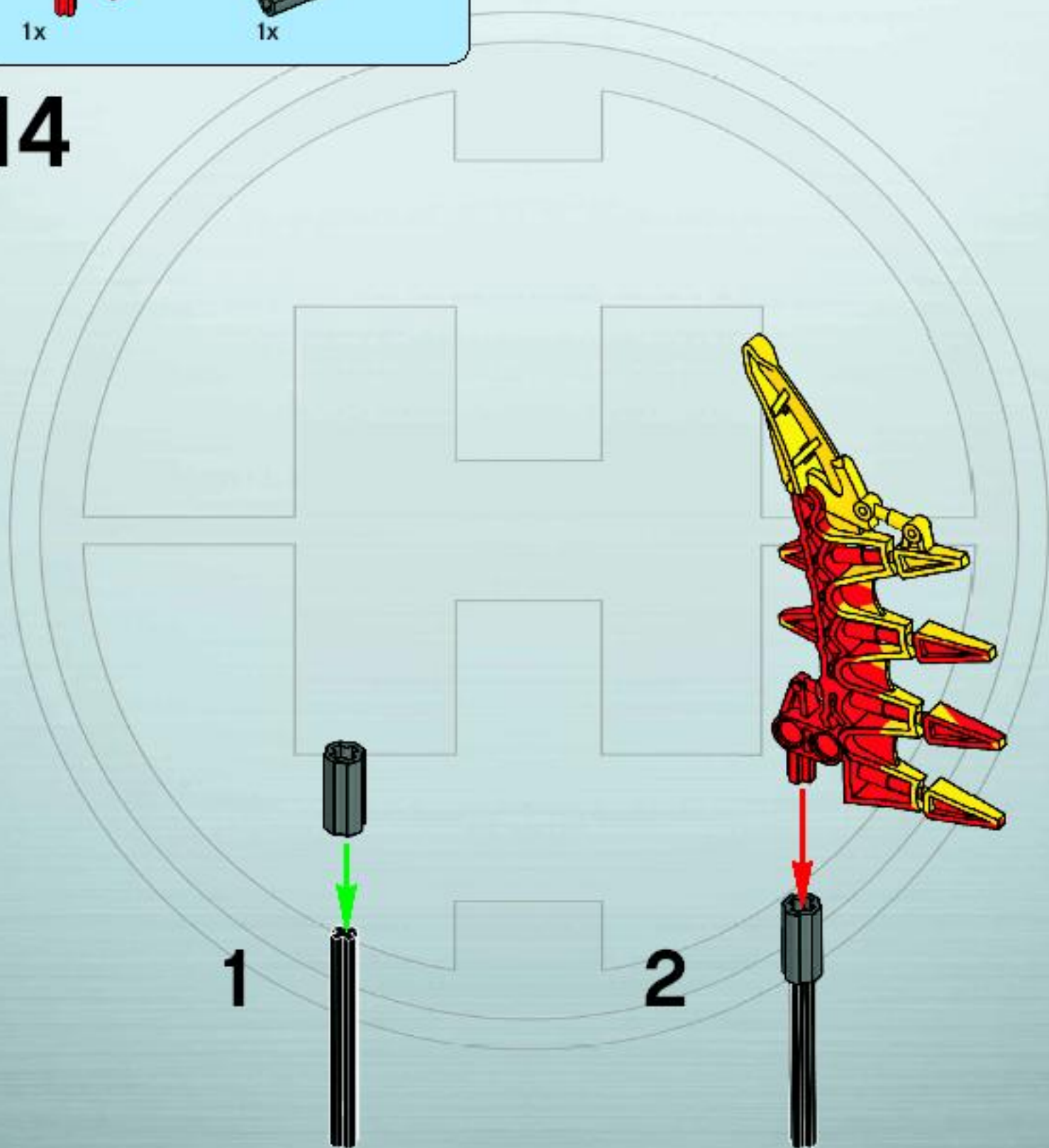



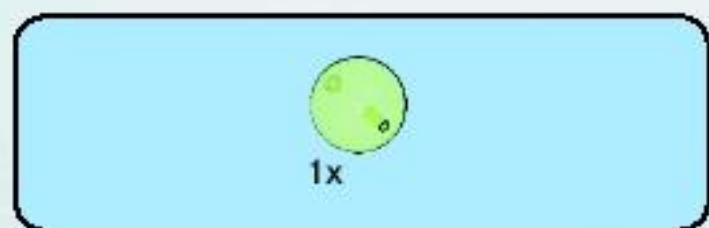

15

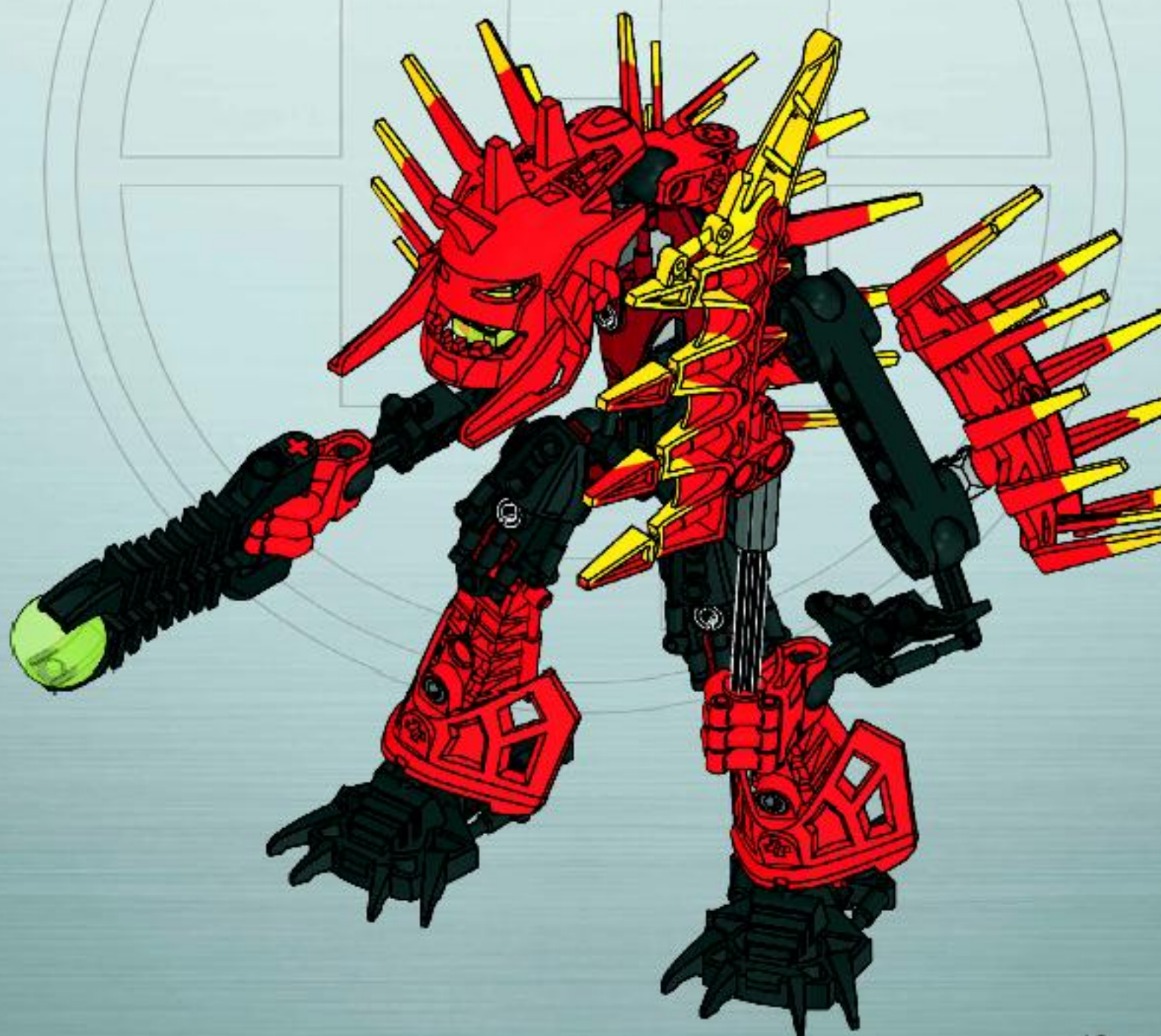
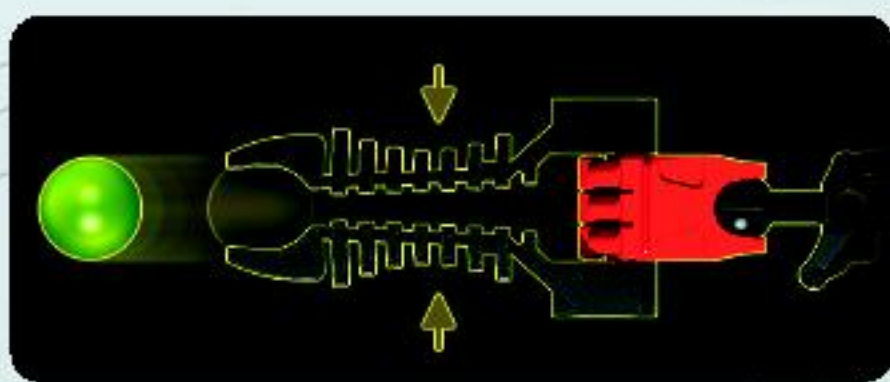

4x  
4121715

2x  
4142865

2x  
4594562

1x  
370626

6

3x  
4598440

1x  
4582178

2x  
4528179

2x  
4583983

1x  
4514553

2x  
4281239

2x  
4541816

1x  
4543428

2x  
4280266

1x  
4579134

1x  
4583979

2x  
4581740

2x  
4546765

2x  
4211050

2x  
4598410

2x  
4502595

1x  
4560110

1x  
4578958

1x  
4211655

1x  
4516546

1x  
4584805



Customer Service

Kundenservice

Service Consommateurs

Servicio Al Consumidor

[www.lego.com/service](http://www.lego.com/service) or dial



00800 5346 5555 :

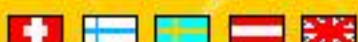

1-800-422-5346 :



3x  
4579135



# HEROFACTORY

*we build heroes™*

7169



7157



7165



**FREE! GRATIS! GRATUIT!**



**www.LEGOclub.com**



**00800 5346 5555\***        

  **1-866-534-6258 • 1-877-518-5346**

US & Canada only

Canada seulement

\* FreePhone. Mobile charges may apply. \* Nummer sans frais. Les frais peuvent s'appliquer avec les téléphones cellulaires.  
\* Gebührenfrei. Nur bei Airtime/Fees aus Mobilfunknetzen können abweichen. \* Gratis telefonnummer vand Fryske lja.  
\* Heberekki gratis nummer, når du ringer fra Postboks 10. \* Debór gratis, når kurriger från en Postboks 10.



VISIT THE WORLD'S  
BIGGEST LEGO® SHOP!

**www.LEGOshop.com**



# WIN!

Go to [www.nielsen.com/LEGO](http://www.nielsen.com/LEGO) to fill out a survey for a chance to win a cool LEGO® Product.

No purchase necessary.

Open to all residents where not prohibited.



## [www.nielsen.com/LEGO](http://www.nielsen.com/LEGO)

### GEWINNE!

Nimm an der Umfrage auf [www.nielsen.com/LEGO](http://www.nielsen.com/LEGO) teil und hab die Chance ein cooles LEGO® Produkt zu gewinnen!

Die Teilnahme am Gewinnspiel führt zu keinerlei Kaufverpflichtungen. Teilnahme in allen nicht ausgeschlossenen Ländern möglich.

### WIN!

Ga naar [www.nielsen.com/LEGO](http://www.nielsen.com/LEGO), vul een enquêteformulier in en maak kans op een cool LEGO® product.

Geen aankoopverplichting. Iedereen mag deelnemen, uitgezonderd ingezetenden

Van landen waar een enquêteverbod geldt

### GAGNE!

Visite [www.nielsen.com/LEGO](http://www.nielsen.com/LEGO) pour répondre à un questionnaire et avoir une chance de gagner un produit LEGO® très cool!

Aucune obligation d'achat. Ouvert à tous les résidents des pays autorisés.

### 当てよう!

[www.nielsen.com/LEGO](http://www.nielsen.com/LEGO) にアクセスして、アンケートにご記入ください。当選者にはレゴ製品を差し上げます。

お買い上げの必要はありません。禁止されていない限り、すべての年齢にご利用いただけます。