



ATLANTIS

8077



1

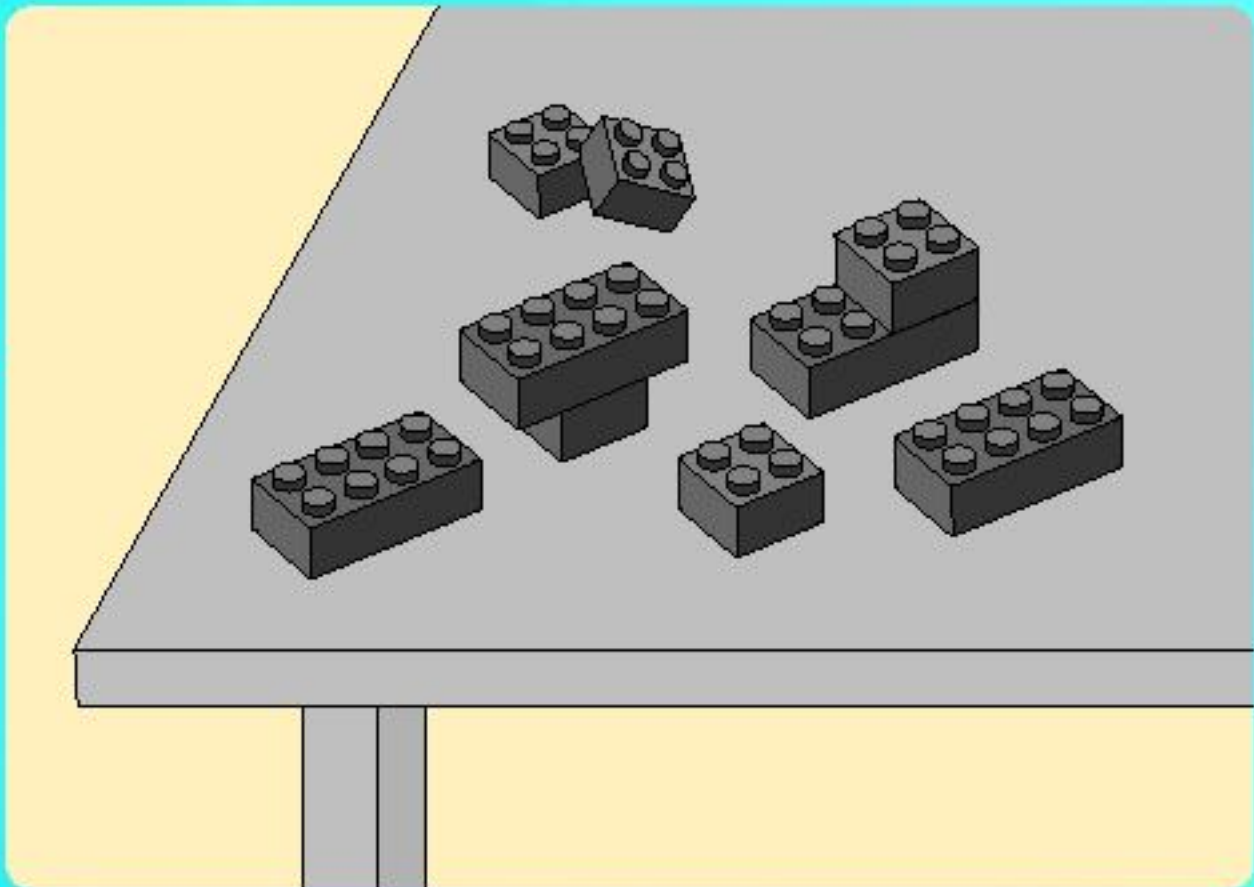
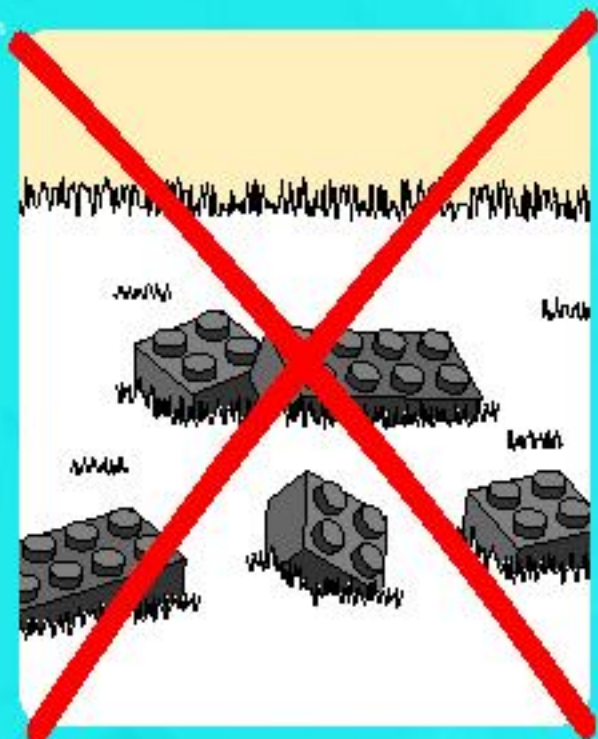

2

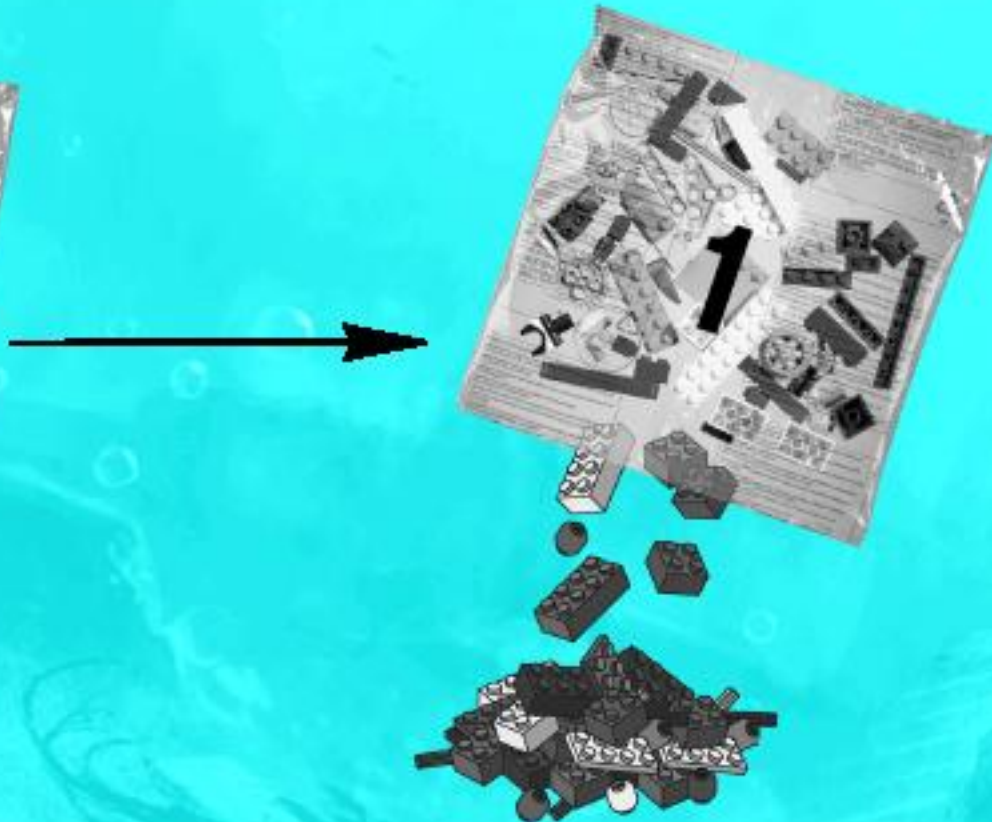

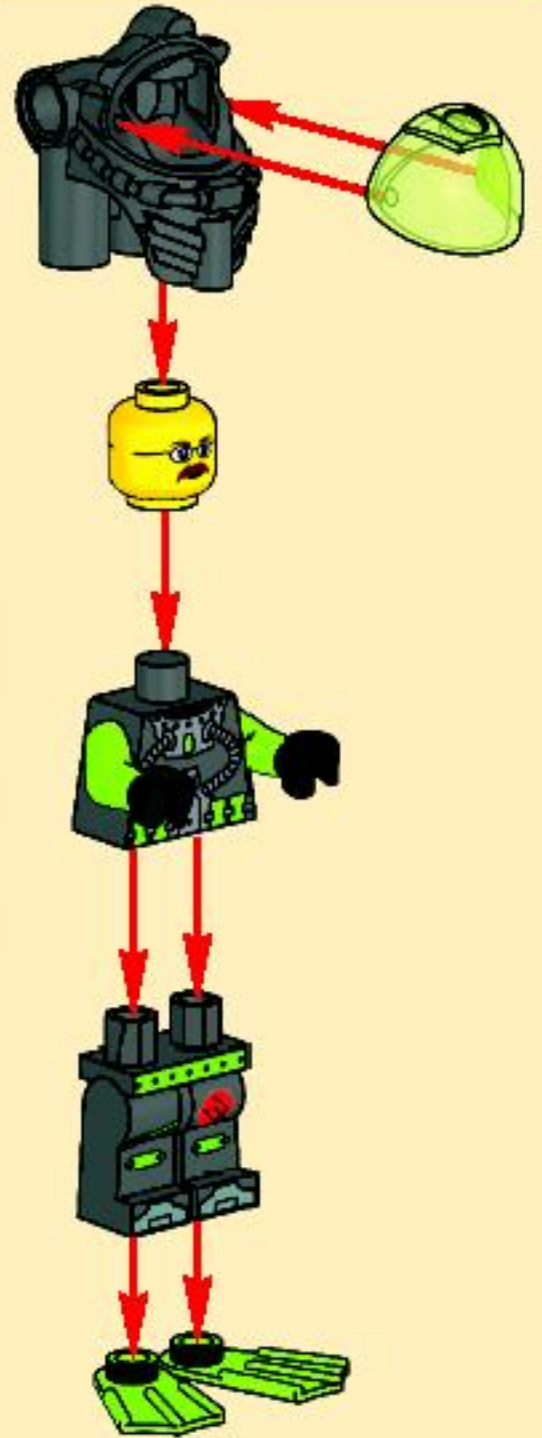
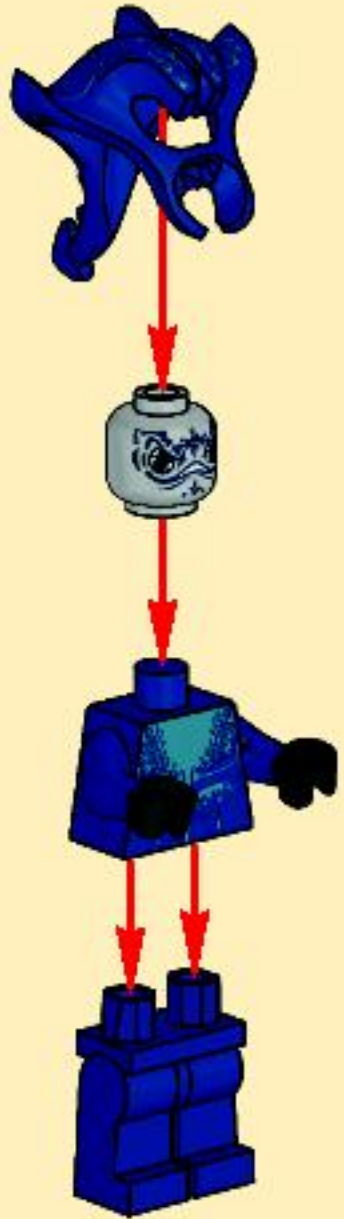

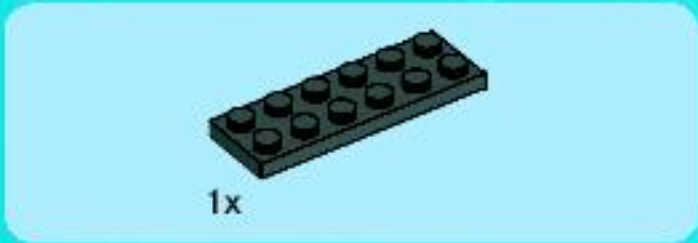

1

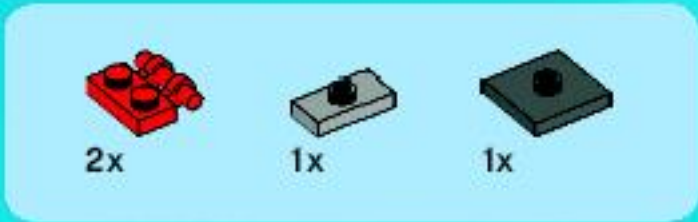

2

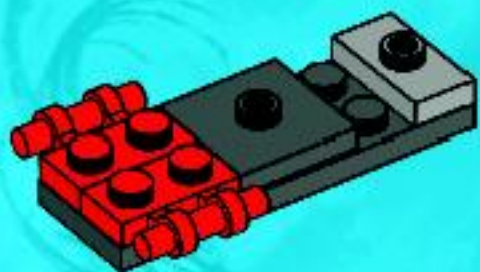

3

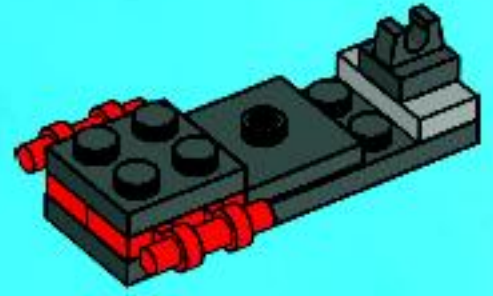

4

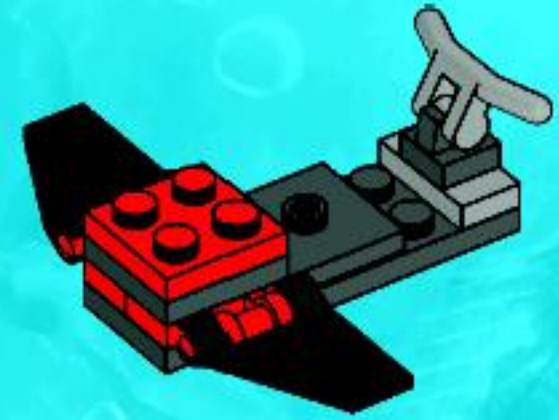



1x



1x



2x

5

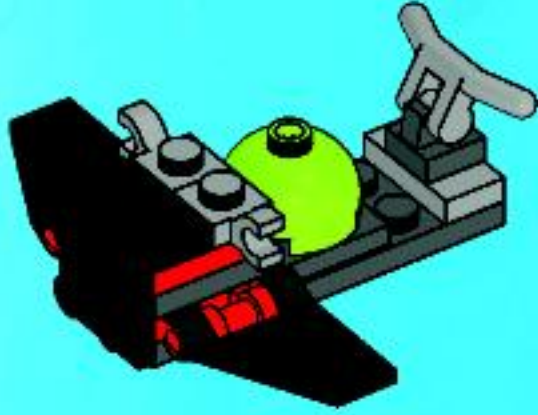

2x



1x

6

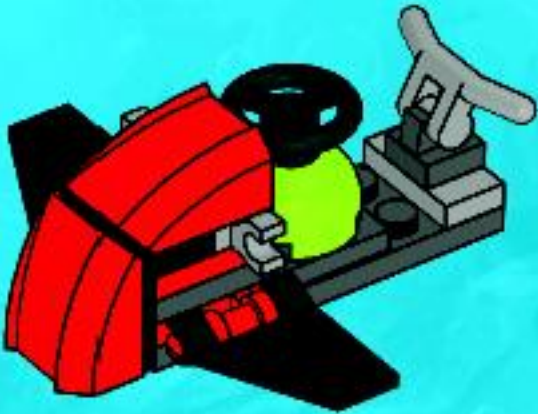

2x

7

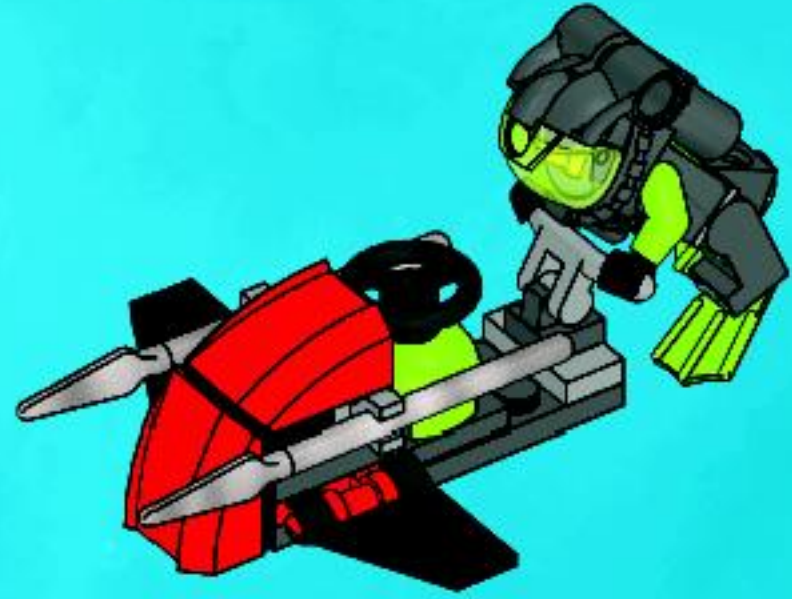

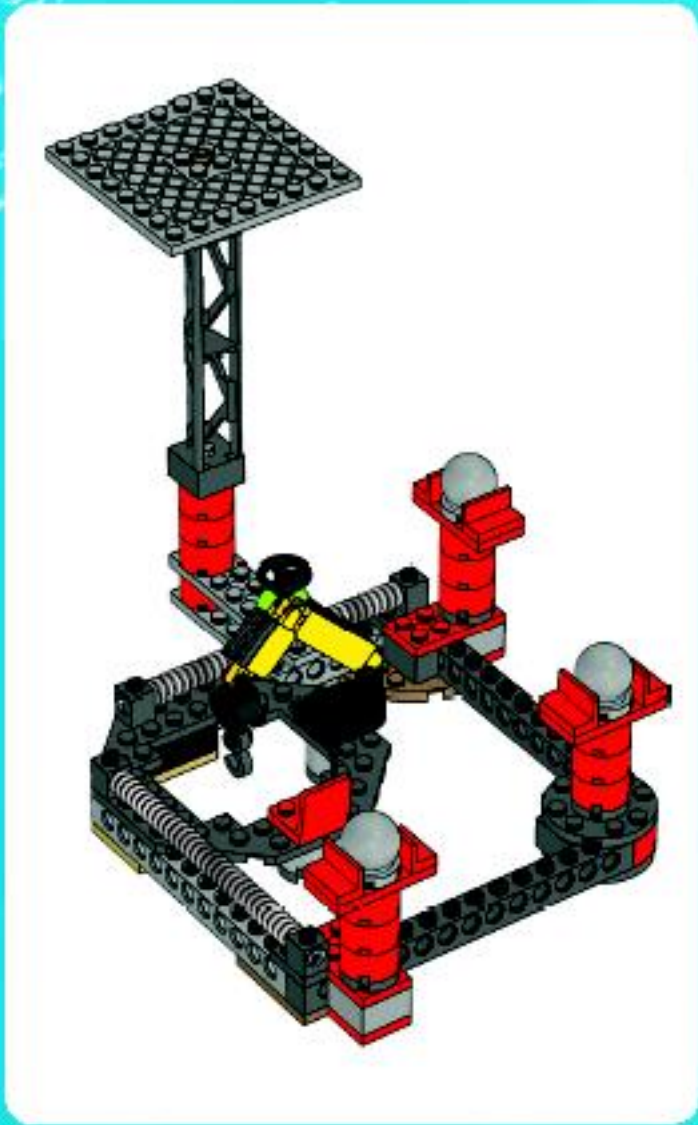

1

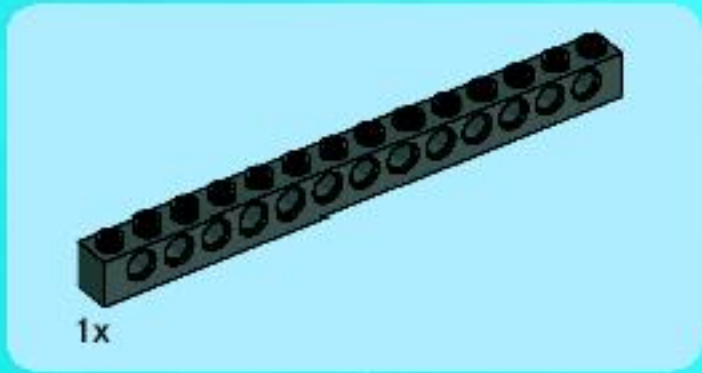

2

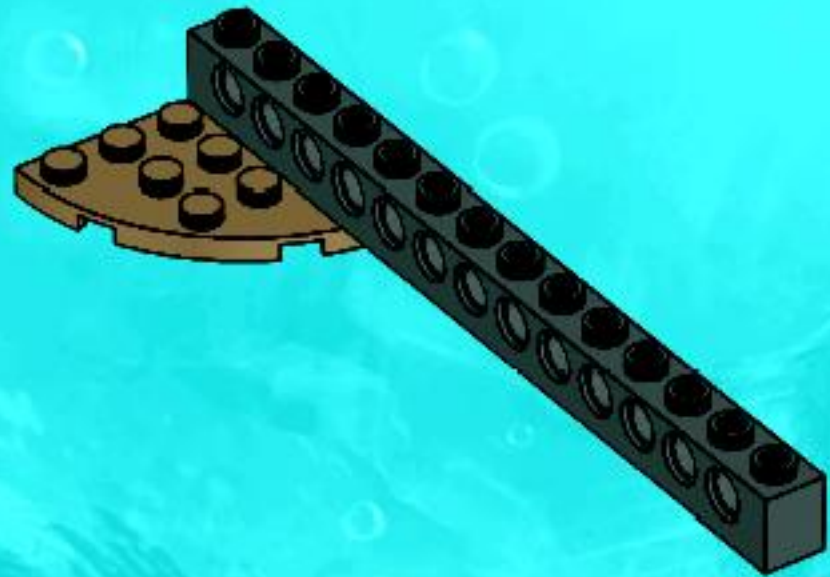

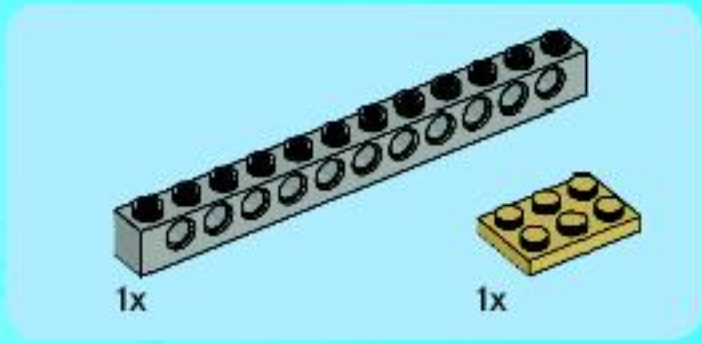

3

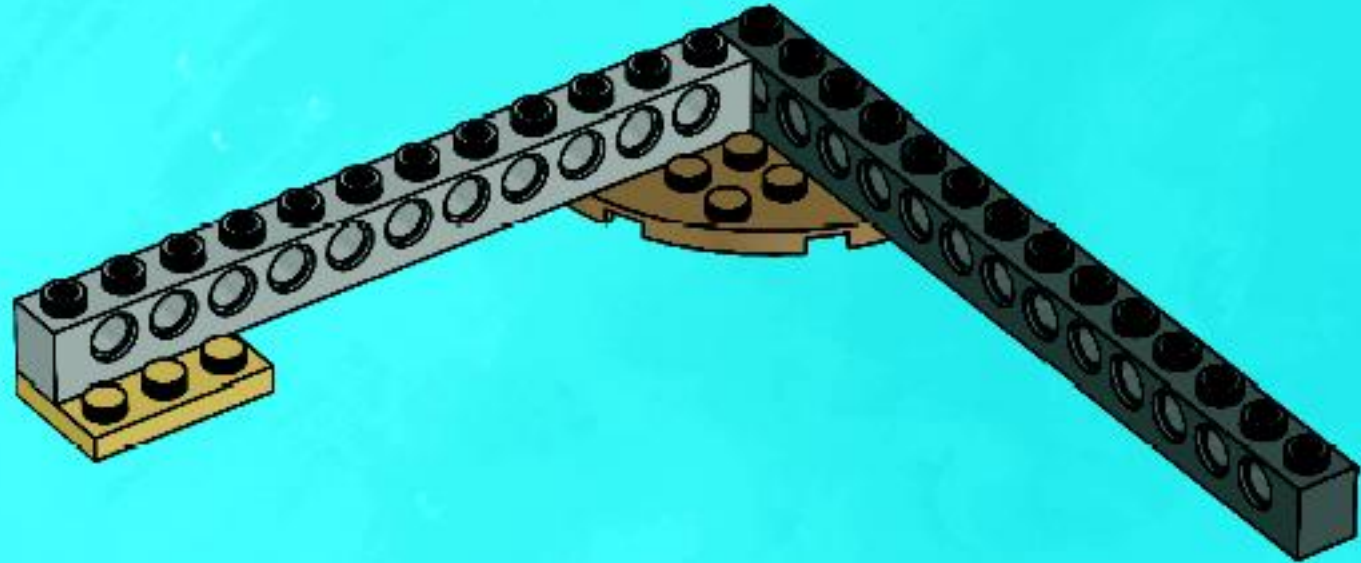

4

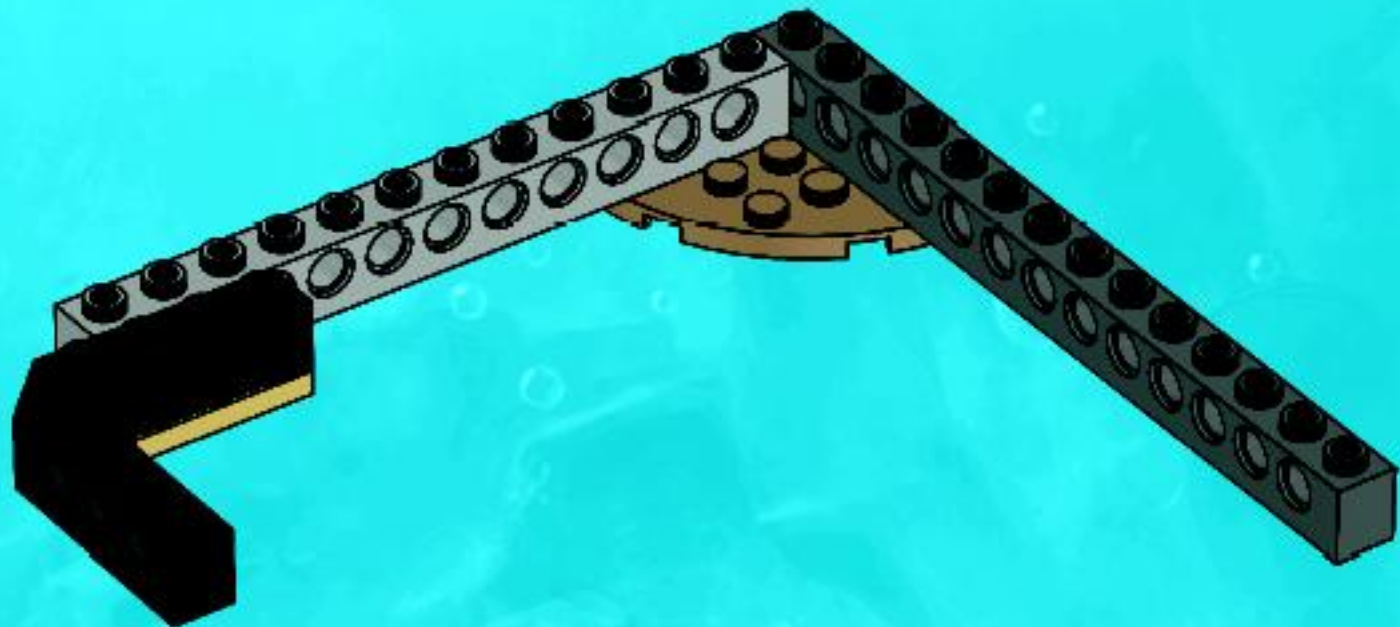



1x

5

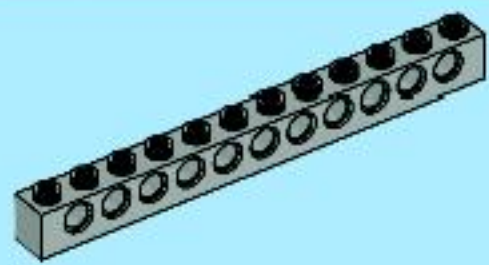
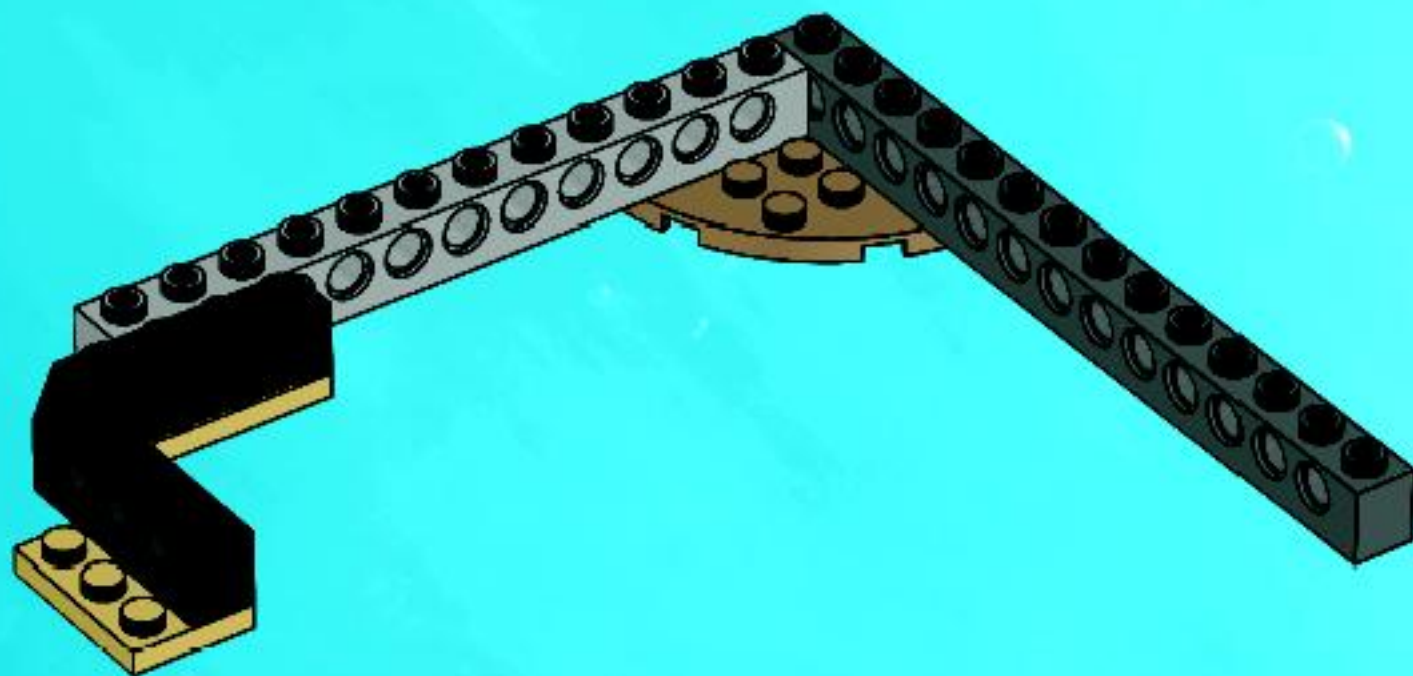

1x

6

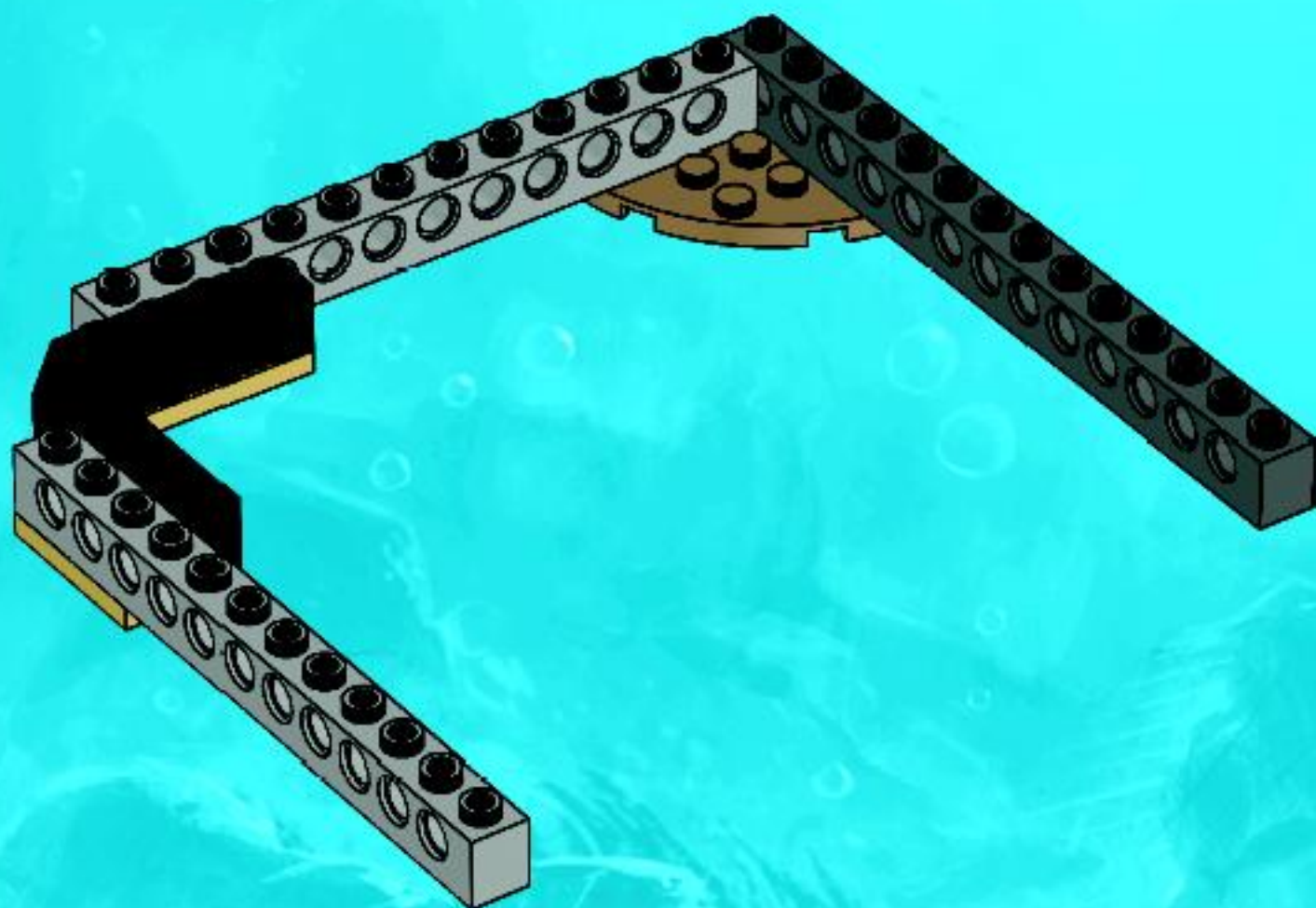



1x



1x

7

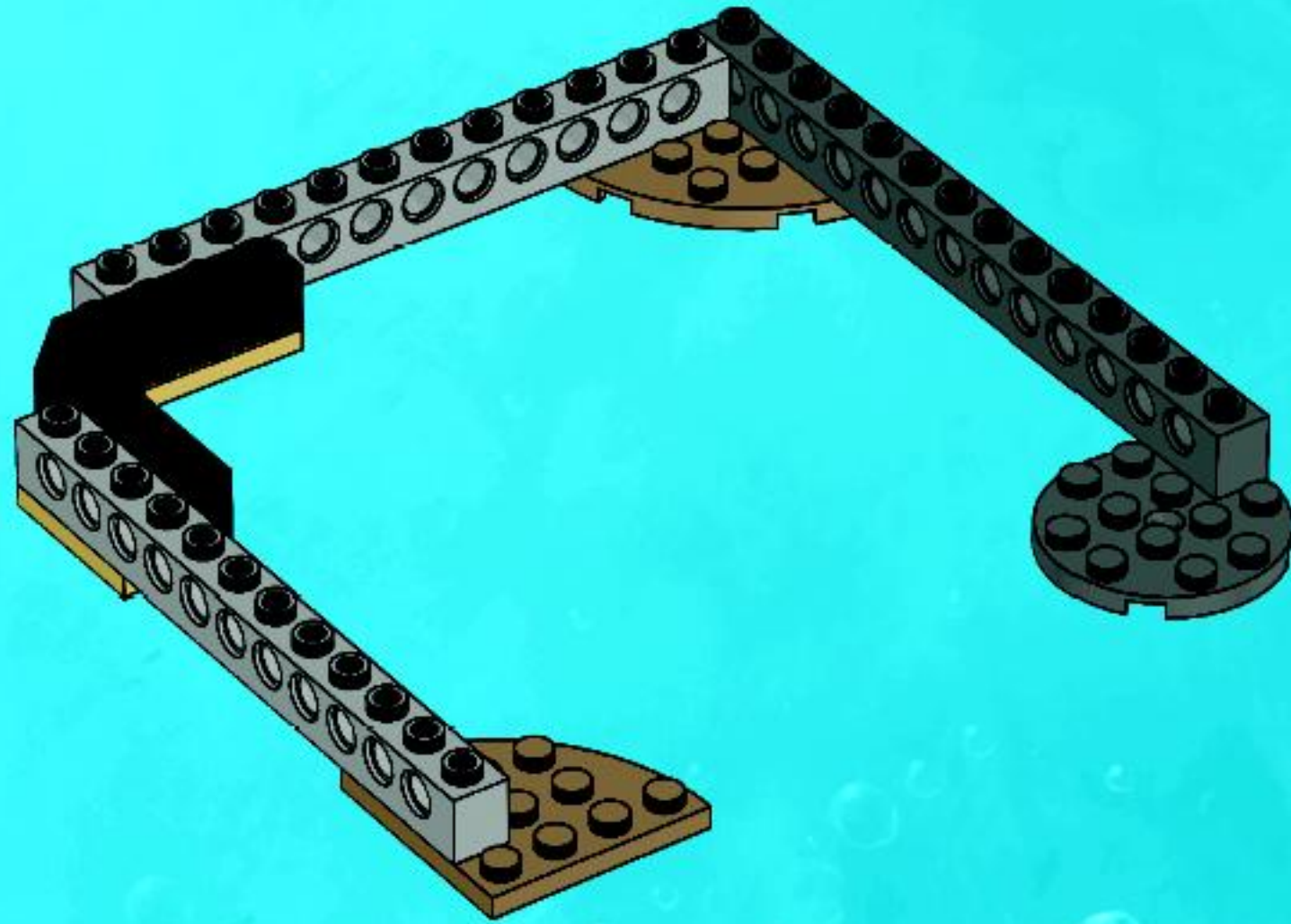

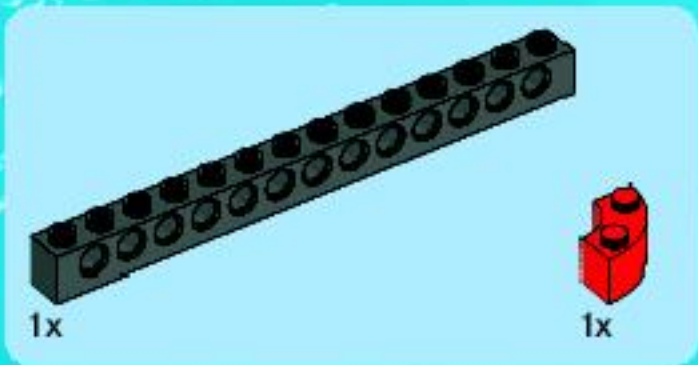

8

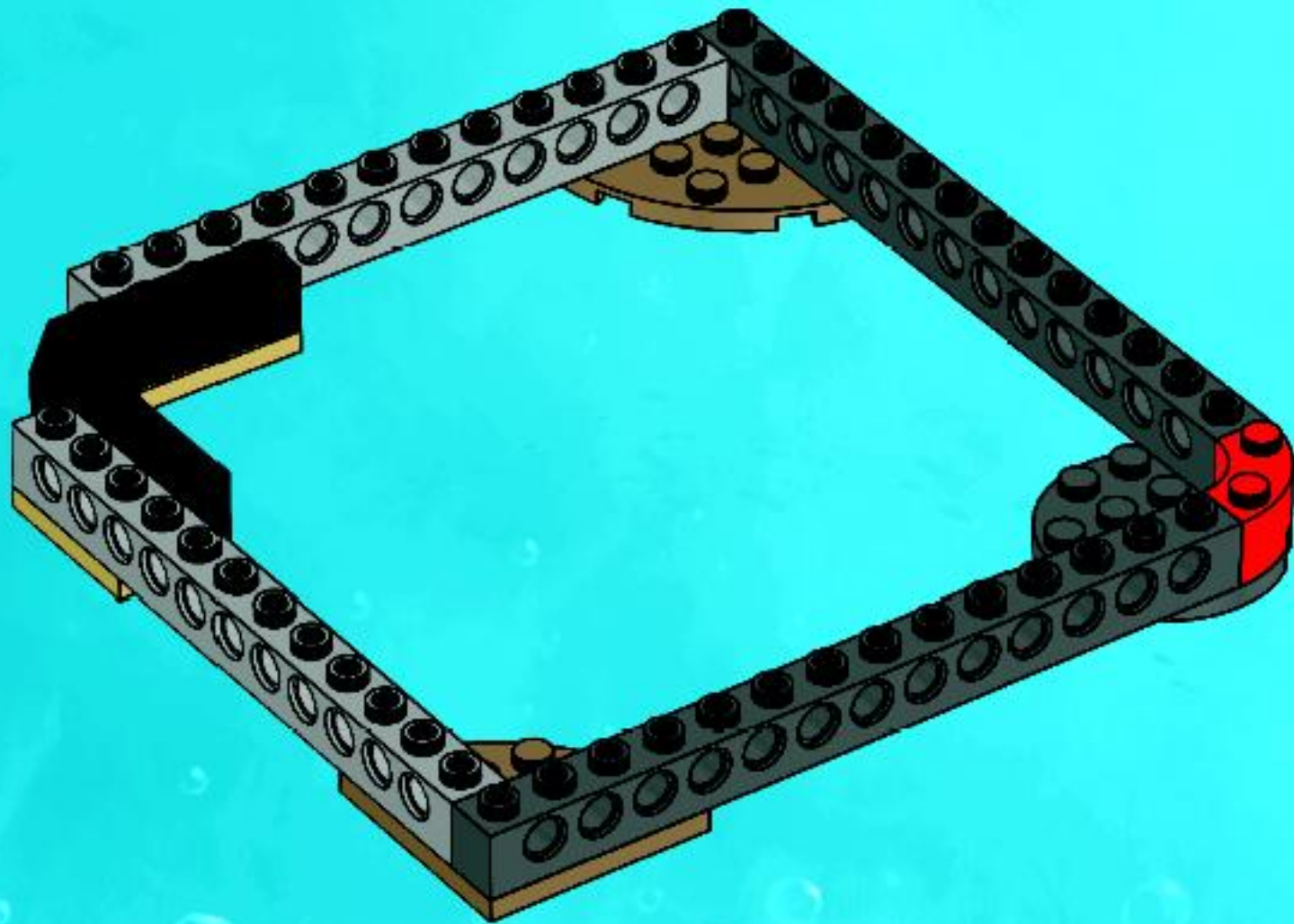



1x



3x

9

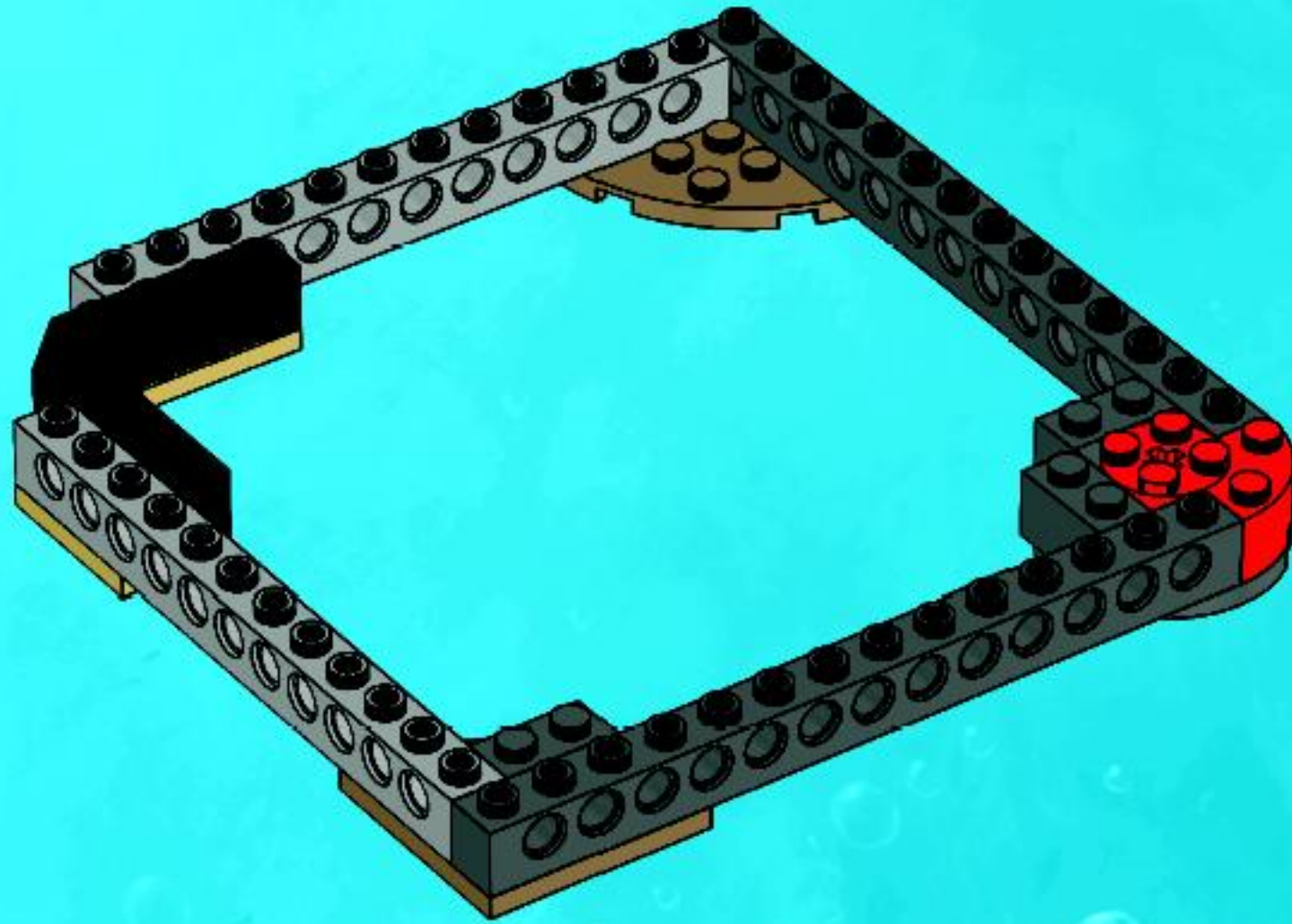

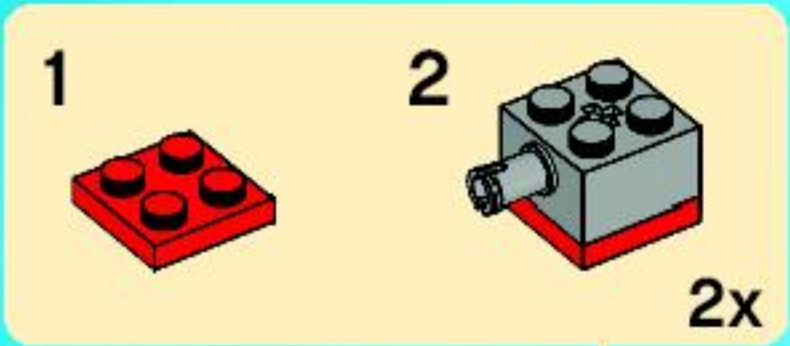

10

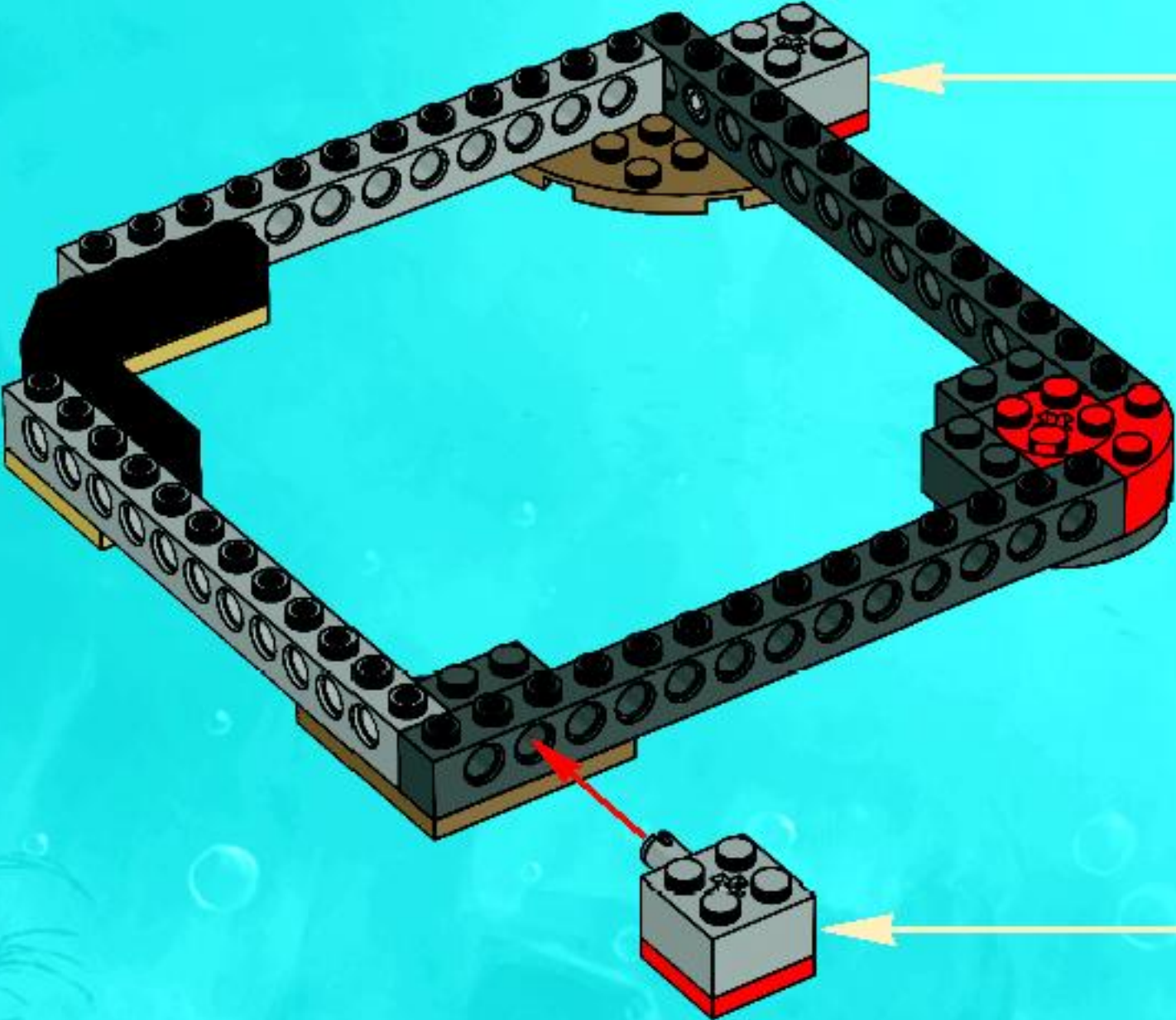



1x



1x

11

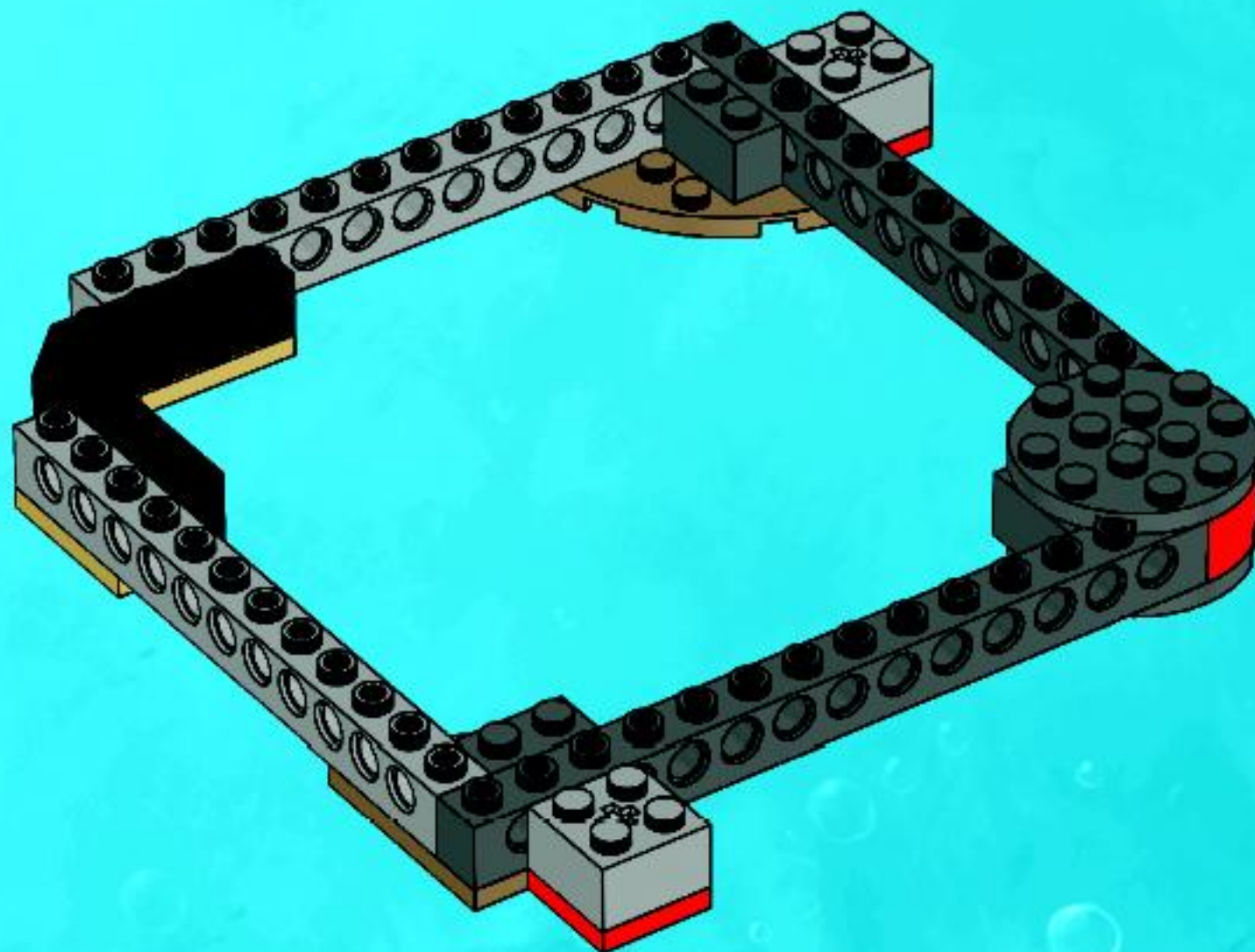

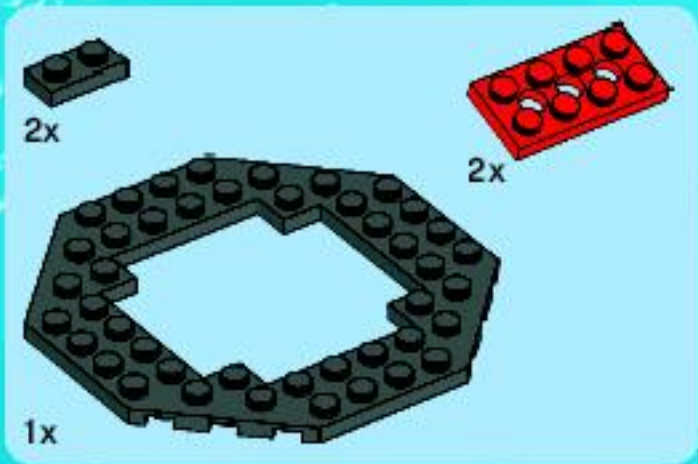

12

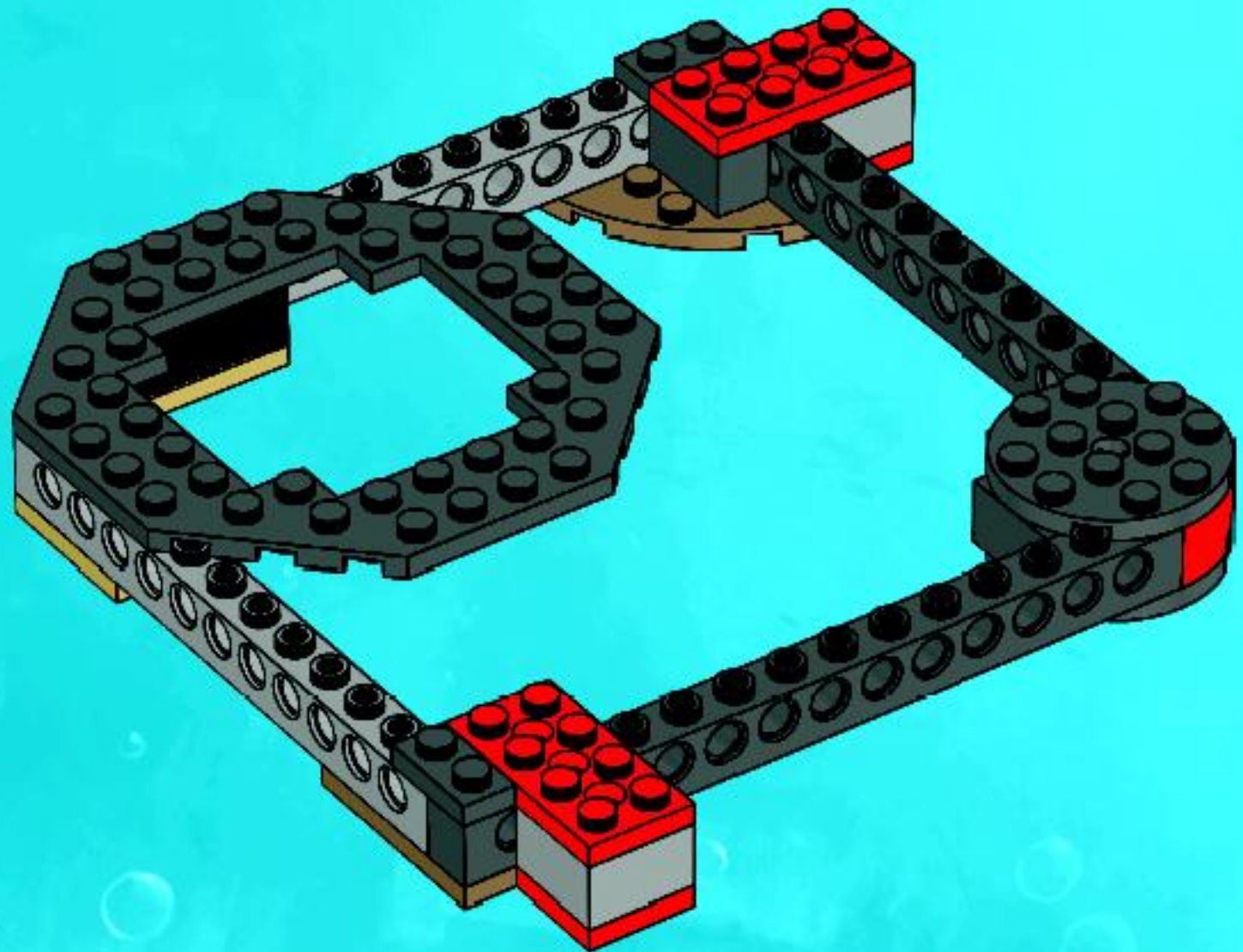



2x

13

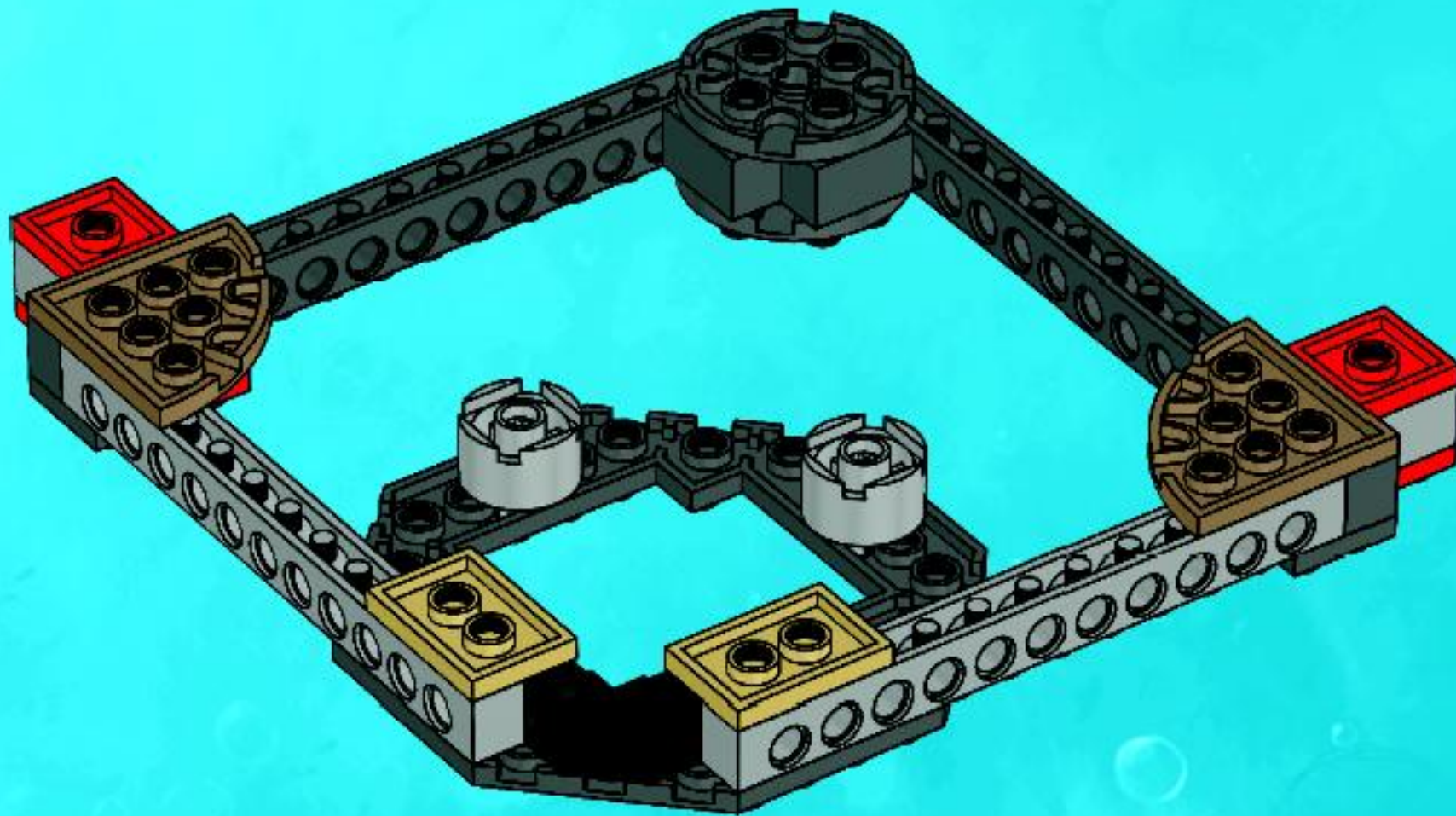



2x

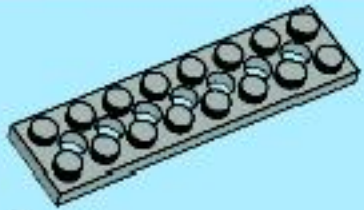

1x

14

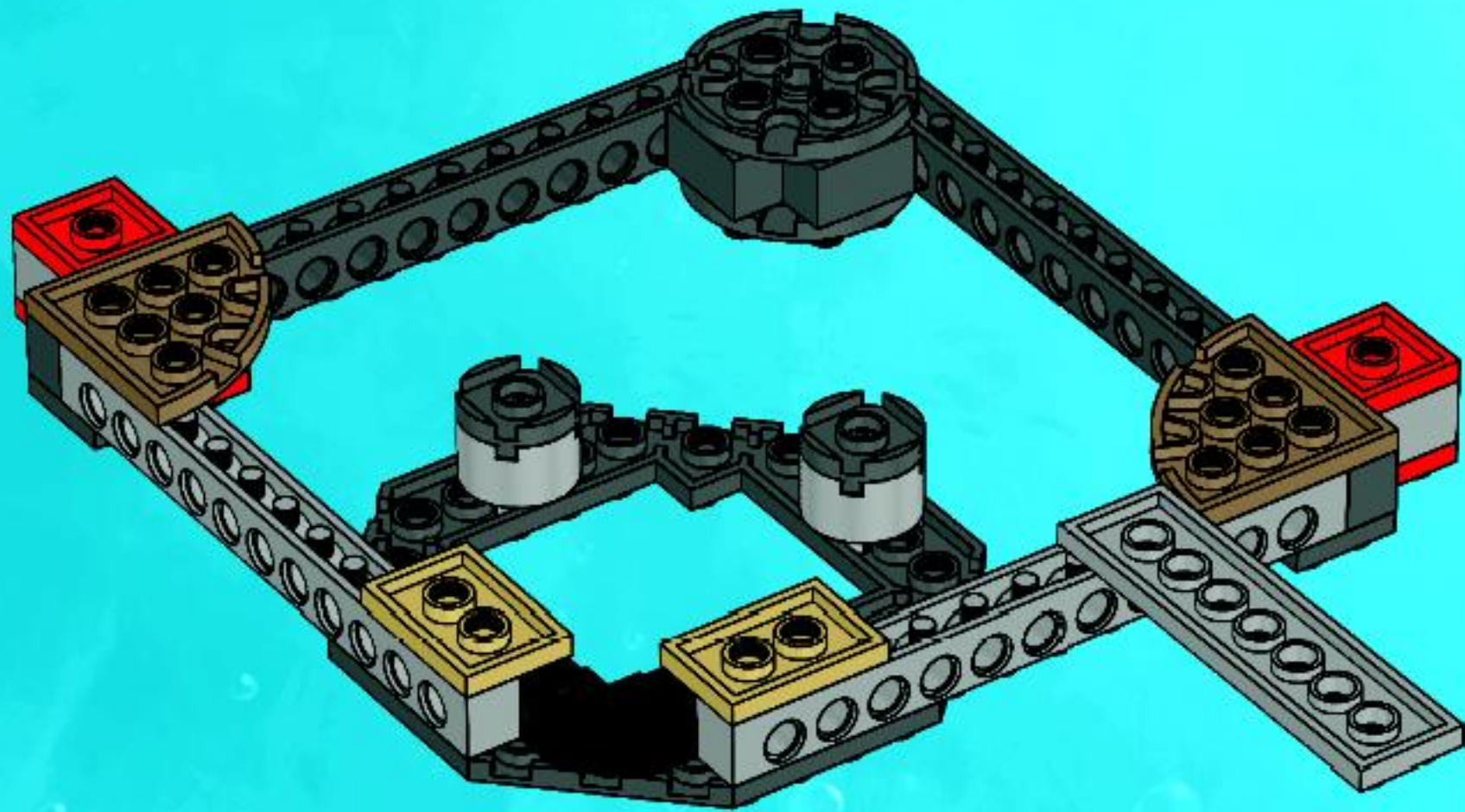



2x



3x

15

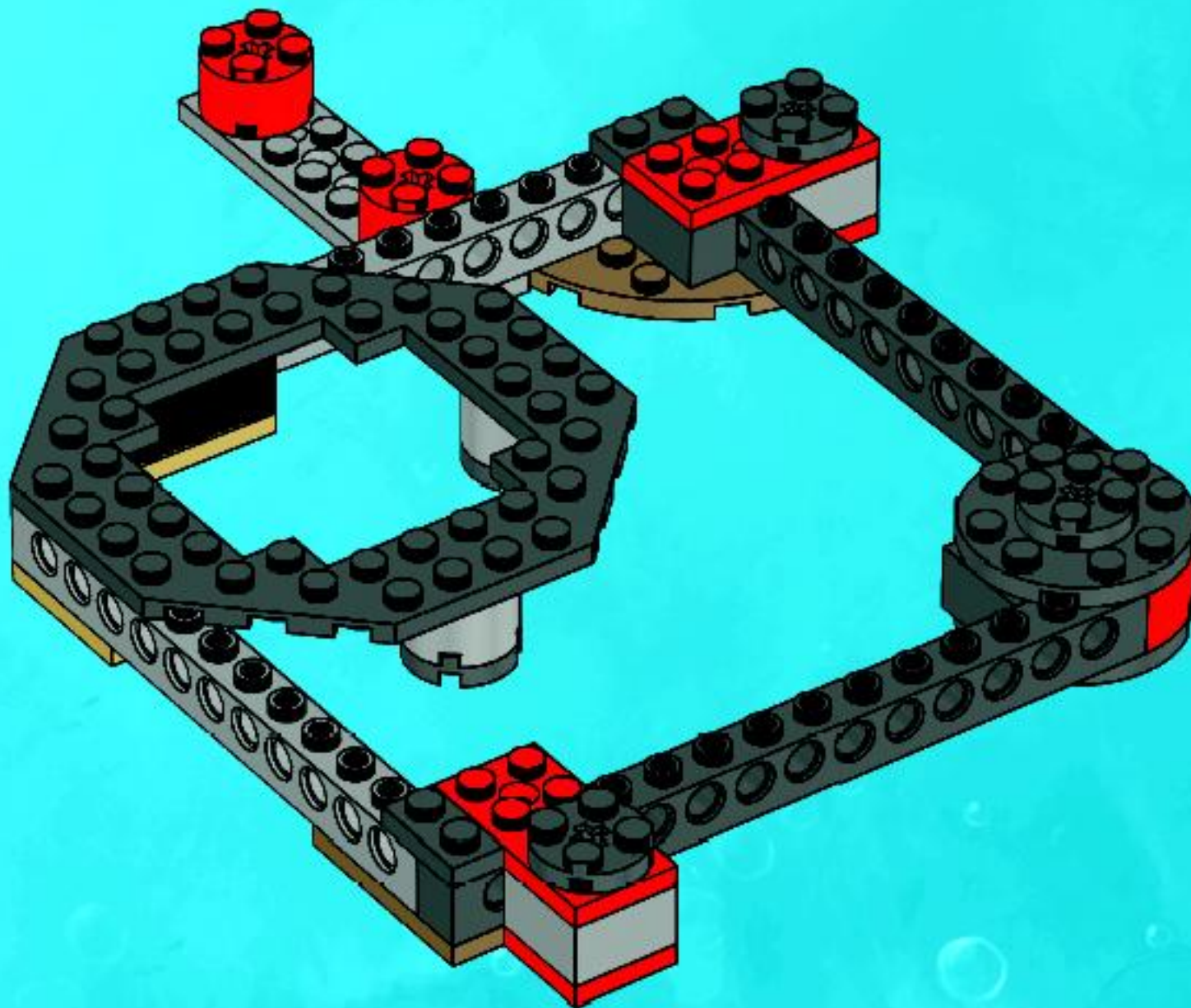

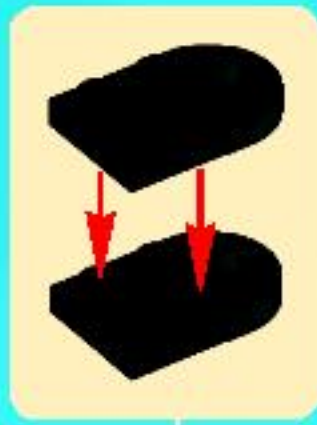
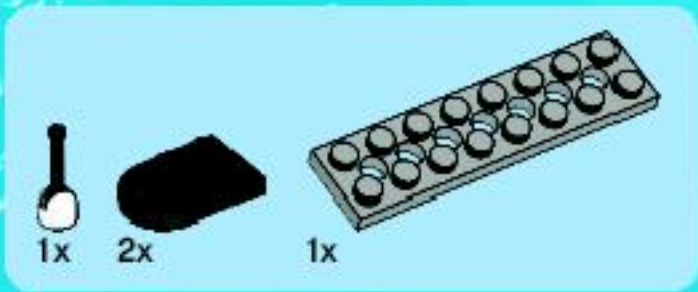

16

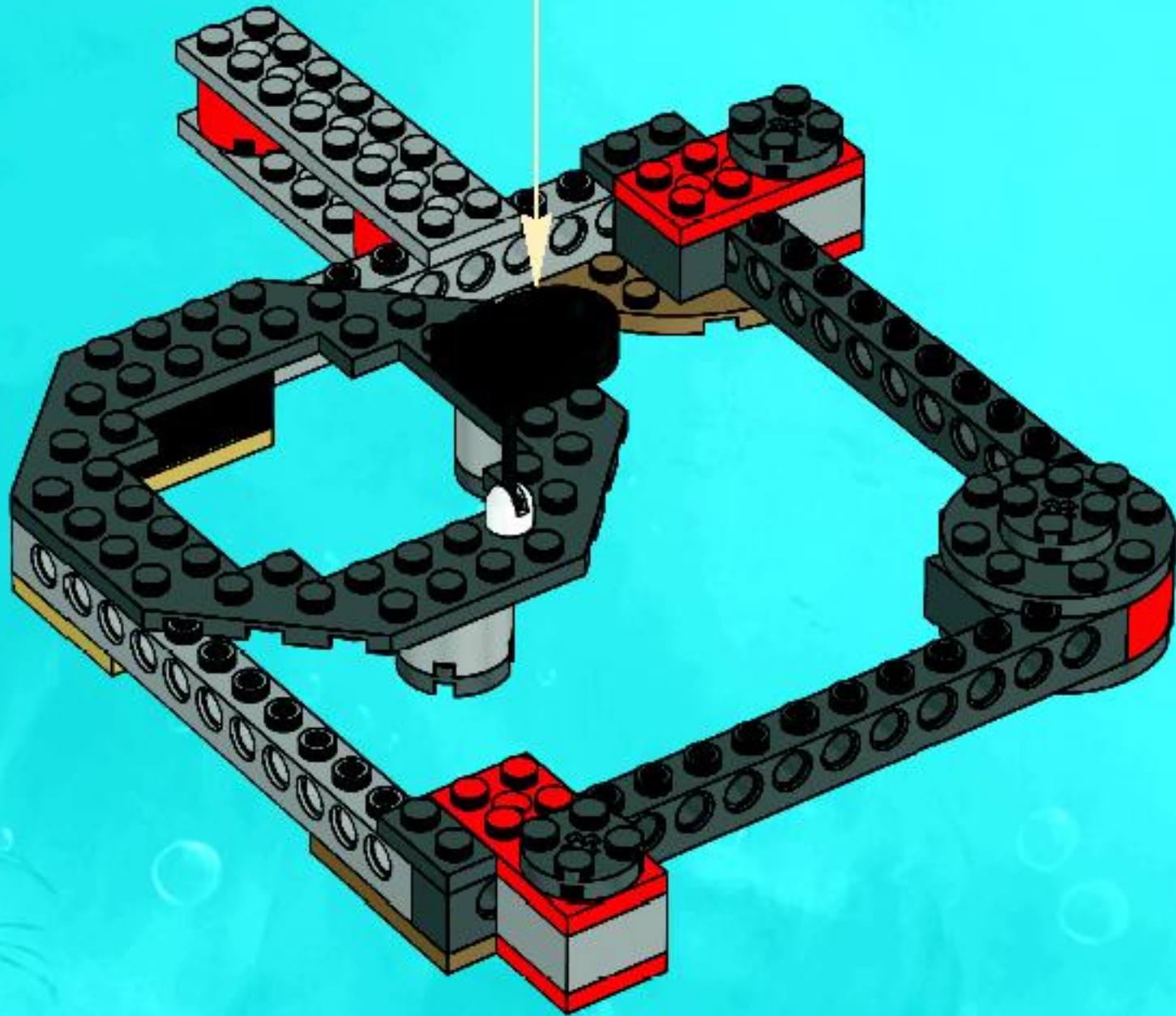



1x



1x

17

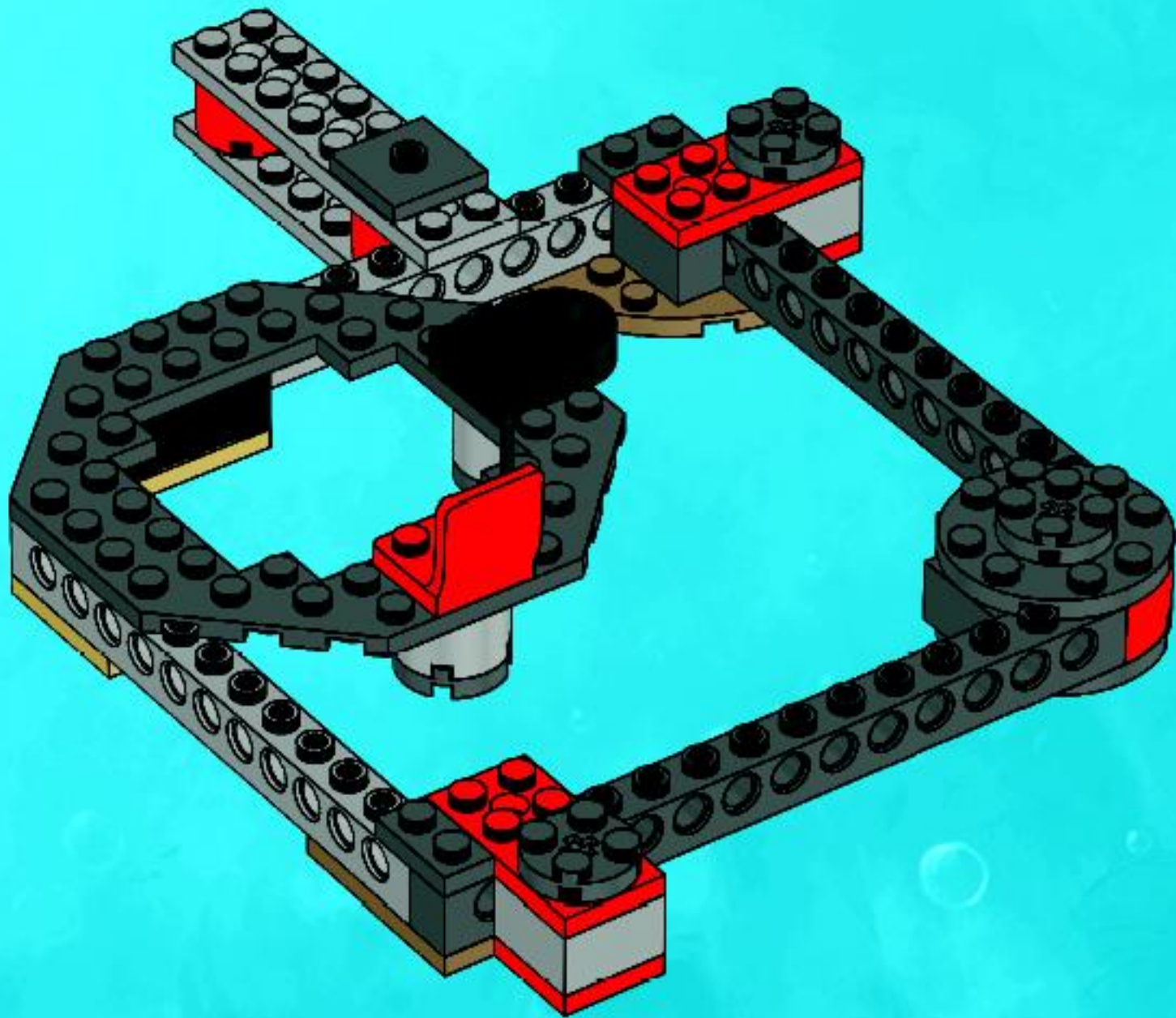

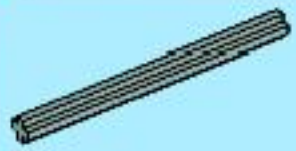

4x



1x



1x

18

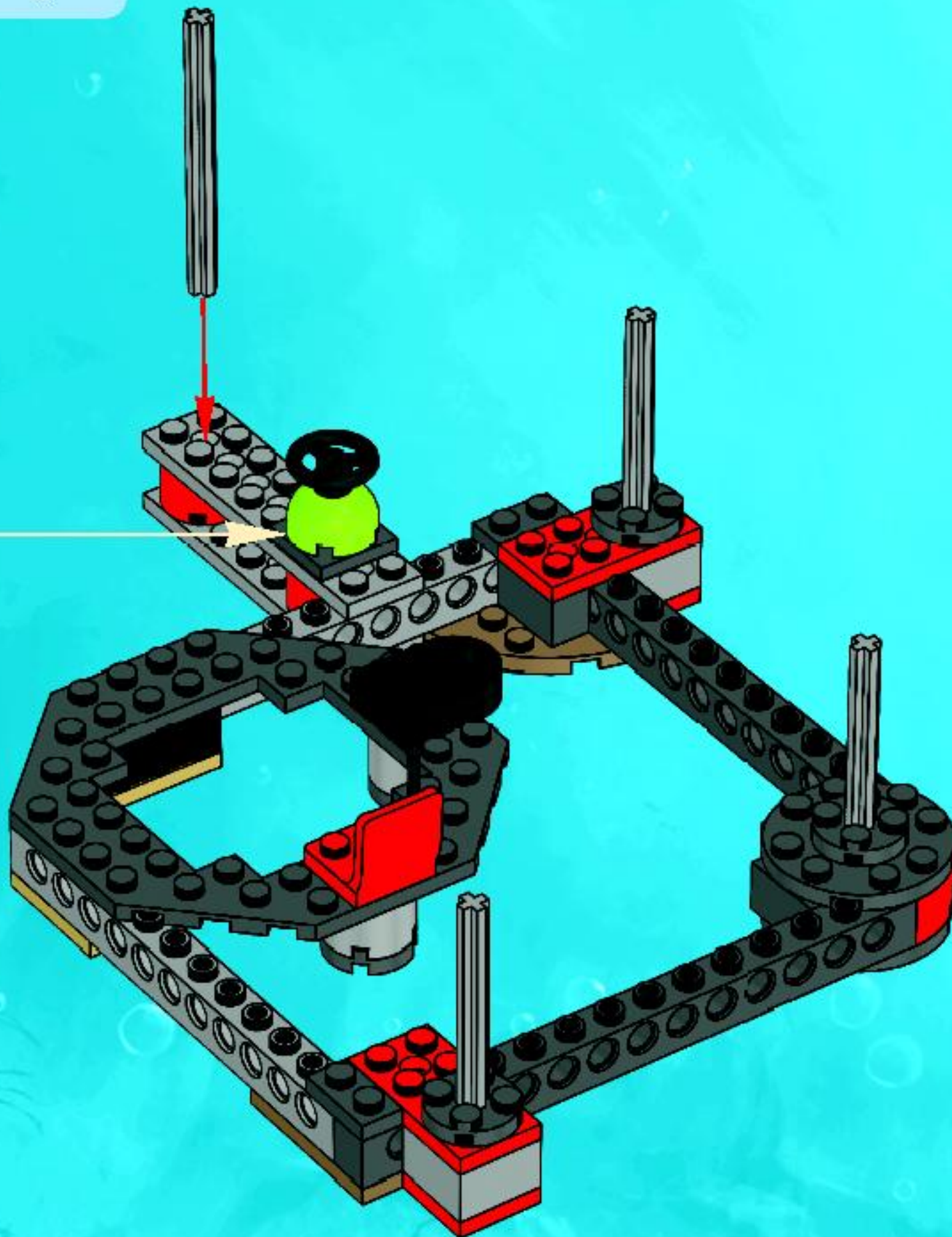



12x

19

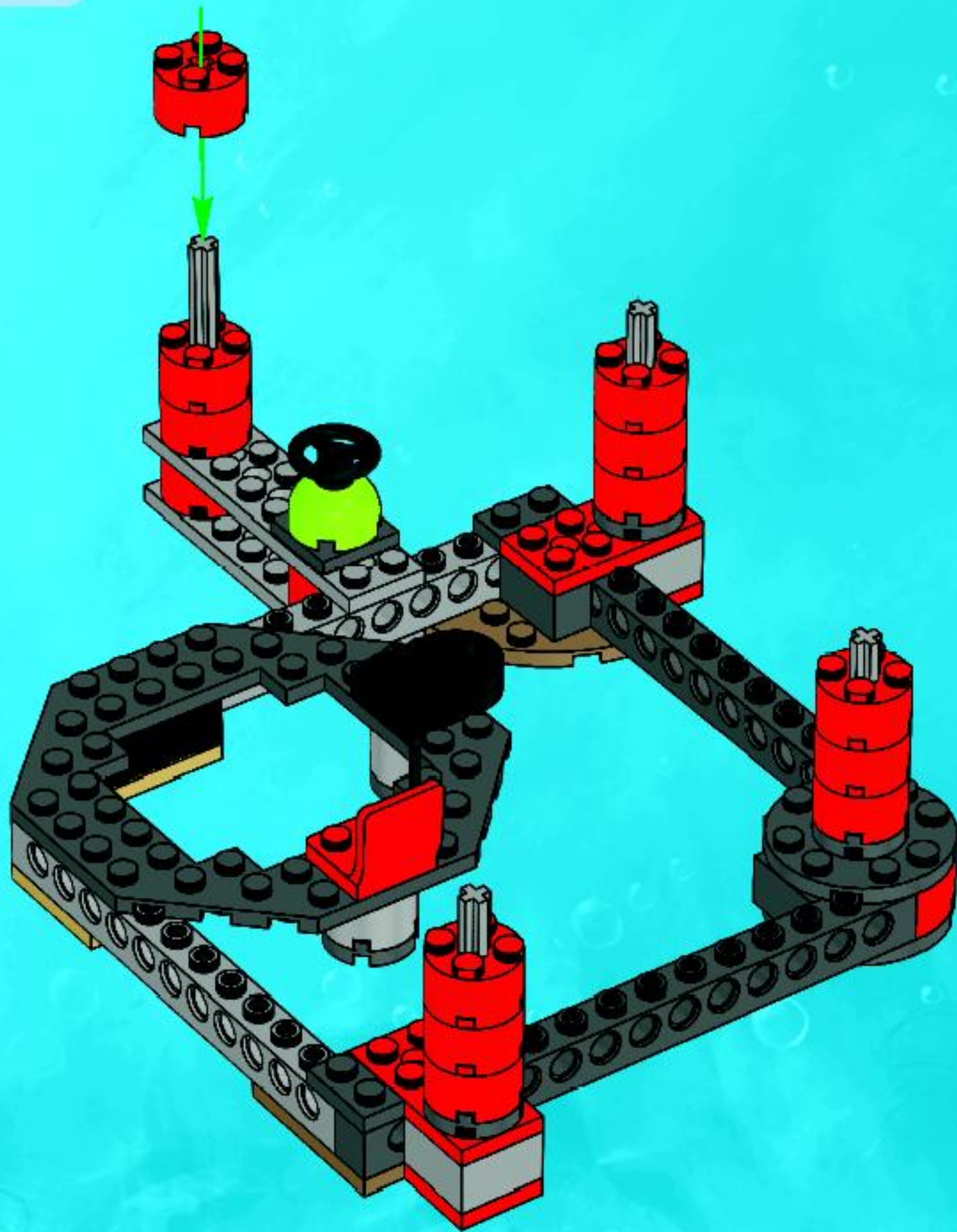



20

1

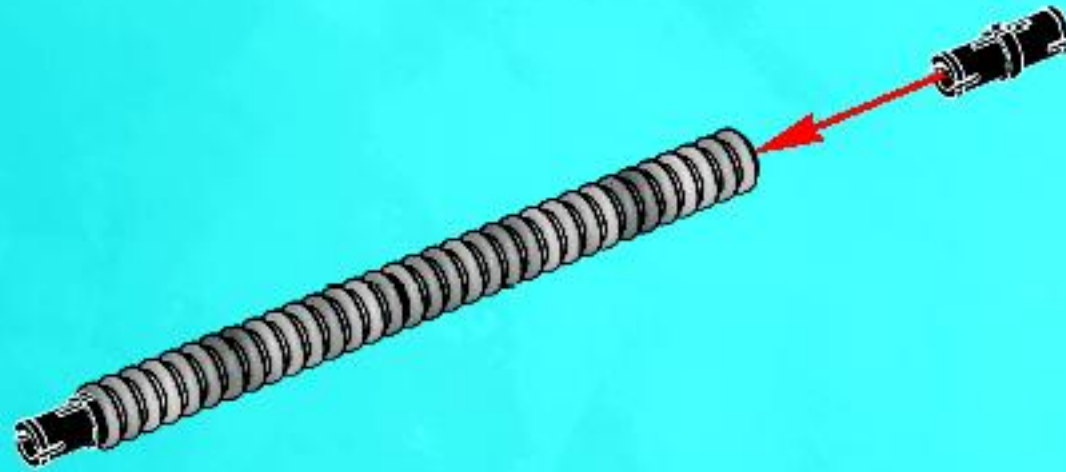

2

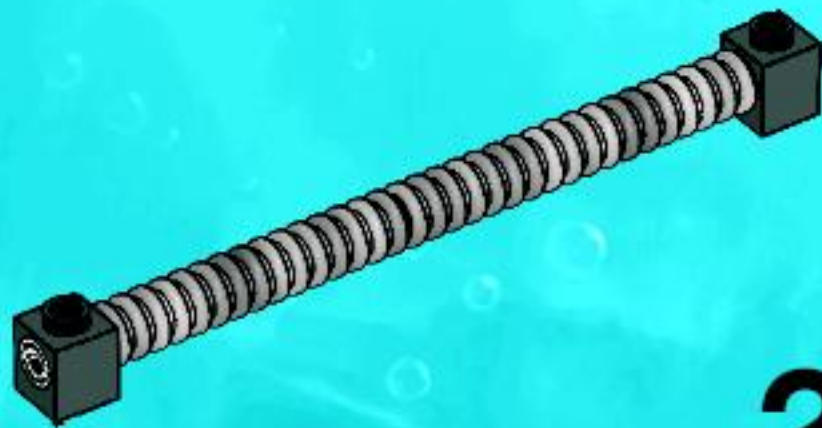

2x

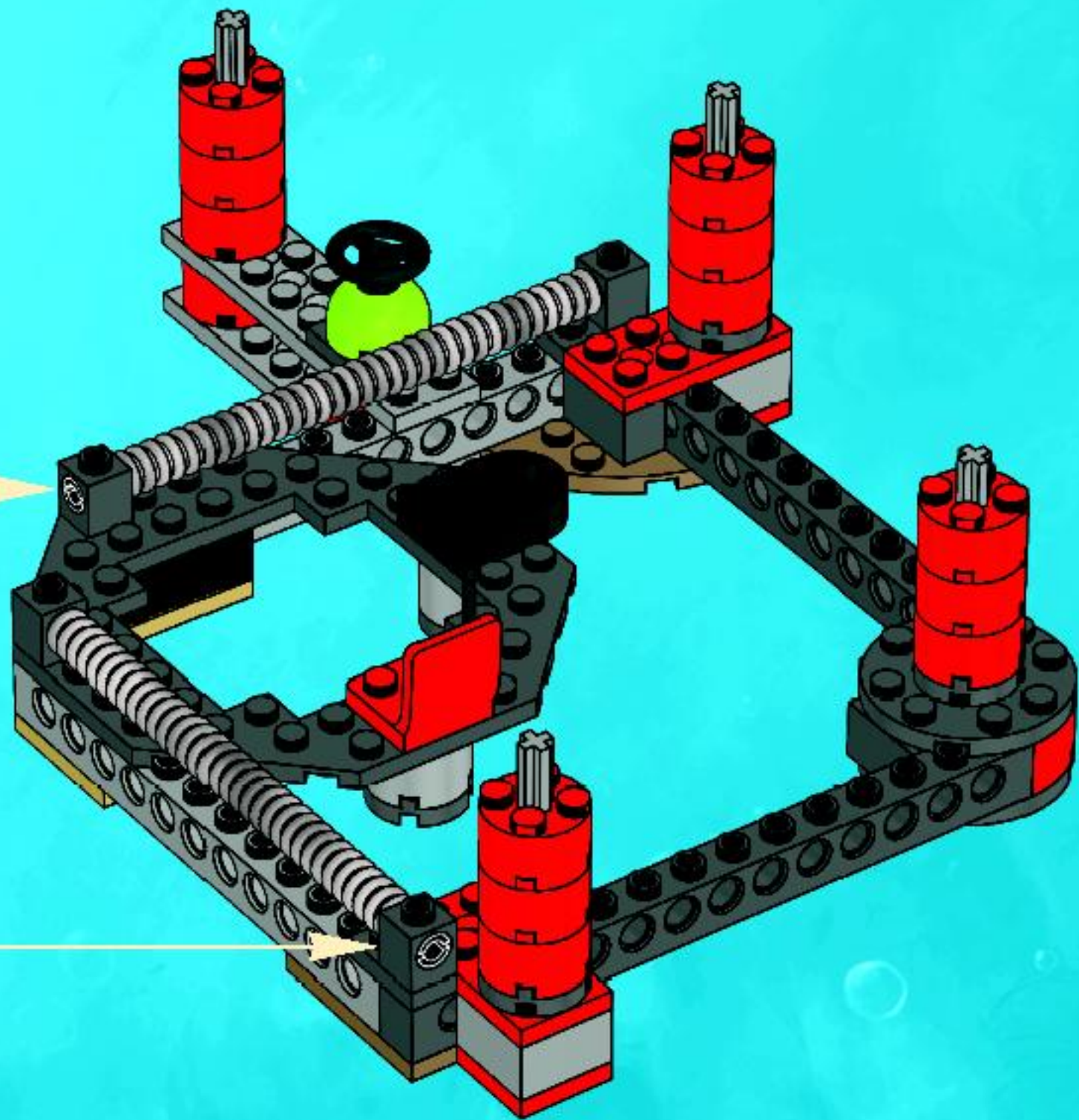

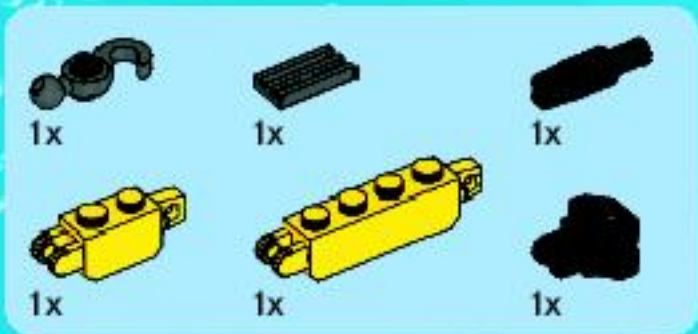

21

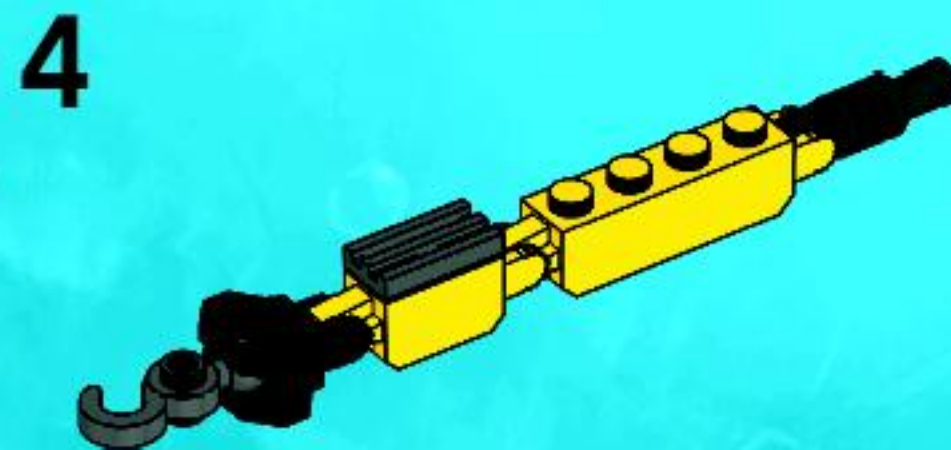
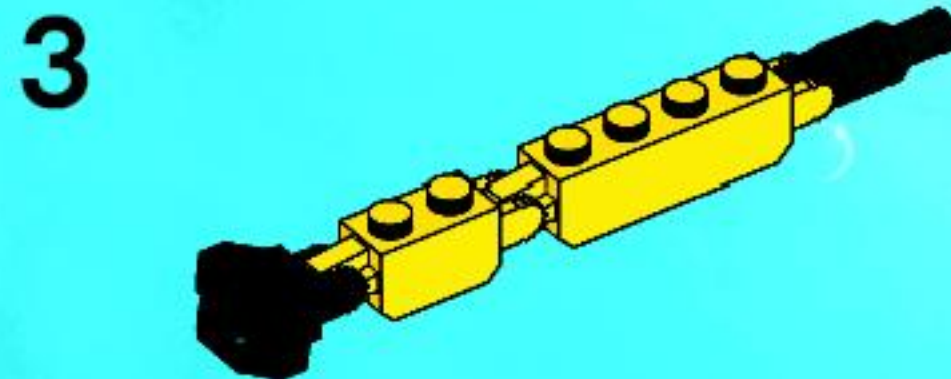
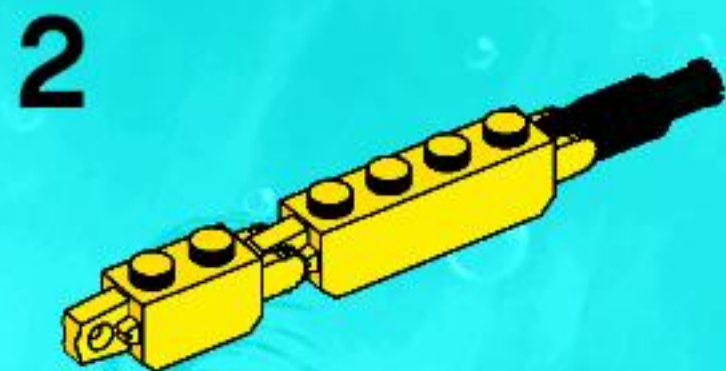
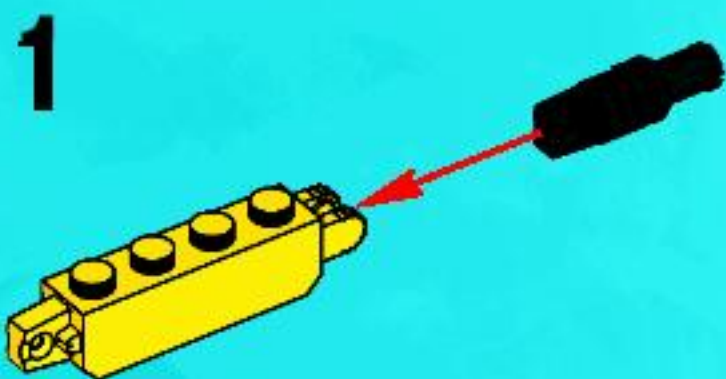

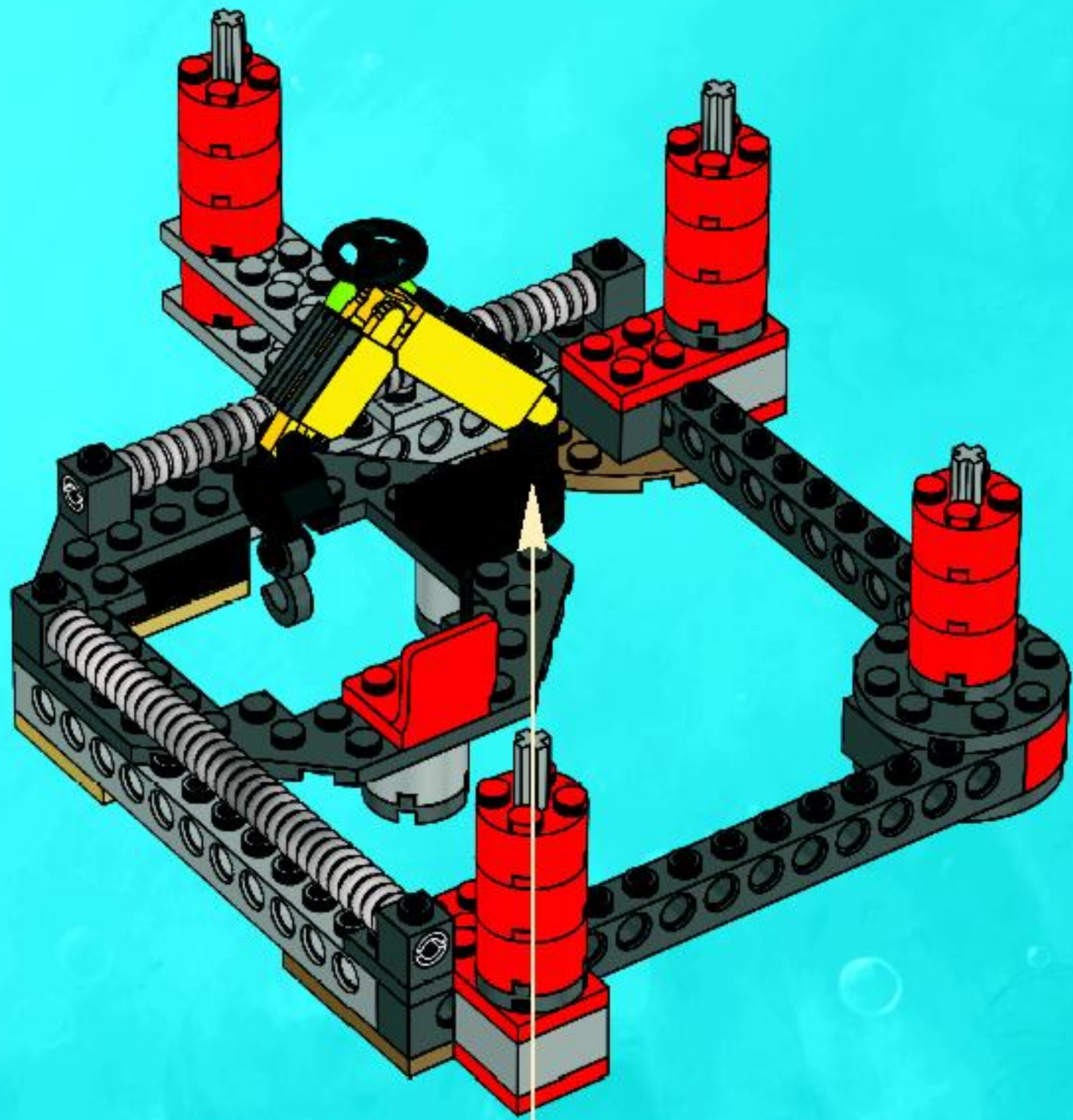



22

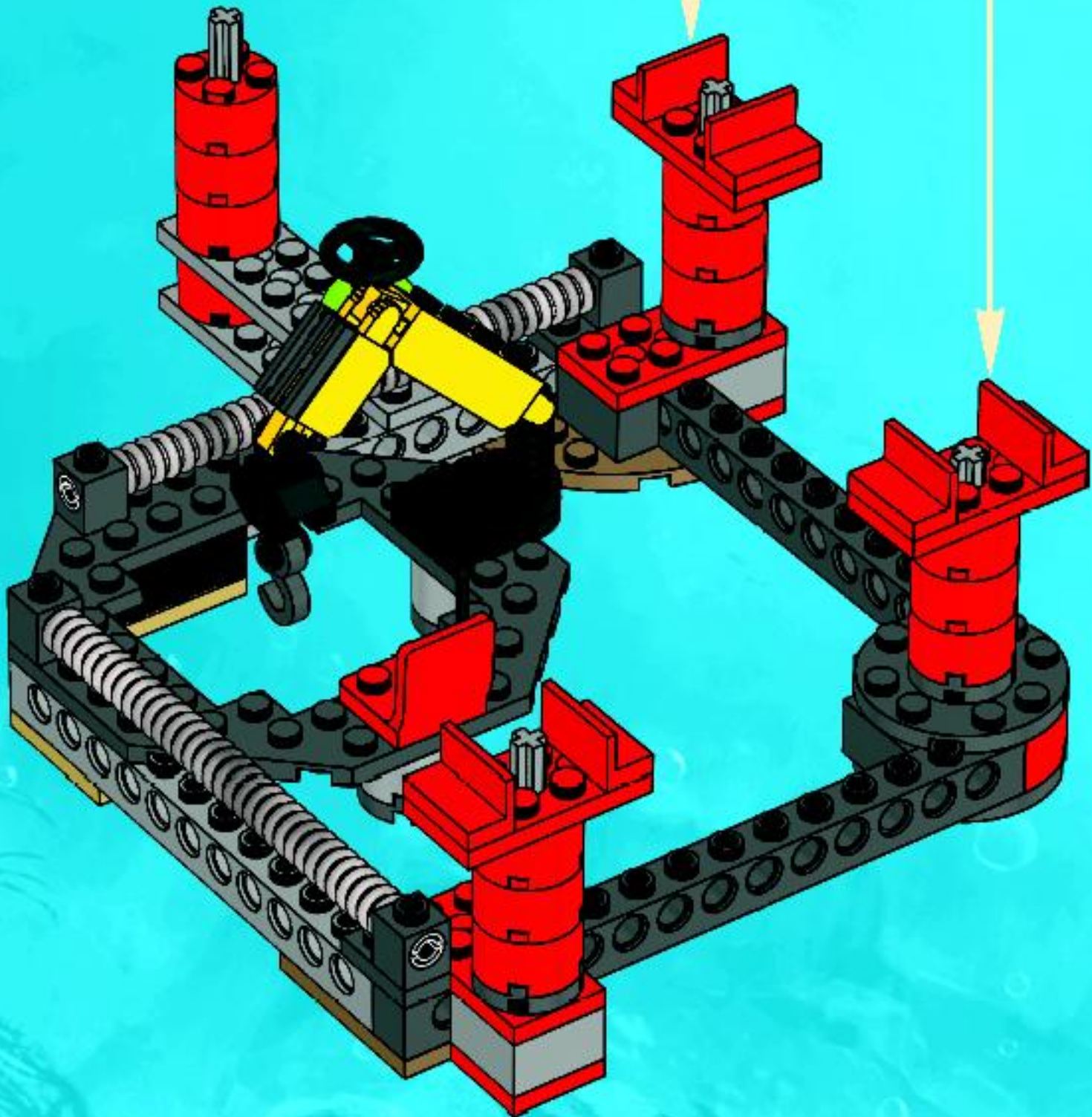
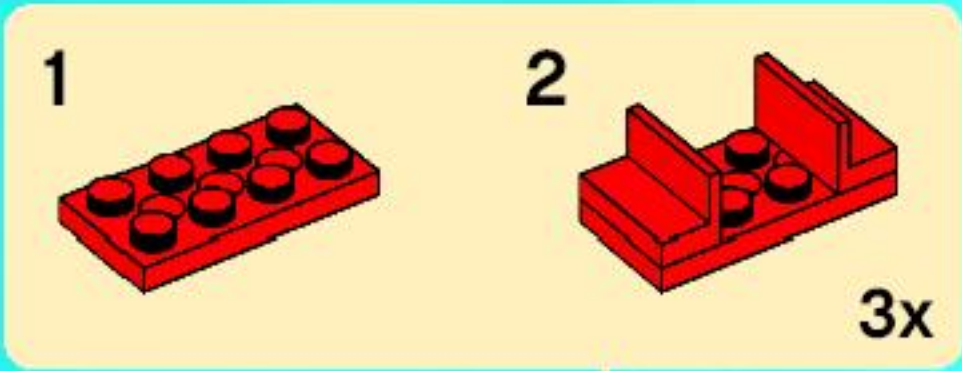

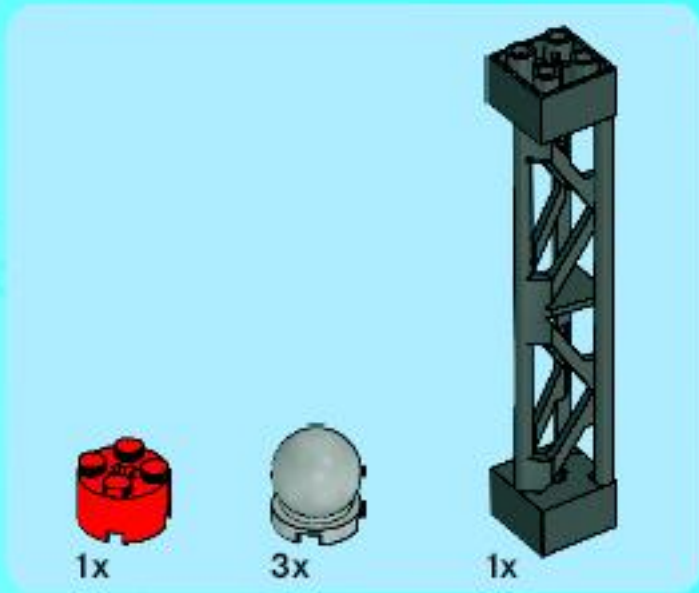

23

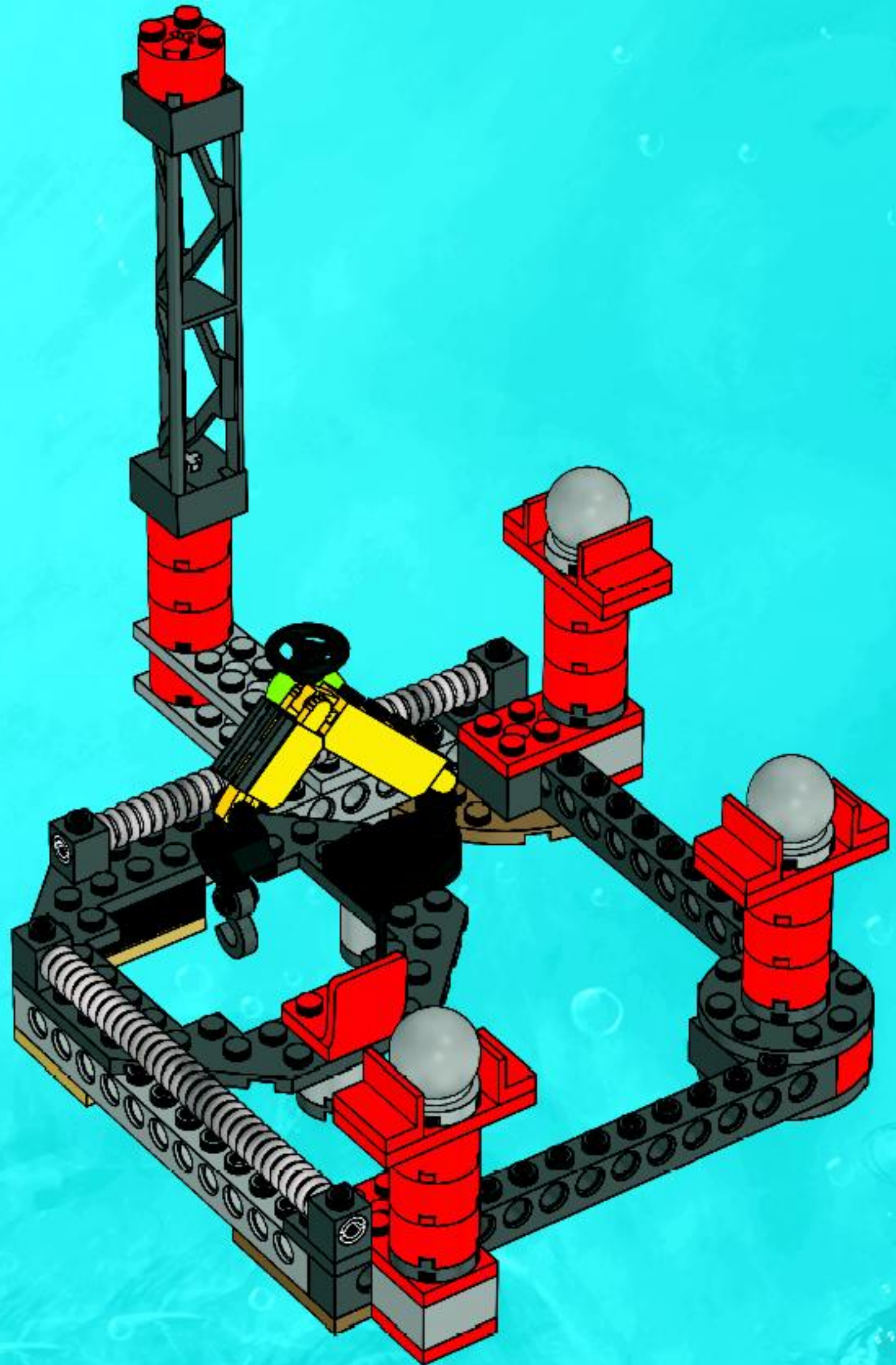

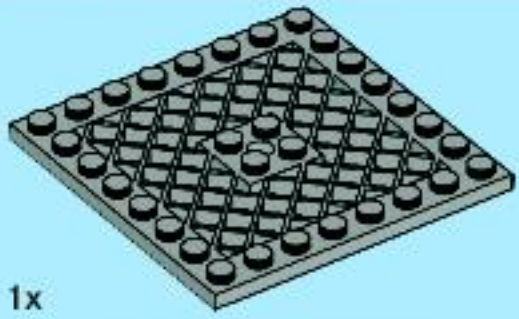

1x

24

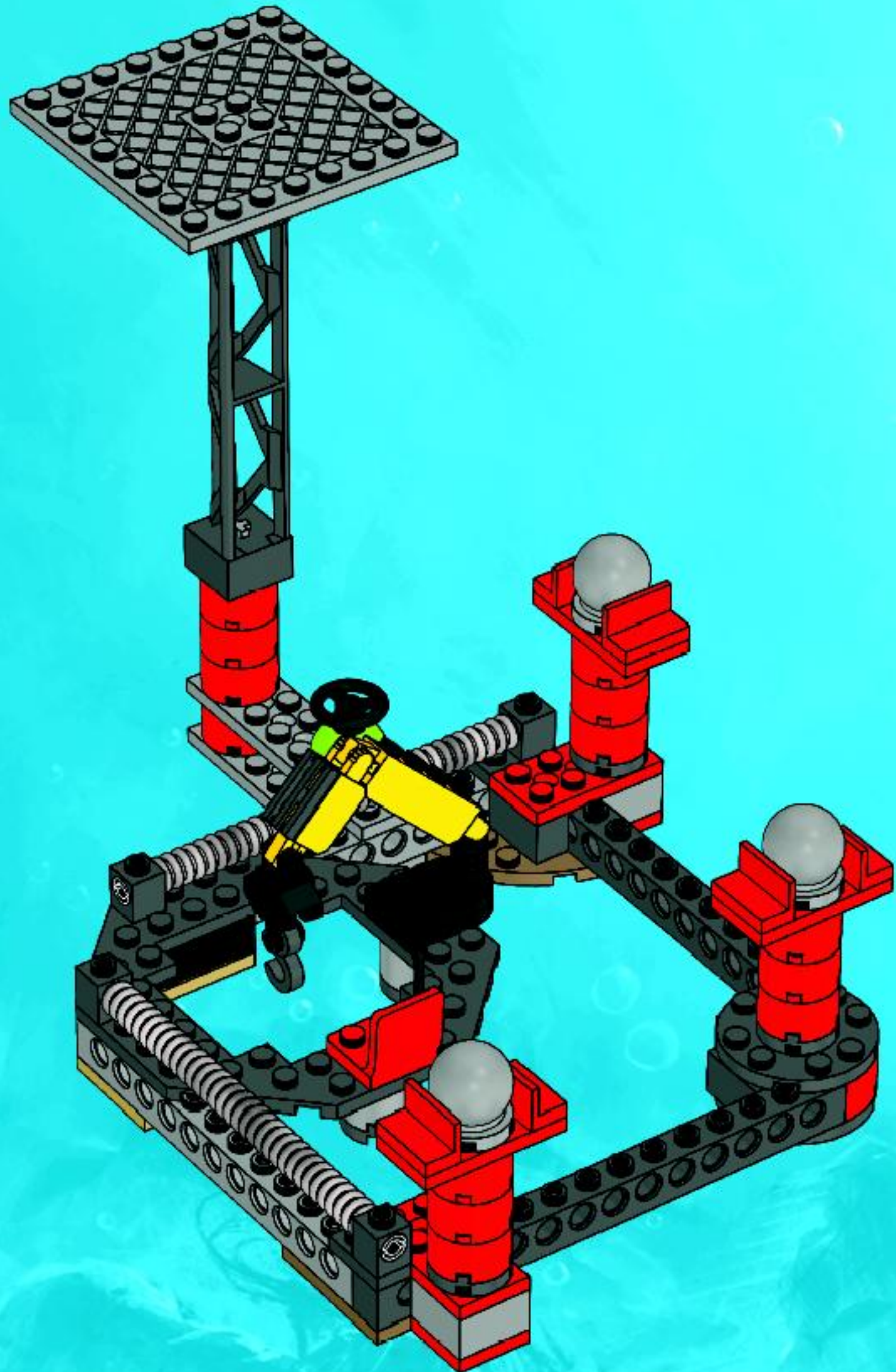



1x

25

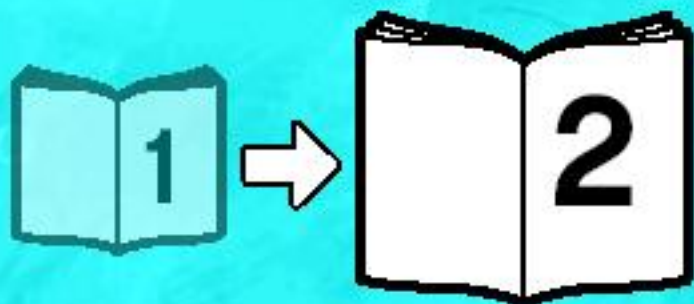
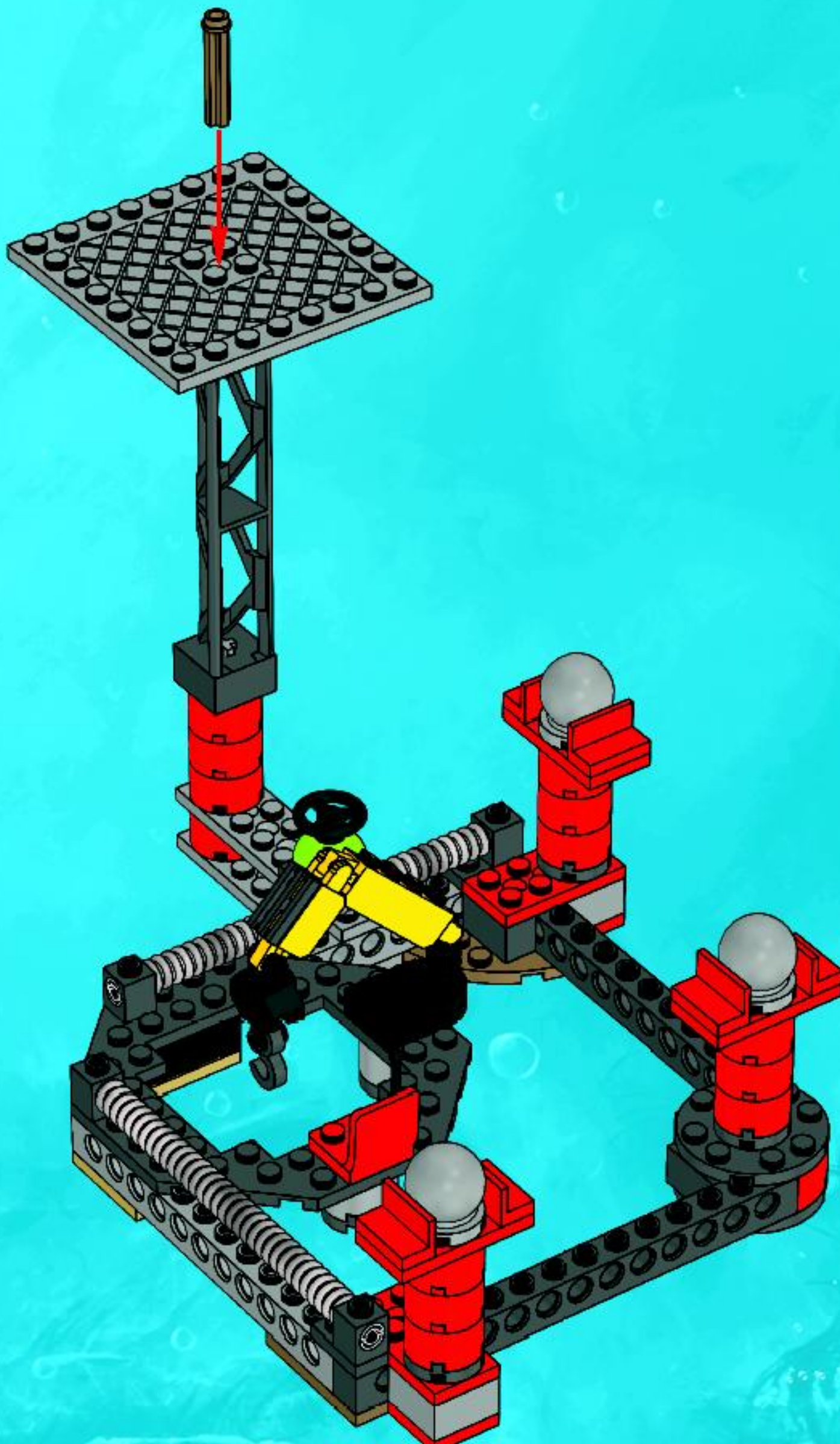

- 1x 4288083
- 1x 4261941
- 1x 4293350
- 3x 73737
- 4x 300521
- 10x 306221
- 1x 4567445
- 16x 614321
- 2x 4179355
- 2x 370021
- 2x 4540382
- 2x 4162826
- 8x 4520782
- 4x 4142865
- 5x 302321
- 3x 306921
- 3x 302221
- 4x 362321
- 6x 4580871
- 2x 371021
- 2x 4560179
- 2x 447721
- 4x 241221
- 2x 4556153
- 2x 4140585
- 2x 4226876
- 5x 370921
- 3x 407921
- 6x 486521
- 4x 4570494
- 2x 4144413
- 4x 4495933
- 2x 4525727
- 1x 4540822
- 1x 4541926
- 1x 4585203
- 2x 4118790
- 6x 4514554
- 1x 4140704
- 1x 4218728
- 2x 306824
- 1x 4570002
- 1x 4570003
- 1x 389924
- 2x 4100423
- 4x 614326
- 2x 370126
- 1x 4529549
- 2x 370226
- 2x 302226
- 2x 371026
- 1x 4277932
- 2x 317626
- 2x 4184617
- 4x 4140303
- 4x 4223247
- 4x 4287672
- 1x 4501975
- 4x 4153044
- 4x 4288241
- 1x 4144567
- 1x 4159335
- 1x 368026
- 23x 4121715
- 4x 4278412
- 1x 4244363
- 1x 3005741
- 1x 4570662
- 1x 4244573
- 1x 3005748
- 4x 4279734
- 1x 4537937
- 2x 4569900
- 1x 4162916
- 1x 4570523
- 1x 4563655
- 4x 4143005
- 8x 4206482
- 2x 4514553
- 4x 4294997
- 1x 4567461
- 4x 4211460
- 4x 4211461
- 6x 4211529
- 2x 4211526
- 3x 4295035
- 6x 4211614
- 6x 4217918
- 2x 4541978
- 6x 4211477
- 1x 4211451
- 6x 4211398
- 1x 4540203
- 1x 4211840

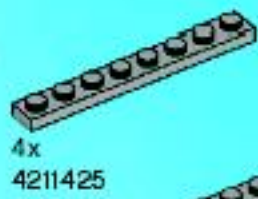

4x
4211425

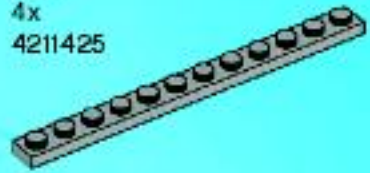

2x
4514846

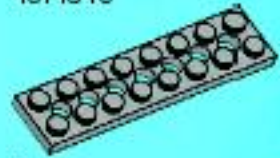

2x
4211449

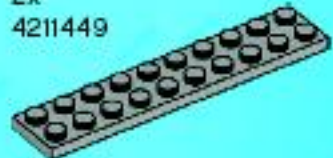

2x
4211462

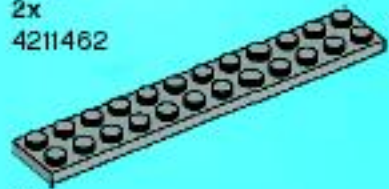

2x
4211360



2x
4211404



2x
4211408



1x
4221602

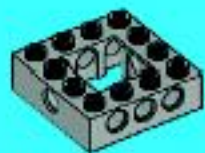

3x
4211640



2x
4211374

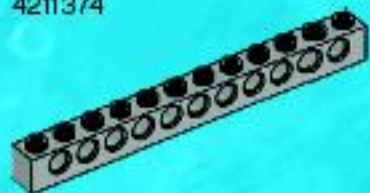

2x
4211860



4x
4211503



1x
4258308



2x
4520320



1x
4211807



4x
4211553

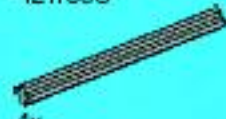

4x
4211805



1x
4566927



2x
4570451



6x
4210639



14x
4211088



4x
4210978



3x
4211060



2x
4211109



2x
4211104



1x
4509668



2x
4211024



2x
4210798

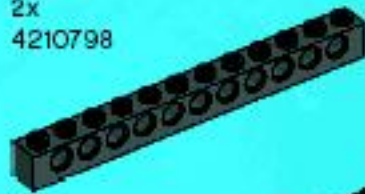

4x
4210963



2x
4211137



4x
4540386



4x
4500975



2x
4211045



2x
4211052



6x
4211069



1x
4587212



2x
4260885



4x
4211119



1x
4210631



1x
4210660



2x
4210883



2x
4210884



3x
4211063



2x
4565322



5x
4211094



2x
4211065



4x
4211056



1x
4211002



1x
4257526



2x
4210678



6x
4211042



2x
4528323



2x
4533334



2x
4568036



2x
4570036



2x
4563473



1x
4212529



4x
4211066



4x
4210658



1x
4296512



2x
4495208



1x
4563483



6x
4580872



2x
4570738



2x
4570481



1x
4581140



2x
4267358



1x
4539486



2x
4495208



Customer Service

Kundenservice

Service Consommateurs

Servicio Al Consumidor

www.lego.com/service or dial



: 00800 5346 5555

: 1-800-422-5346

Atlantis.LEGO.com



©2010 The LEGO Group. 4598438





ATLANTIS

8077



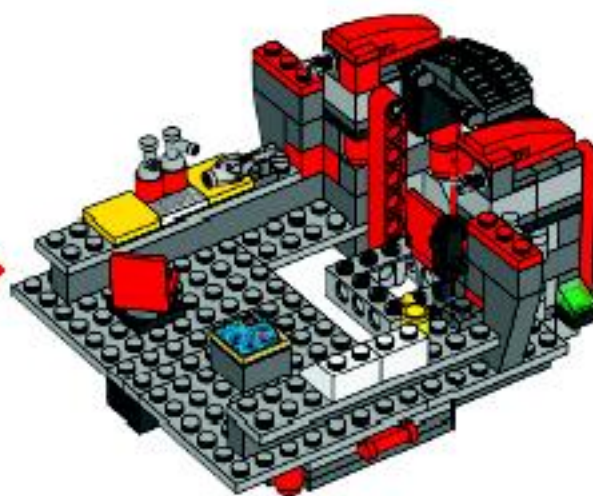
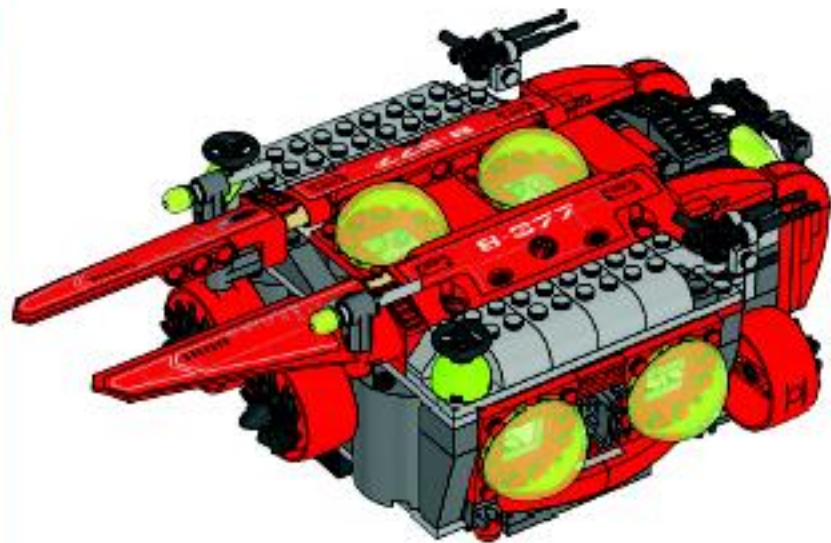

1x



1x

1

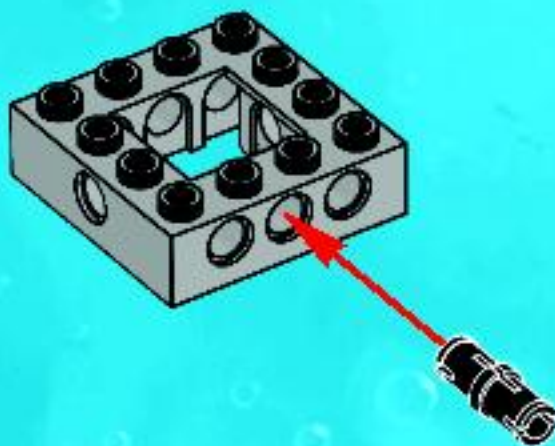

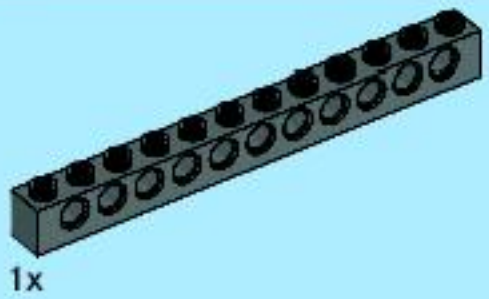

2



3

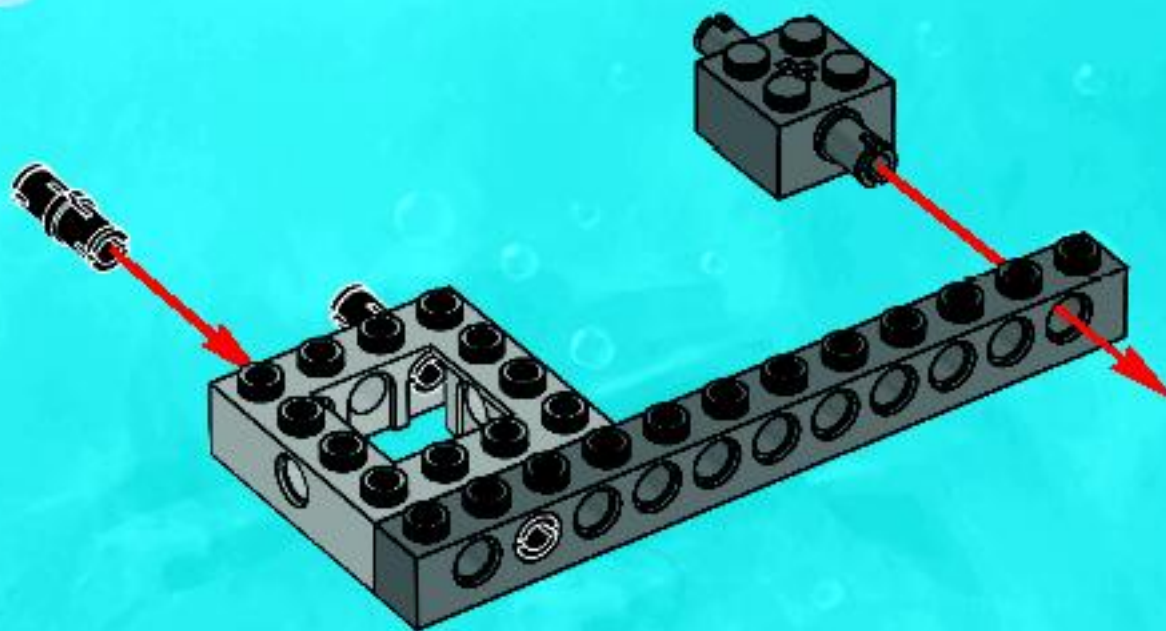



1x



1x

4

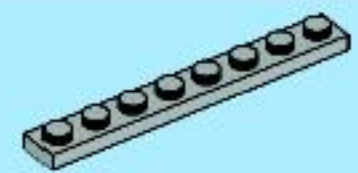
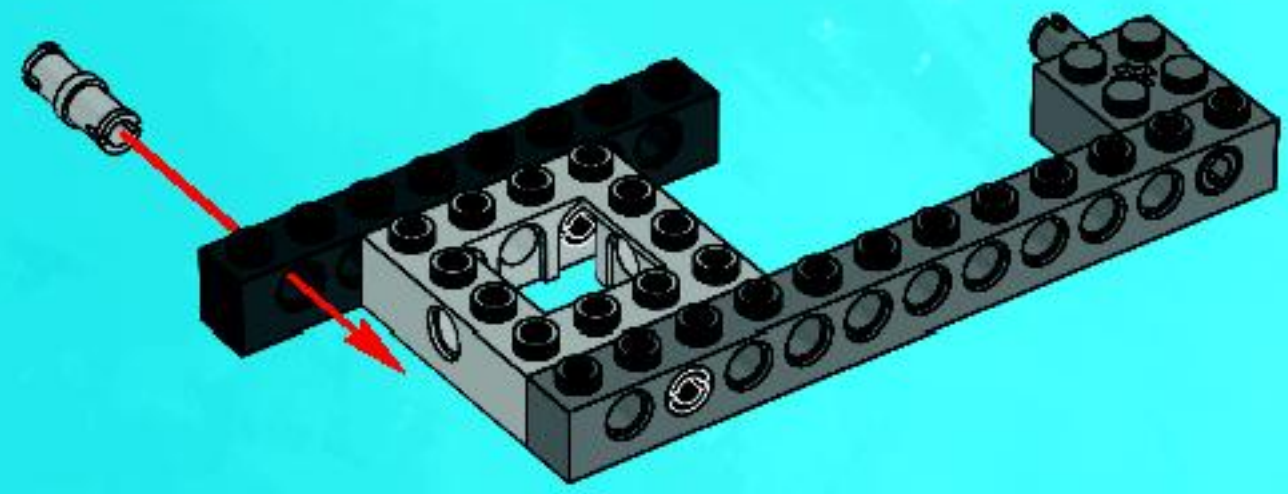

1x

5

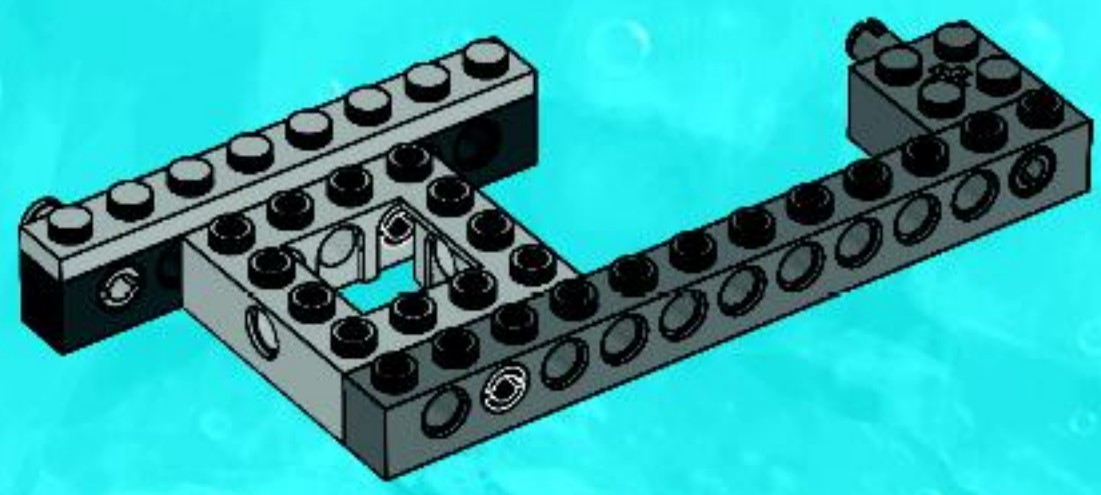

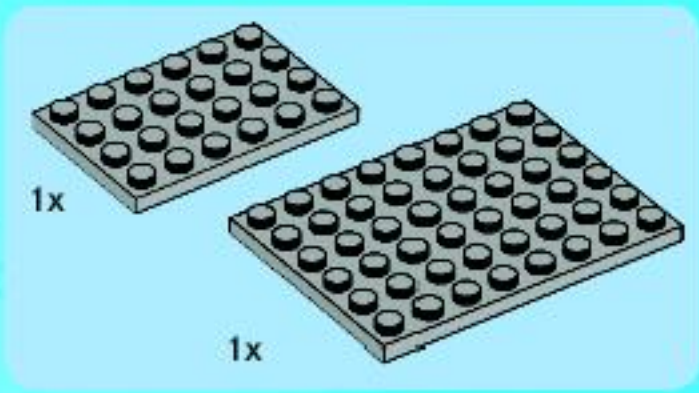

6

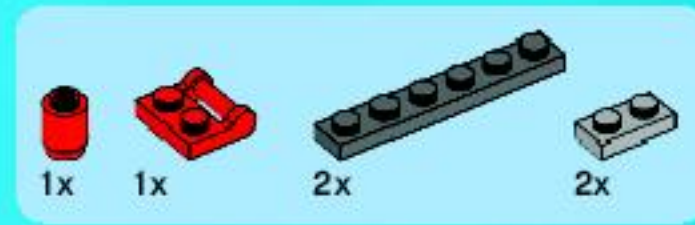
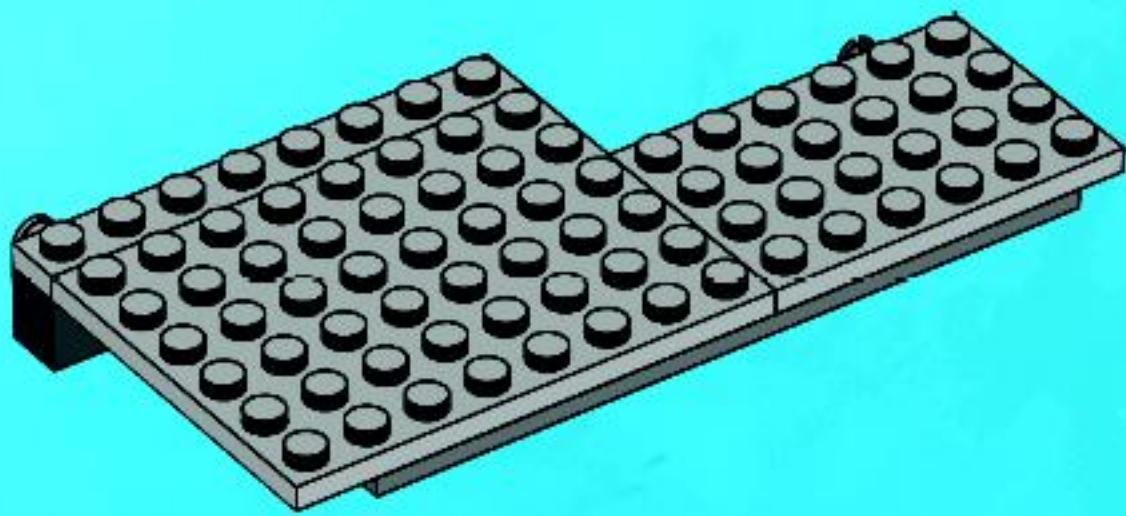

7

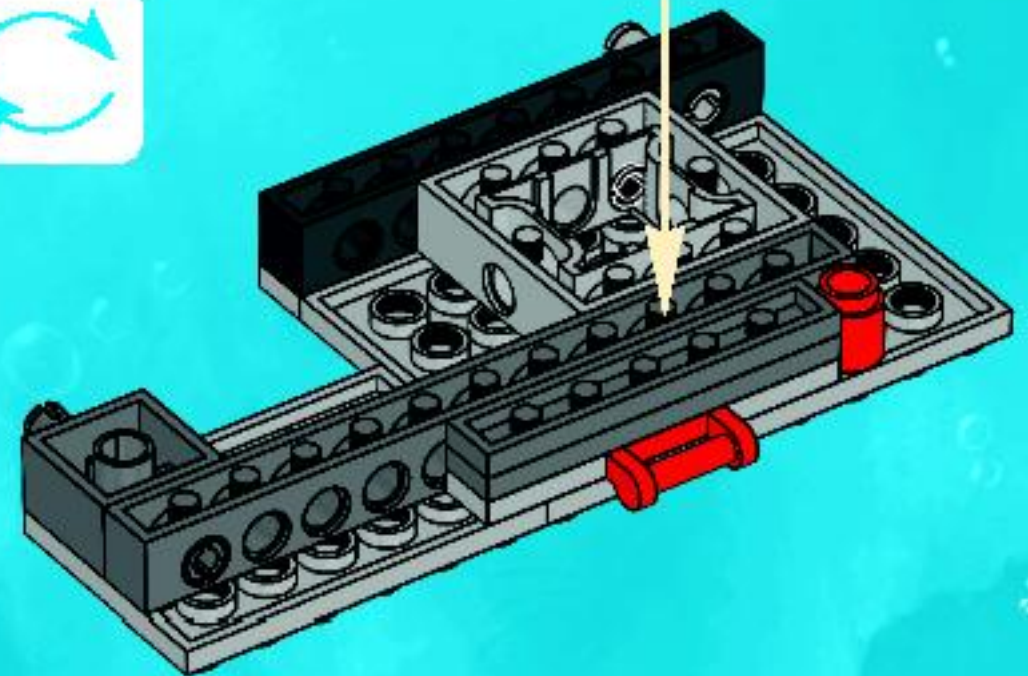
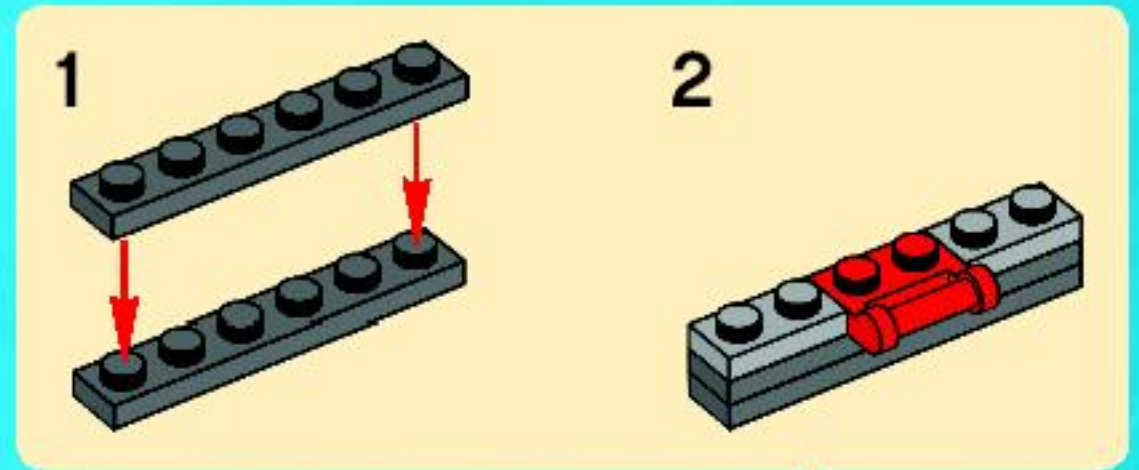

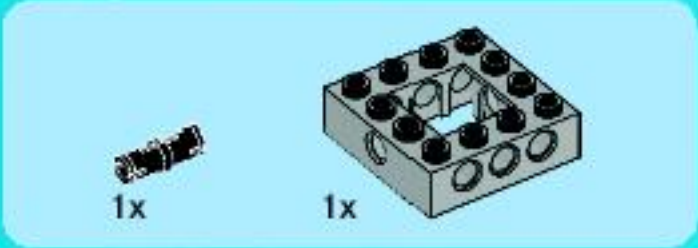

1

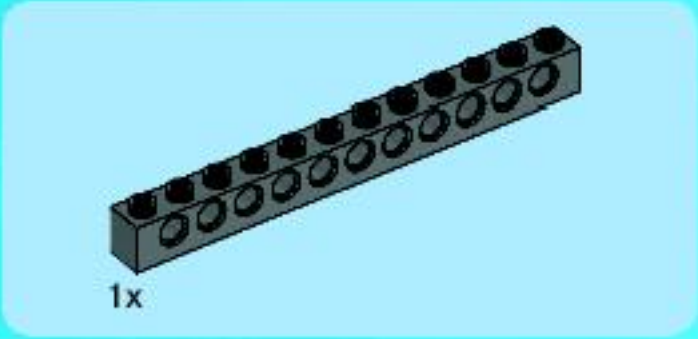
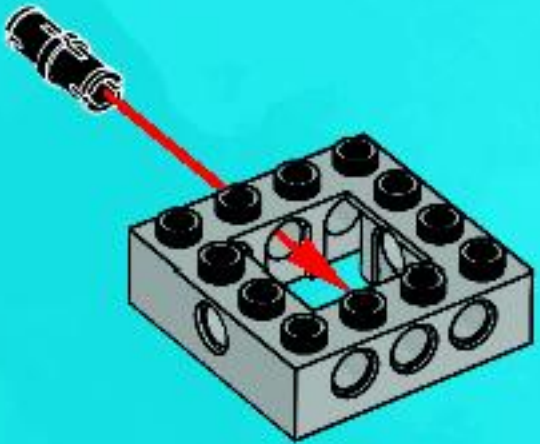

2

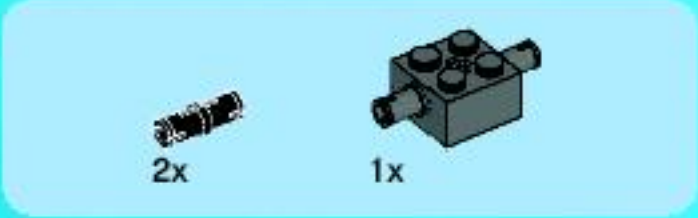
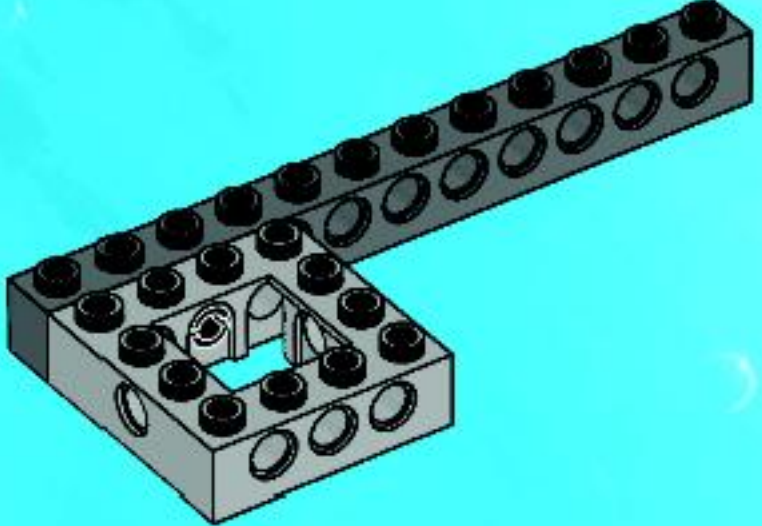

3

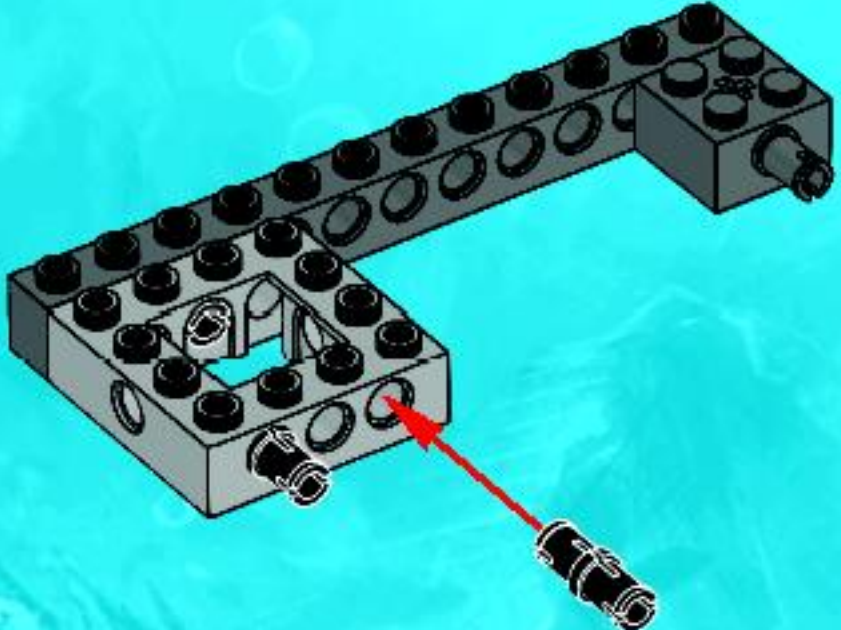



1x

4

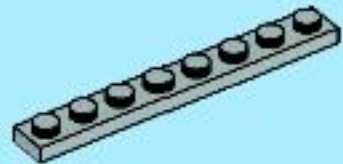
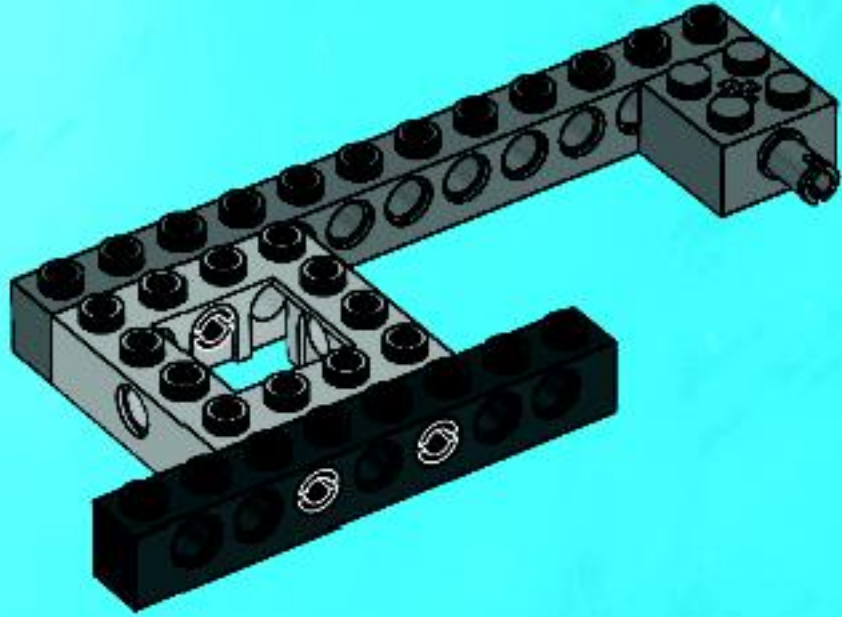

1x

5

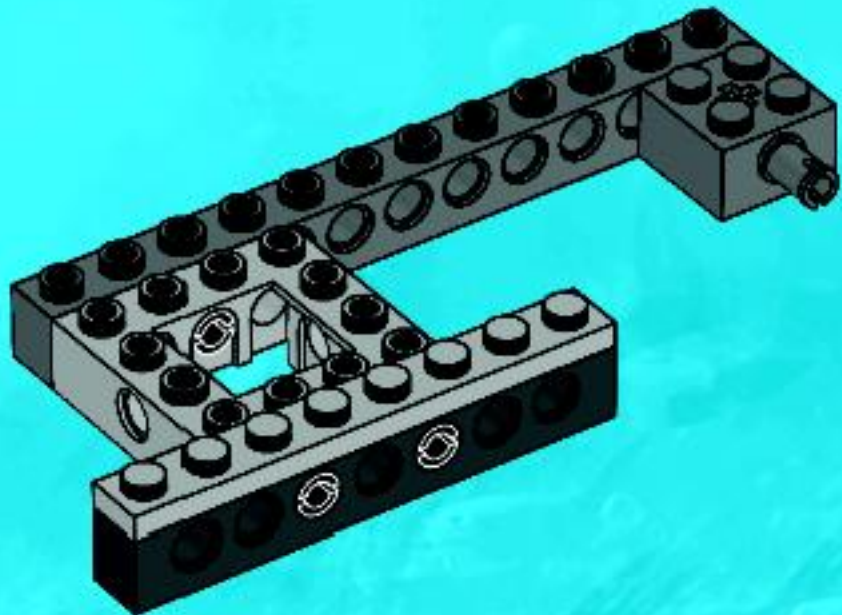

1x



1x

6

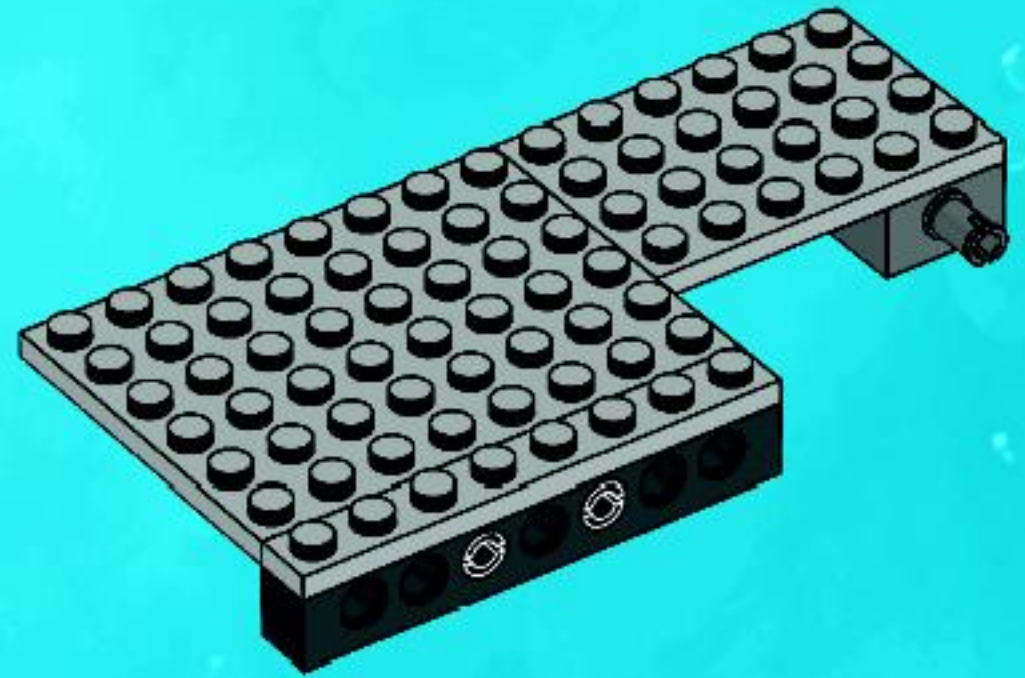

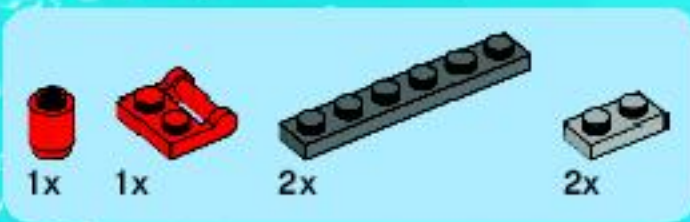

7

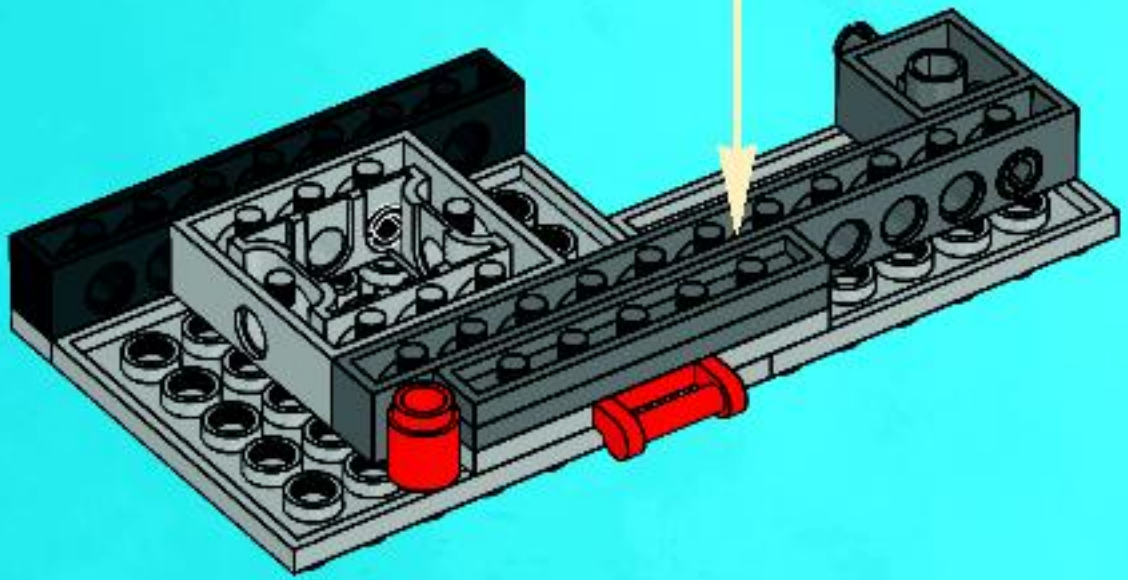
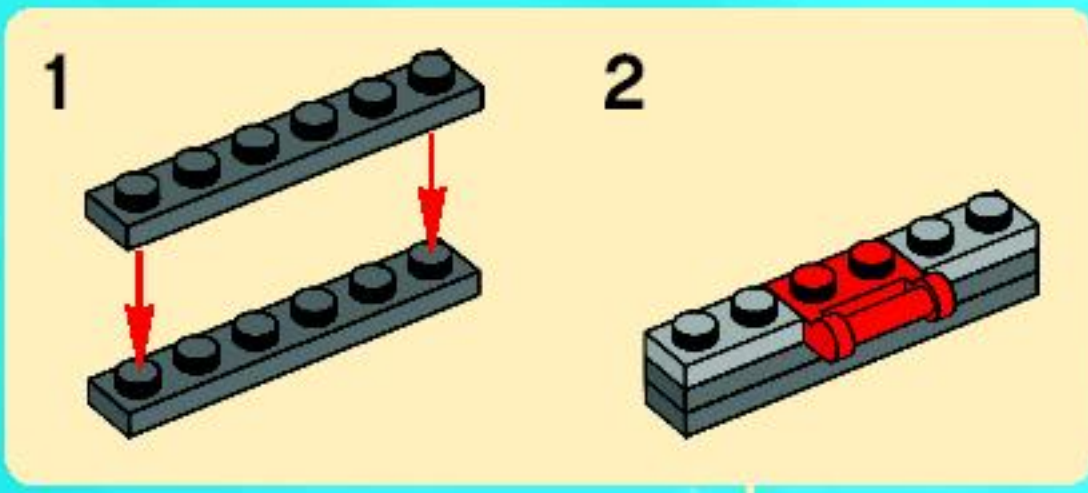

8



9

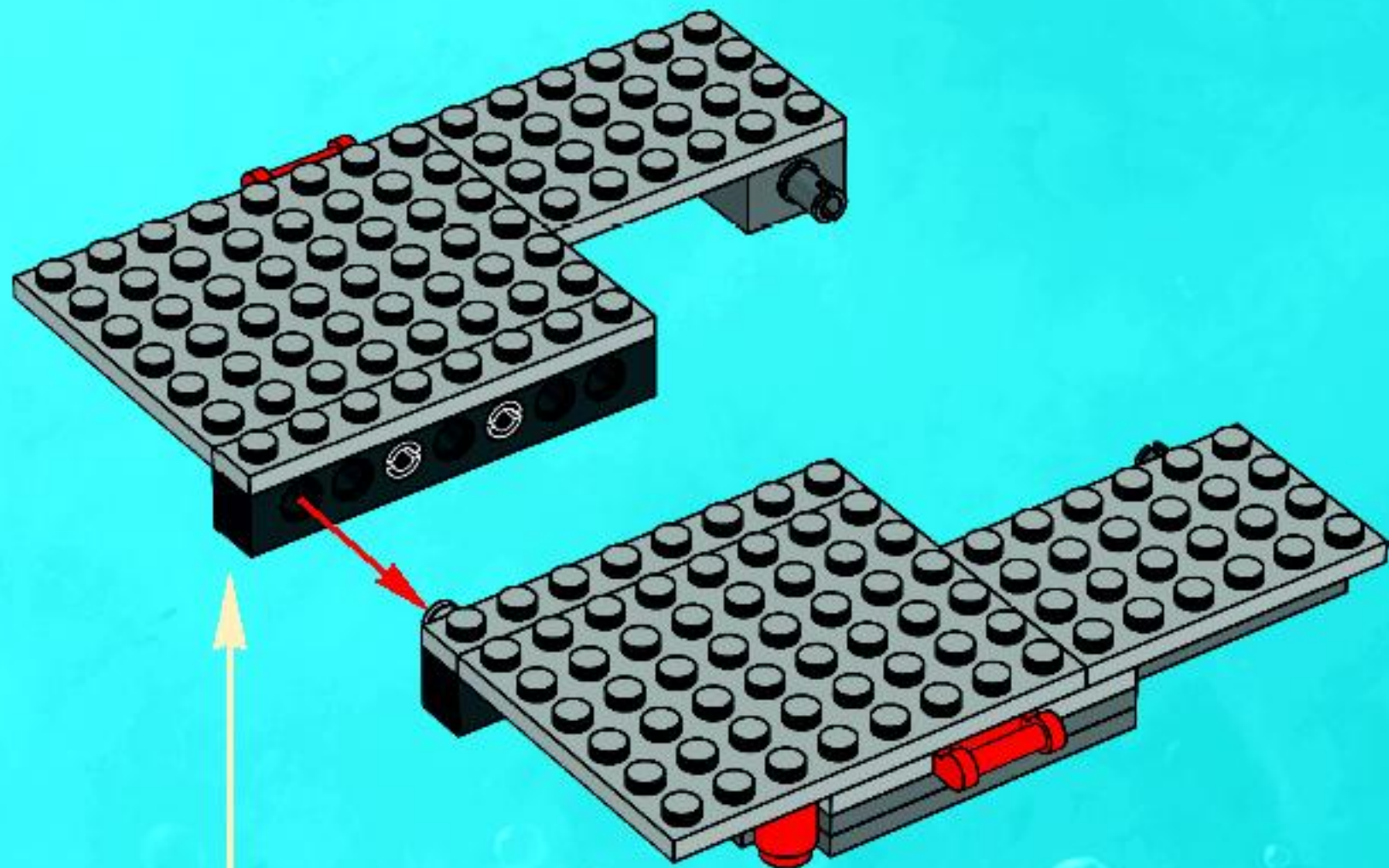

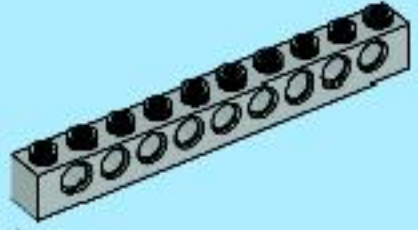

1x



2x

1

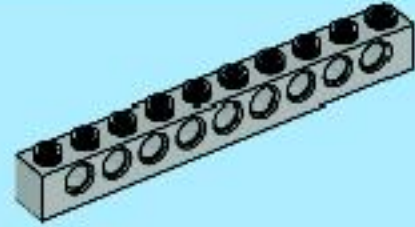
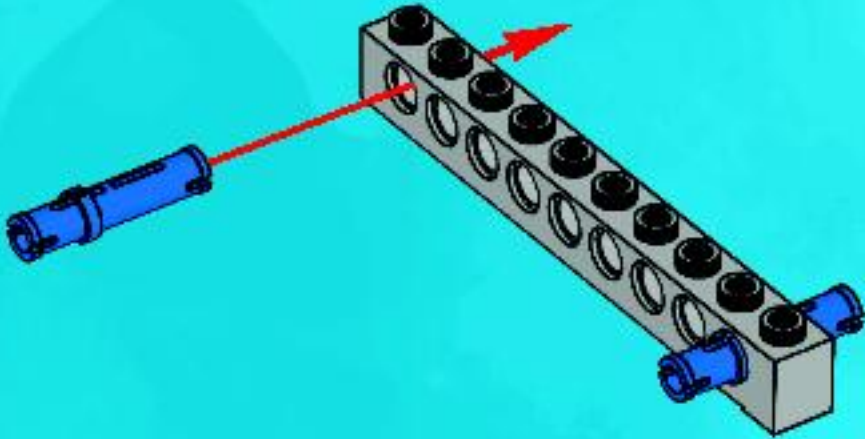

1x

2

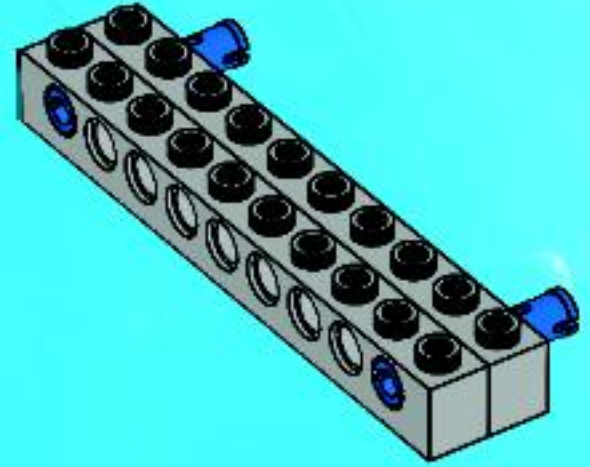

2x

3

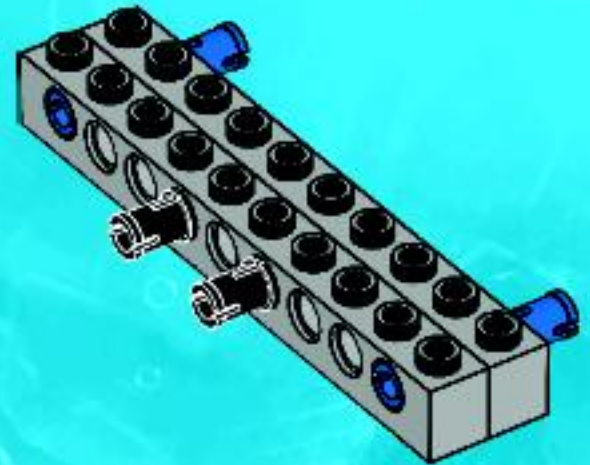

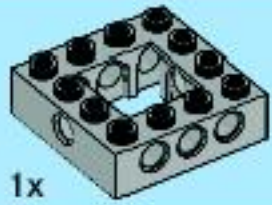

1x

4

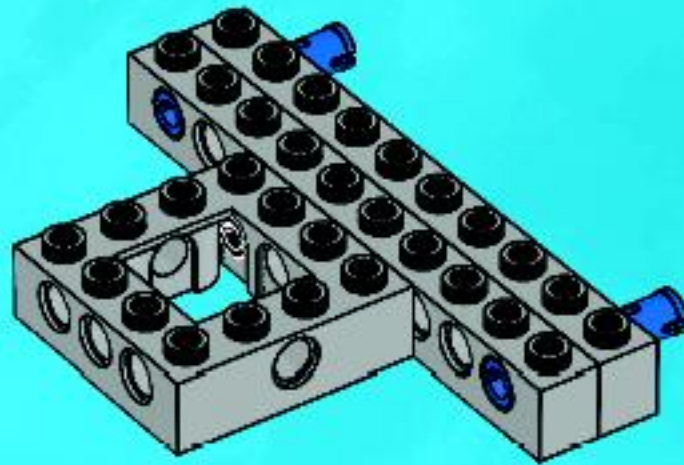

2x



1x

5

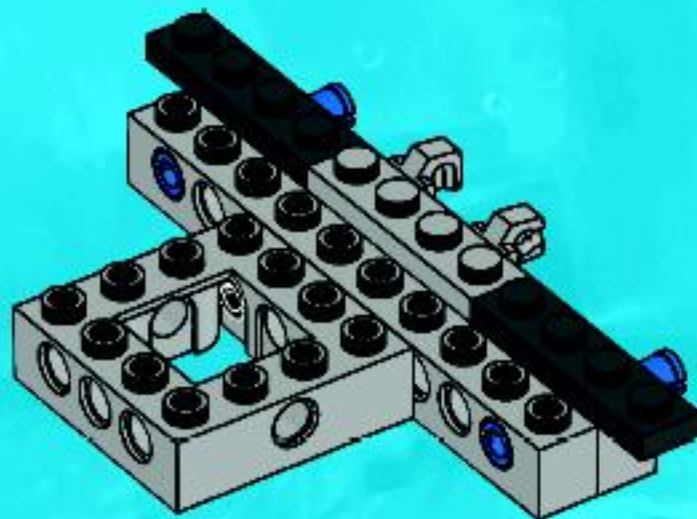



1x

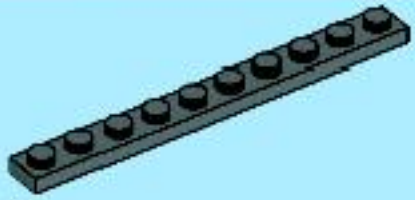

1x

6

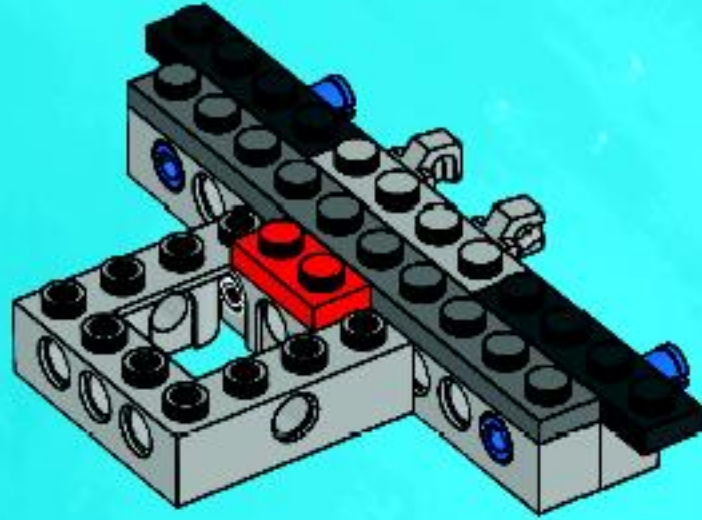

2x



2x



1x



1x

7

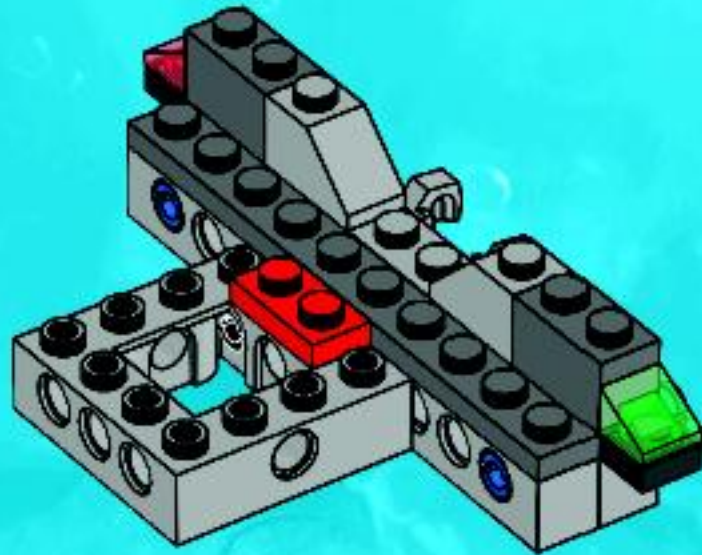



8

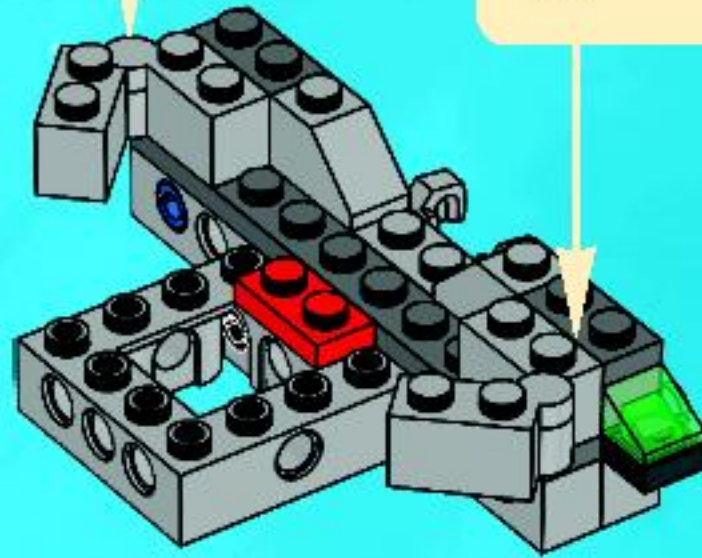
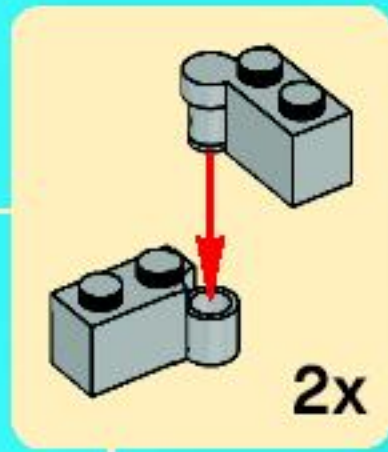

9

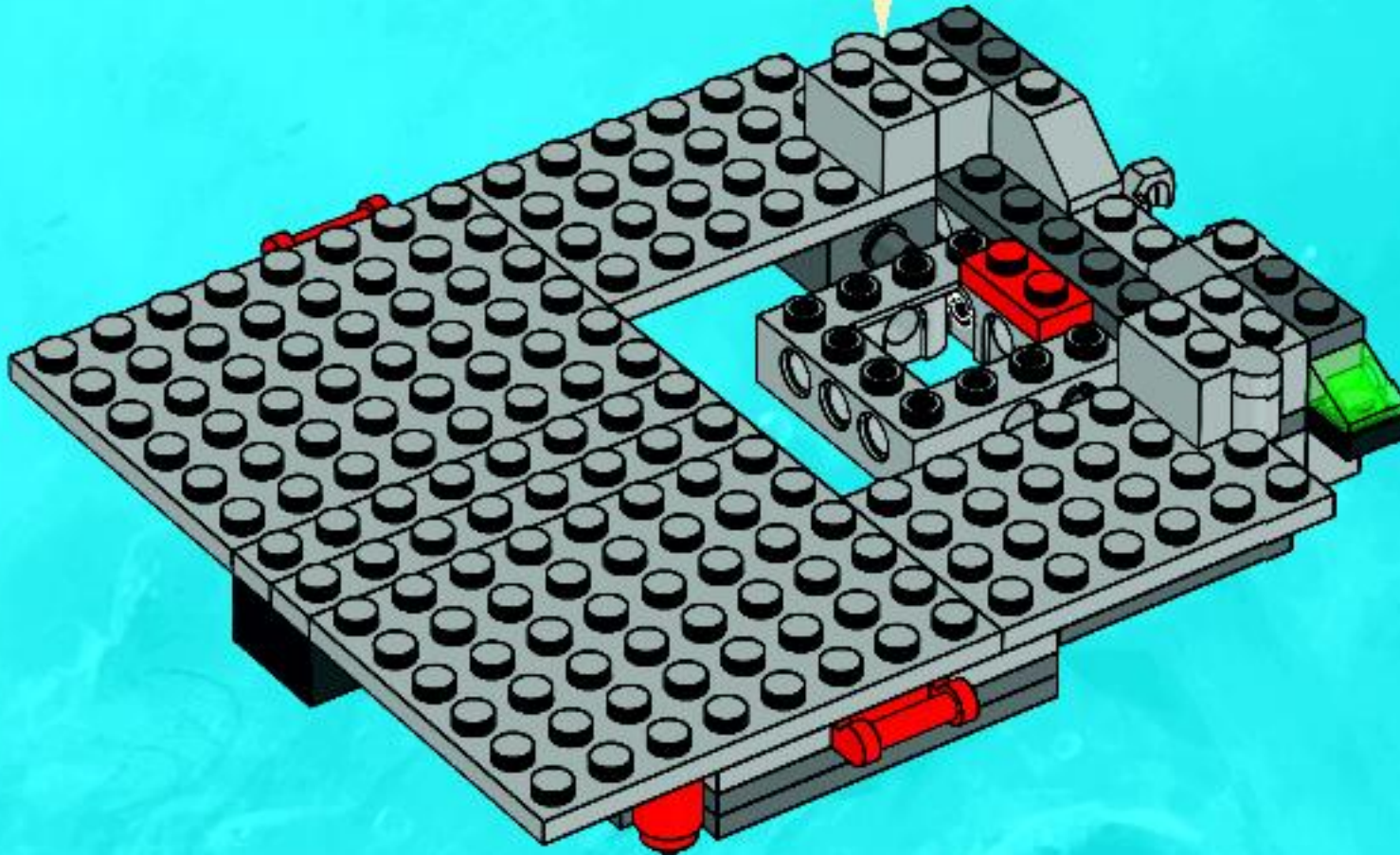

10

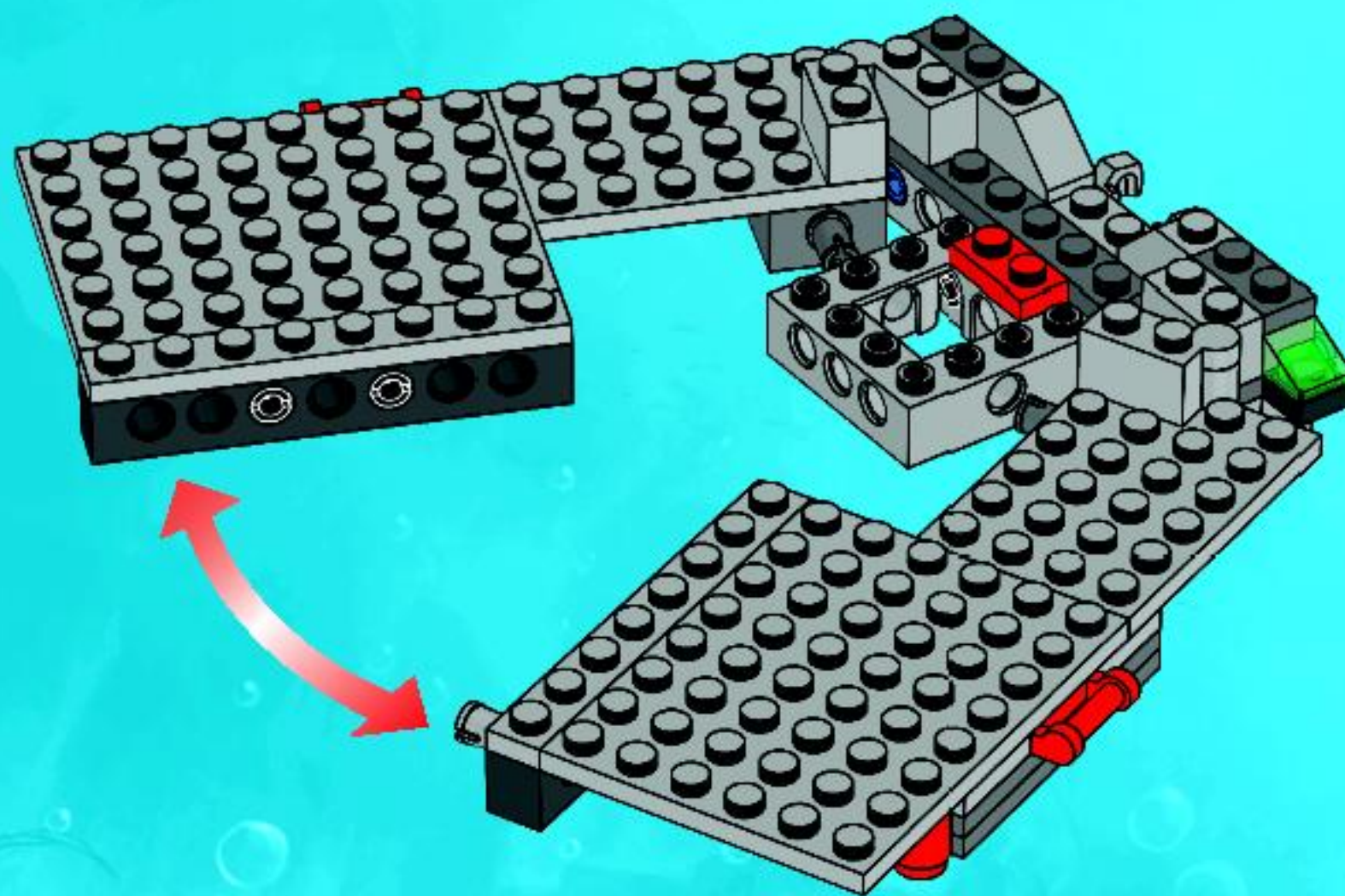

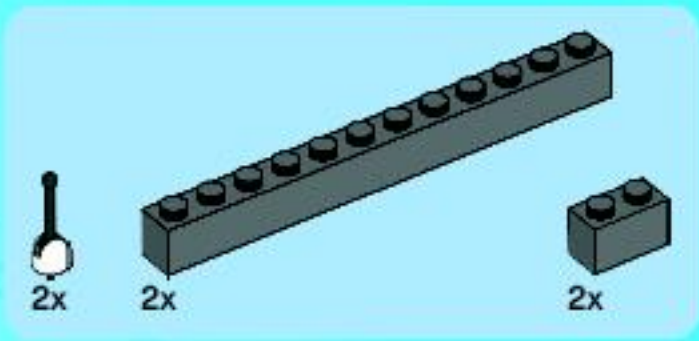

11

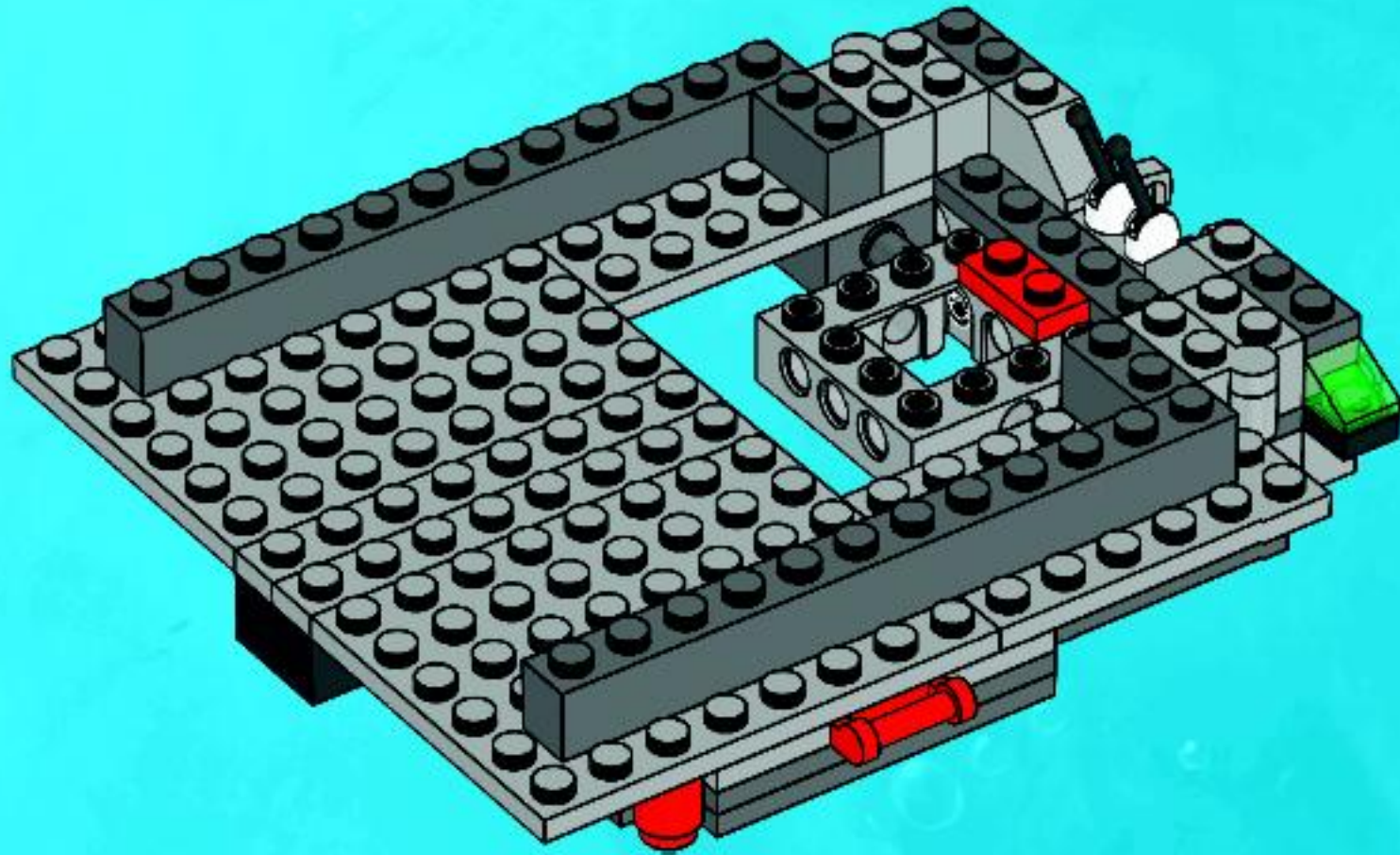



2x



1x



1x

13

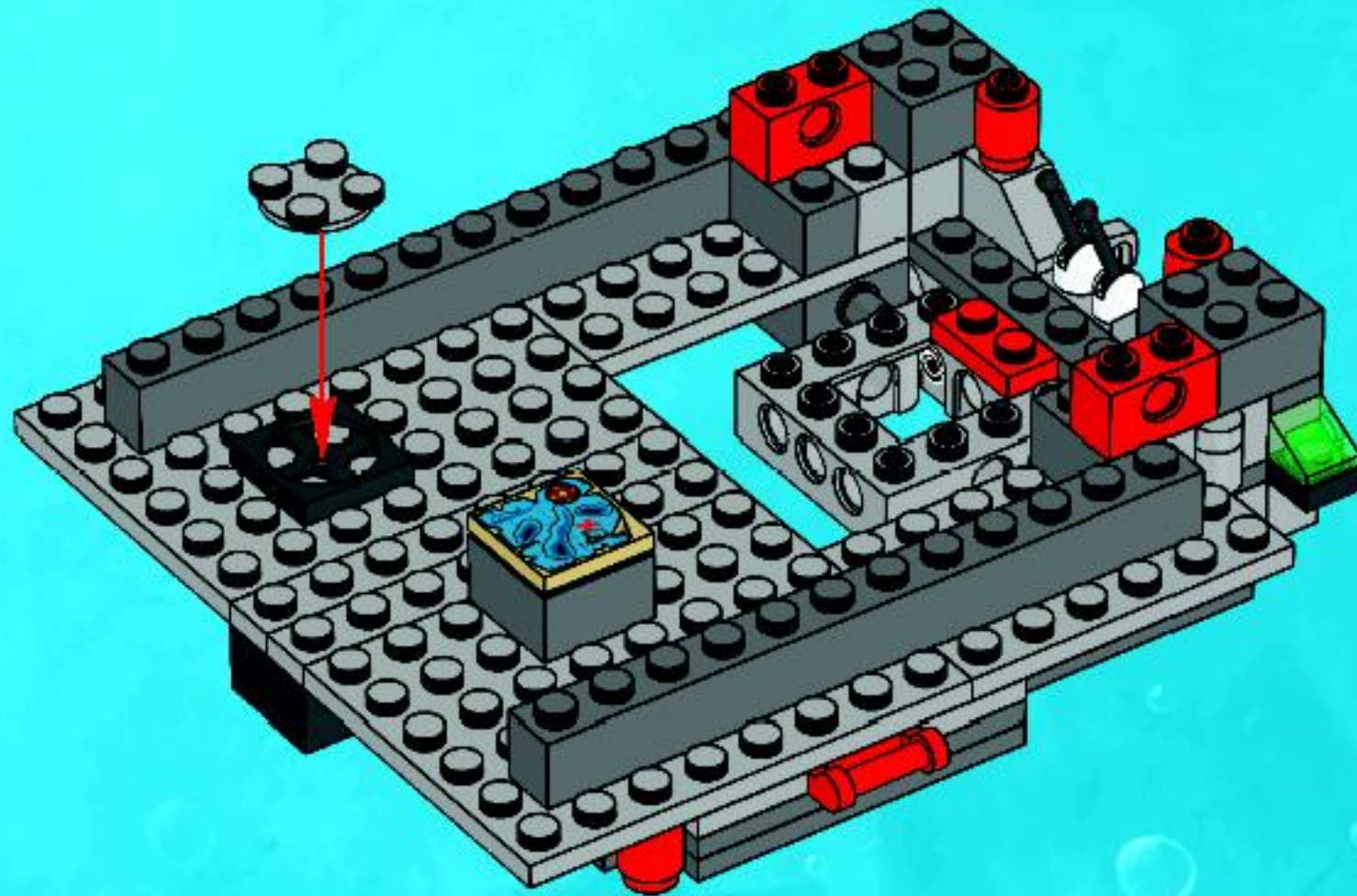



2x



1x



2x

14

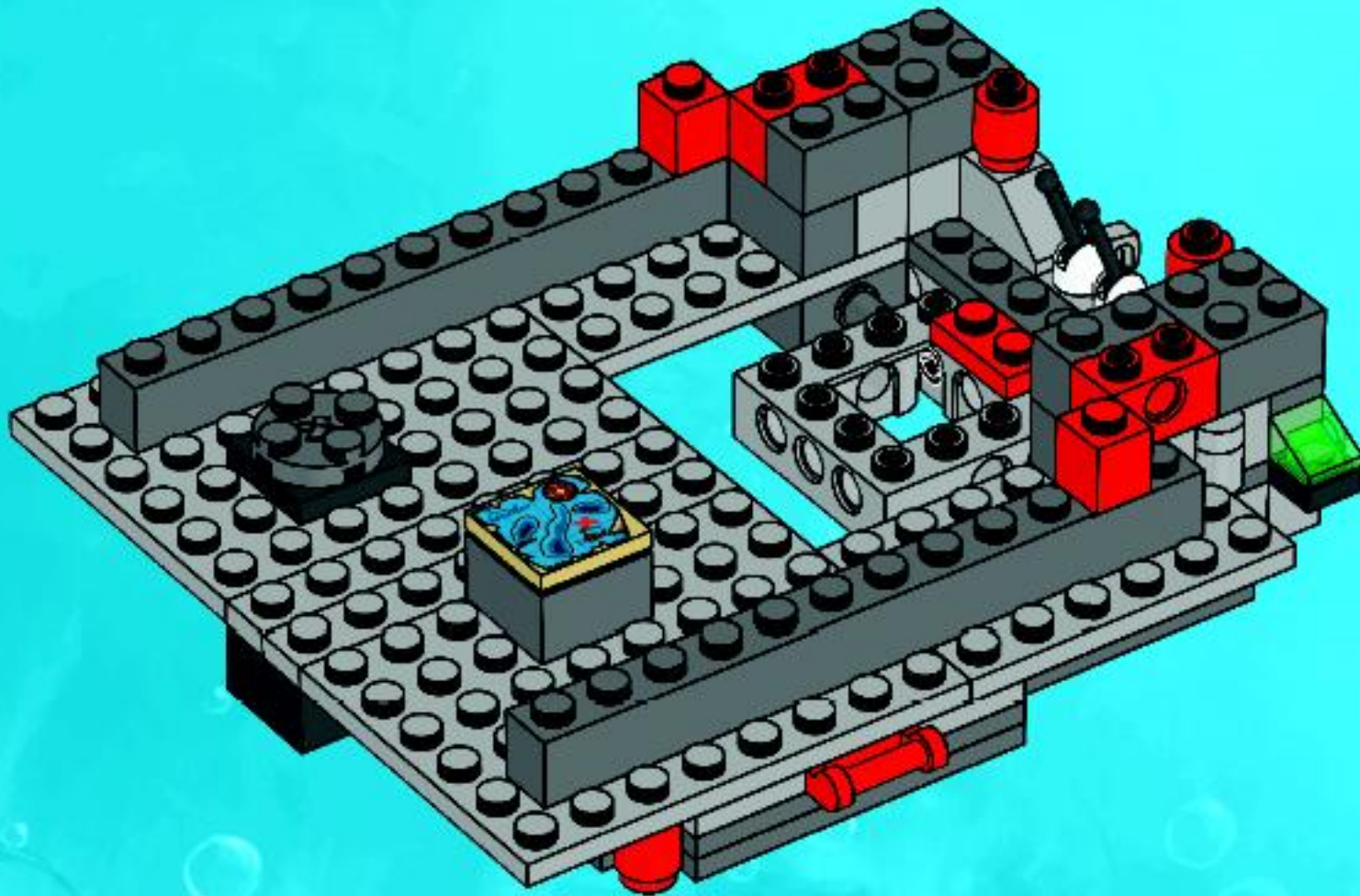

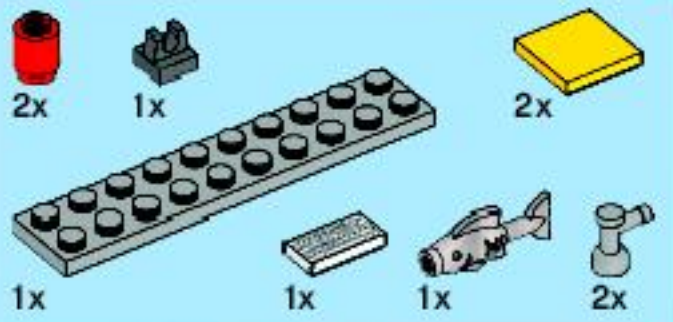

15

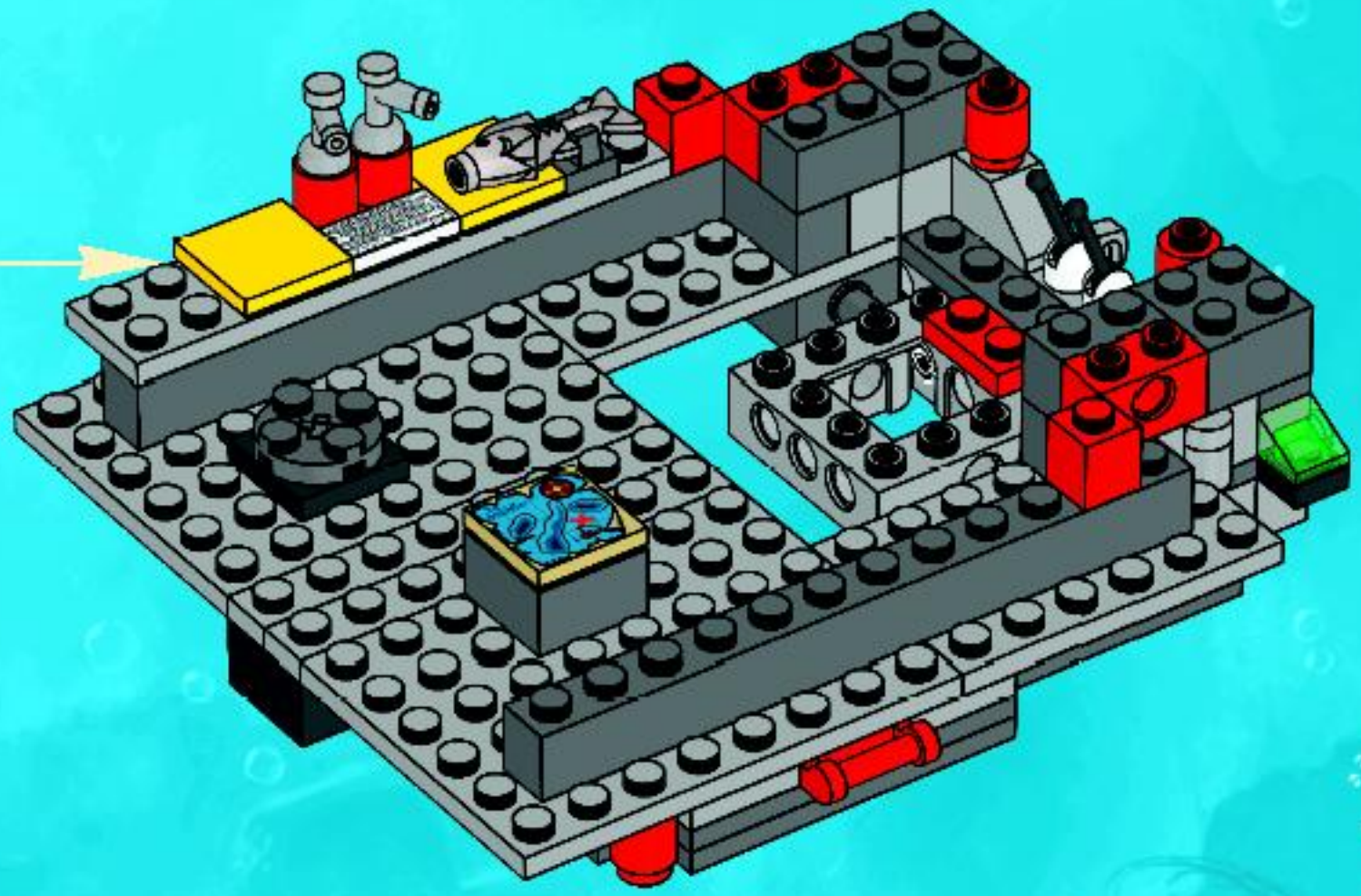
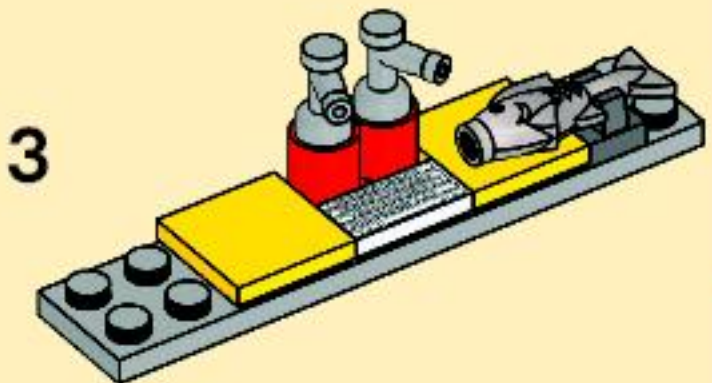
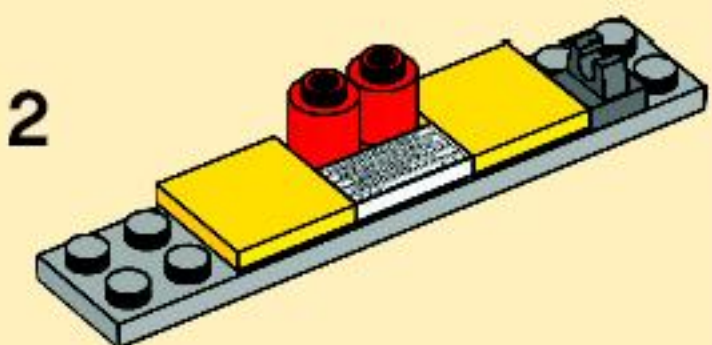
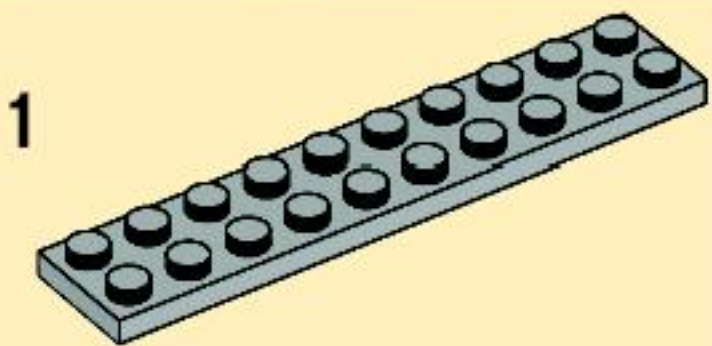

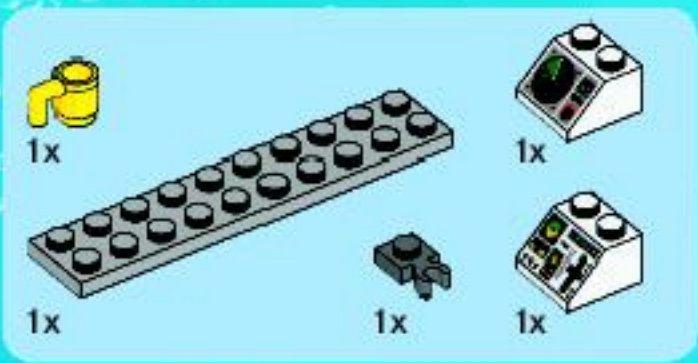

16

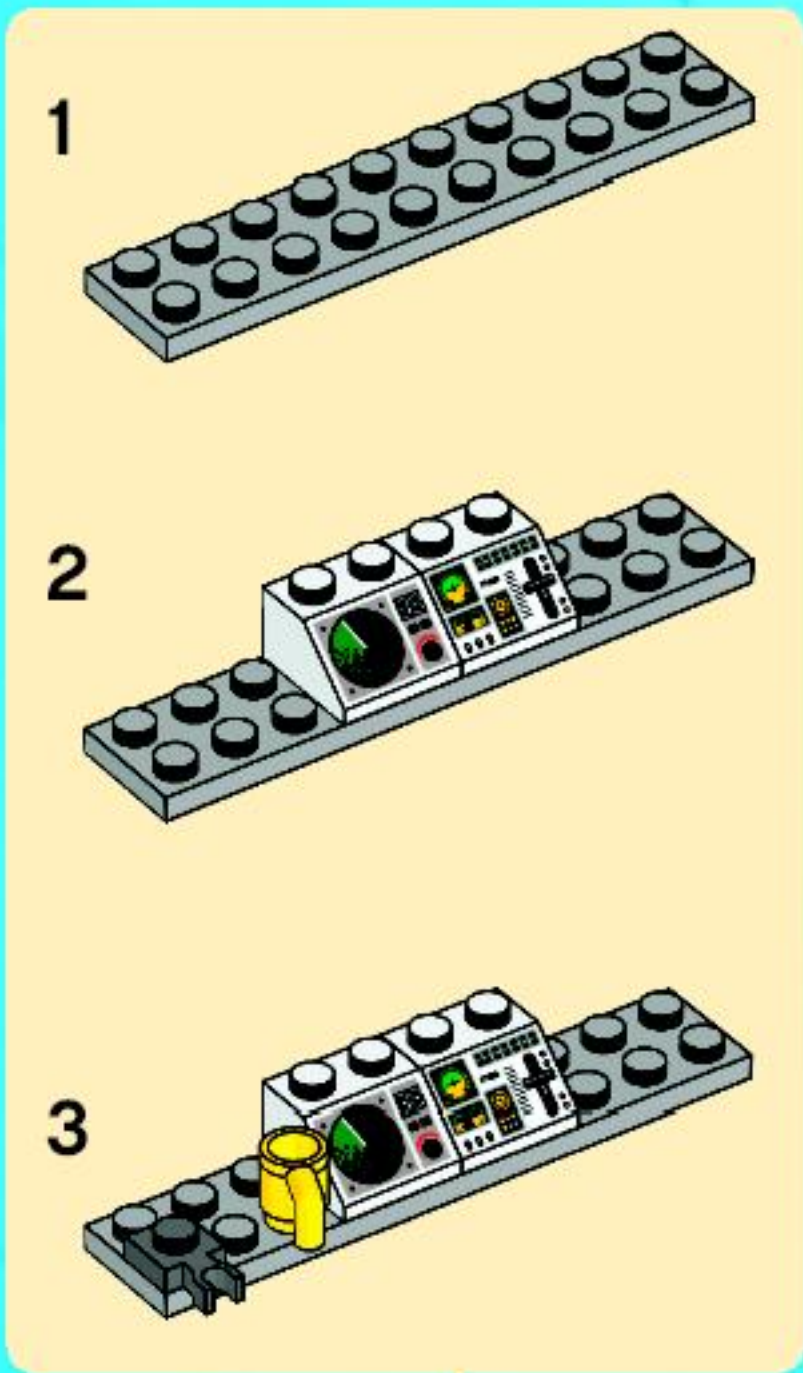
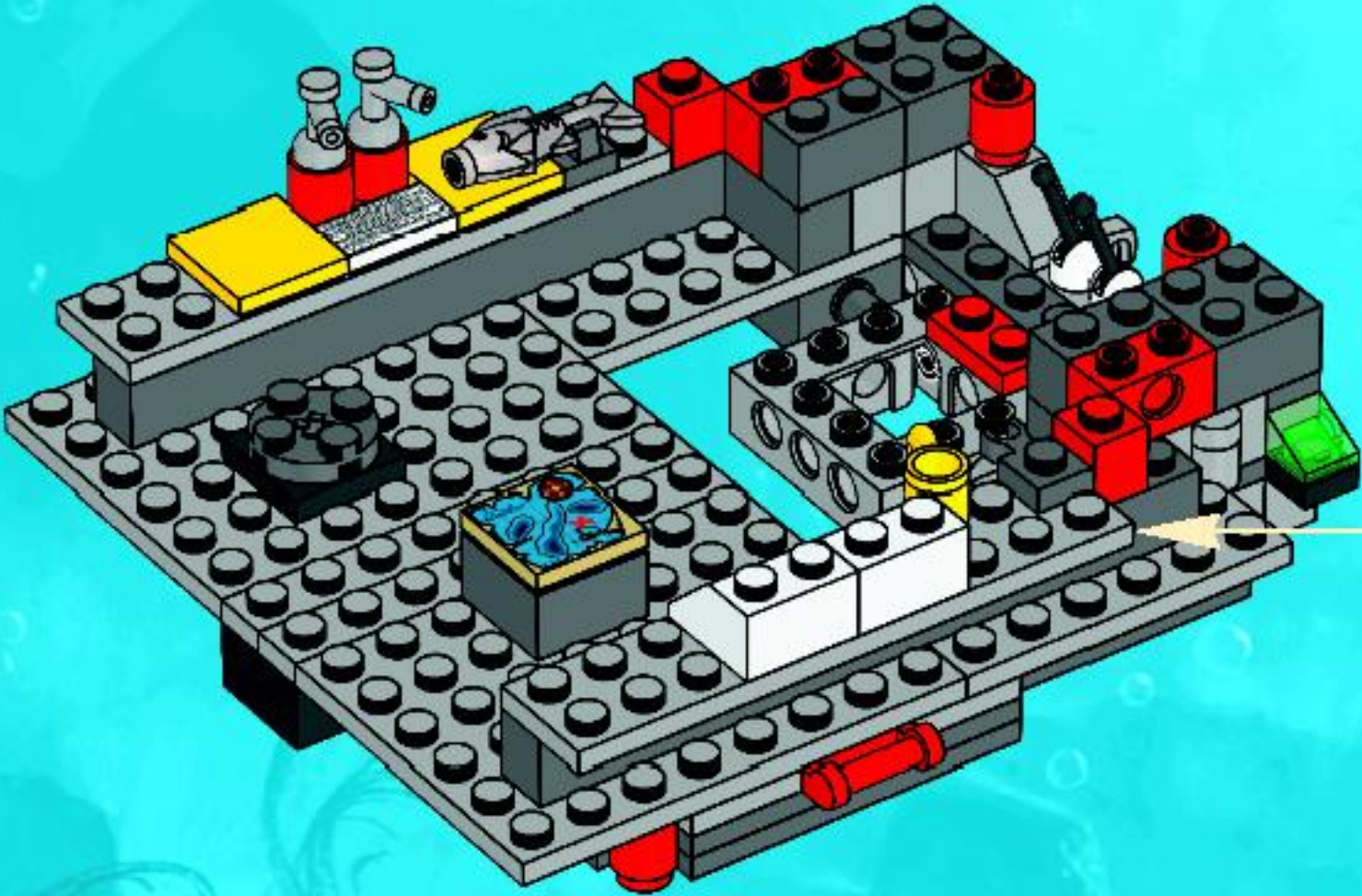



2x



2x



2x

17

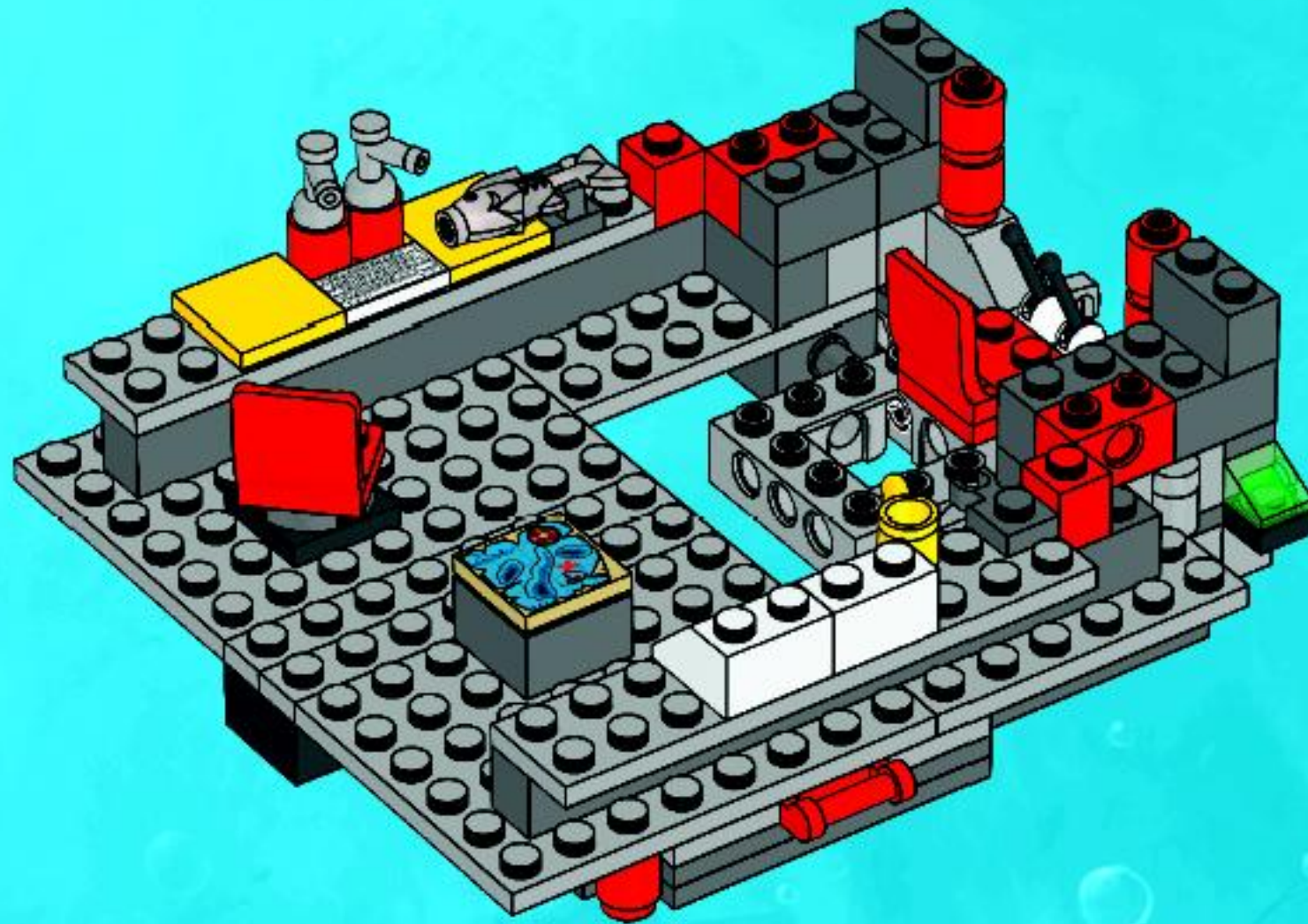



18

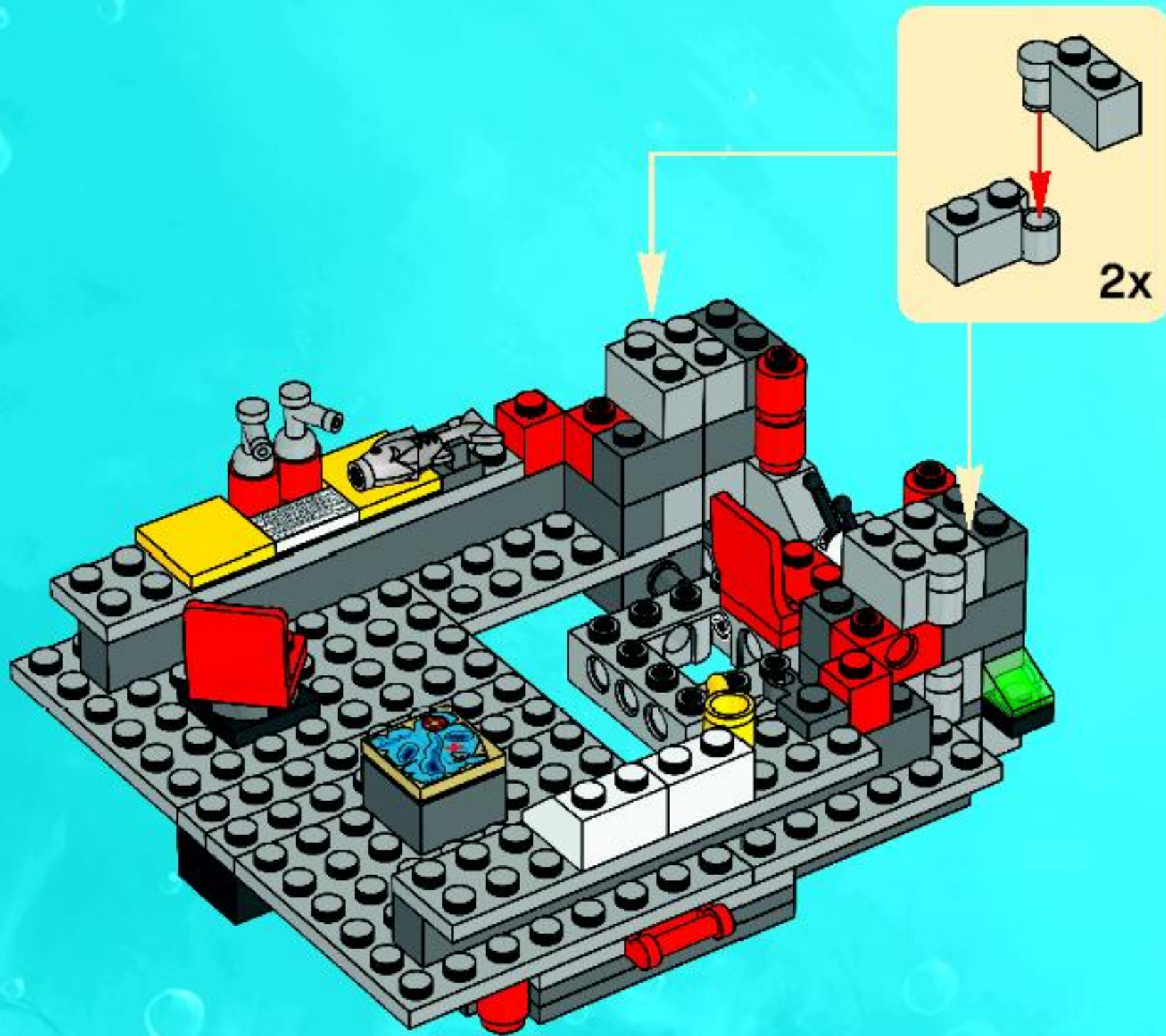



2x



2x

19

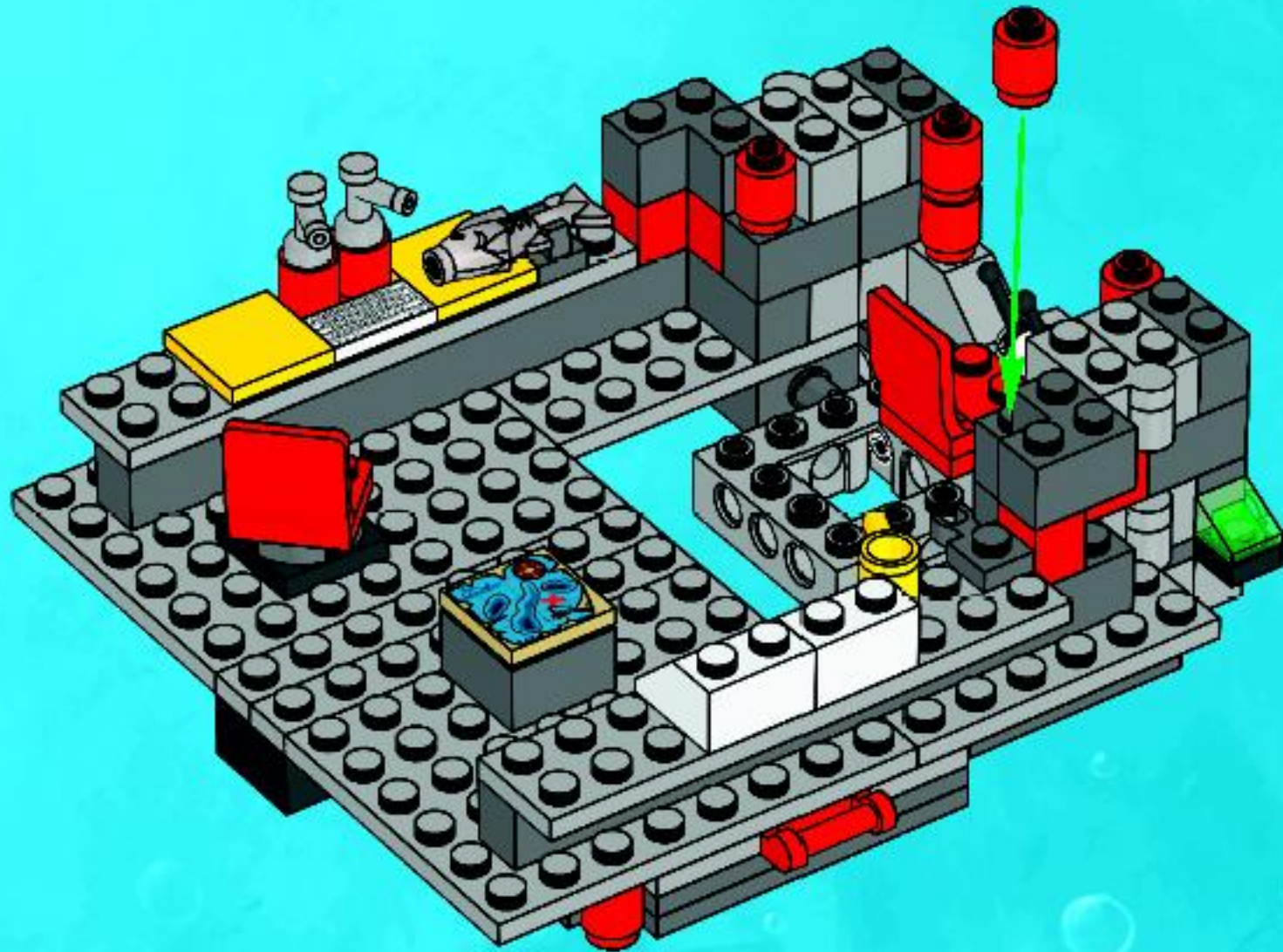

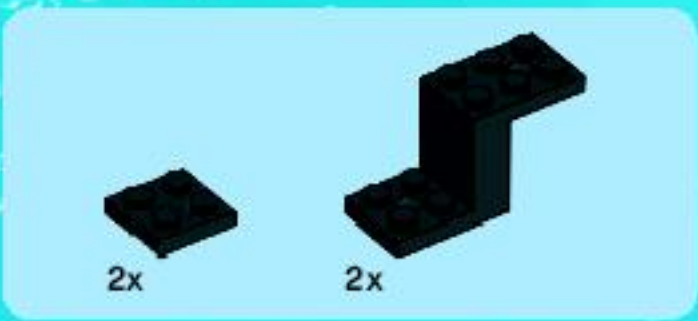

20

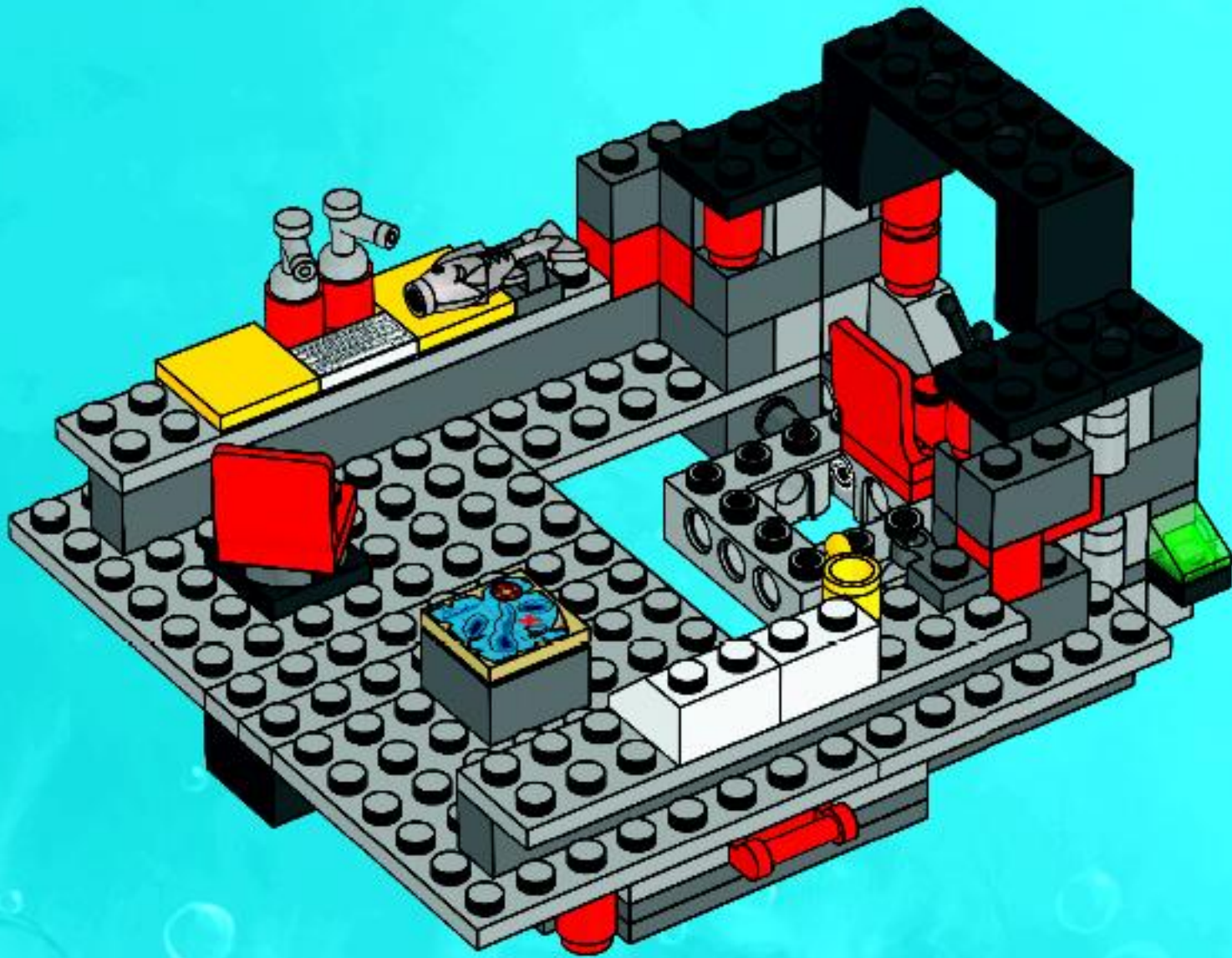



4x



2x

21

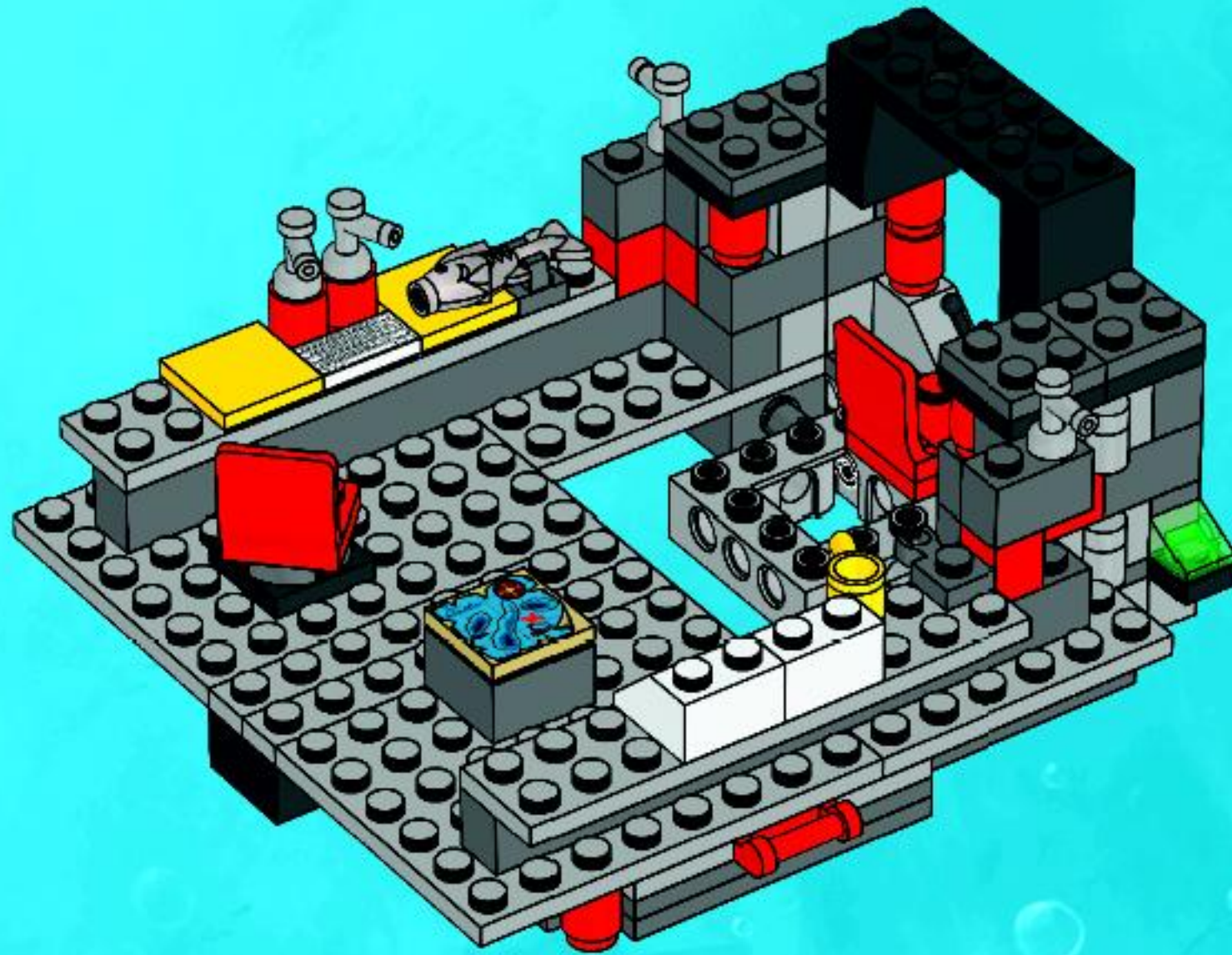



4x

22

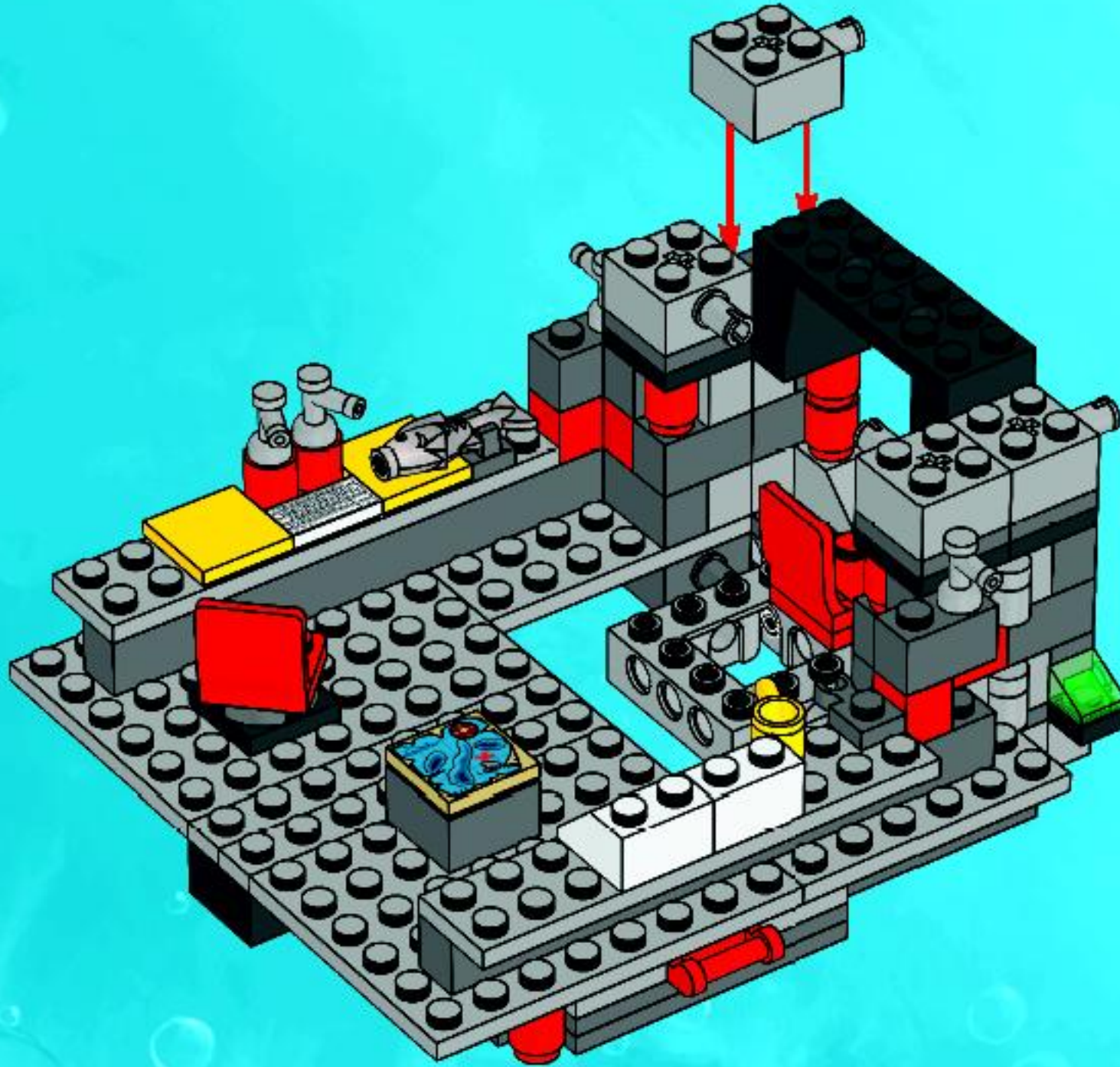

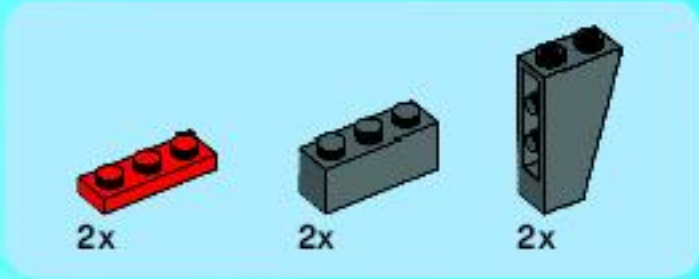

23

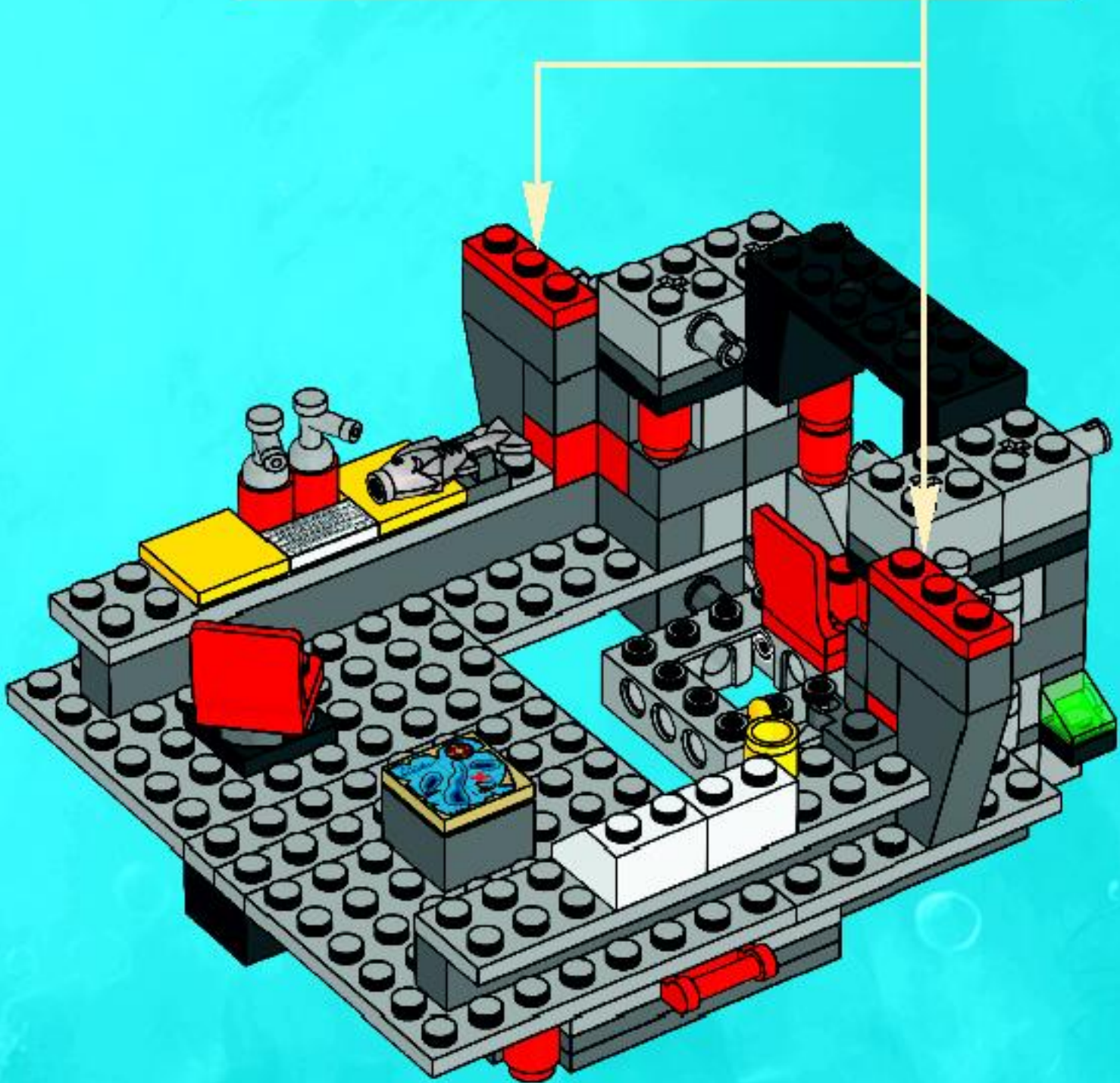
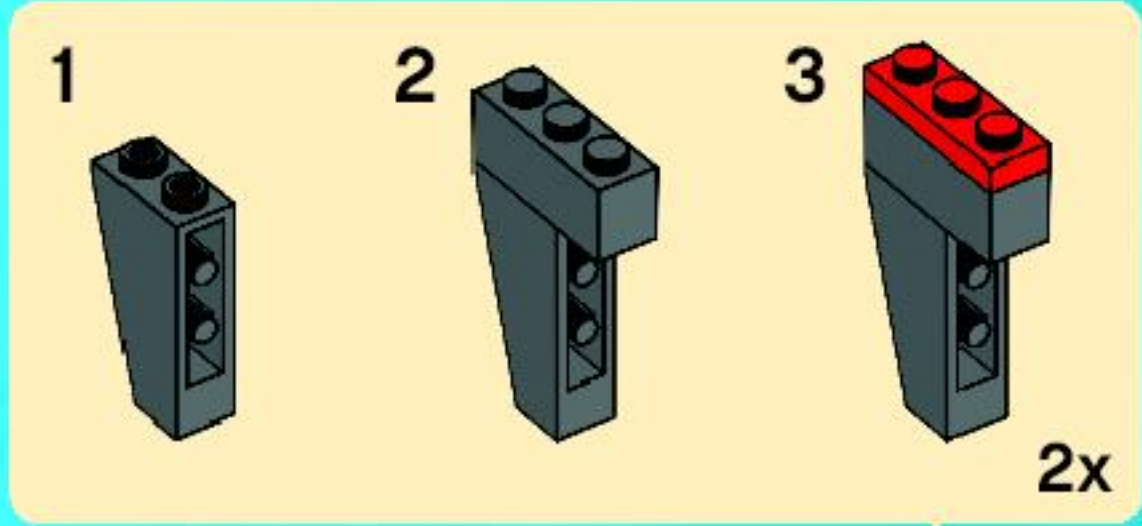

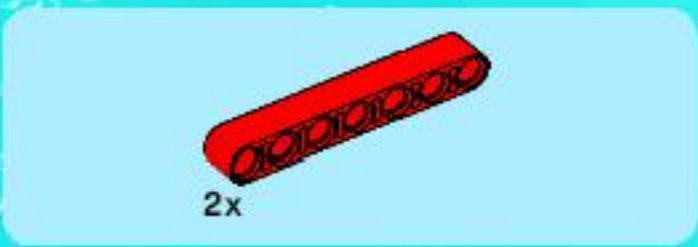

24

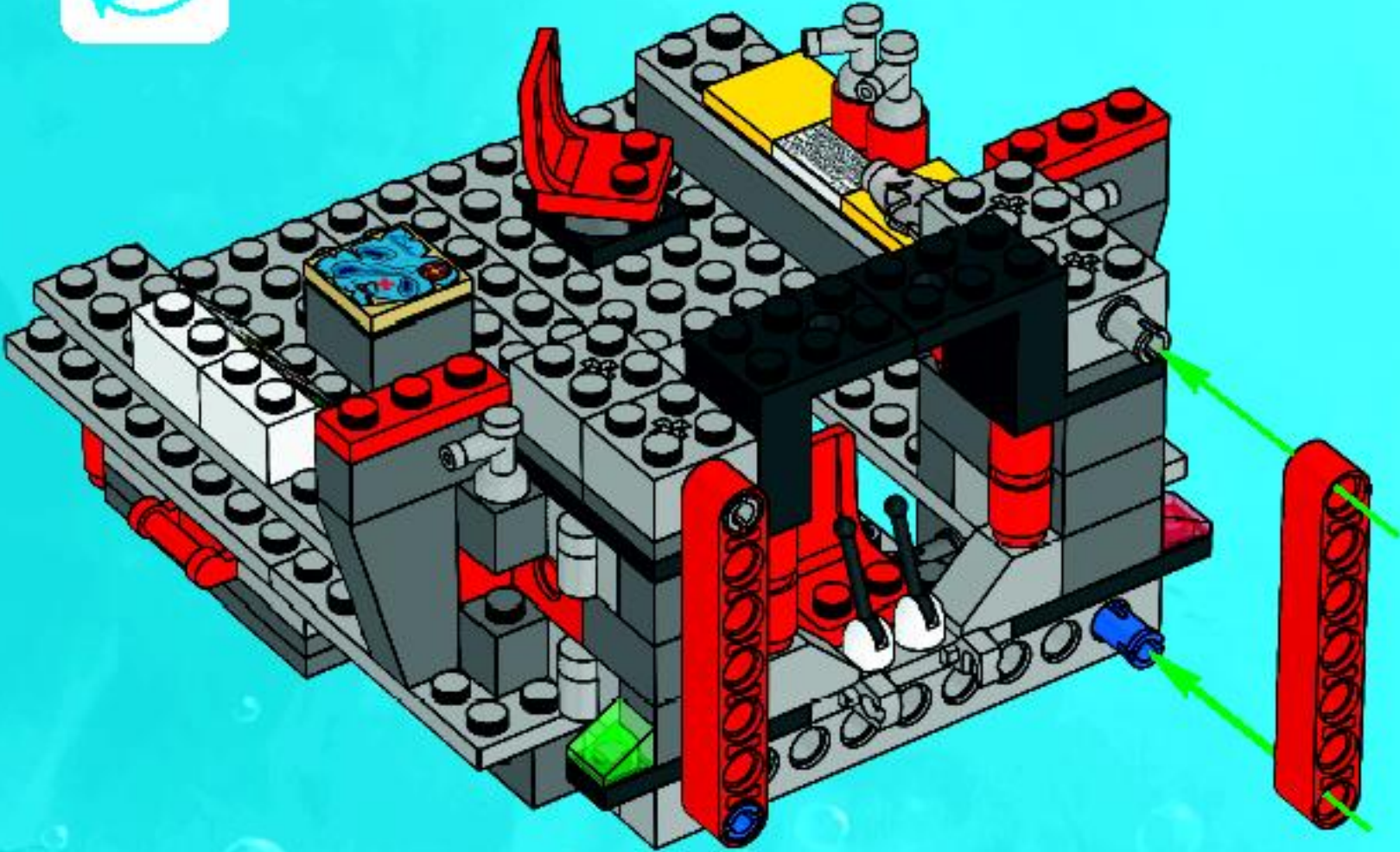



4x

25

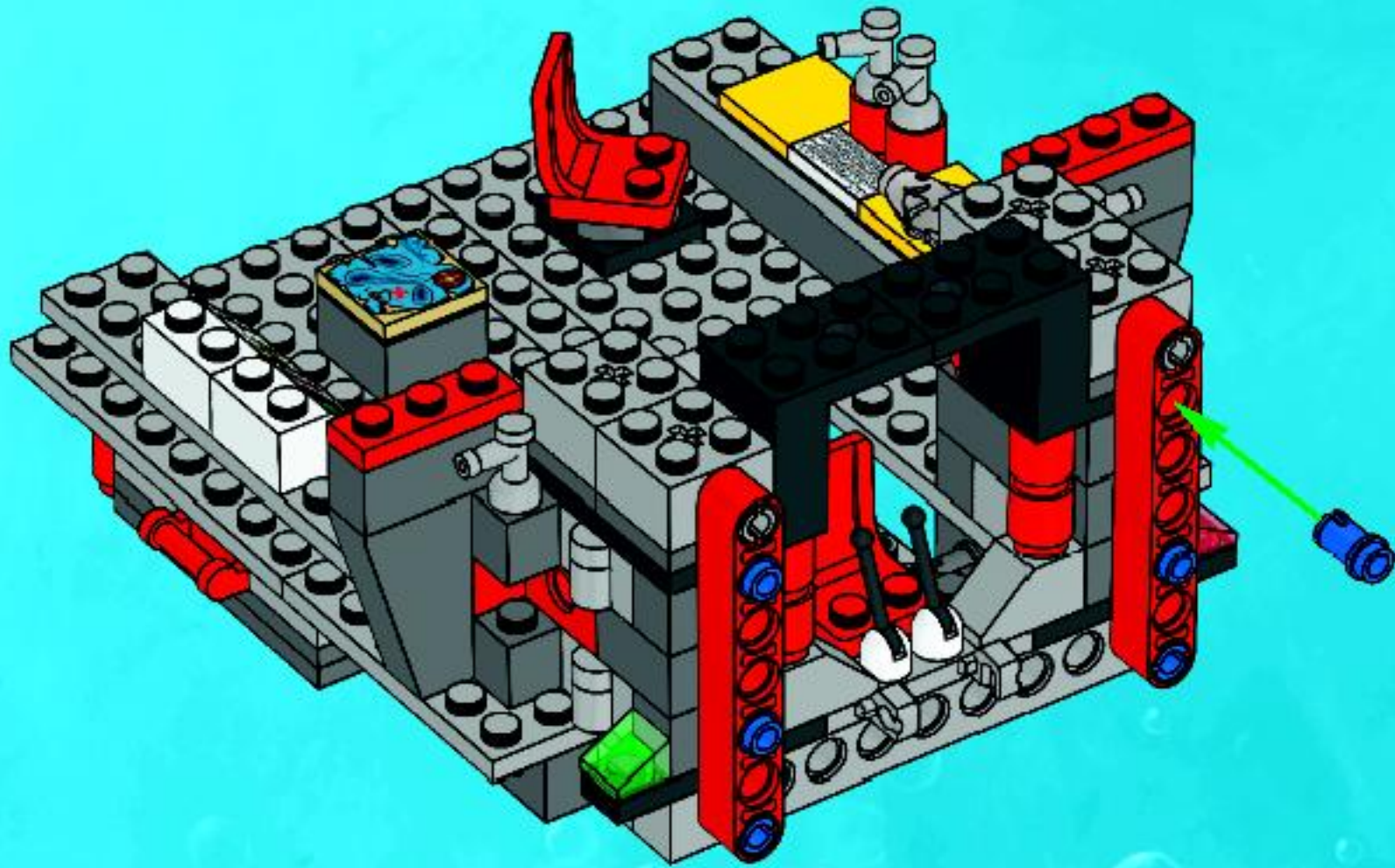

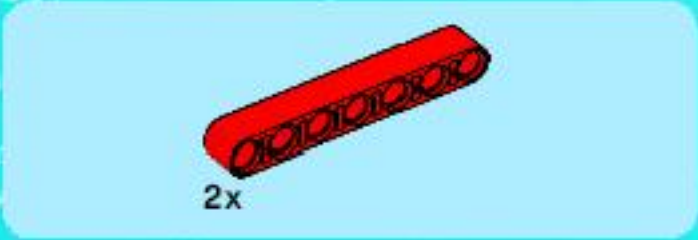

26

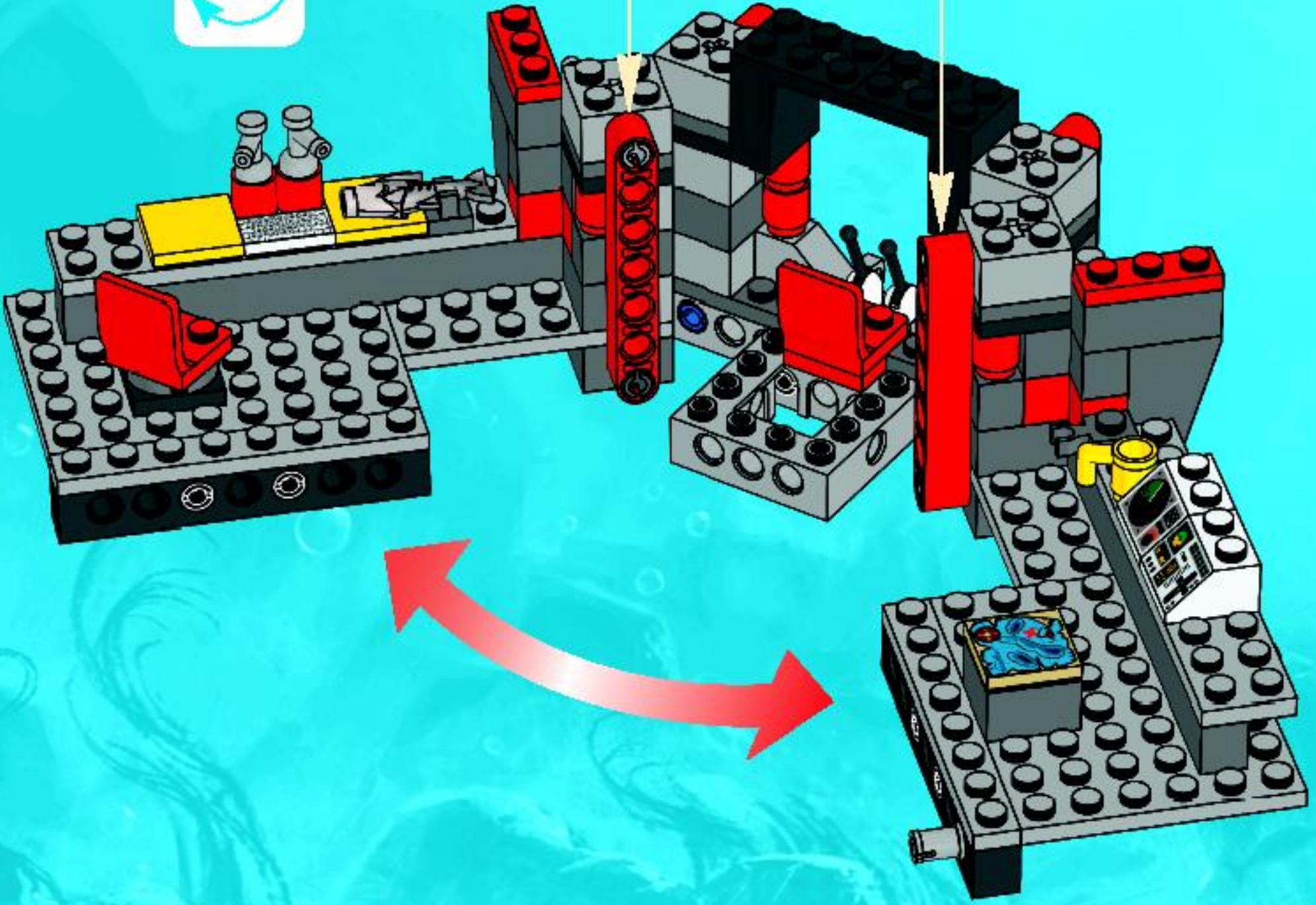
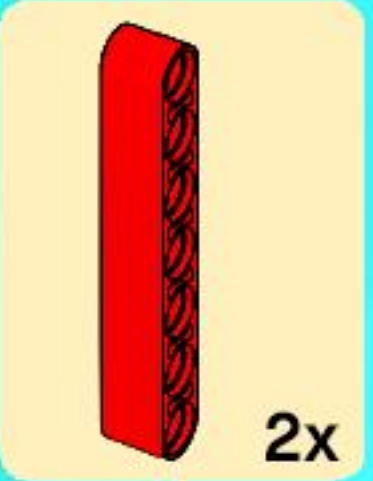

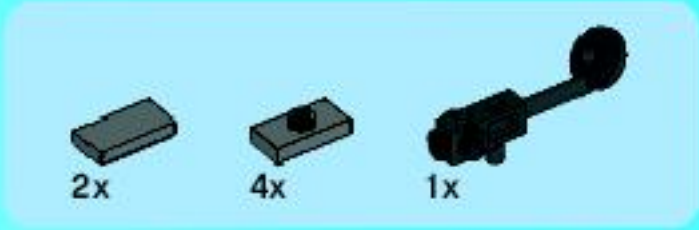

27

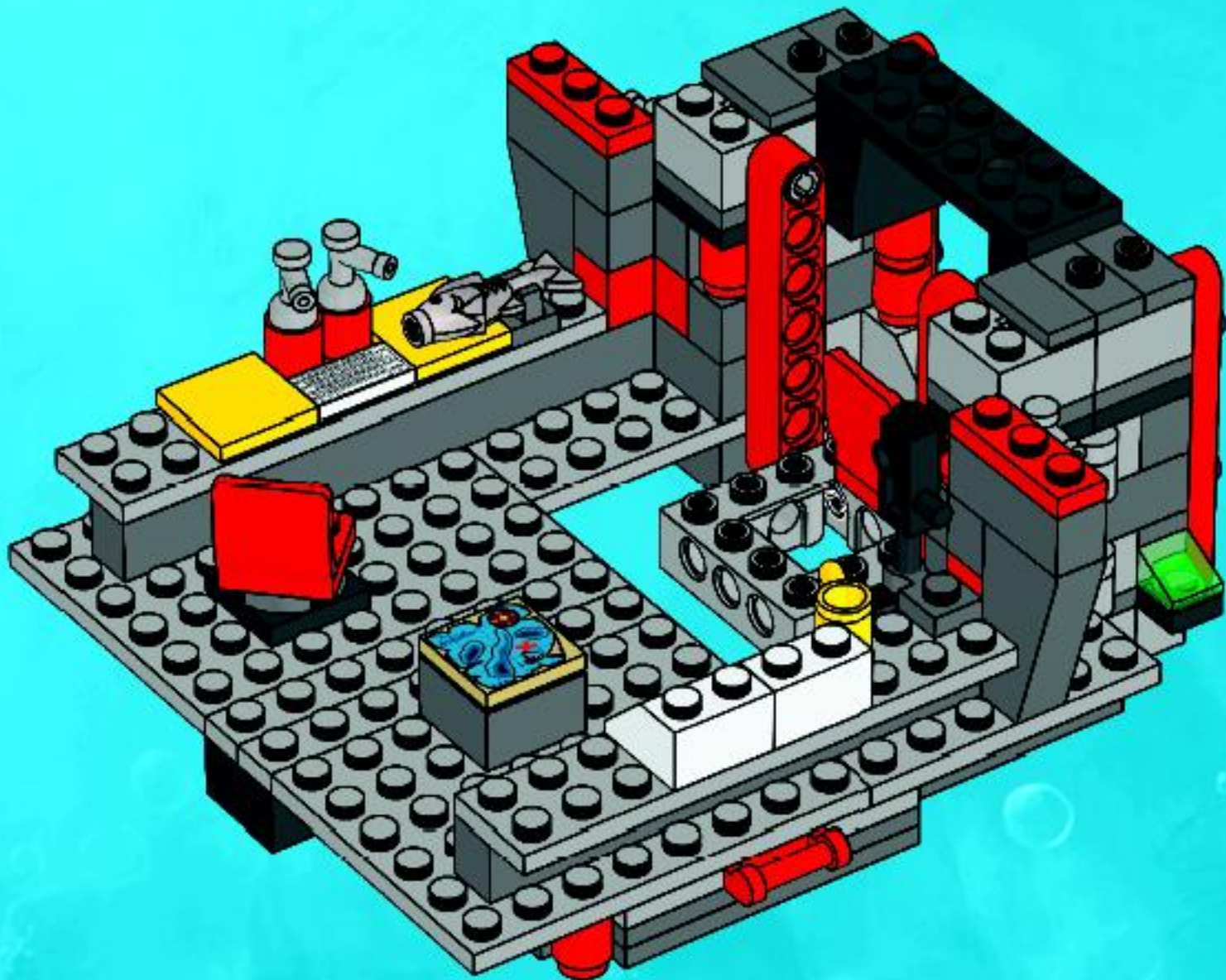

 2x	 2x	 2x
 1x	 1x	 2x

28

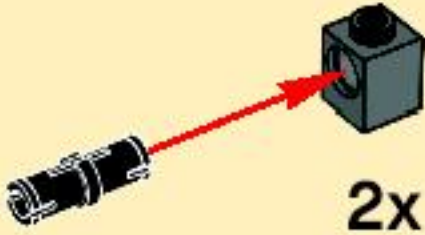



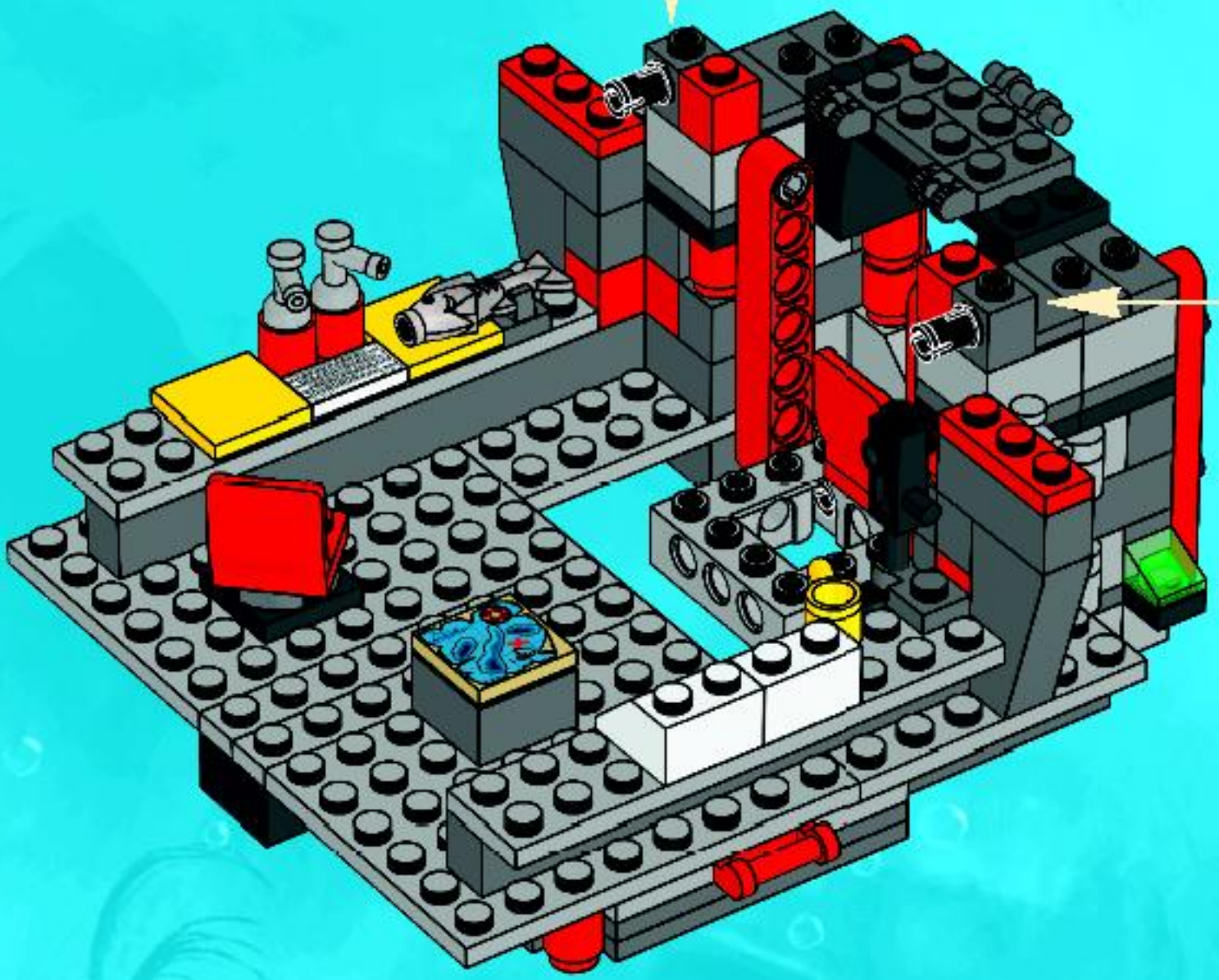

2x

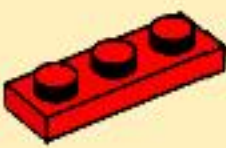
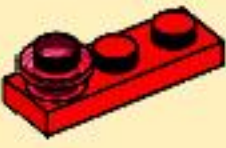

 2x
 1x
 1x
 2x

30

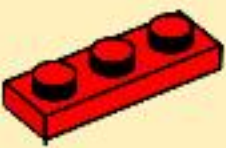
- 1 
- 2 
- 3 

- 1 
- 2 
- 3 

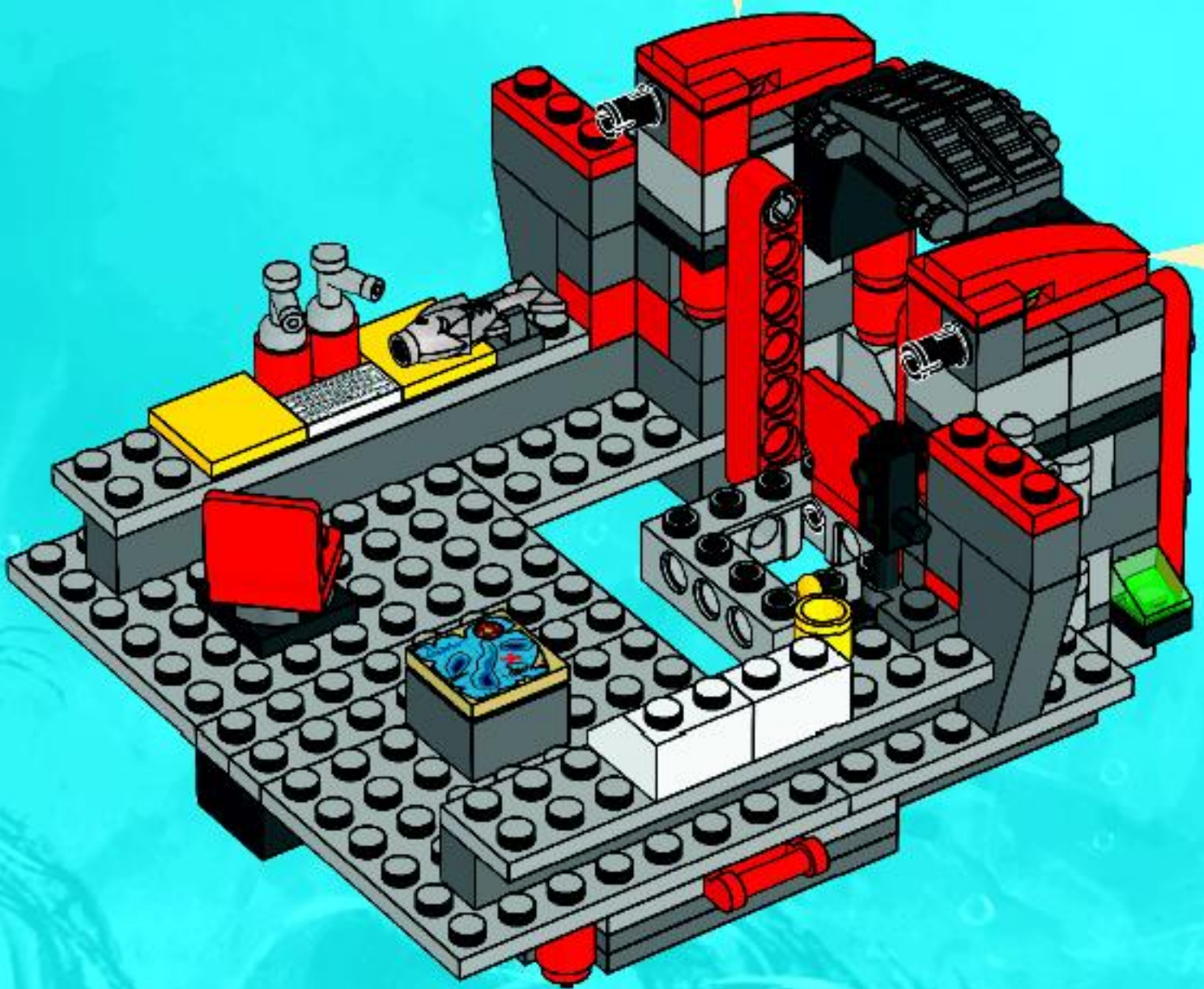

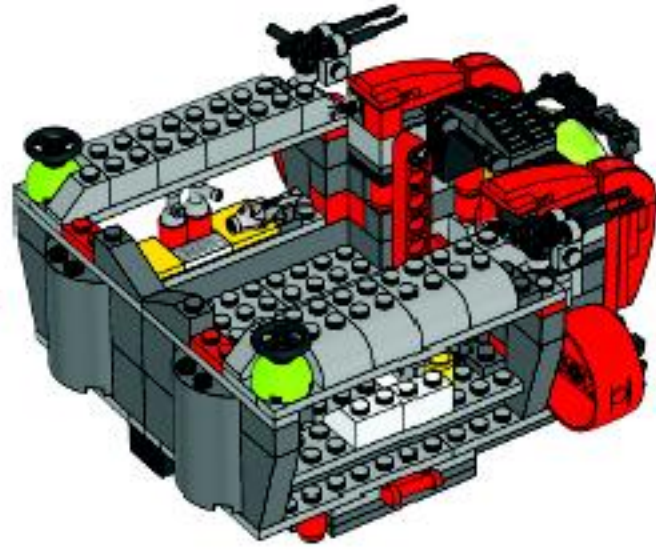

2x



2x

31

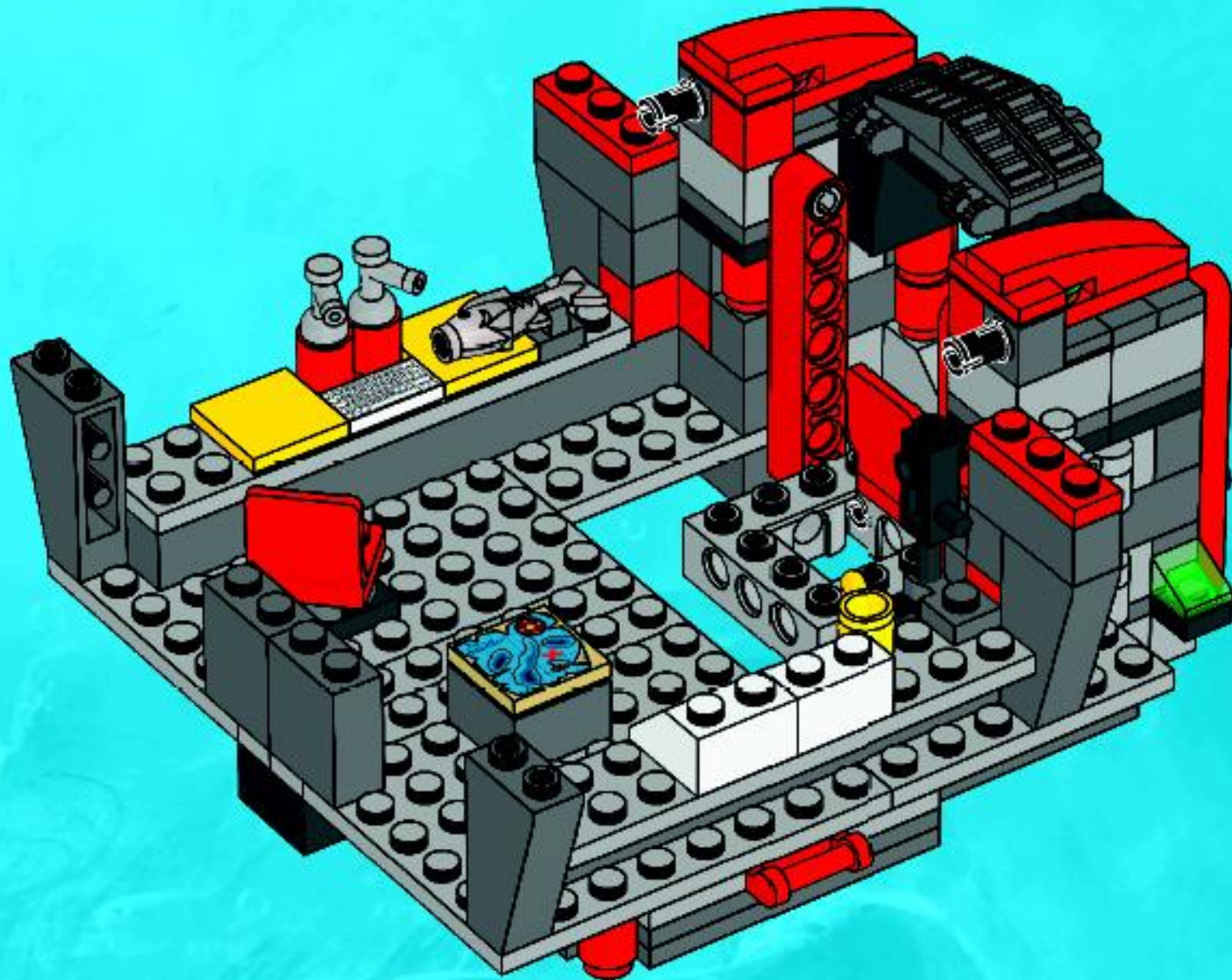



2x



2x

32

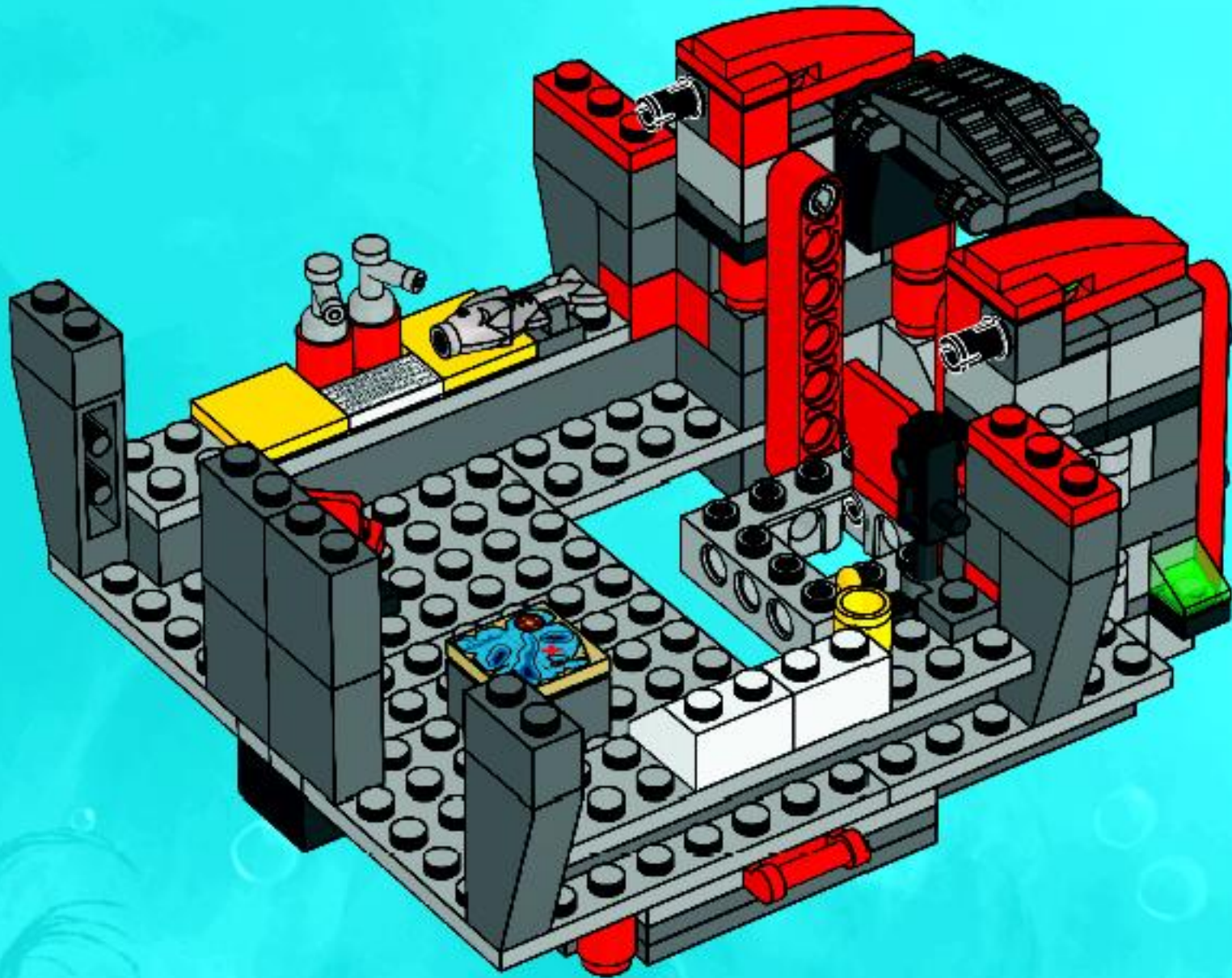



2x

33

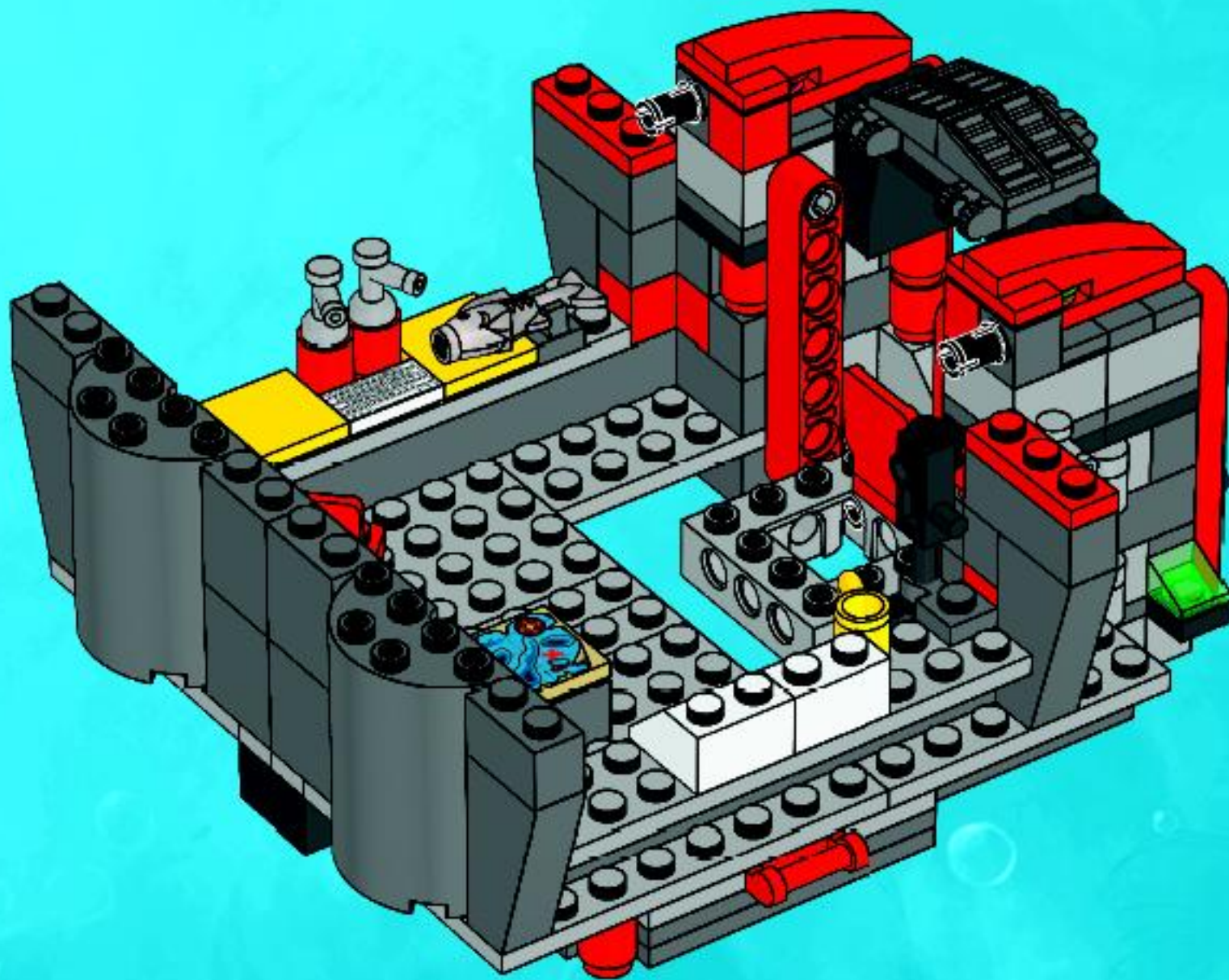

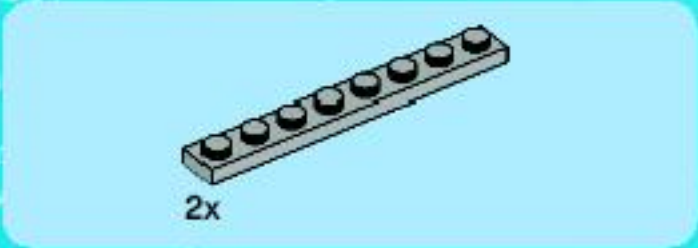

34

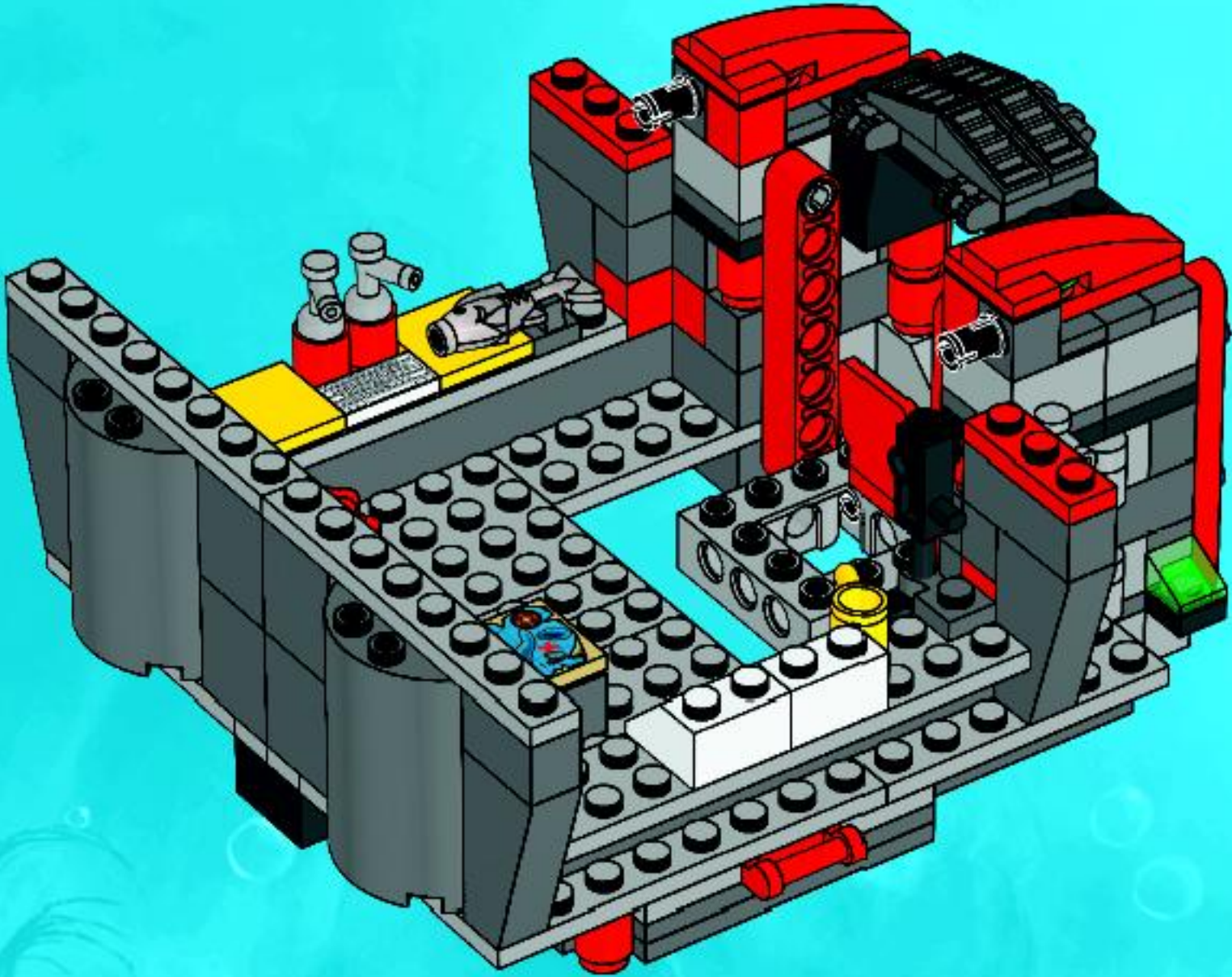



2x



2x

35

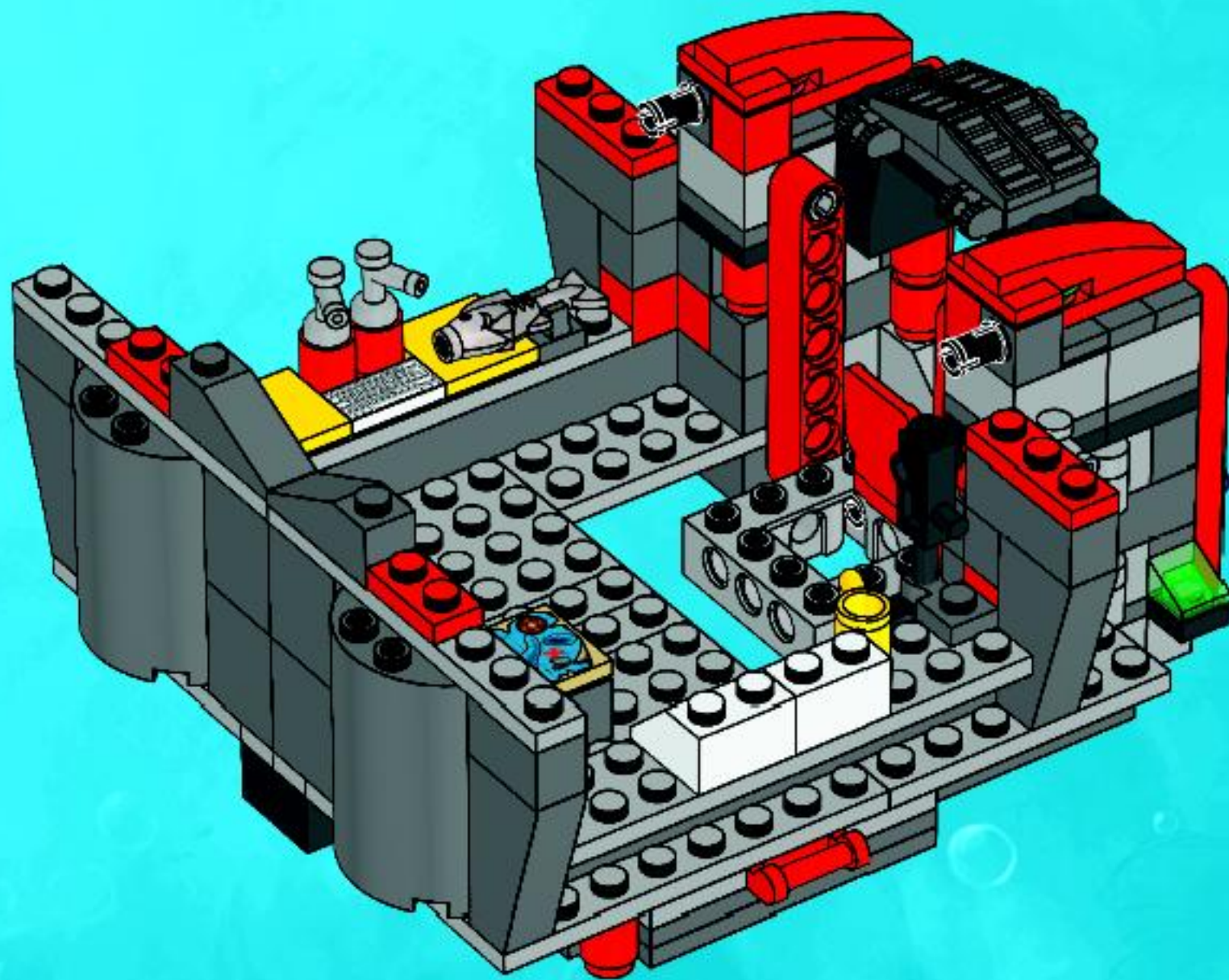

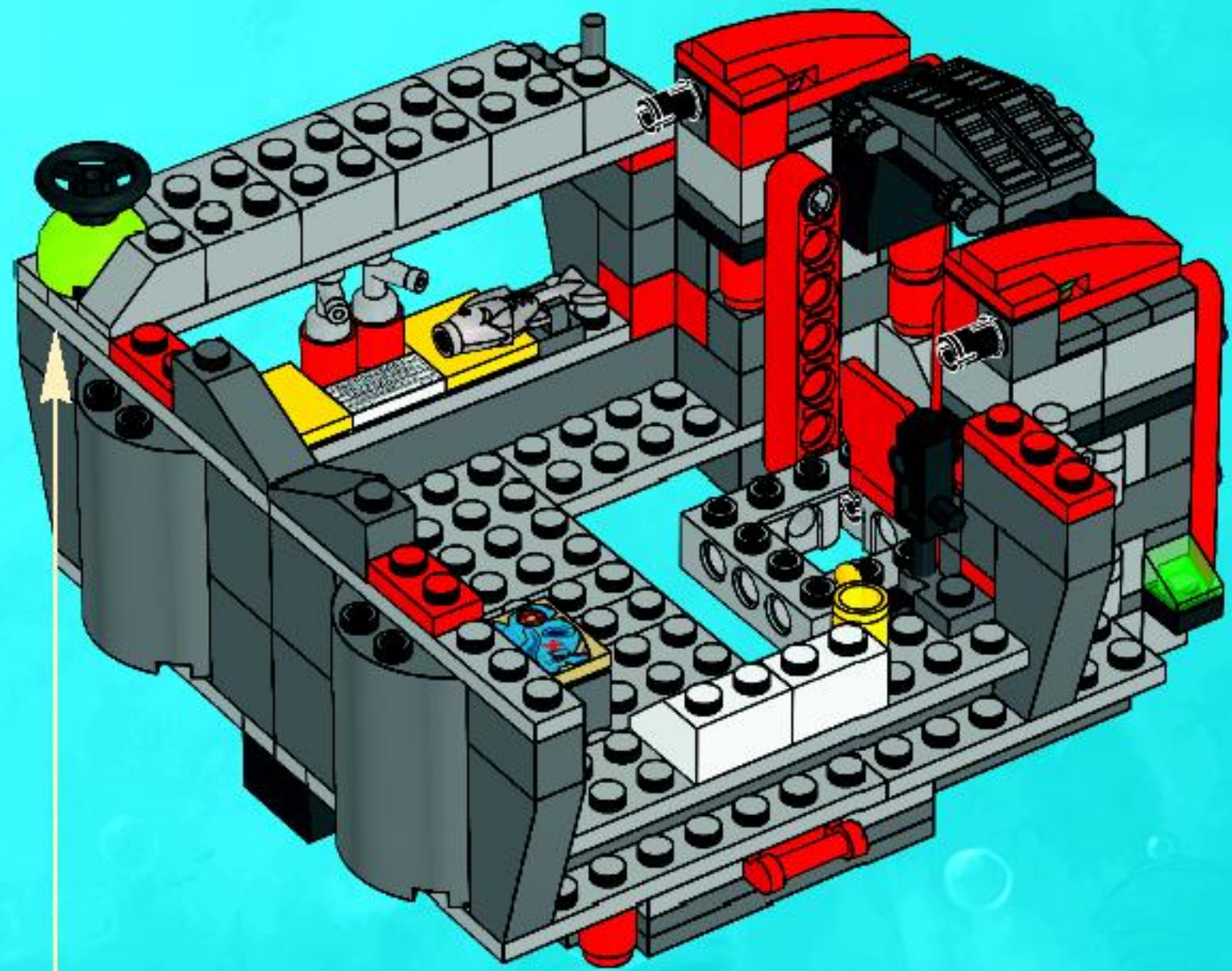

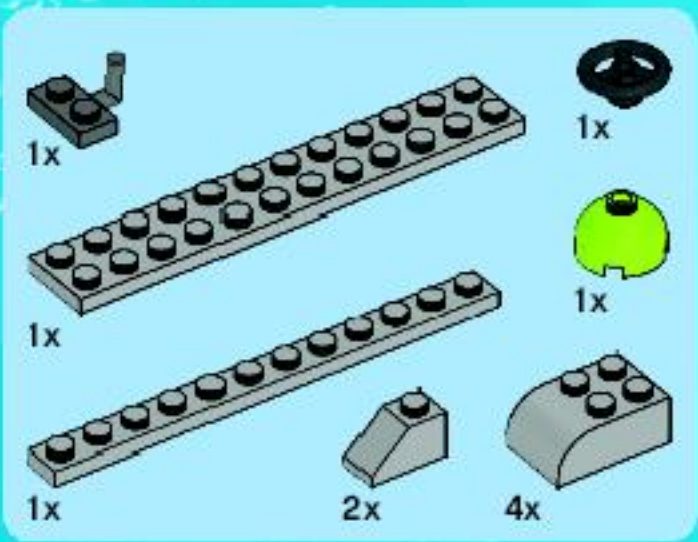

37

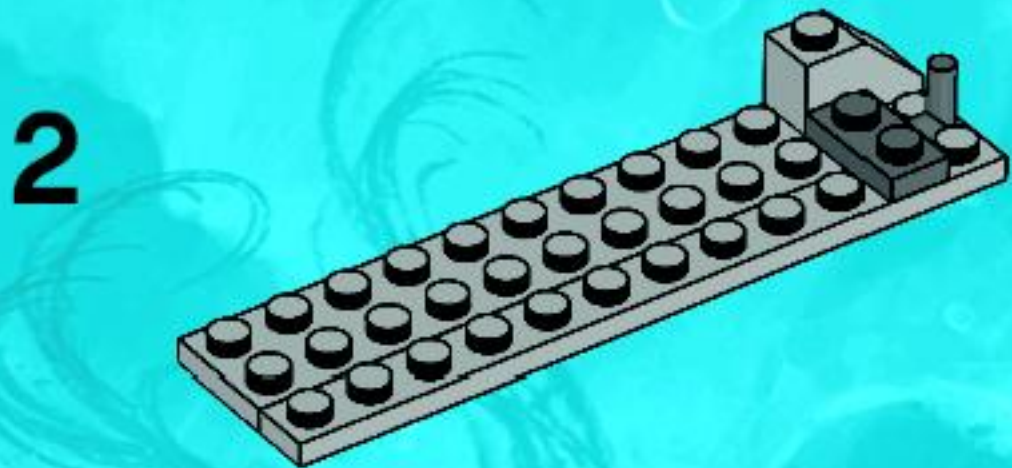
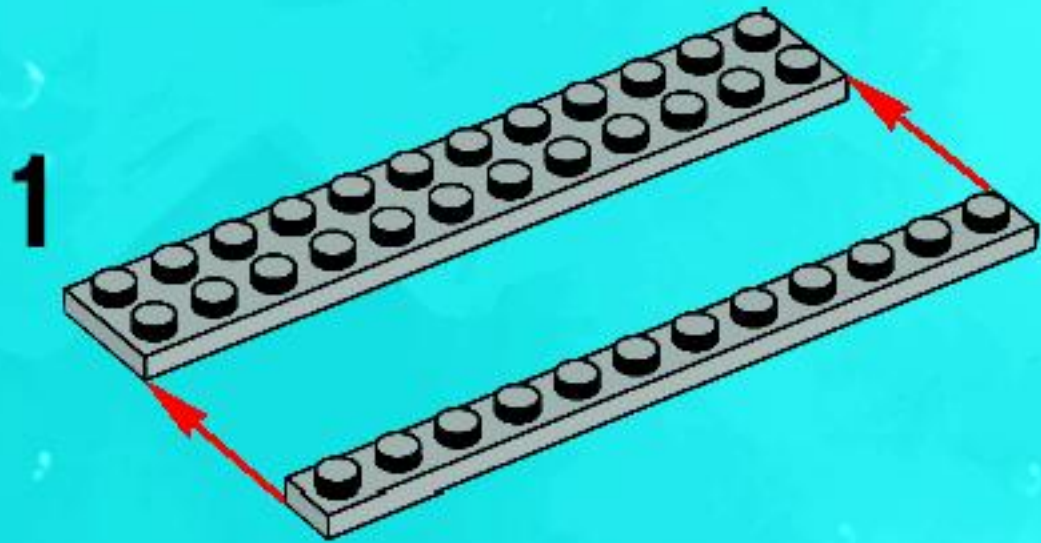

3

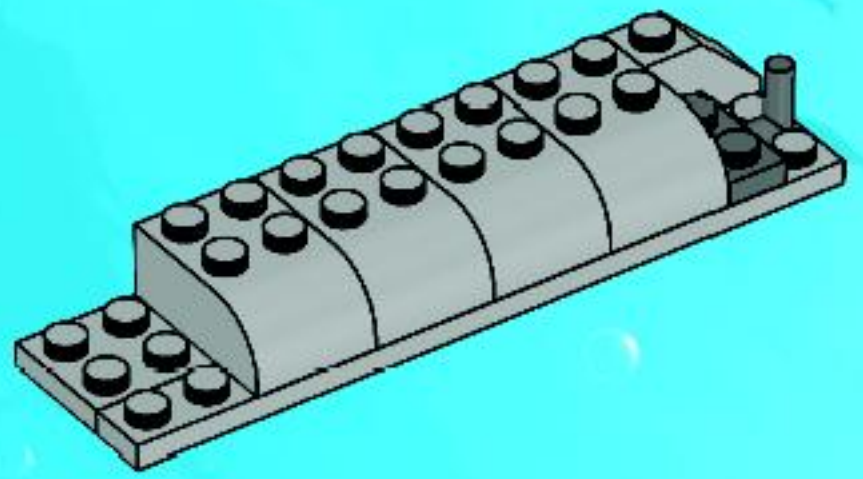

4

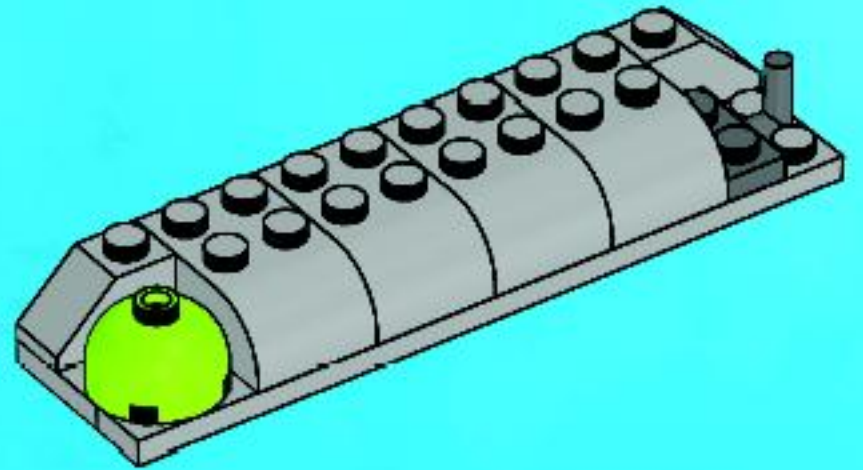

5

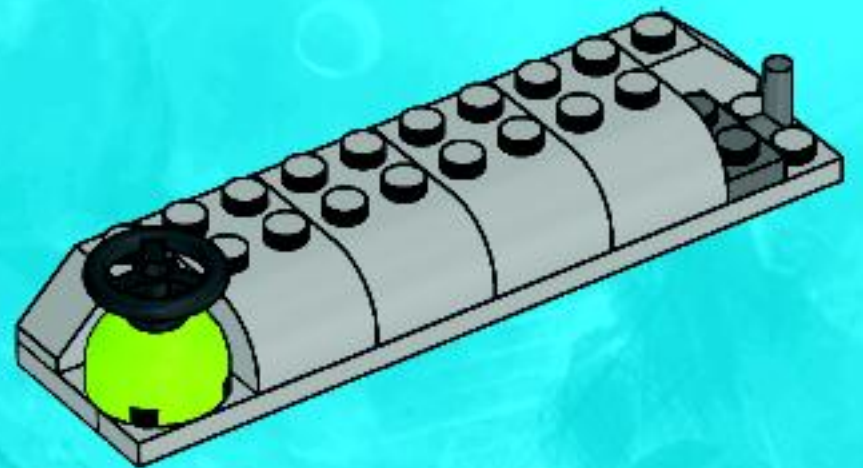

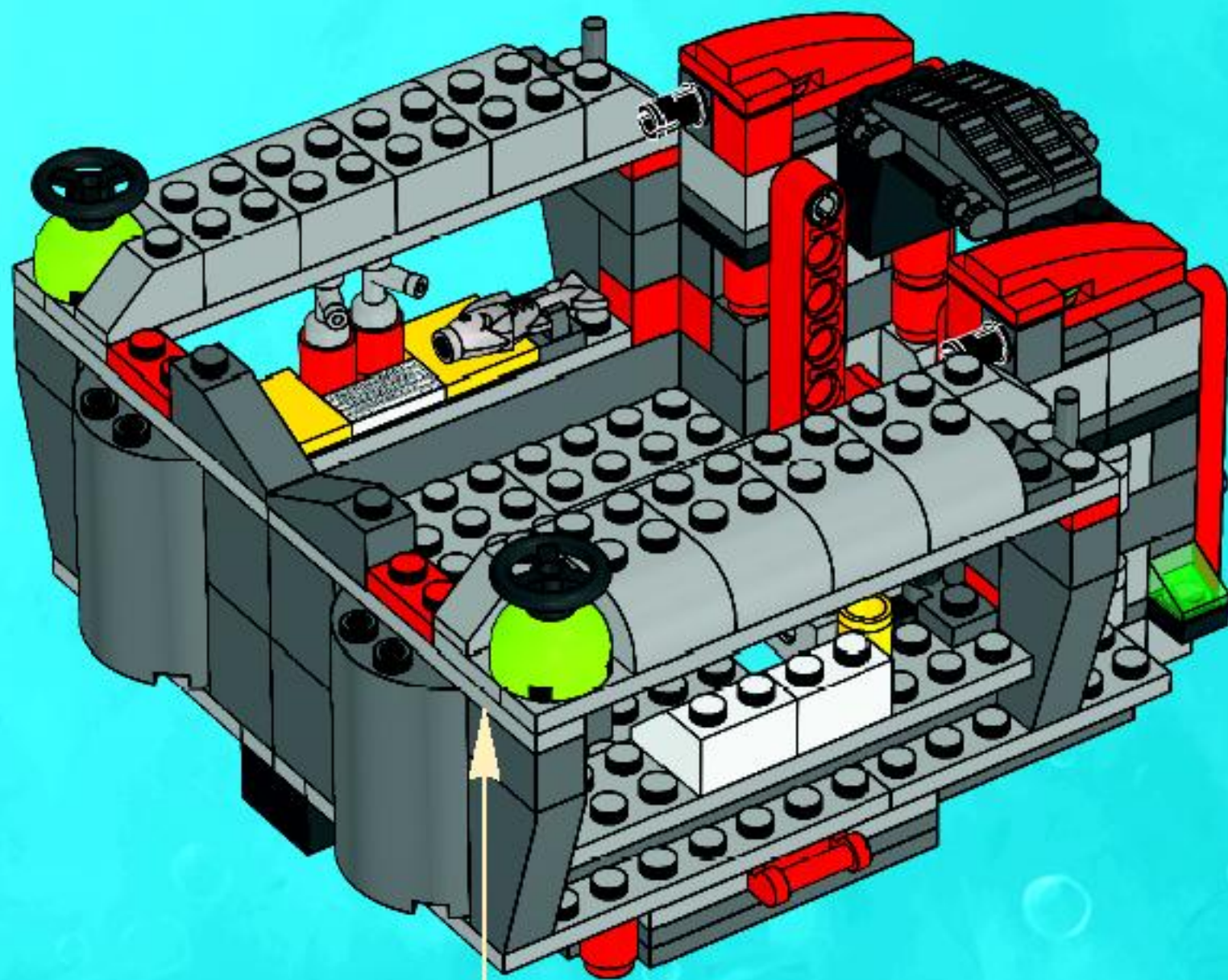

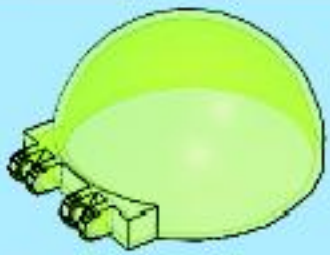

1x

38

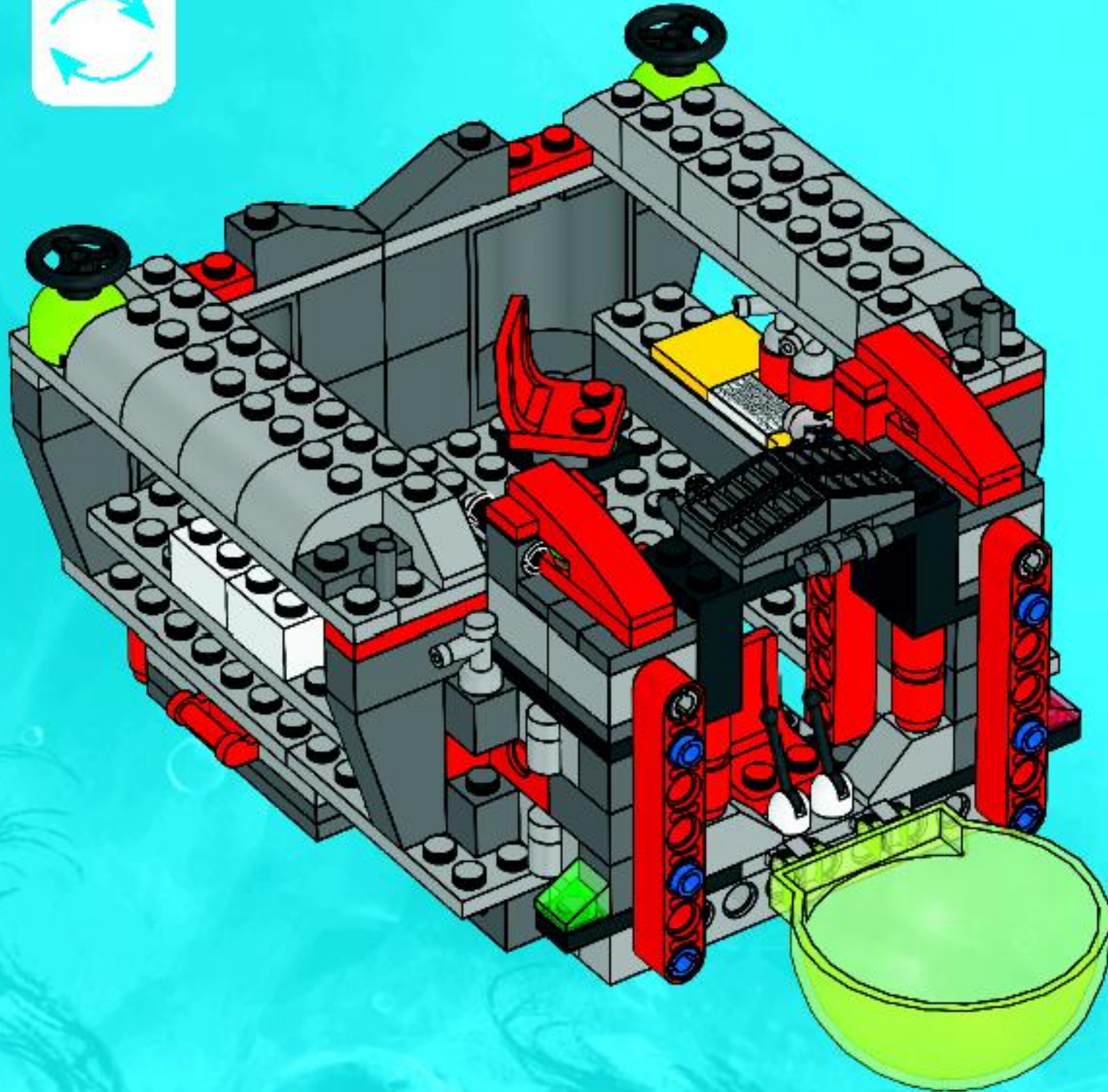

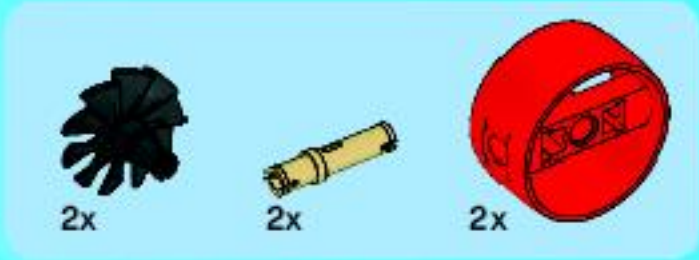

39

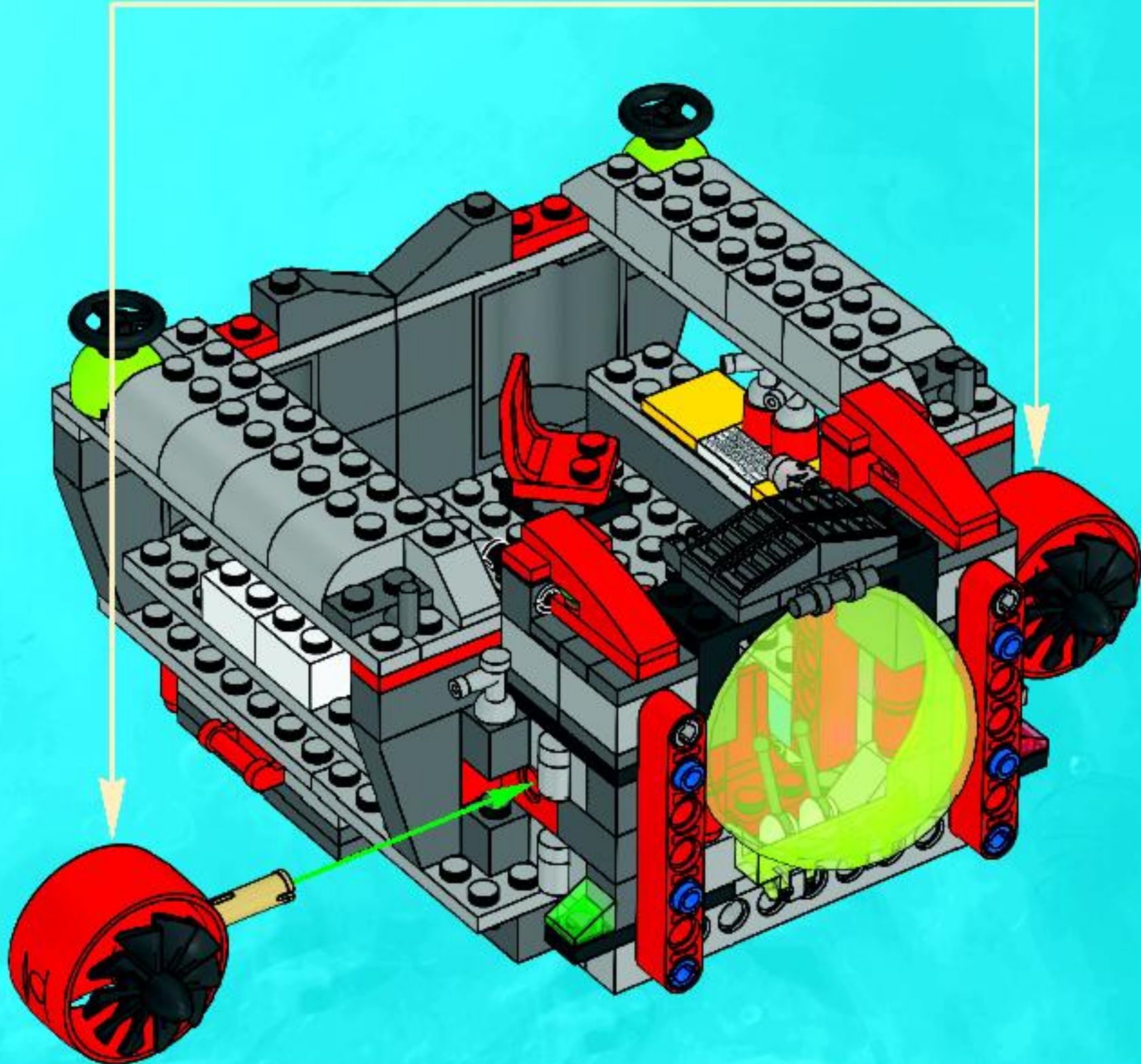
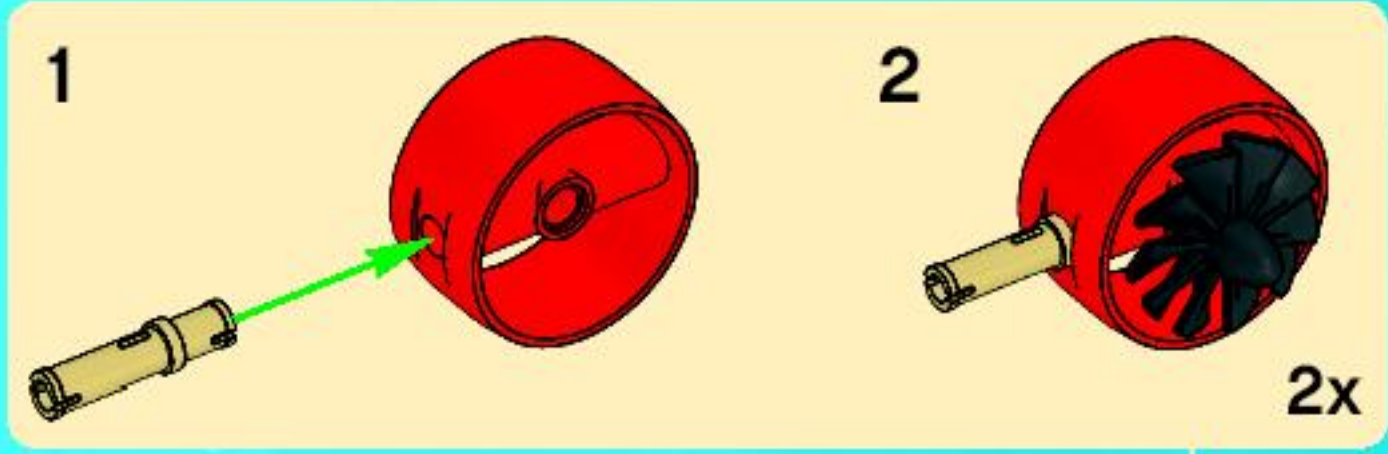

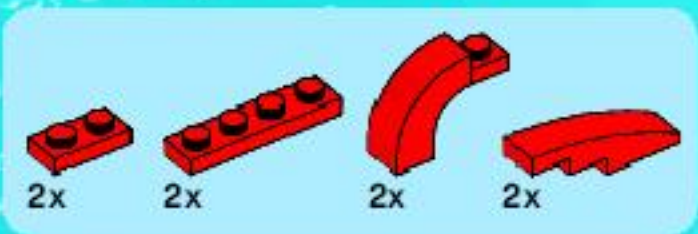

40

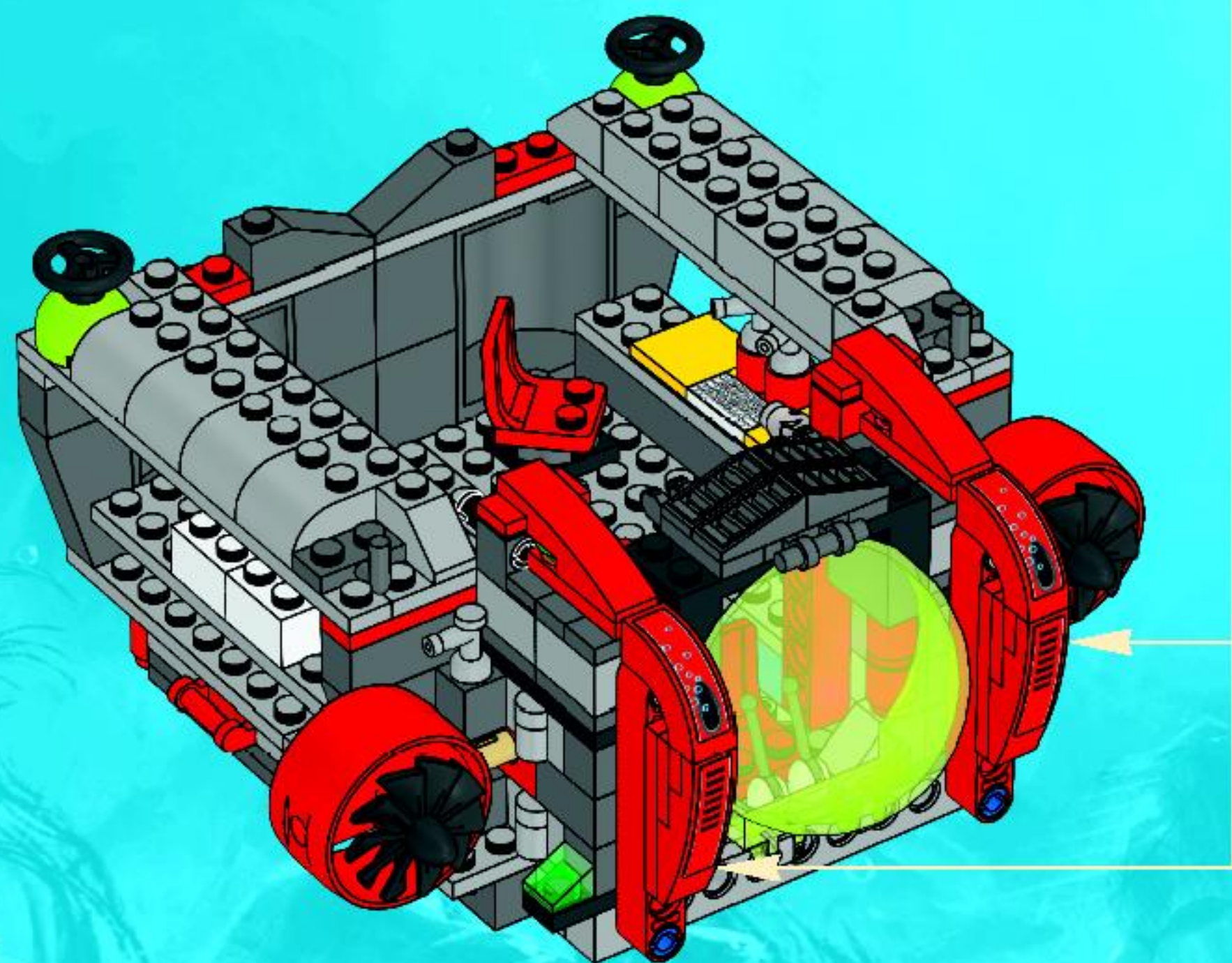
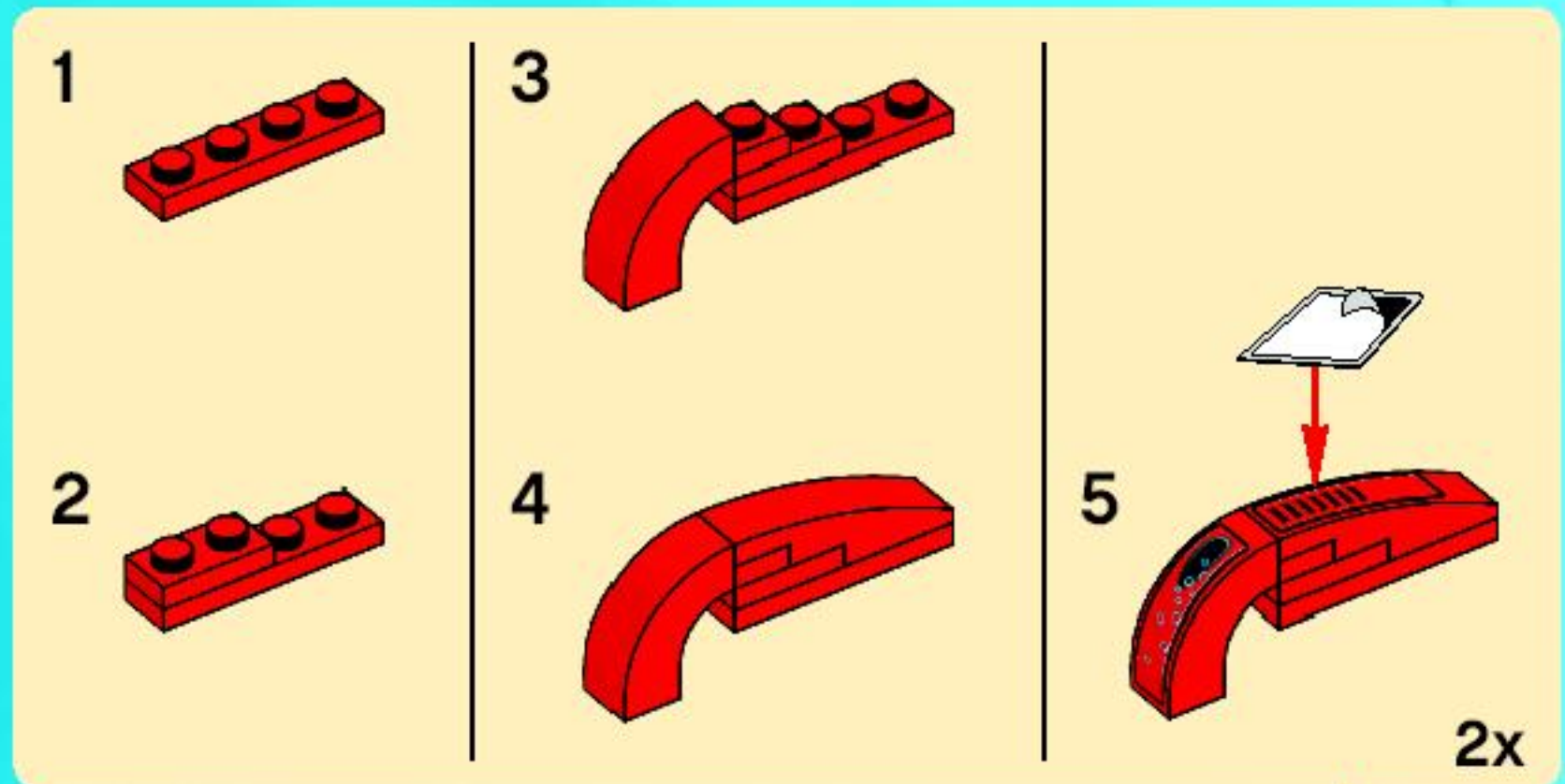



41



3



4



5



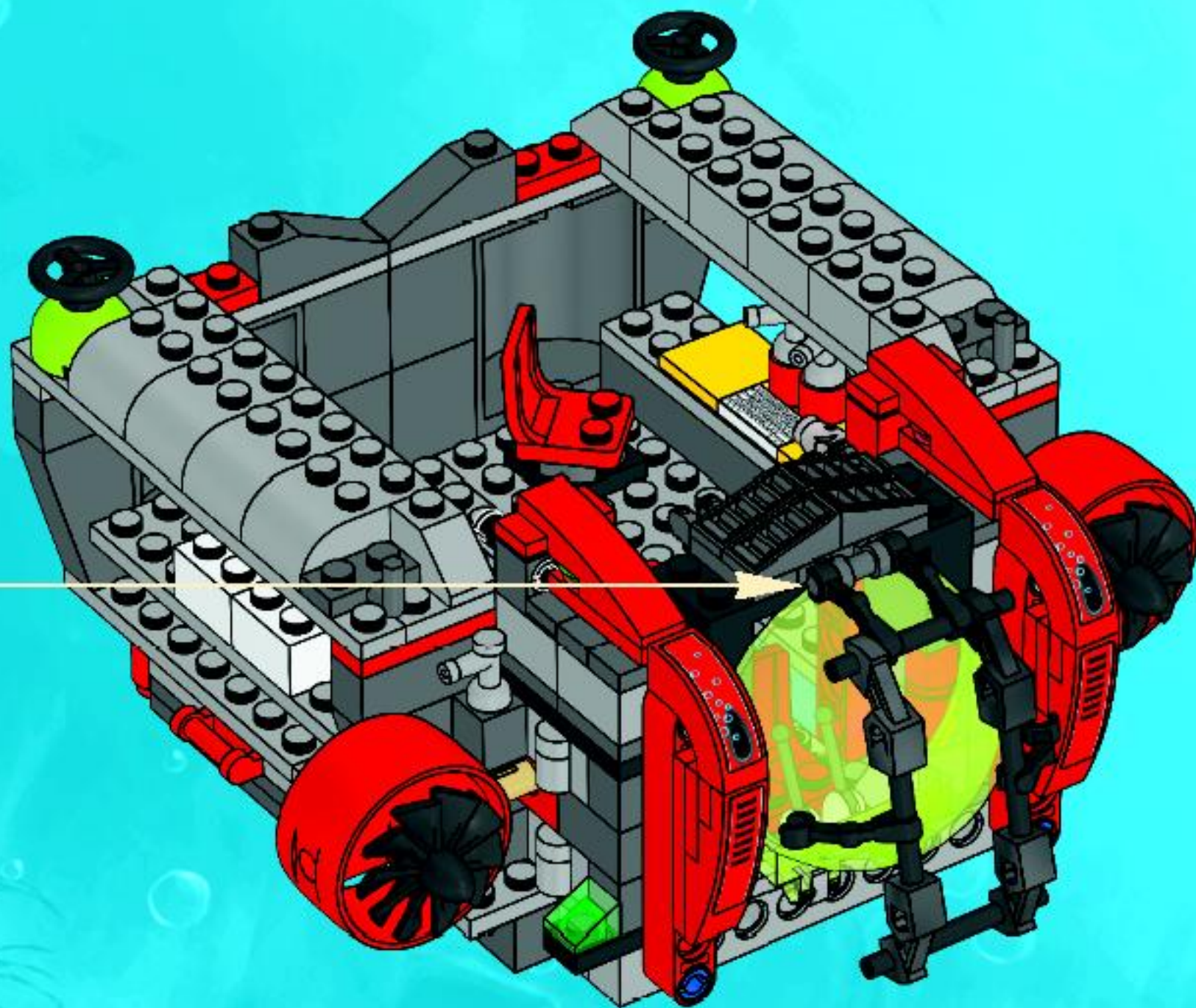

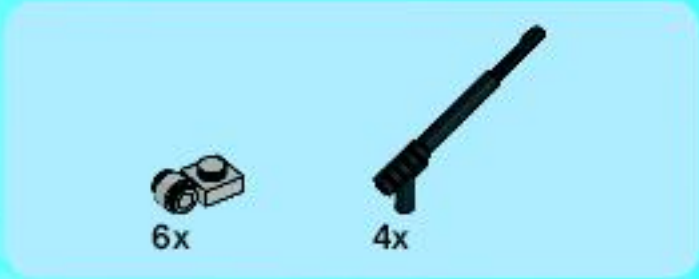

42

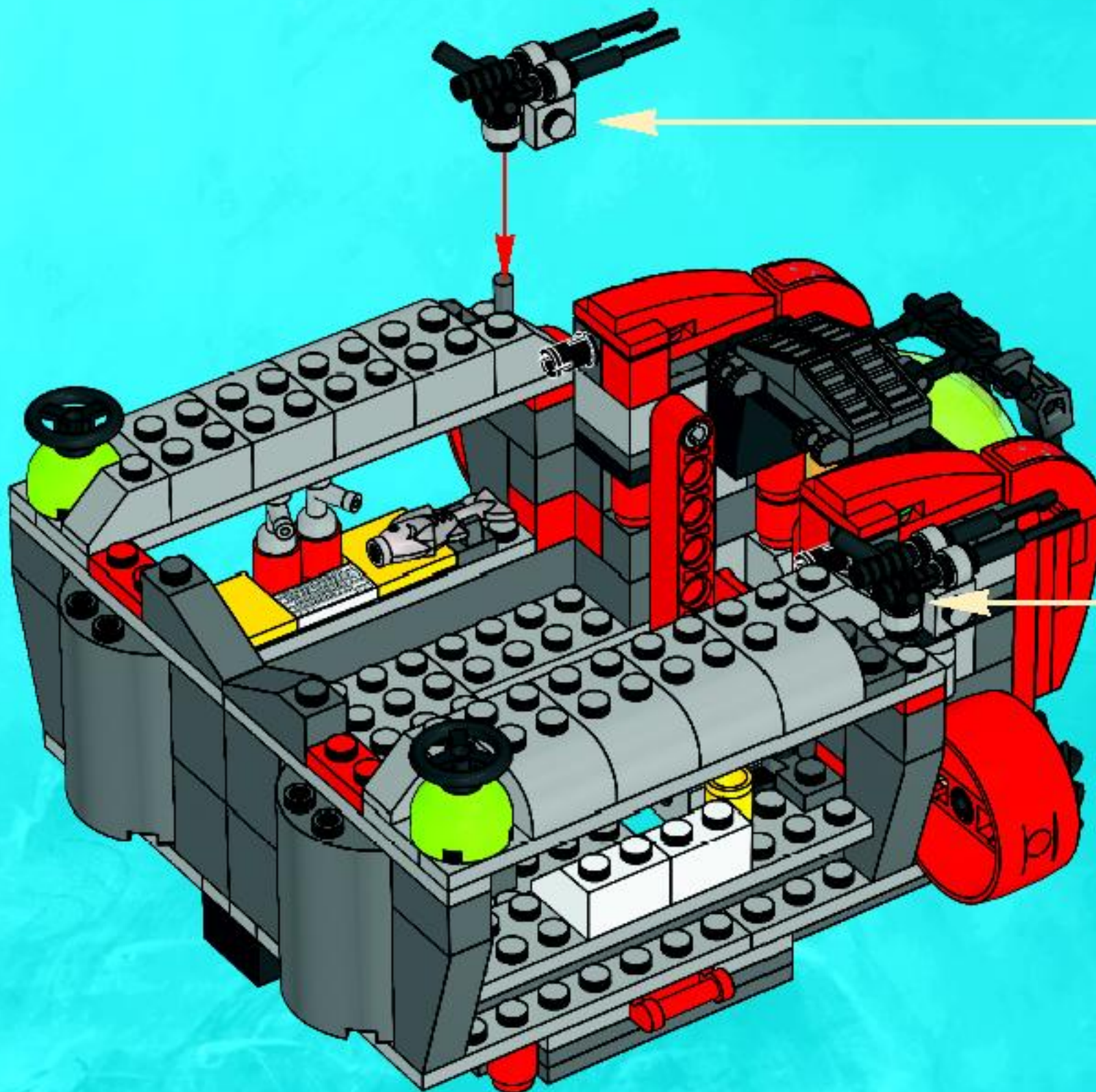
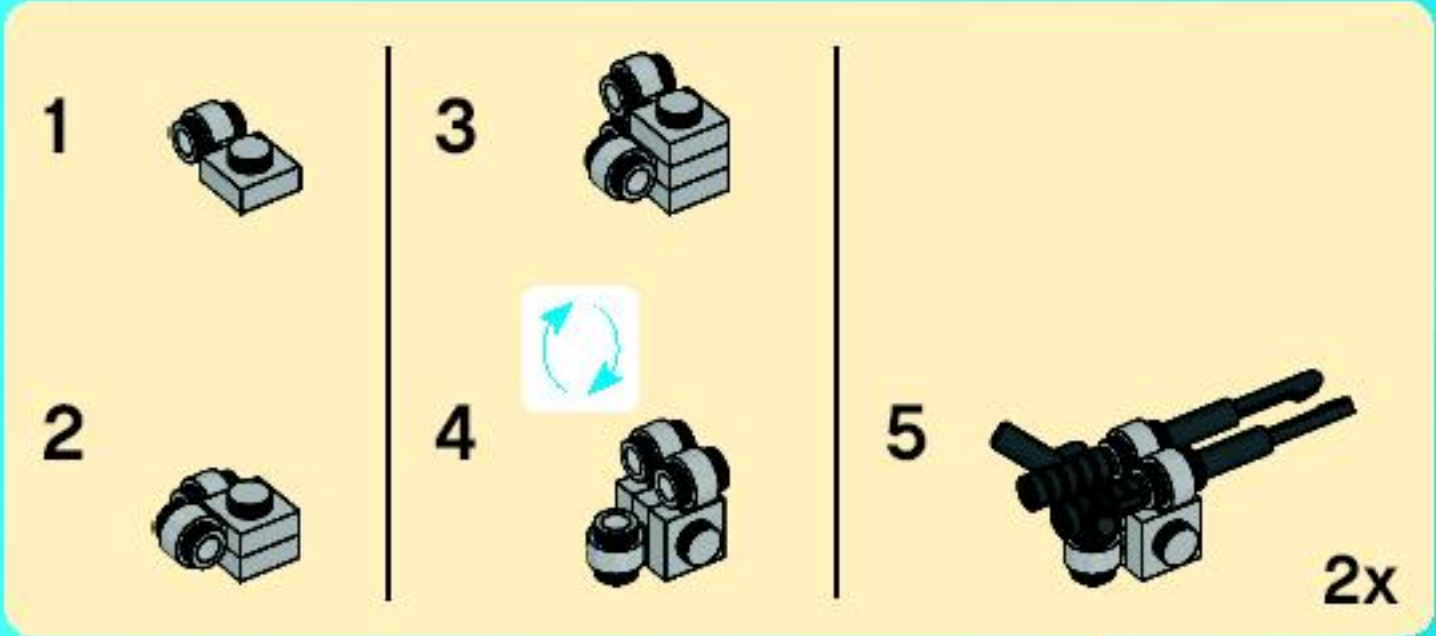

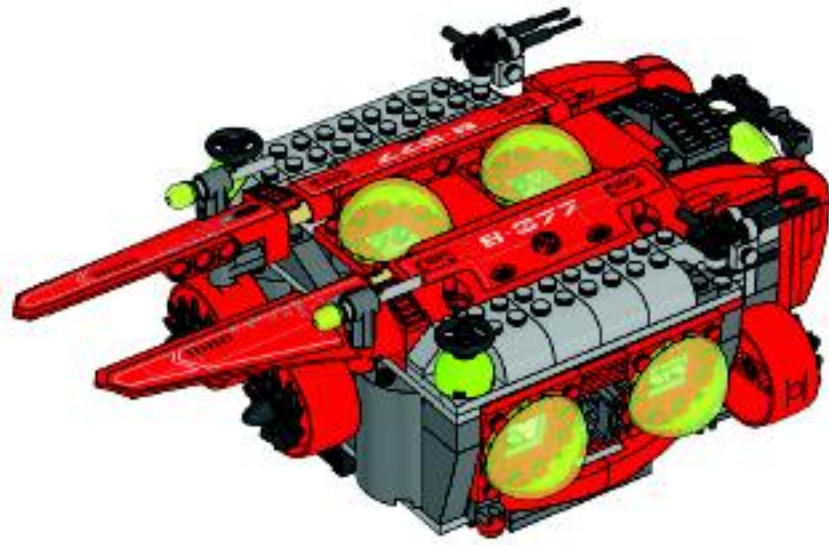

2x



1x



1x

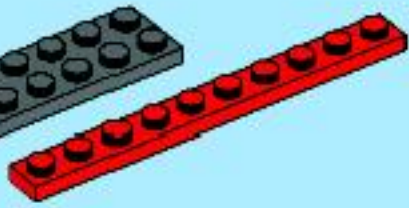

1x

1

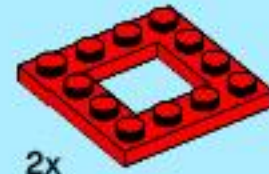
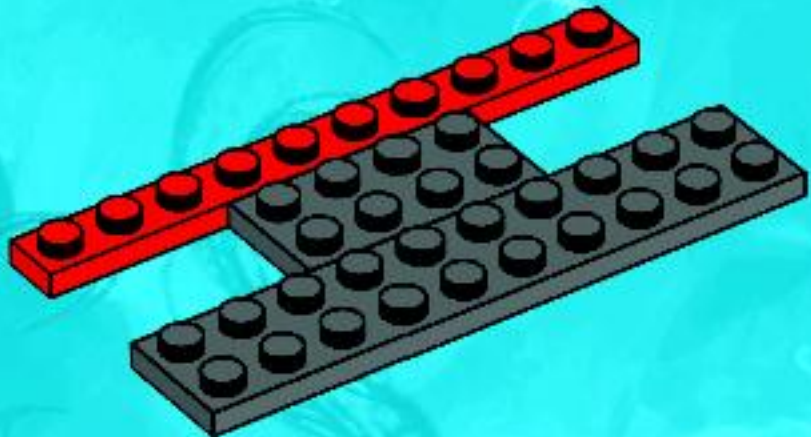

2x

2

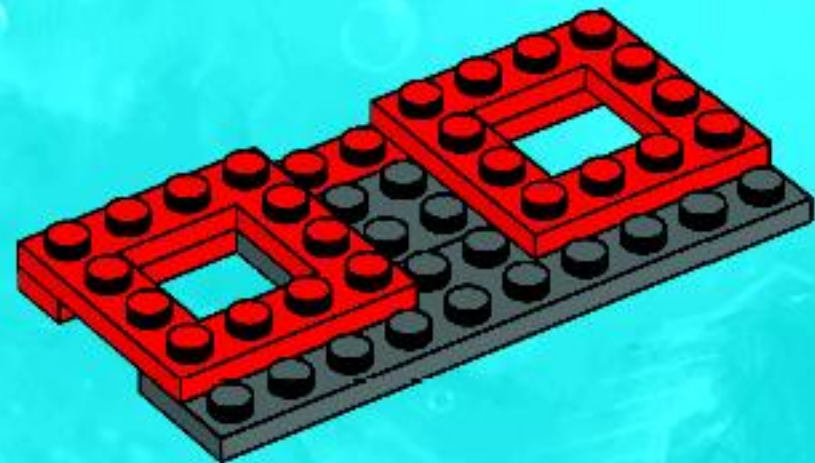



2x



1x

3

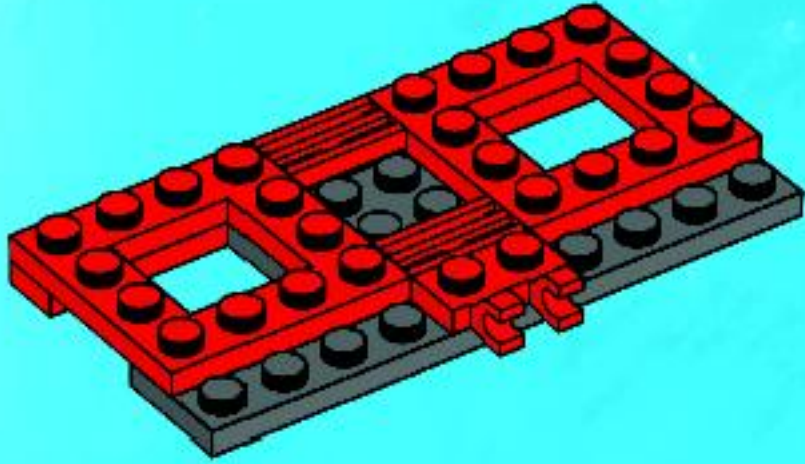

2x



2x



1x

4

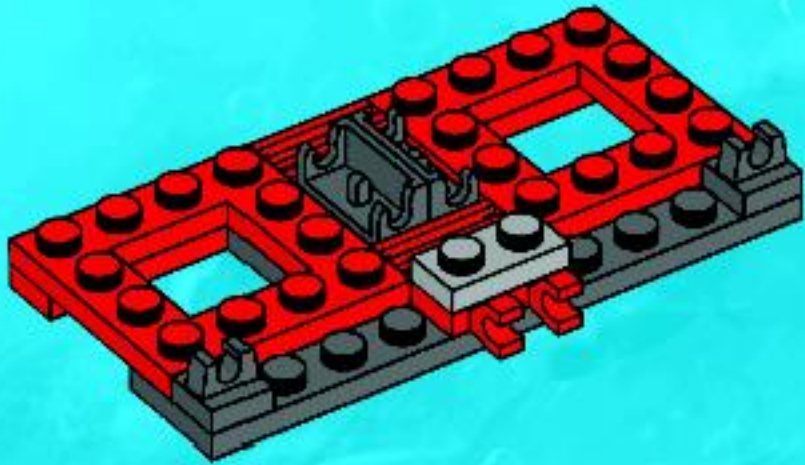

2x

5

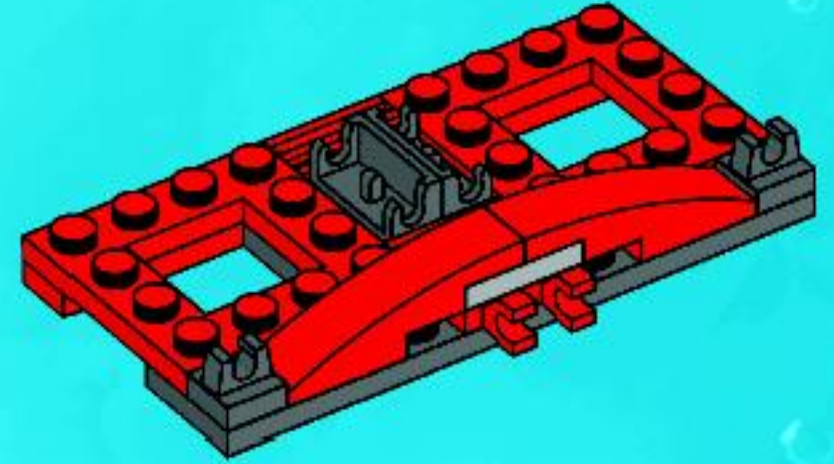

2x

6

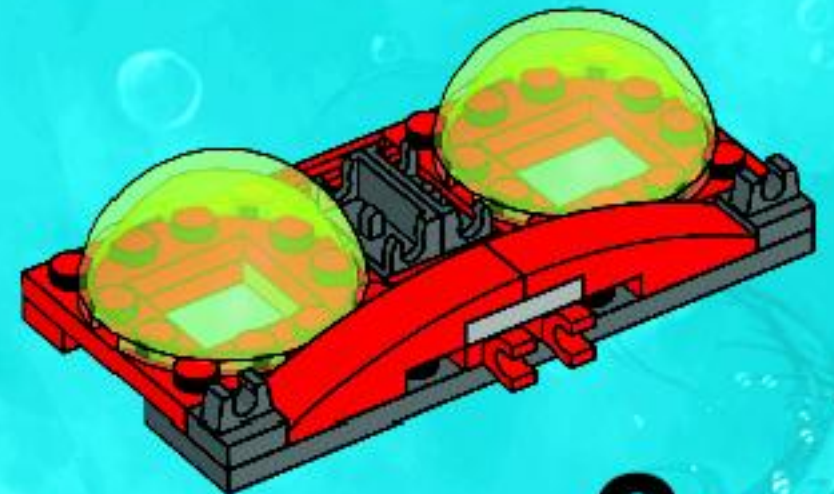

2x

43

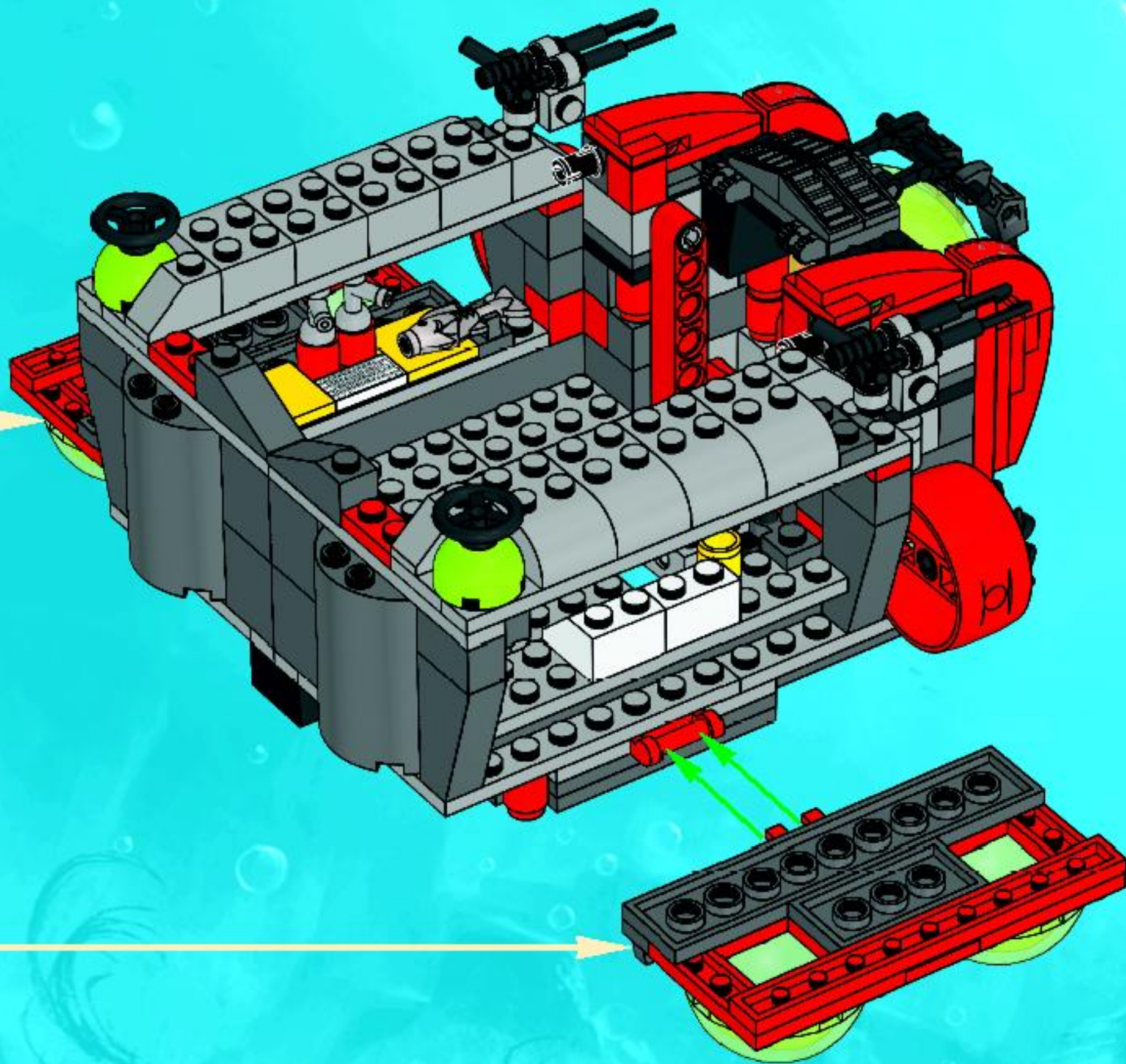

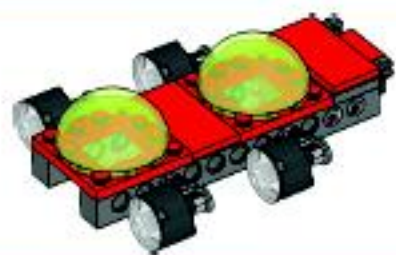

2x



3x

1

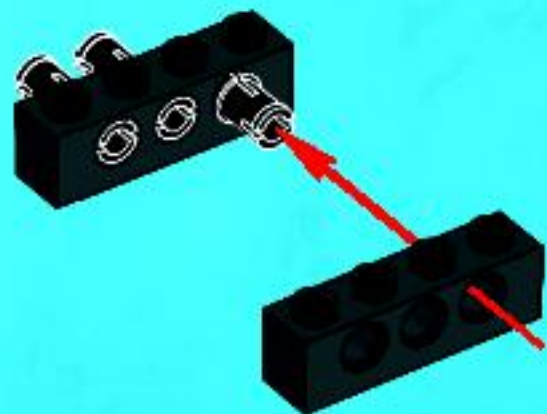

2x

2

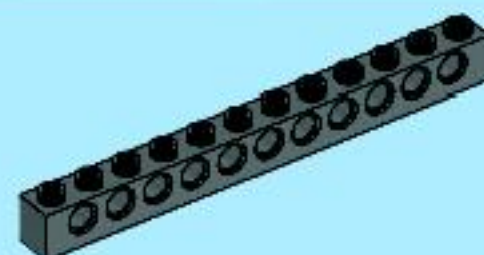
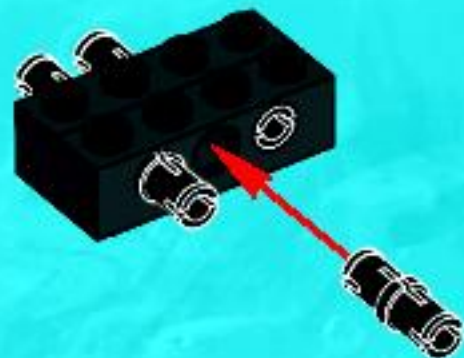

2x

3

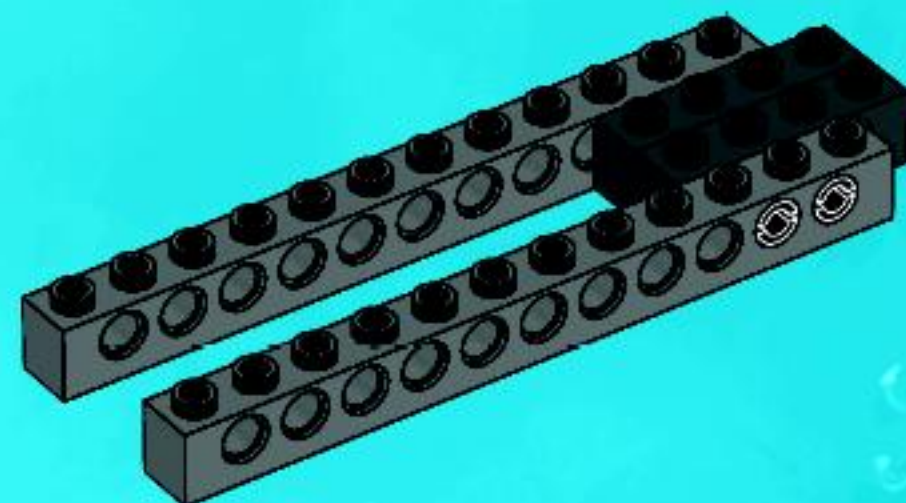

1x



2x



1x

4

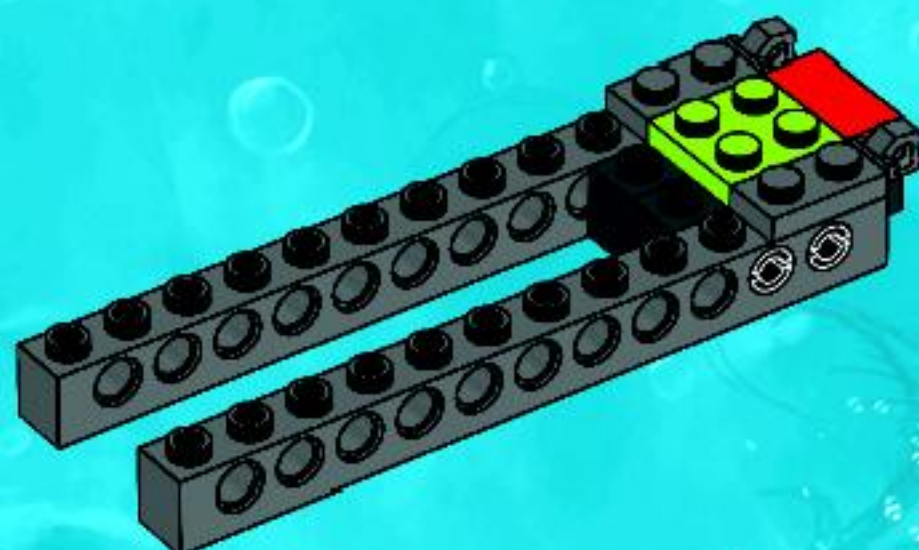



5

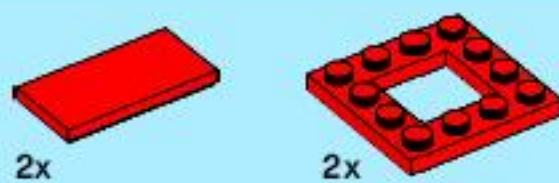
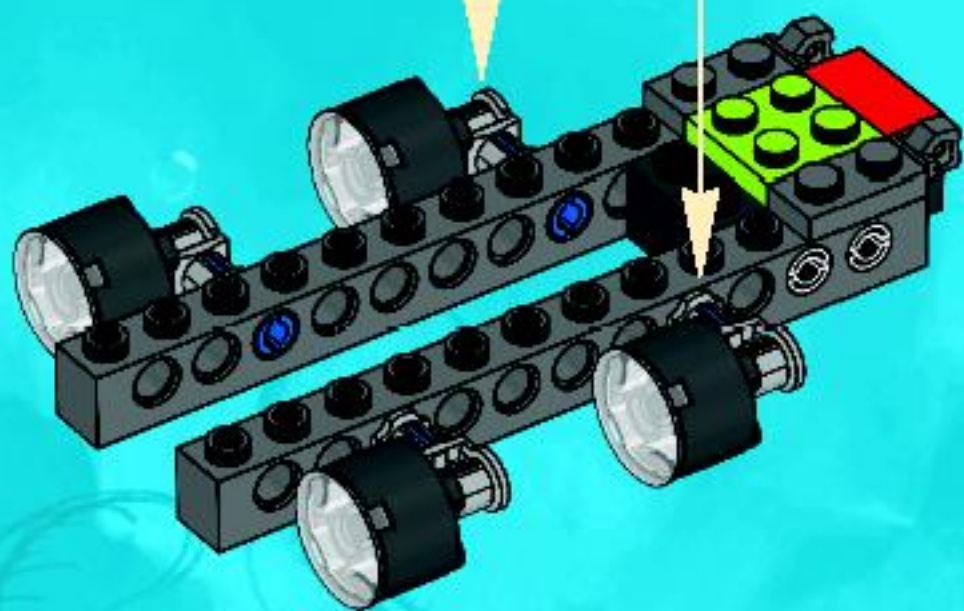
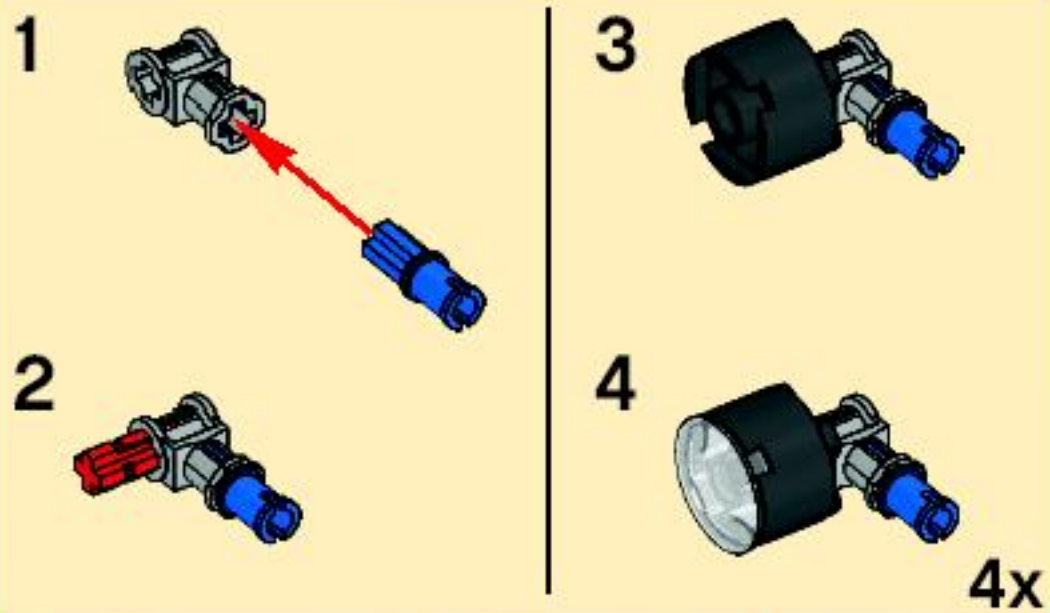

6

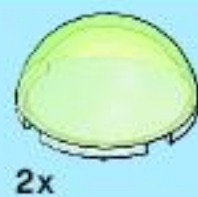
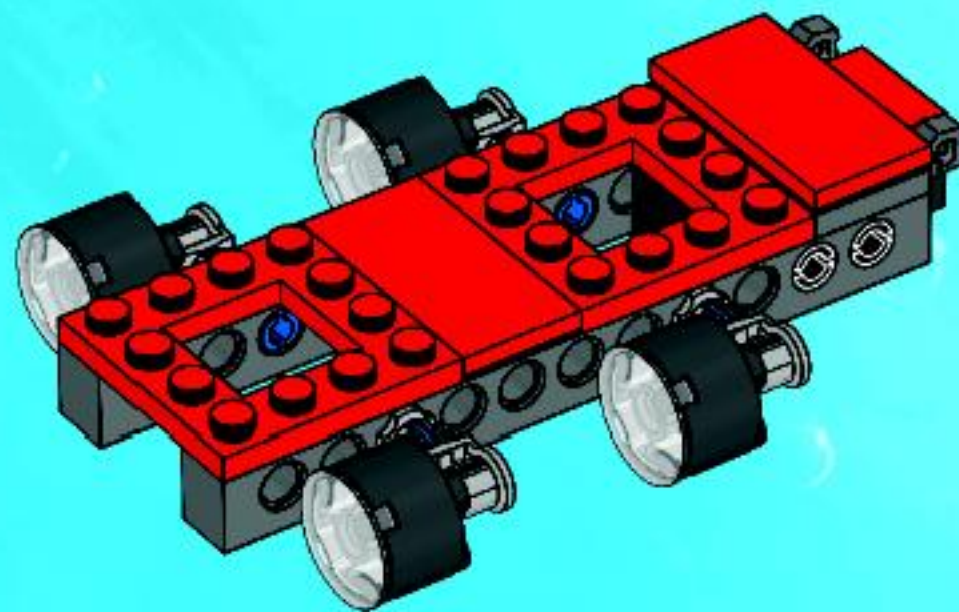

7

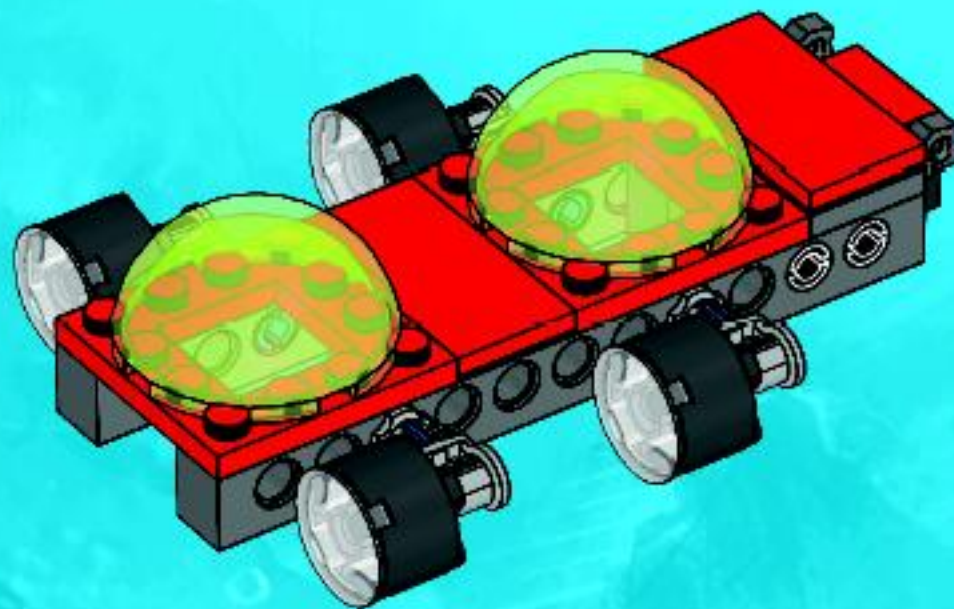

44

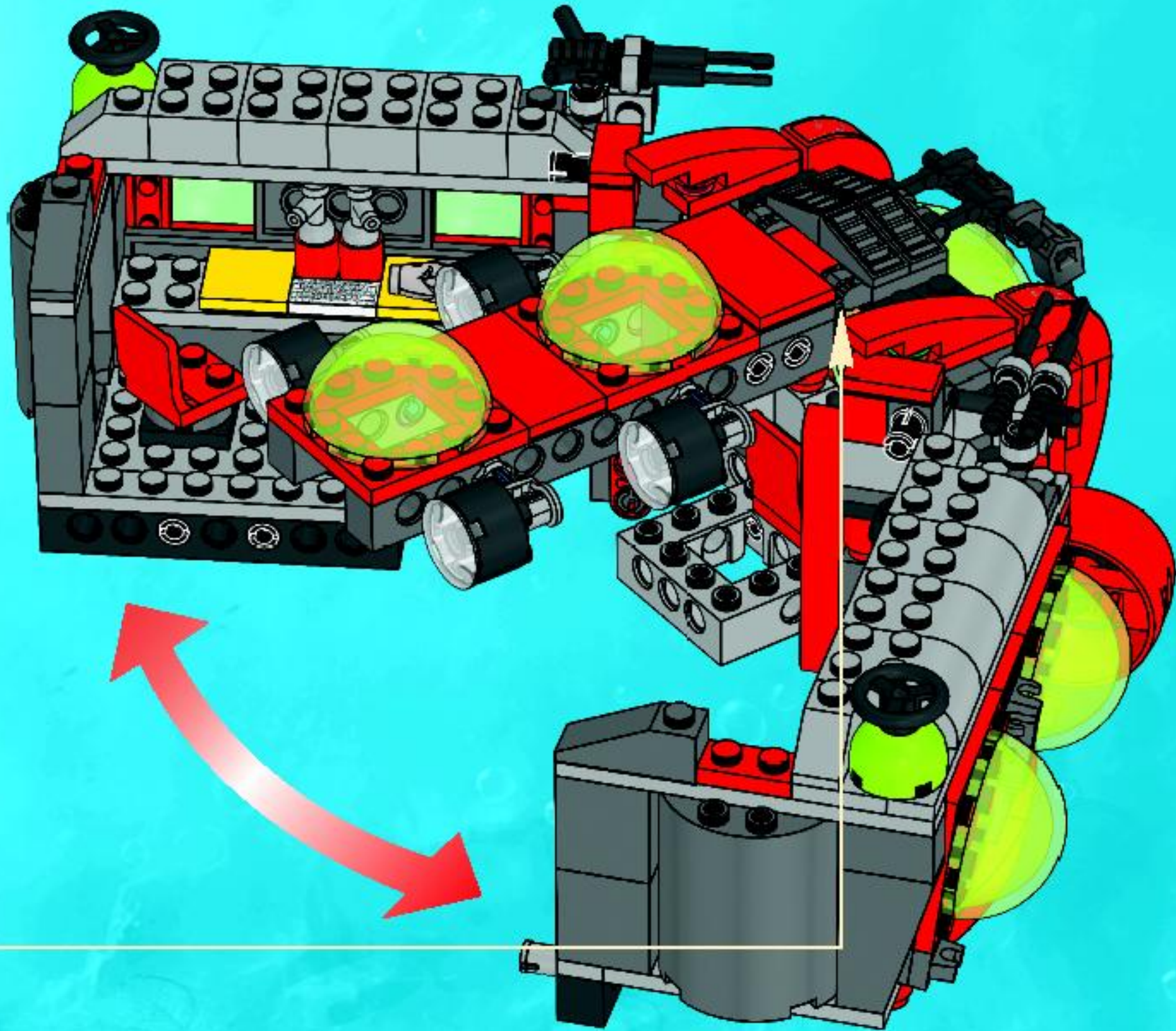

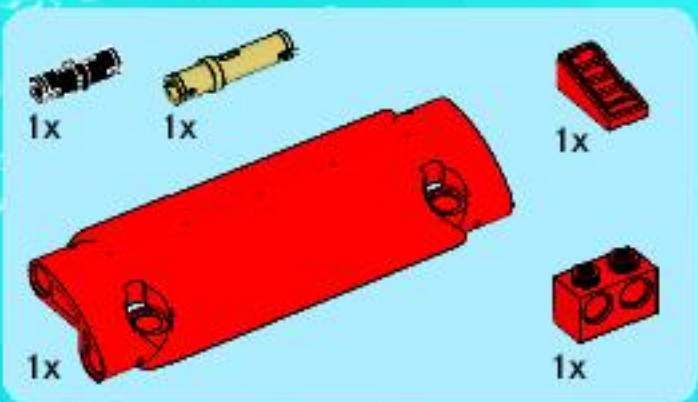

45

1

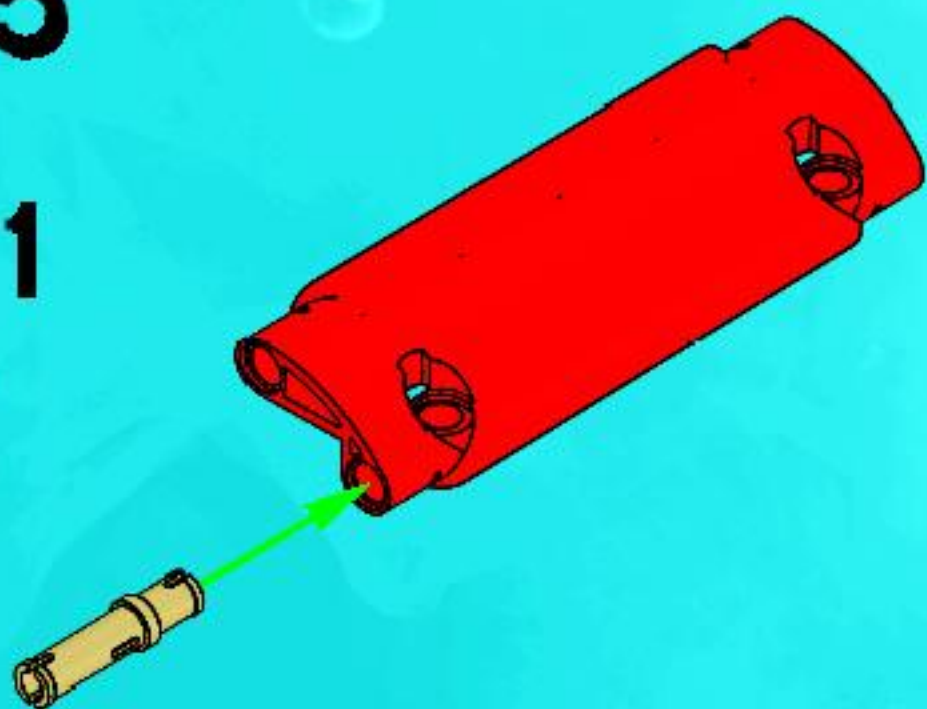

2

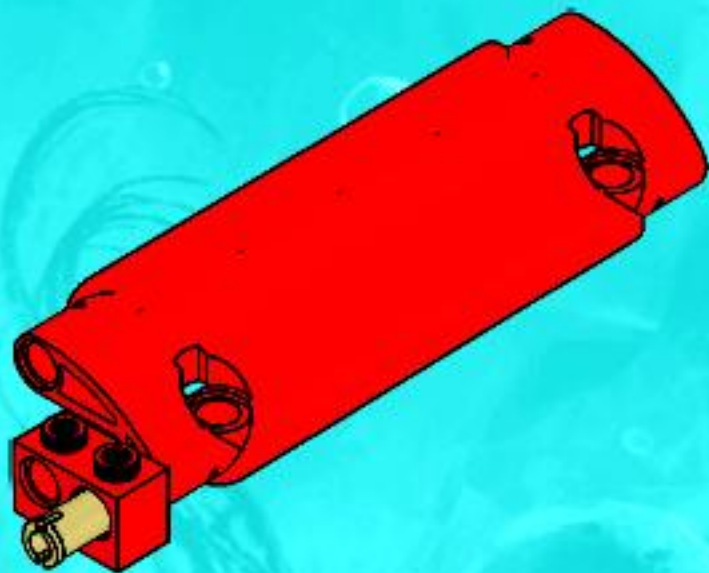

3

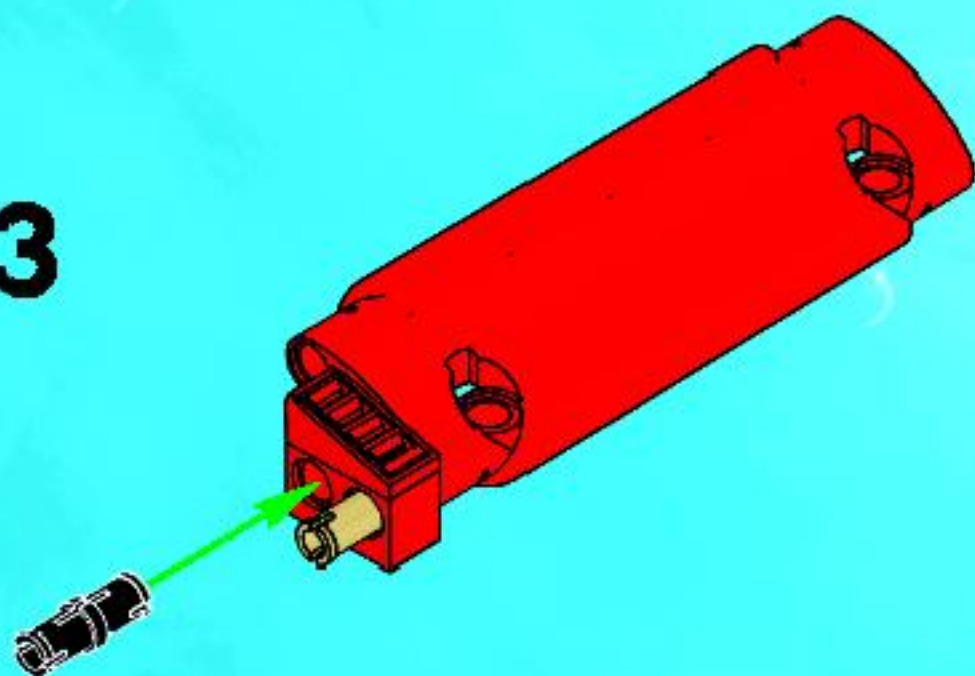

4

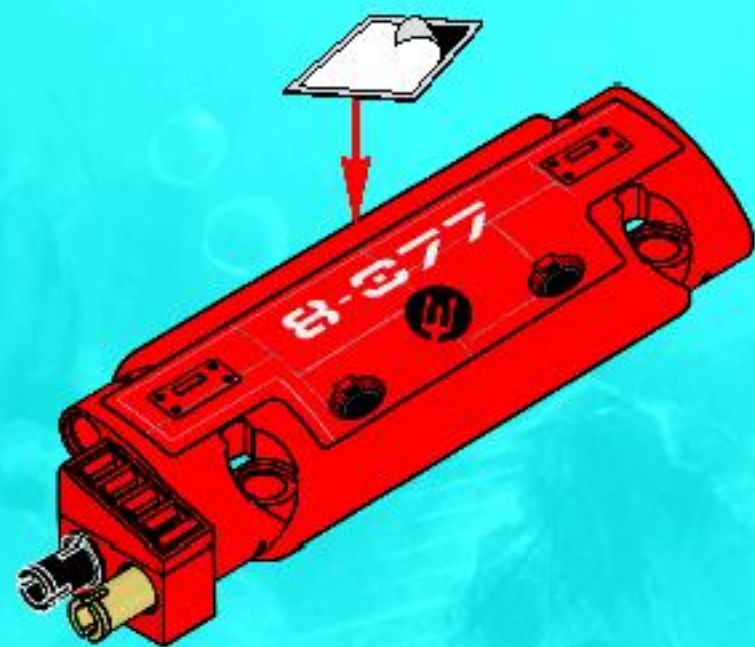

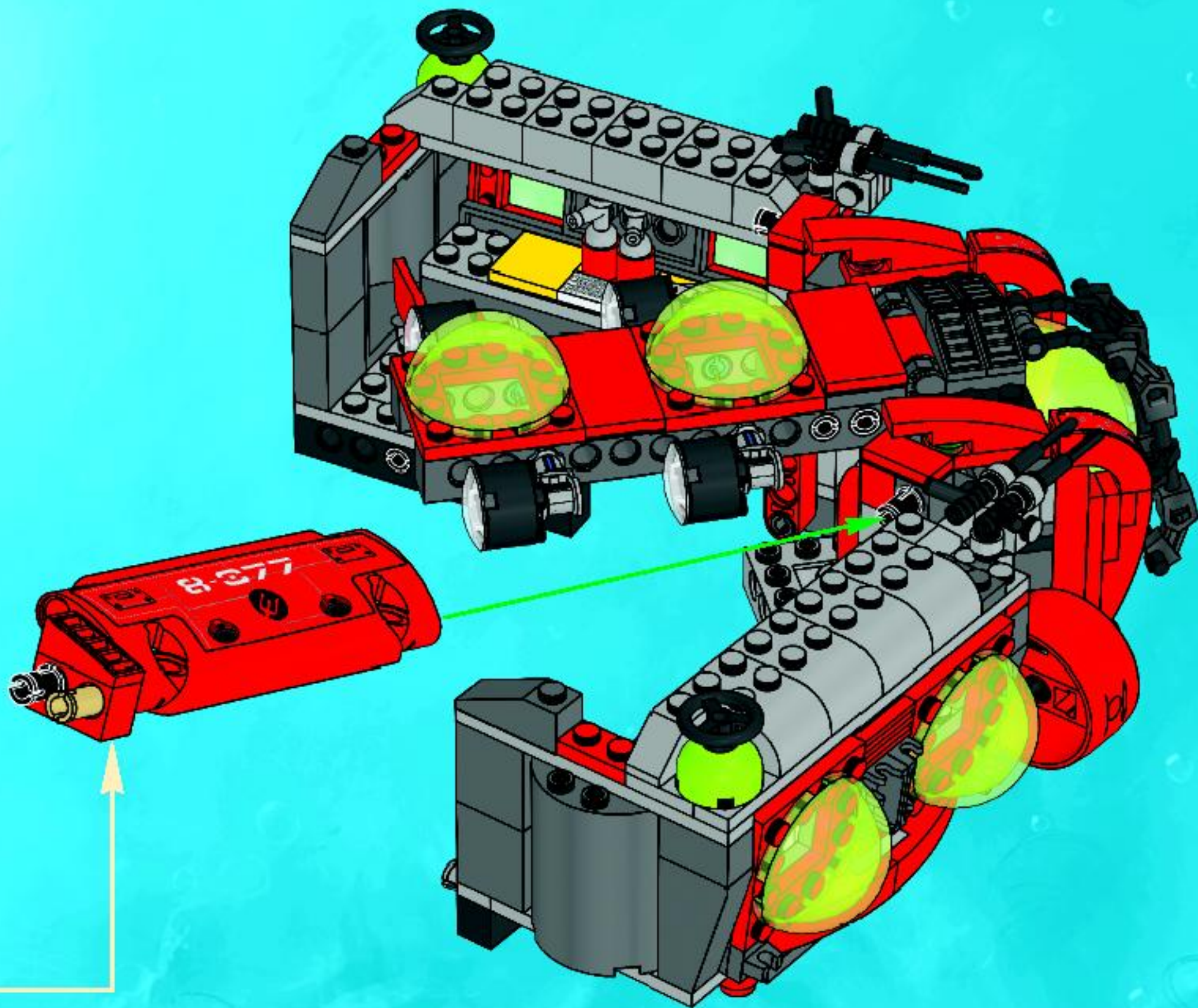

46

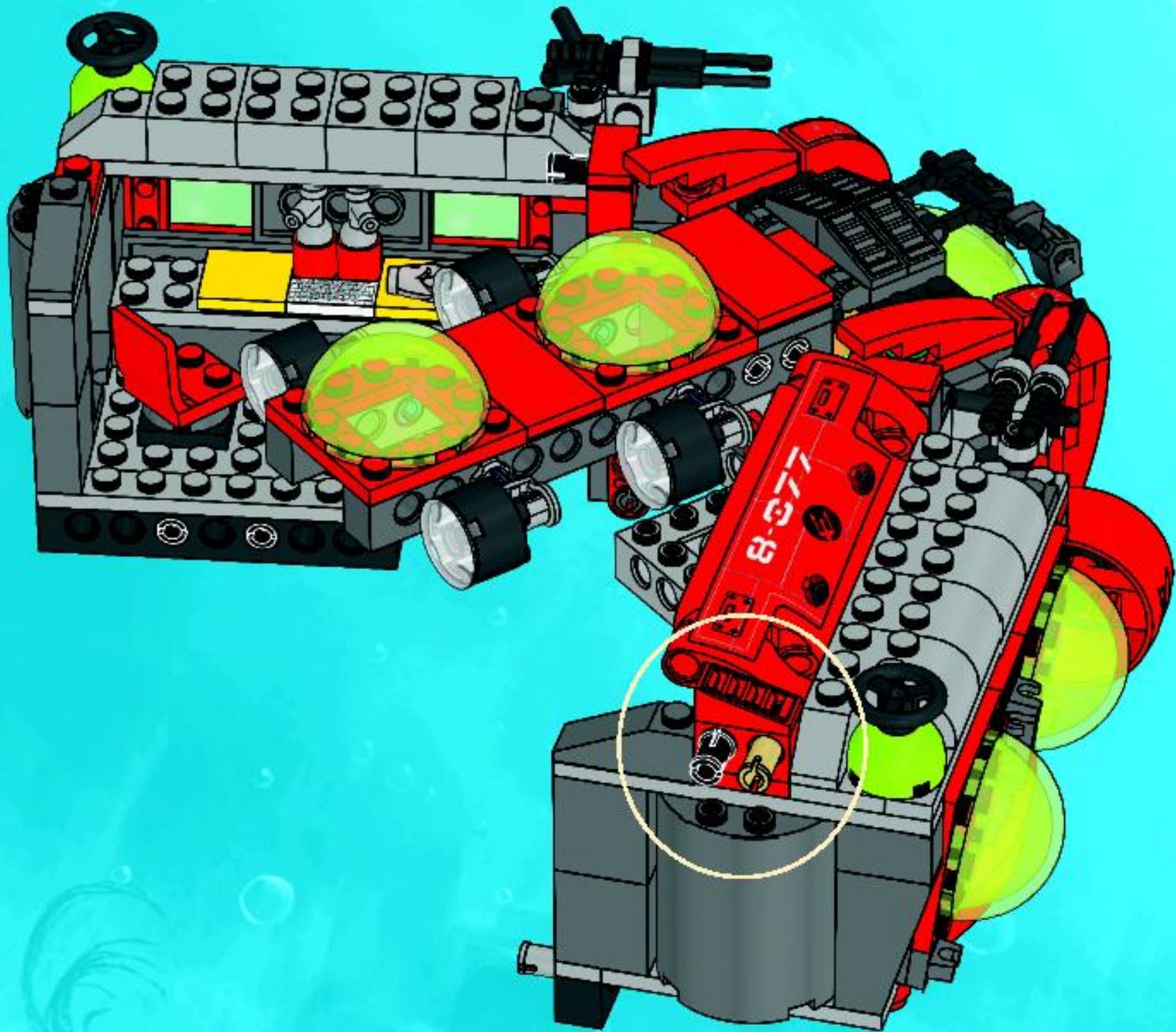

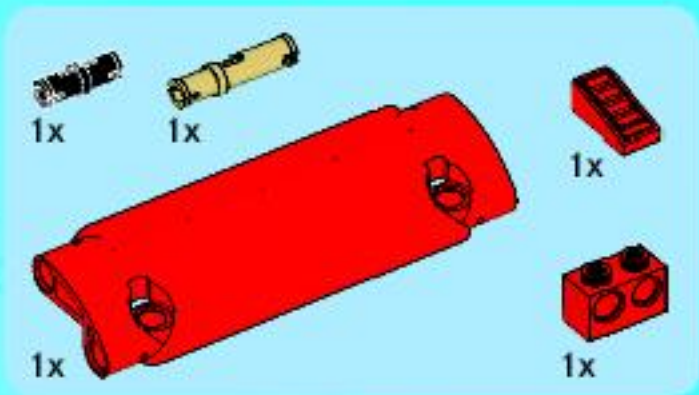

47

1

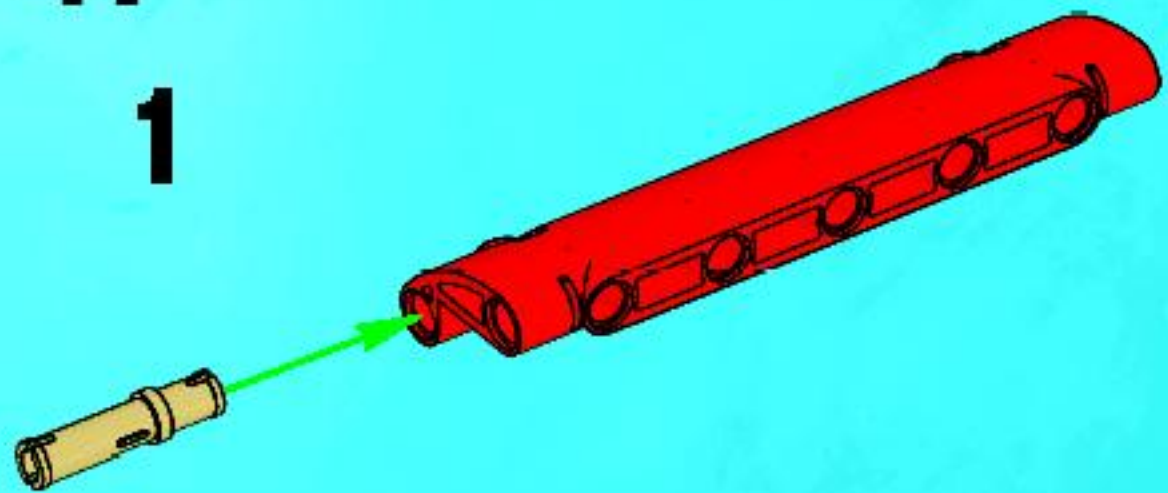

2

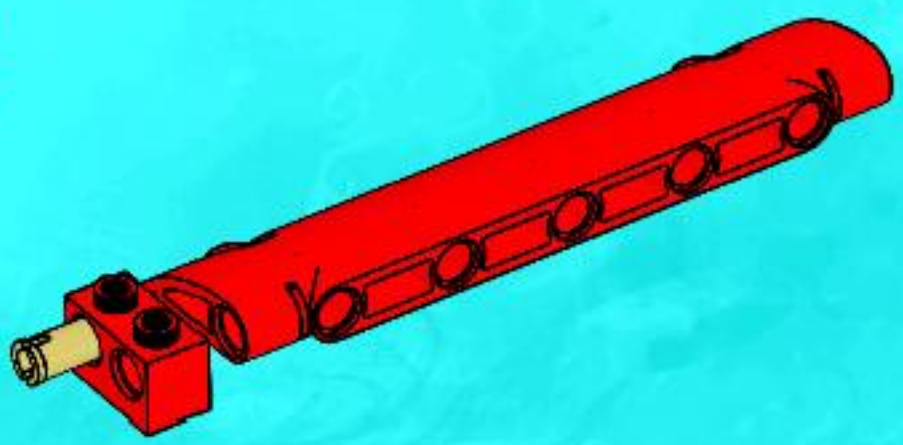

3

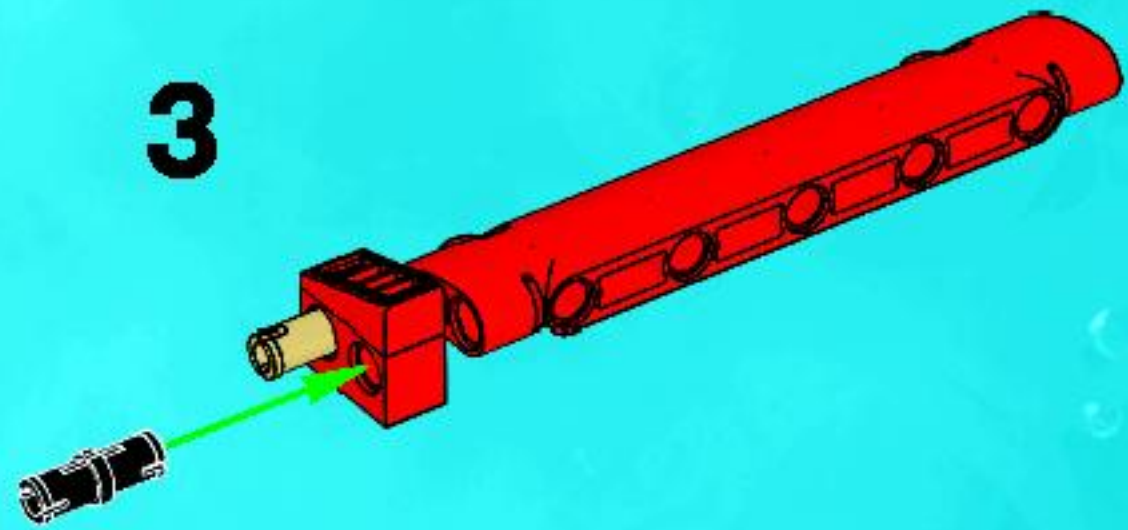

4

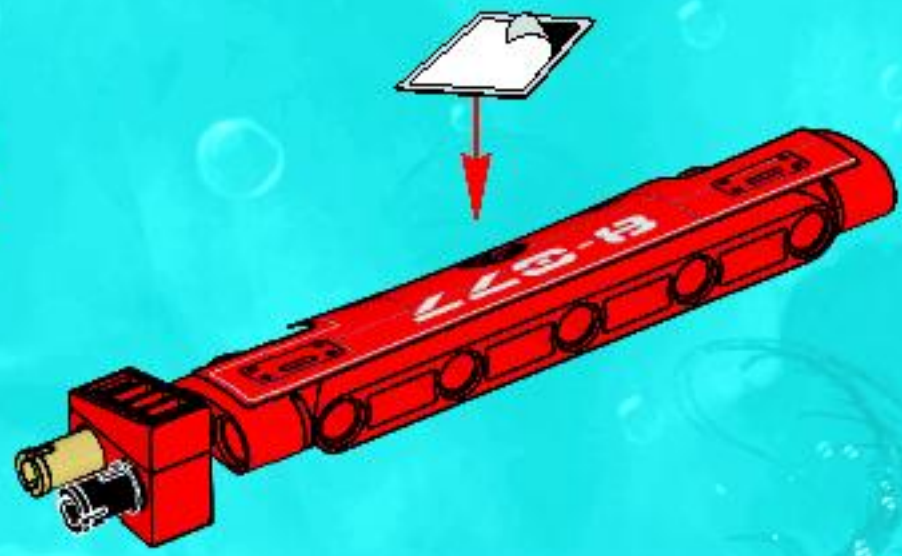

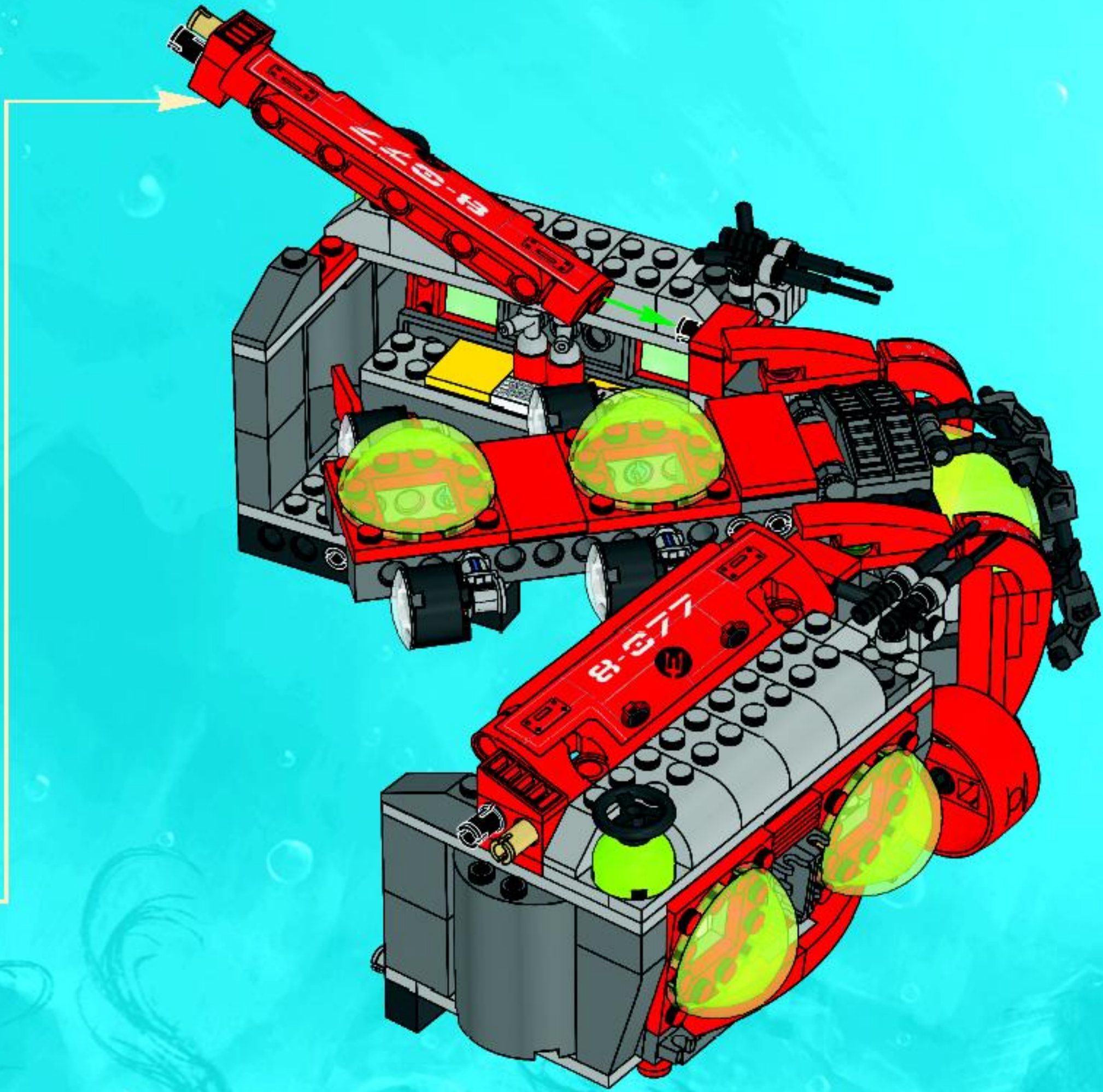

48

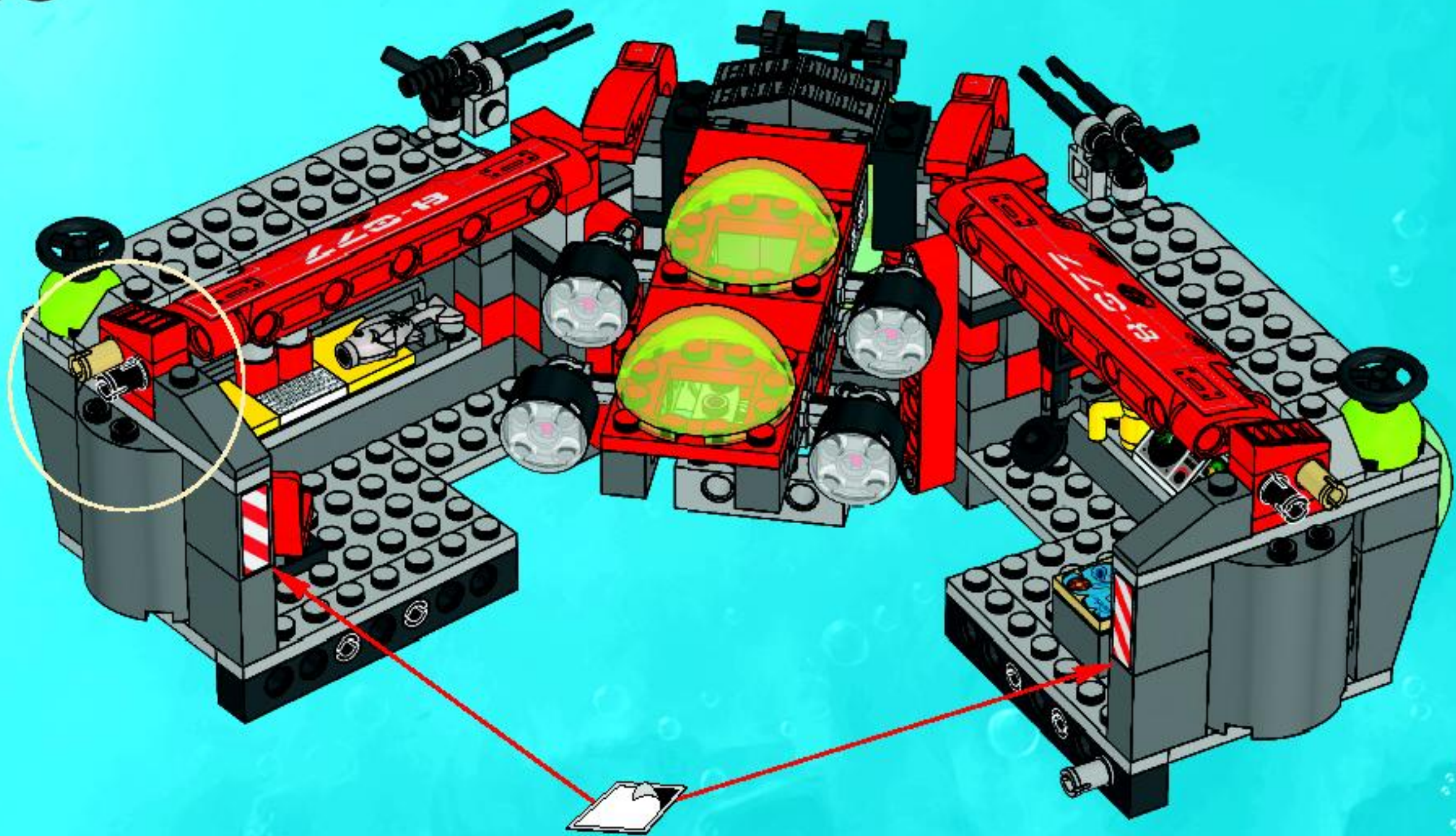

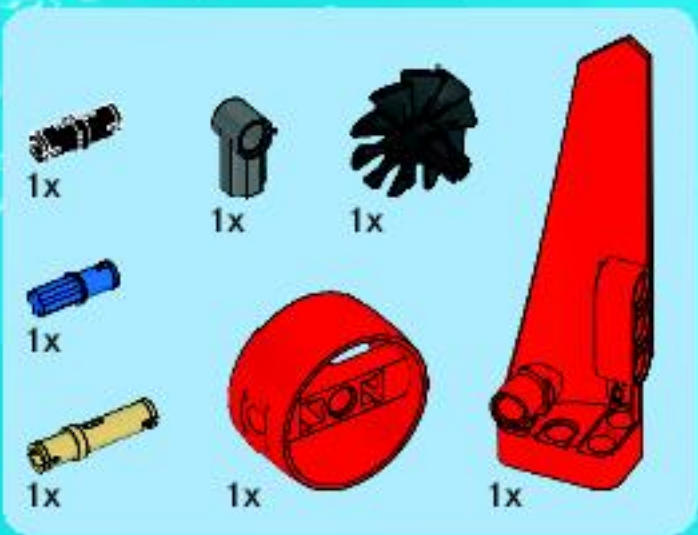

49

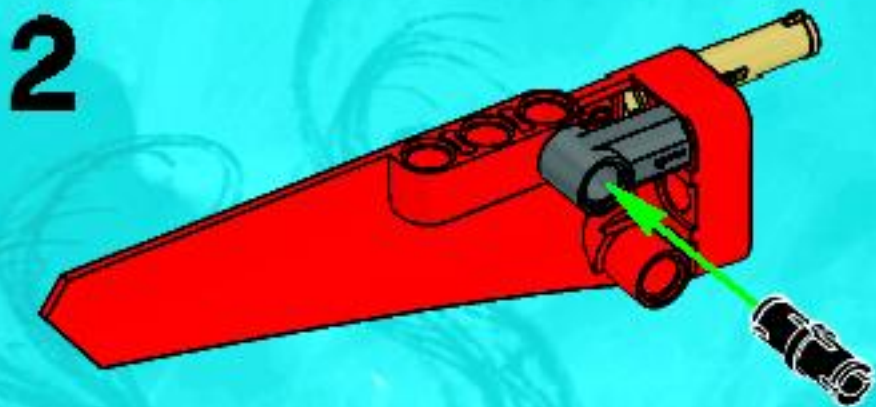
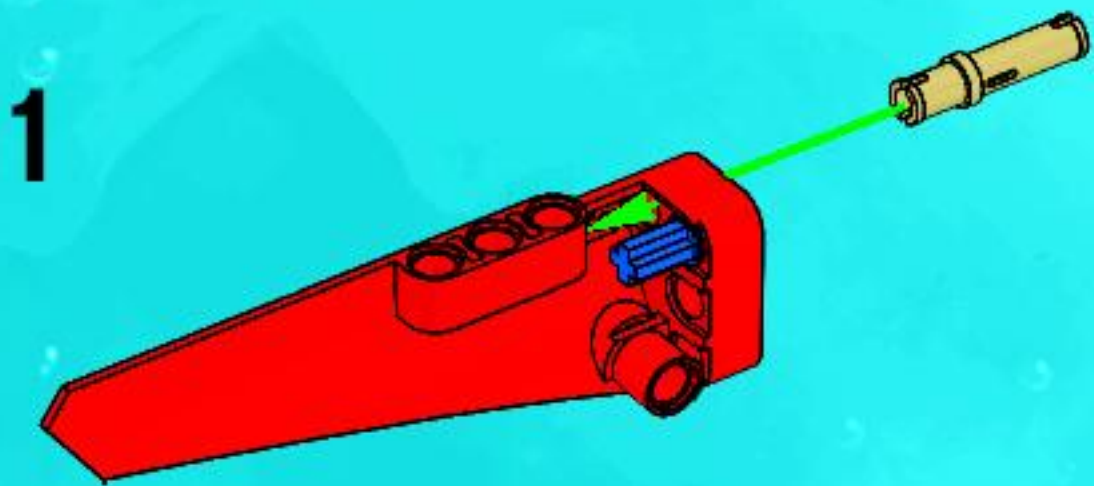

3

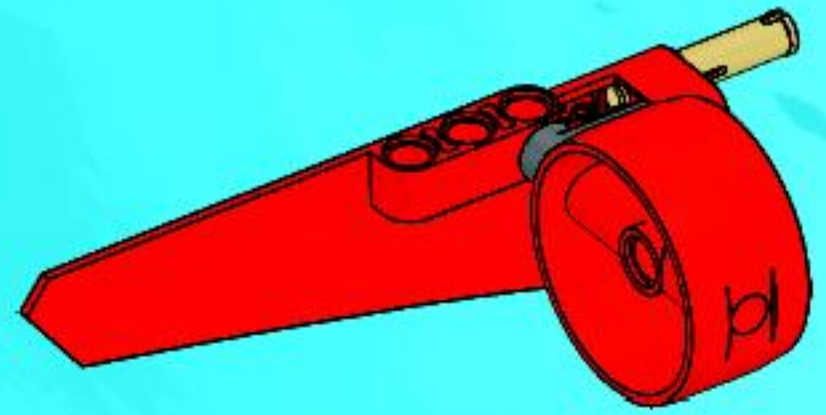

4

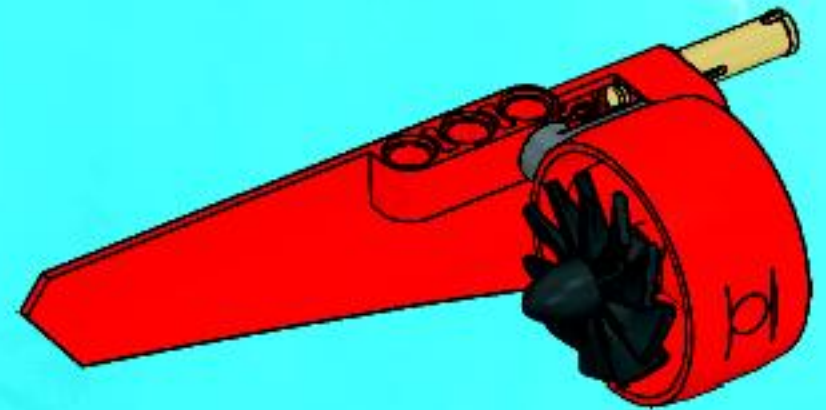

5



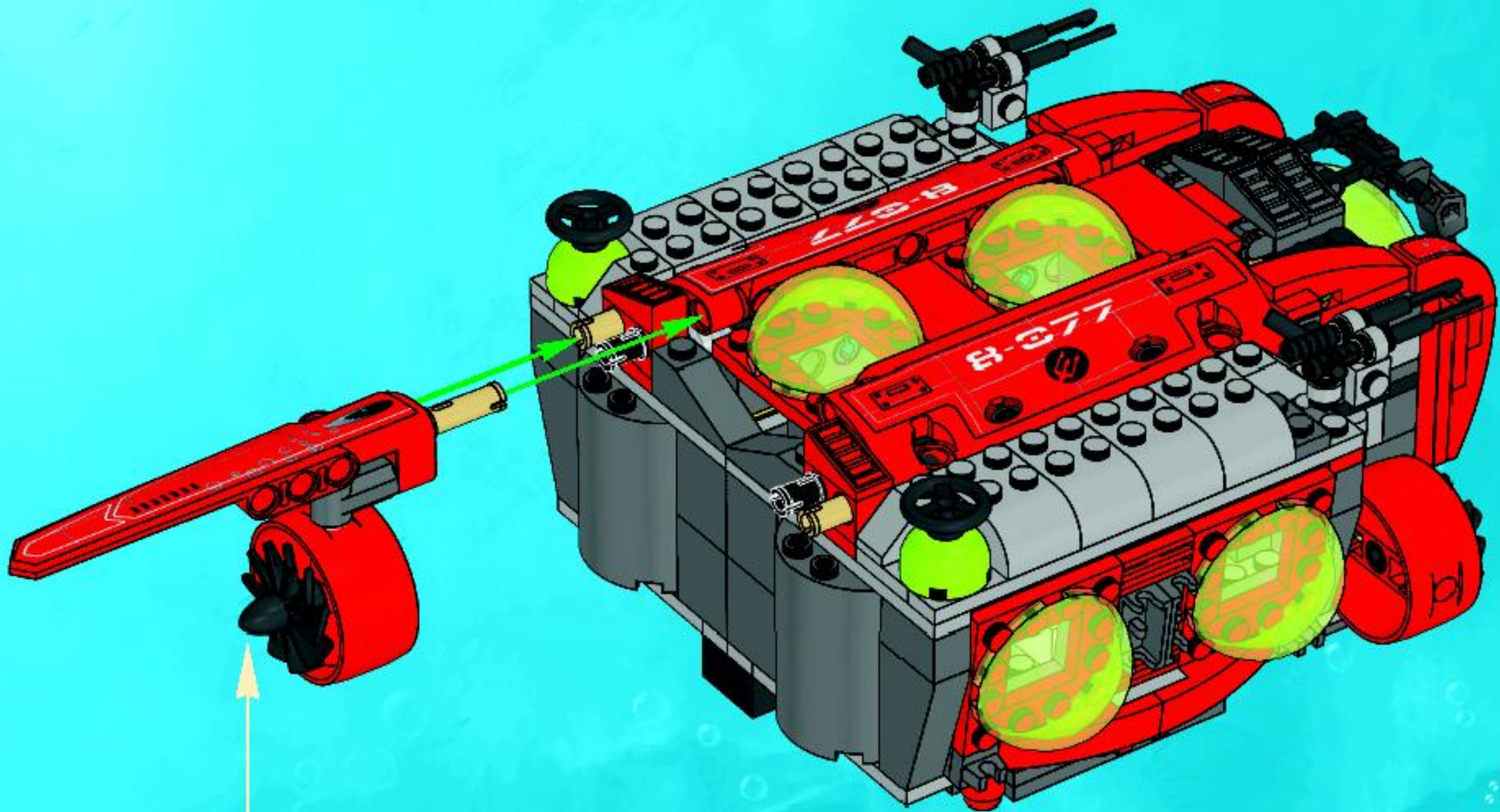

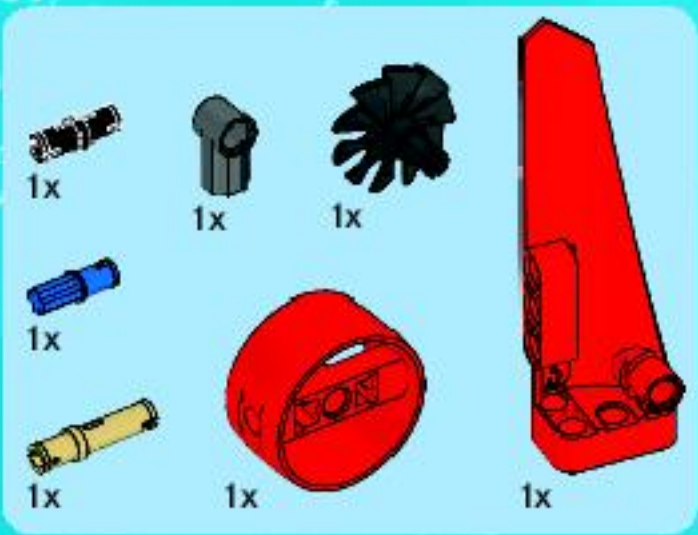

50

1

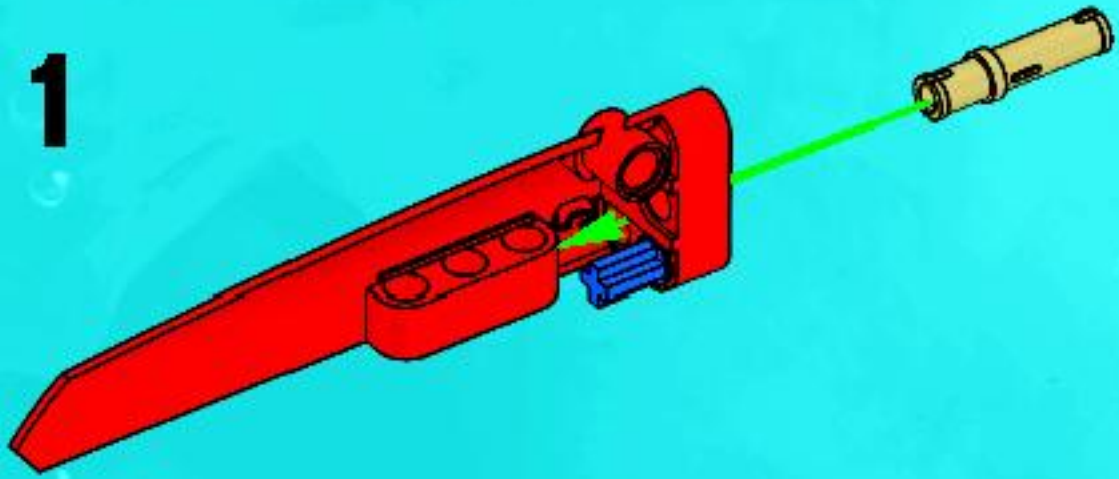

2

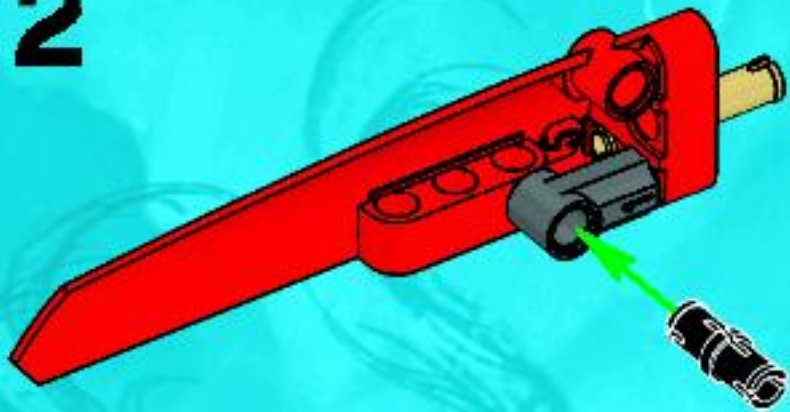

3

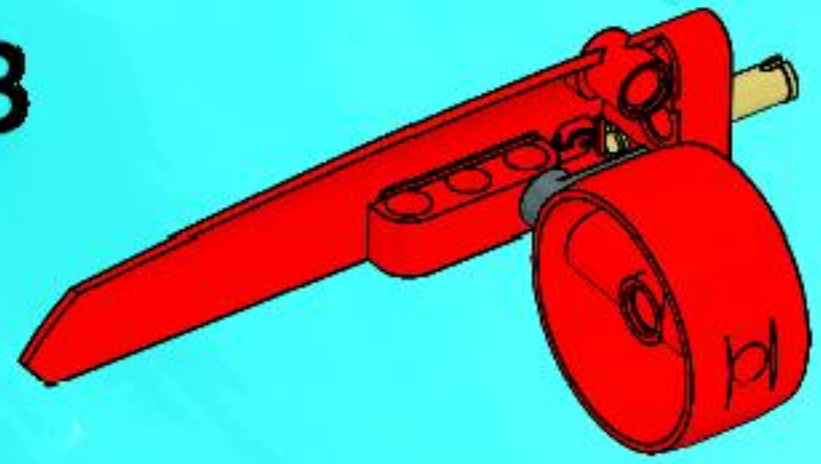

4



5



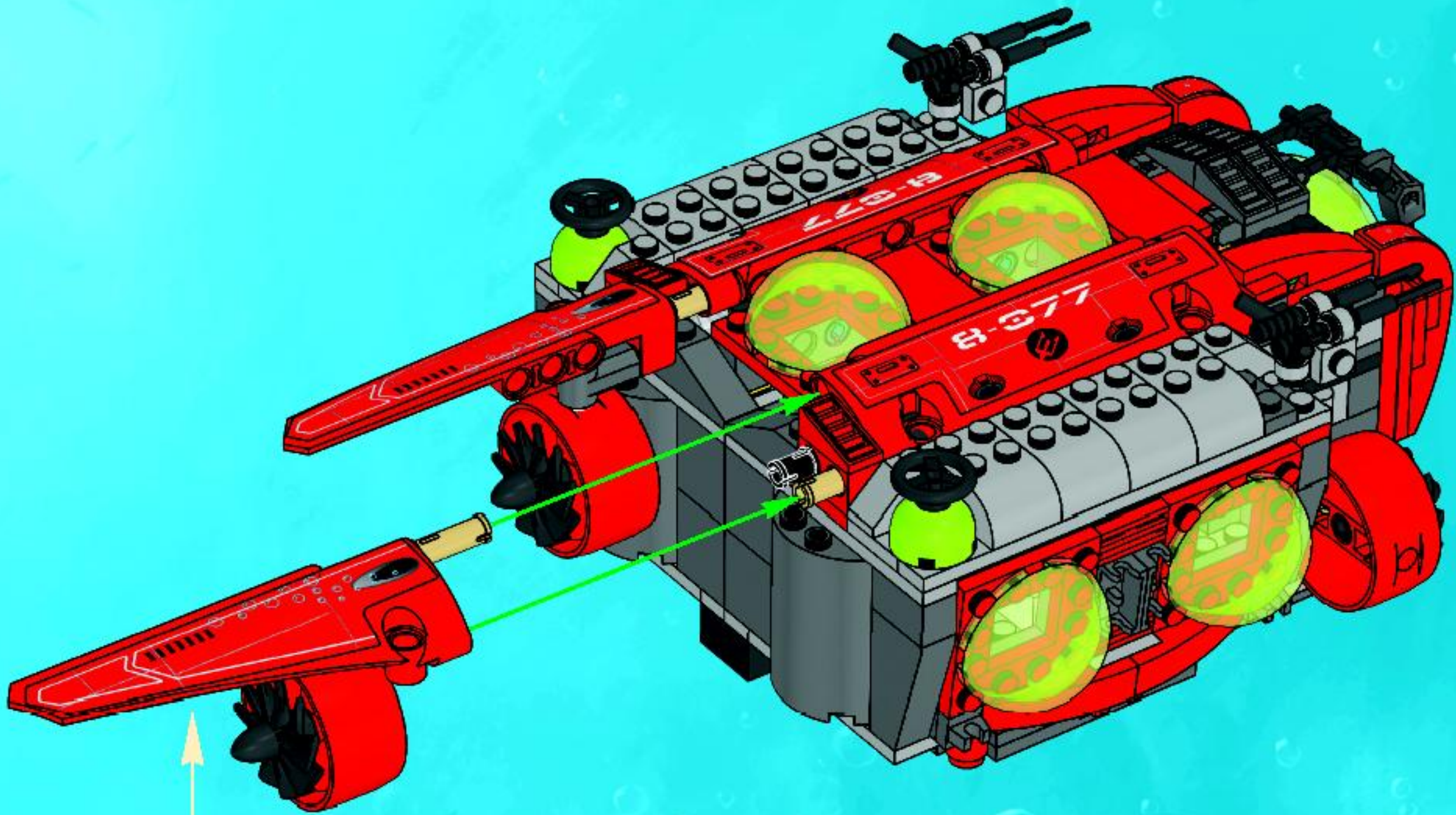



2x



2x



2x

51

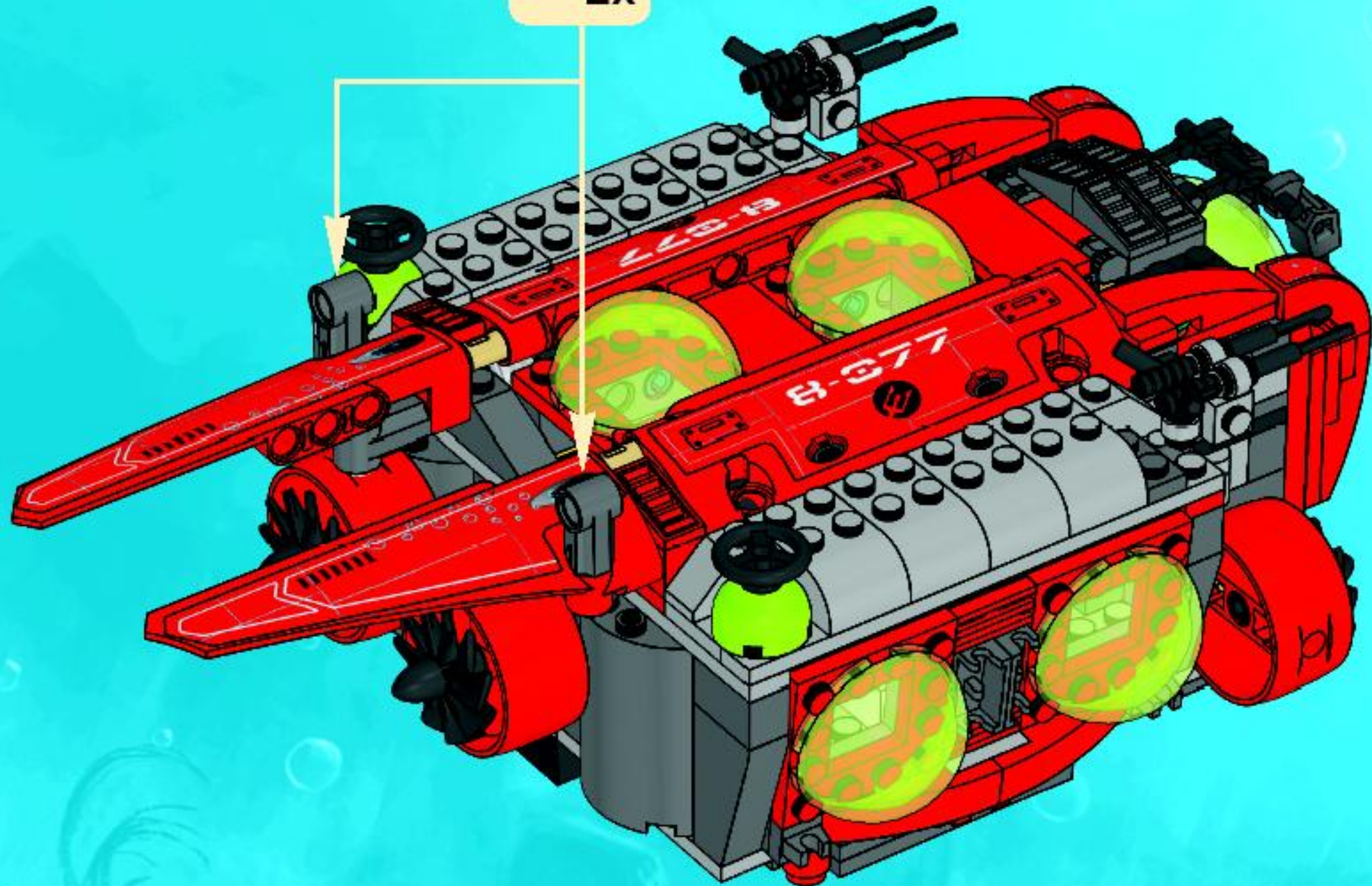



2x



2x

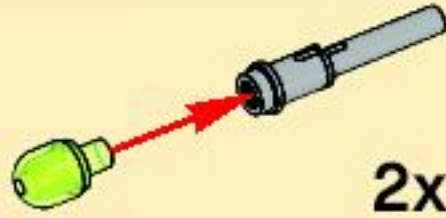

2x



52

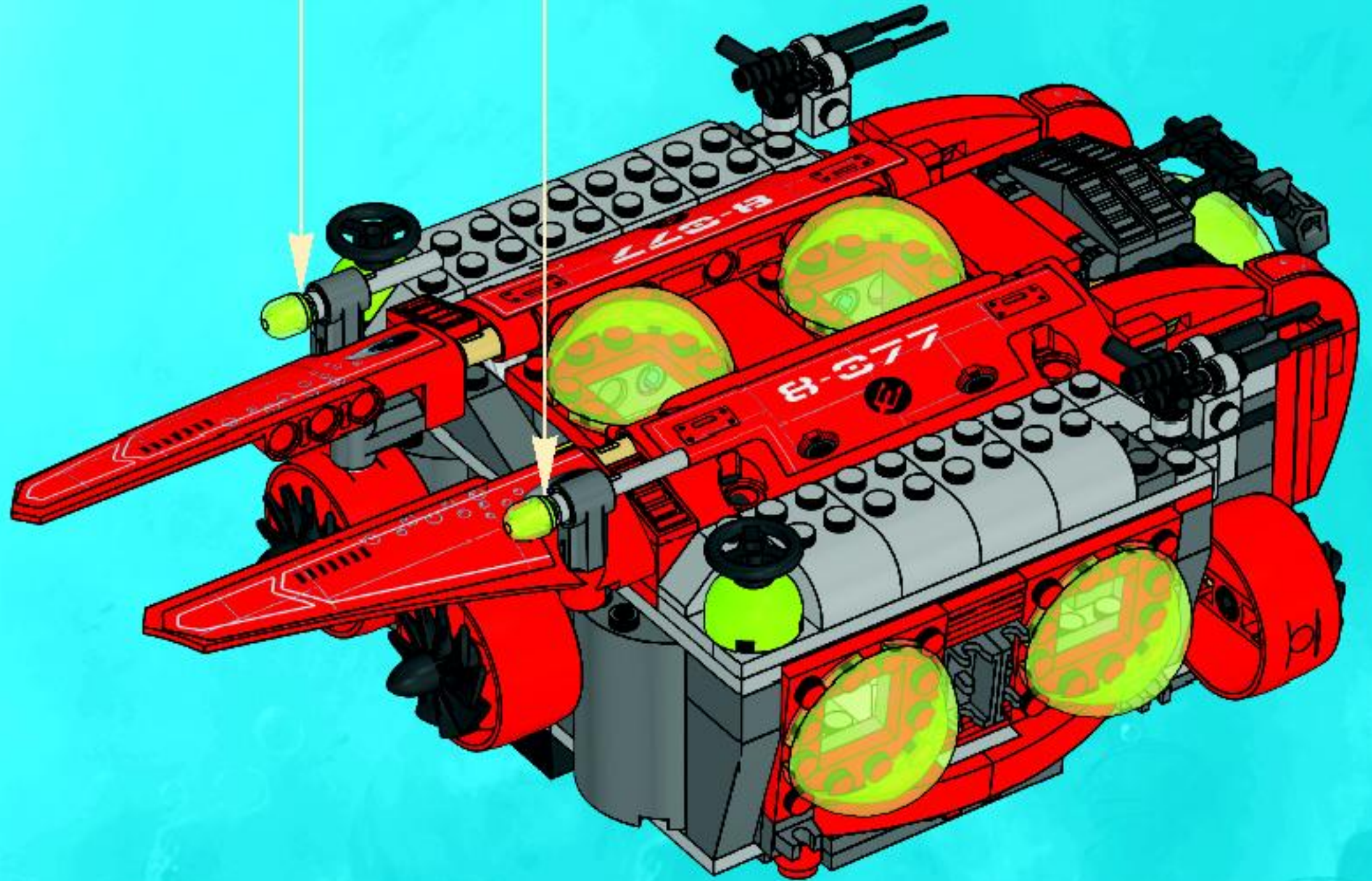

1

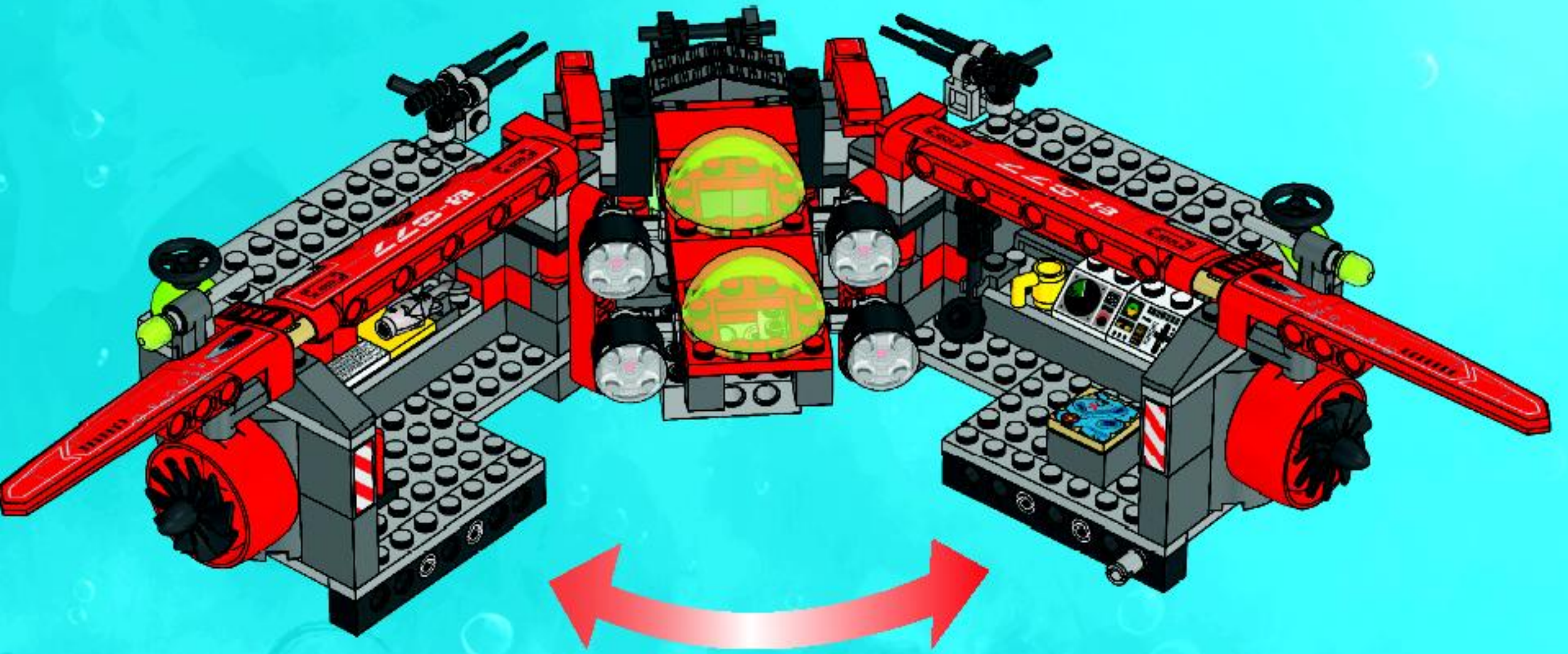

2

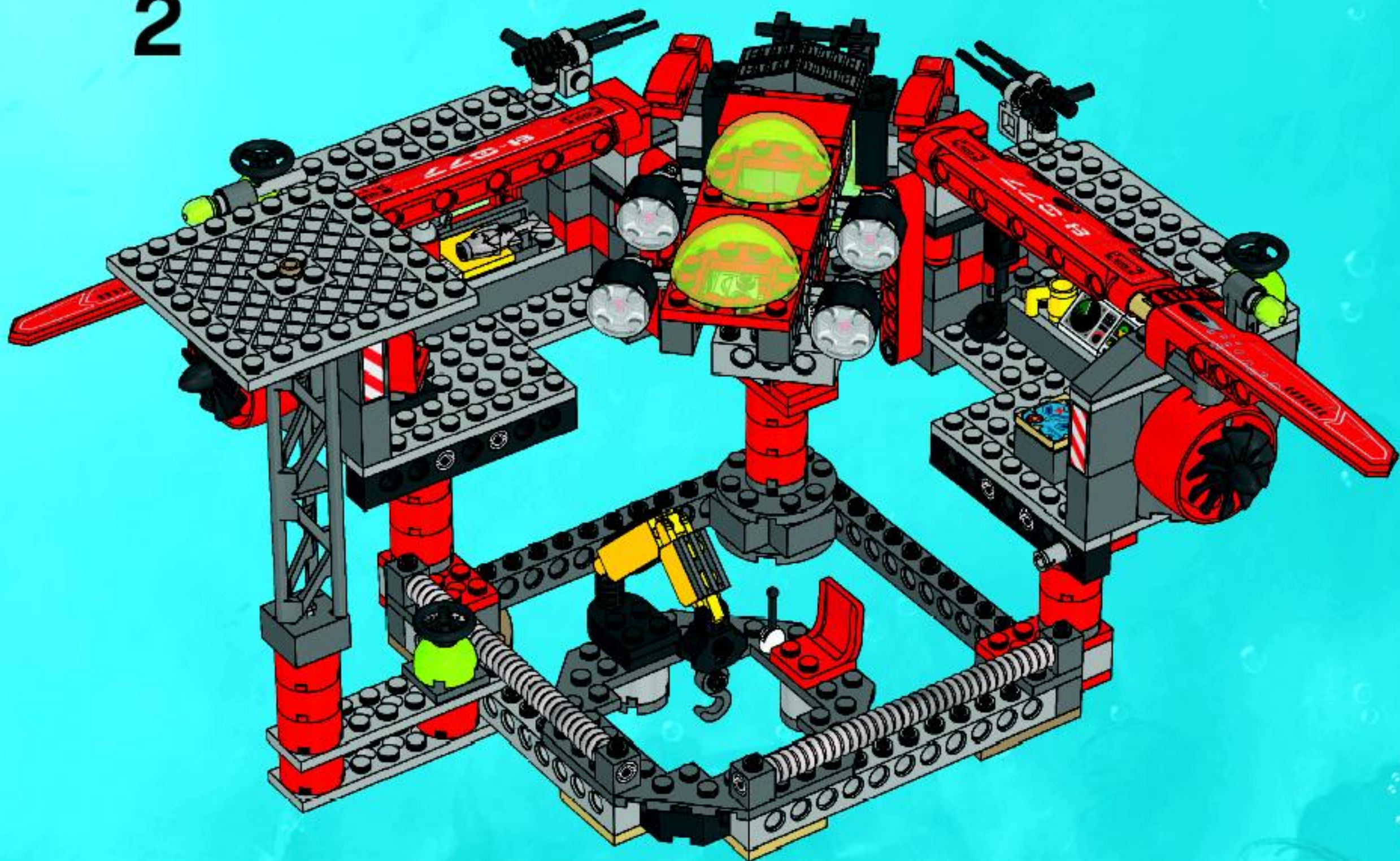







8058



8058



8075



8075



72 8077



8077



8078



8078



8076



8076



ATLANTIS

MAP OF ATLANTIS

LO 230:23.5
LA 40:22.7
ETA 02.43.00

SIM 440:00.5
IN 10:11.1
OUT 30.33.33

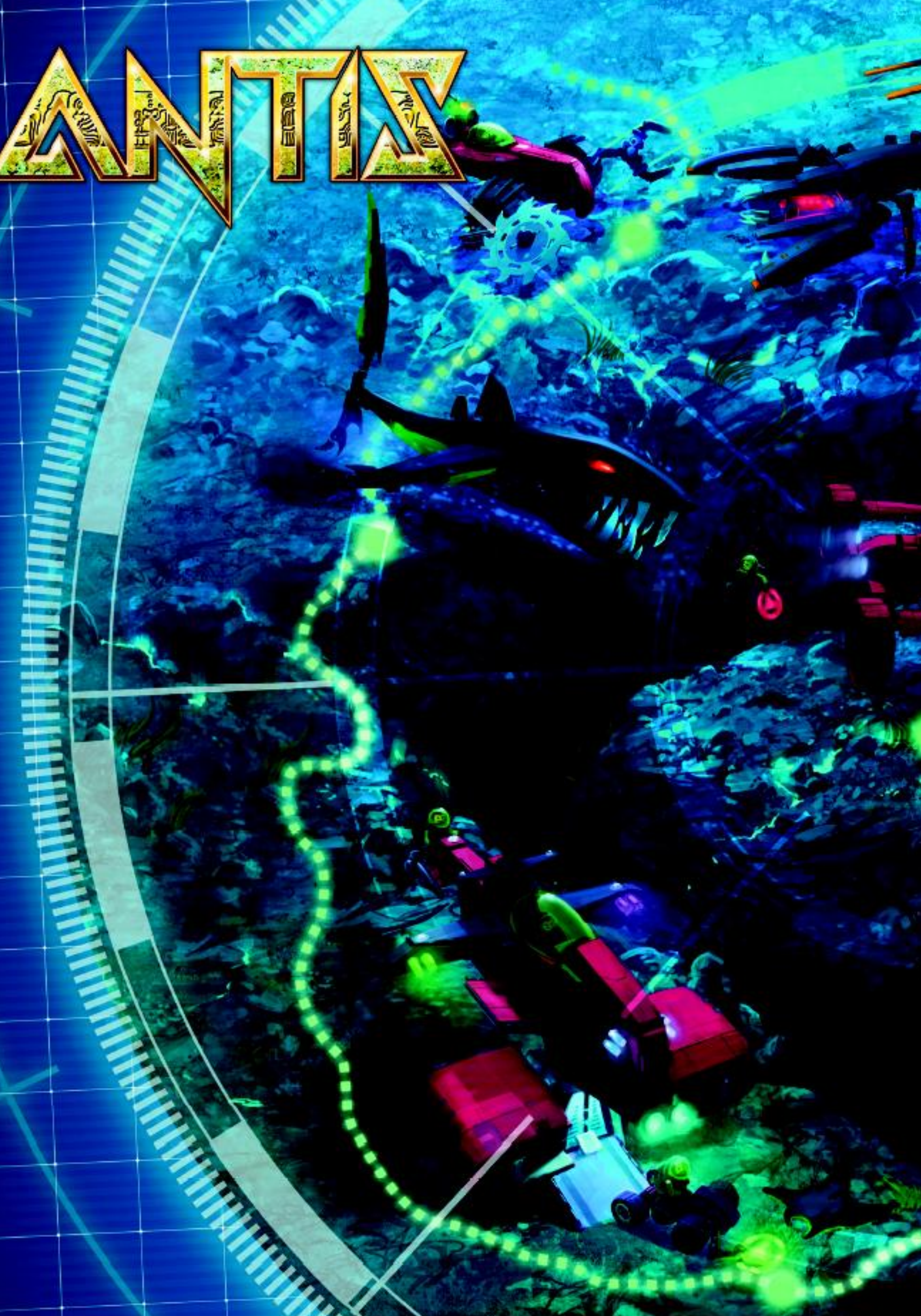

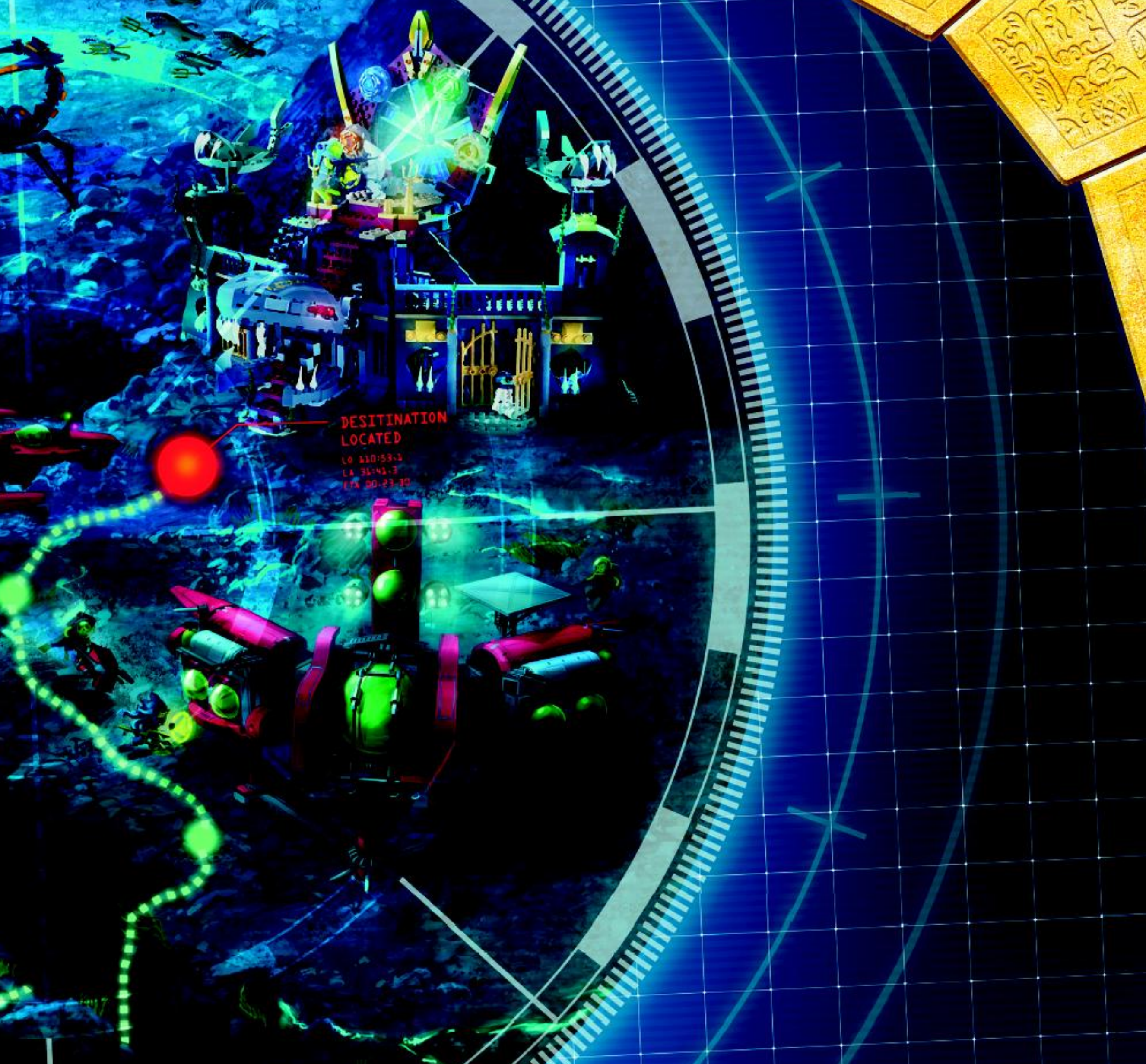

DESTINATION
LOCATED

LO 110:59.1
LA 31:43.3
ETA 00:23:30



WIN!

Go to www.nielsen.com/LEGO to fill out a survey for a chance to win a cool LEGO® Product. No purchase necessary. Open to all residents where not prohibited.



www.nielsen.com/LEGO

GEWINNE! WIN!

Nimm an der Umfrage auf www.nielsen.com/LEGO teil und hab die Chance ein cooles LEGO® Produkt zu gewinnen!

Die Teilnahme am Gewinnspiel führt zu keinerlei Kaufverpflichtungen. Teilnahme in allen nicht ausgeschlossenen Ländern möglich.

Ga naar www.nielsen.com/LEGO, vul een enquêteformulier in en maak kans op een cool LEGO® product.

Geen aankoopverplichting. Iedereen mag deelnemen, uitzonderd ingezetenden van landen waar een enquêteverbod geldt.

GAGNE! 当てよう!

Visite www.nielsen.com/LEGO pour répondre à un questionnaire et avoir une chance de gagner un produit LEGO® très cool!

Aucune obligation d'achat. Ouvert à tous les résidents des pays autorisés.

www.nielsen.com/LEGOにアクセスして、アンケートにご記入ください。当選者にはレゴ製品を差し上げます。

お買い上げの必要はありません。

禁止されていない限り、すべての管轄にご利用いただけます。