



PIRATES of the CARIBBEAN



4184



1

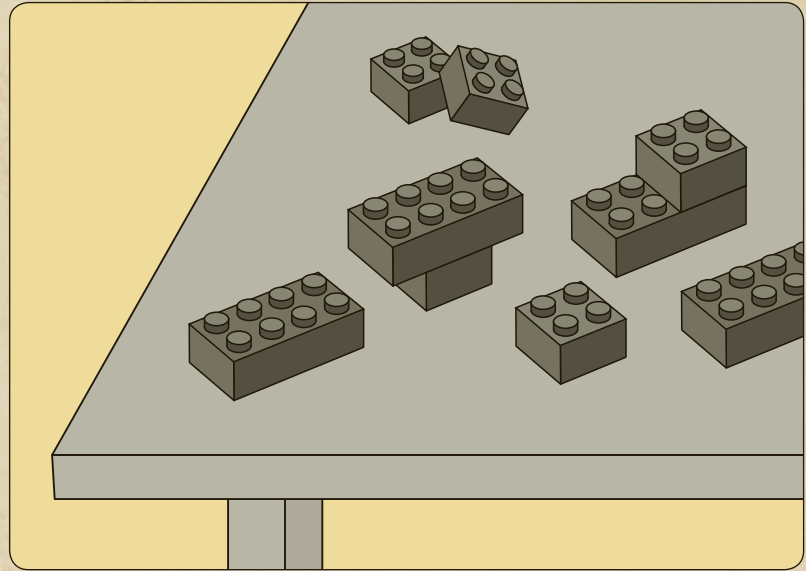
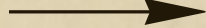
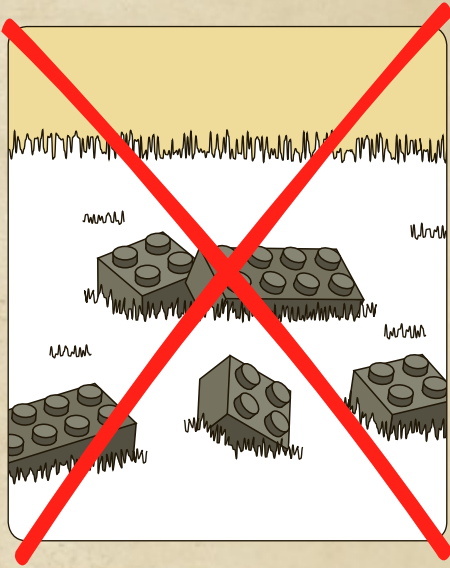

2





+

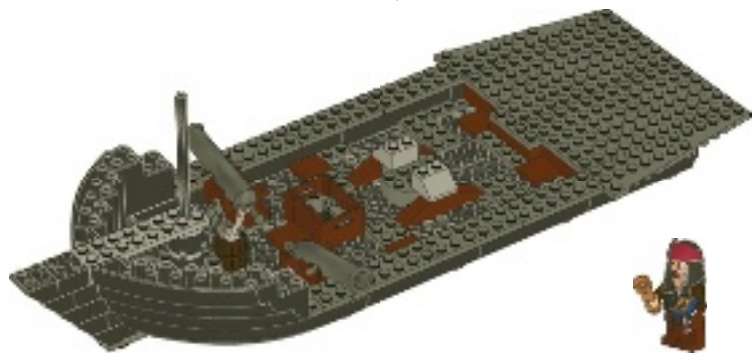

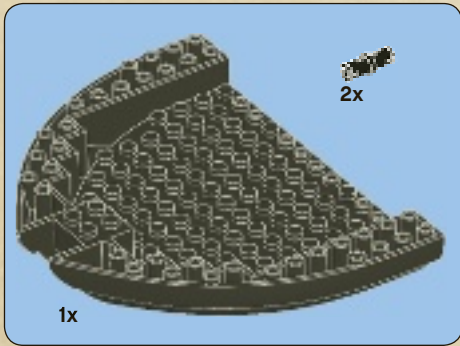
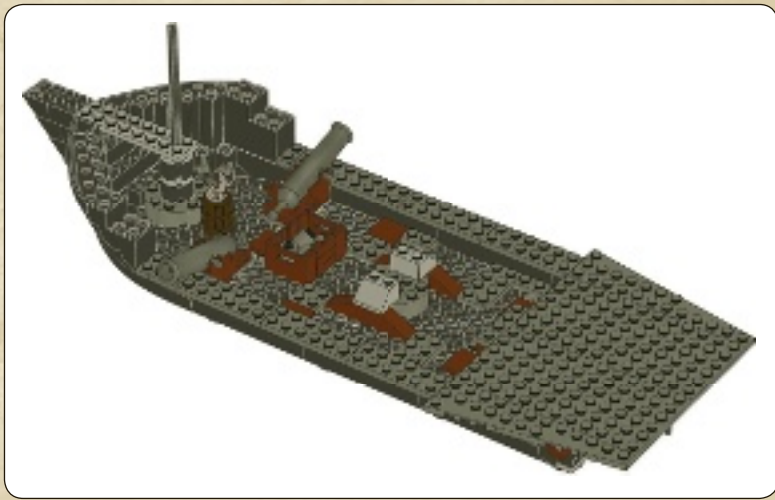

1

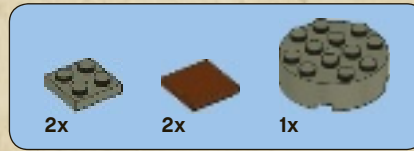
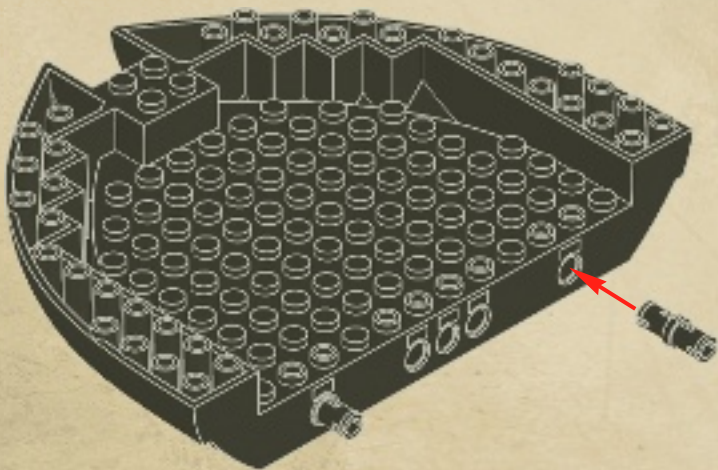

2

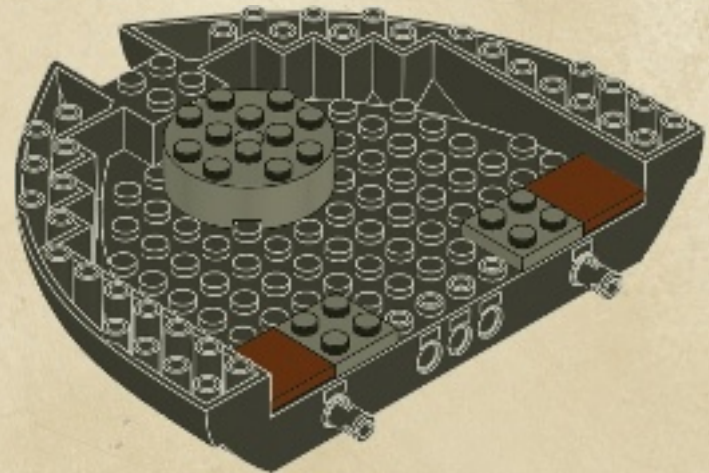

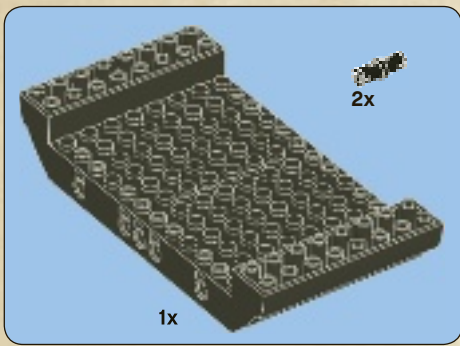

3

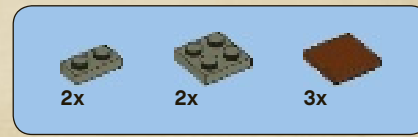
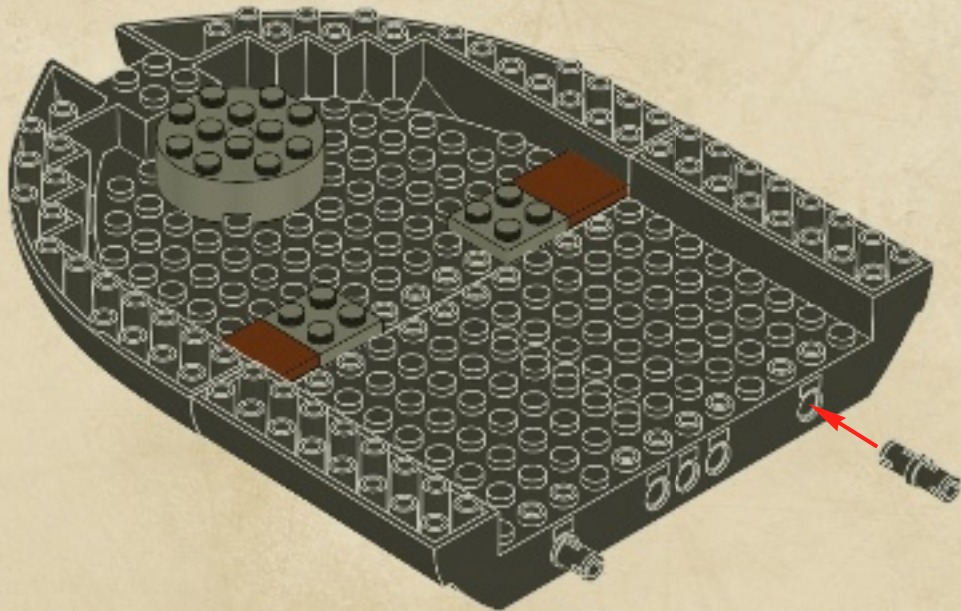

4

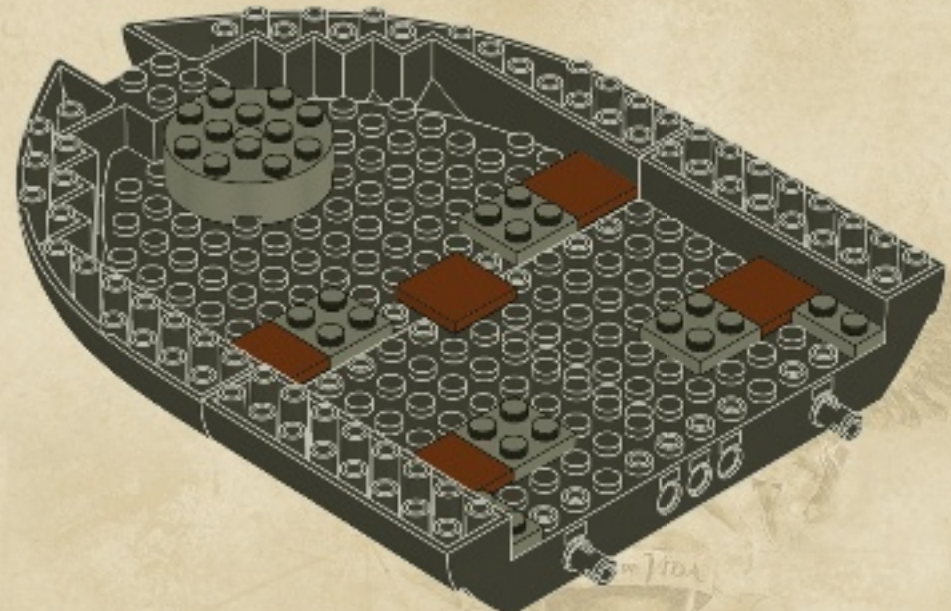

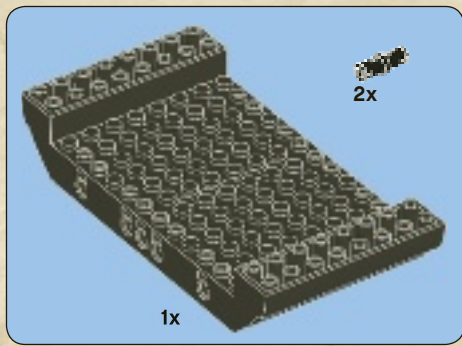

5

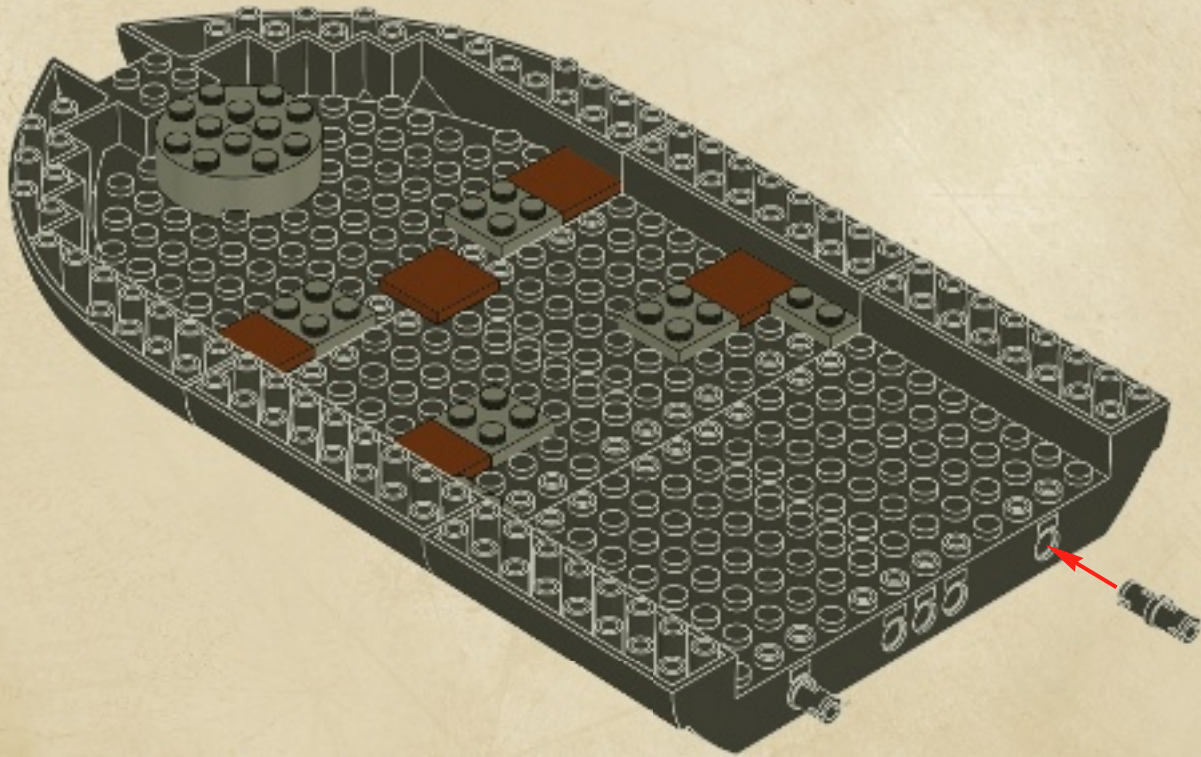

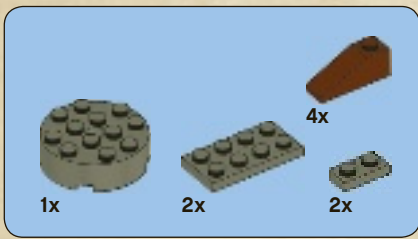

6

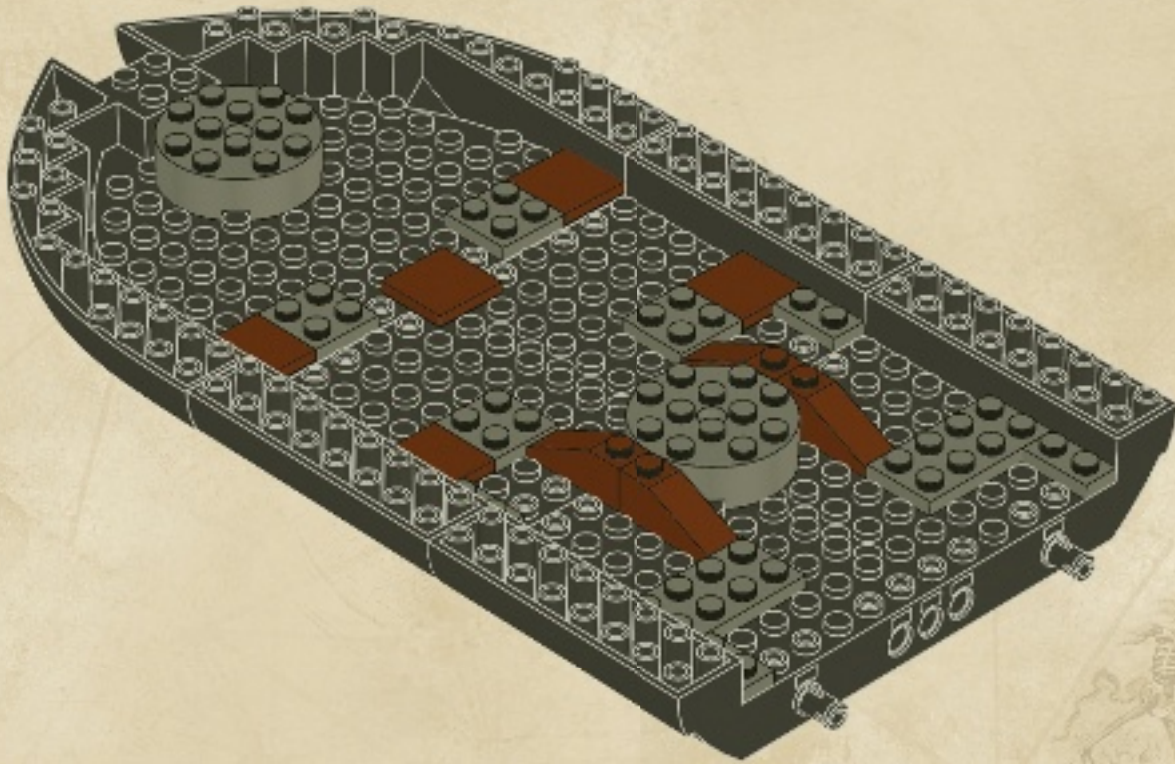

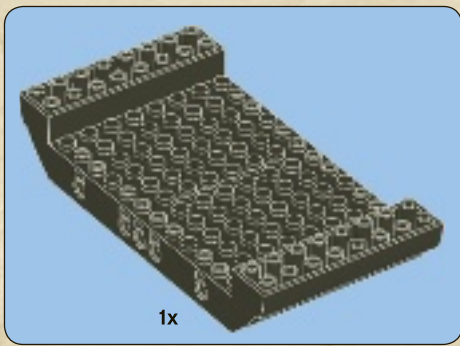

7

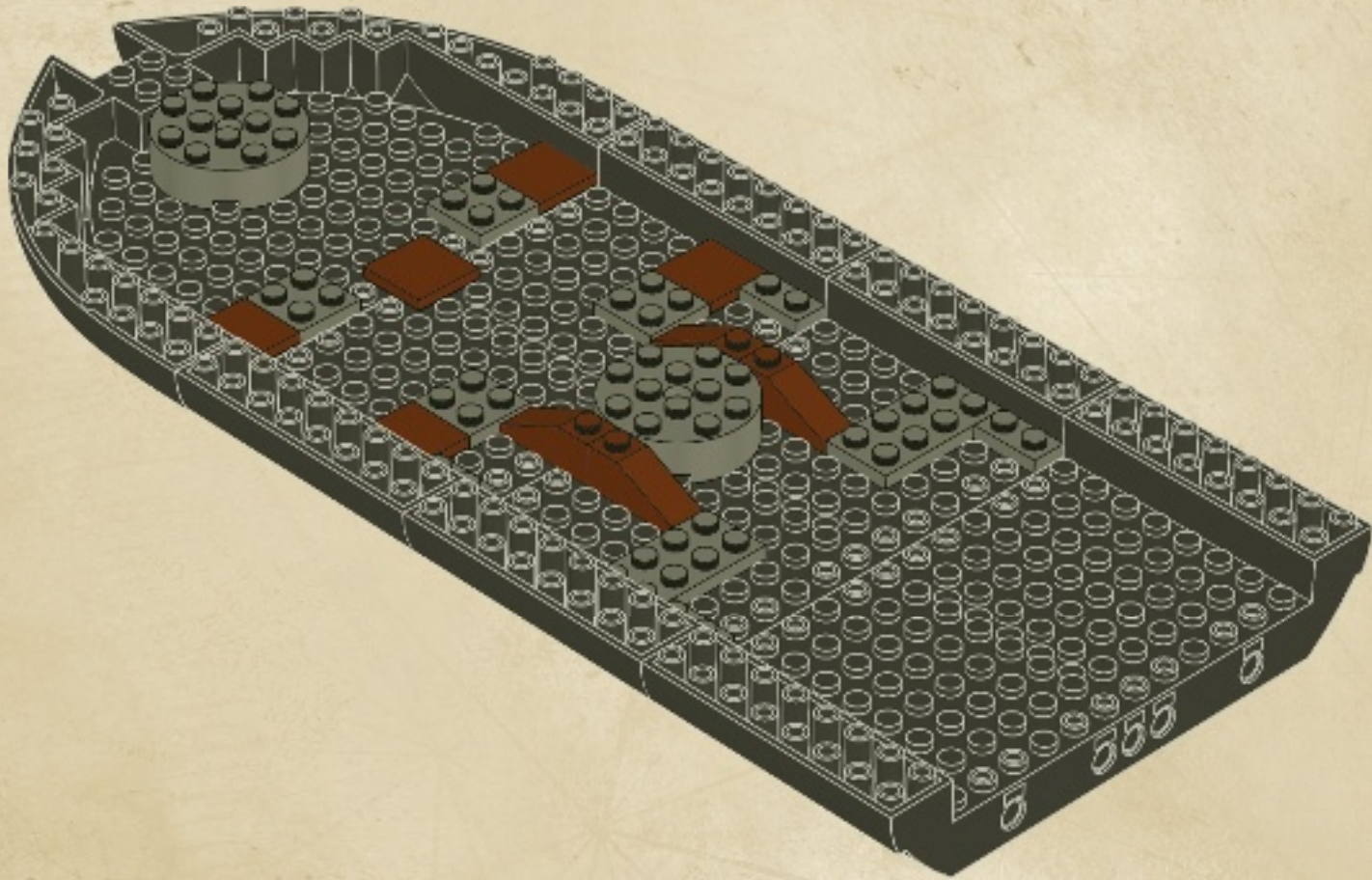



2x

8

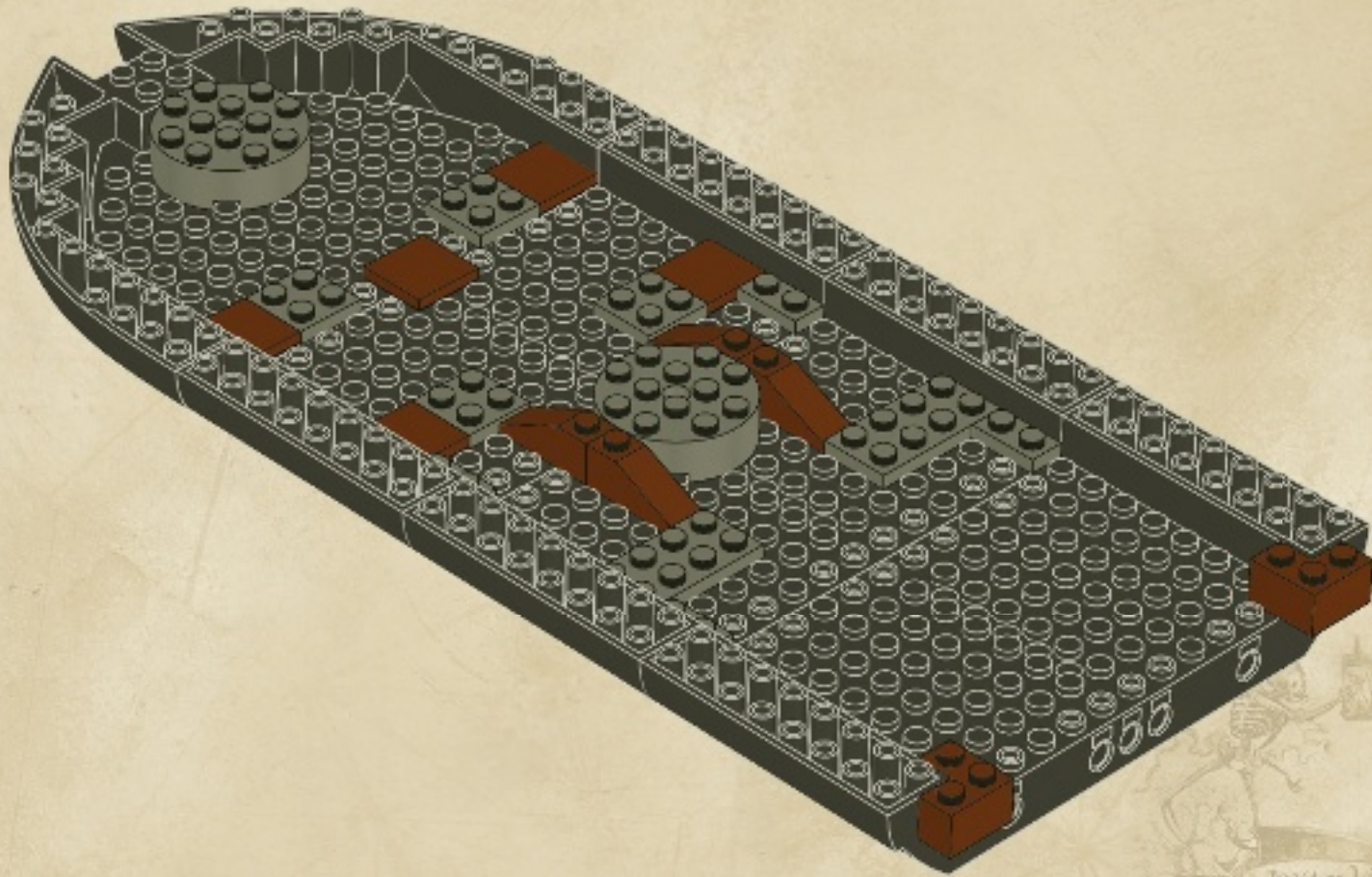

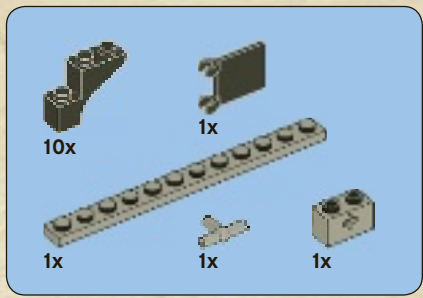

9

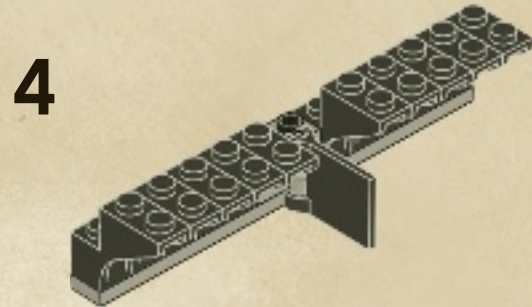
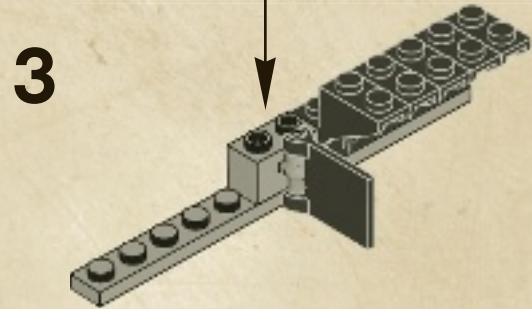
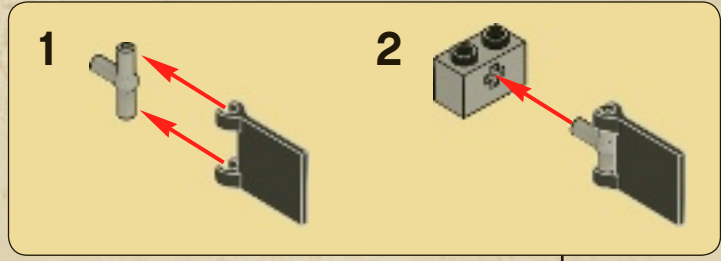
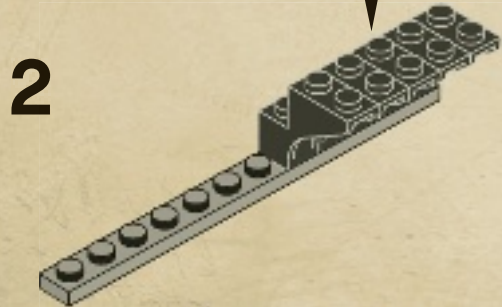
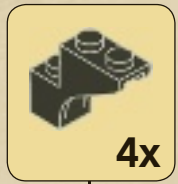
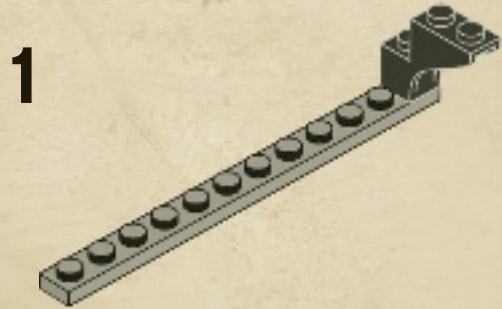

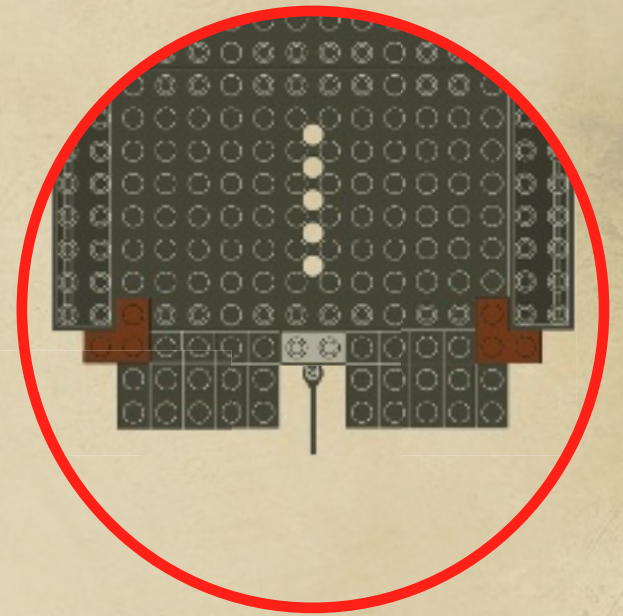
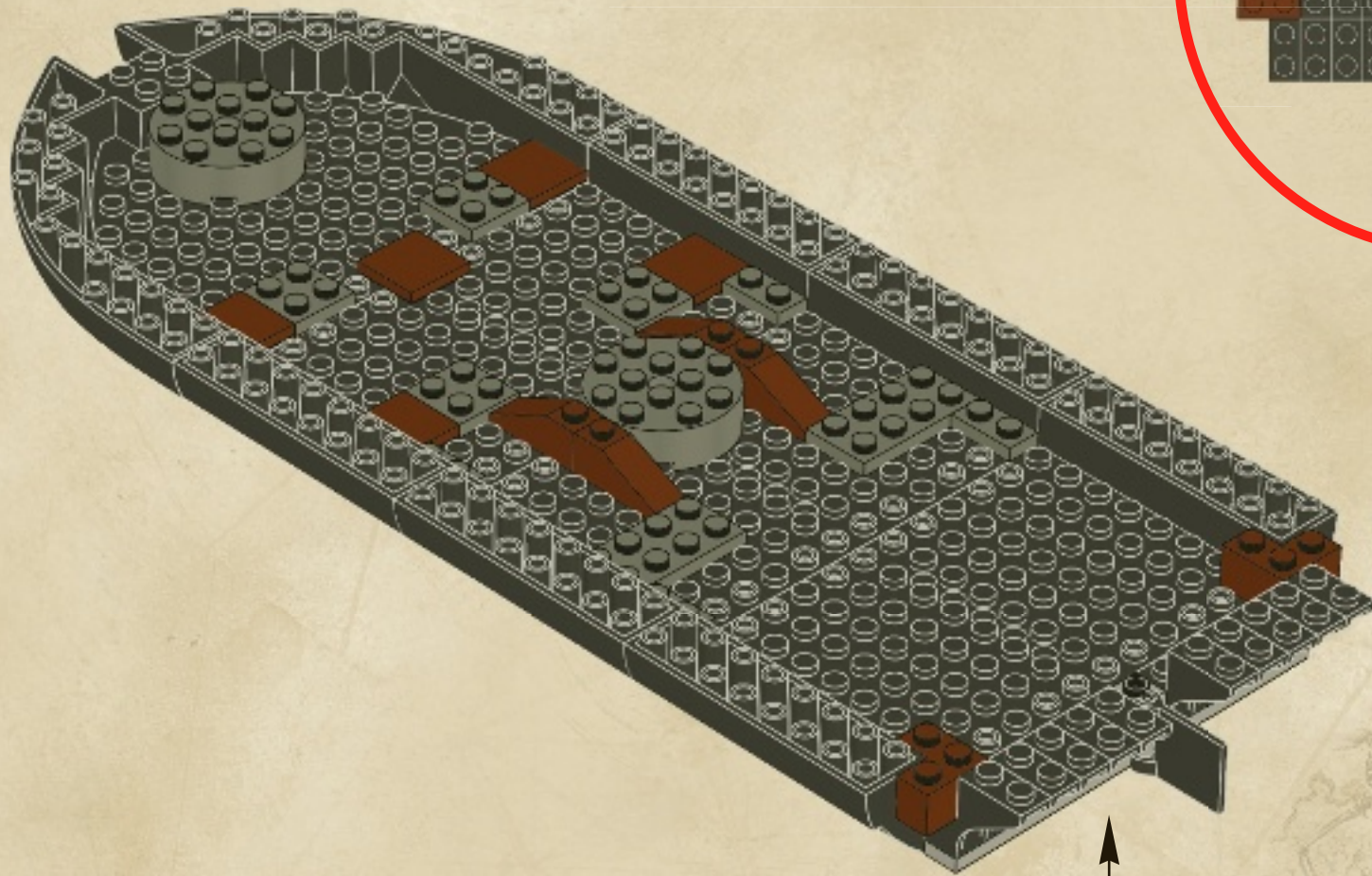

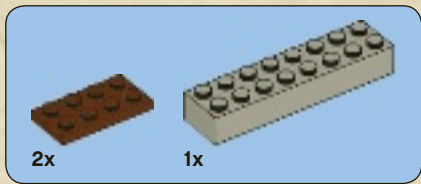

10

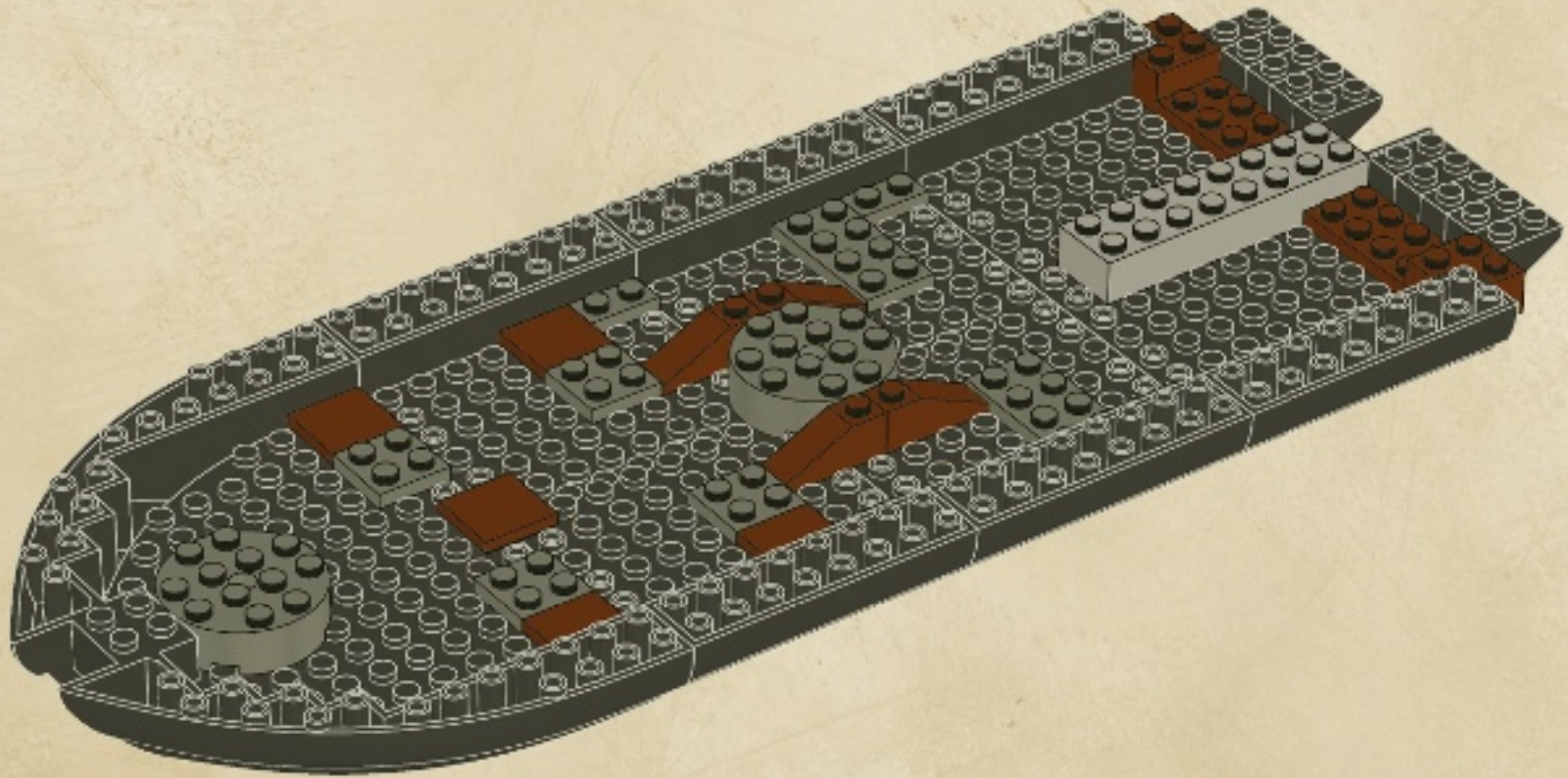

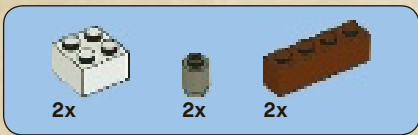

11

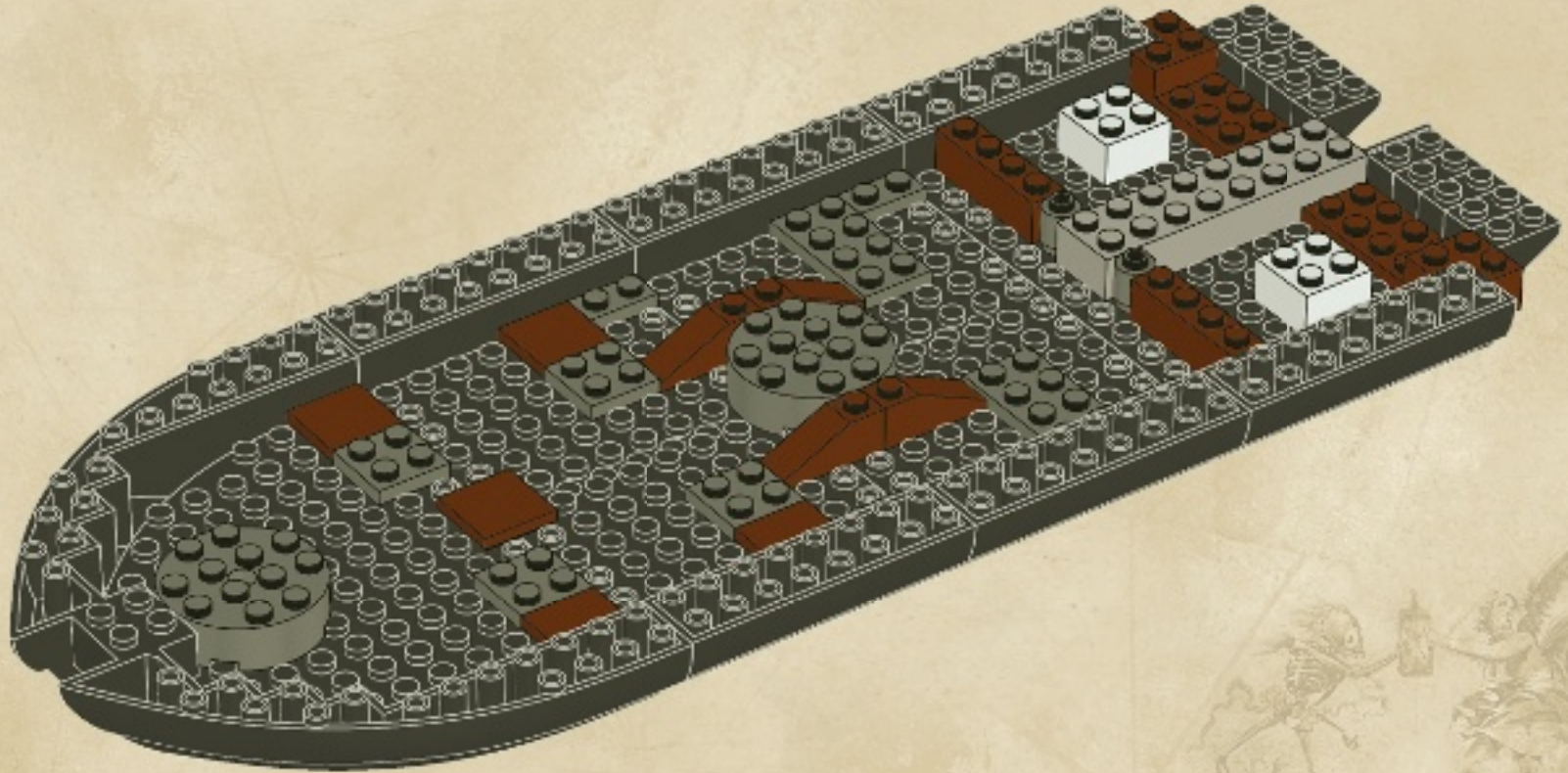



12

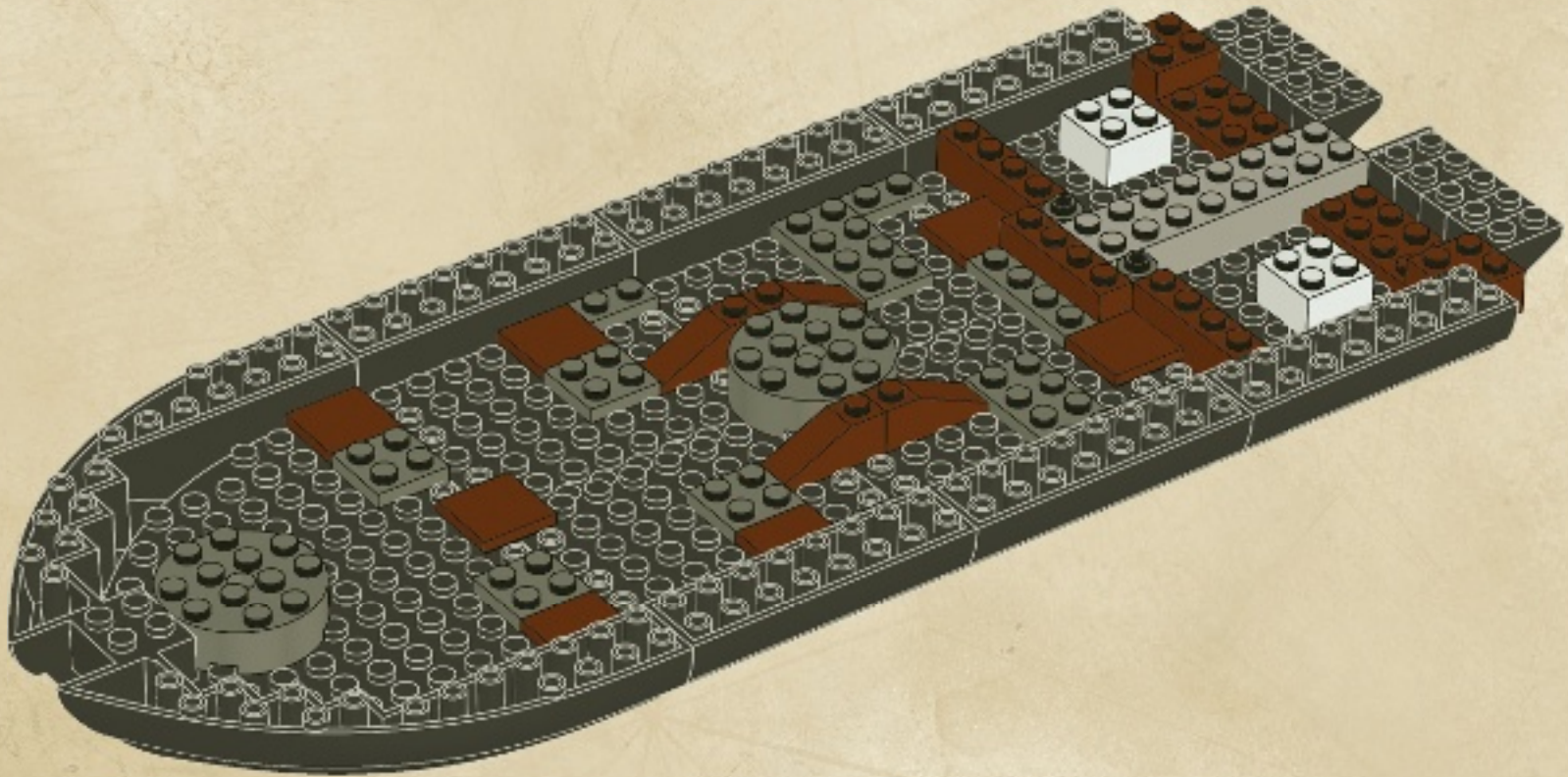



13

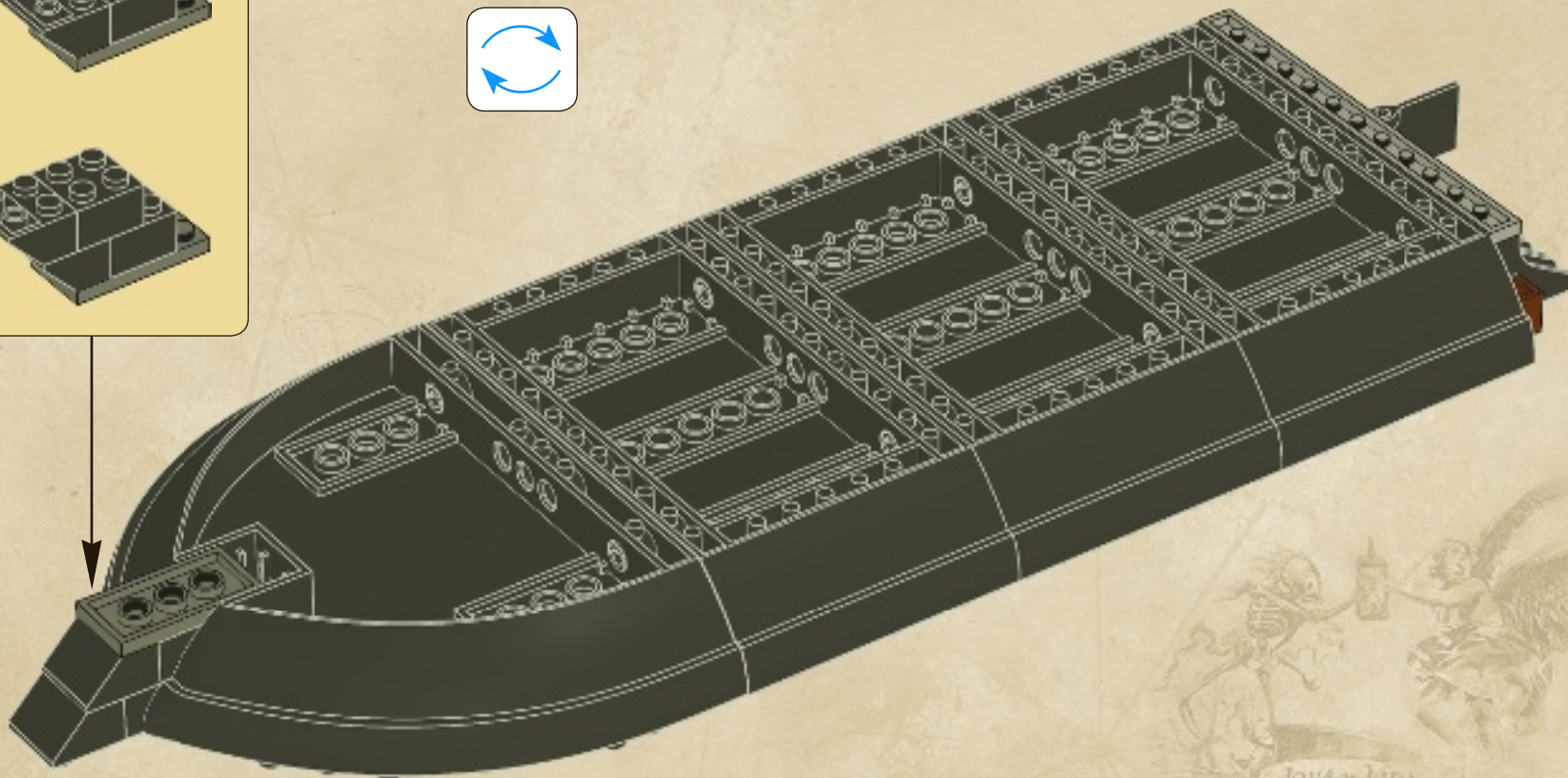
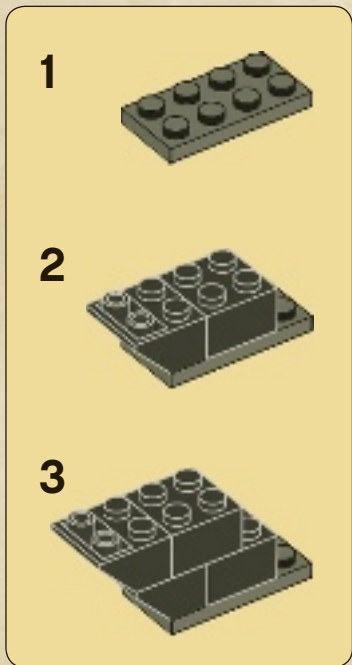



10x

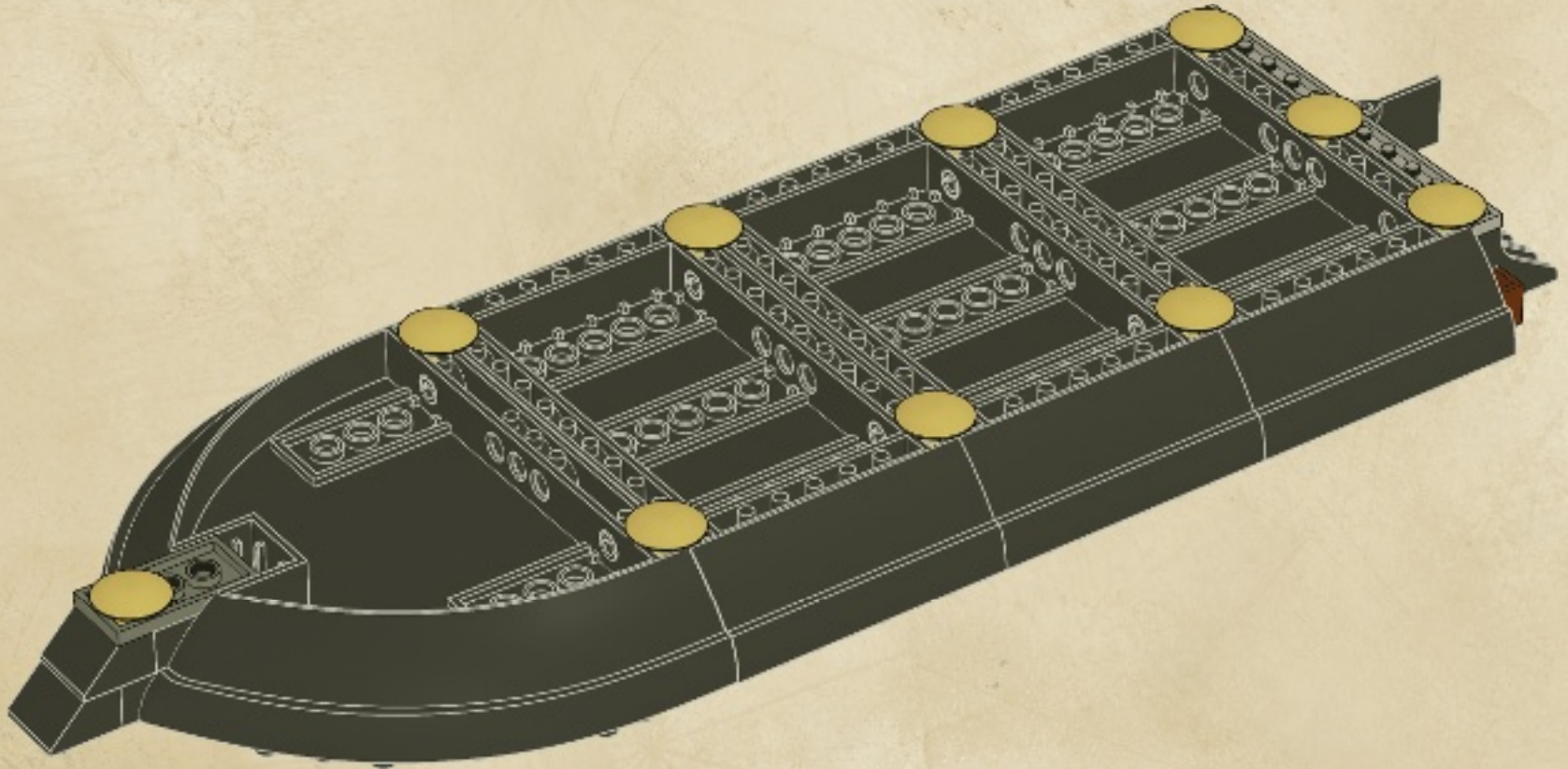

14

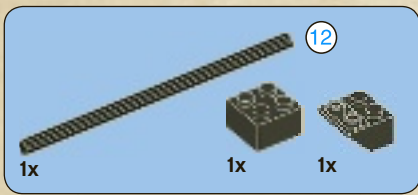

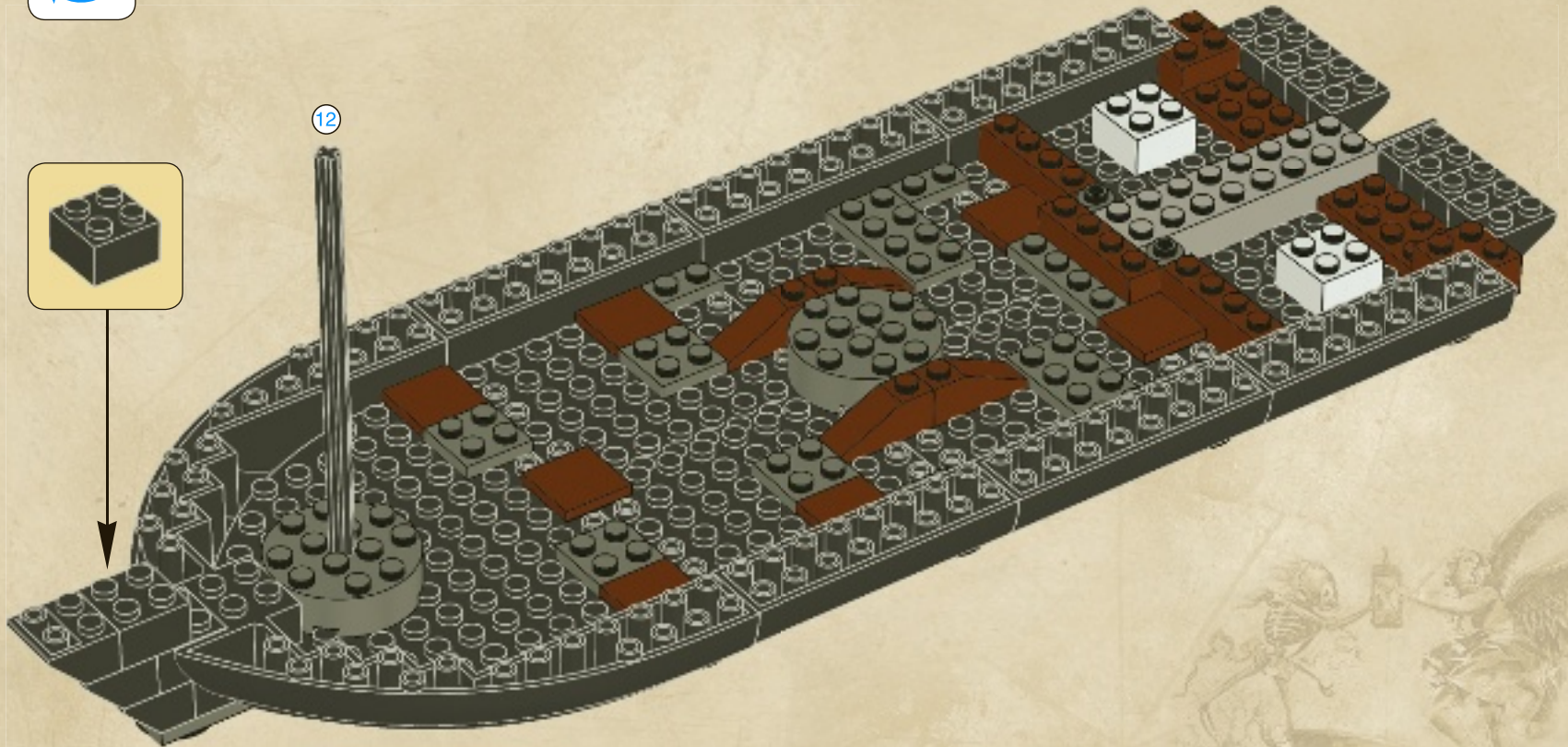
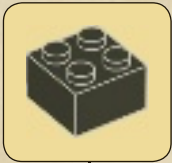

15



1x  1x 

16

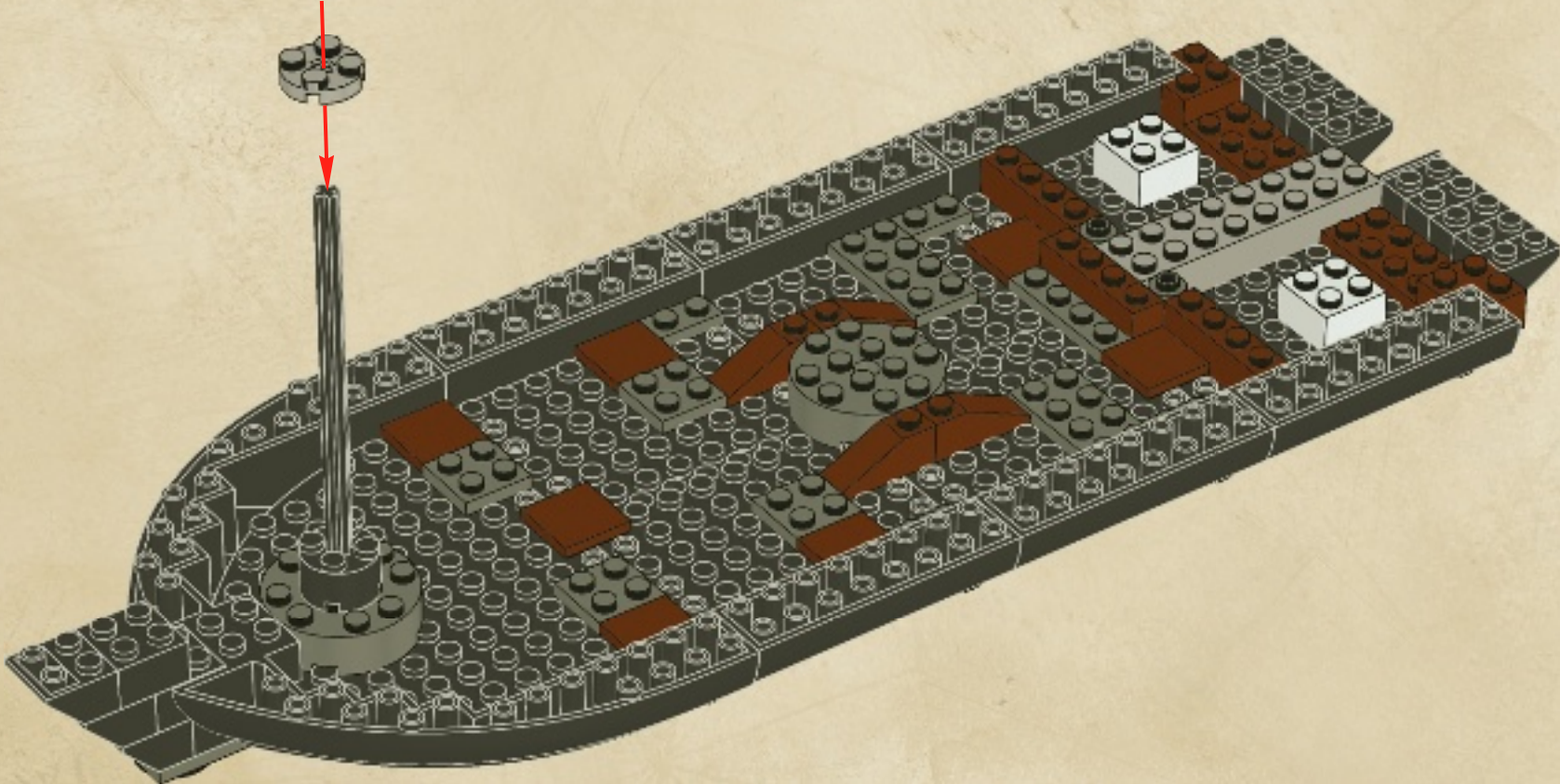



17

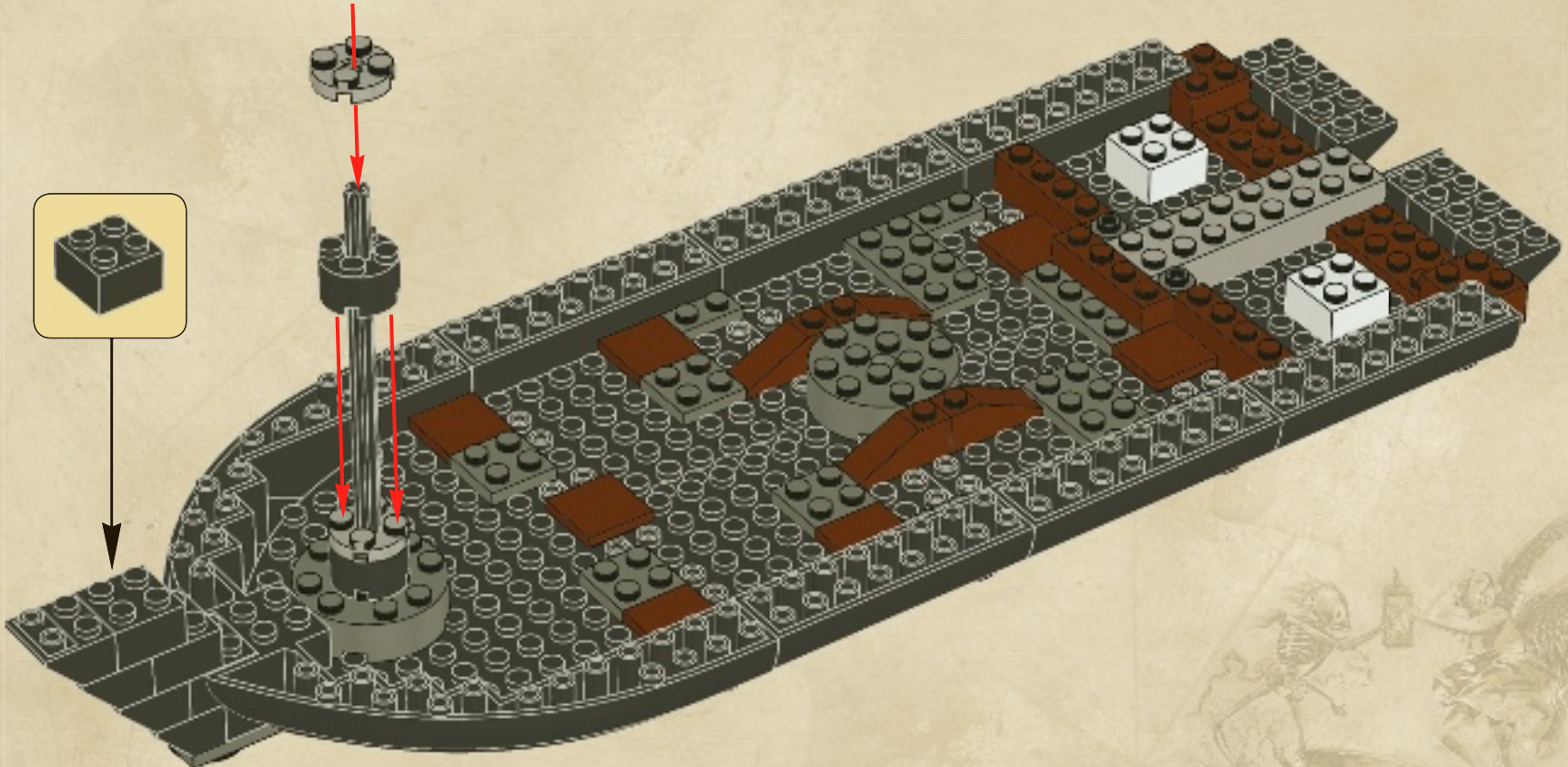

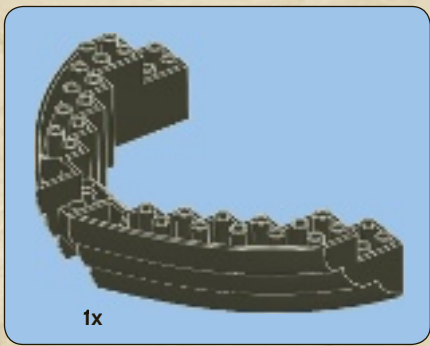

18

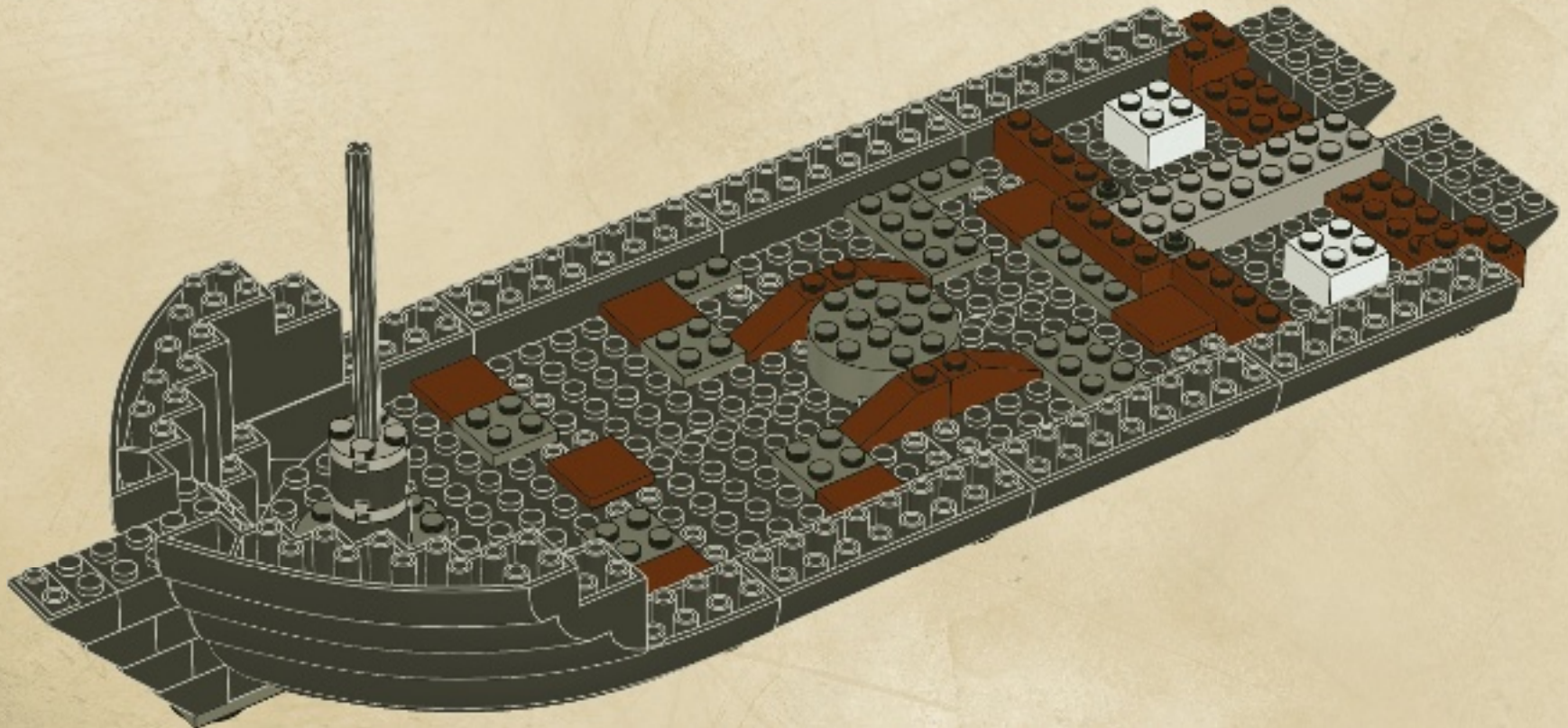

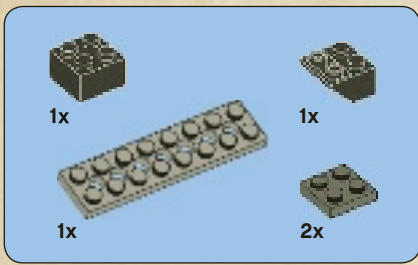

19

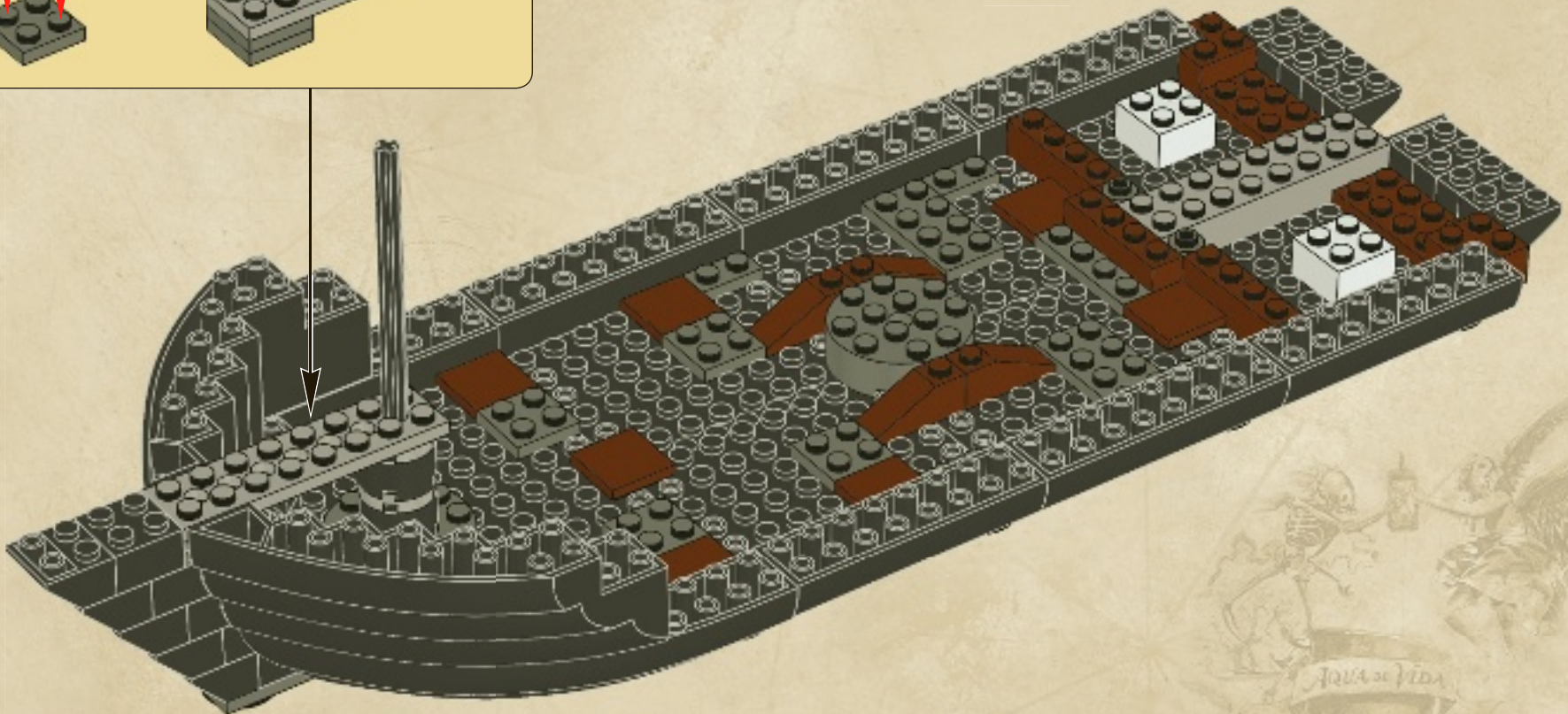
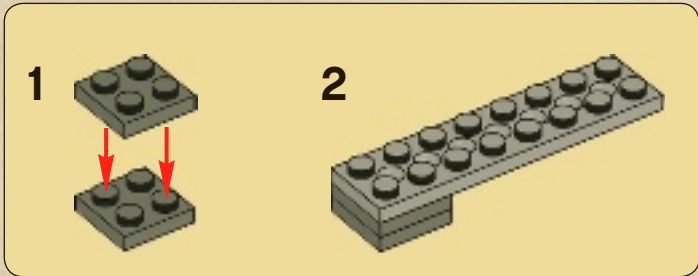

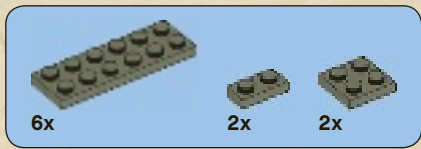

20

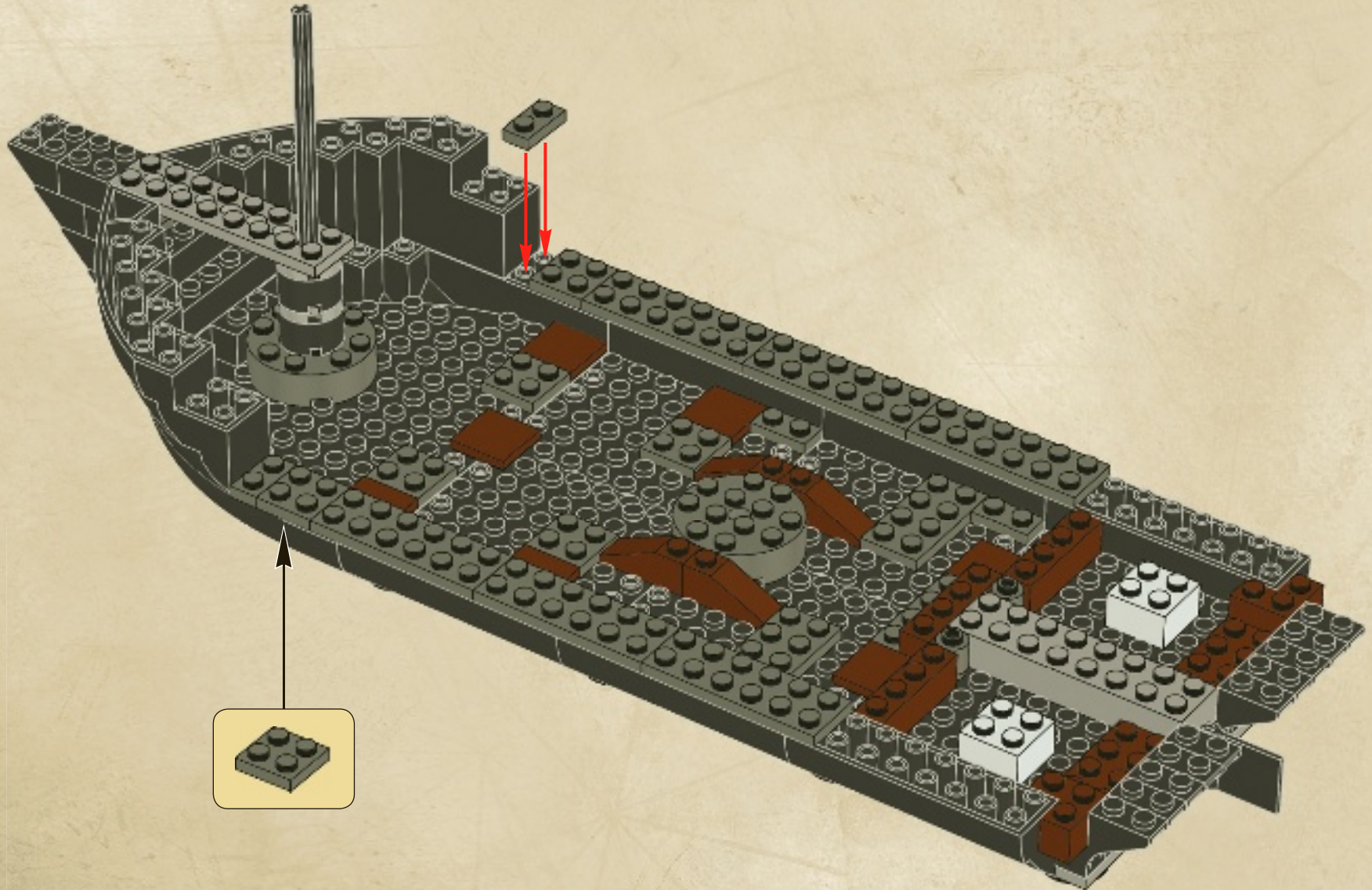



21

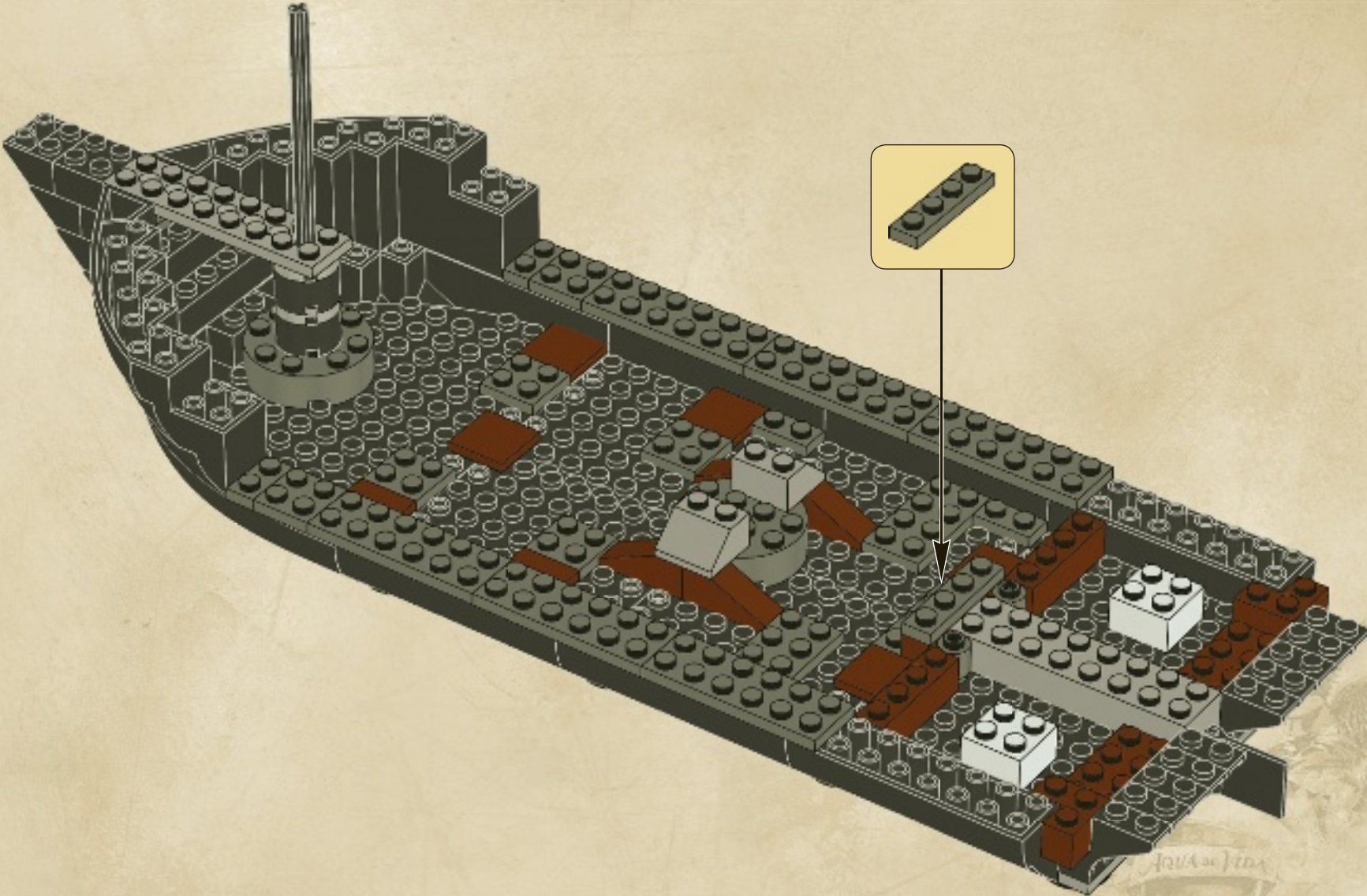

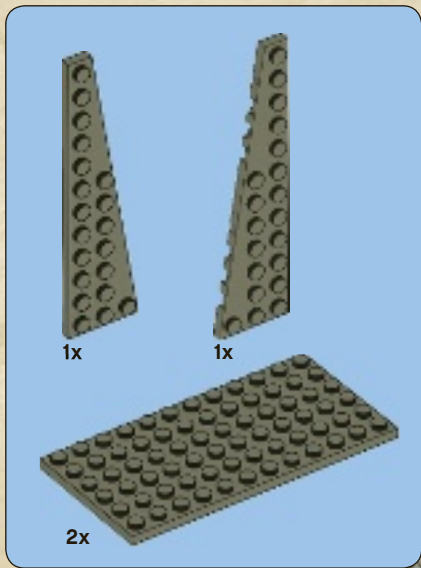

22

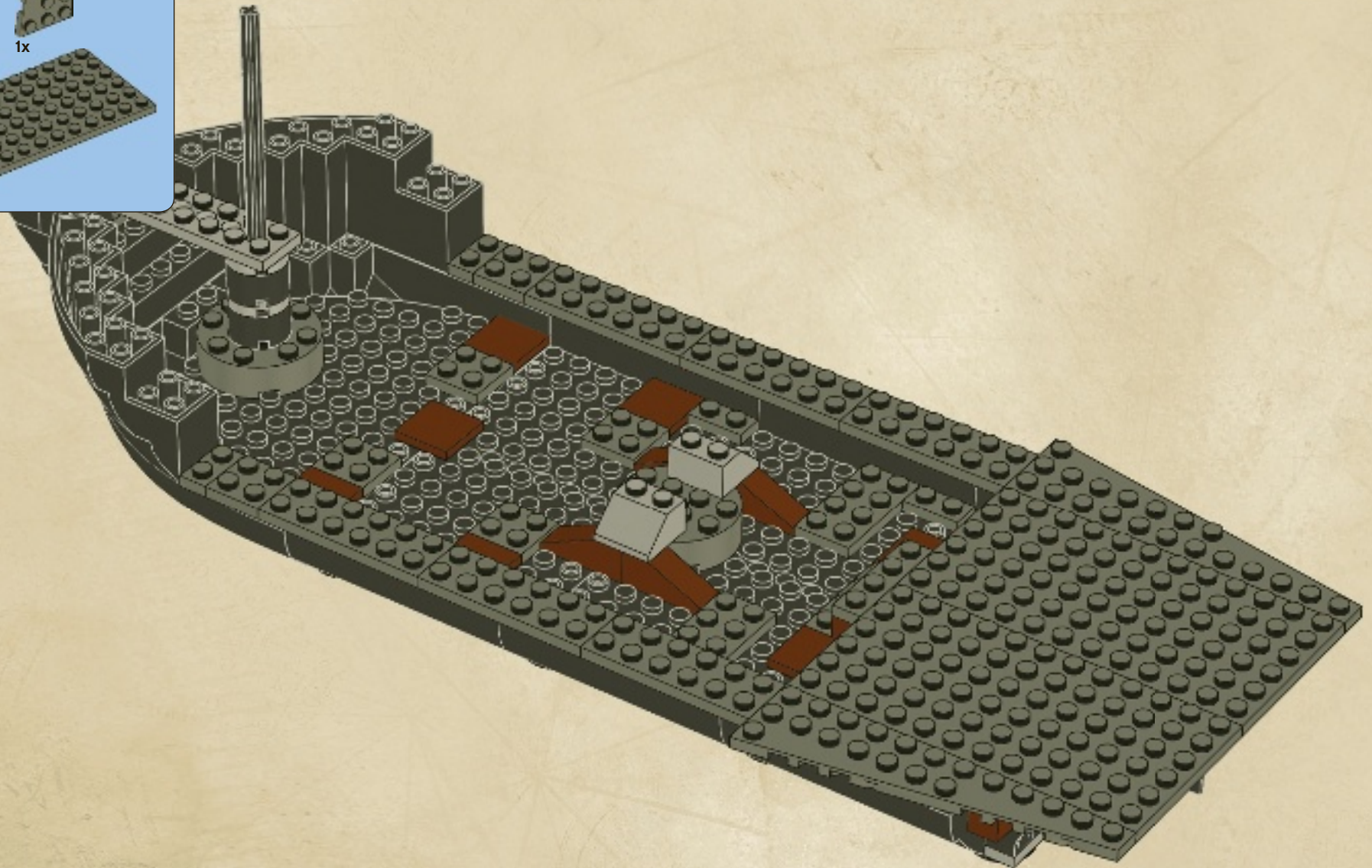

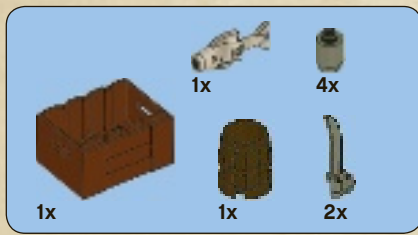

23

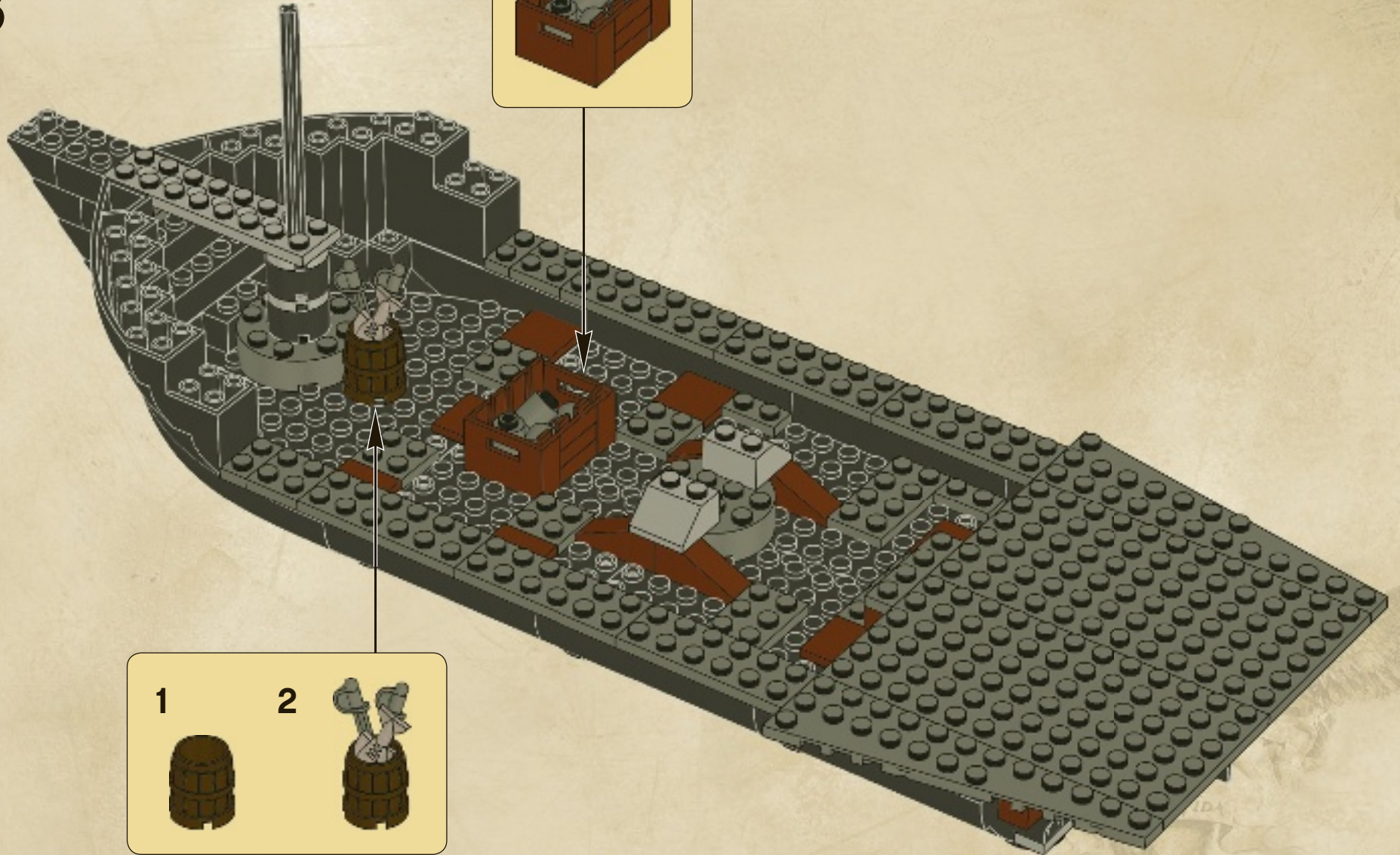
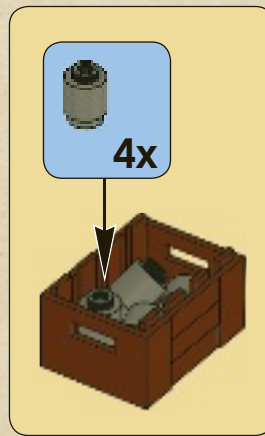

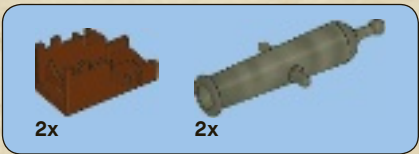

24

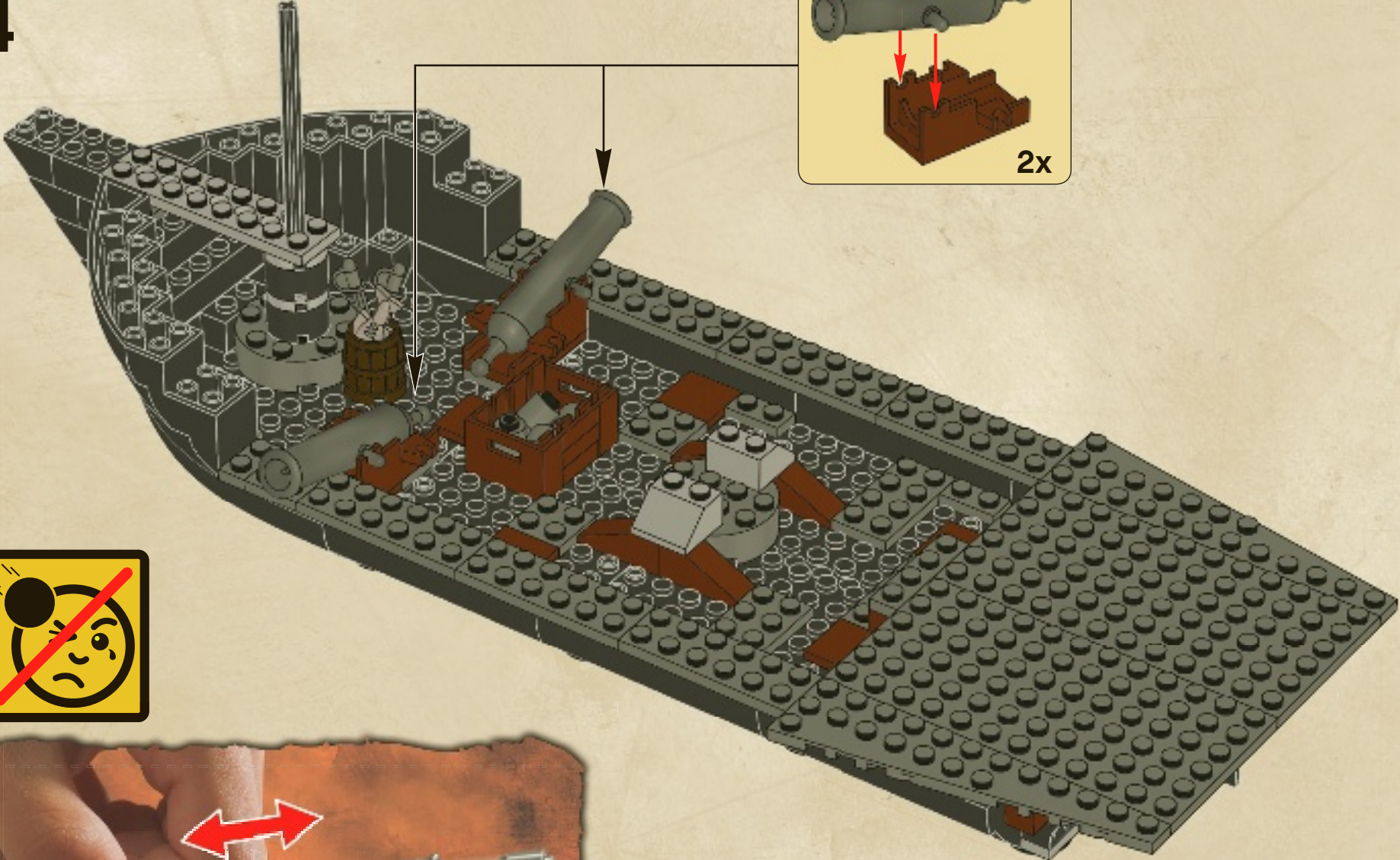
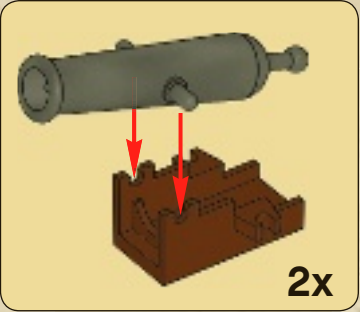

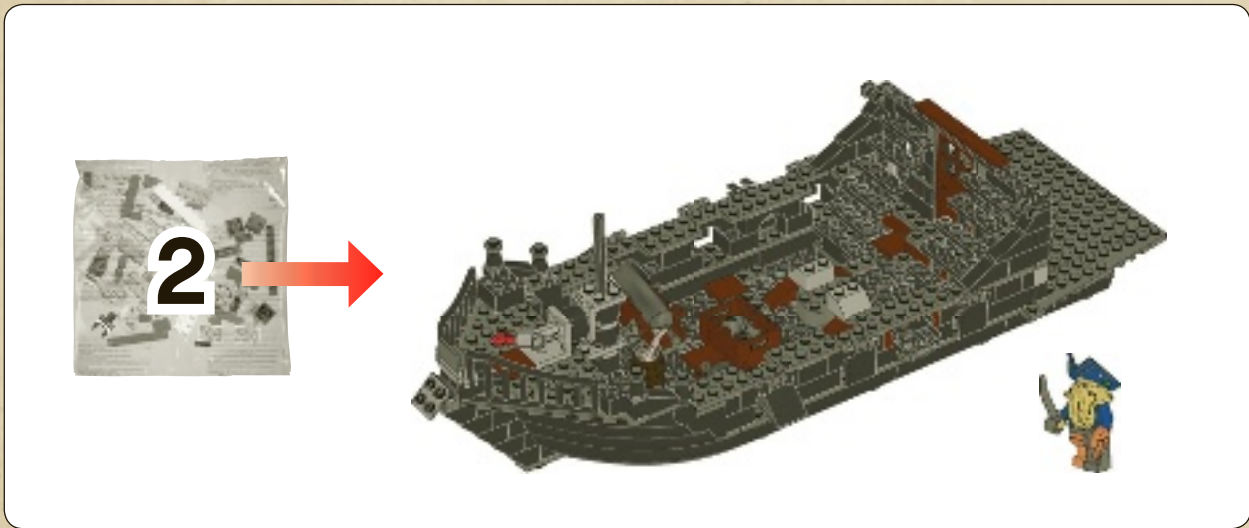



25

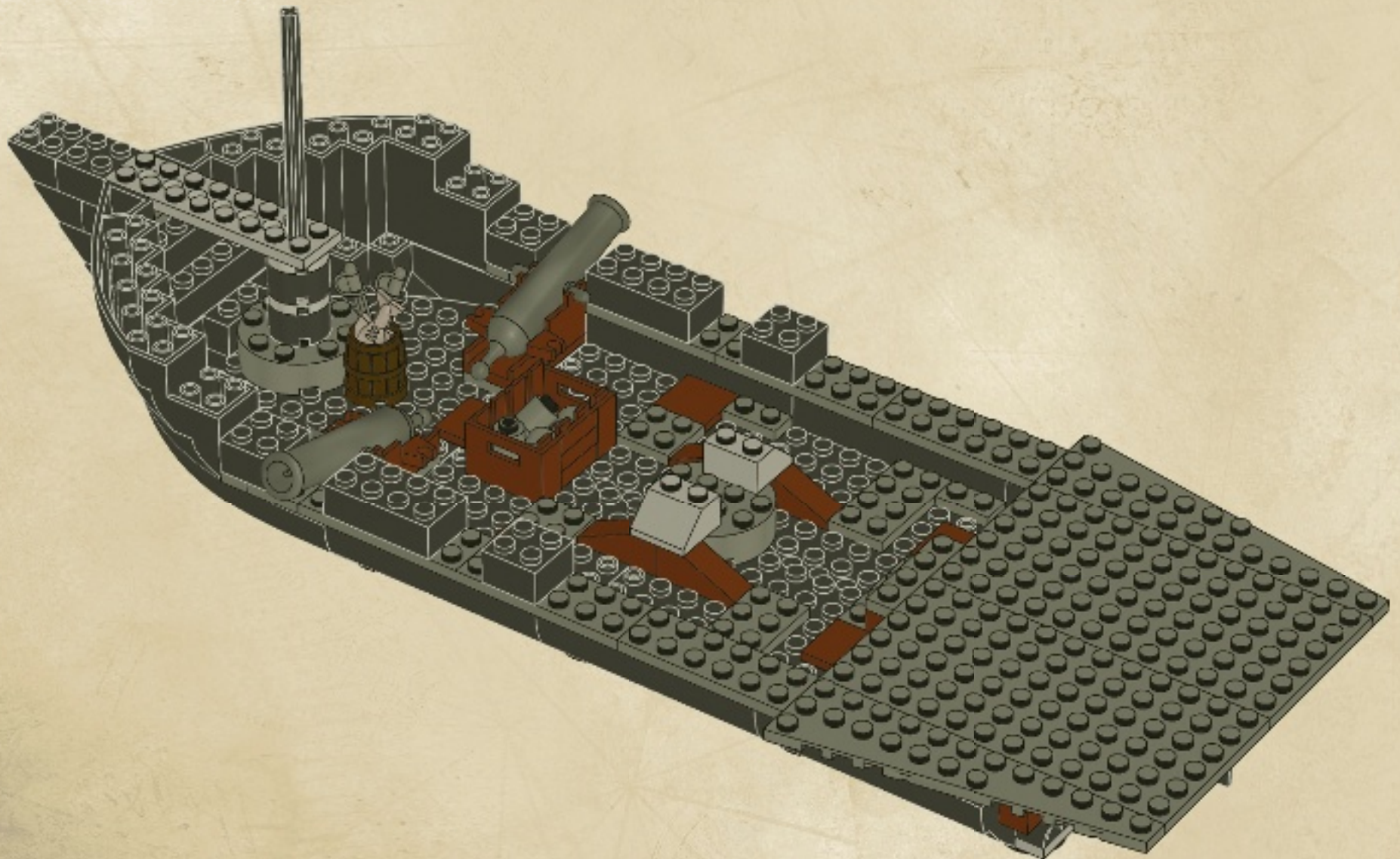

2x 4x

26

2x

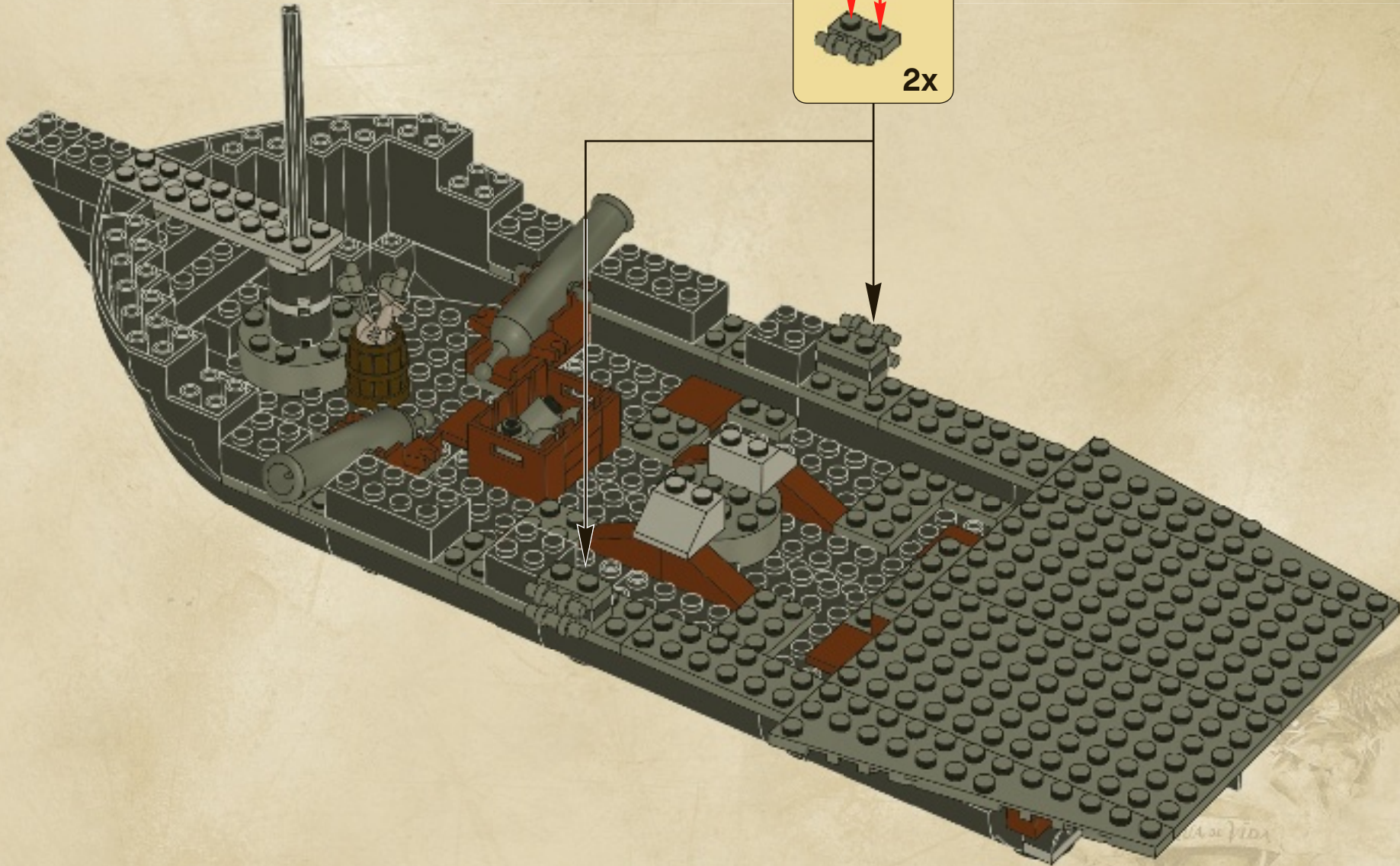



27

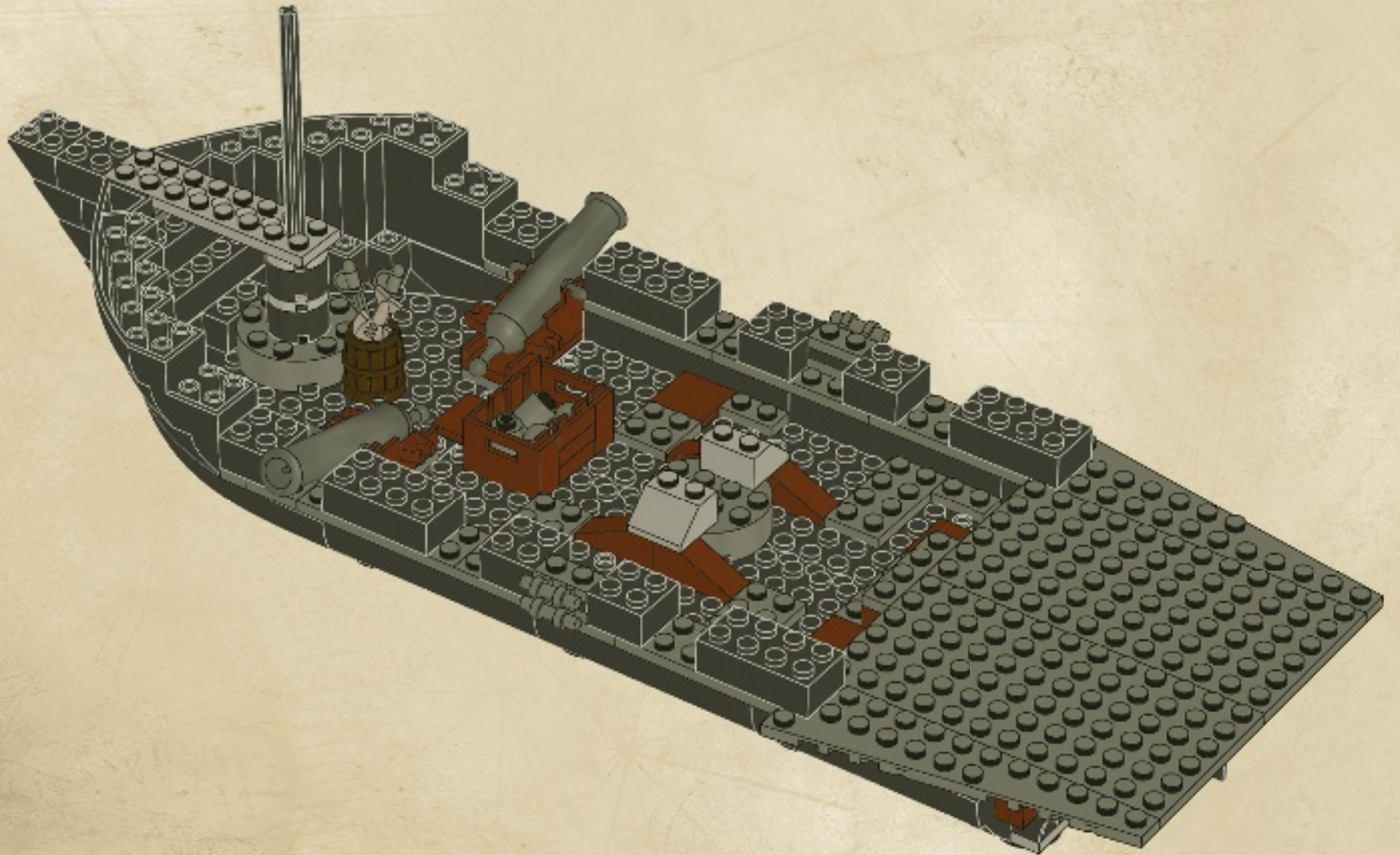



2x



2x

28

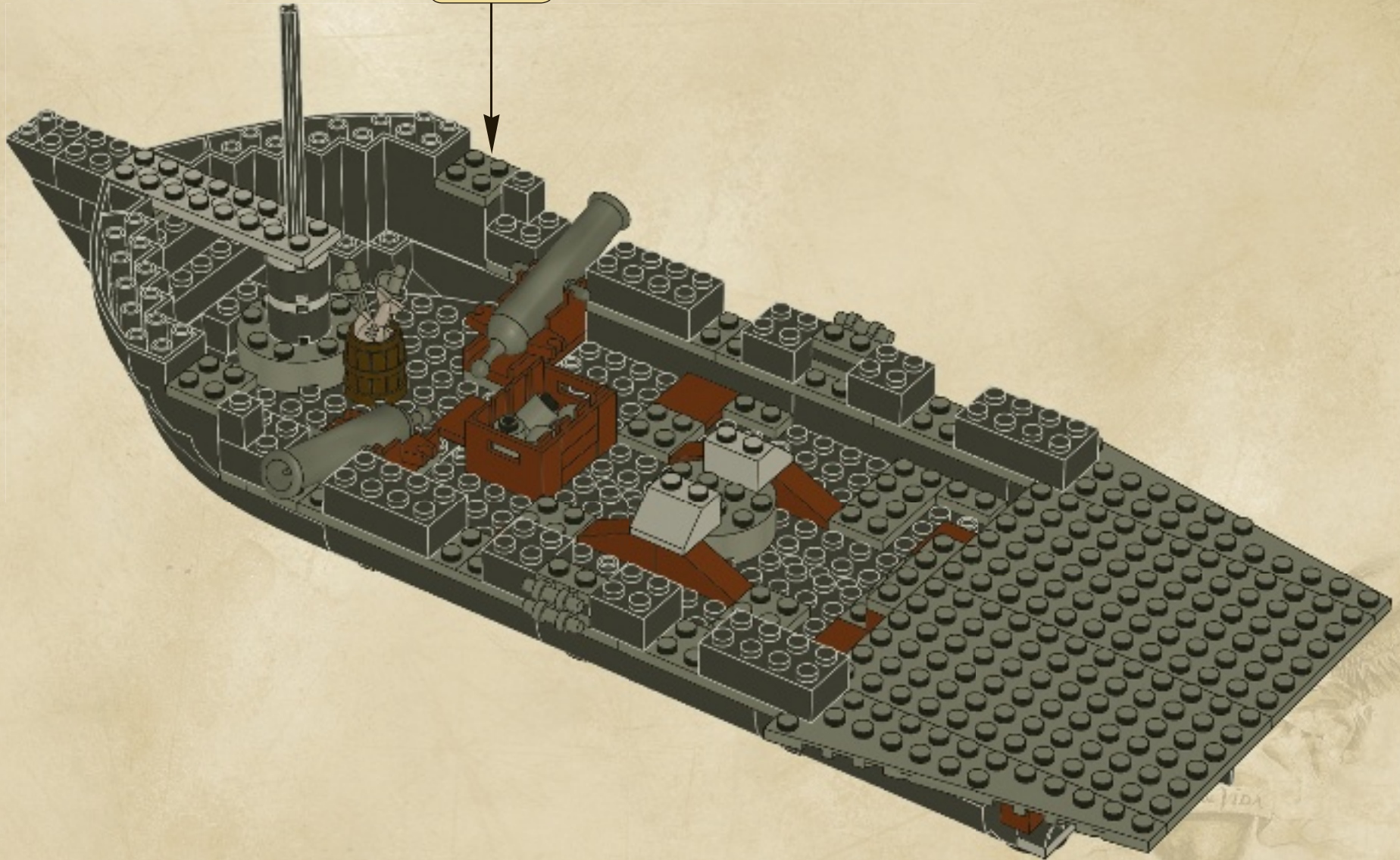
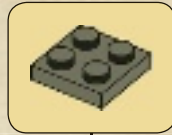



2x



6x

29

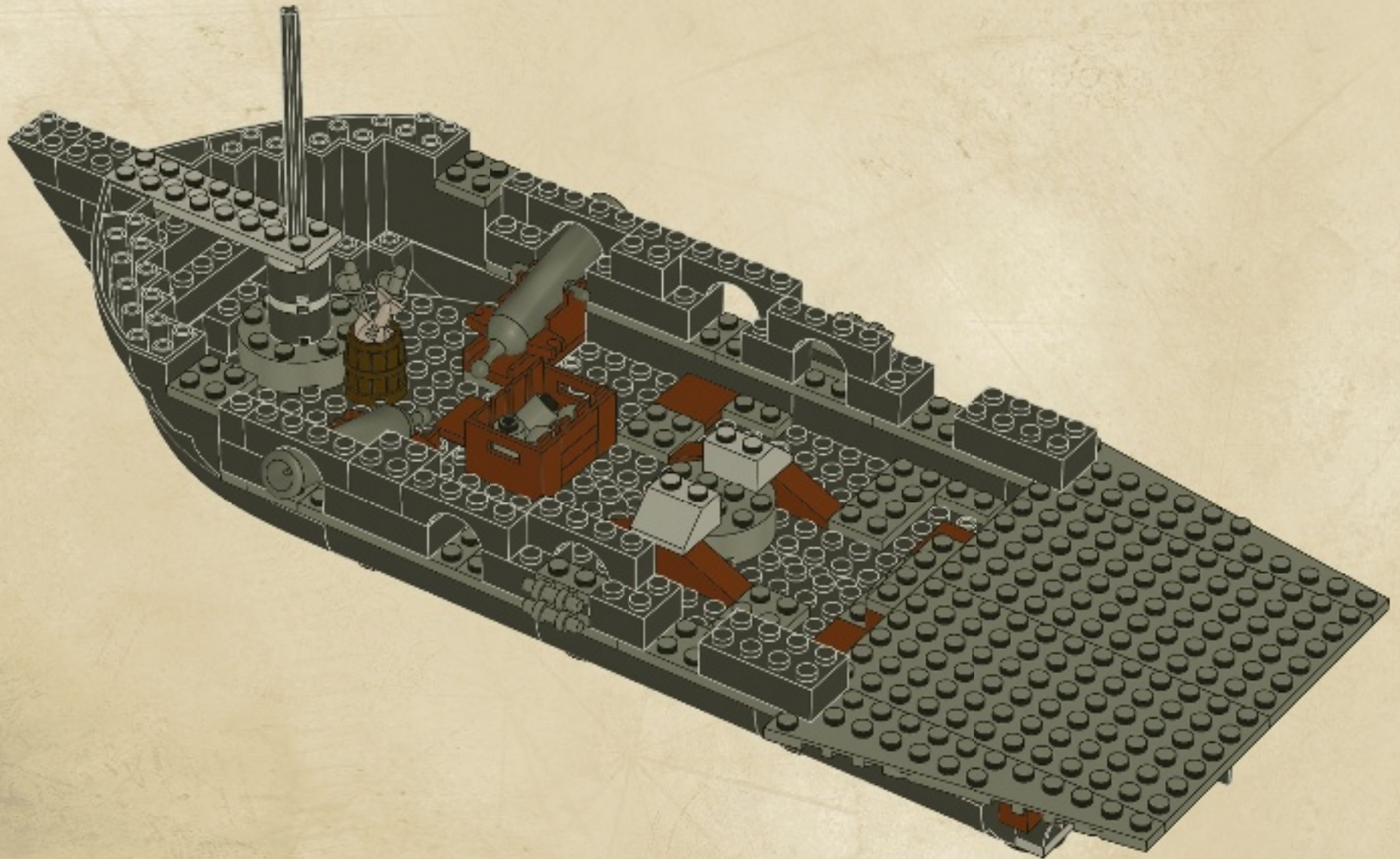



30

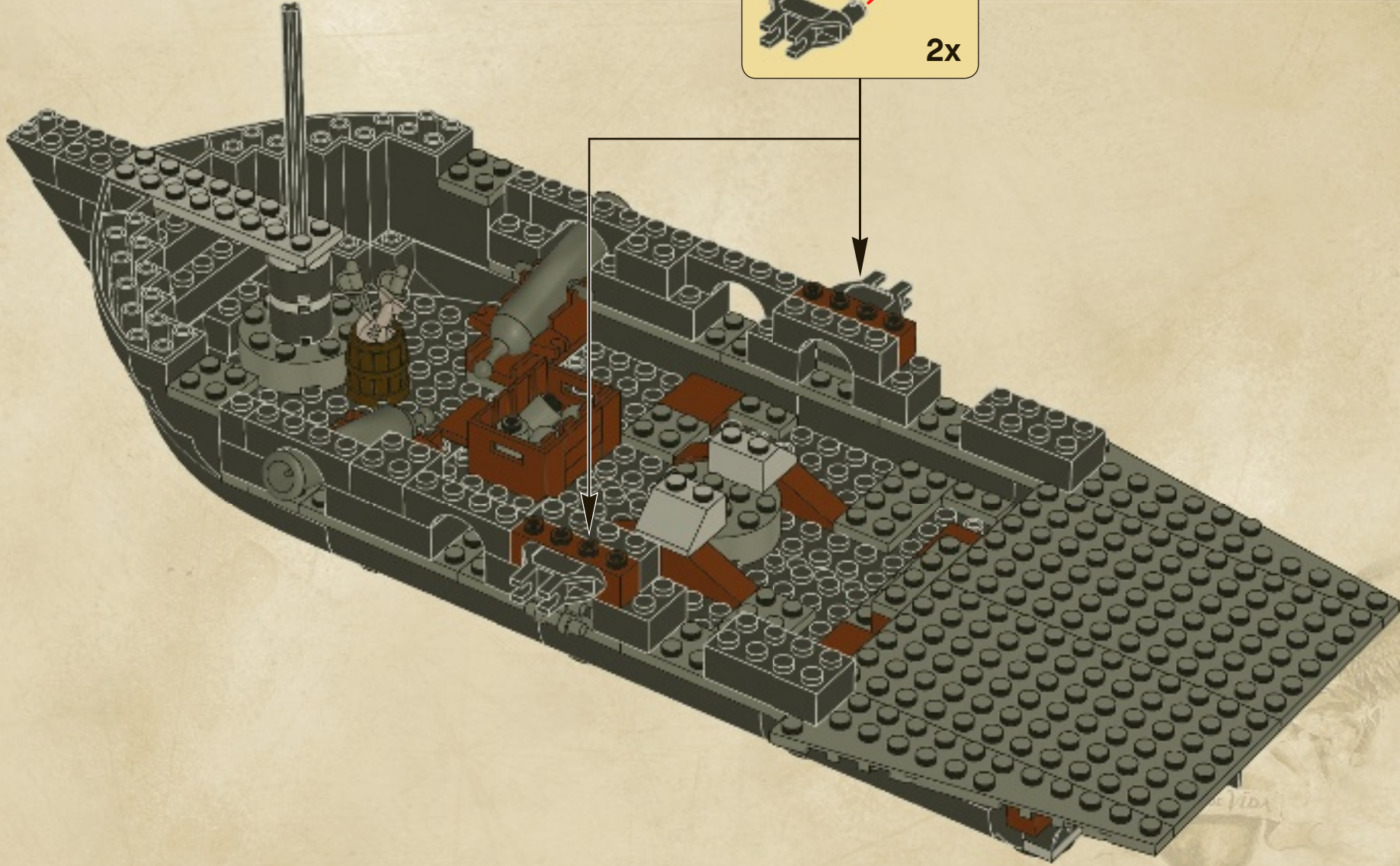
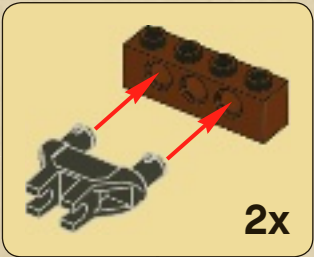



31

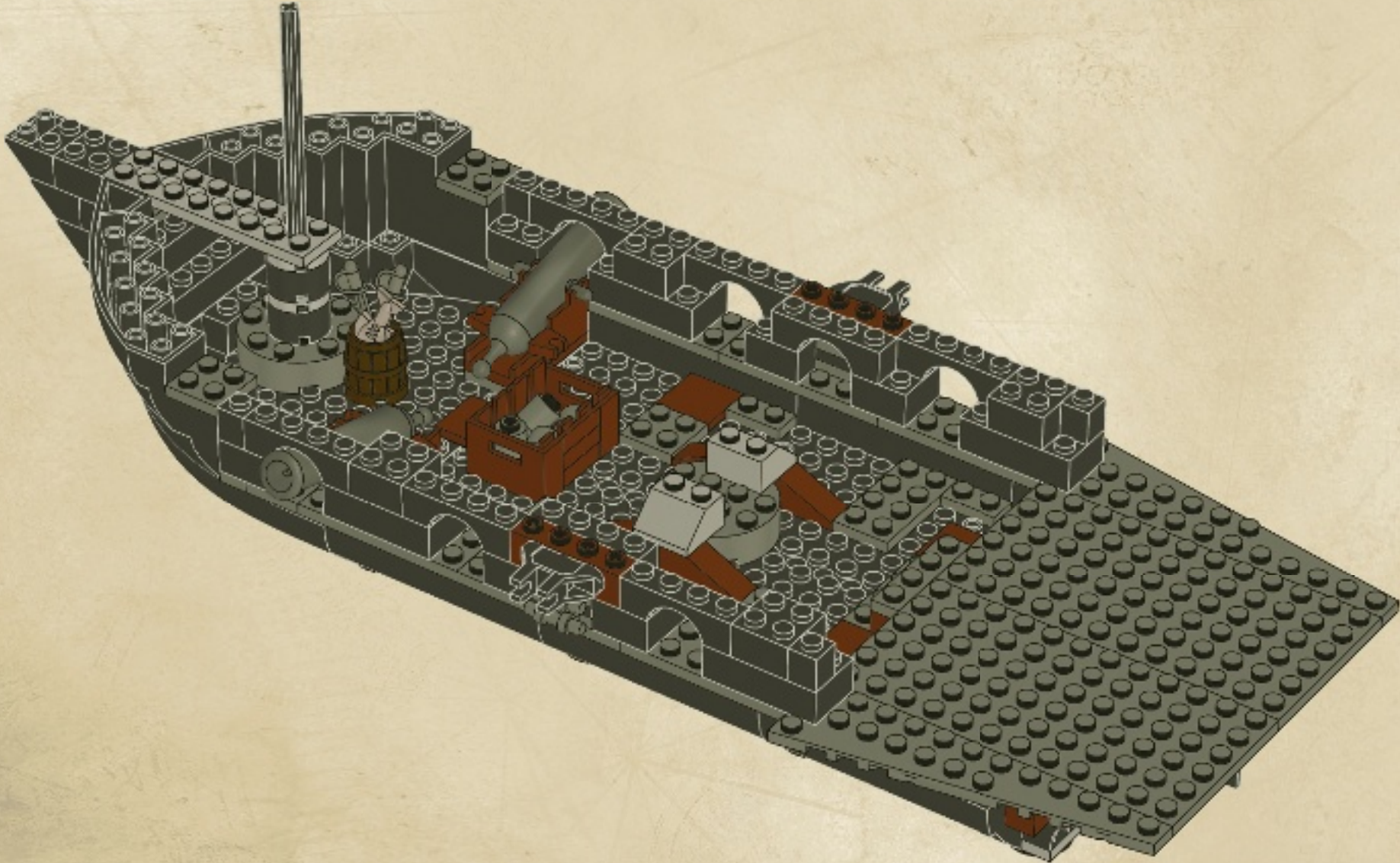

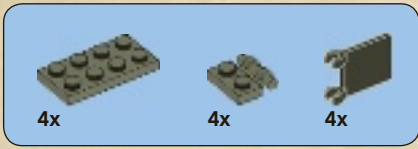

32

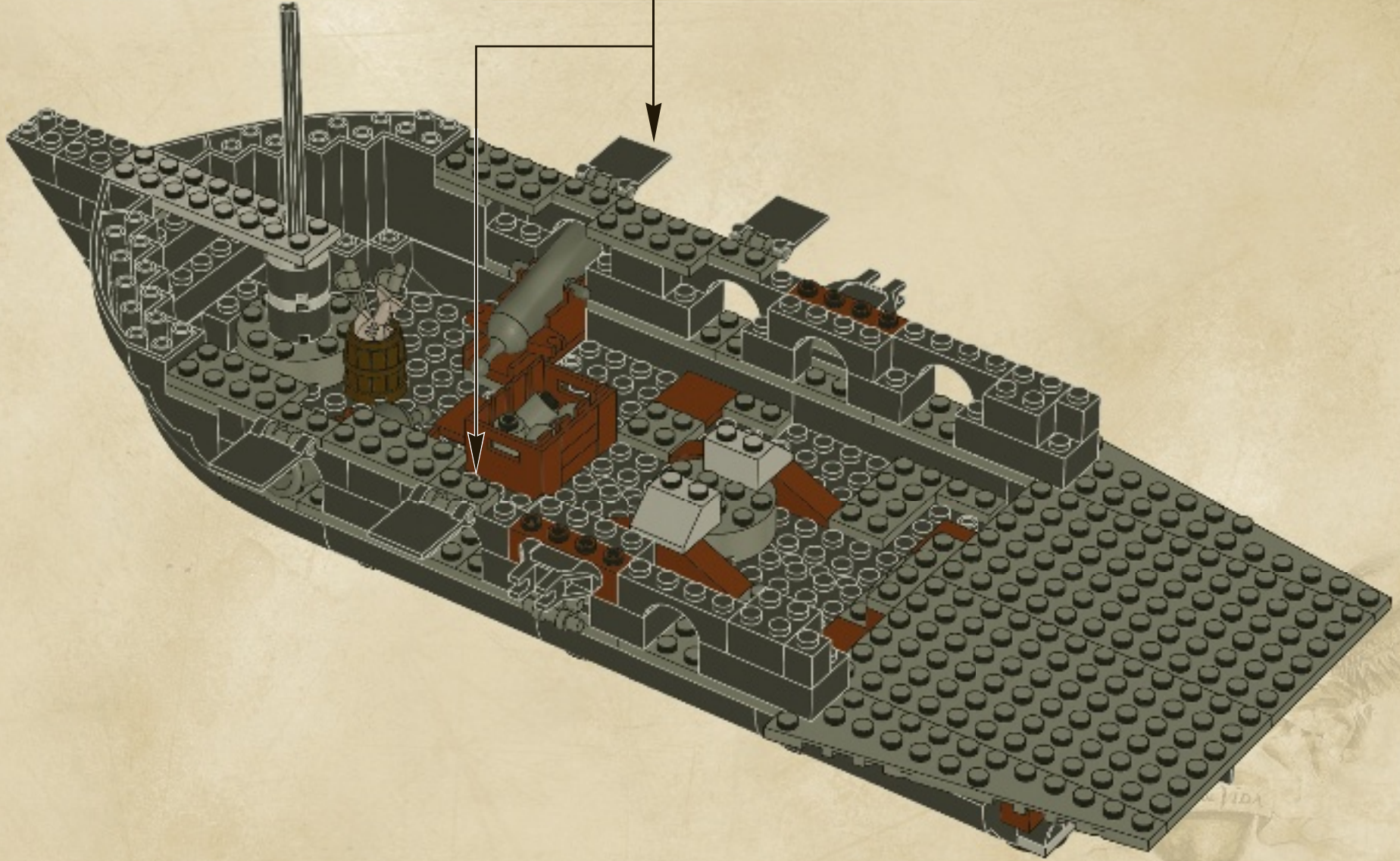
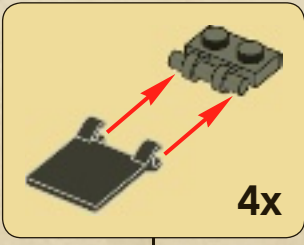

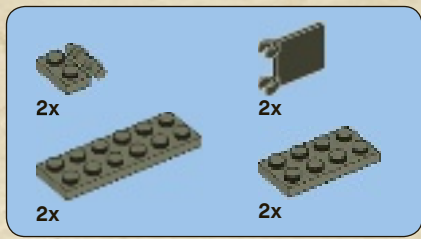

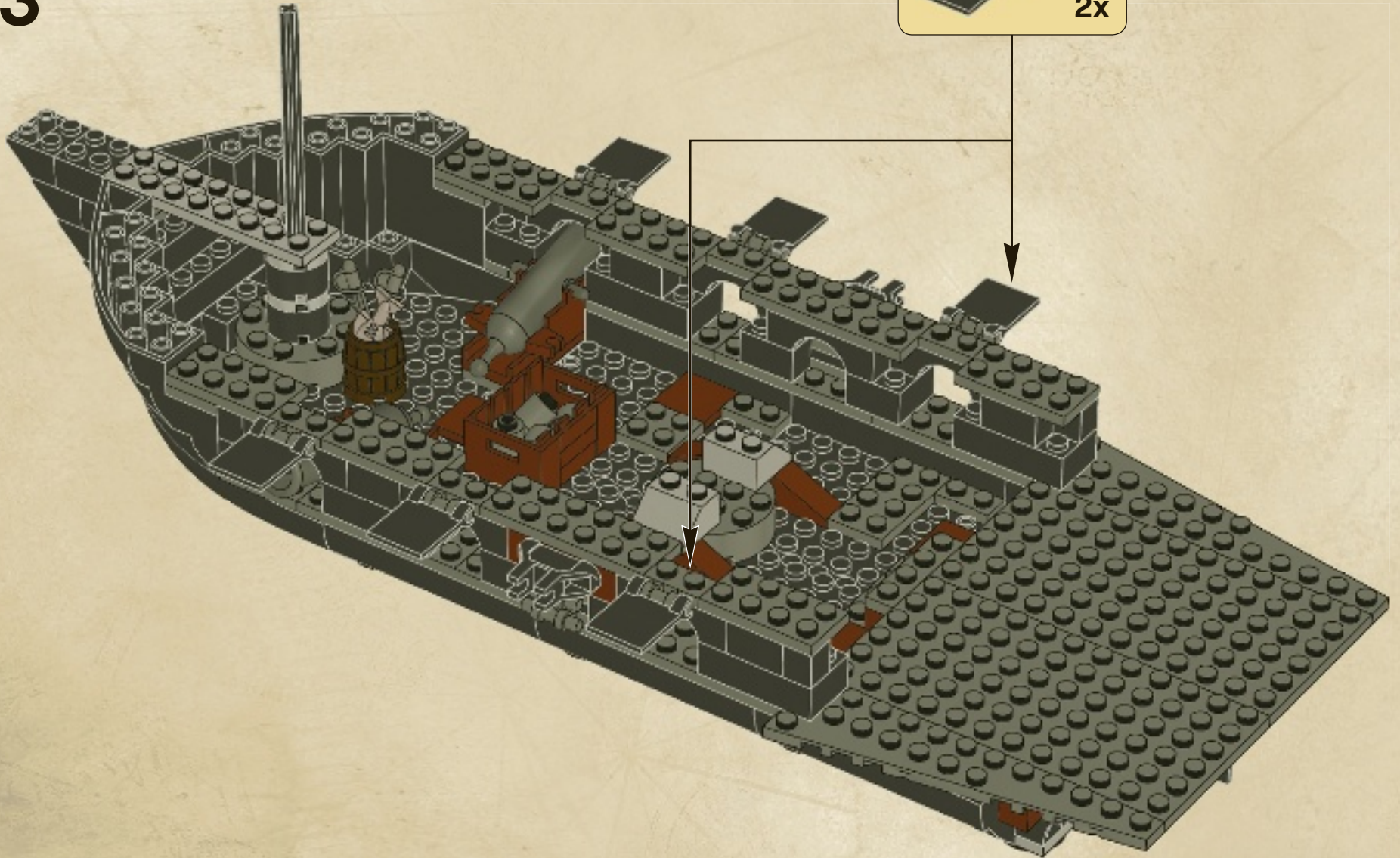
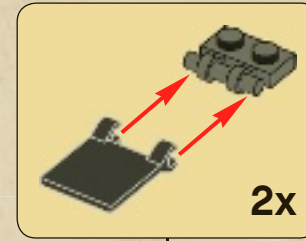

33

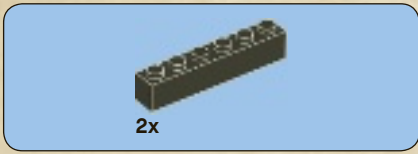

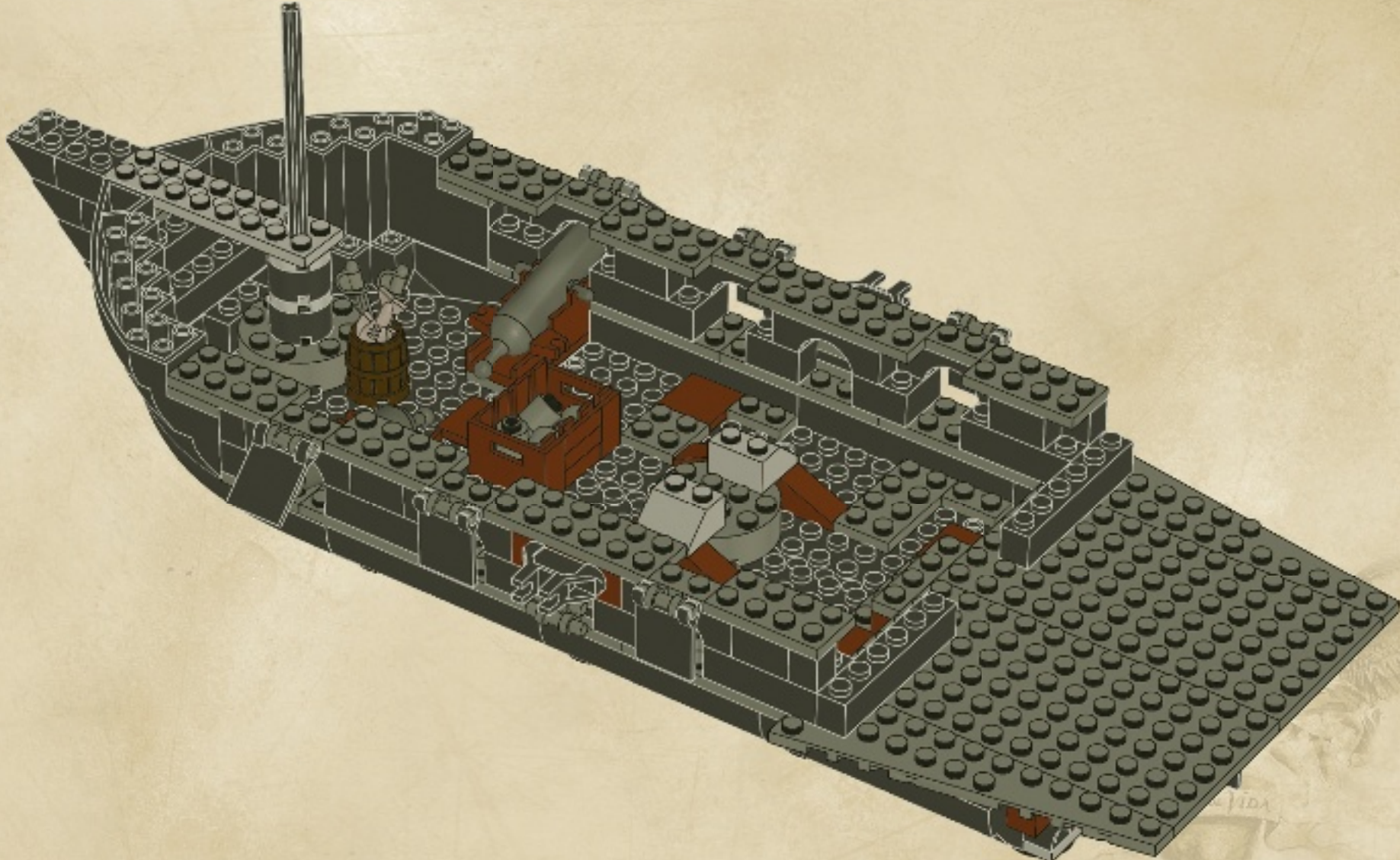

34



2x  4x 

35

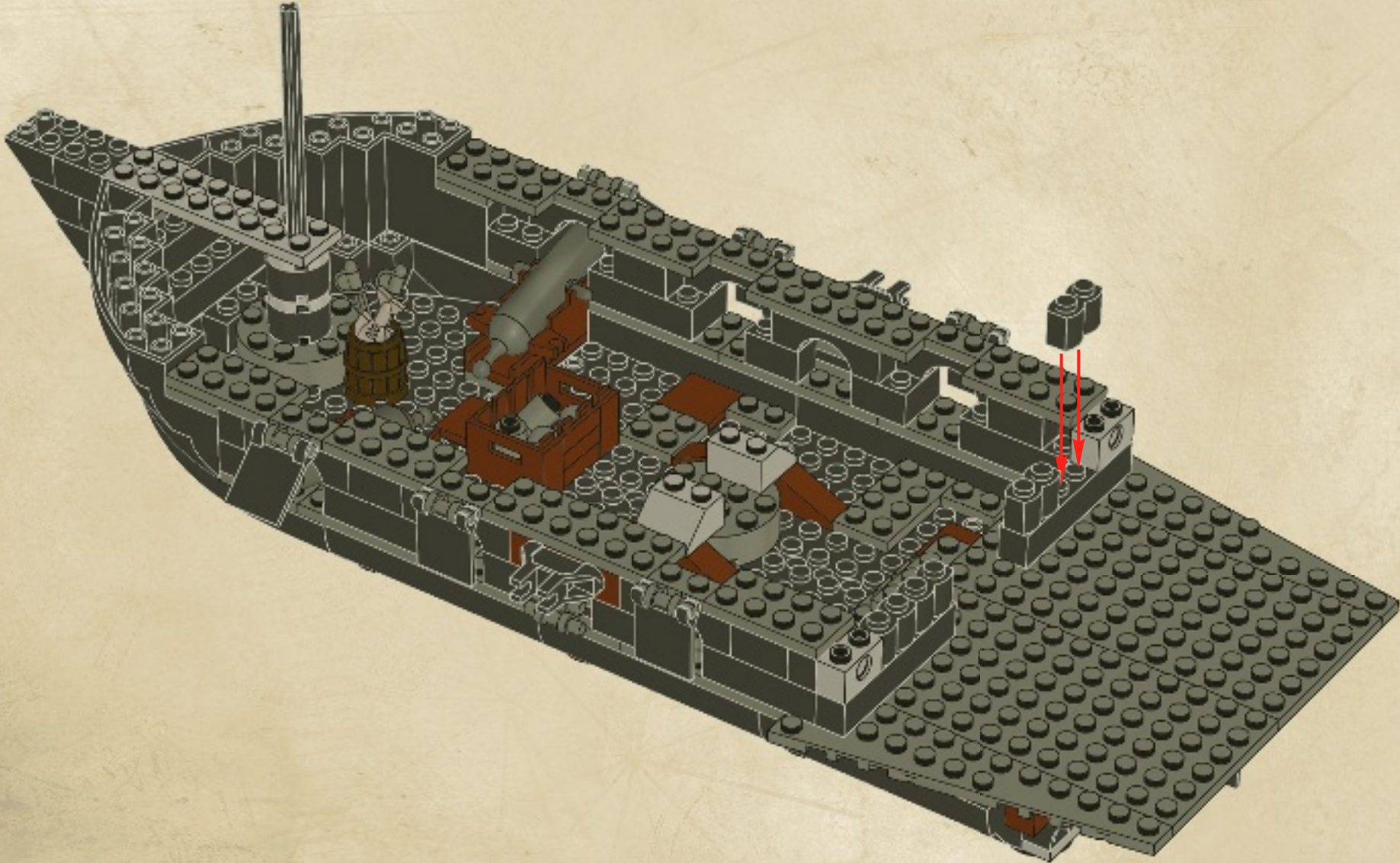



36

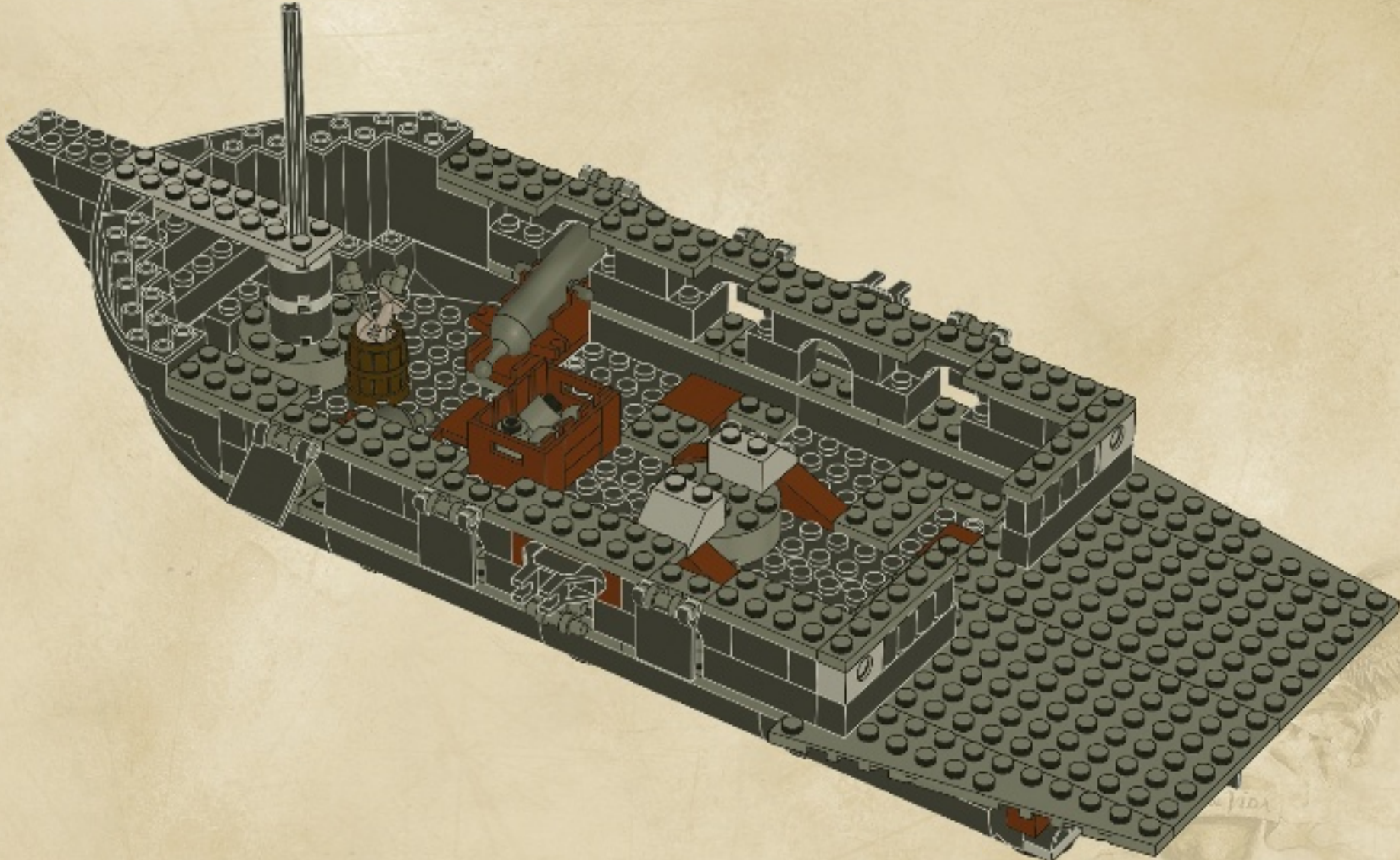

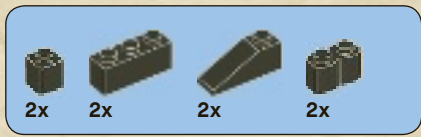

37

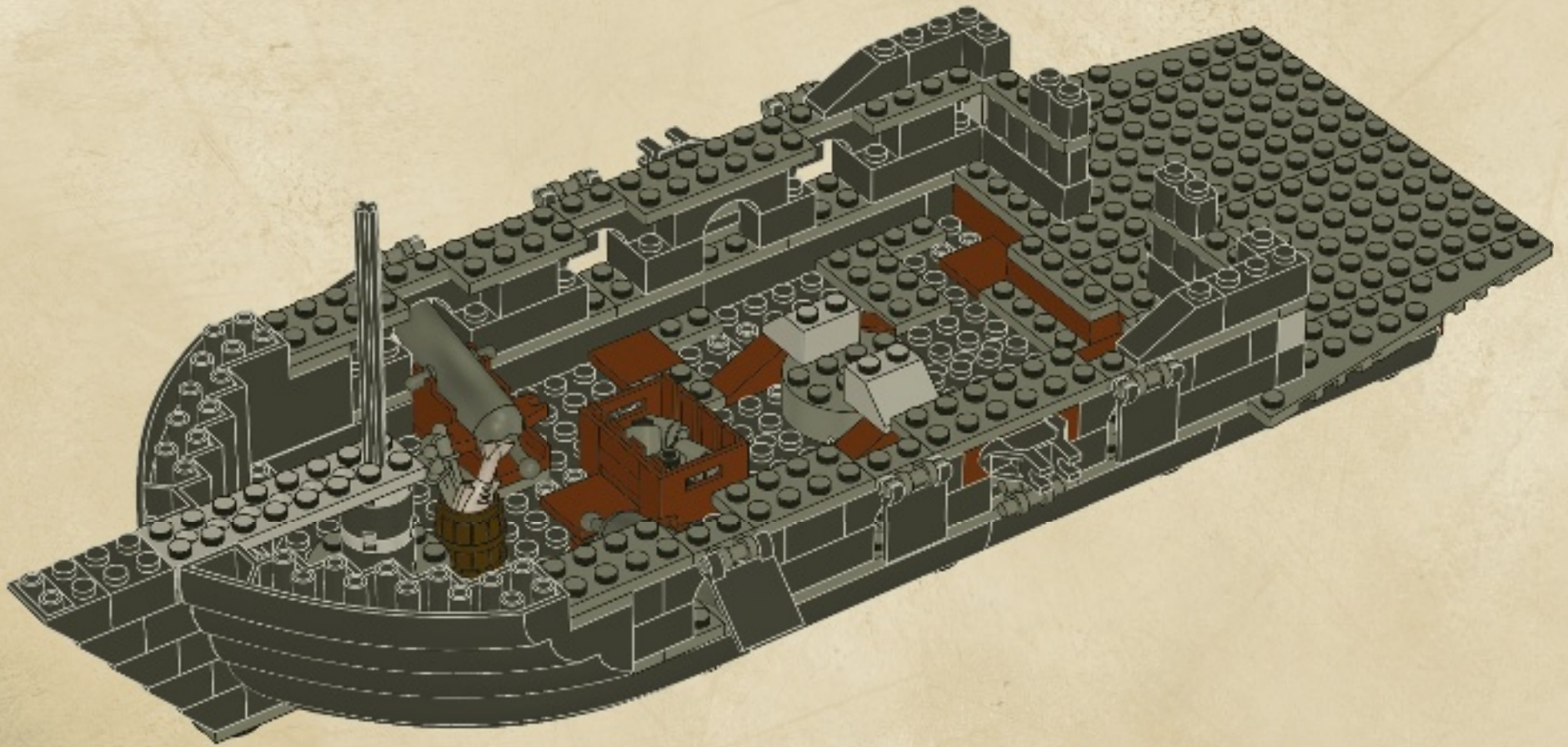



38

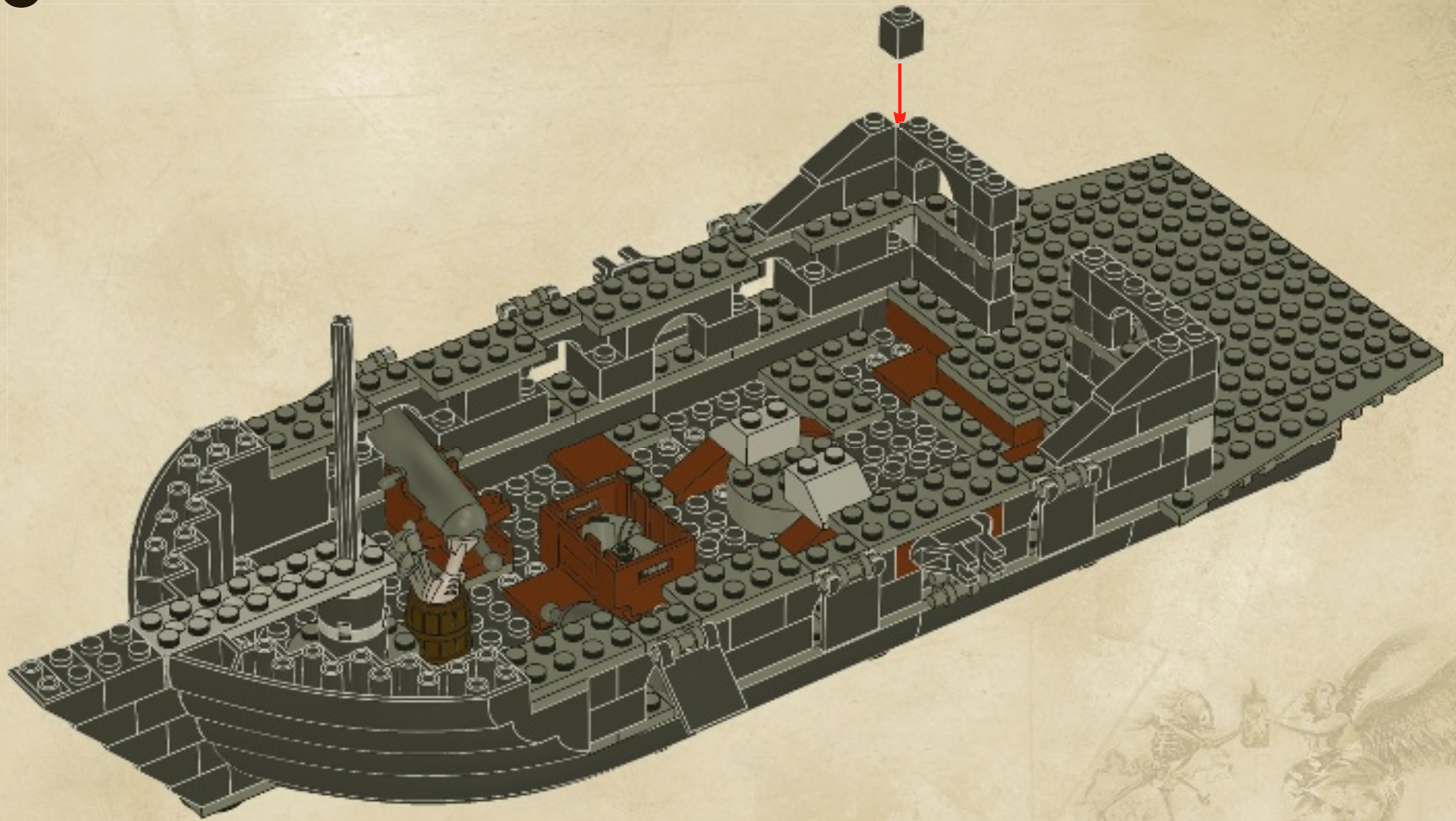



6x

39

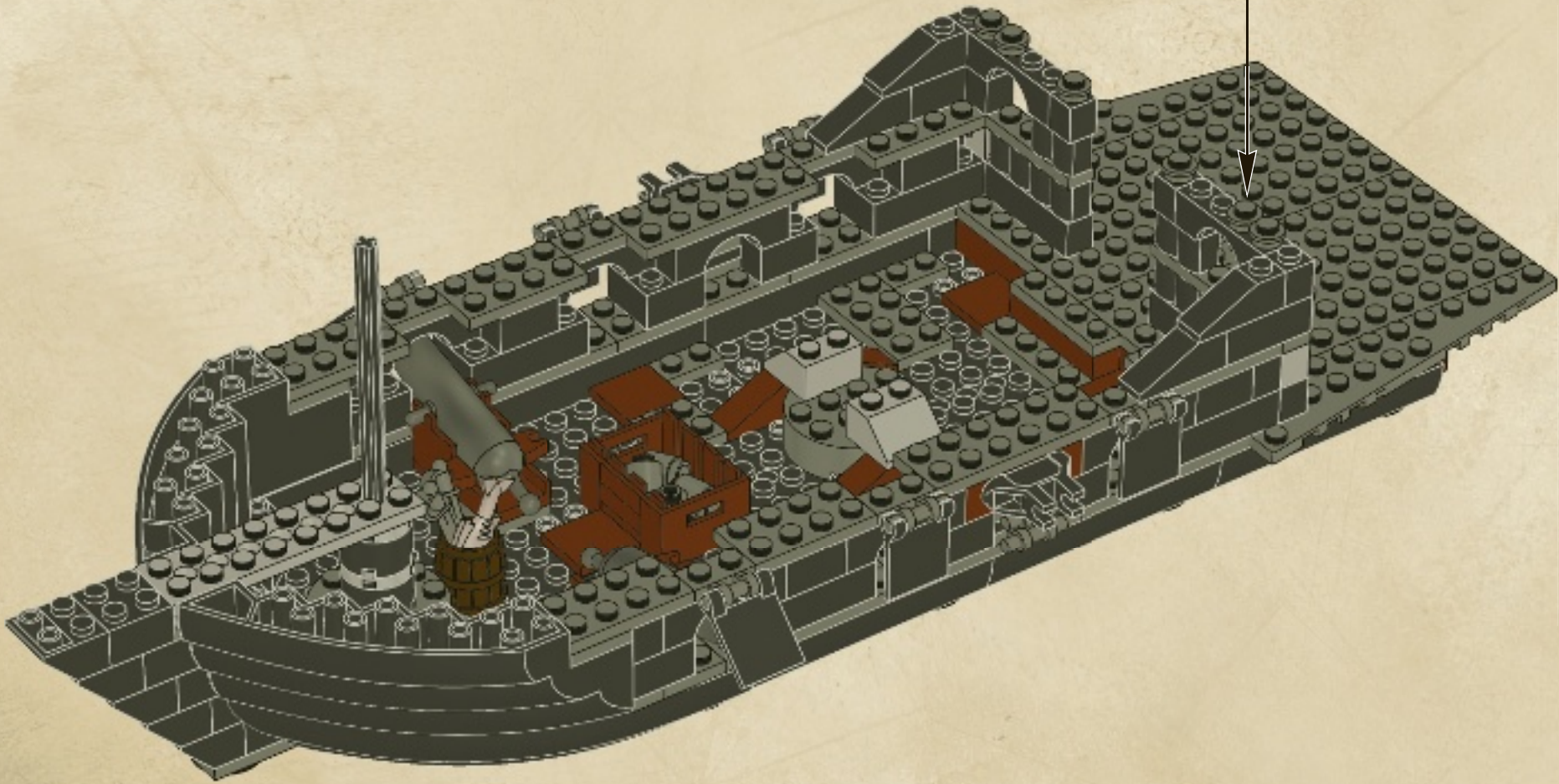

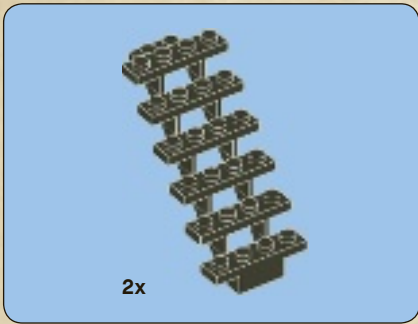

40

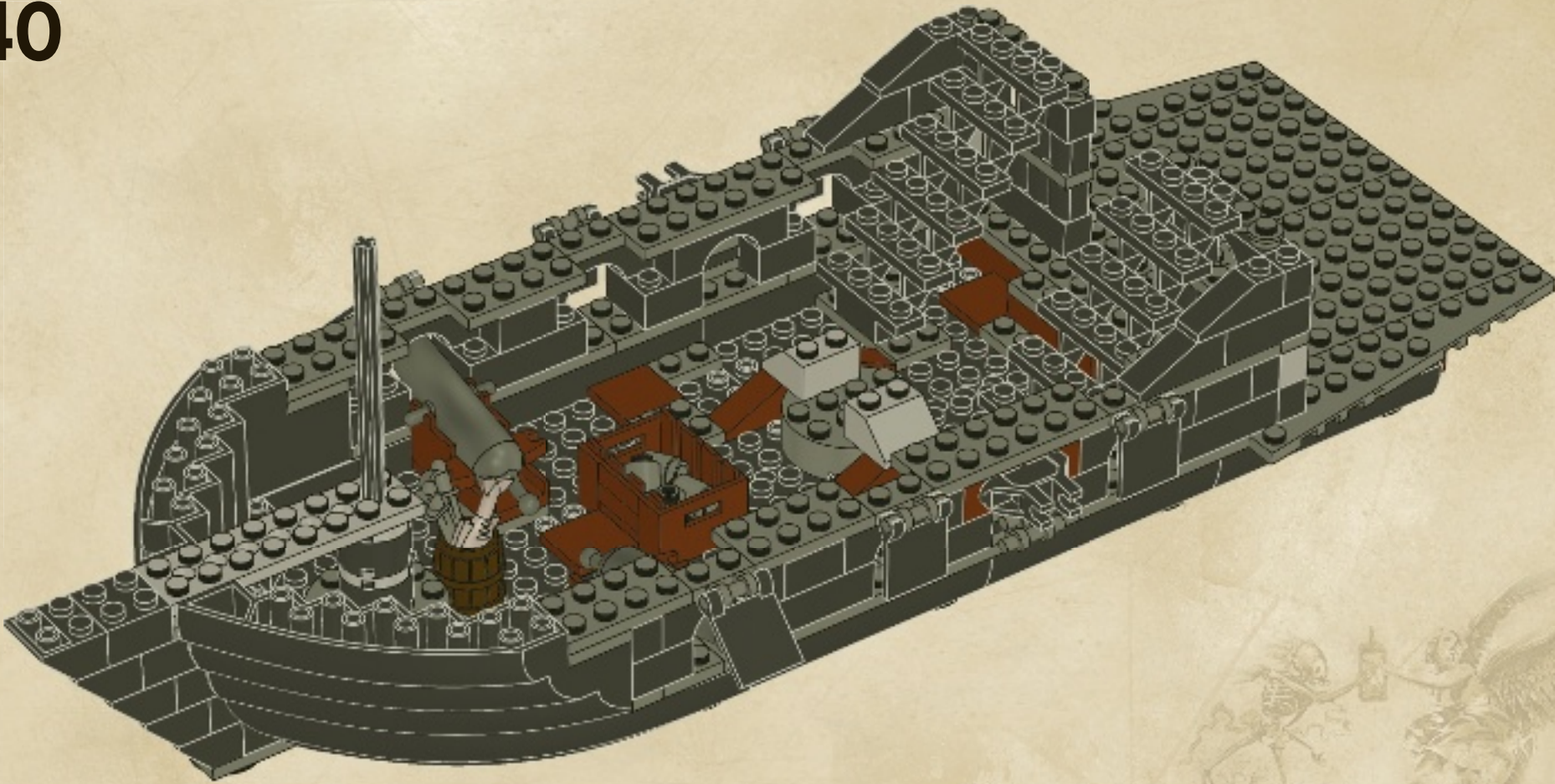



41



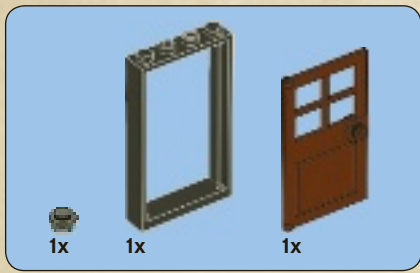

42

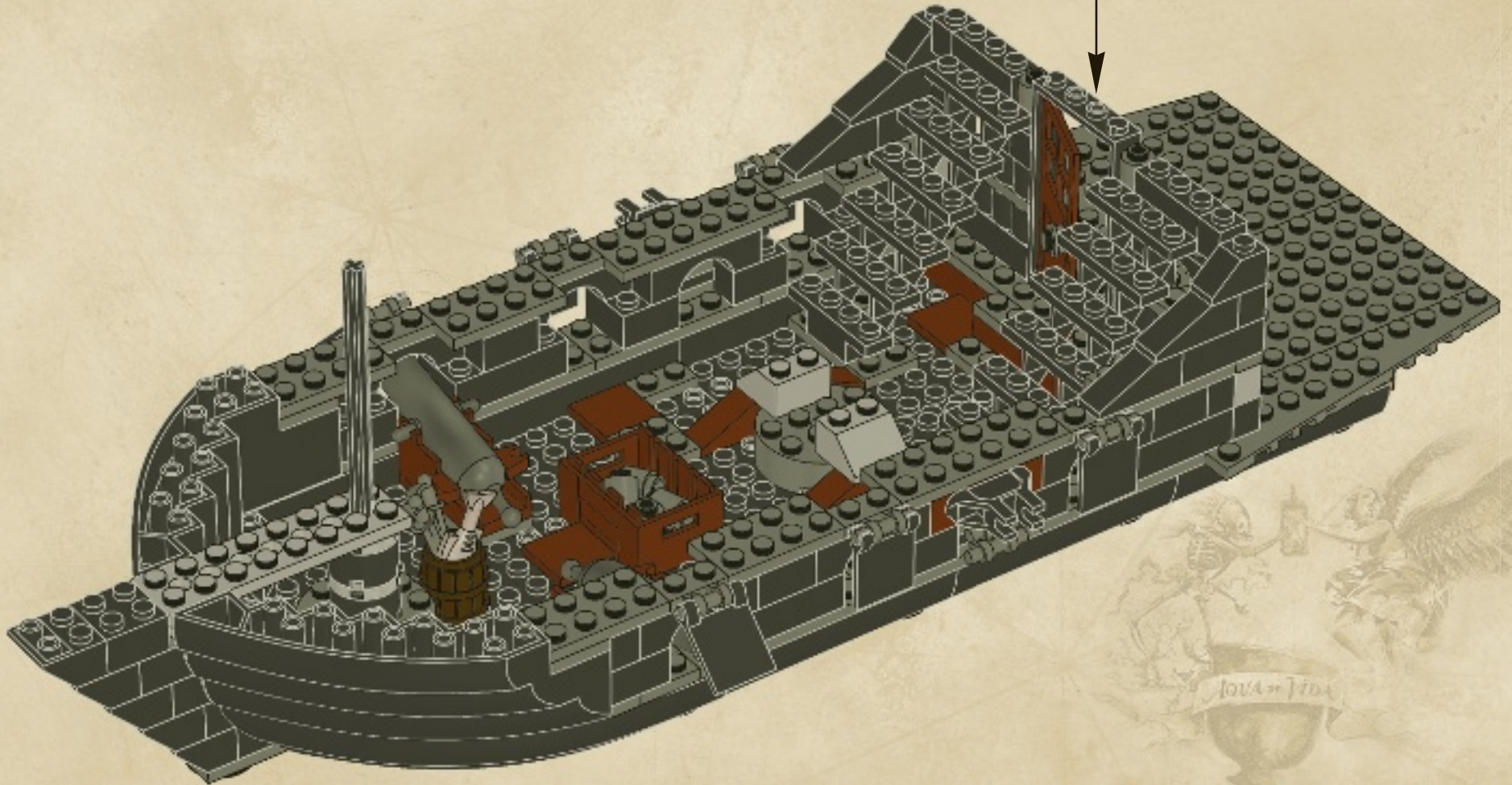
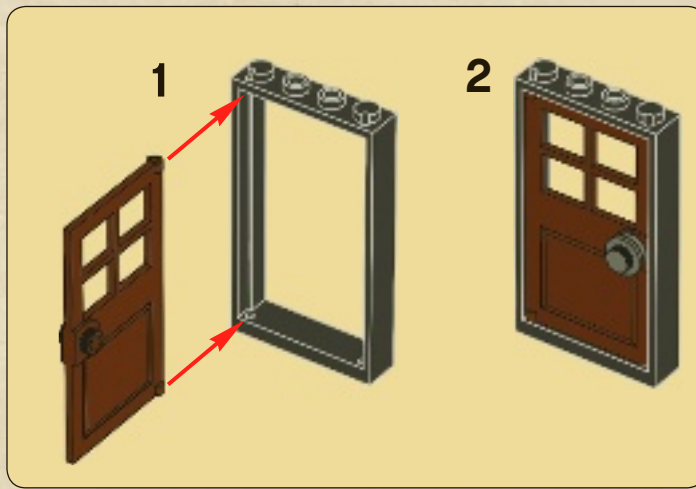

2x 4x 2x

43

2x

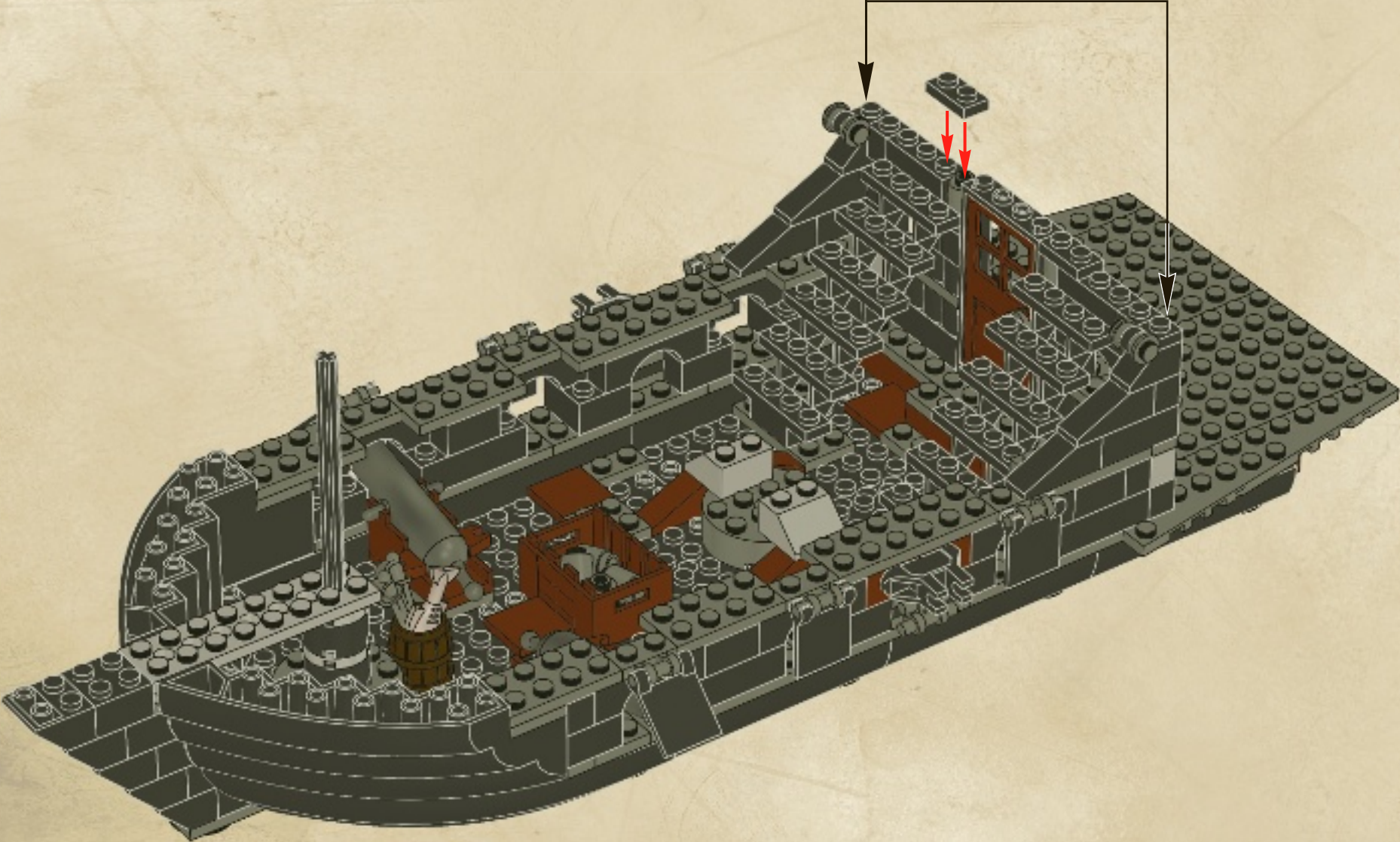



44

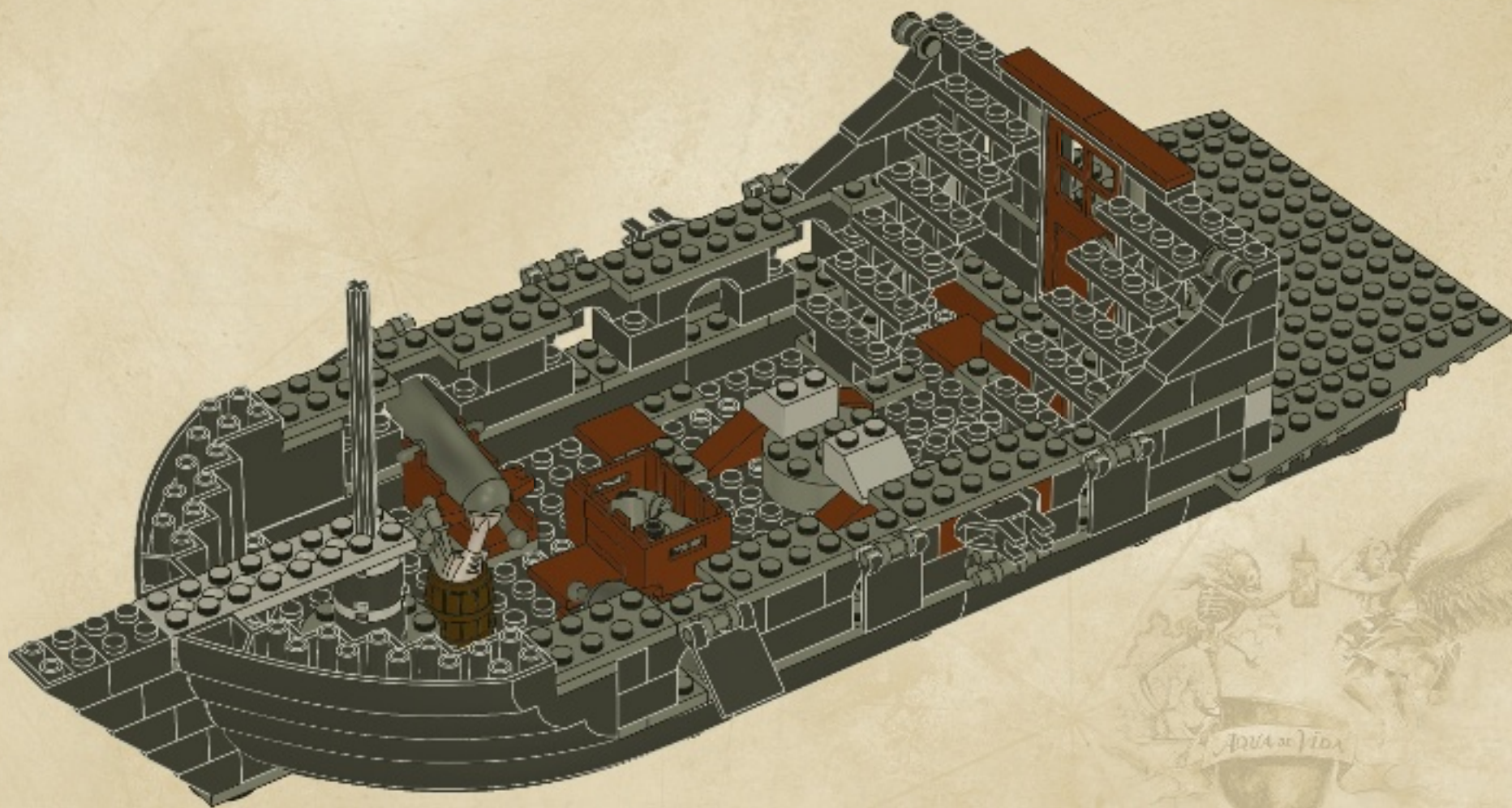



45

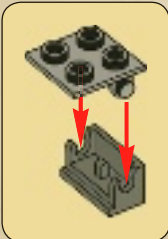
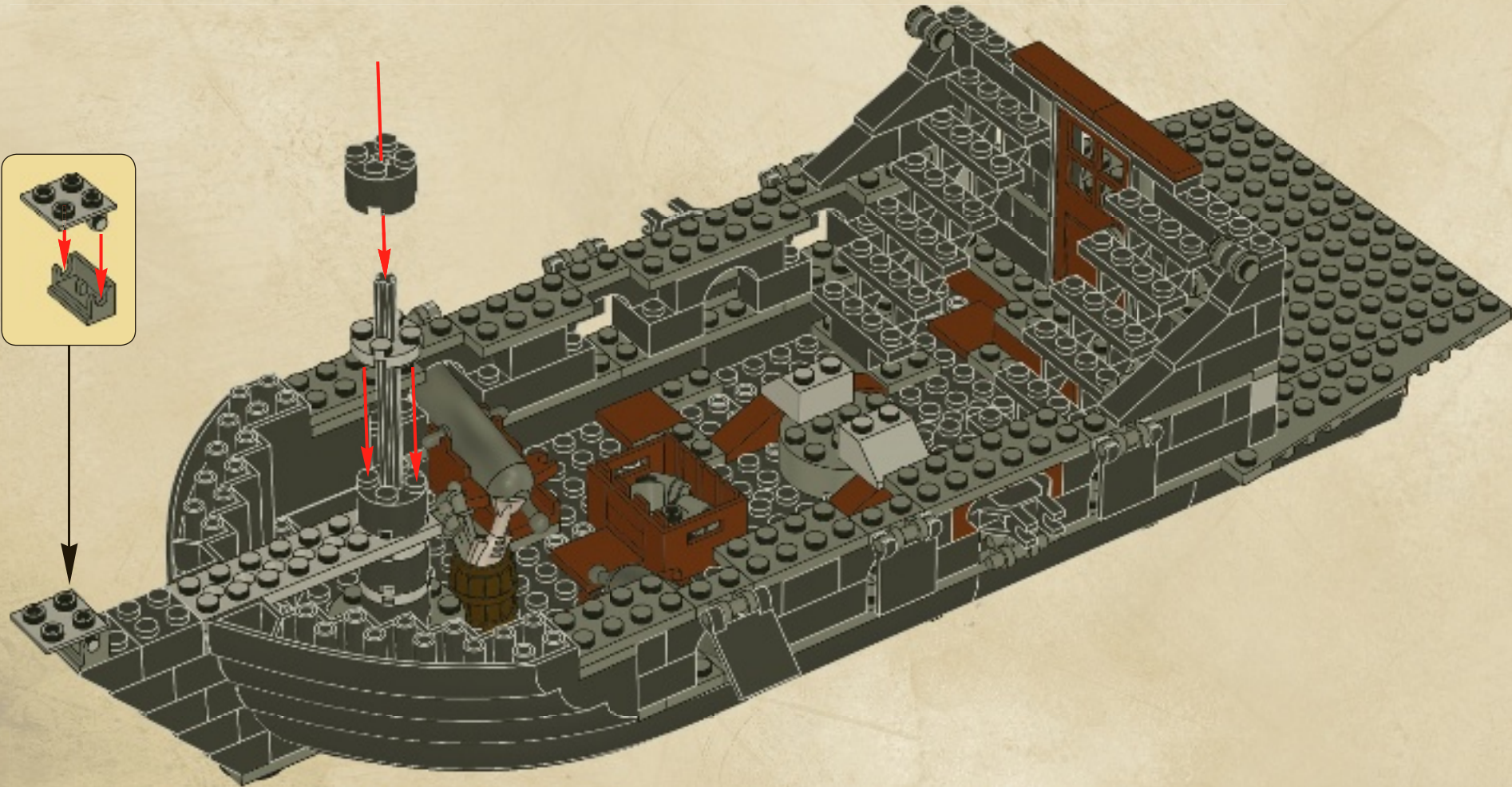



46

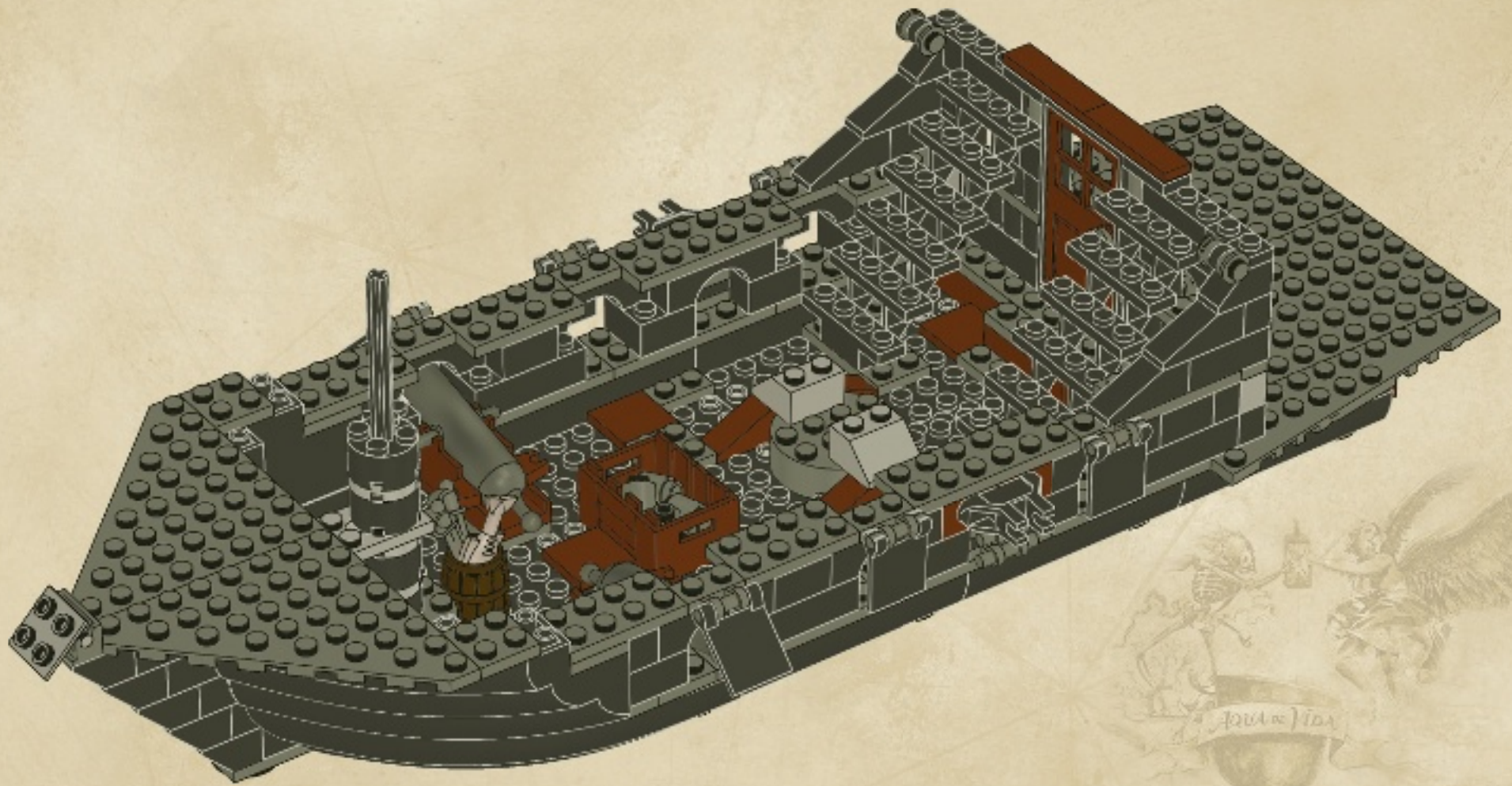



2x



4x



1x

47

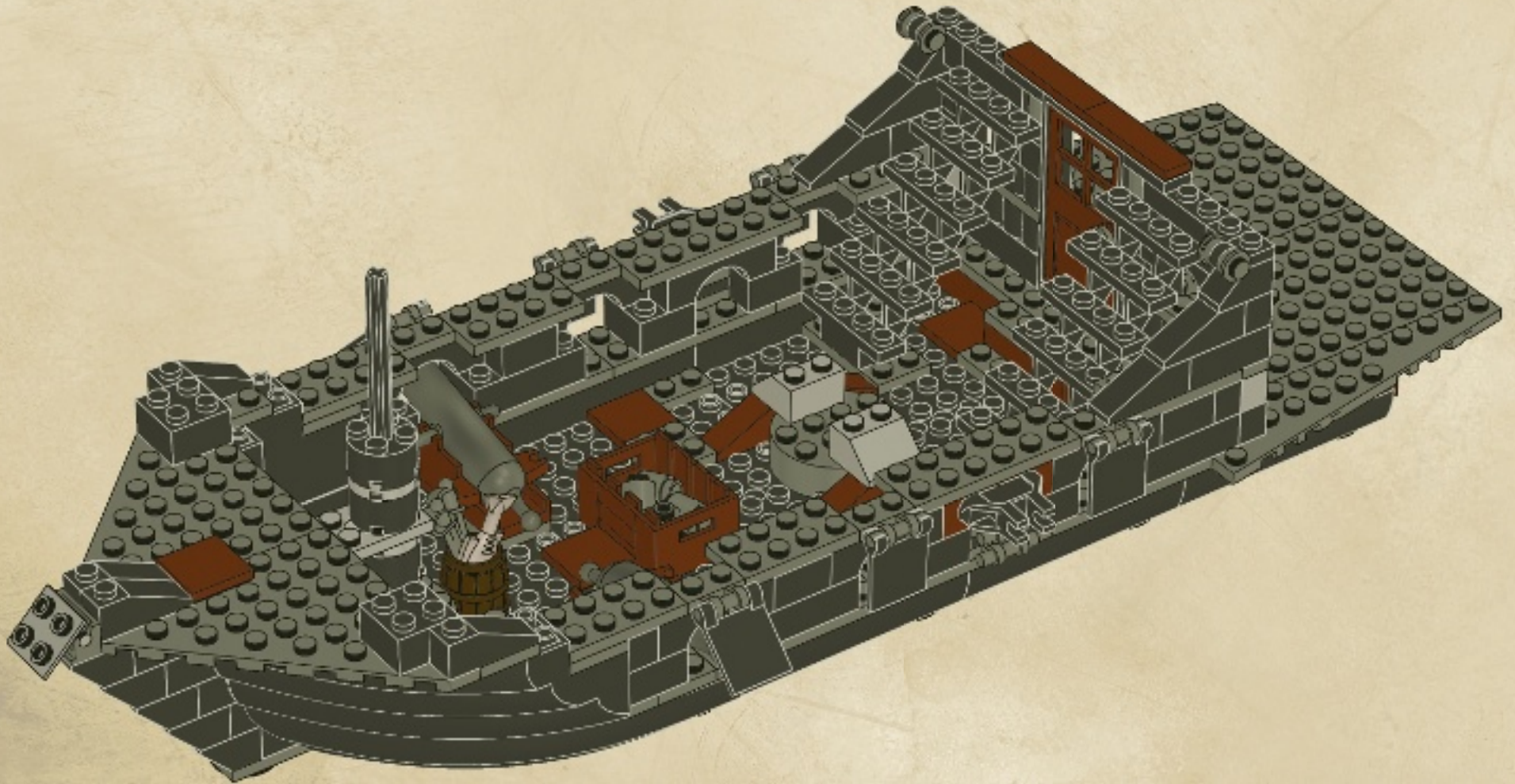



48

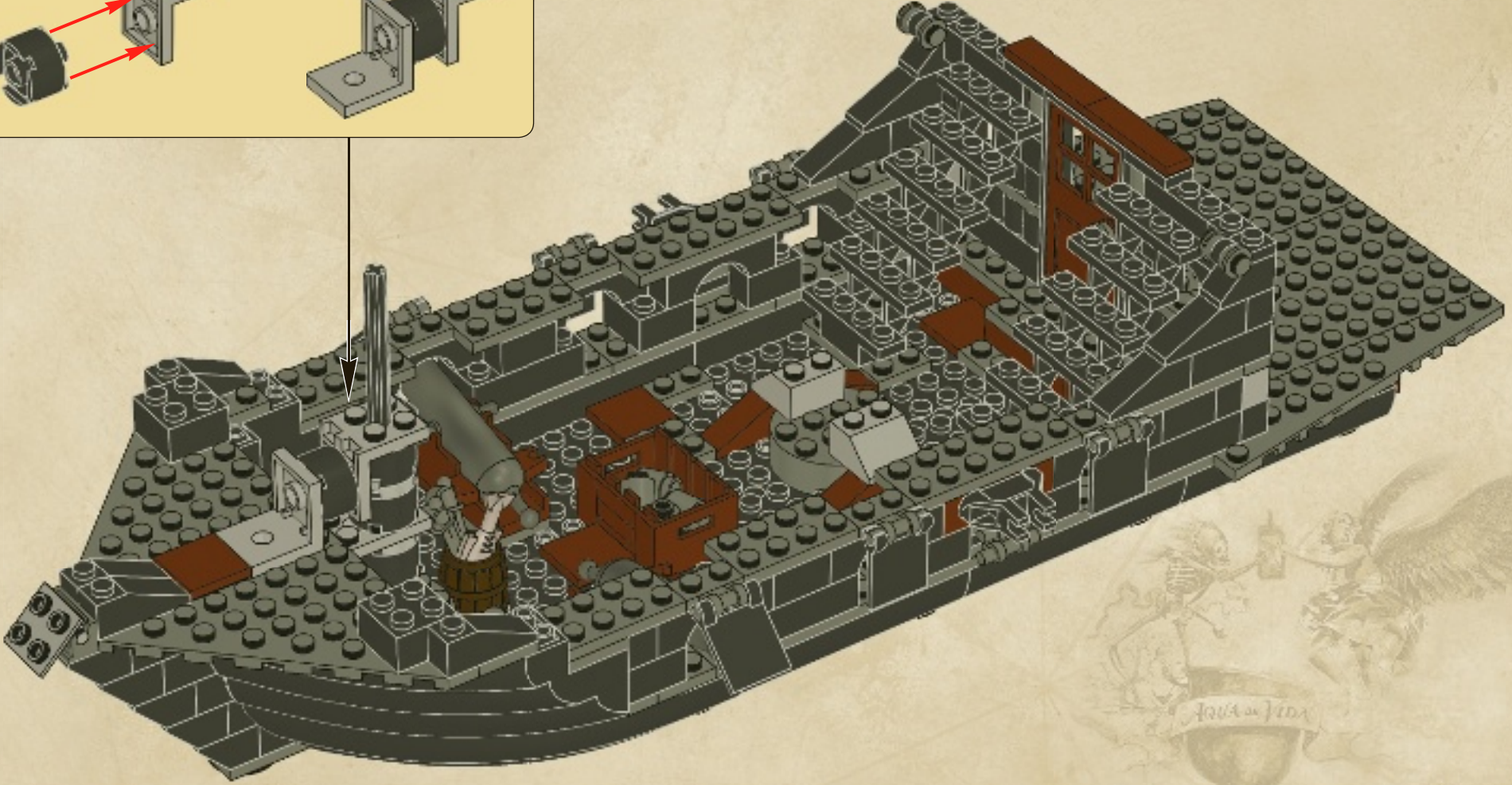
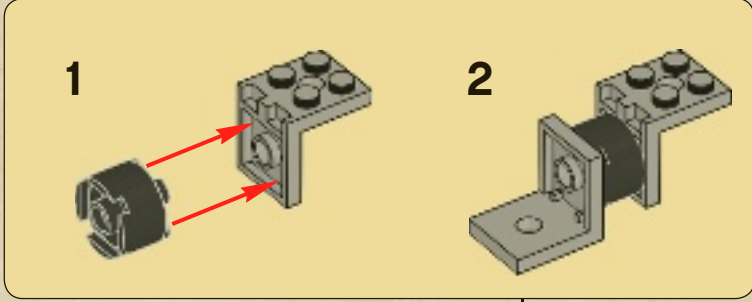

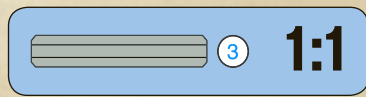
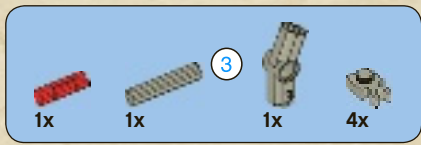

49

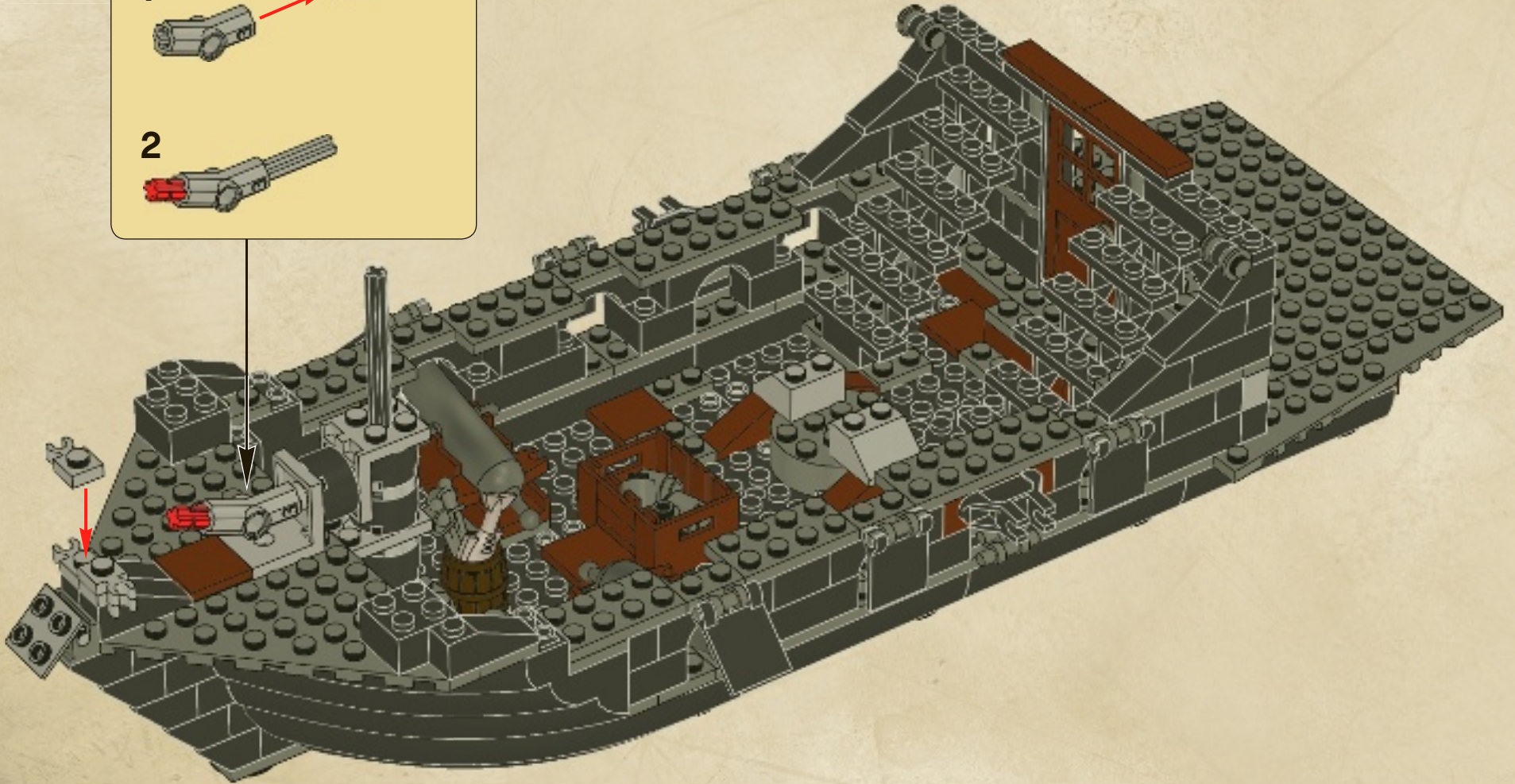
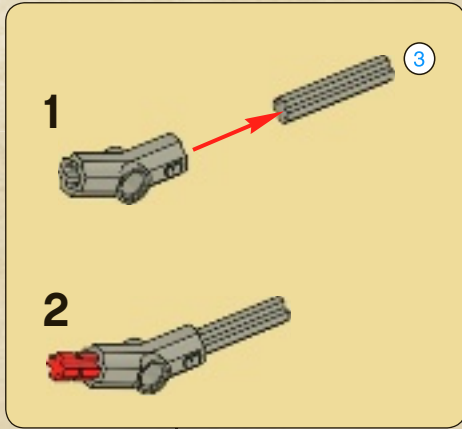

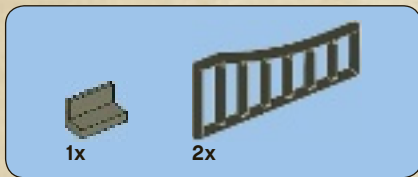

50

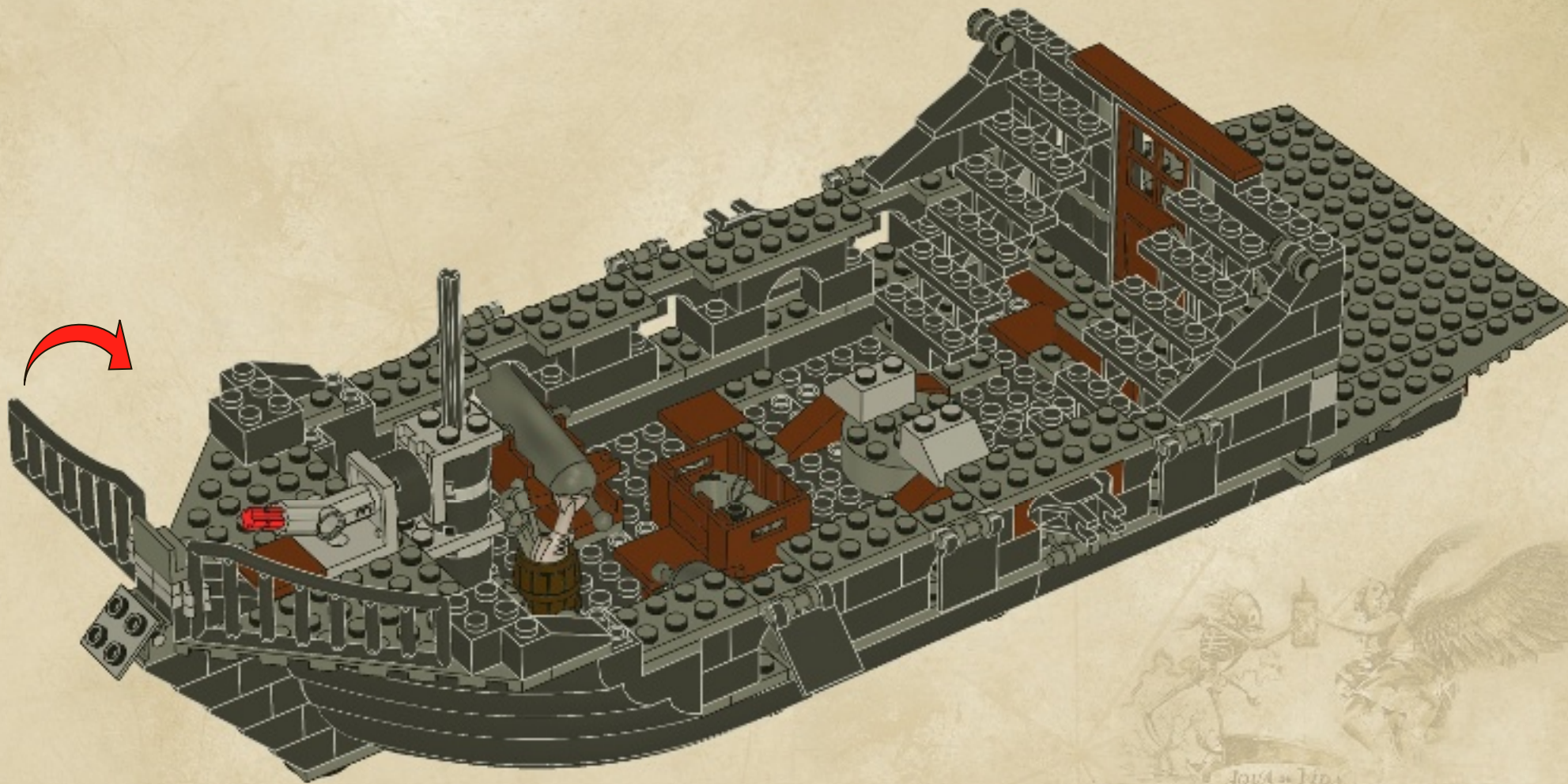

4x

4x

51

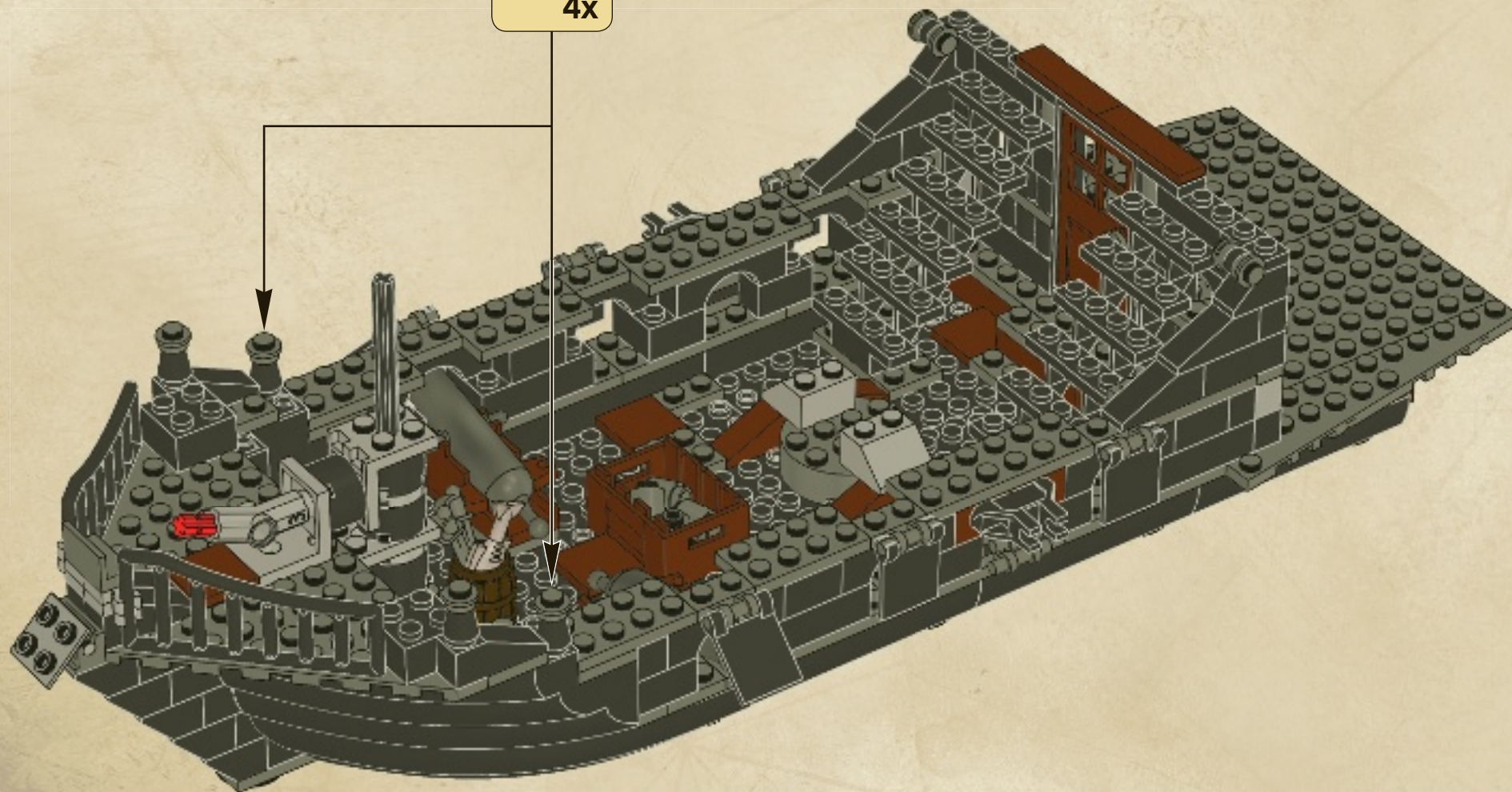
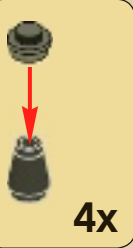

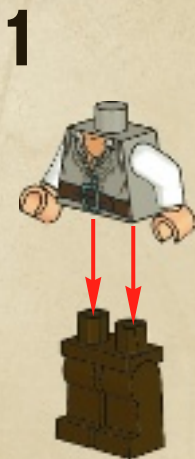
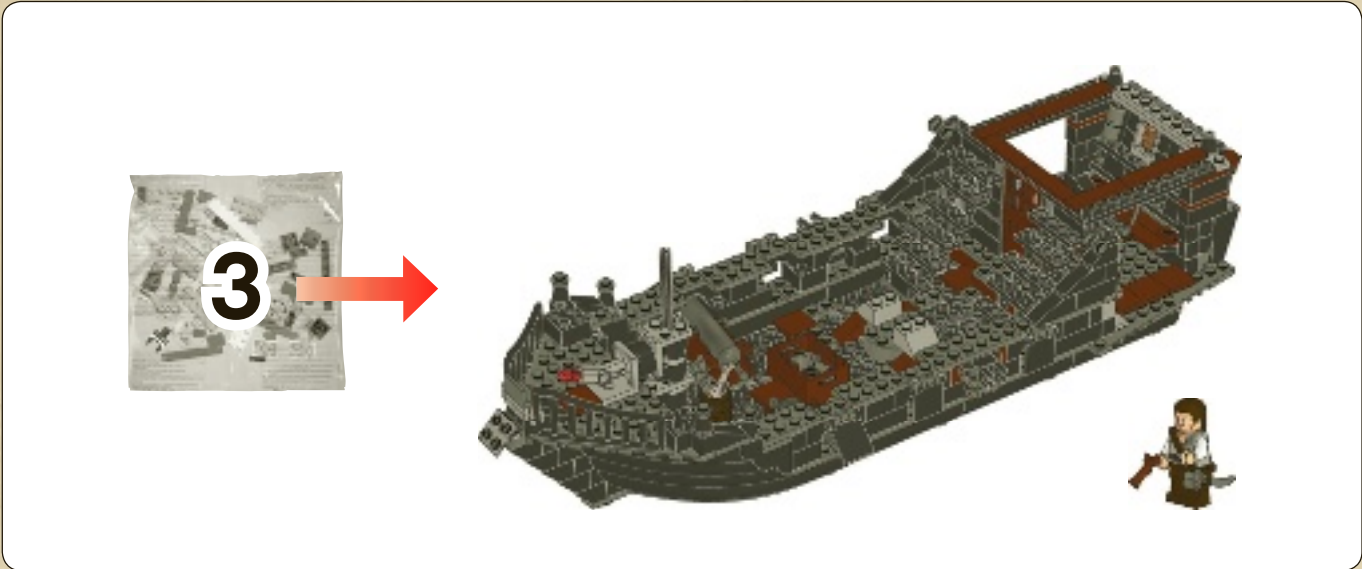



52

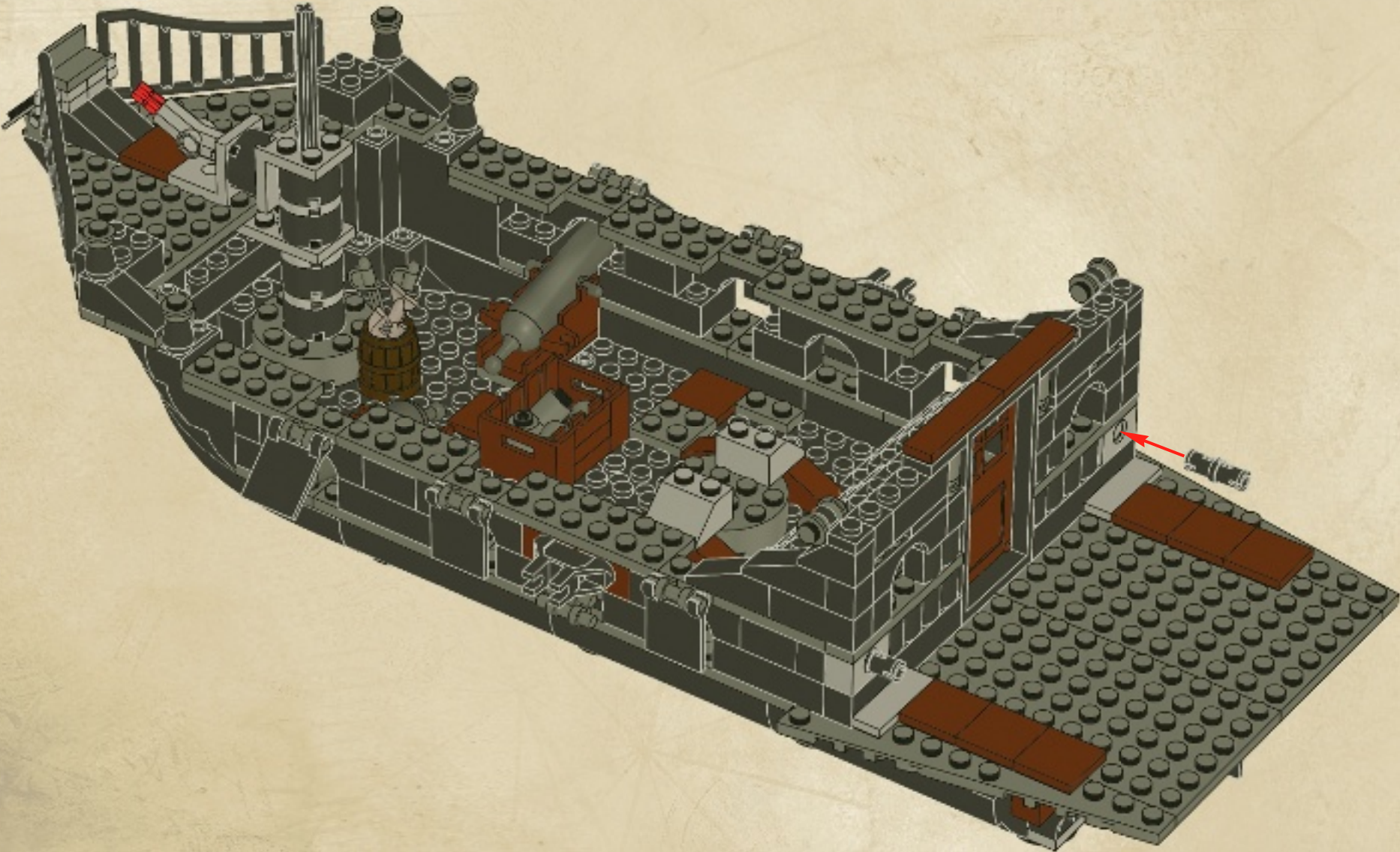

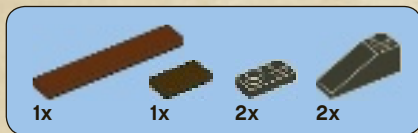

53

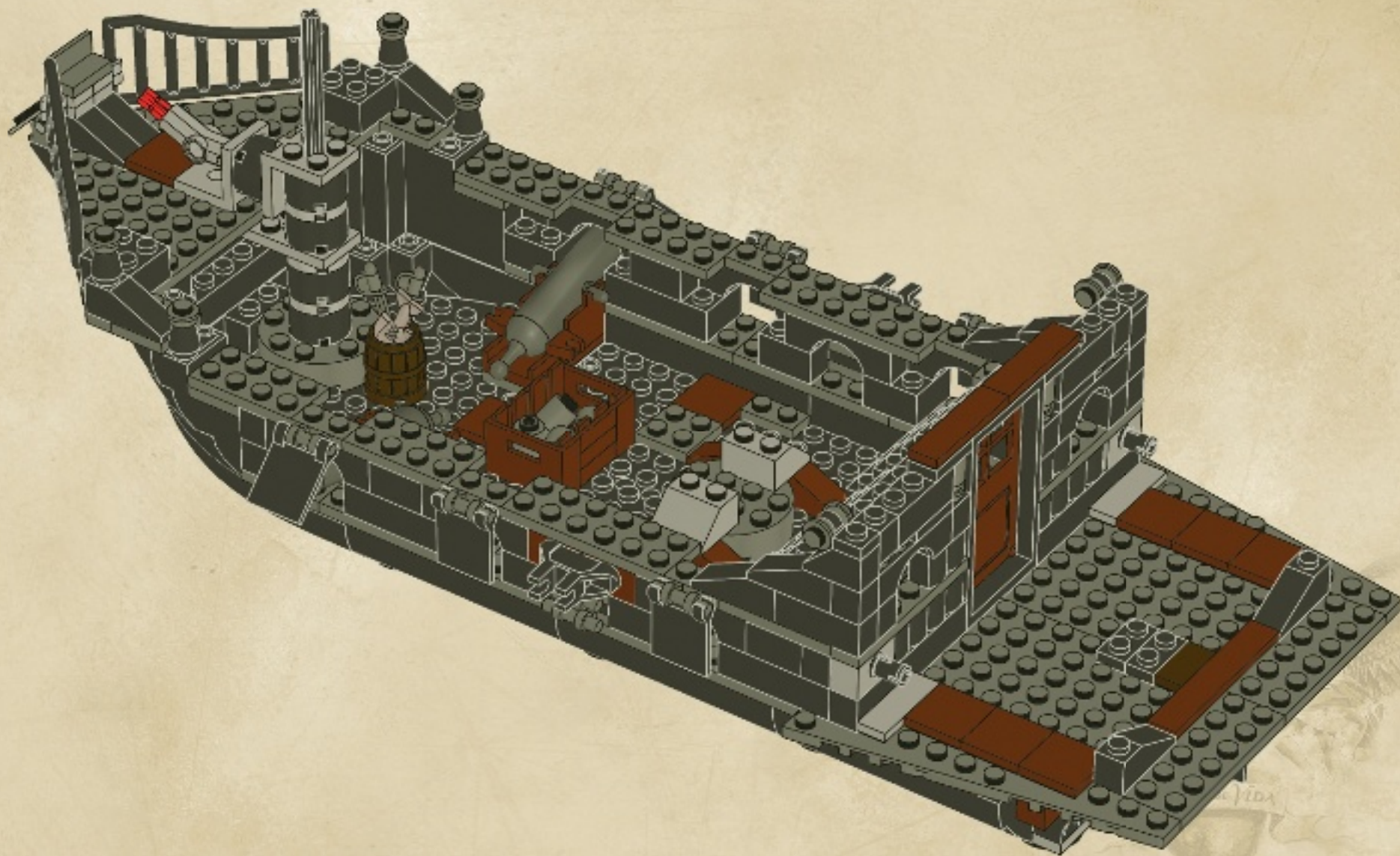

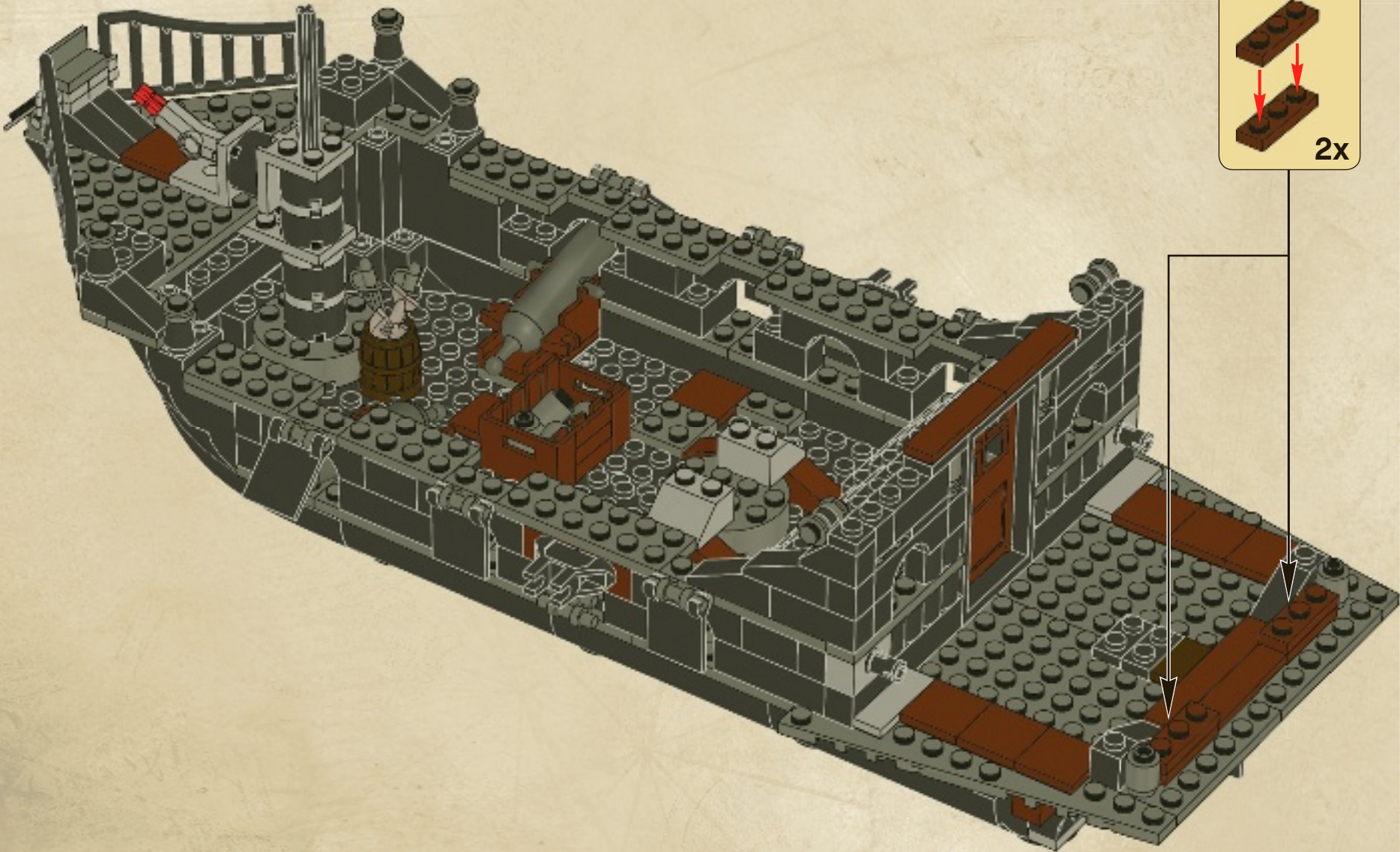

2x 4x 1x

54



2x

2x  3x 

55

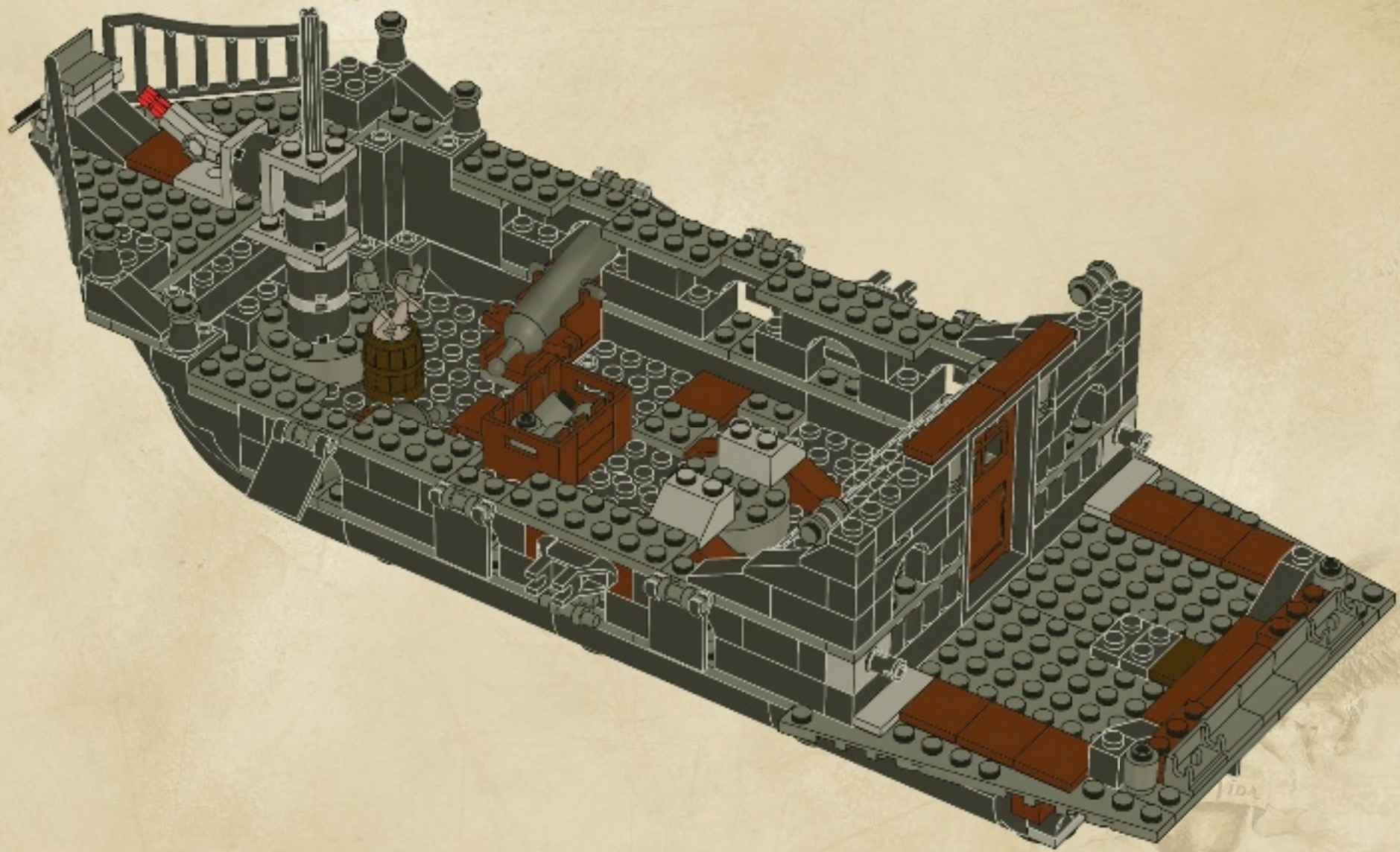

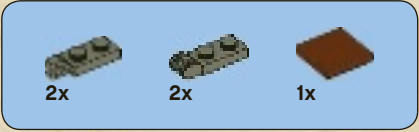

56

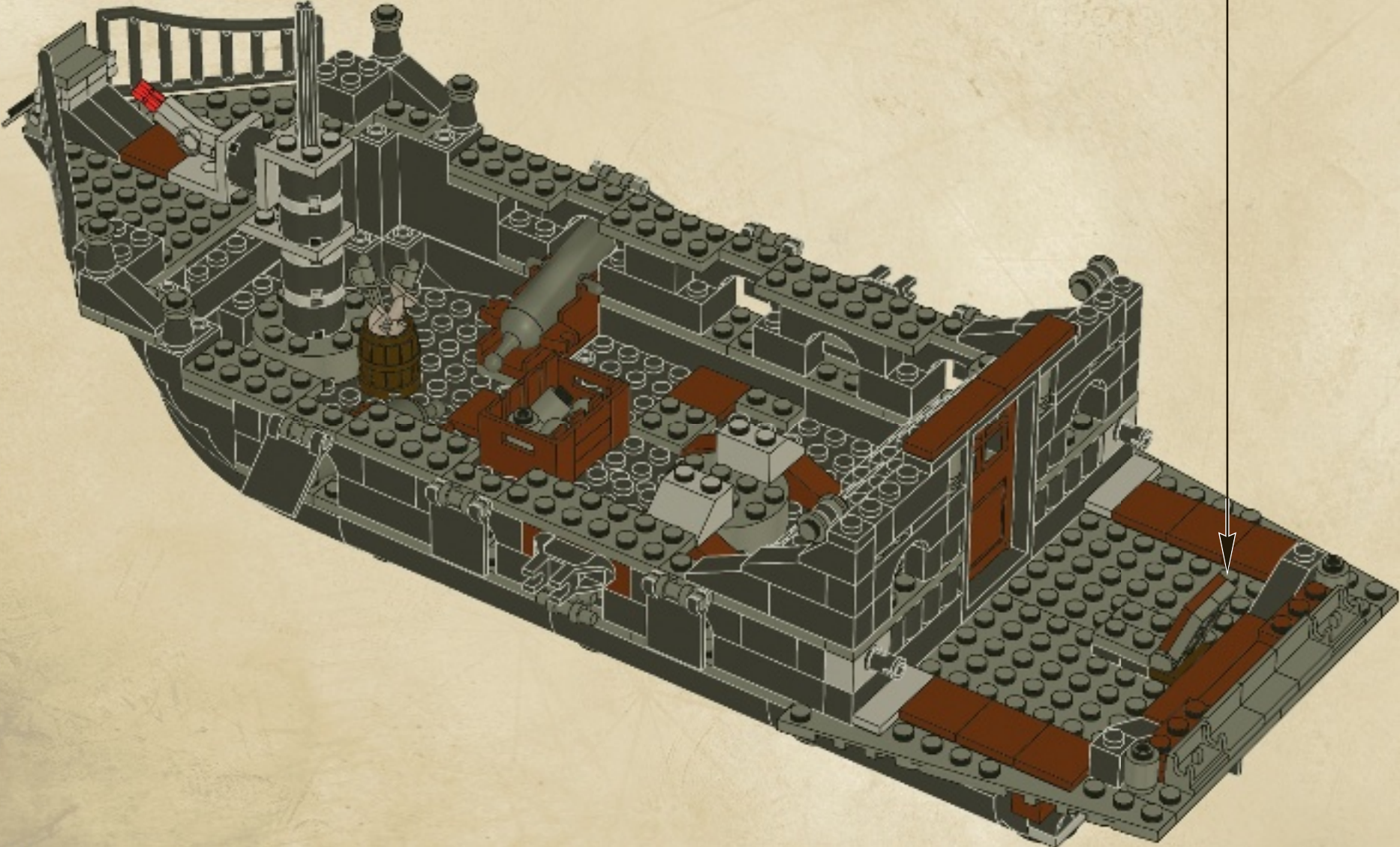
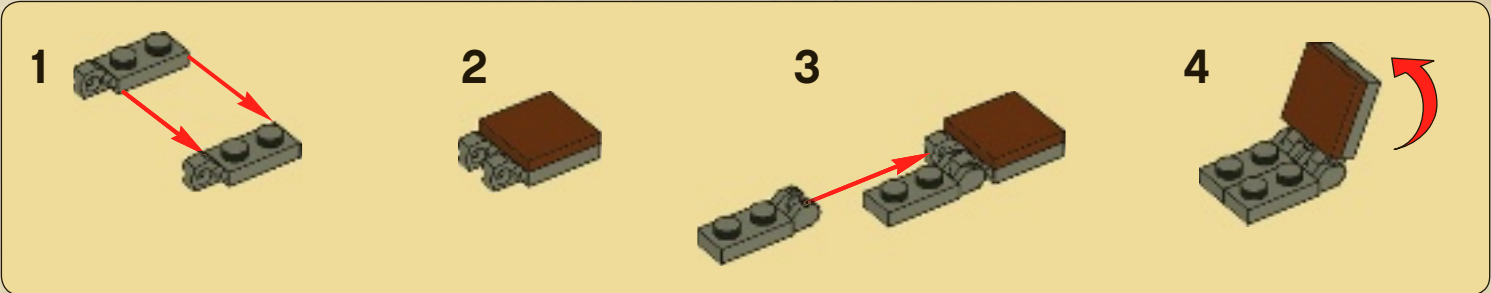



57

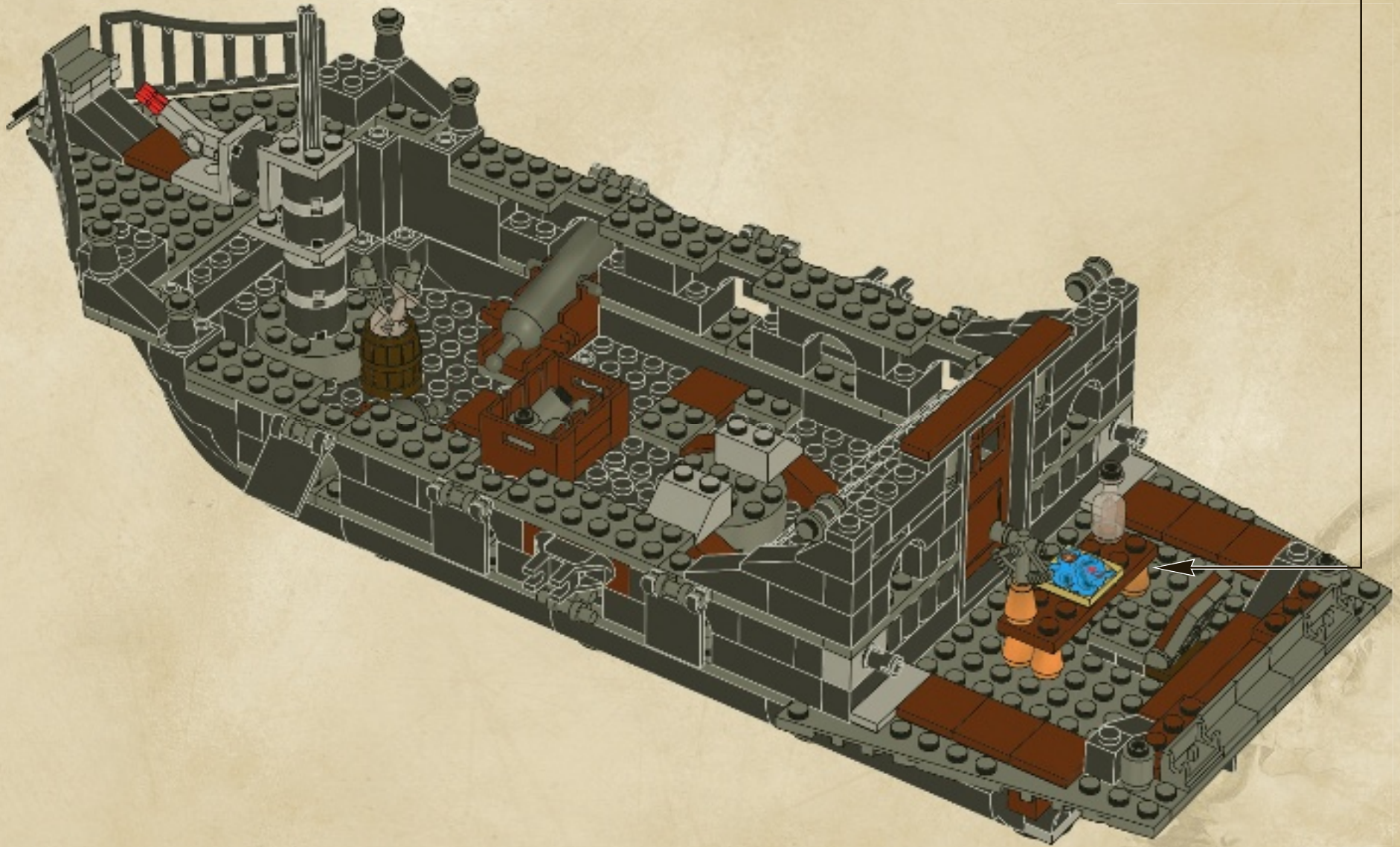
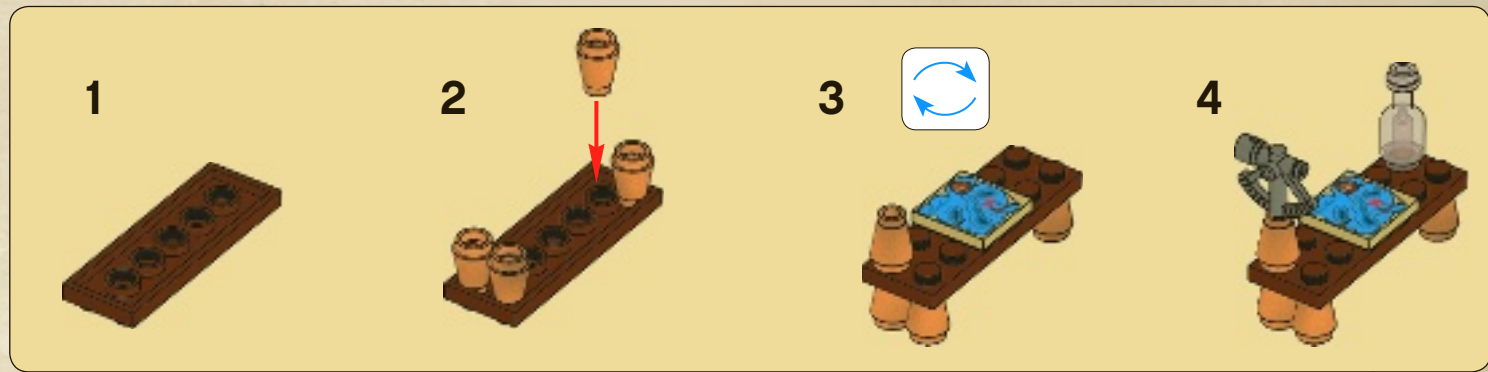

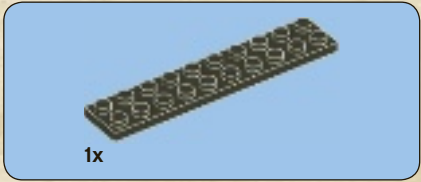

1x

1

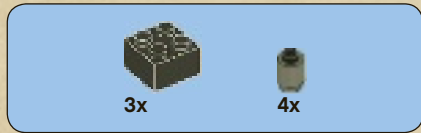

3x

4x

2

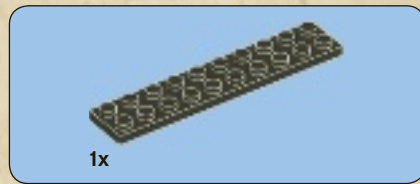
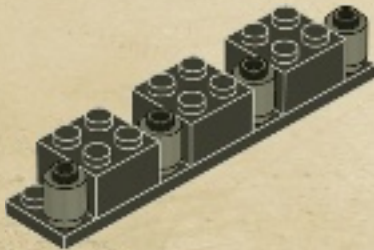

1x

3

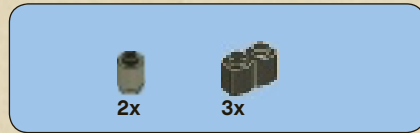
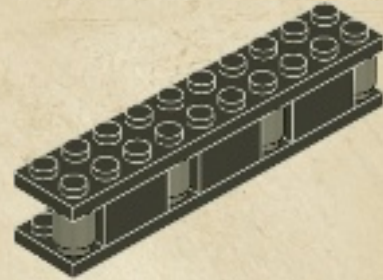

2x

3x

4

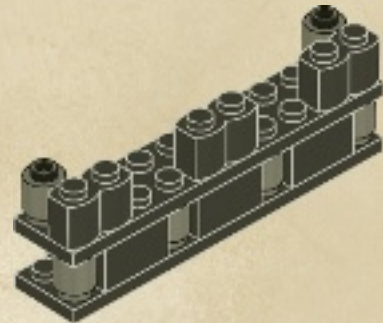

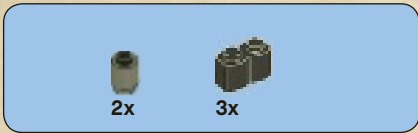

5

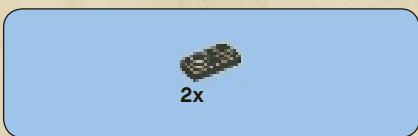
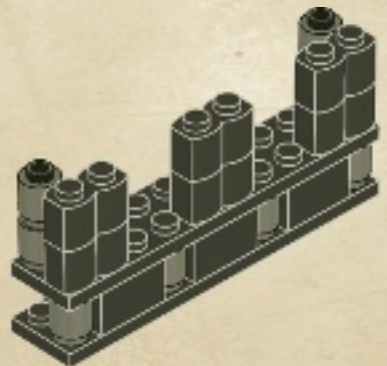

6

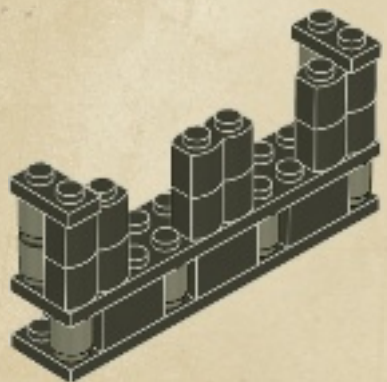

7

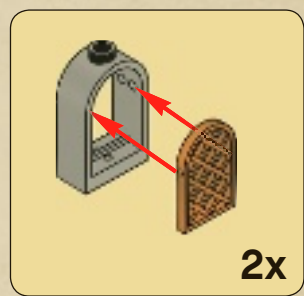

2x

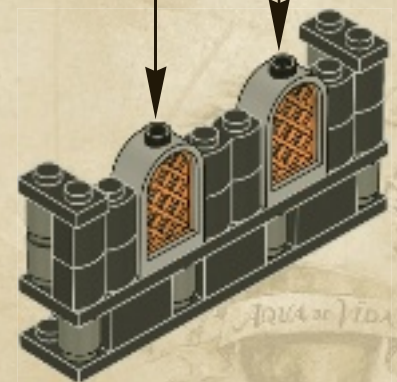

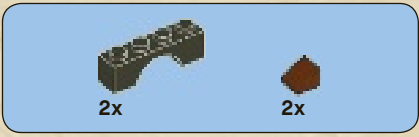

8

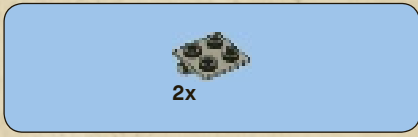

9

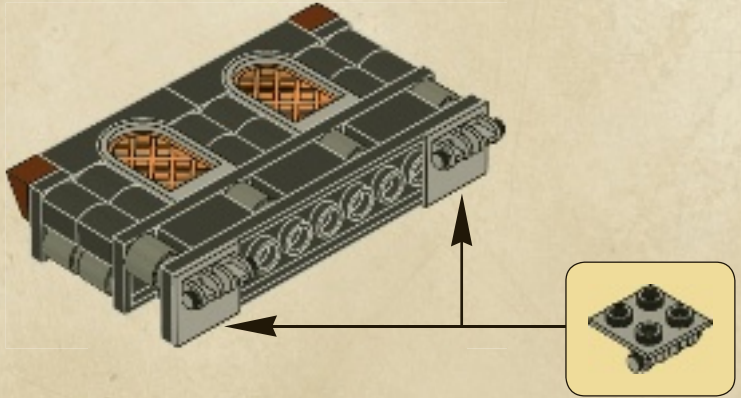

58

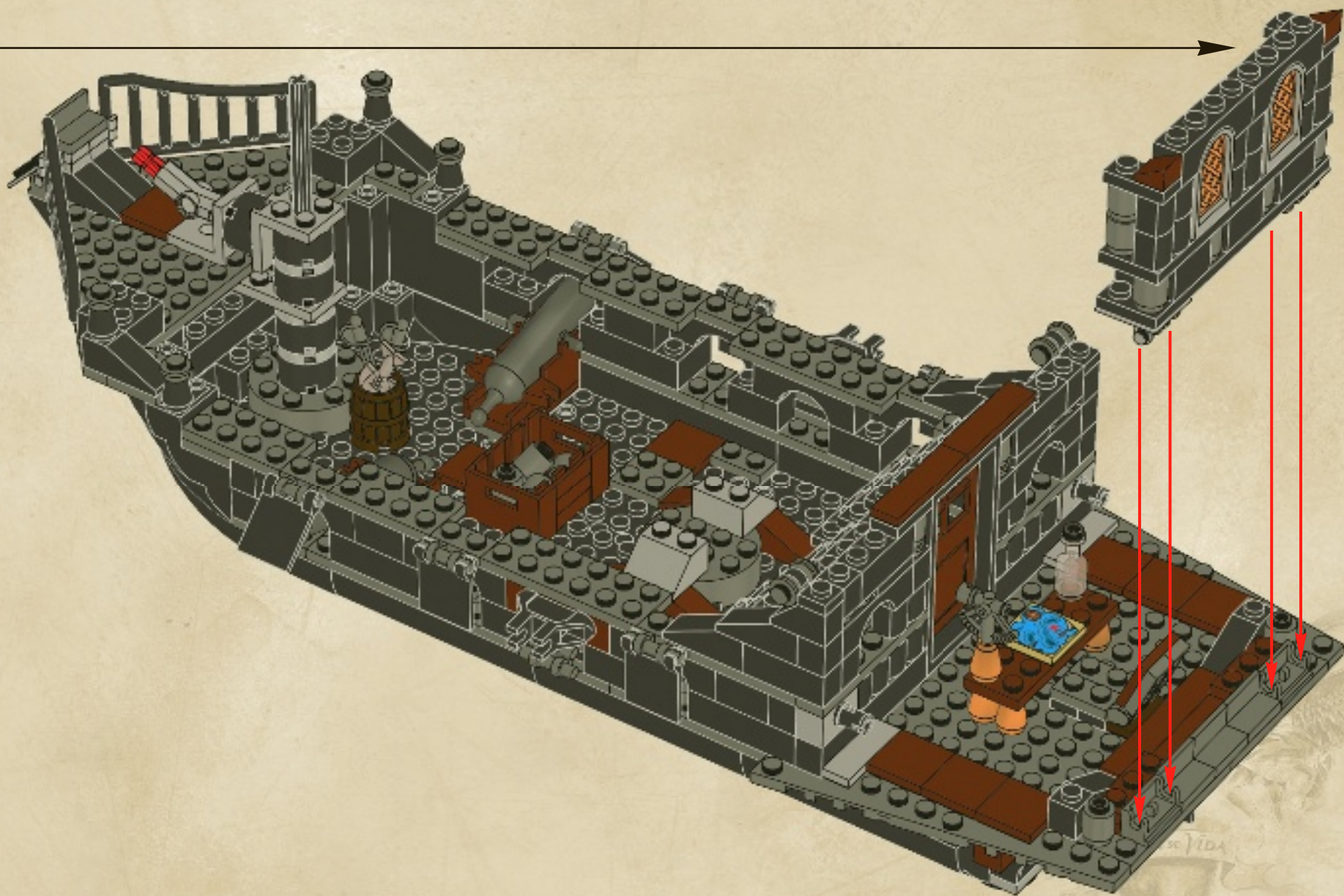

59

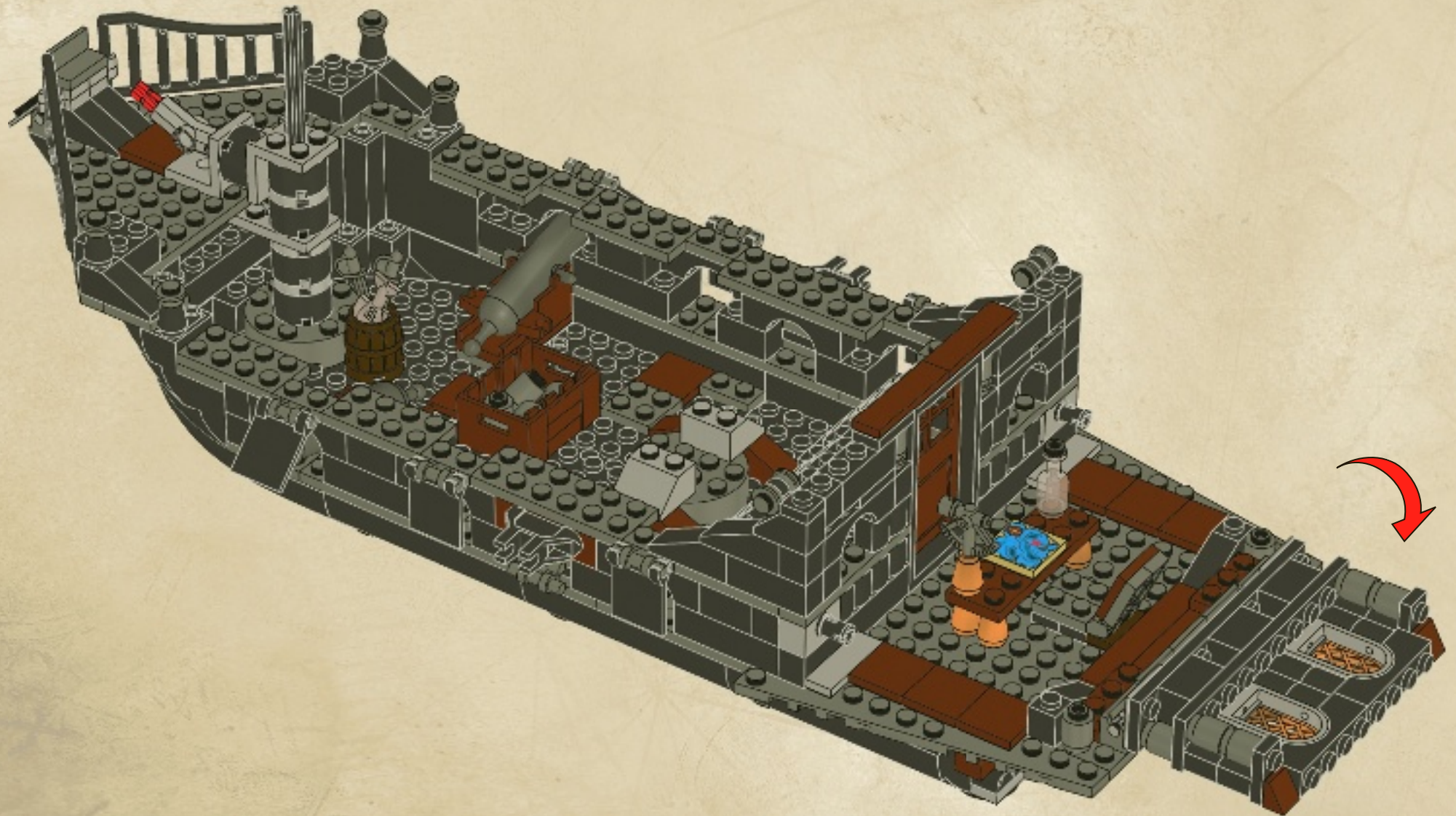

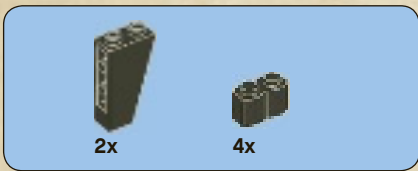

60

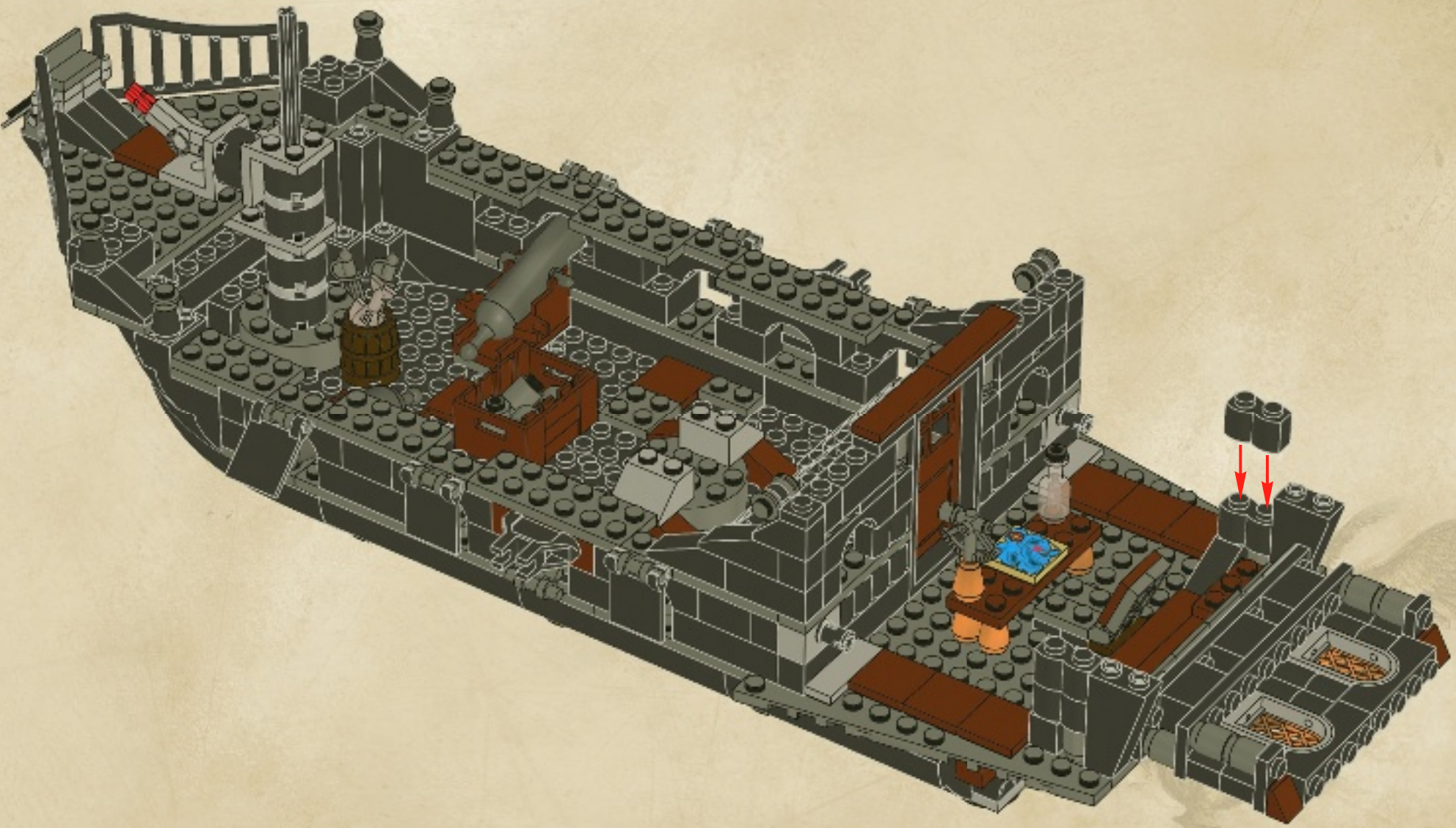



61

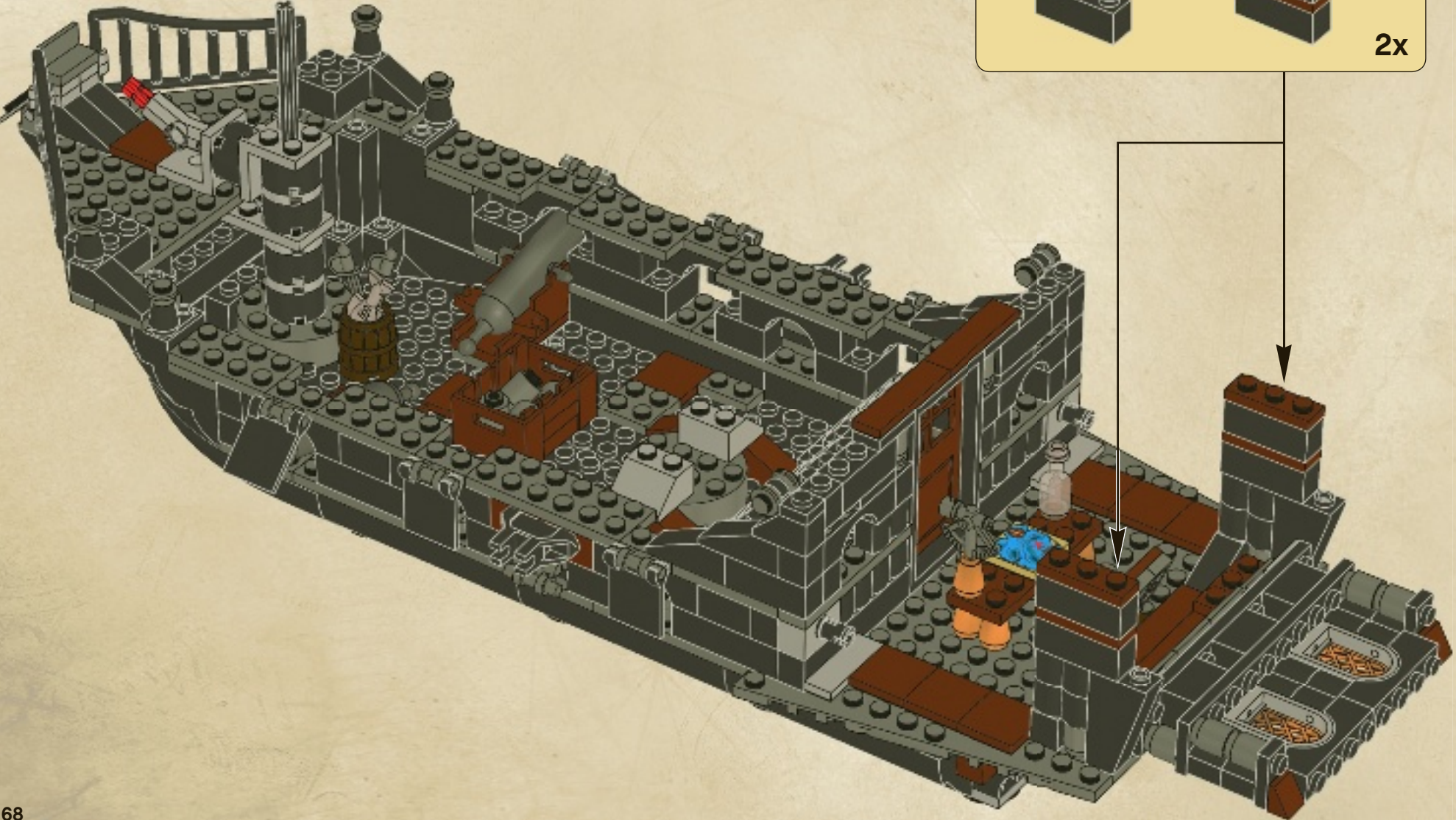
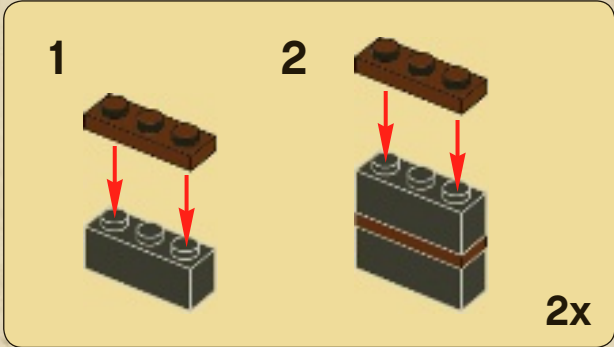

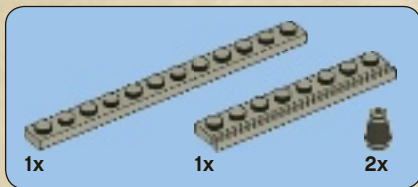

62

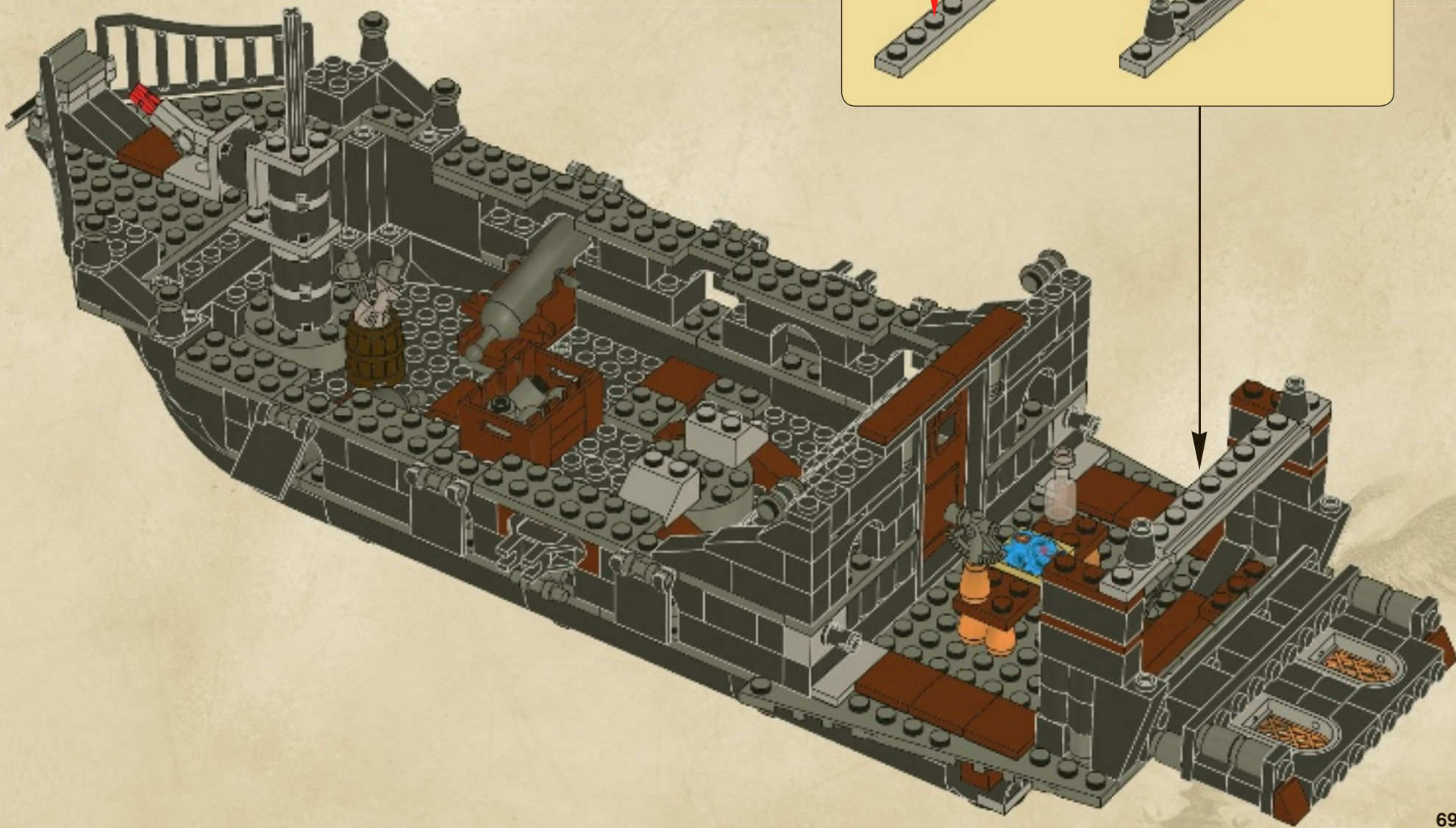
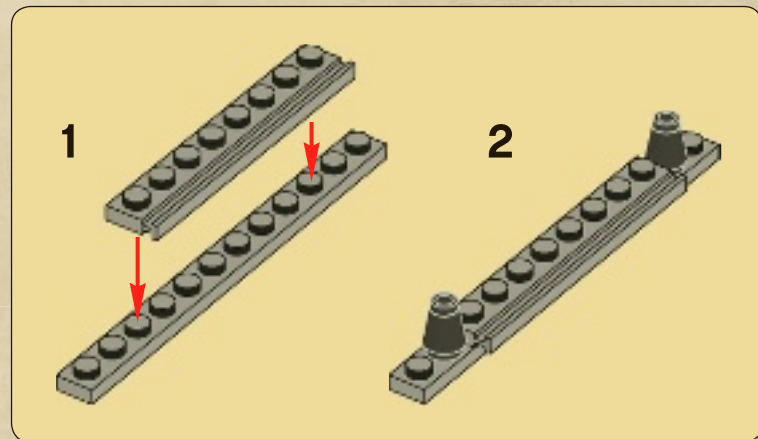

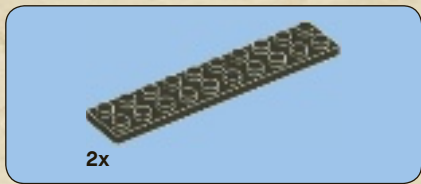

63

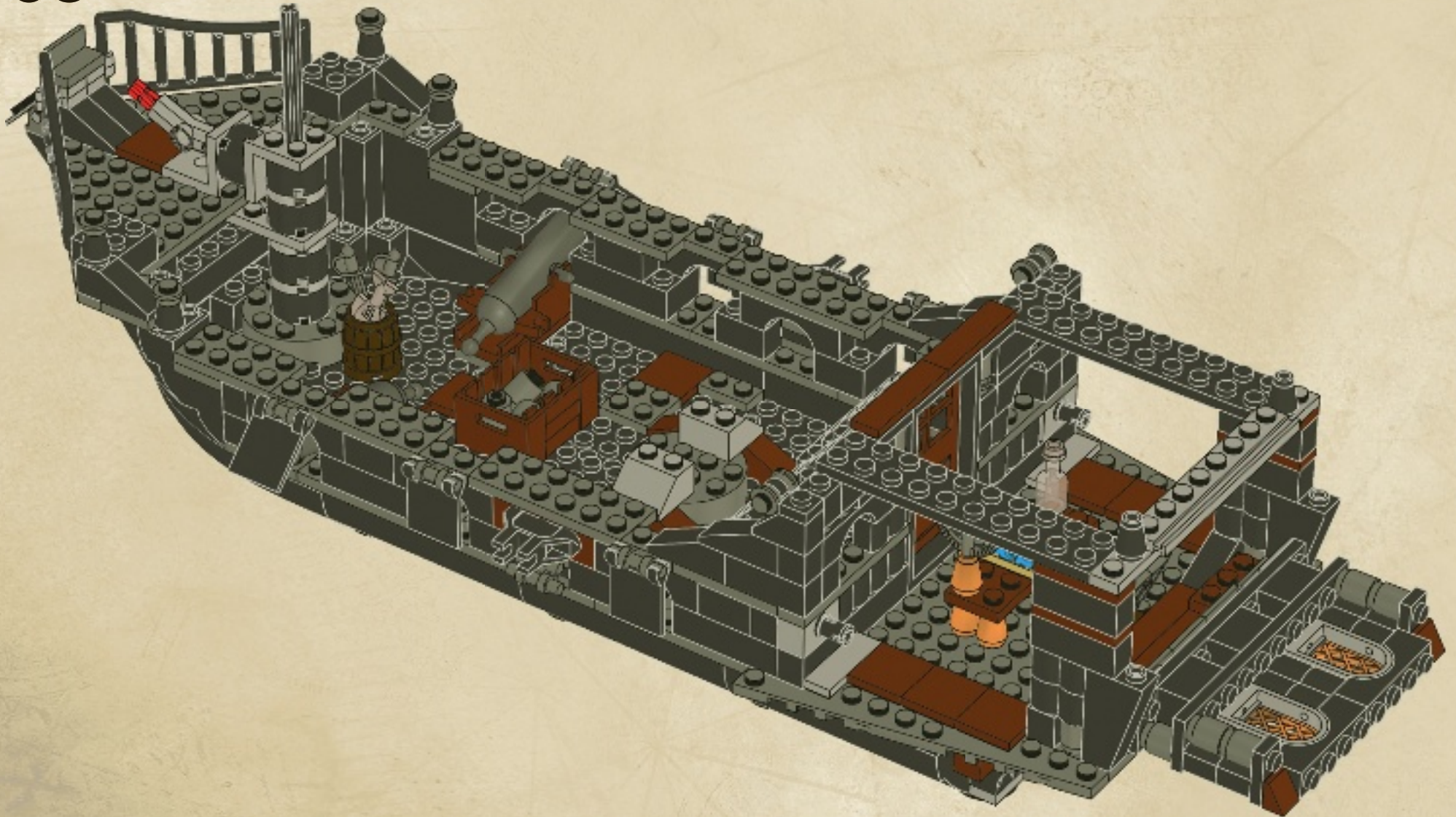

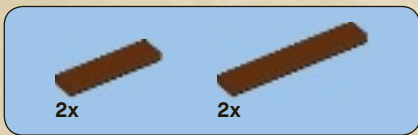

64

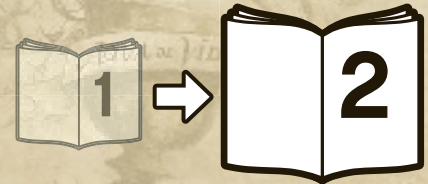
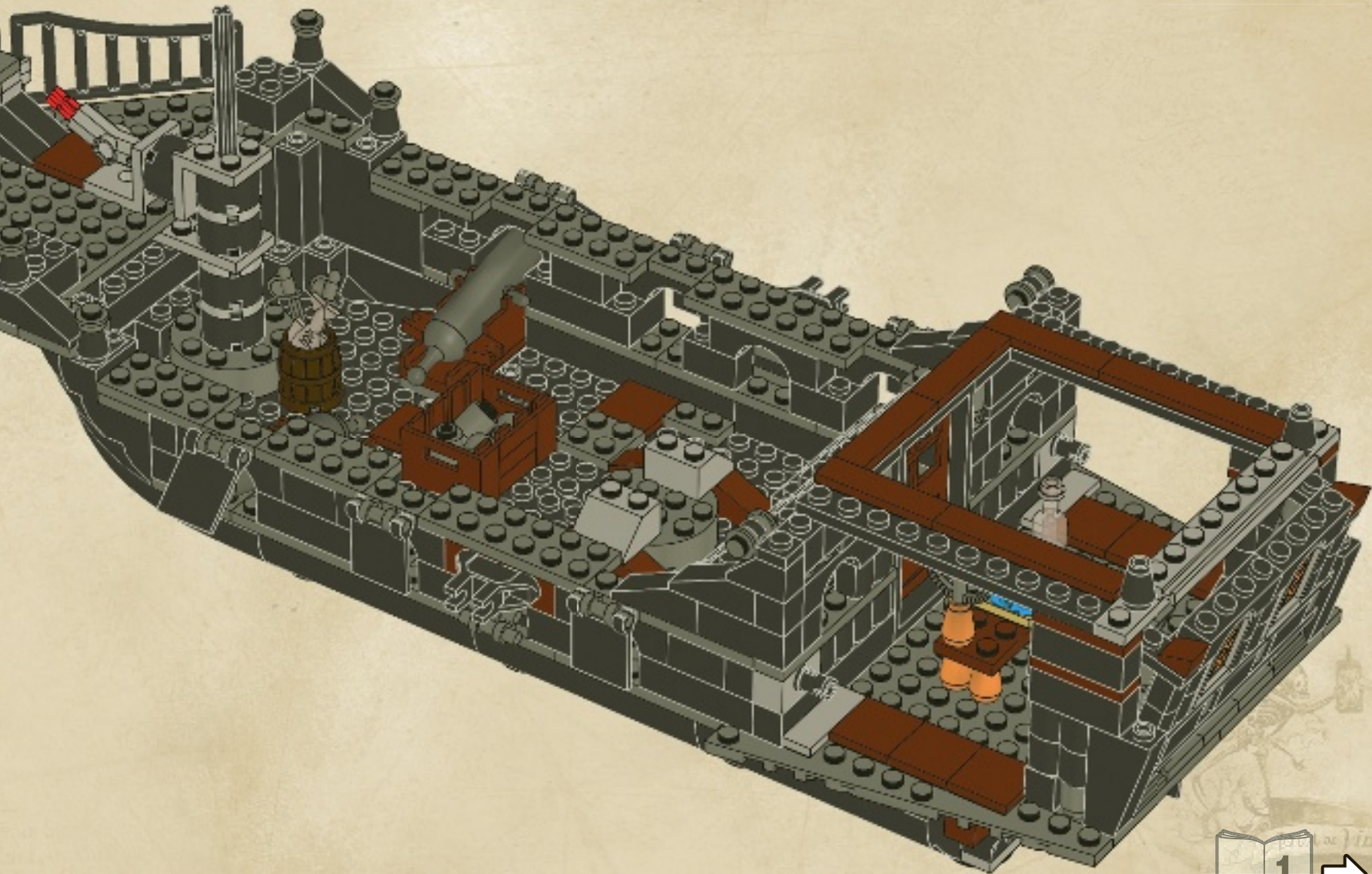



WIN!

Go to www.LEGOsurvey.com/product to fill out a survey for a chance to win a cool LEGO® Product. No purchase necessary. Open to all residents where not prohibited.



www.LEGO.com



www.LEGOsurvey.com/product

GEWINNE!

Nimm an der Umfrage auf www.LEGOsurvey.com/product teil und hab die Chance ein cooles LEGO® Produkt zu gewinnen! Die Teilnahme am Gewinnspiel führt zu keinerlei Kaufverpflichtungen. Teilnahme in allen nicht ausgeschlossenen Ländern möglich.

WIN!

Ga naar www.LEGOsurvey.com/product, vul een enquêteformulier in en maak kans op een cool LEGO® product. Geen aankoopverplichting. Iedereen mag deelnemen, uitgezonderd ingezetenden van landen waar een enquêteverbod geldt.

GAGNE!

Visite www.LEGOsurvey.com/product pour répondre à un questionnaire et avoir une chance de gagner un produit LEGO® très cool ! Aucune obligation d'achat. Ouvert à tous les résidents des pays autorisés.

当てよう!

www.LEGOsurvey.com/product にアクセスして、アンケートにご記入ください。当選者にはレゴ製品を差し上げます。お買い上げの必要はありません。禁止されていない限り、すべての皆様にご利用いただけます。



PIRATES *of the* CARIBBEAN



4184



1

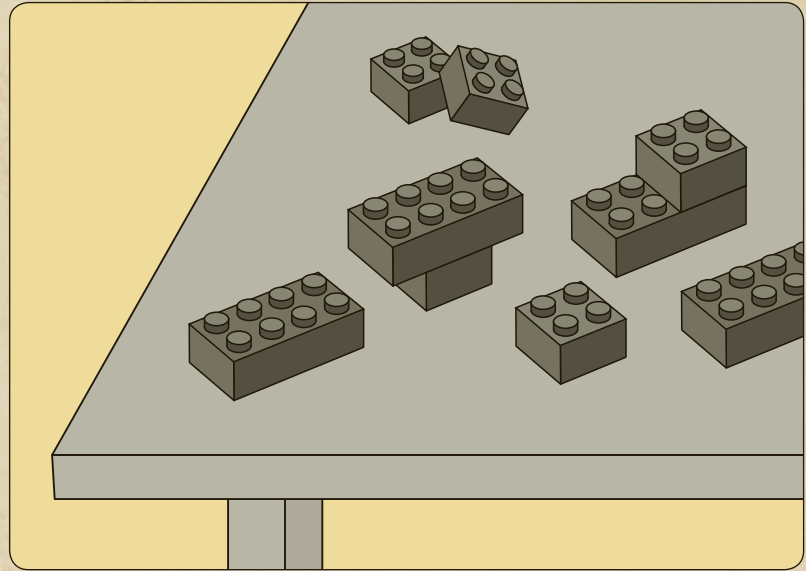
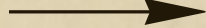
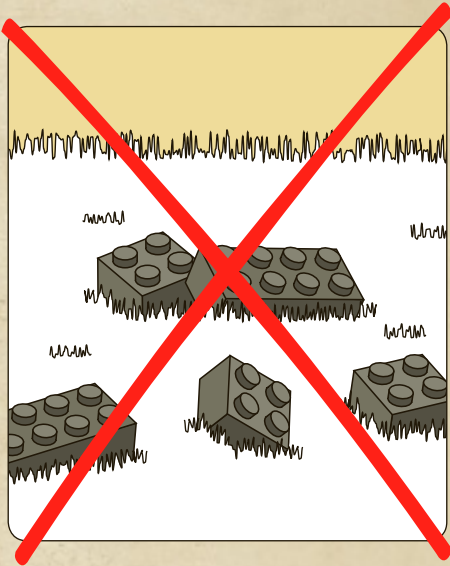

2





+

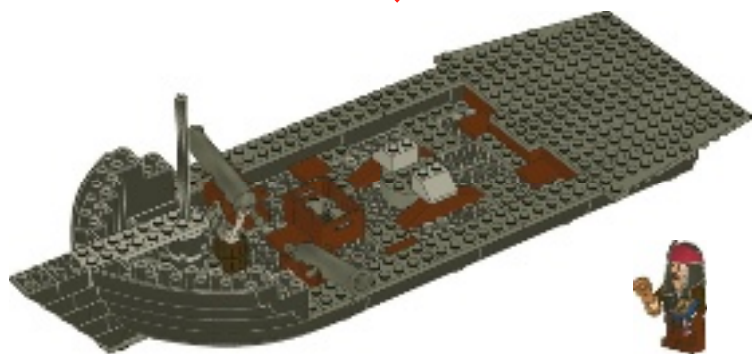

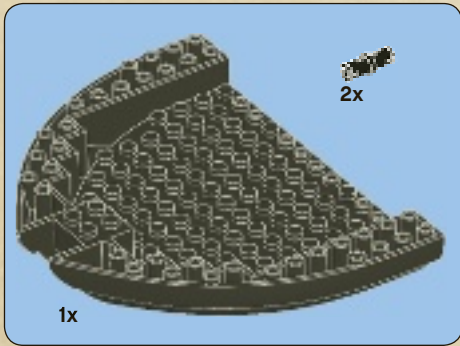
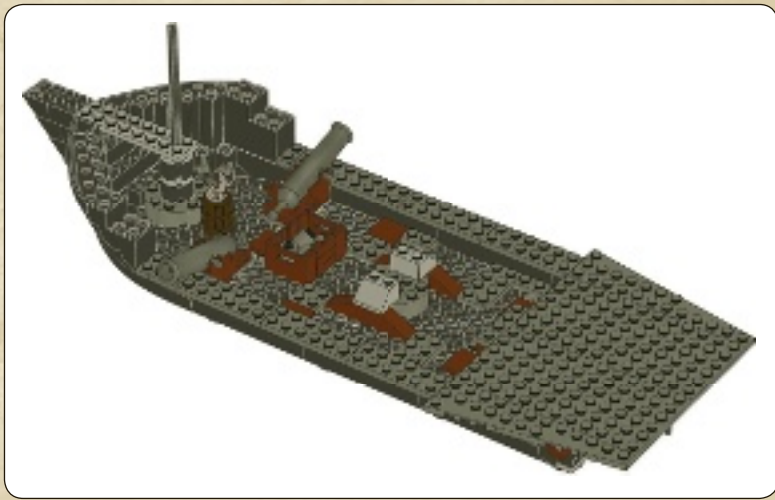

1

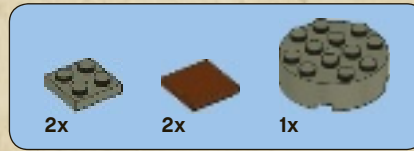
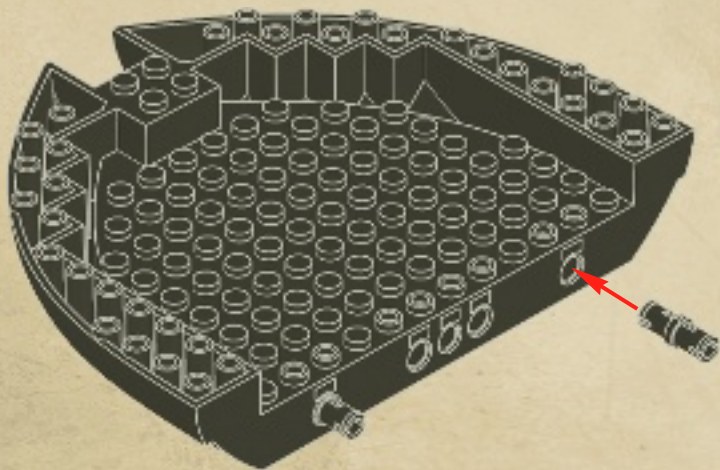

2

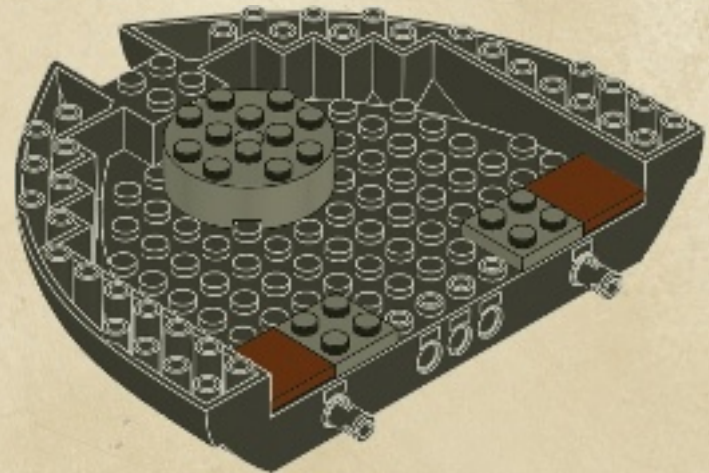

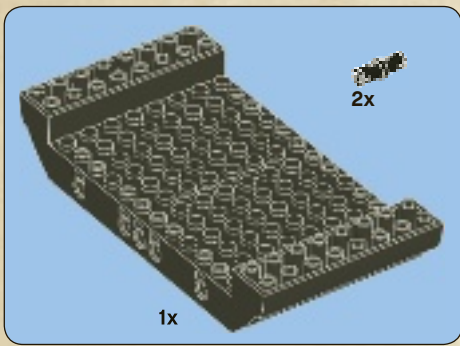

3

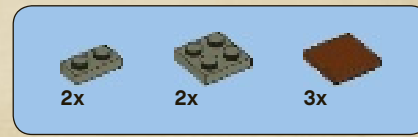
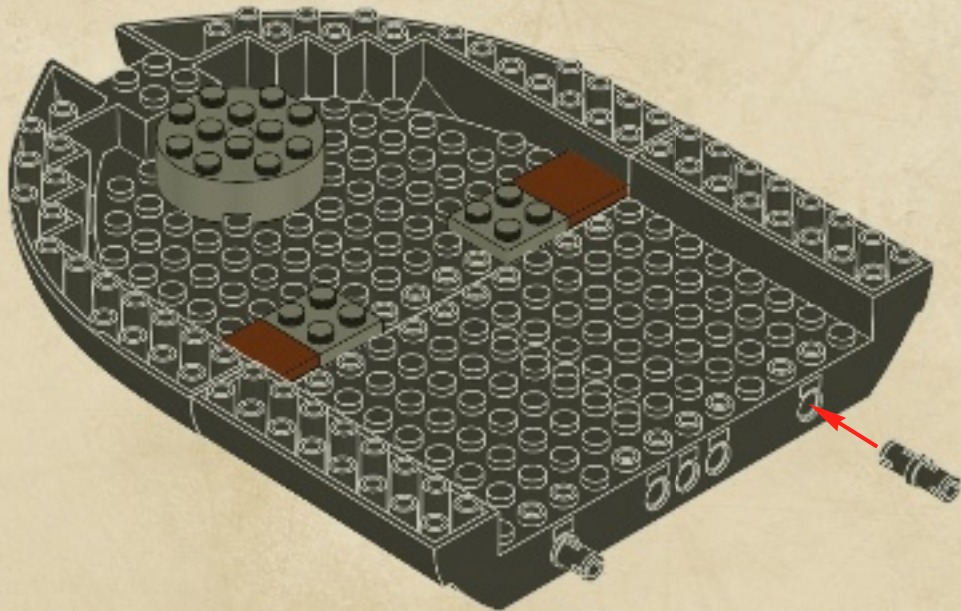

4

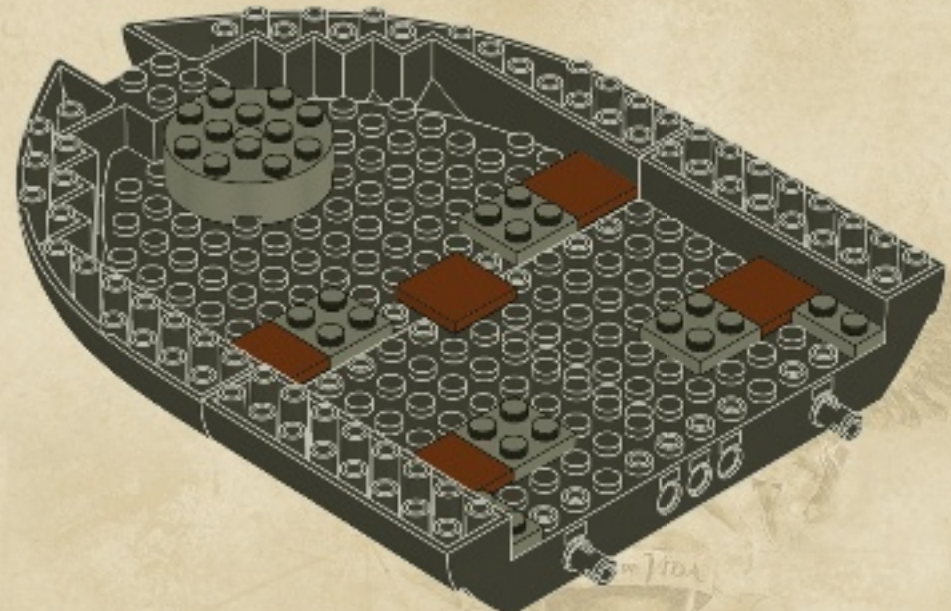

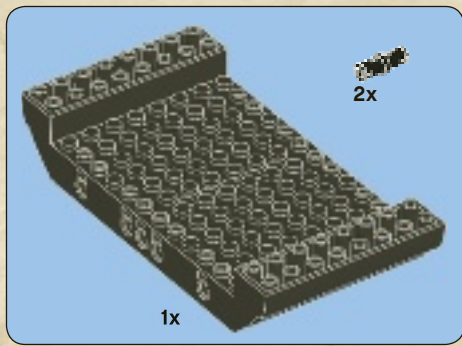

5

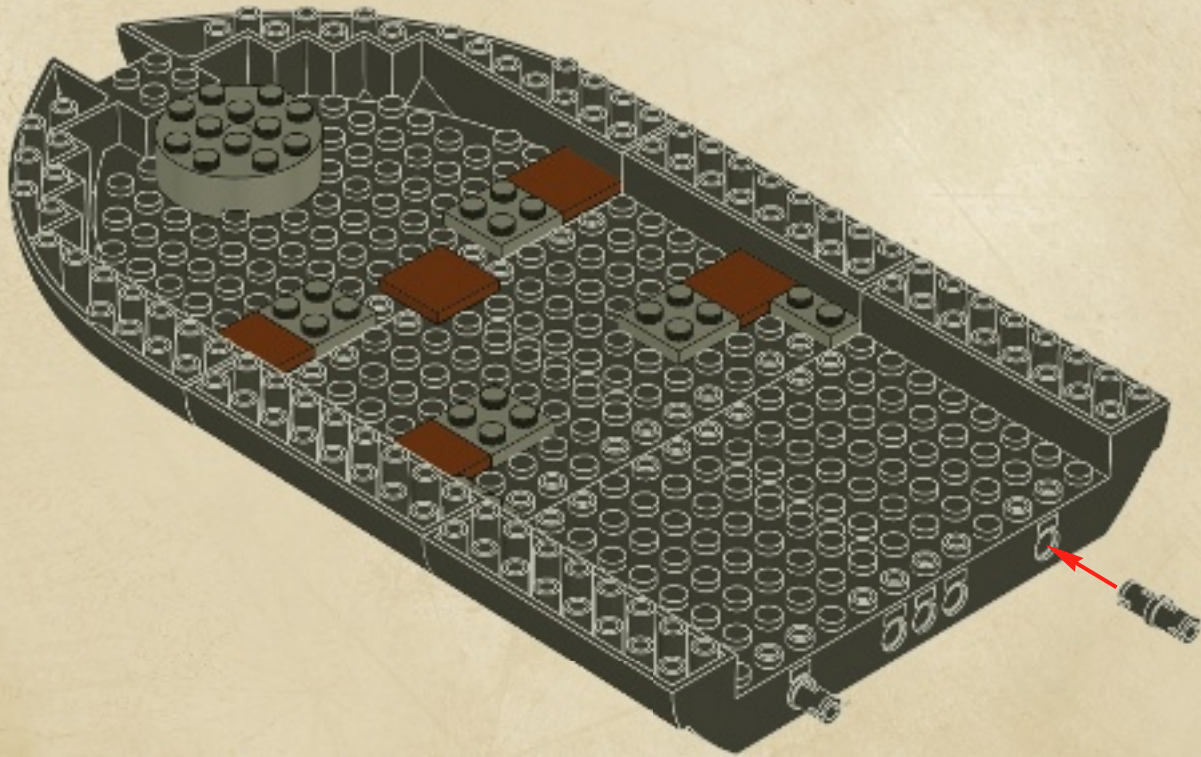

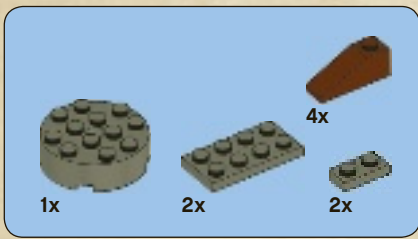

6

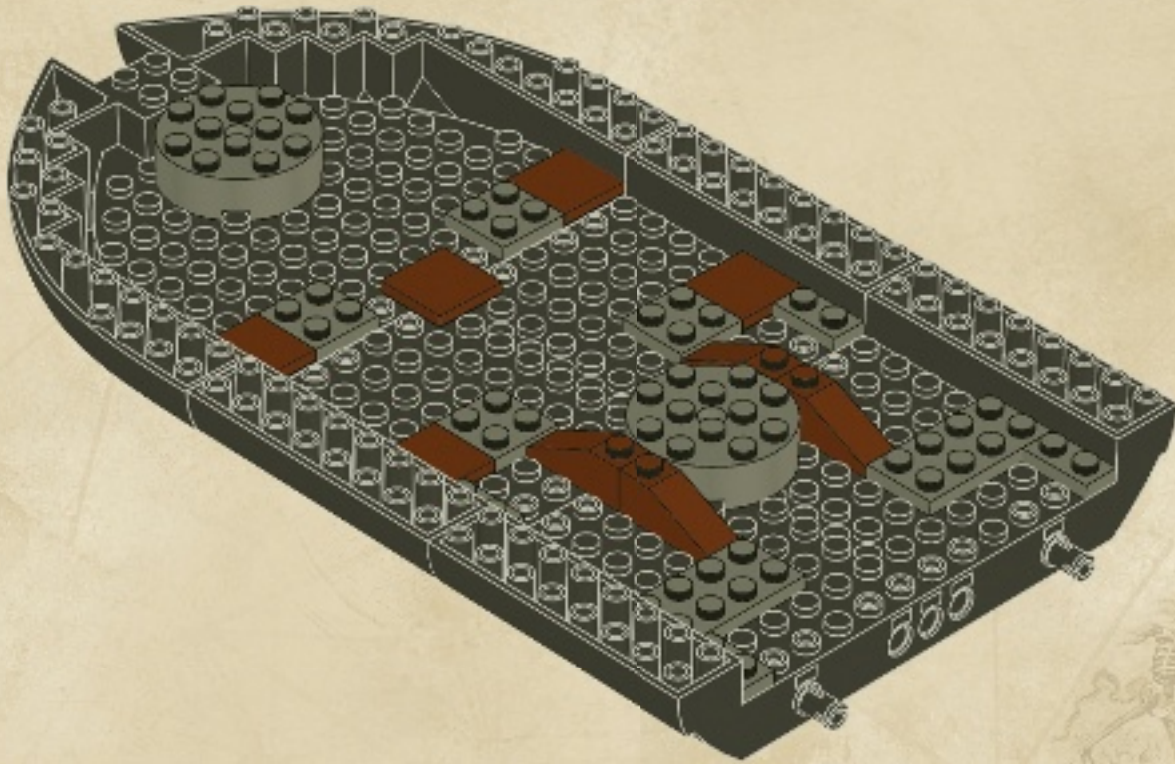

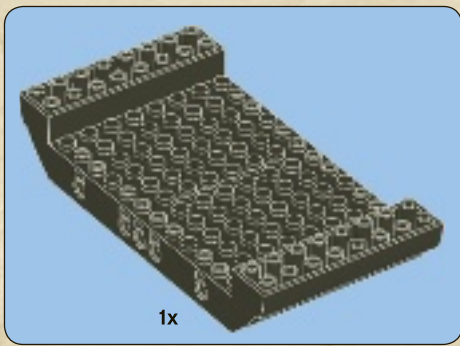

7

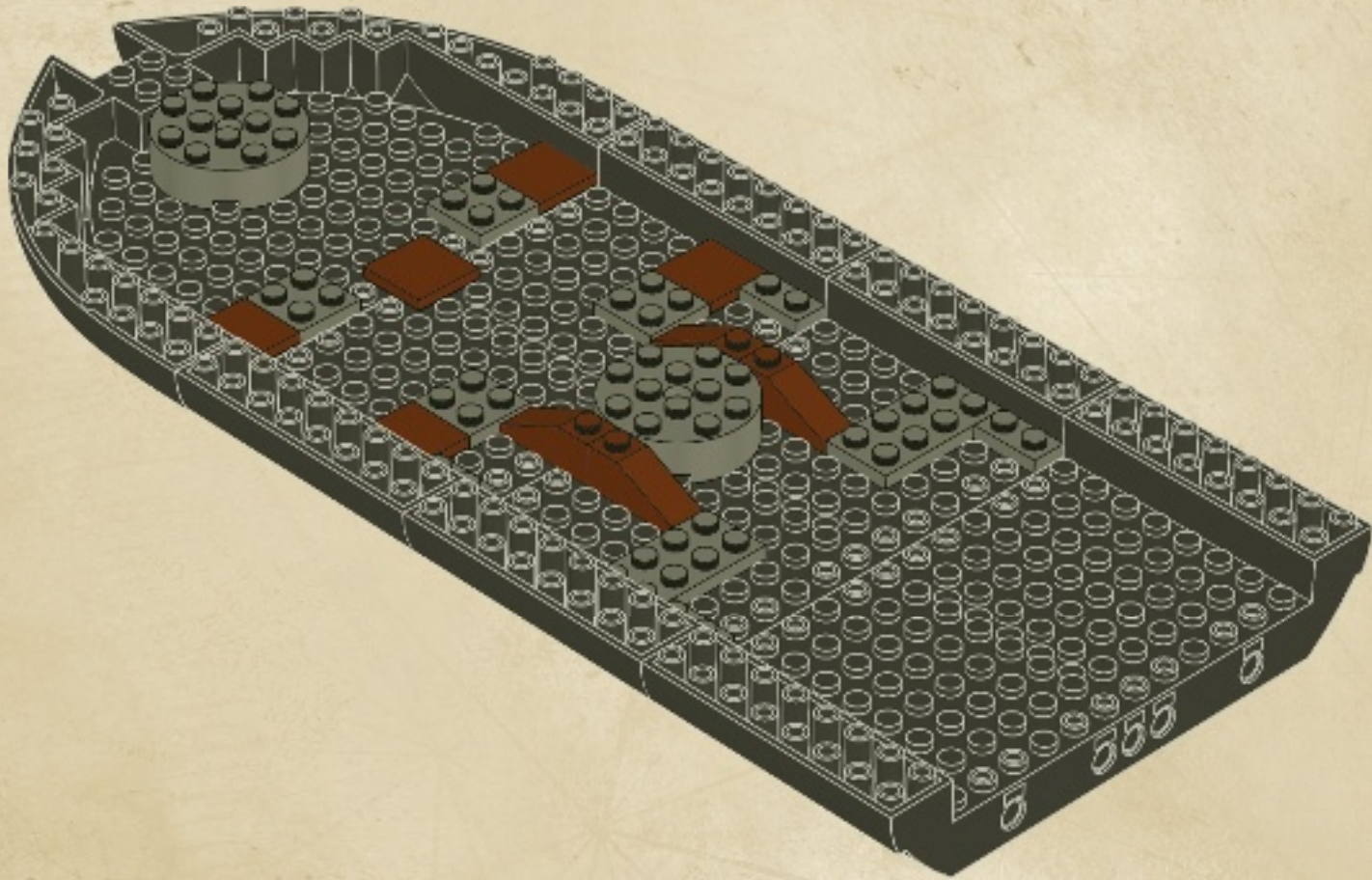



2x

8

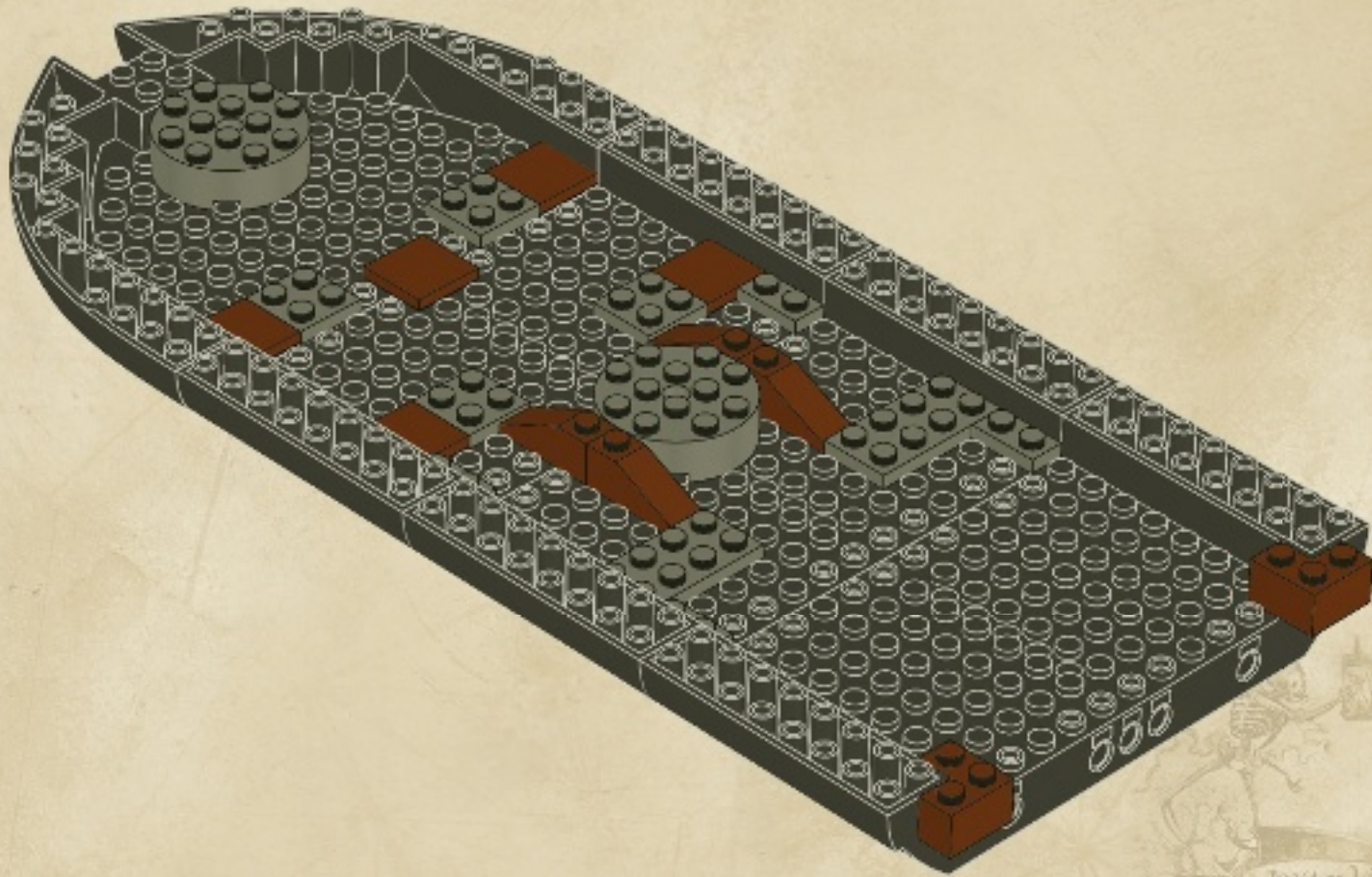

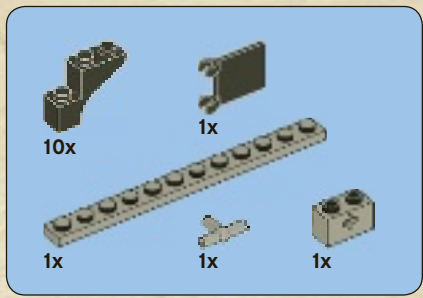

9

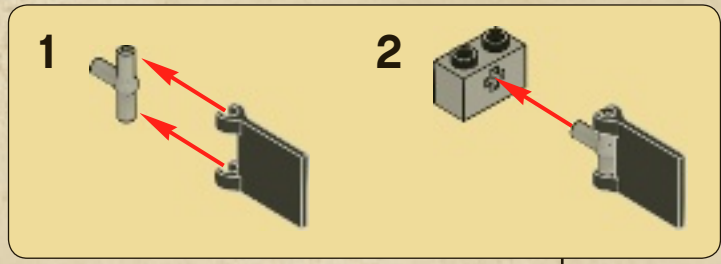
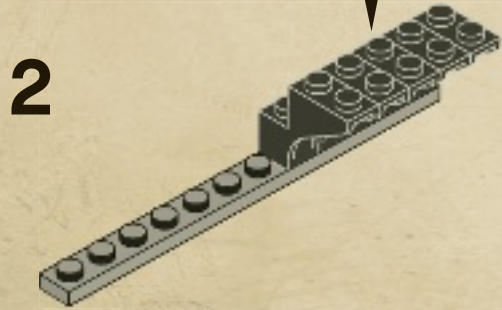
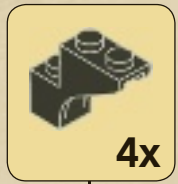
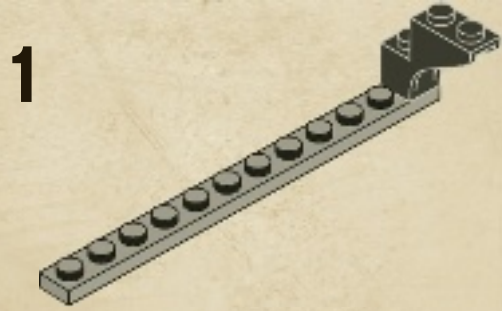

3

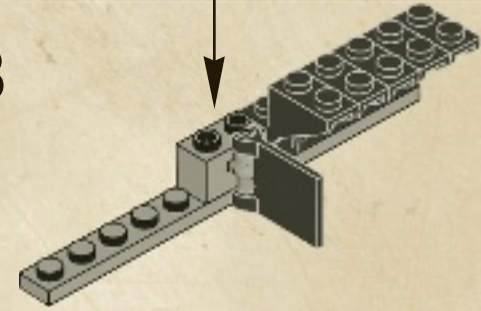

4

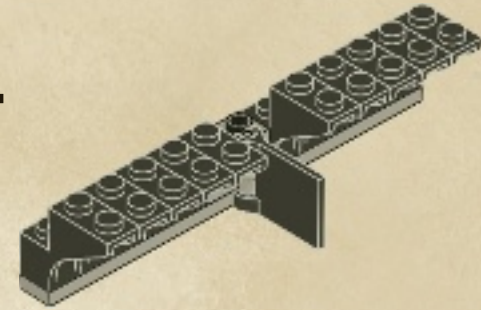

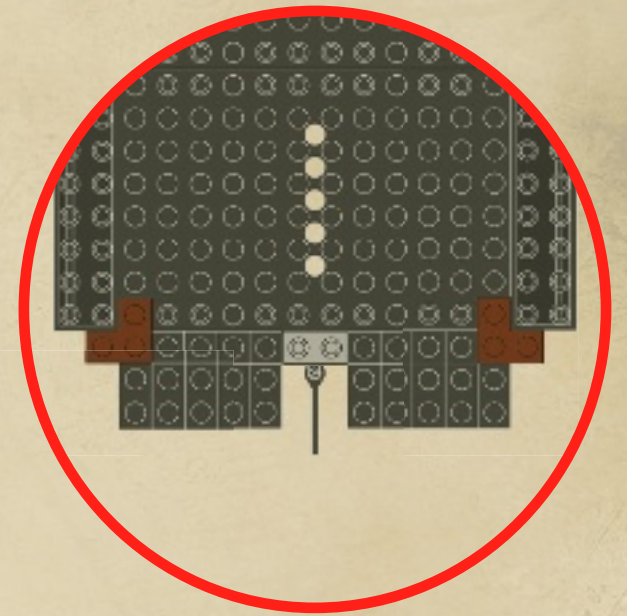
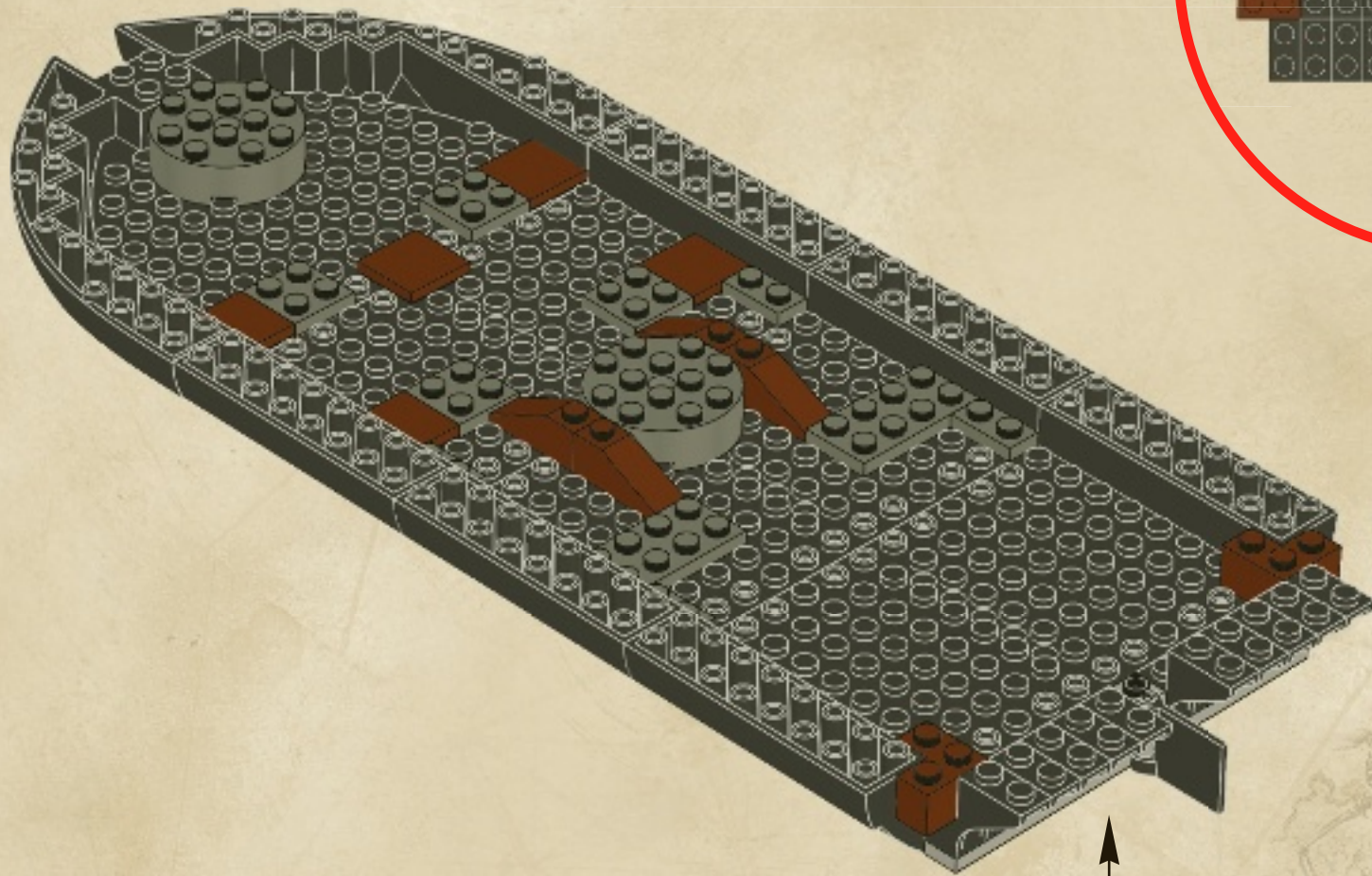

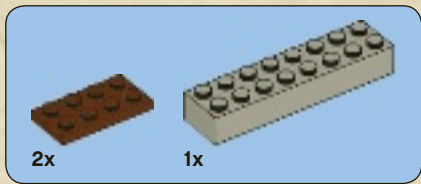

10

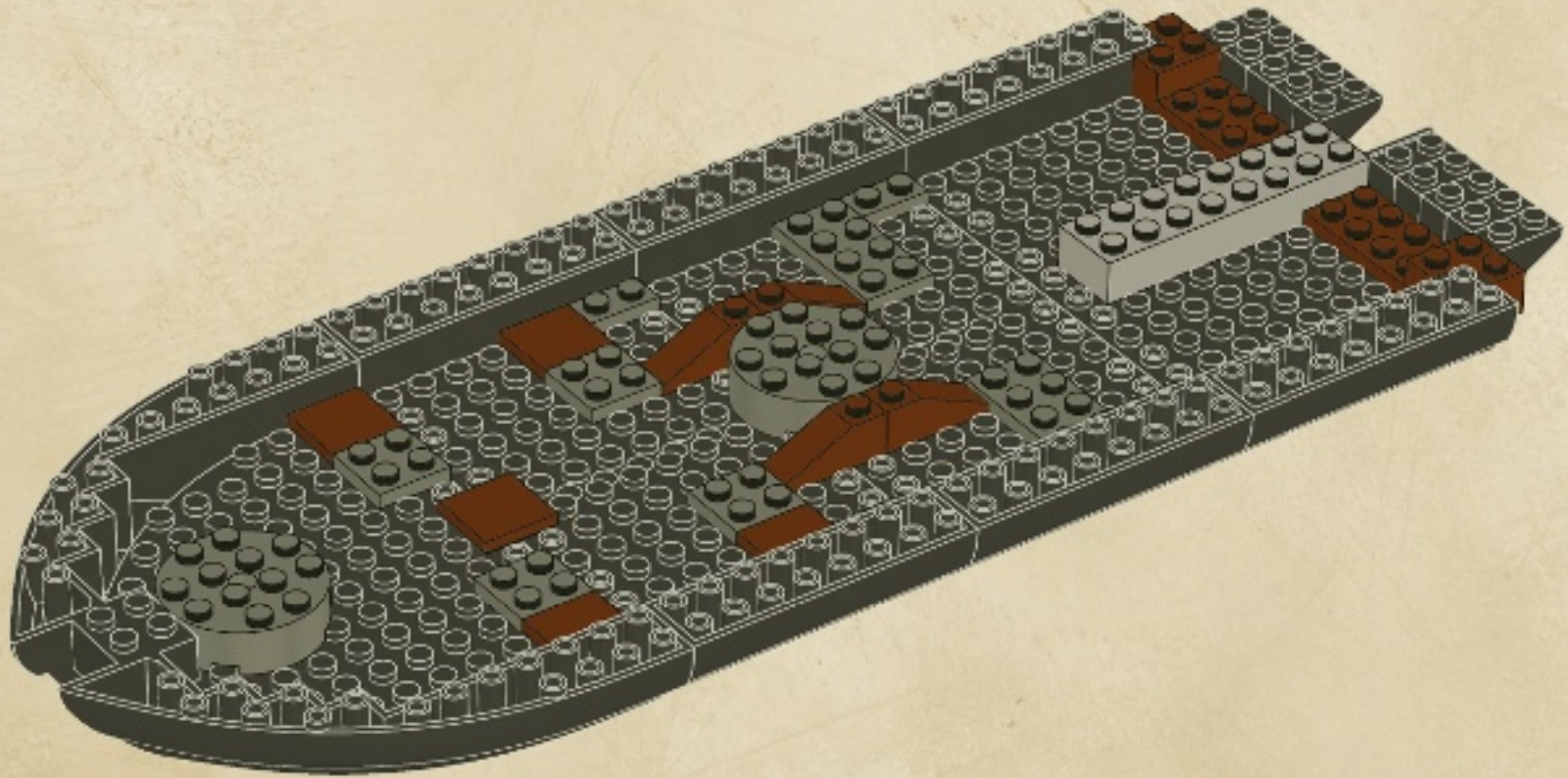

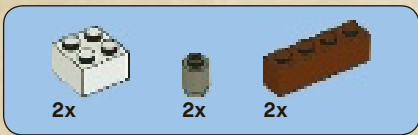

11

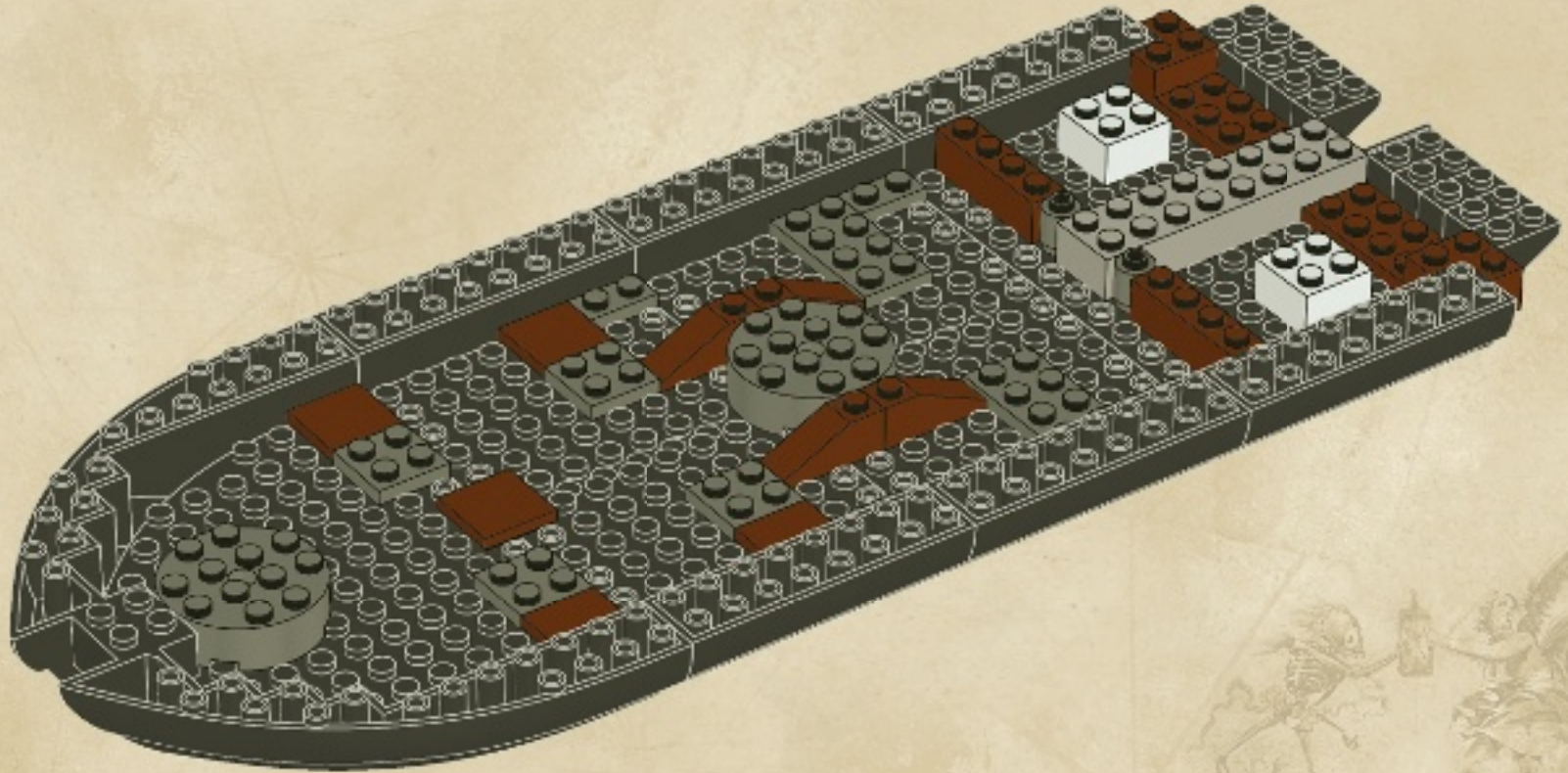



12

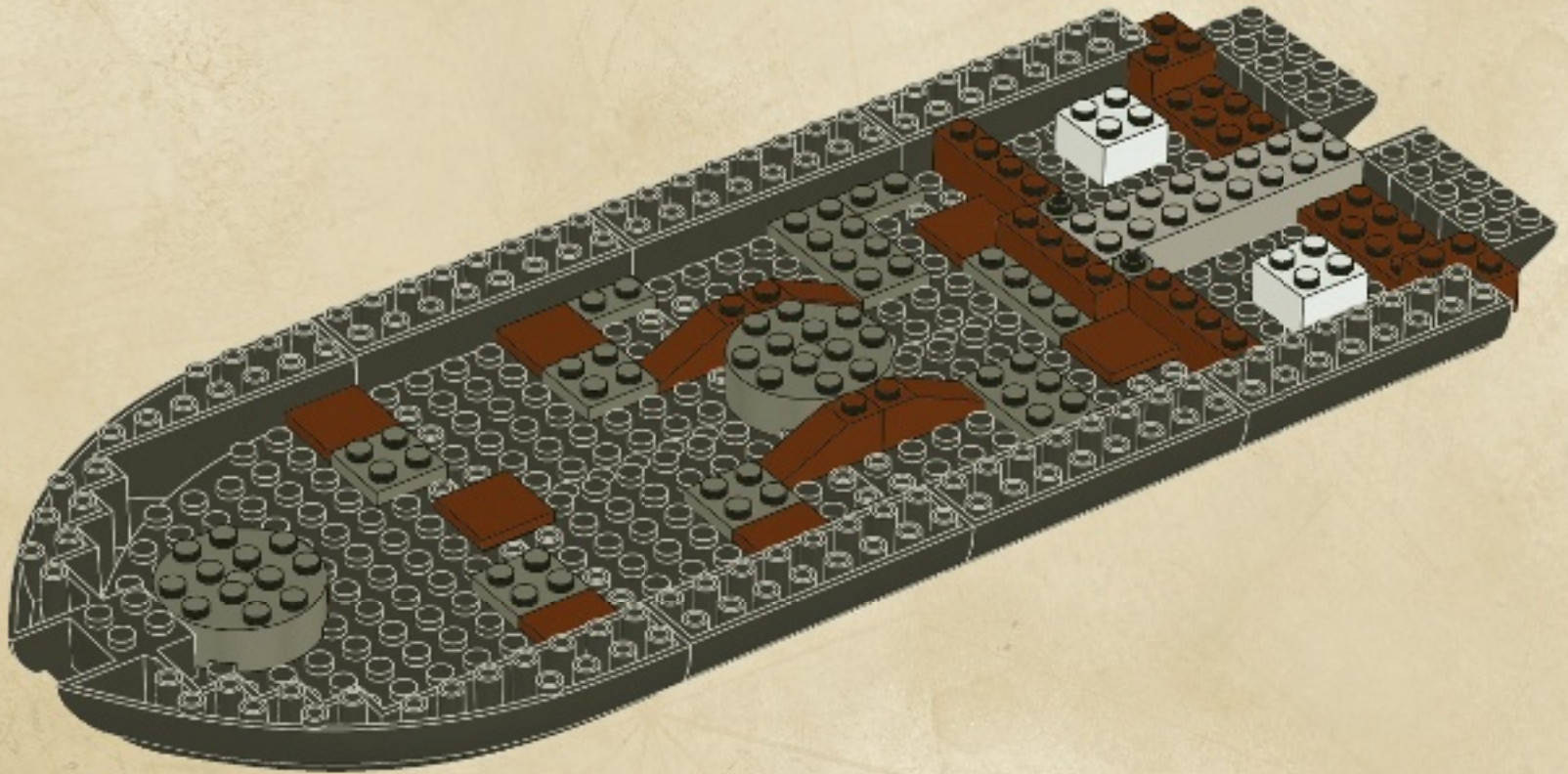



13

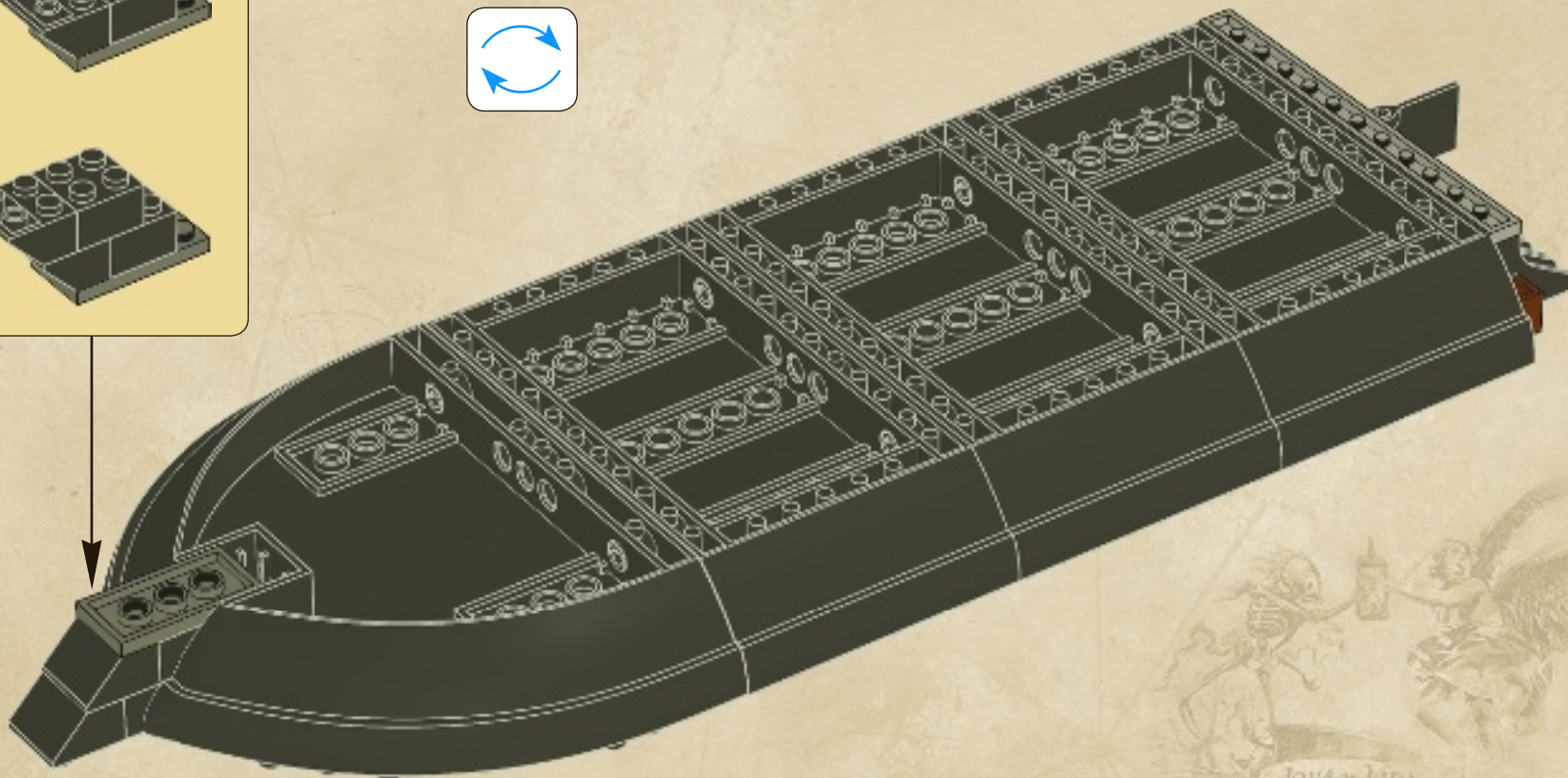
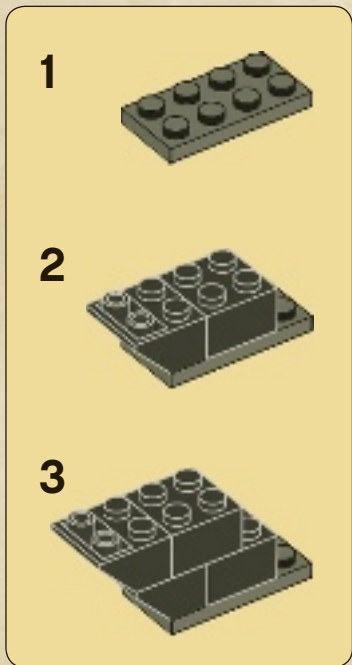



10x

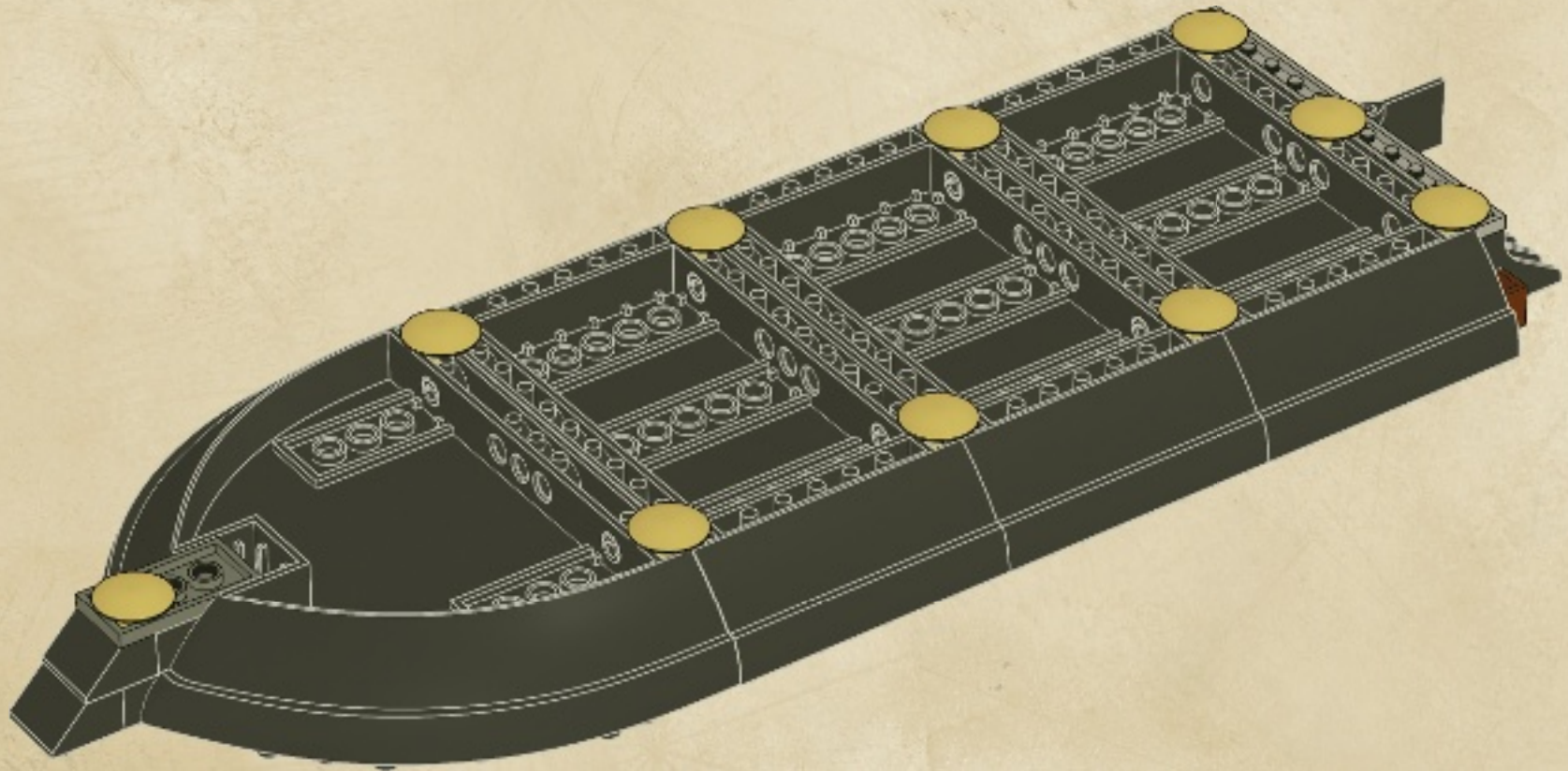

14

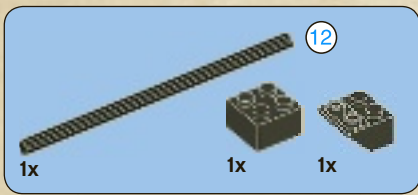

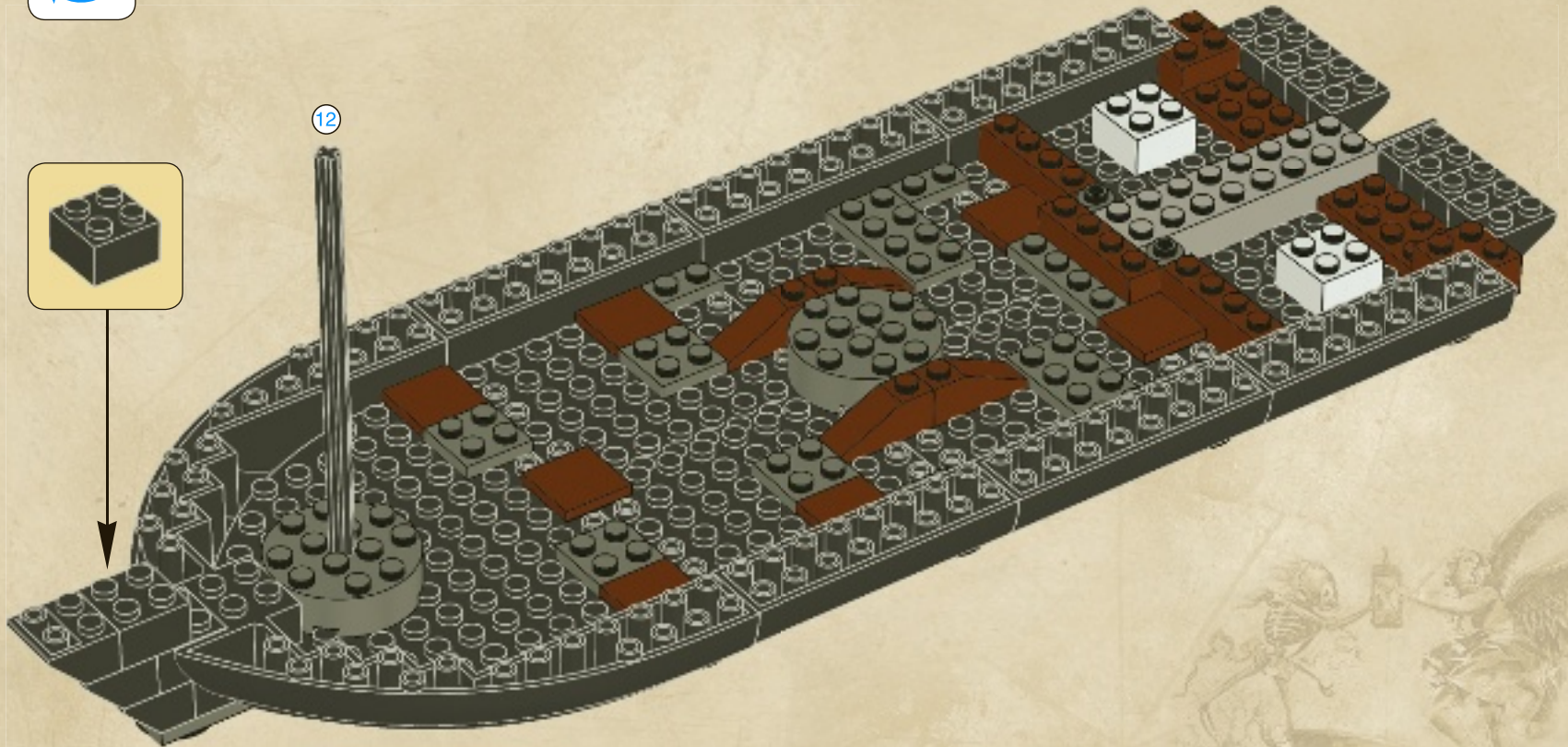
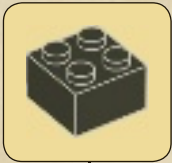

15



1x  1x 

16

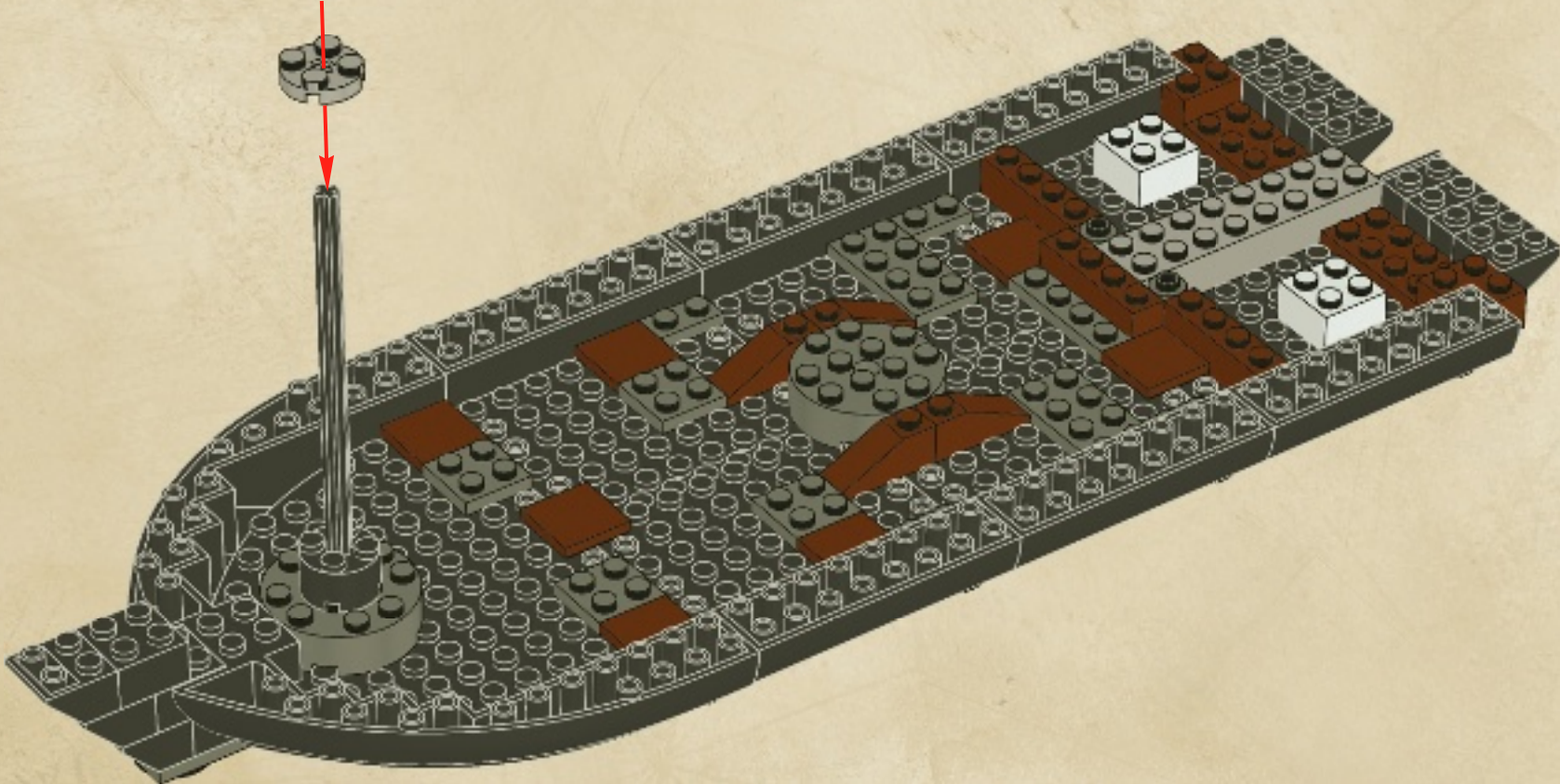



17

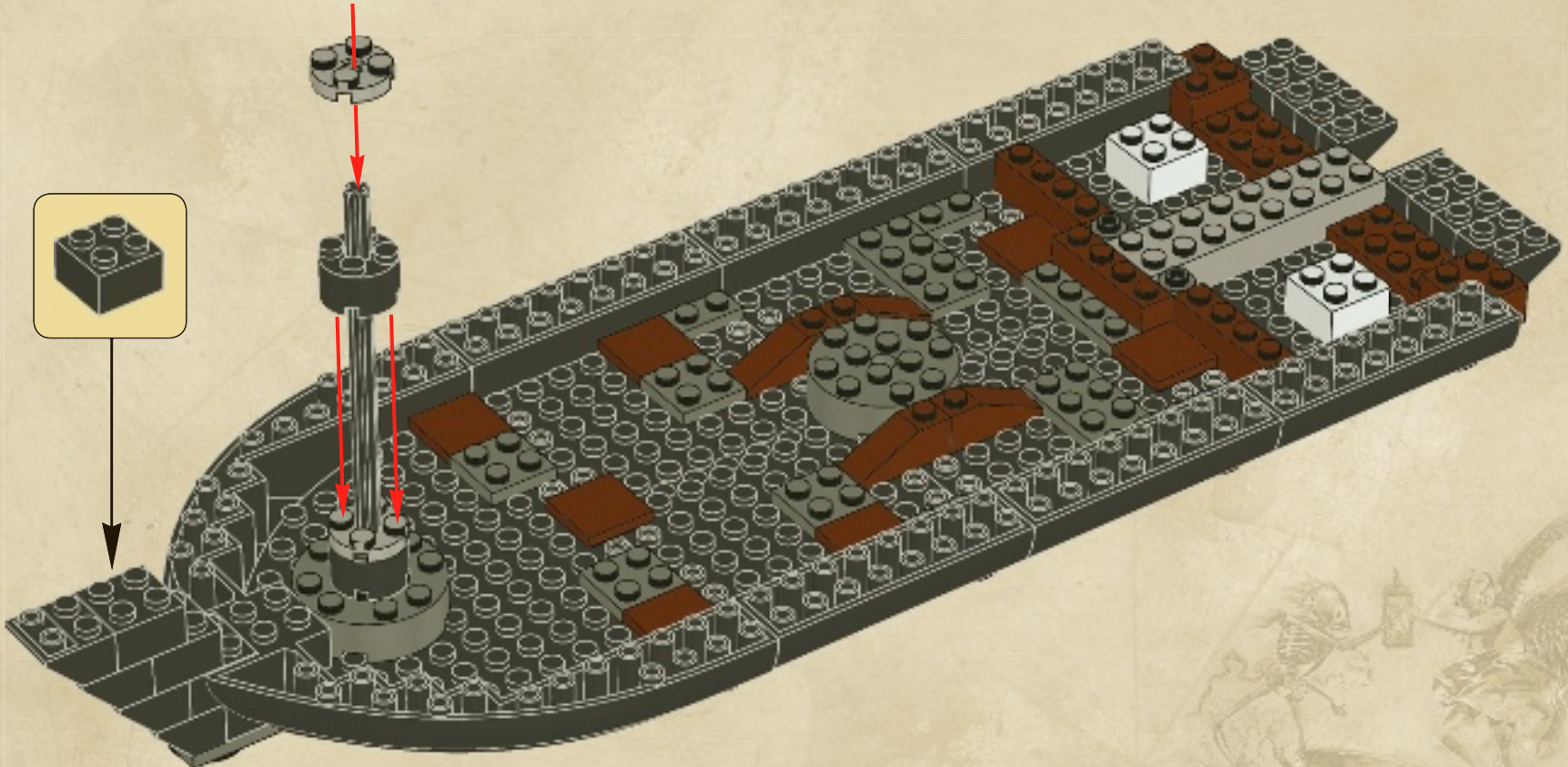

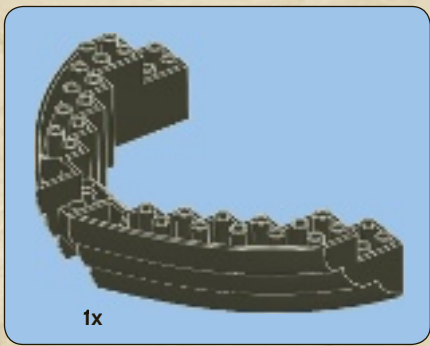

18

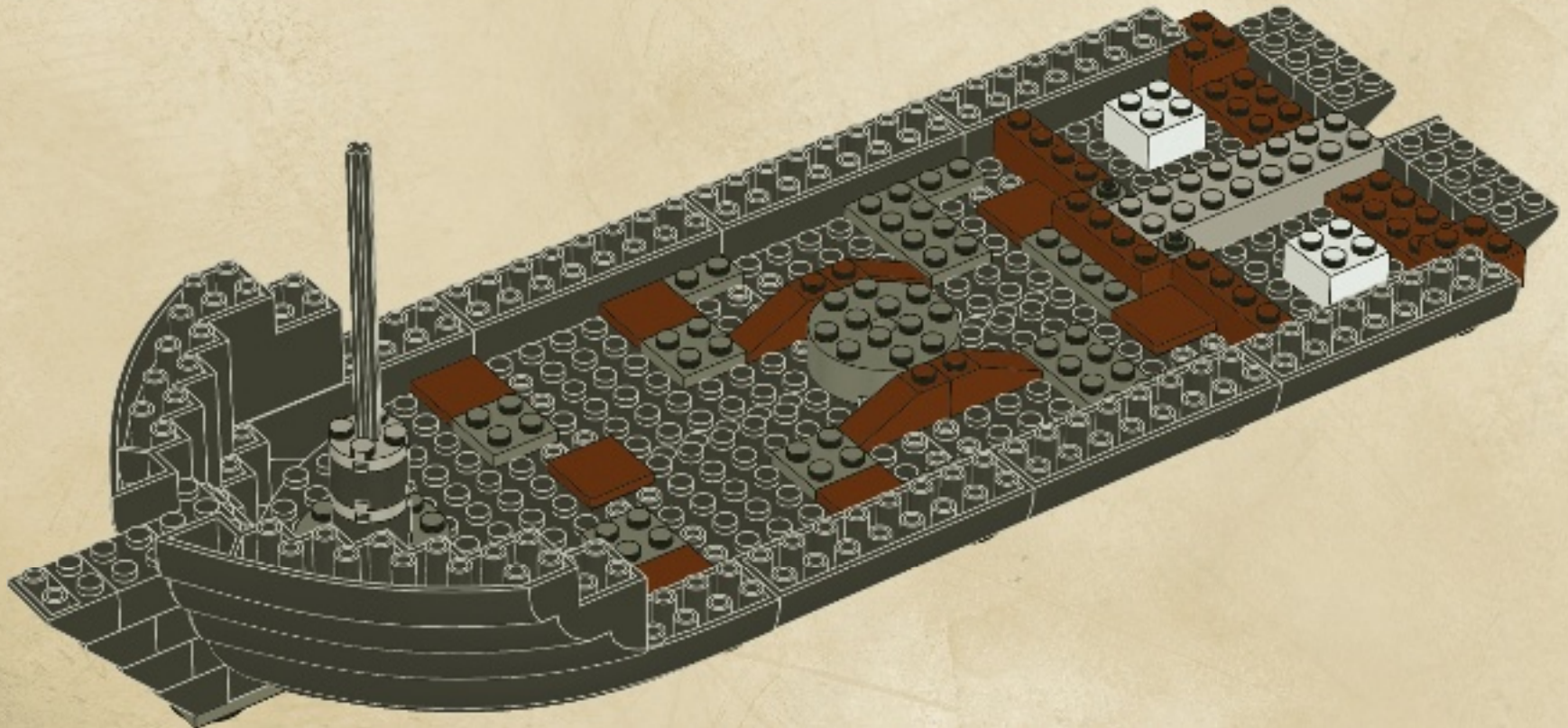

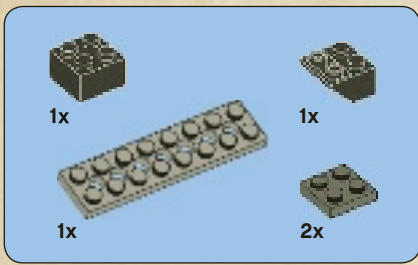

19

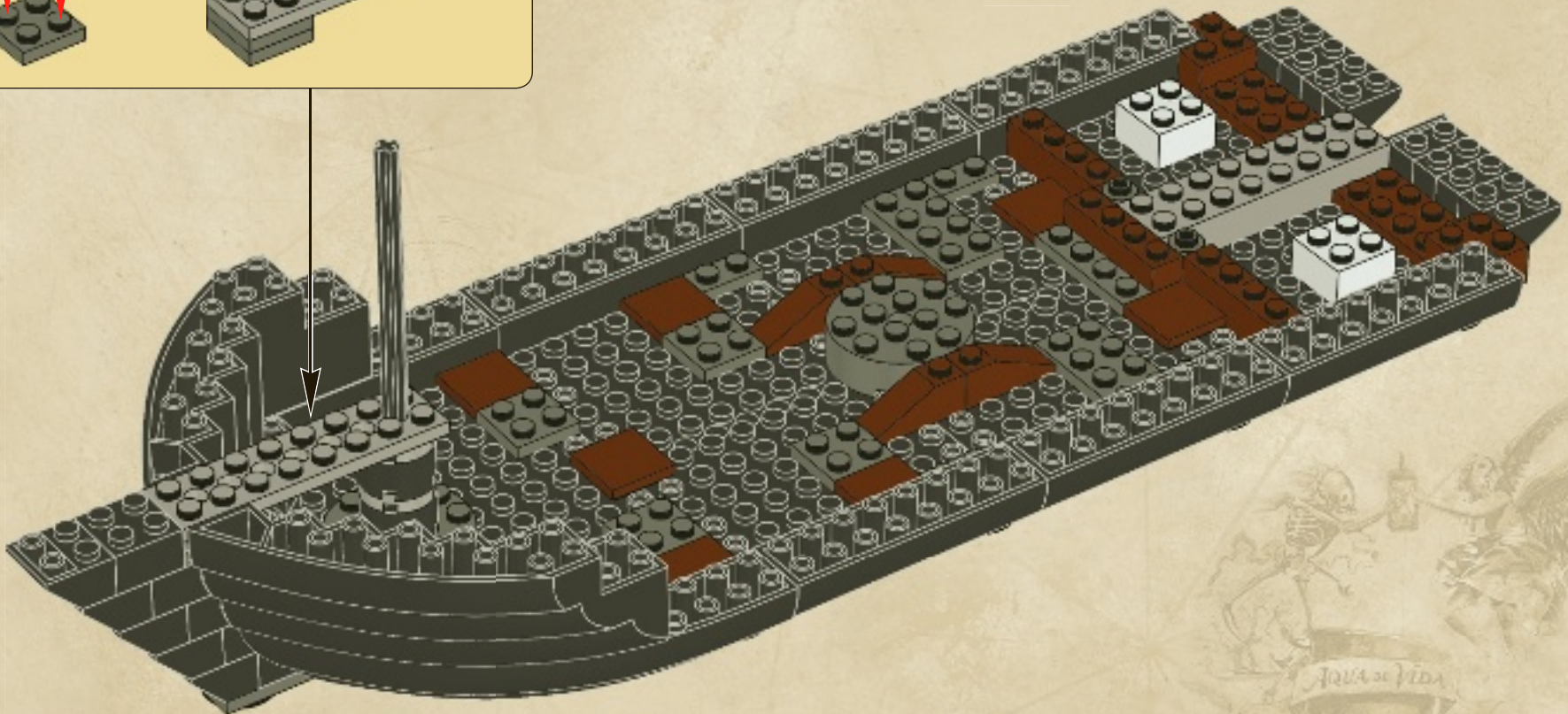
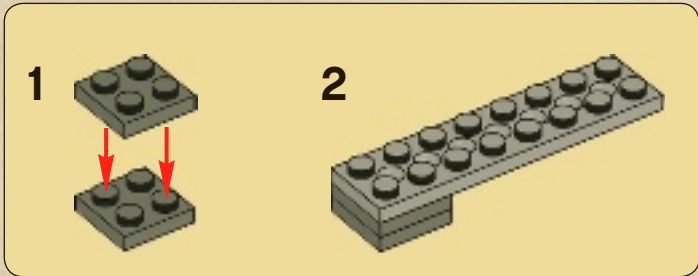

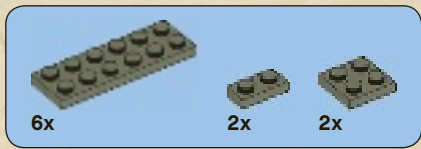

20

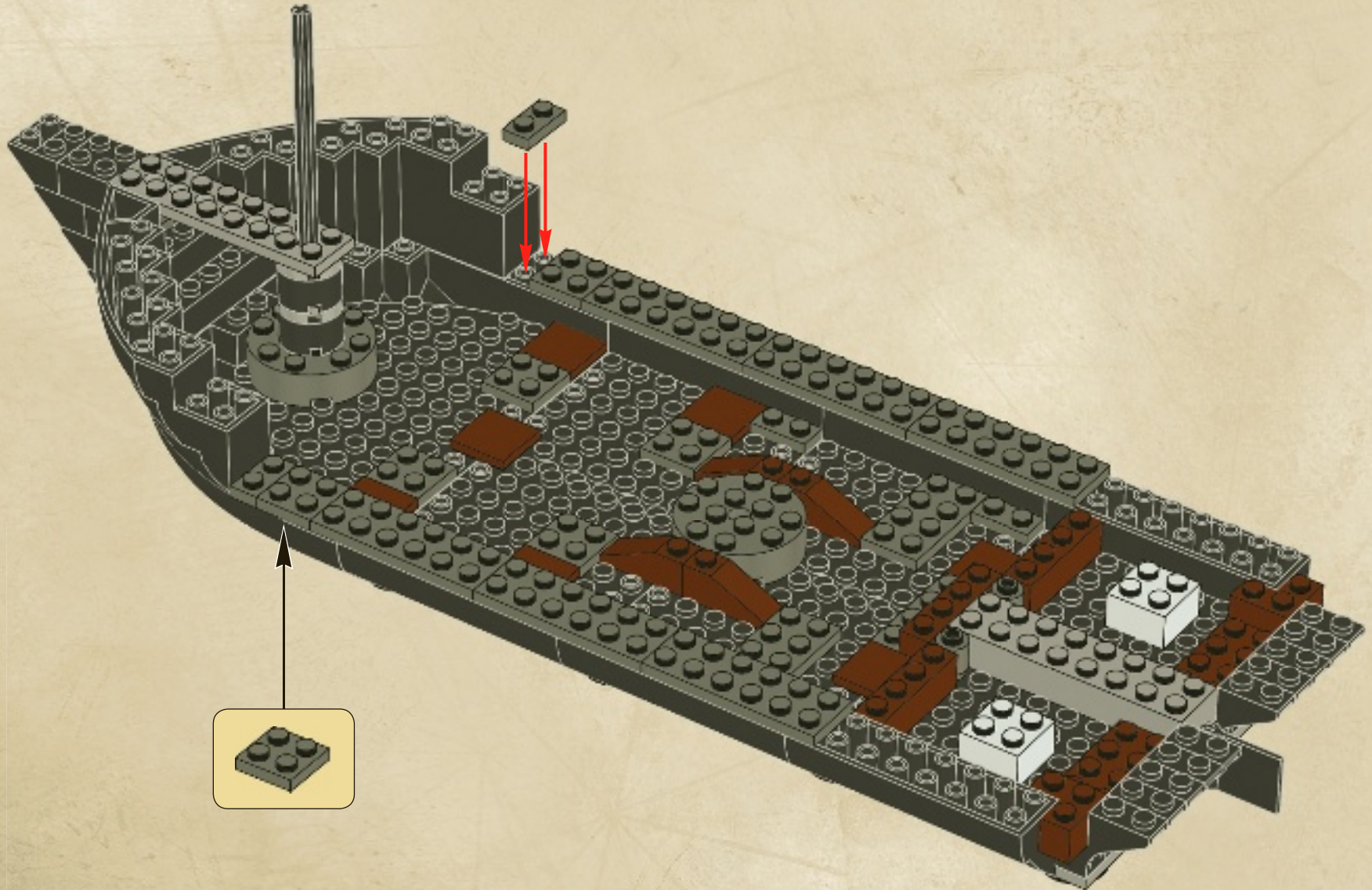



21

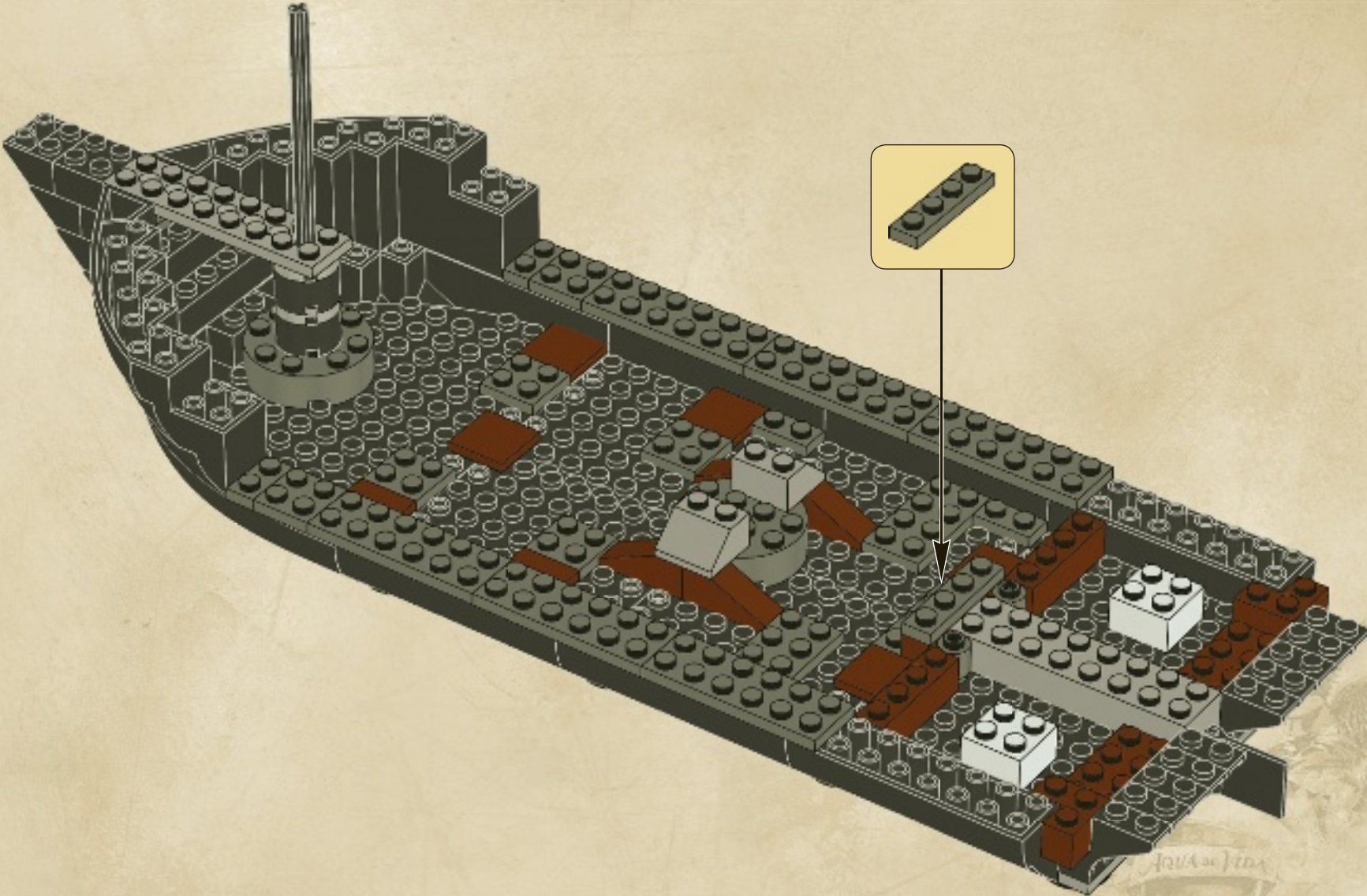

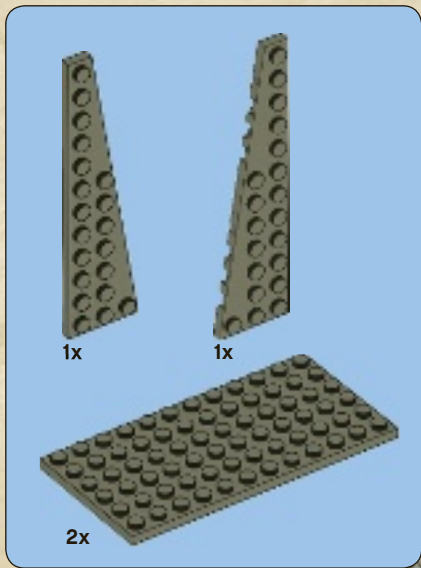

22

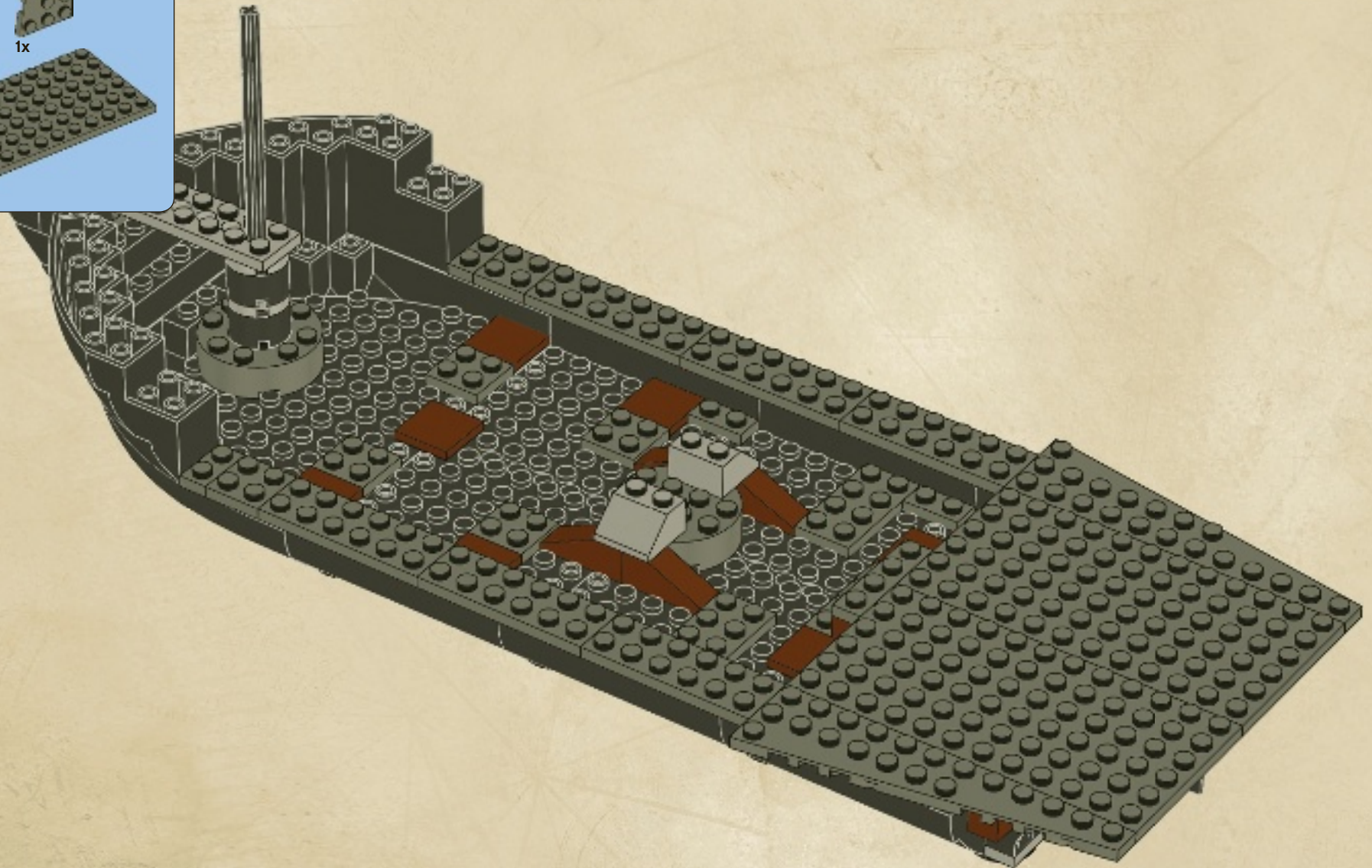

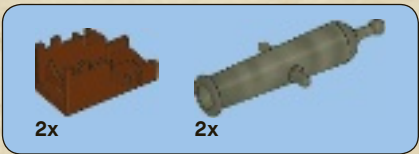

24

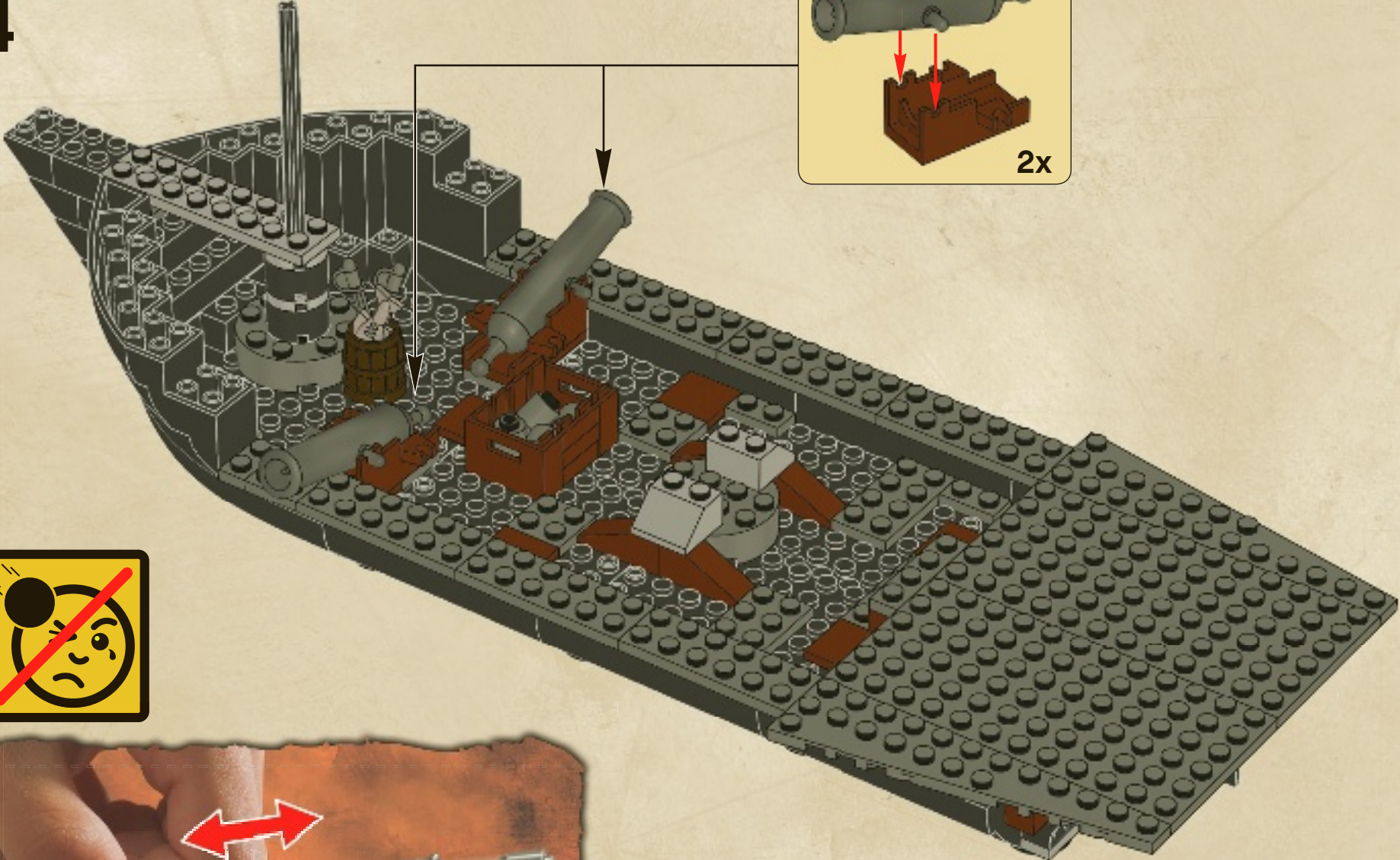
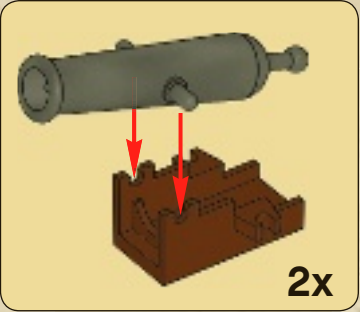

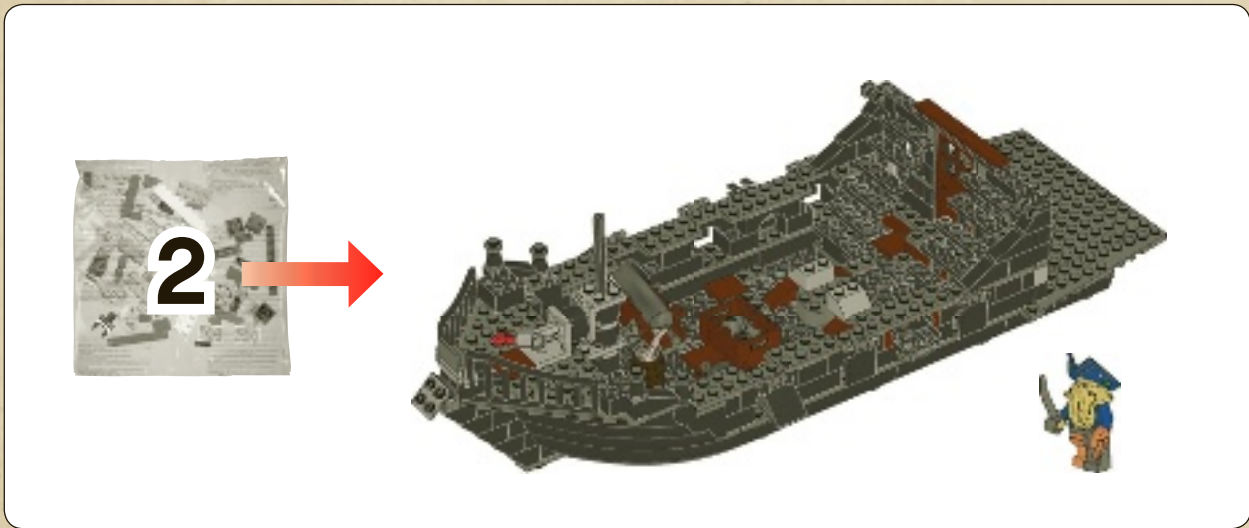



25

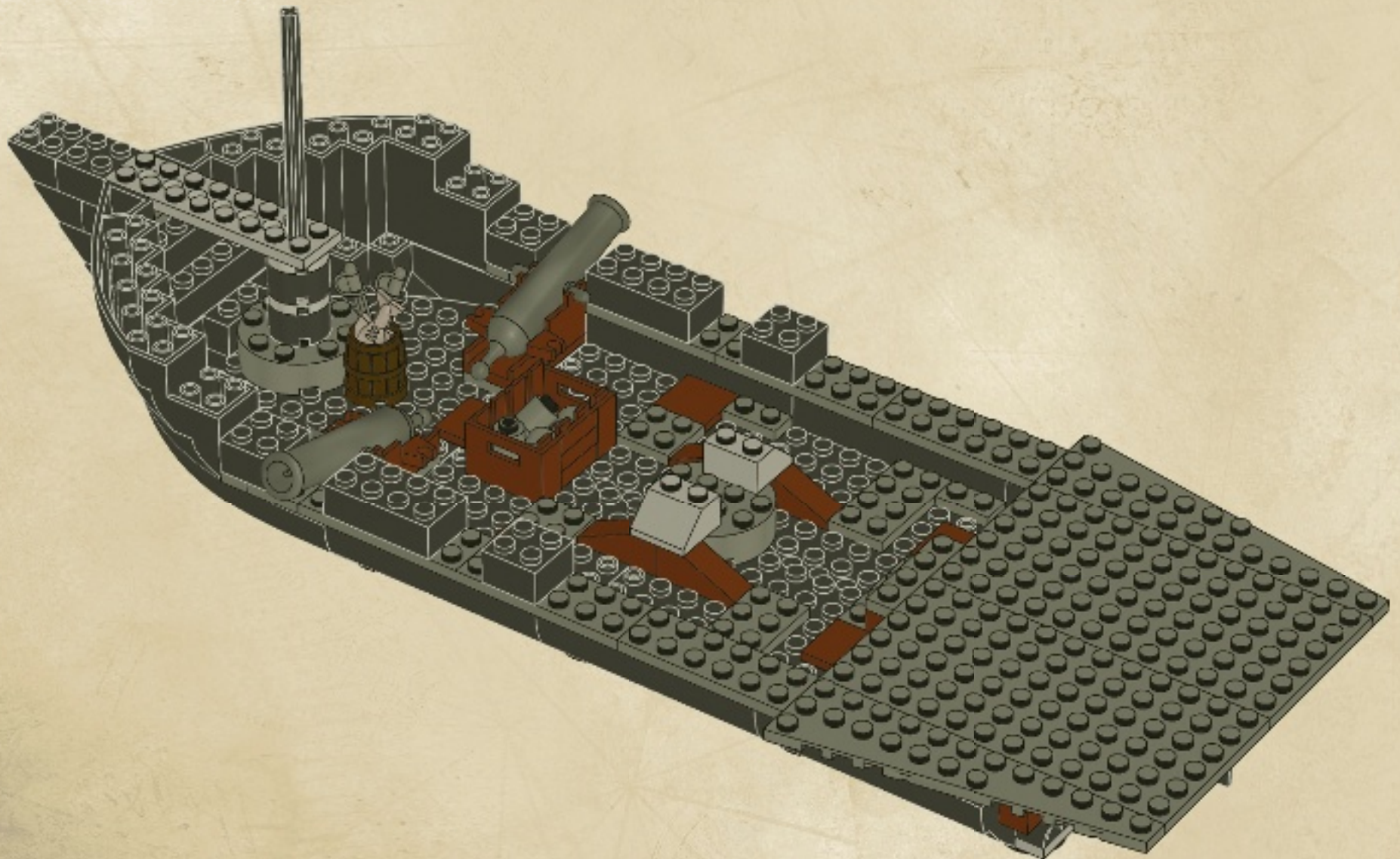

2x 4x

26

2x

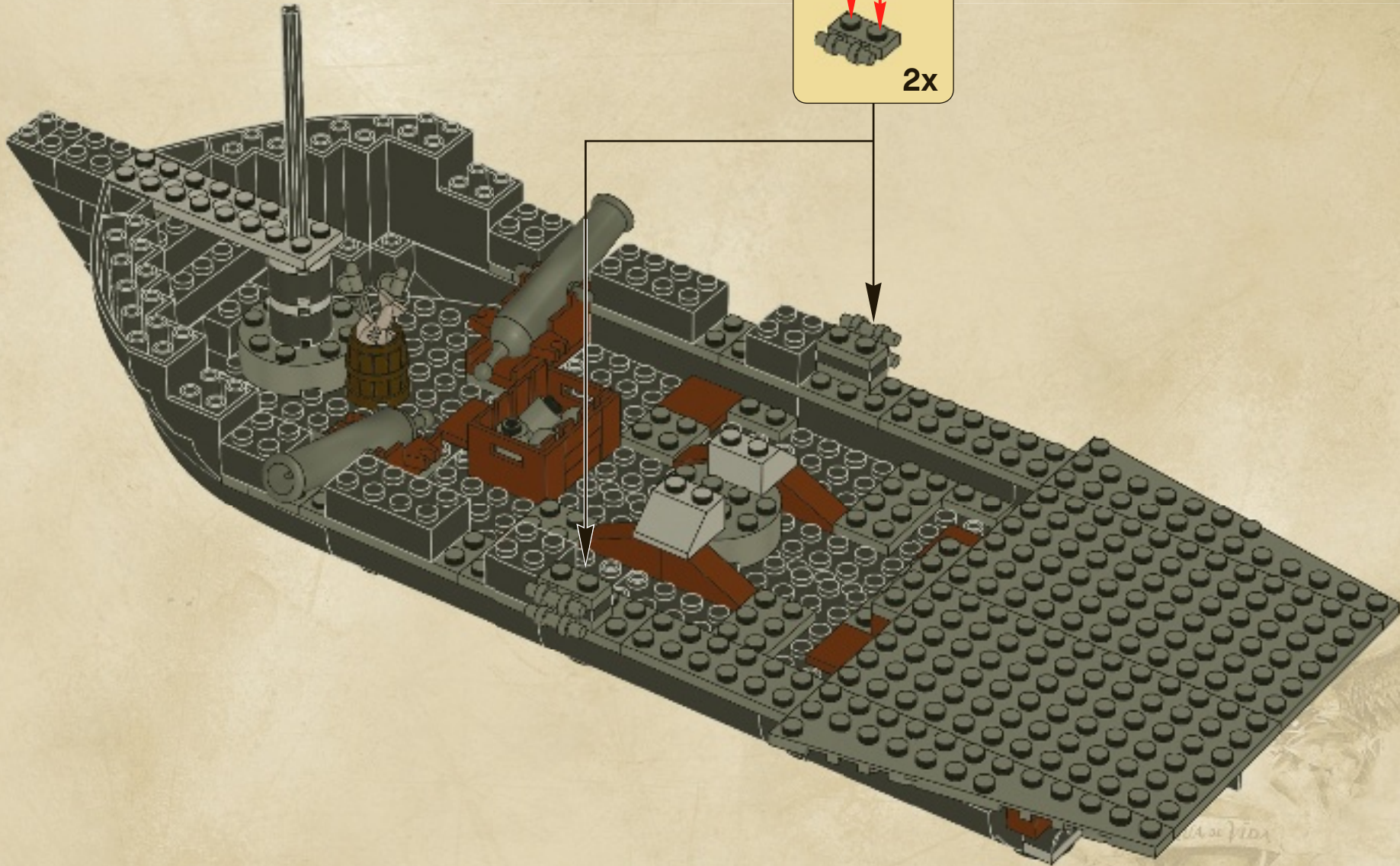



27

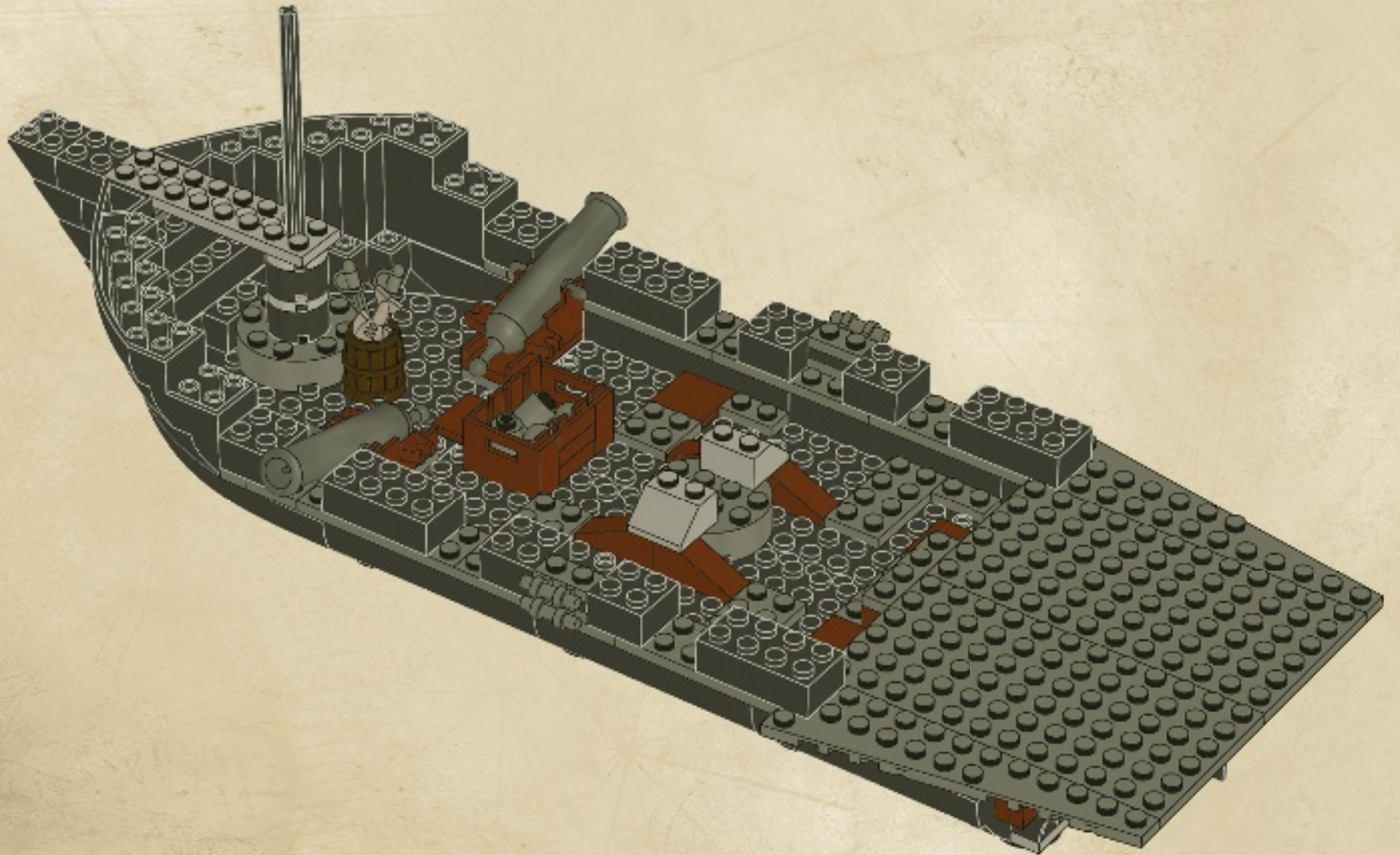



30

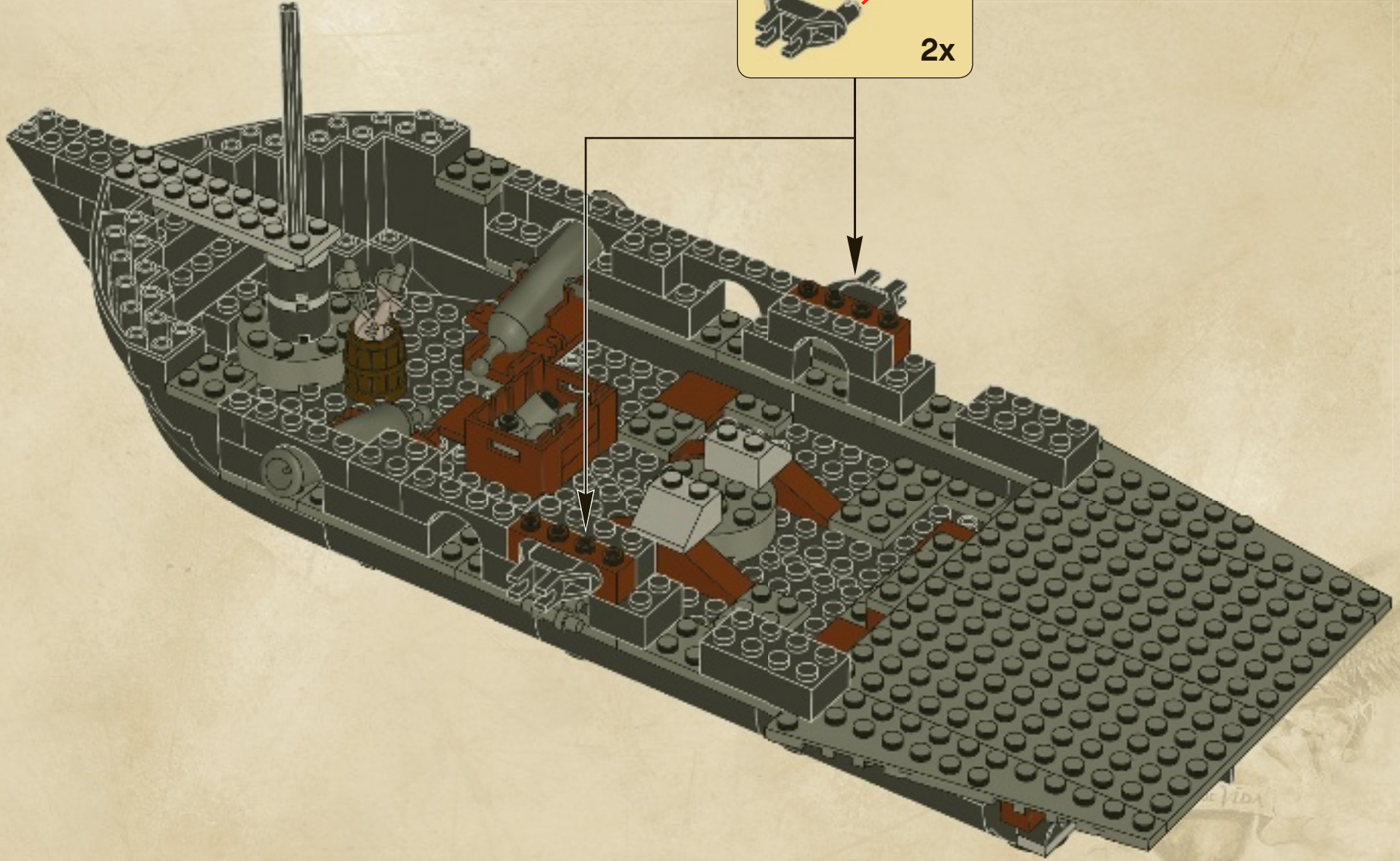
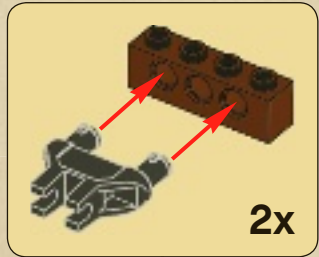



31

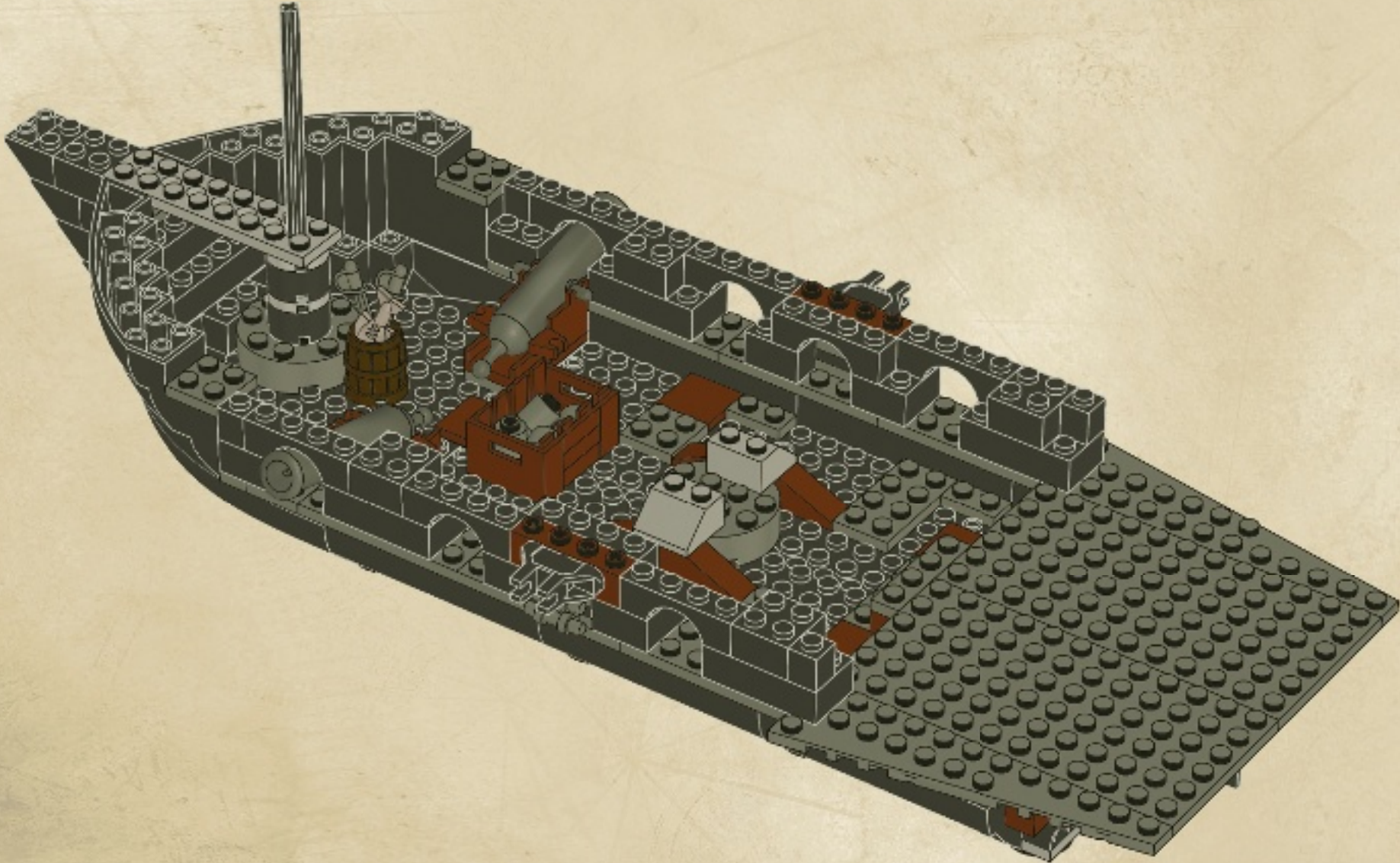

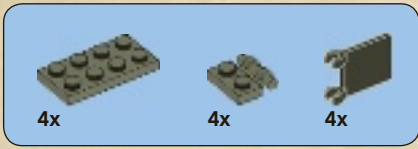

32

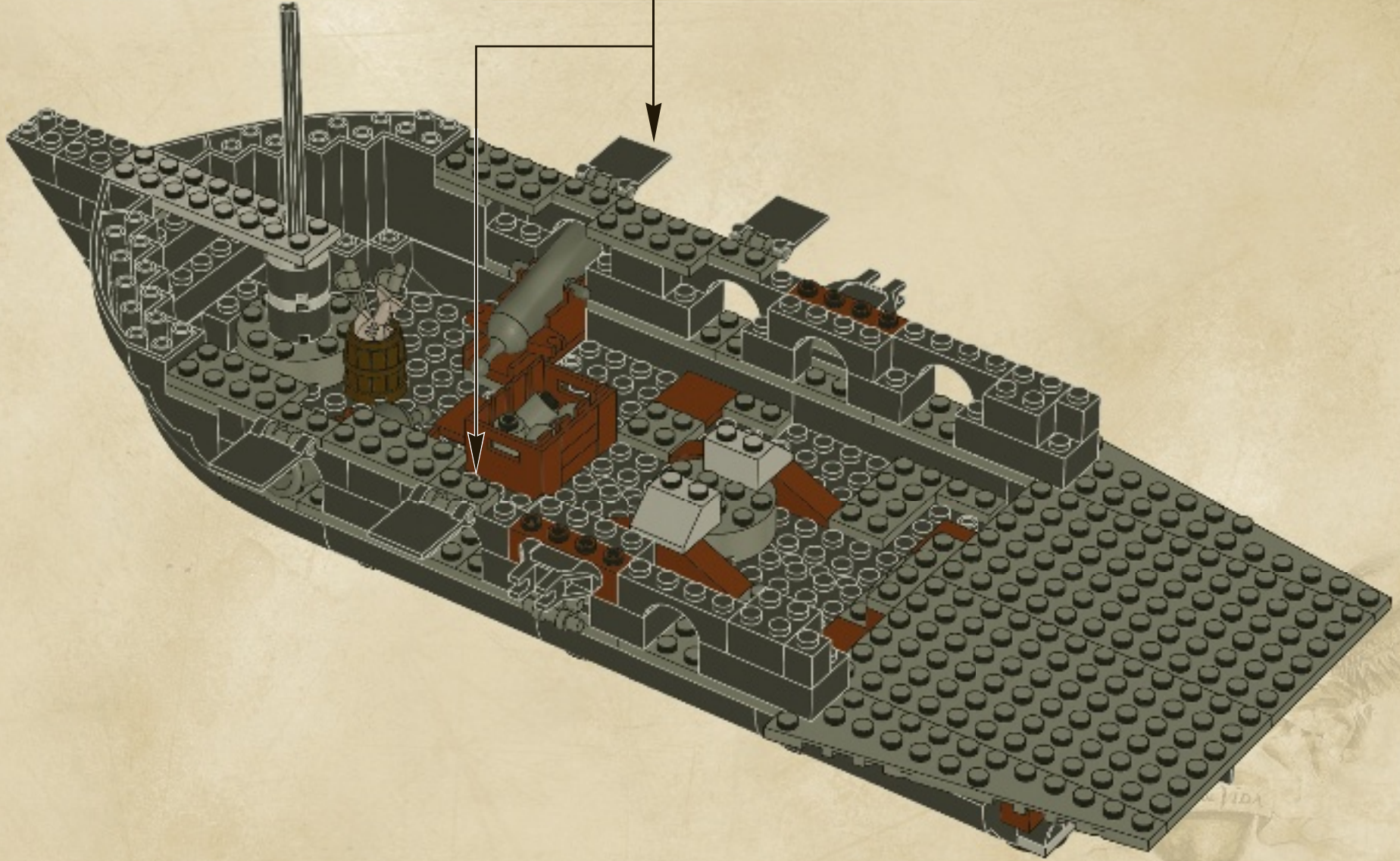
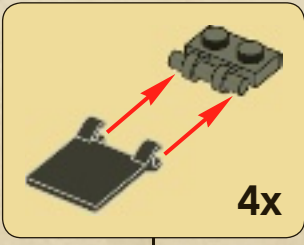

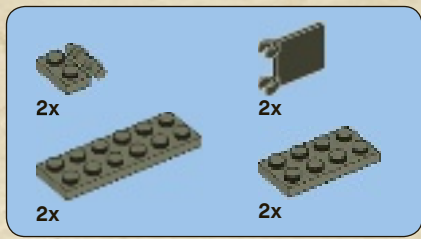

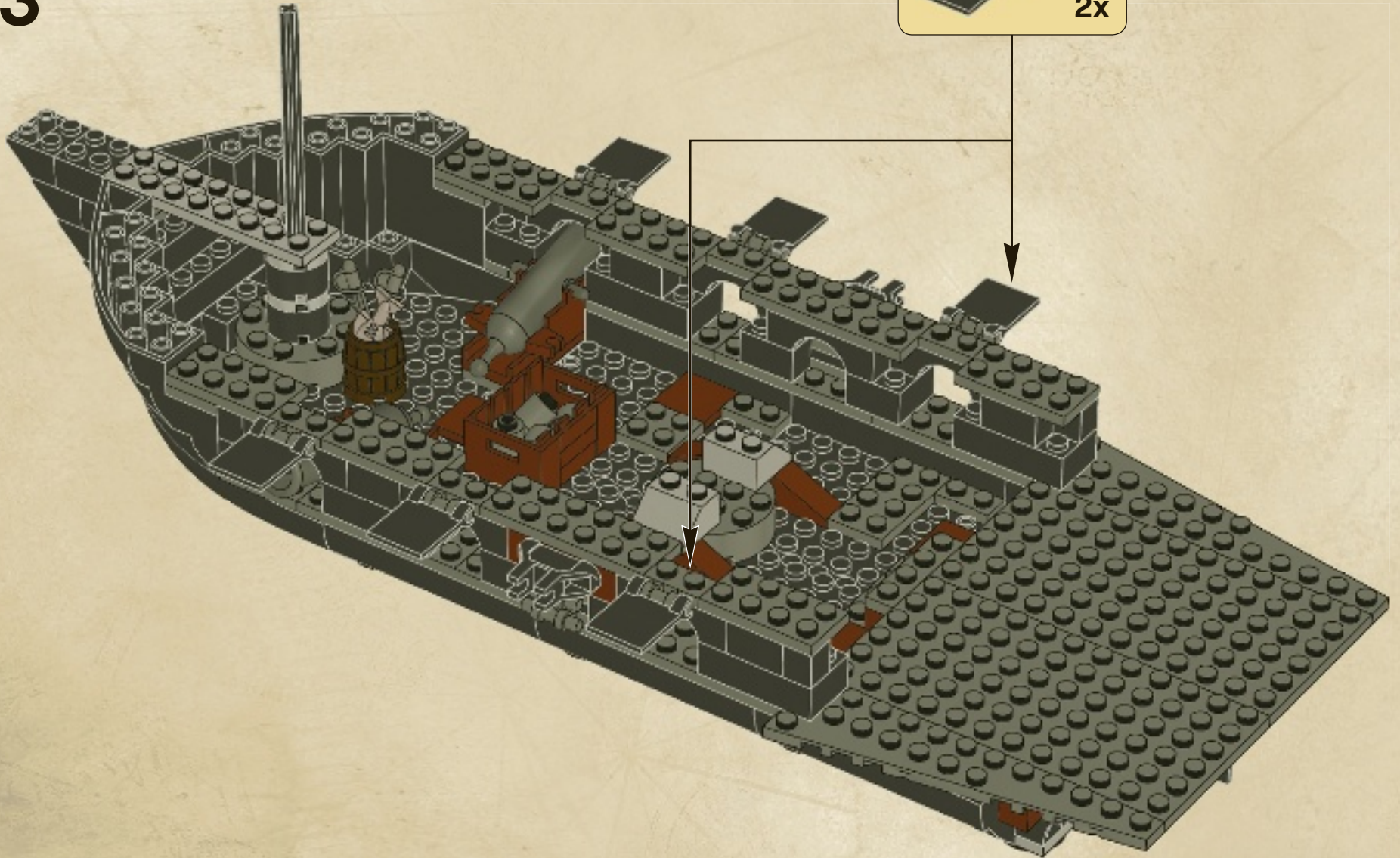
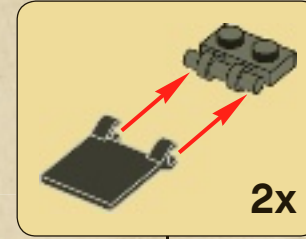

33

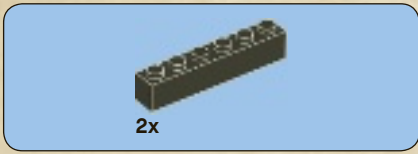

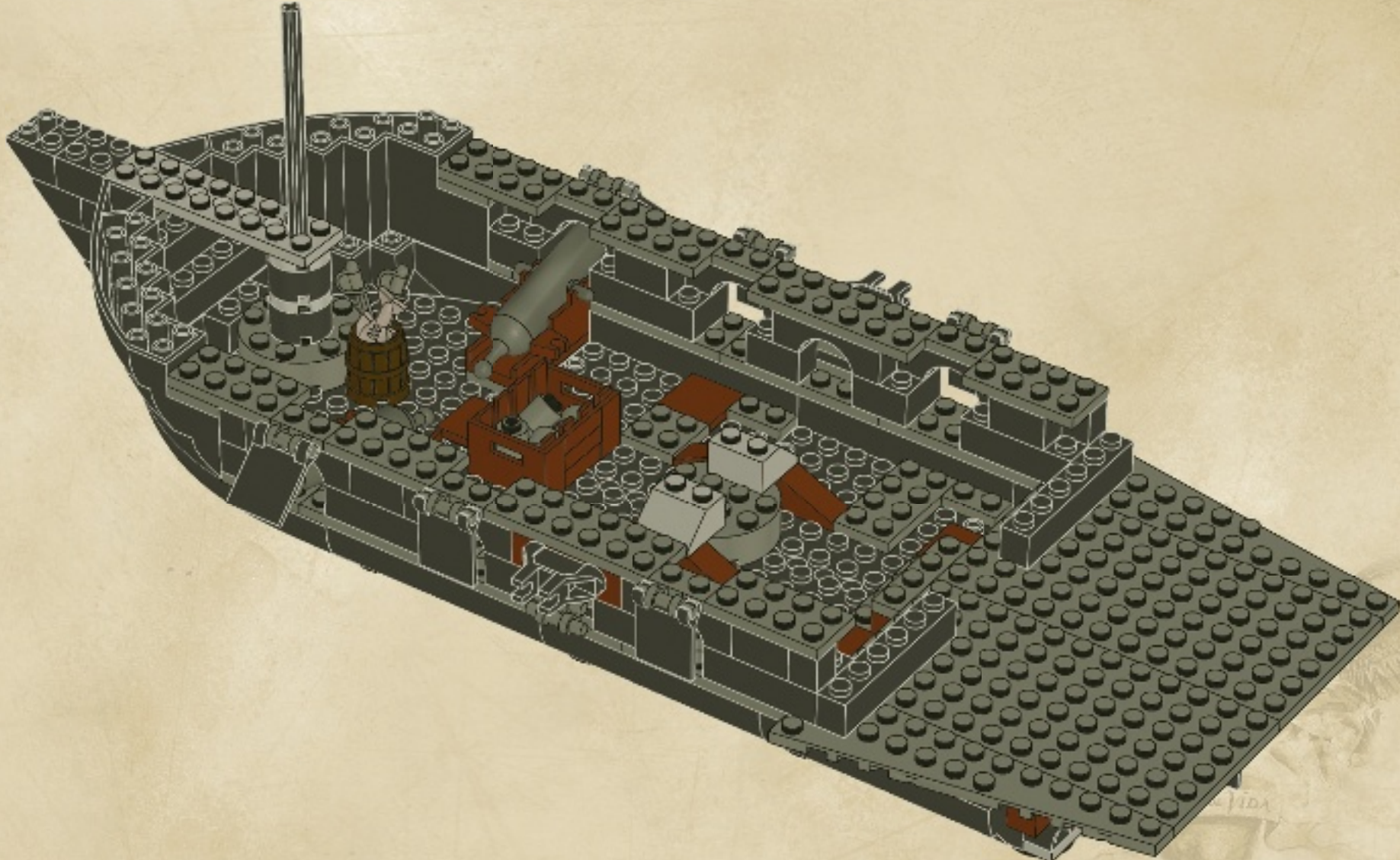

34



2x  4x 

35

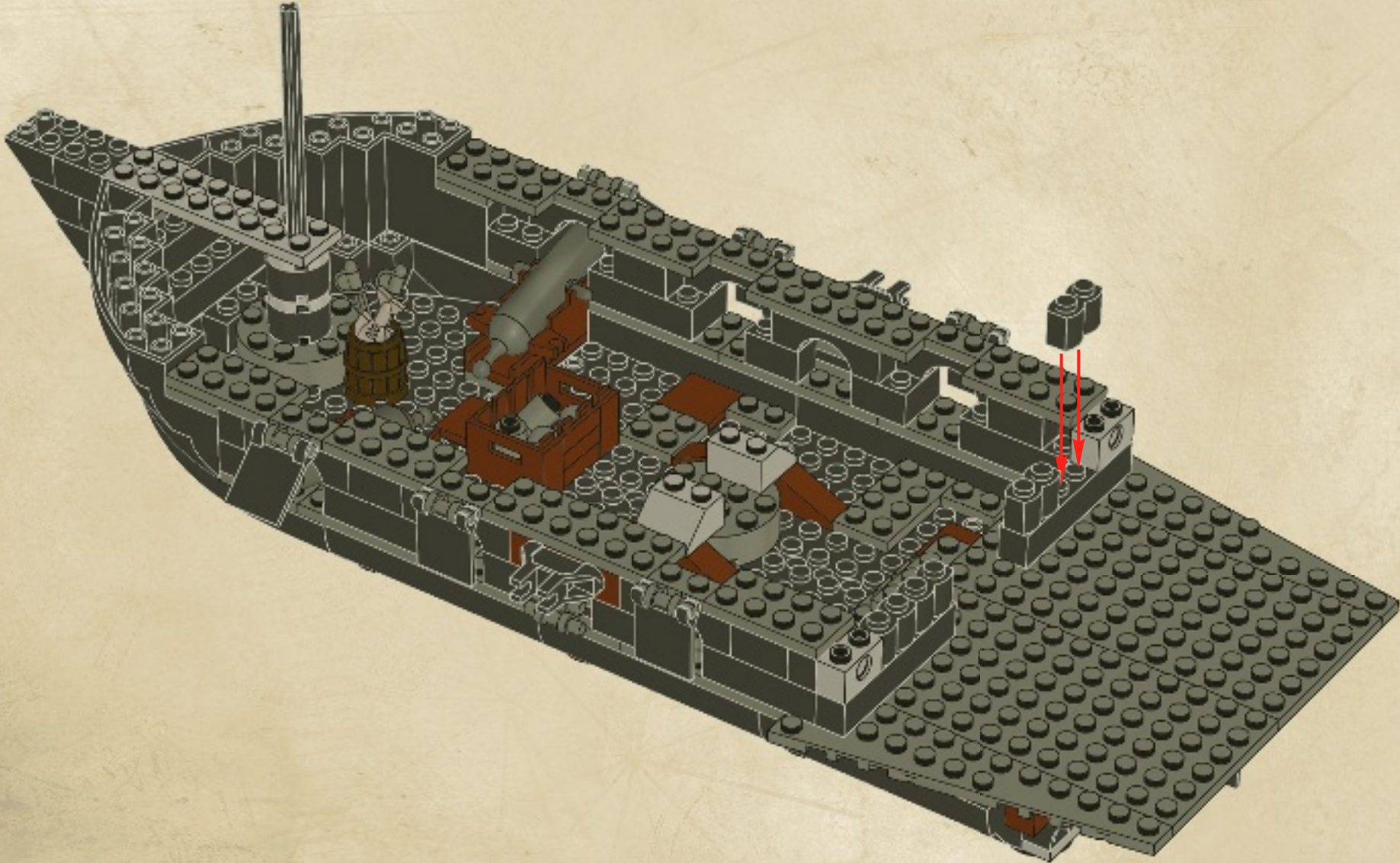



36

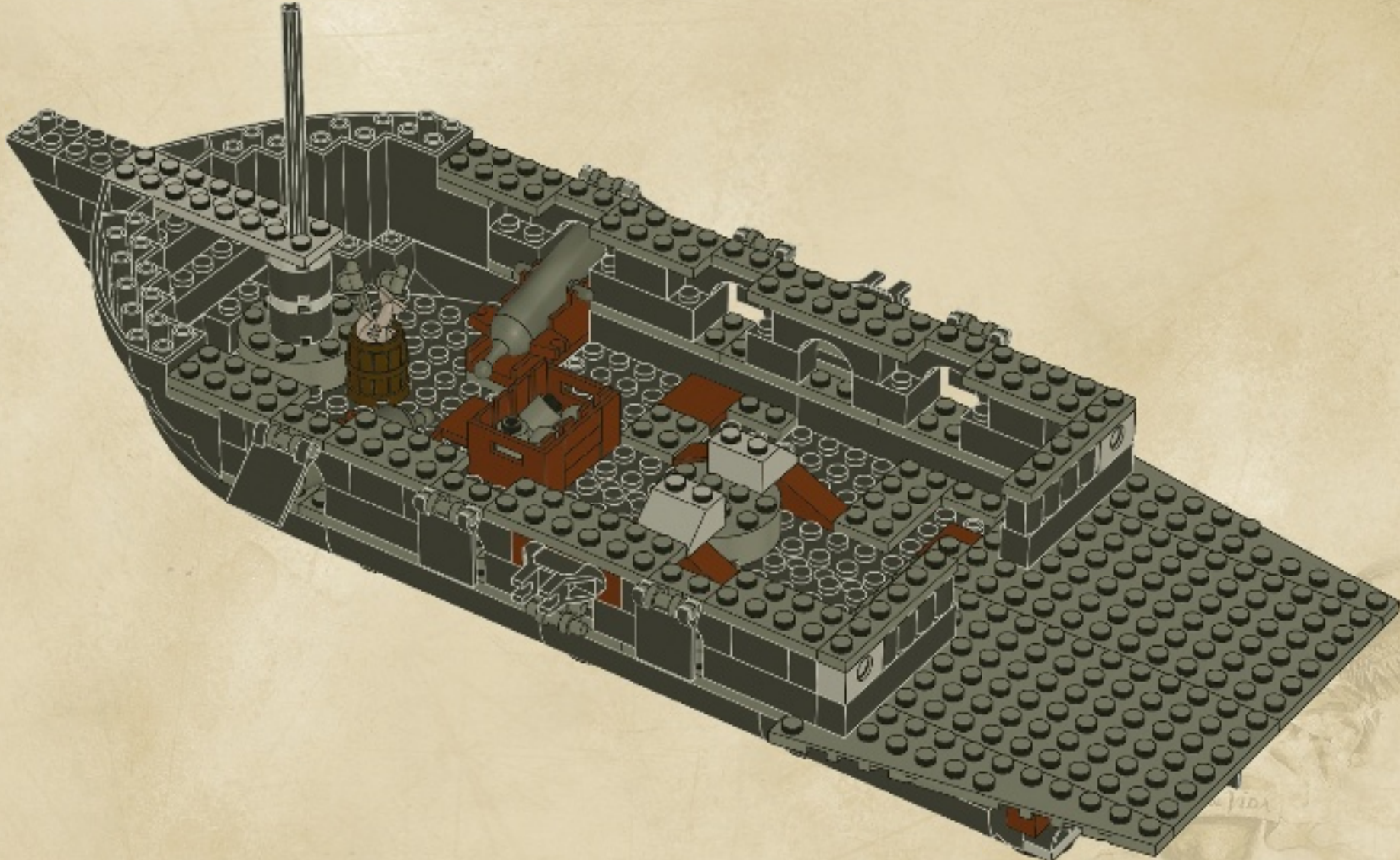

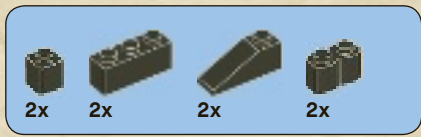

37

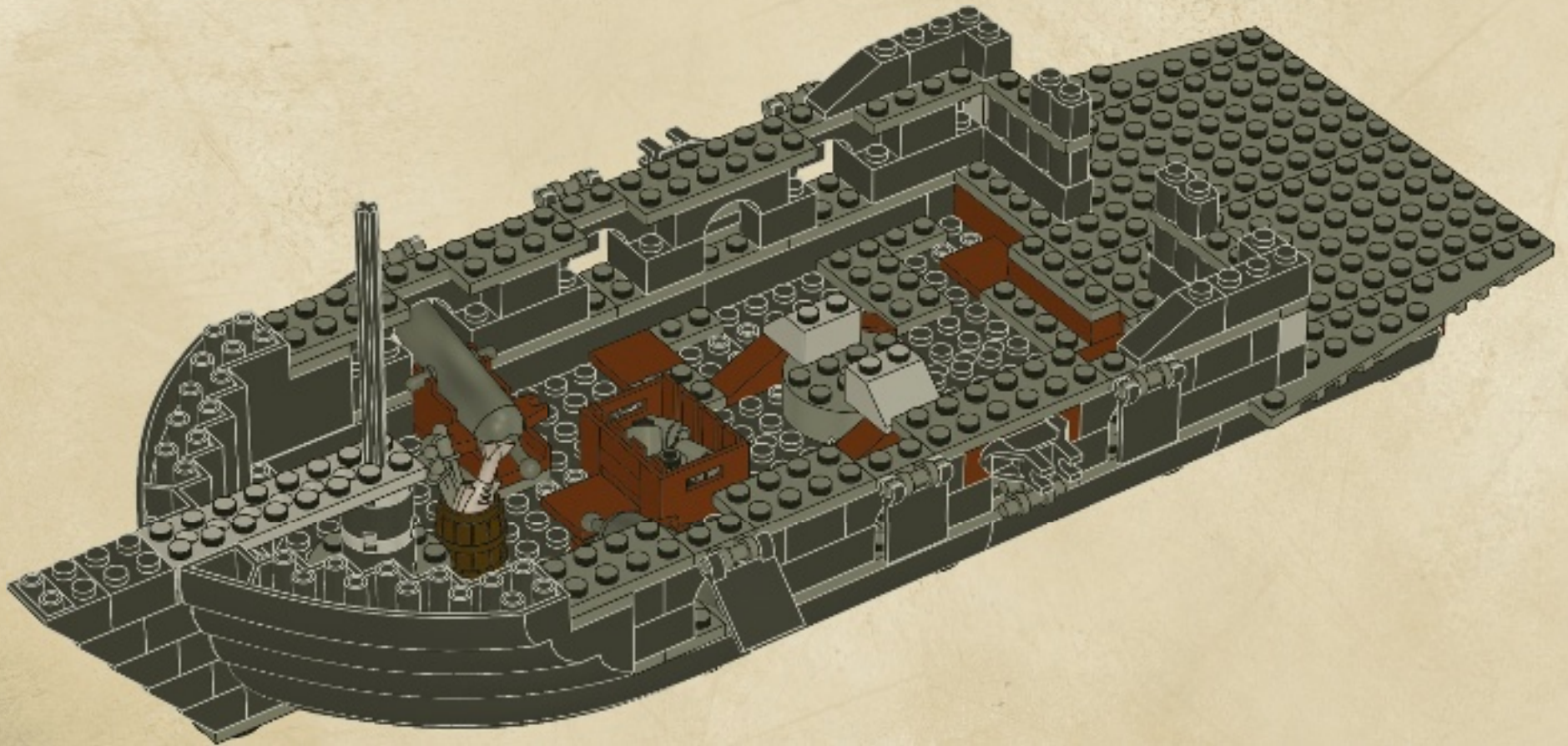



38

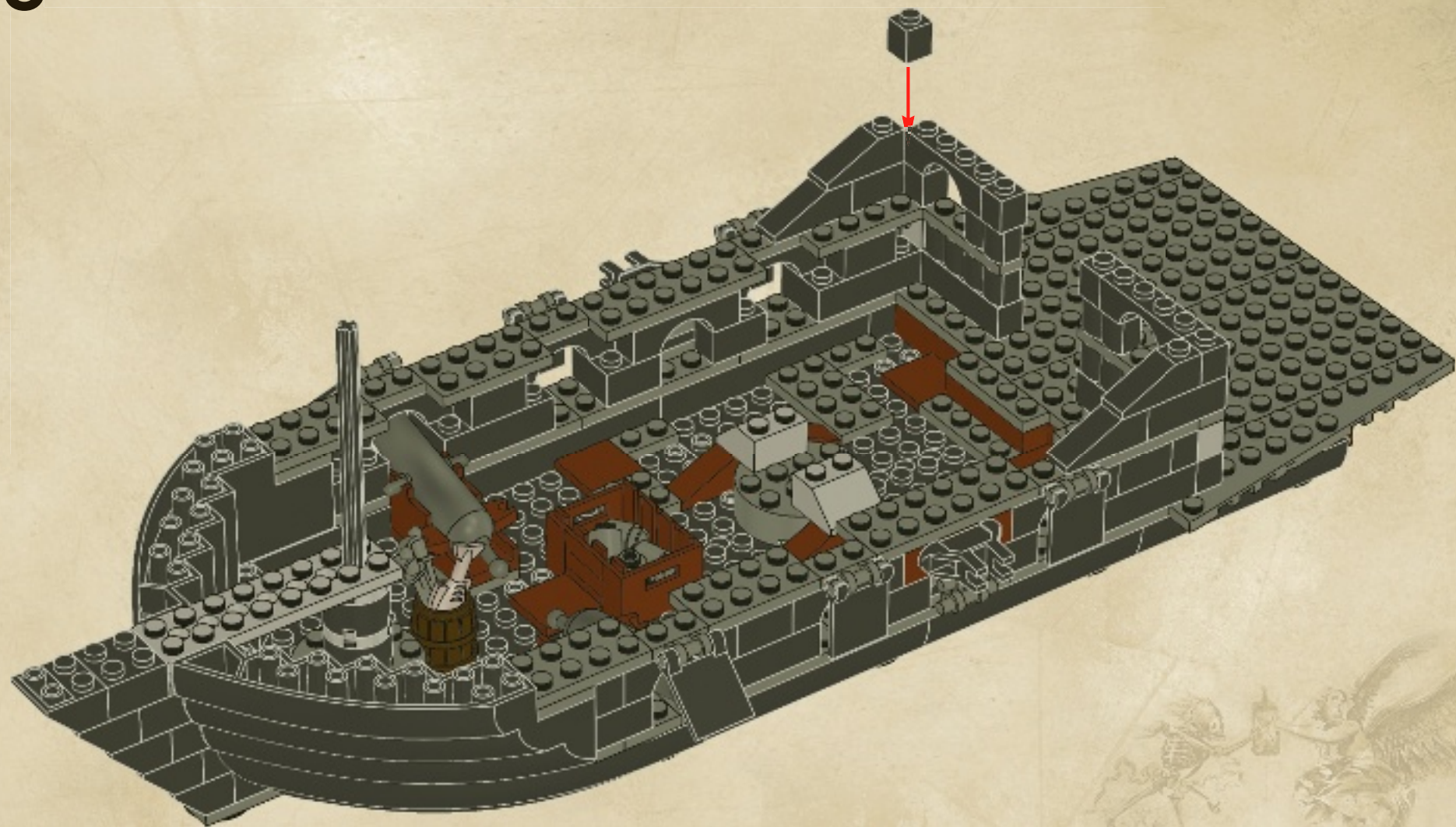



6x

39

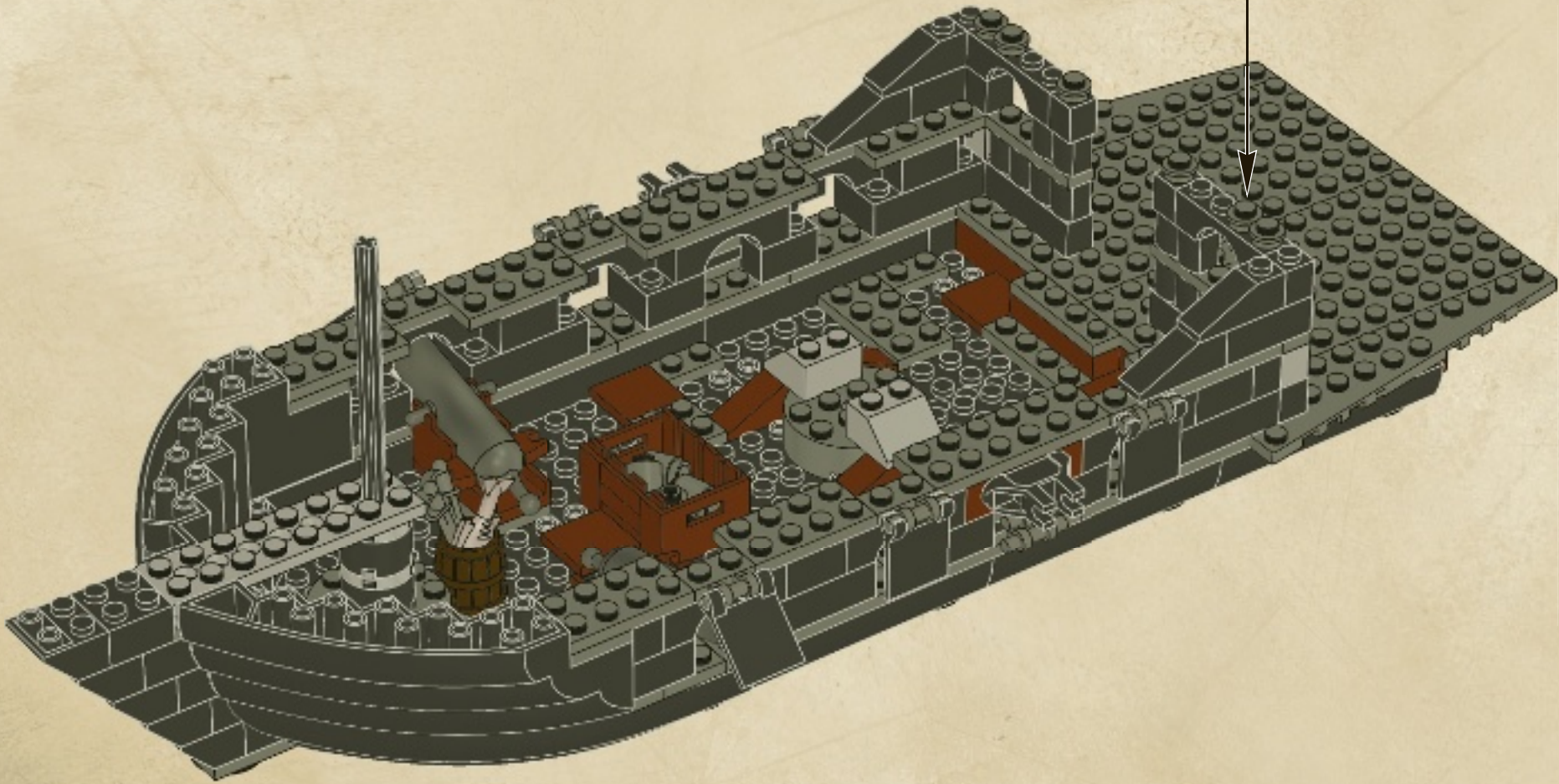

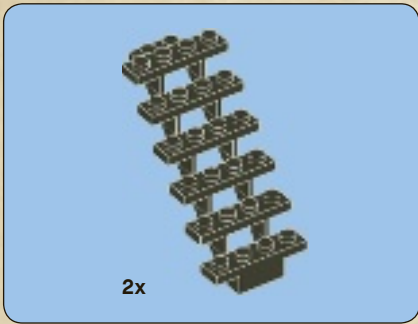

40

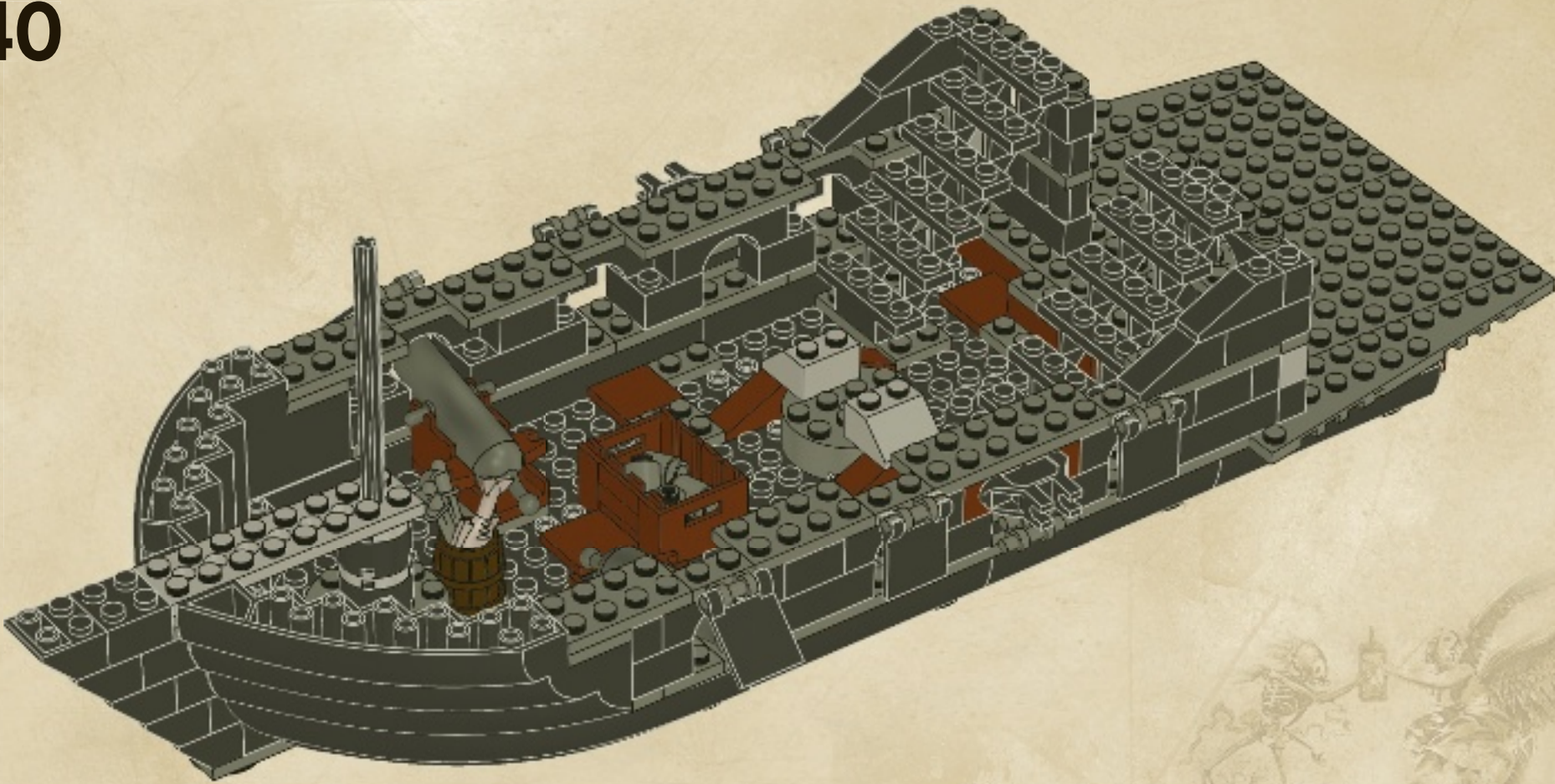



41



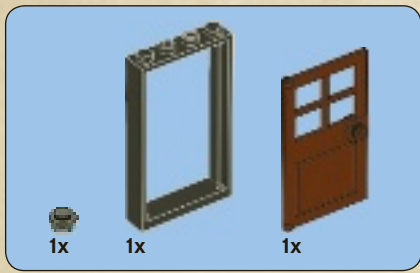

42

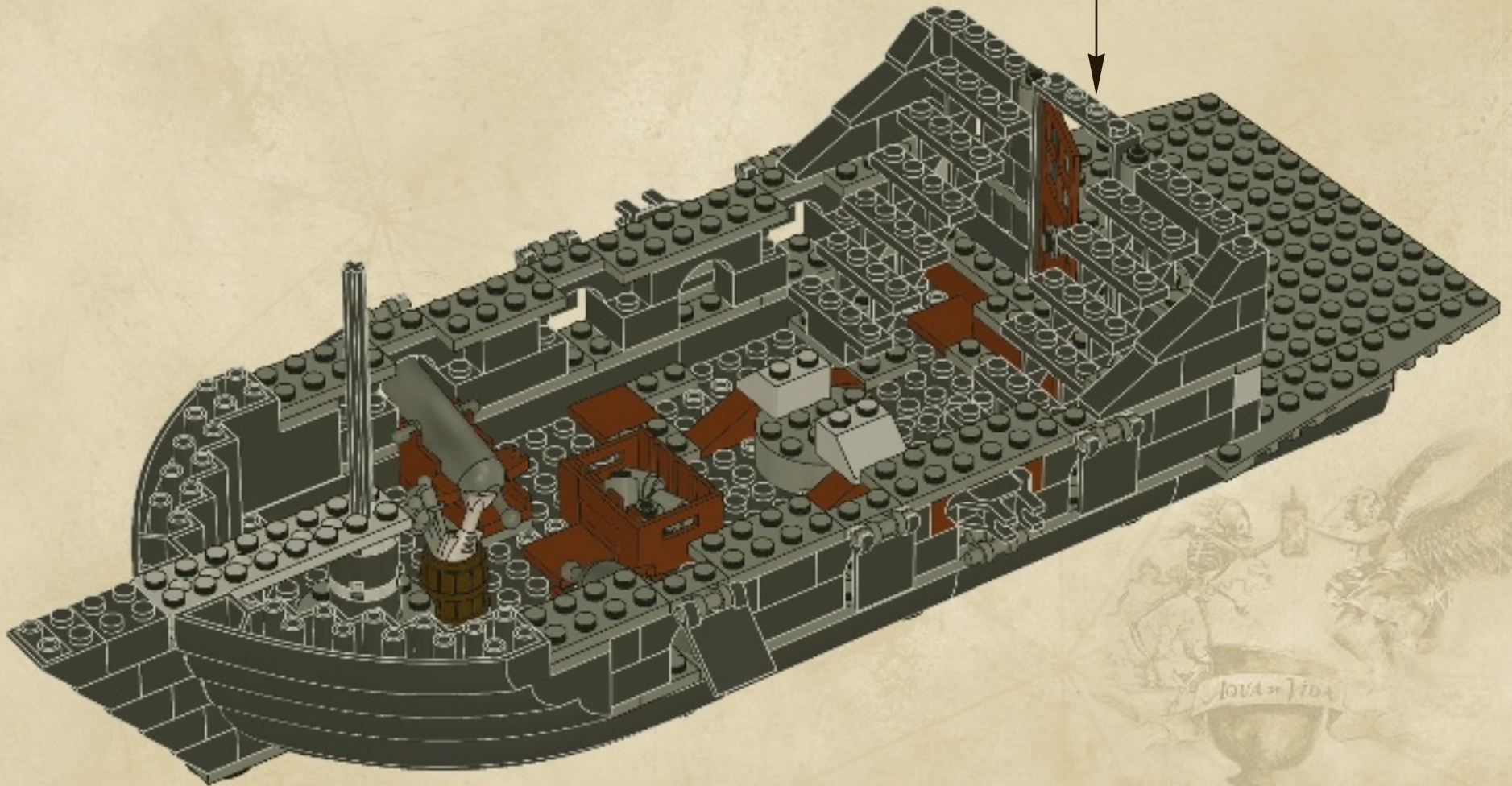
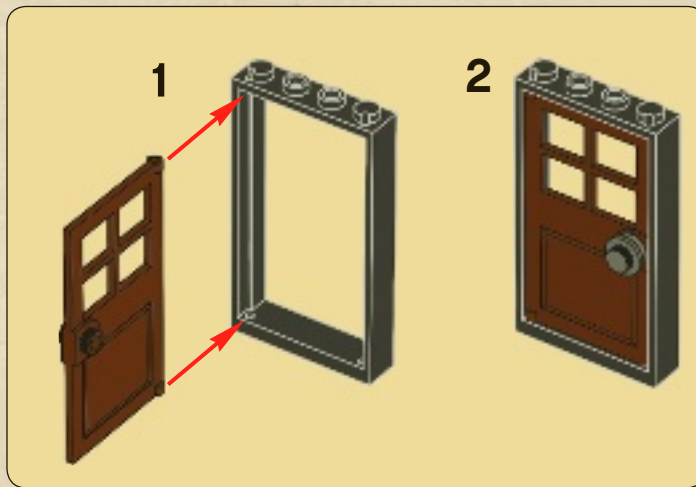

2x 4x 2x

43

2x

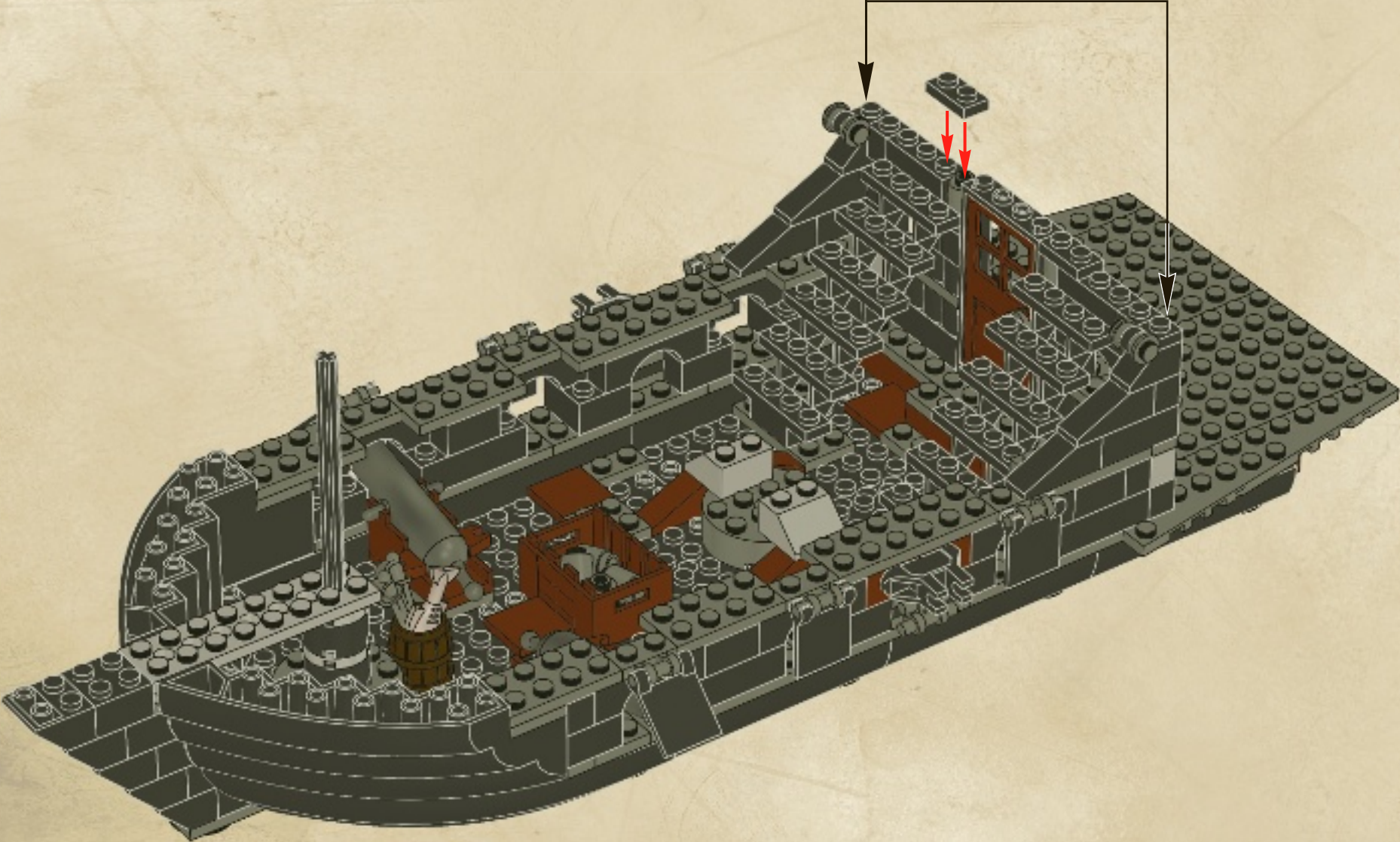



44

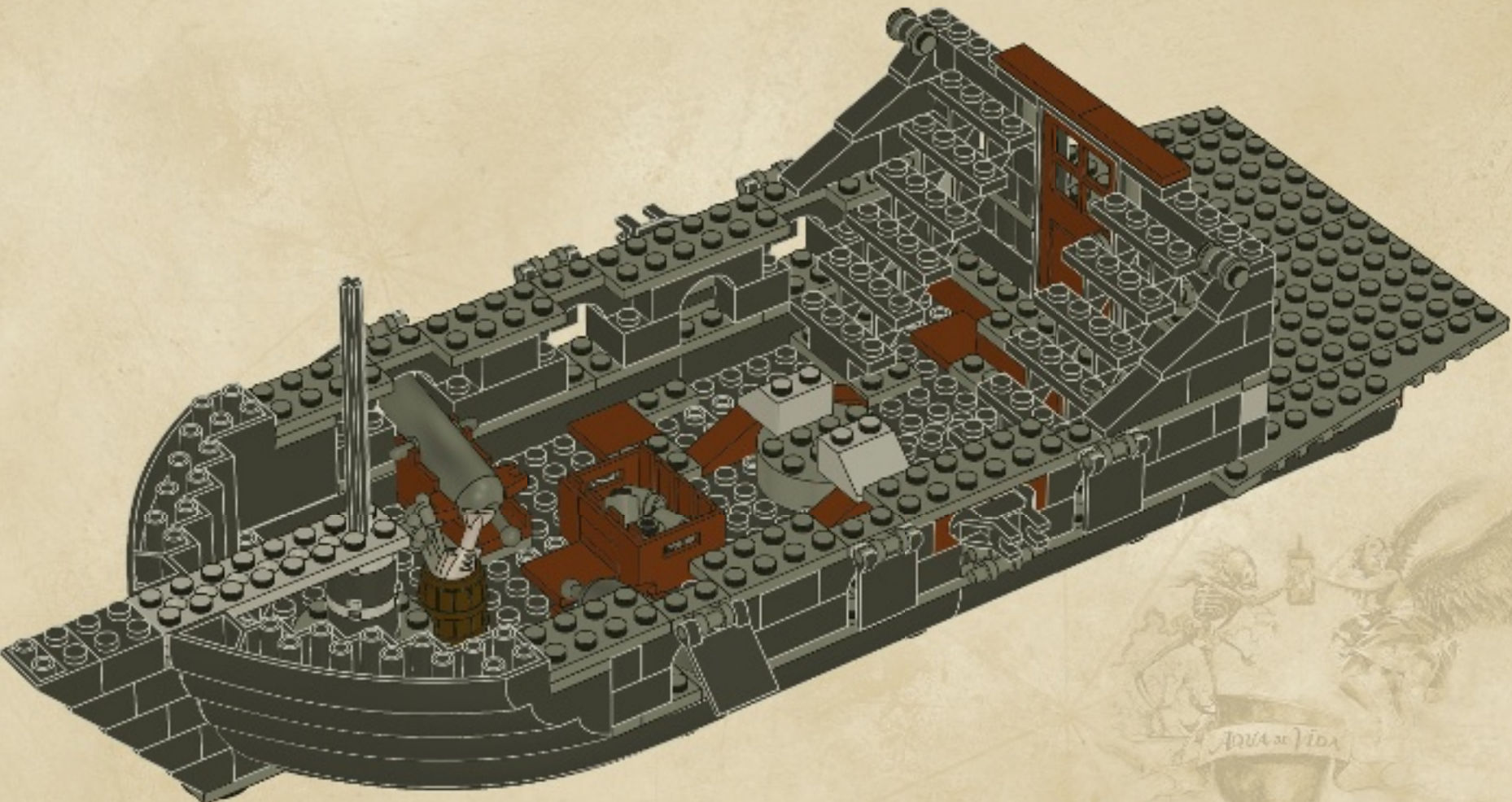



45

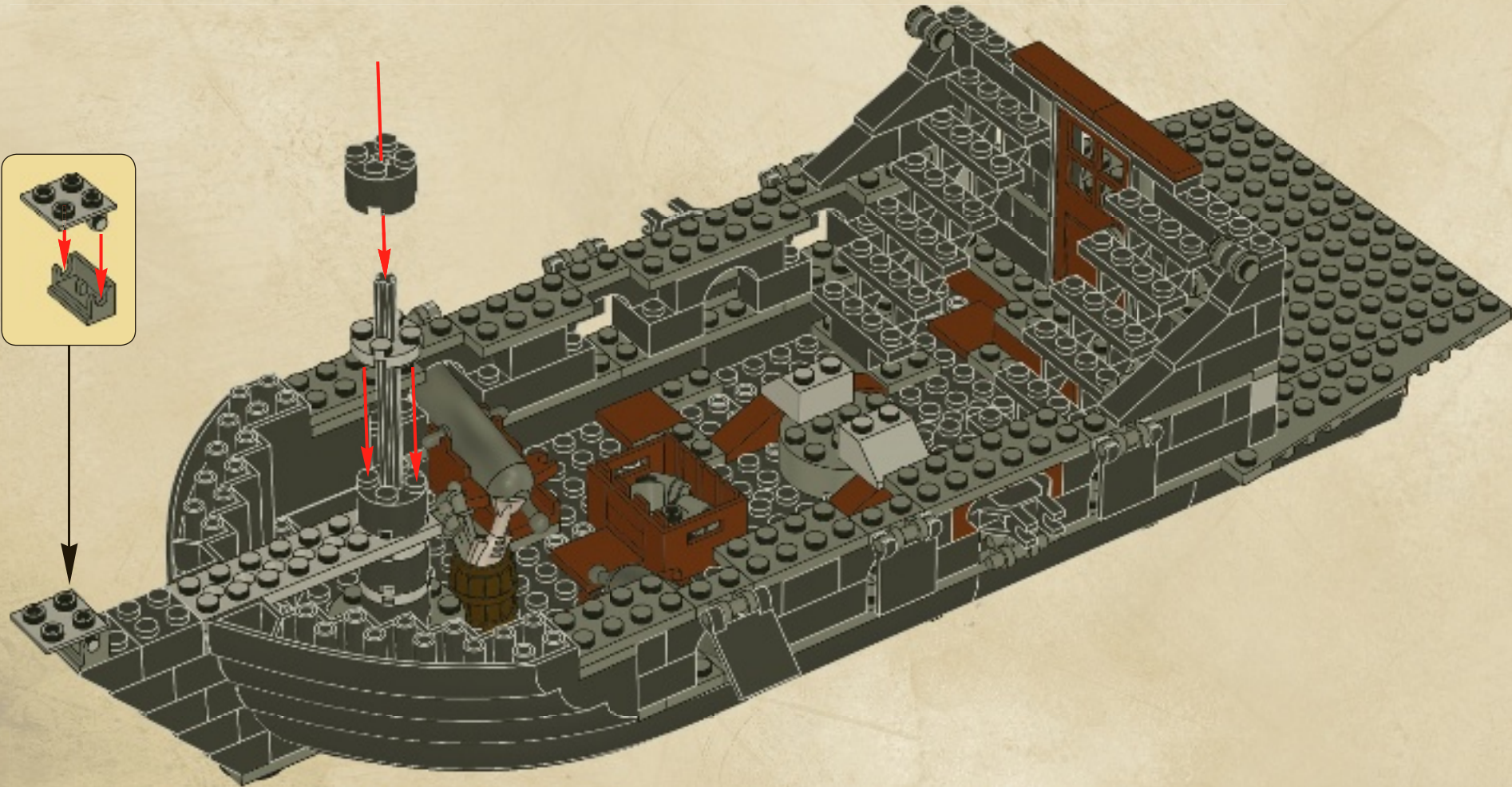



46

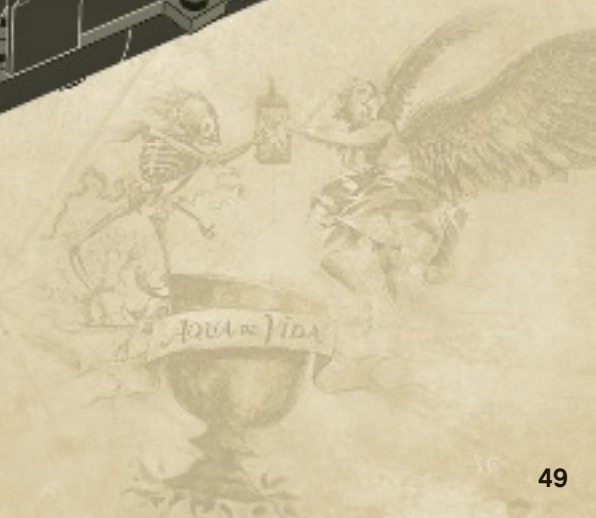
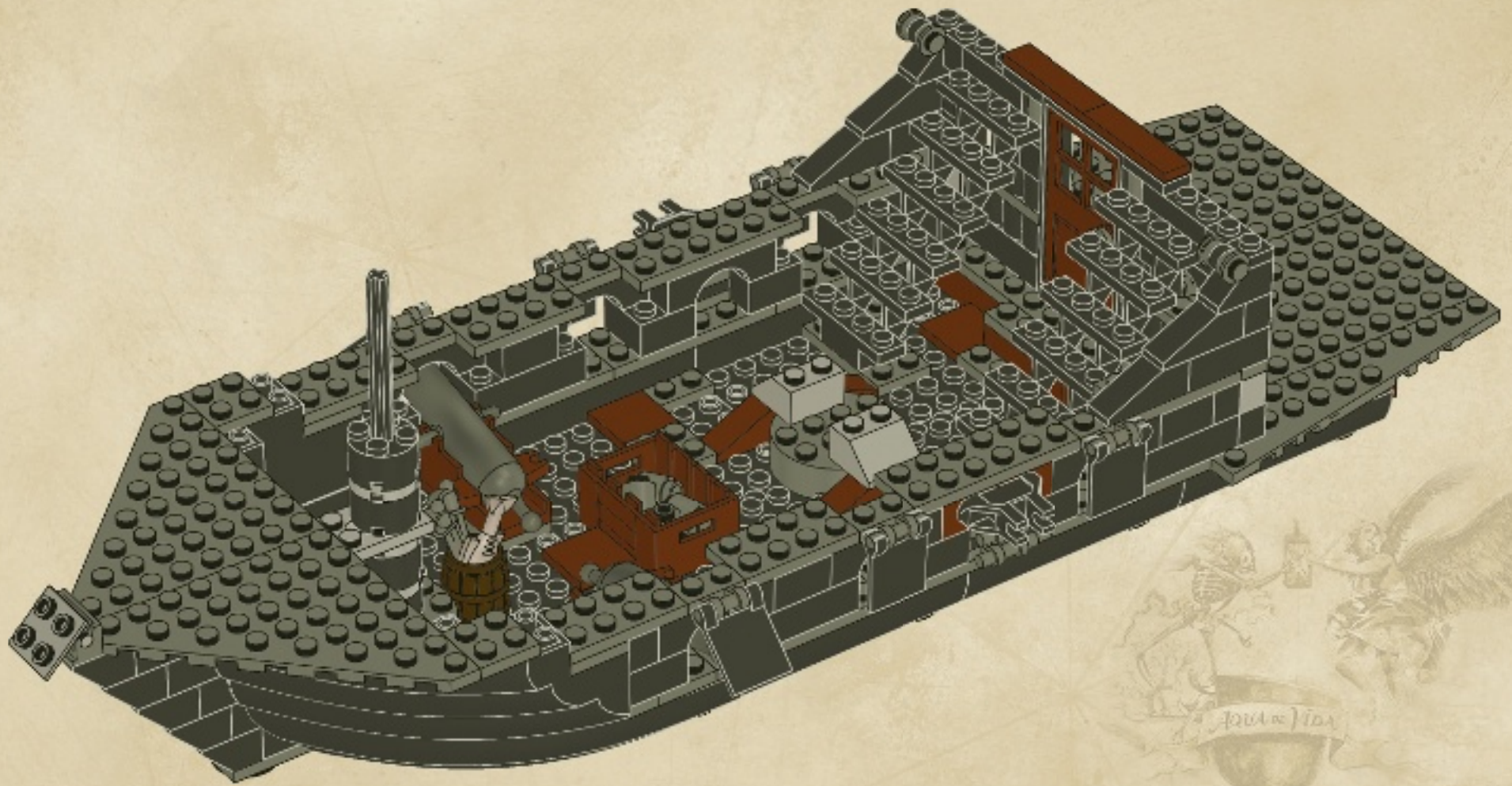



2x



4x



1x

47

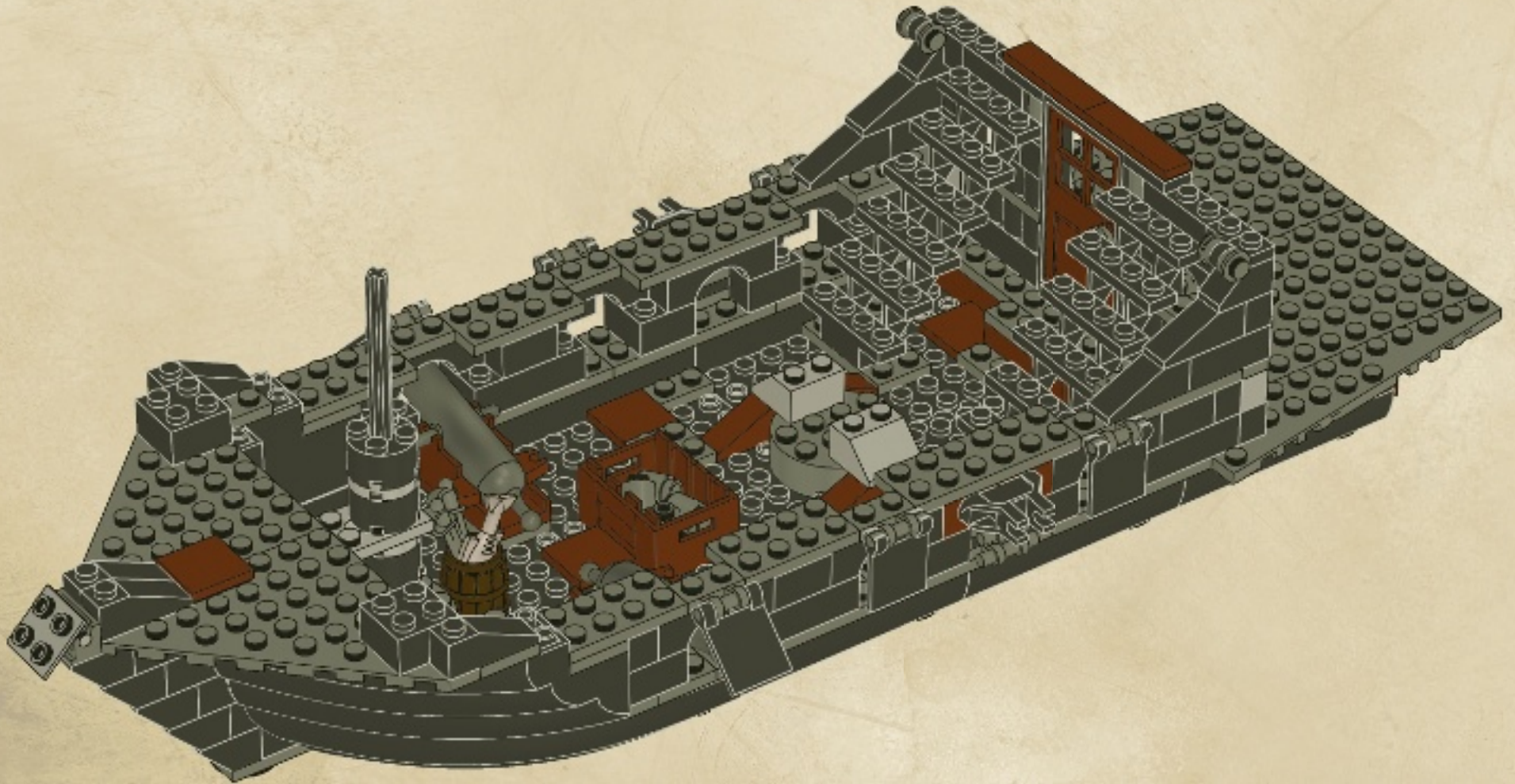



48

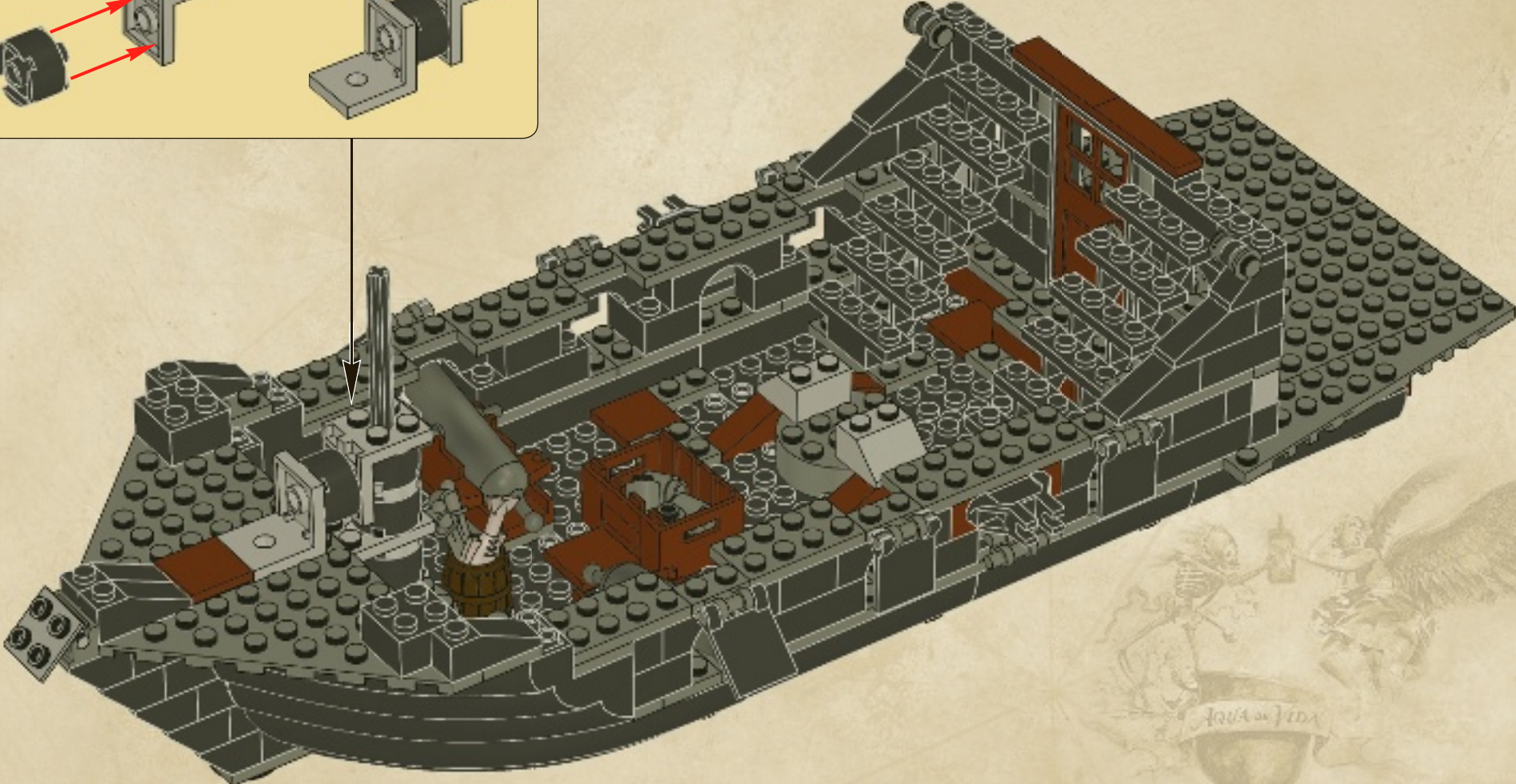
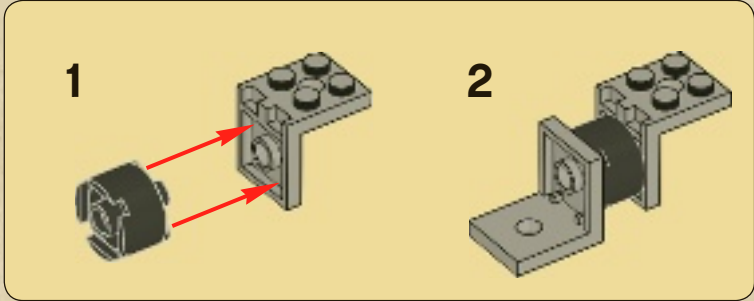

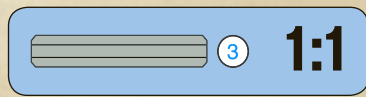
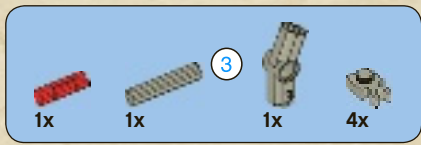

49

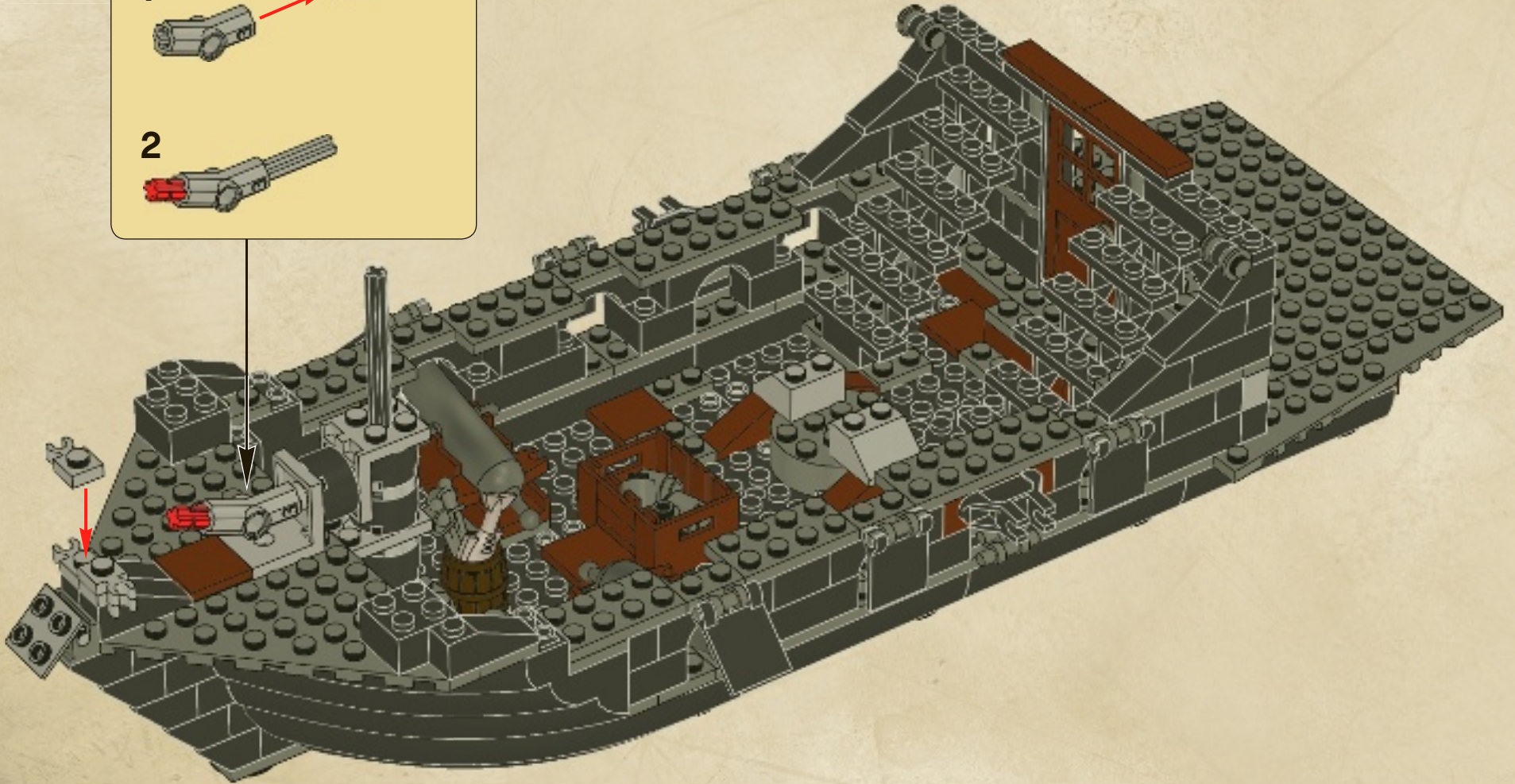
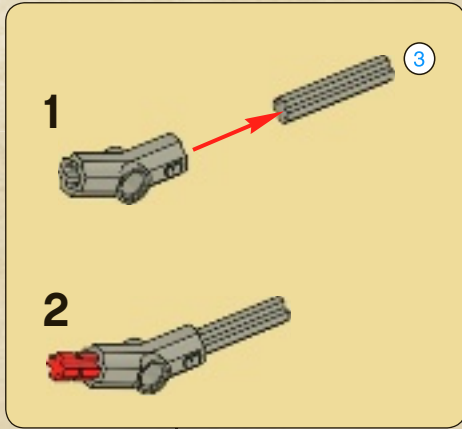

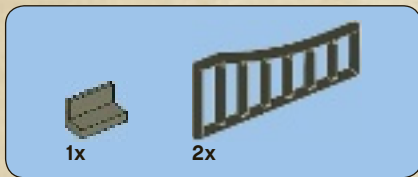

50

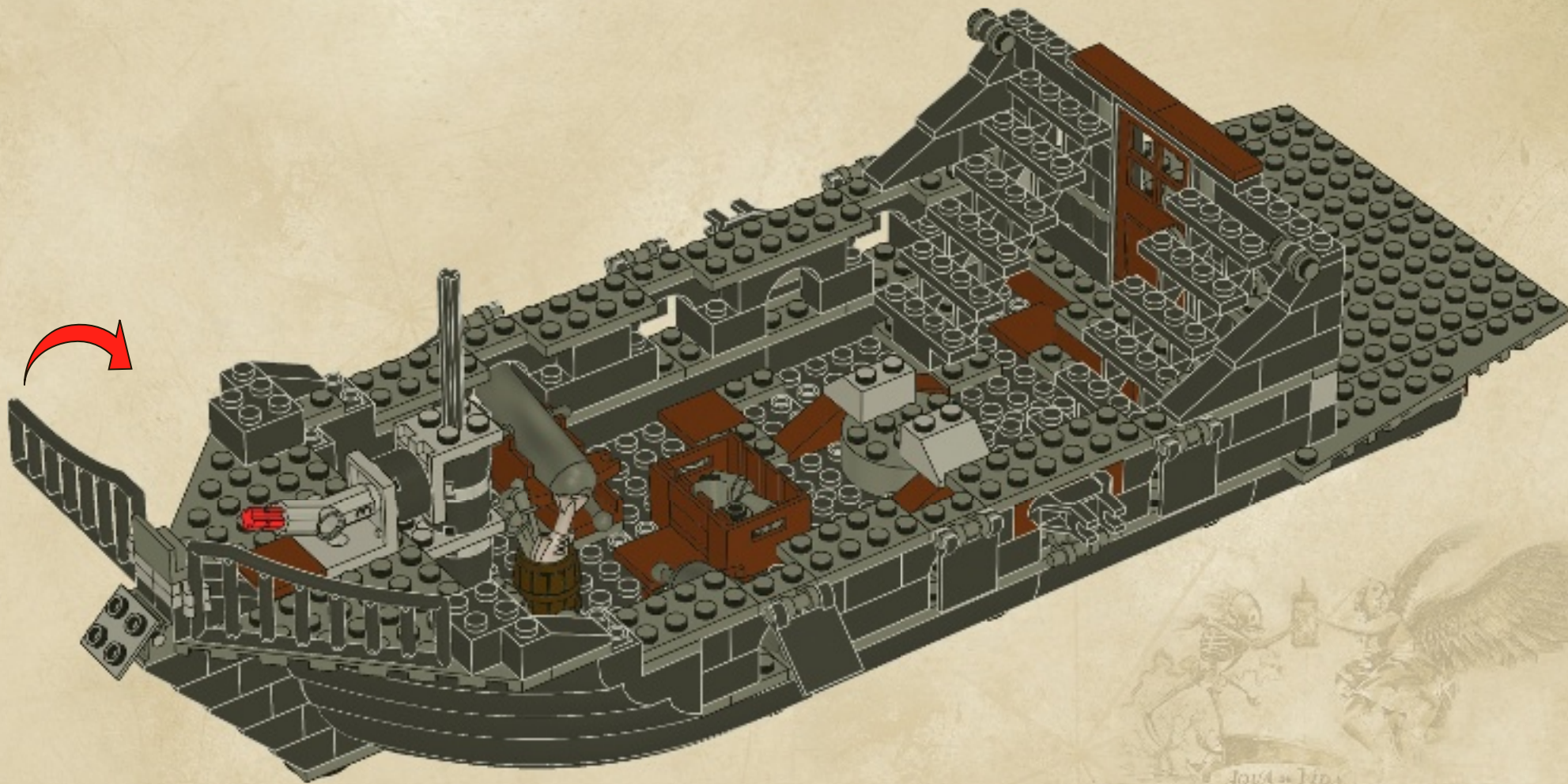

4x

4x

51

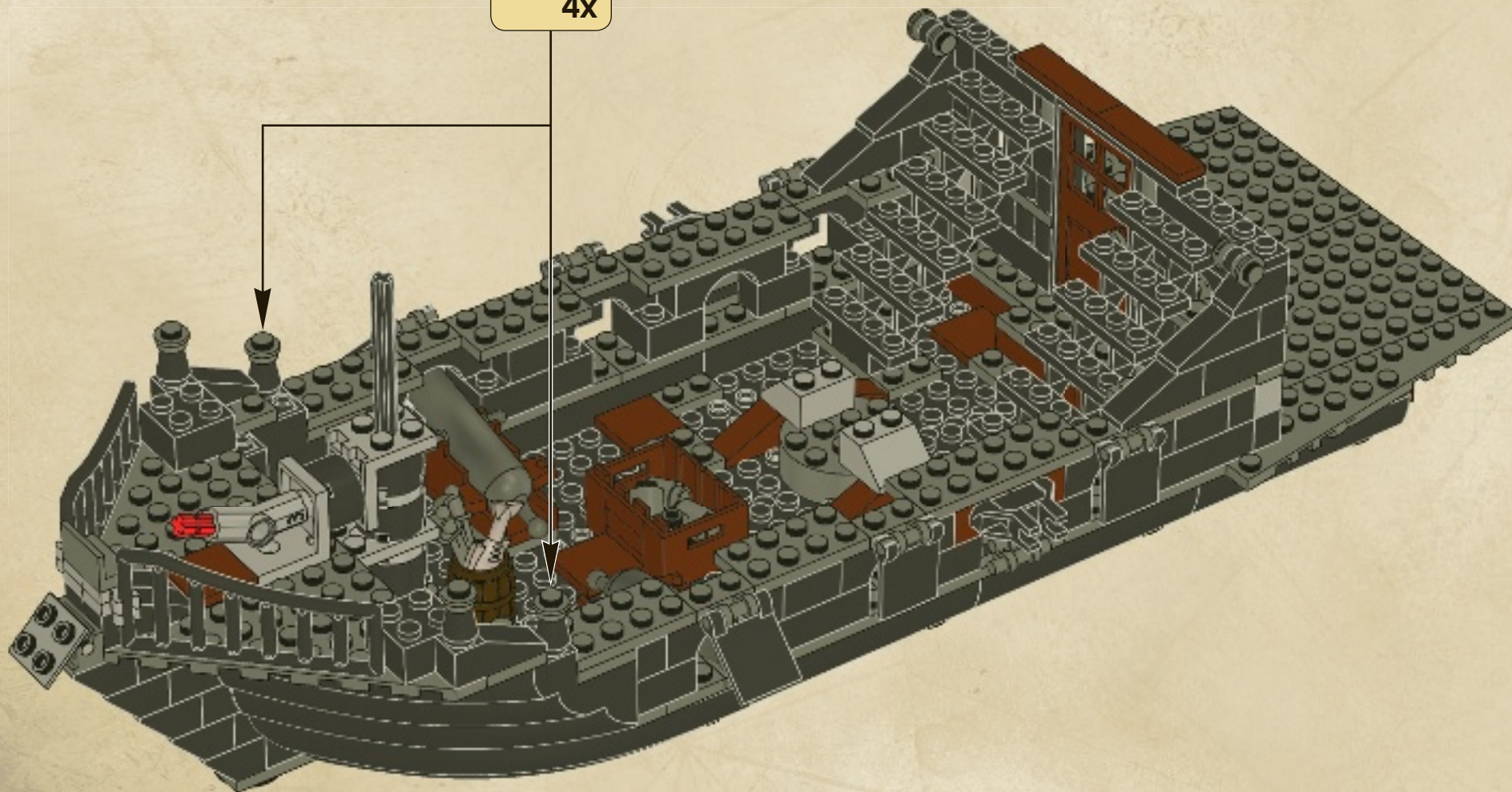
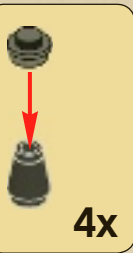

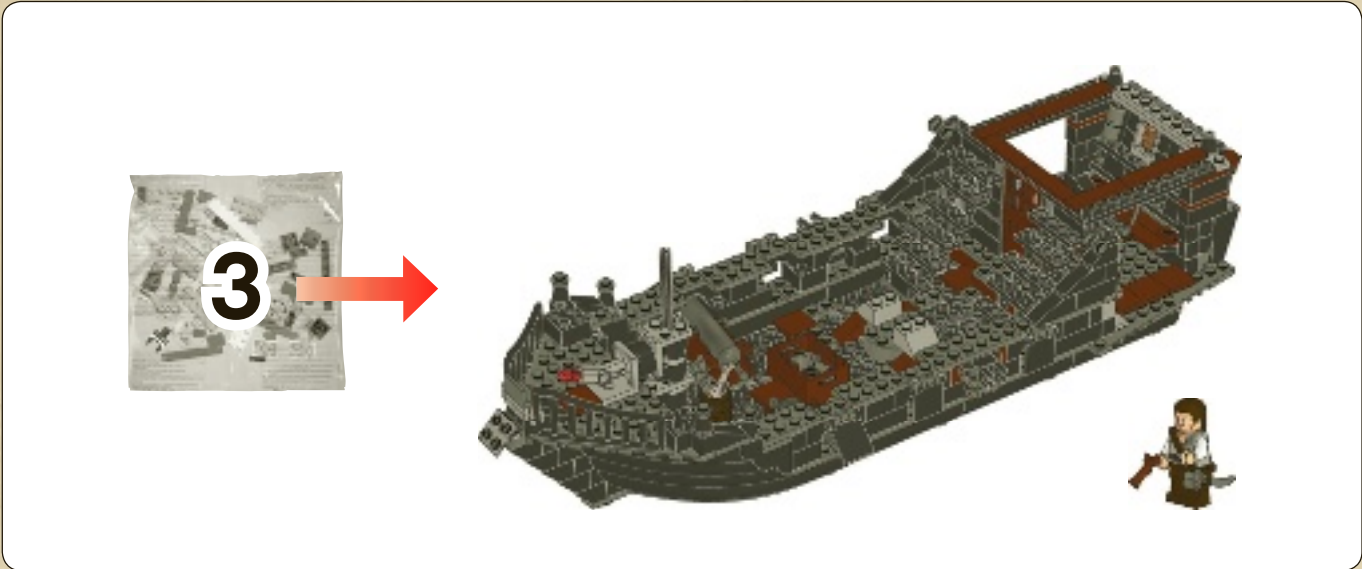

2x 6x 2x

52

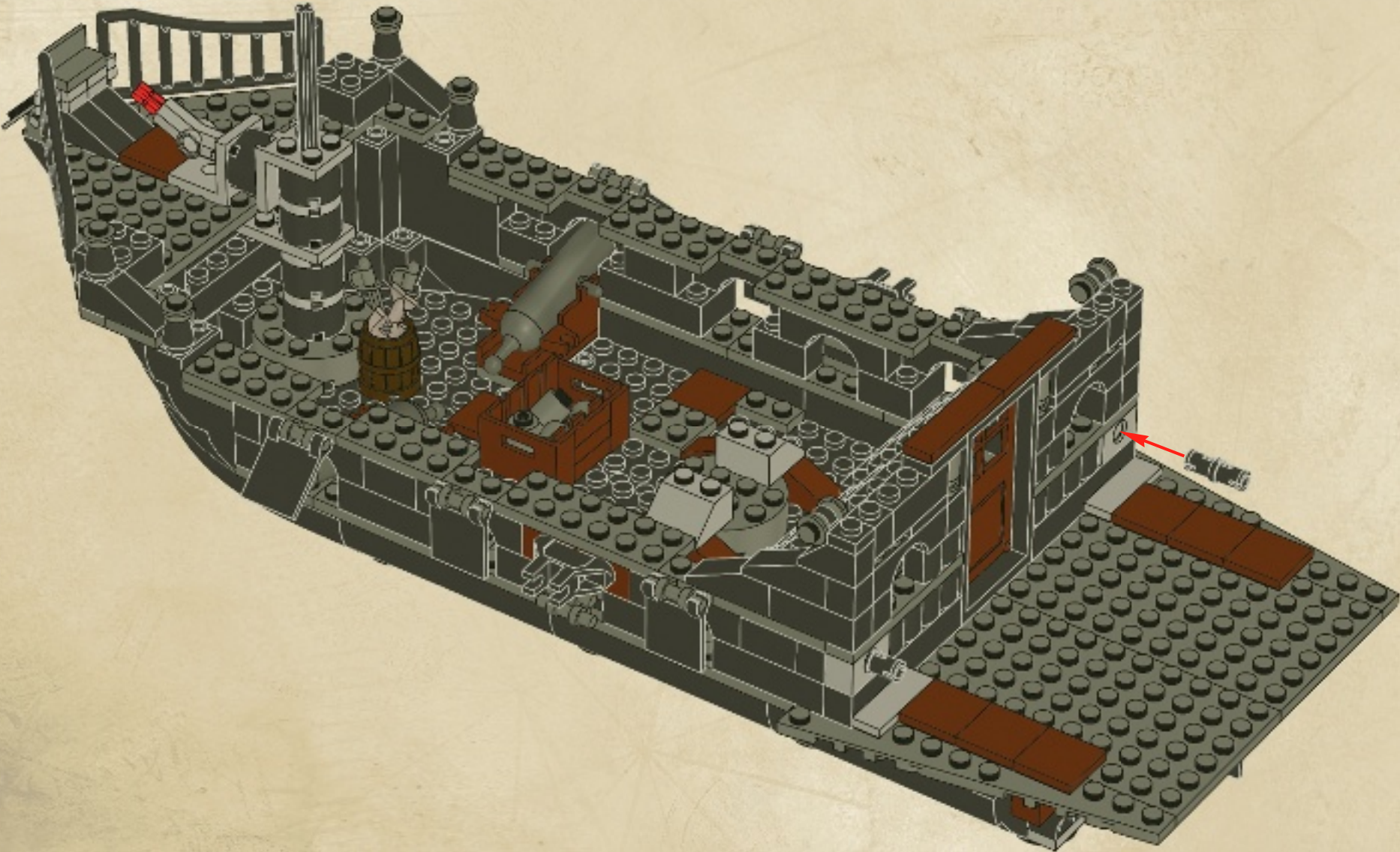

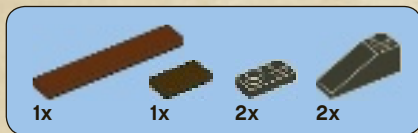

53

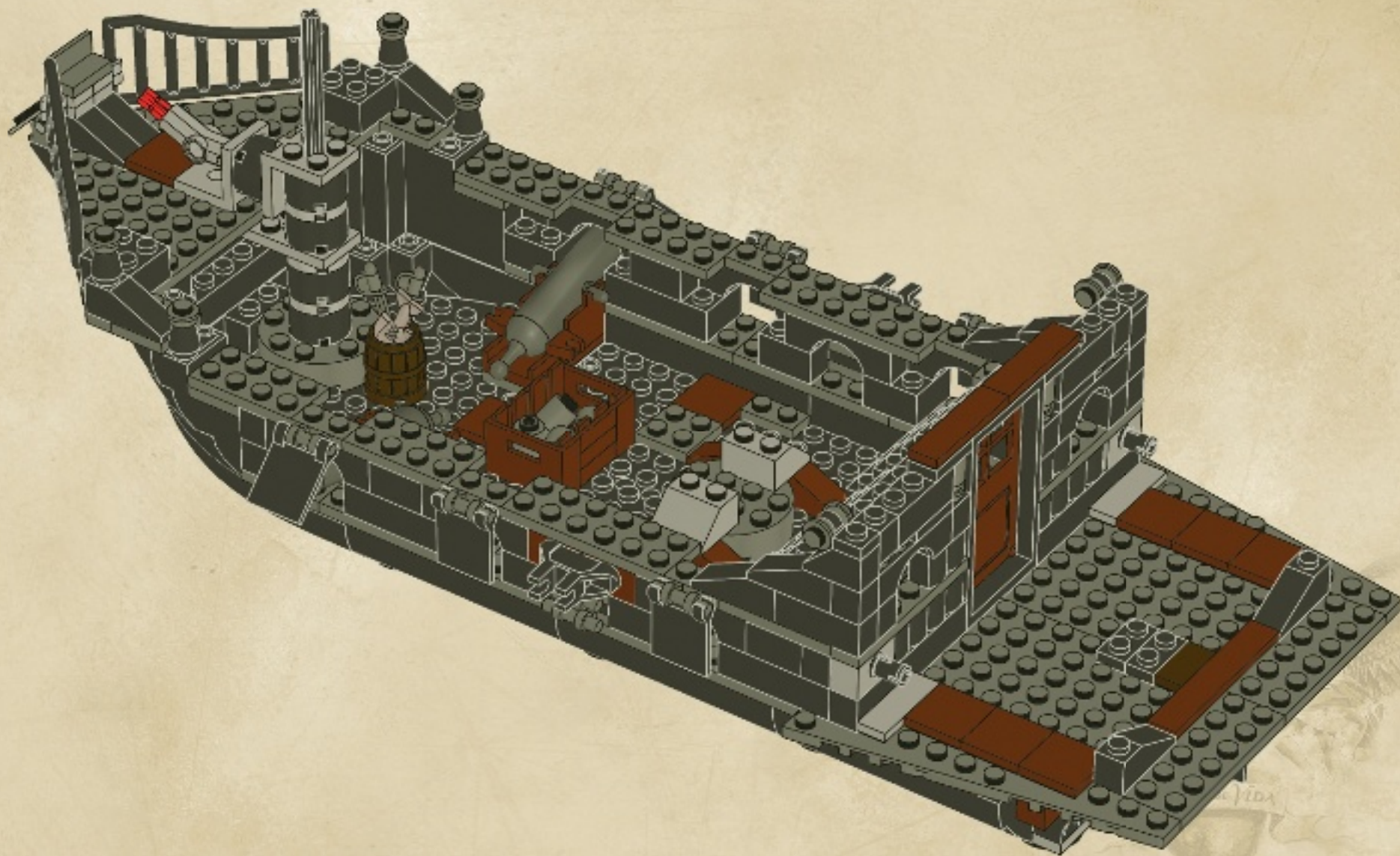

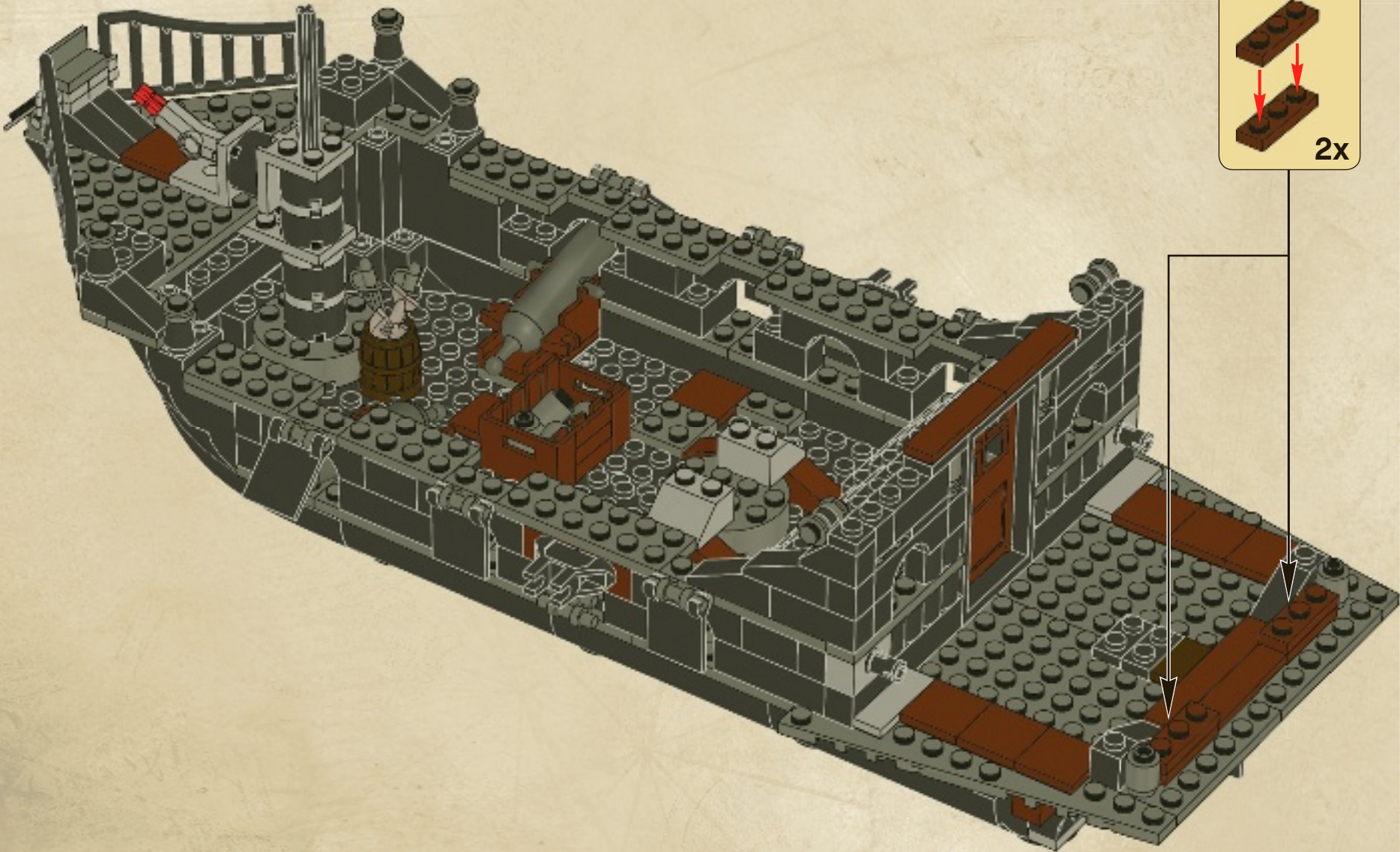

2x 4x 1x

54



2x

2x  3x 

55

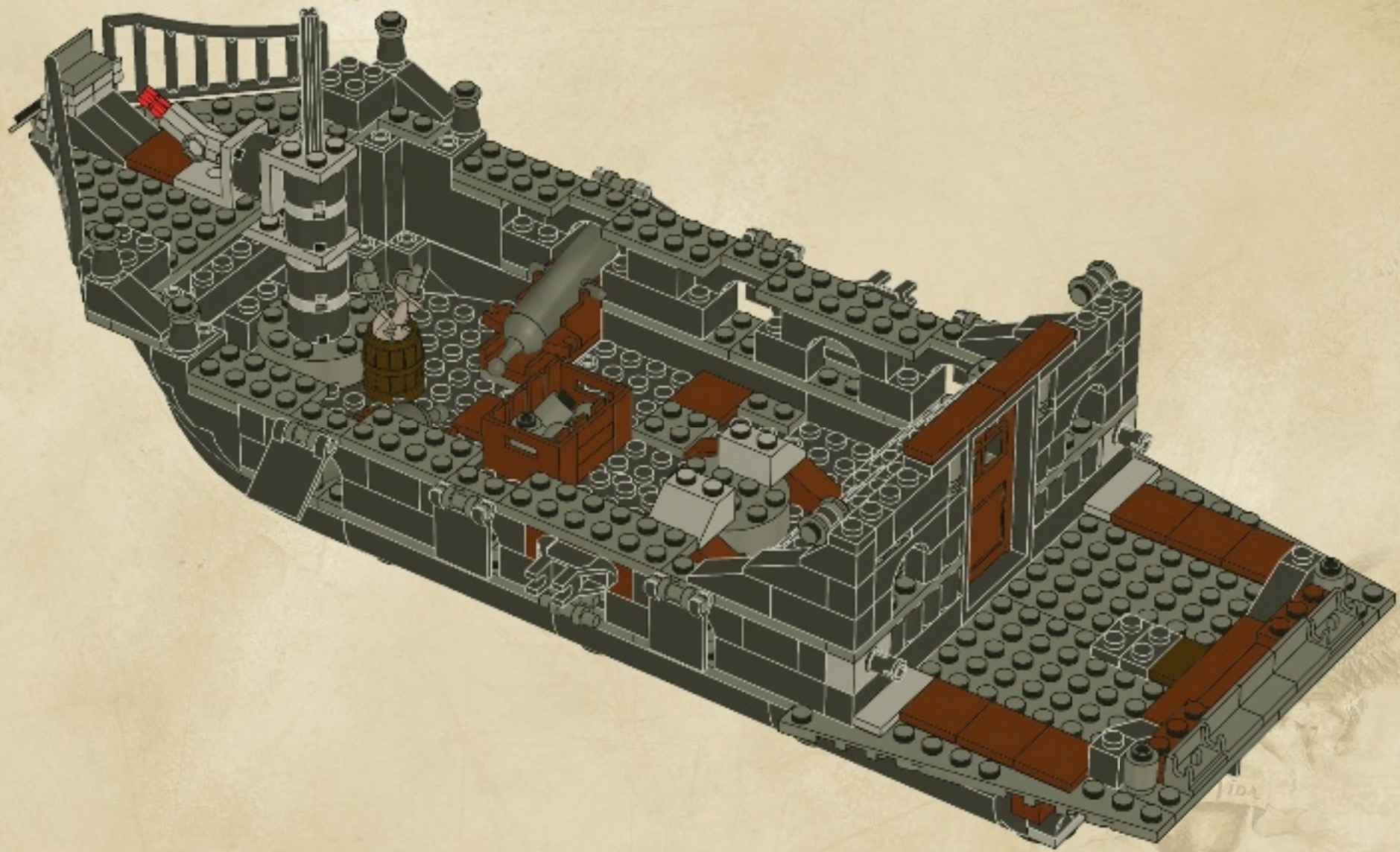

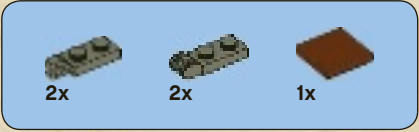

56

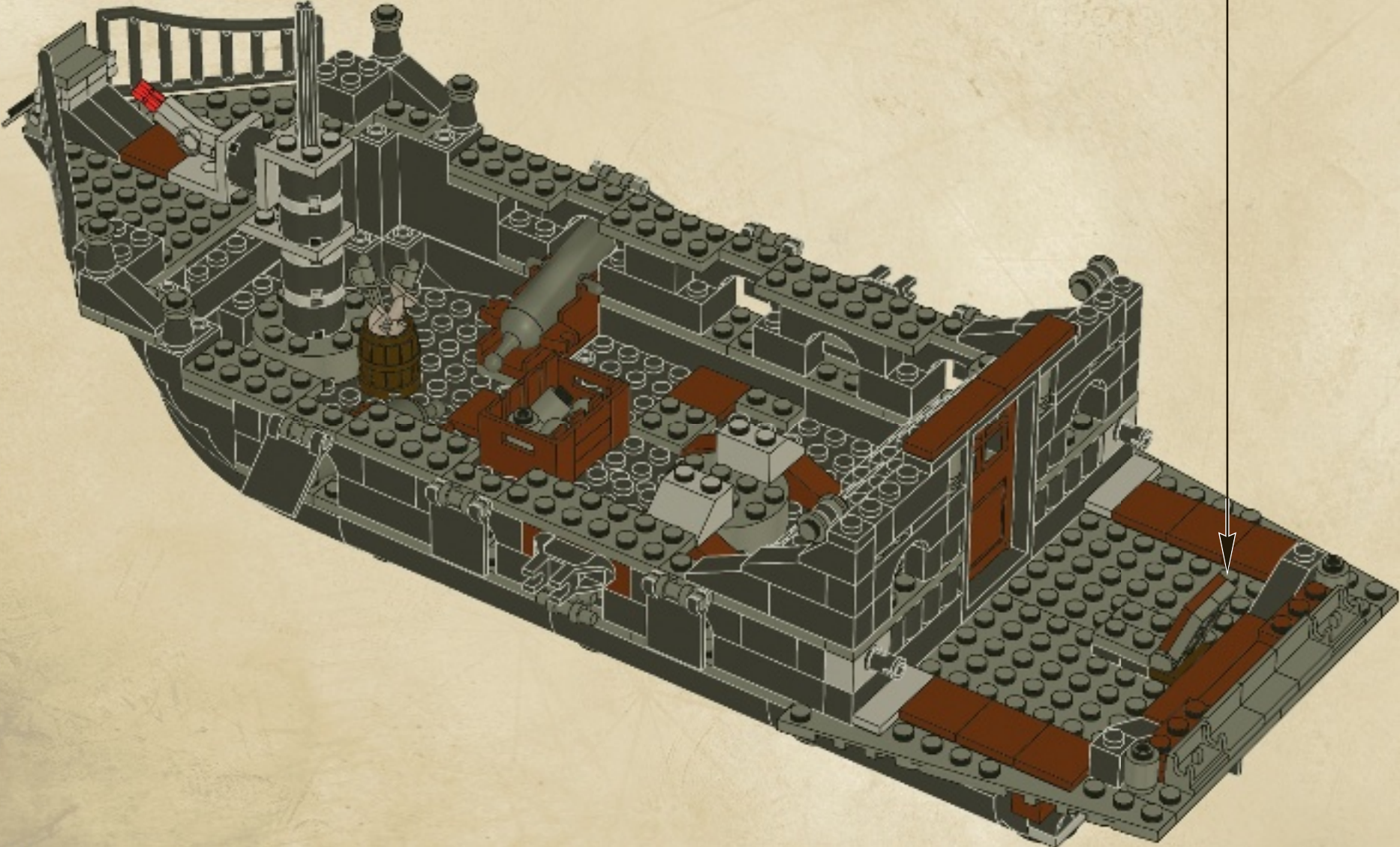
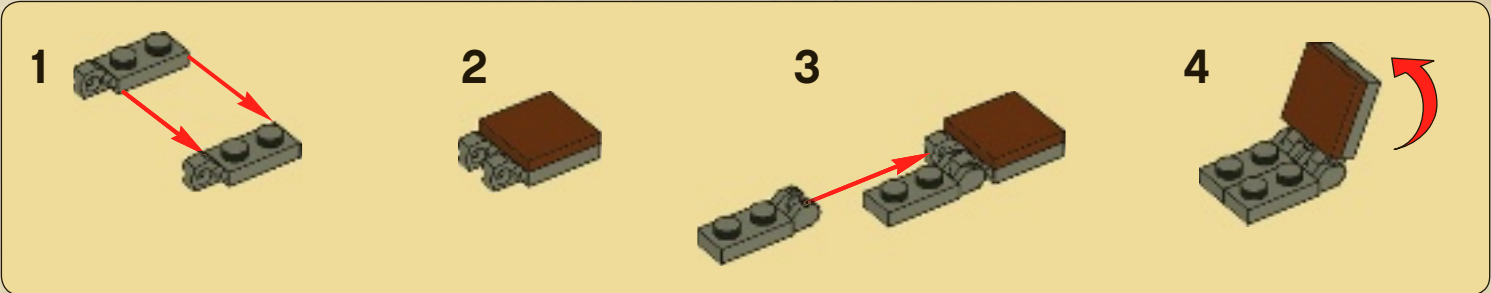



57

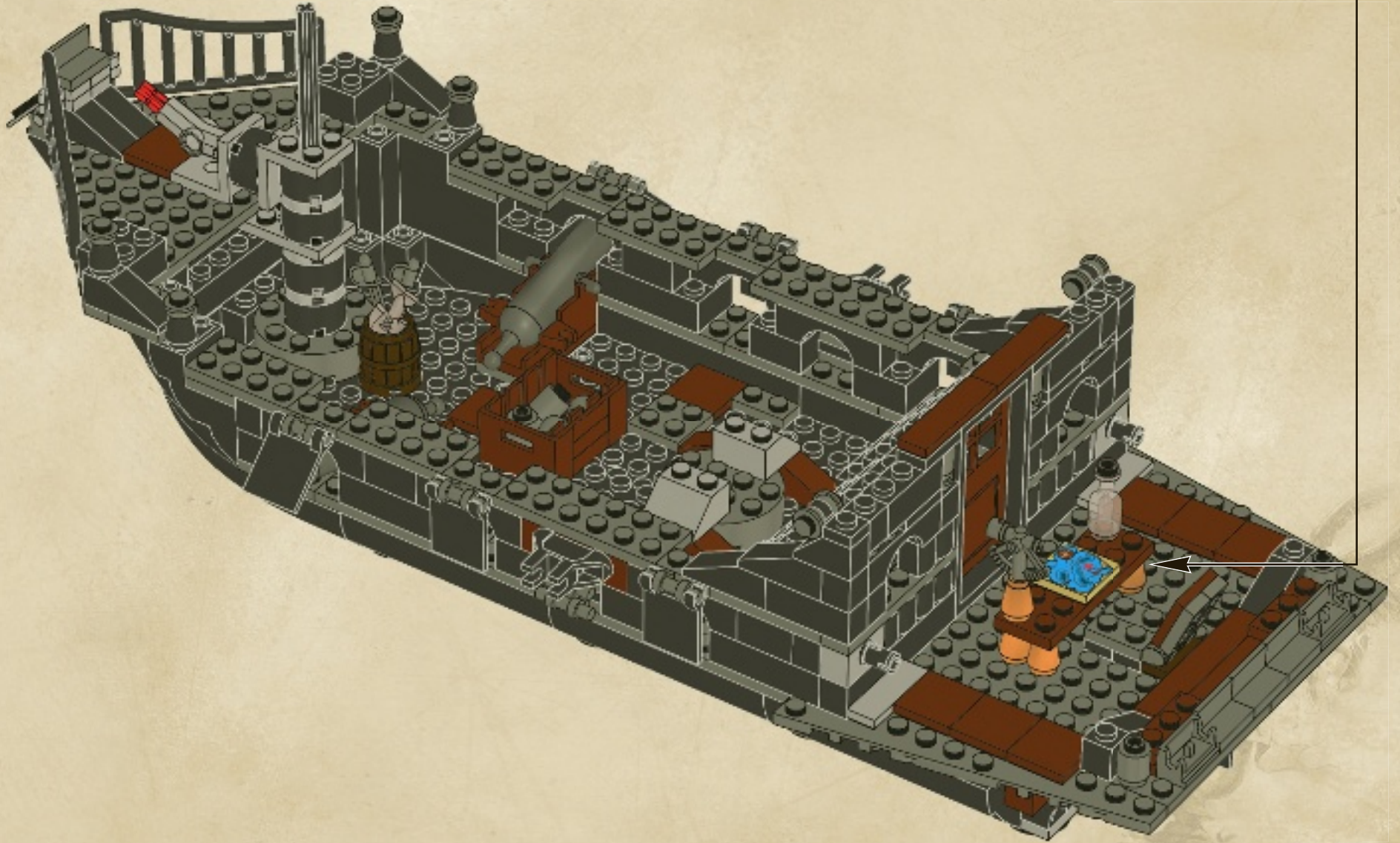
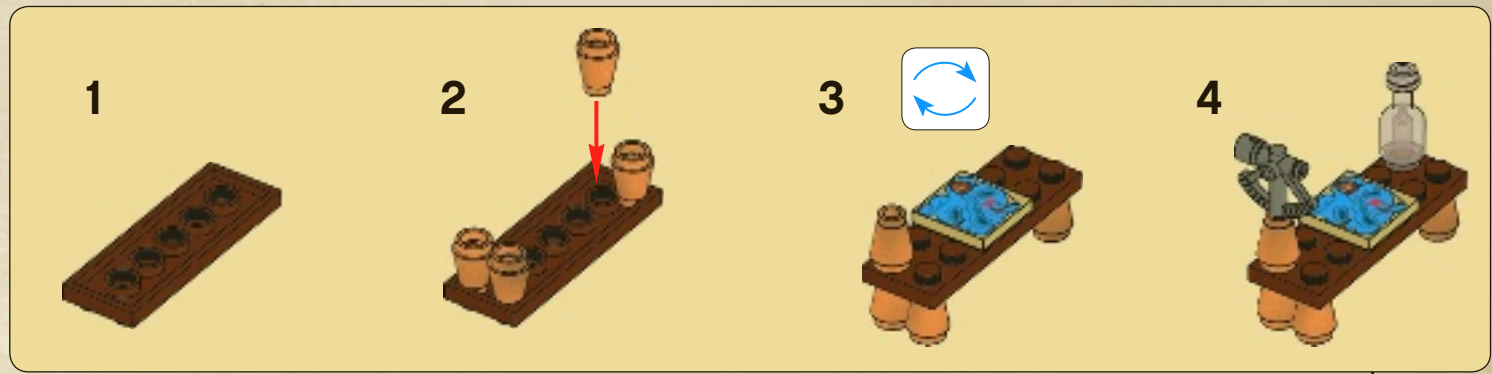

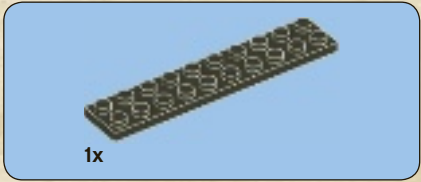

1x

1

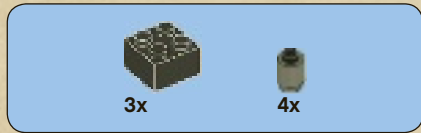

3x

4x

2

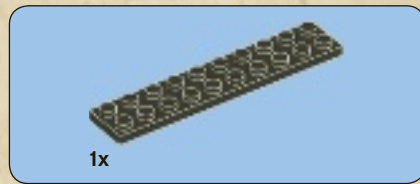
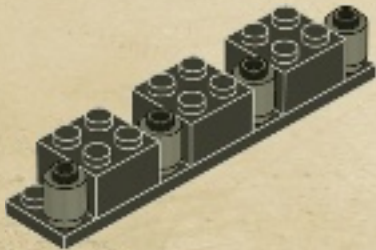

1x

3

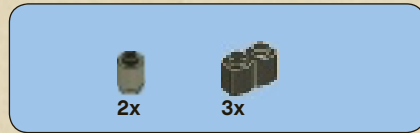
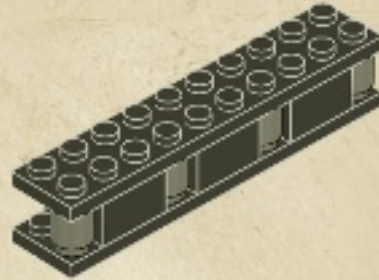

2x

3x

4

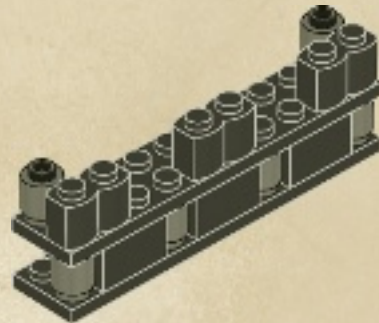

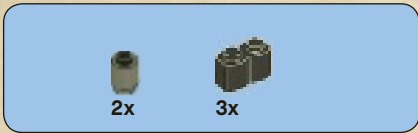

5

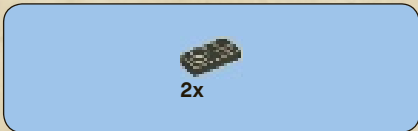
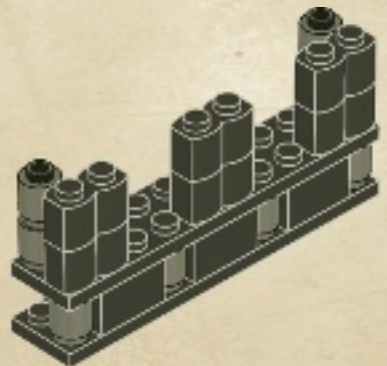

6

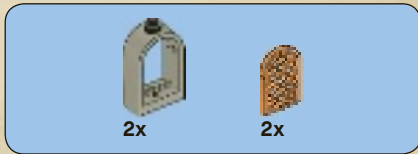
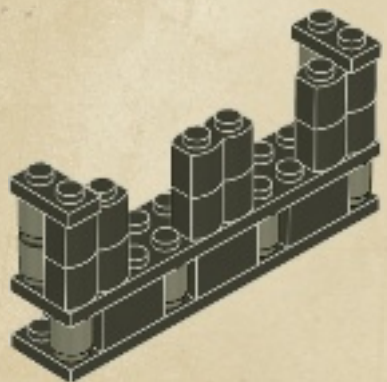

7

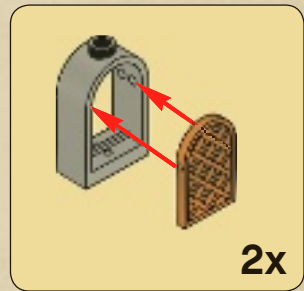

2x

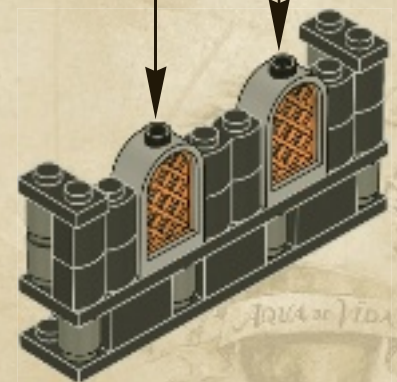

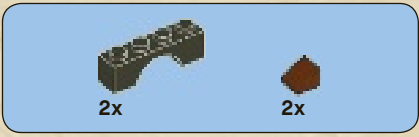

8

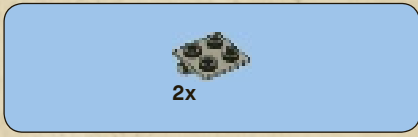

9

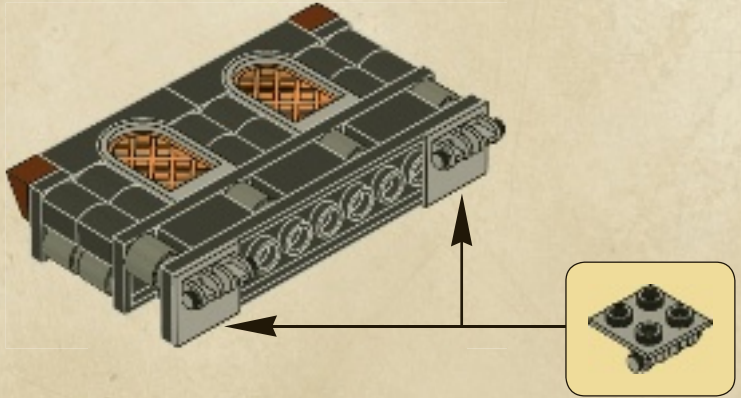

58

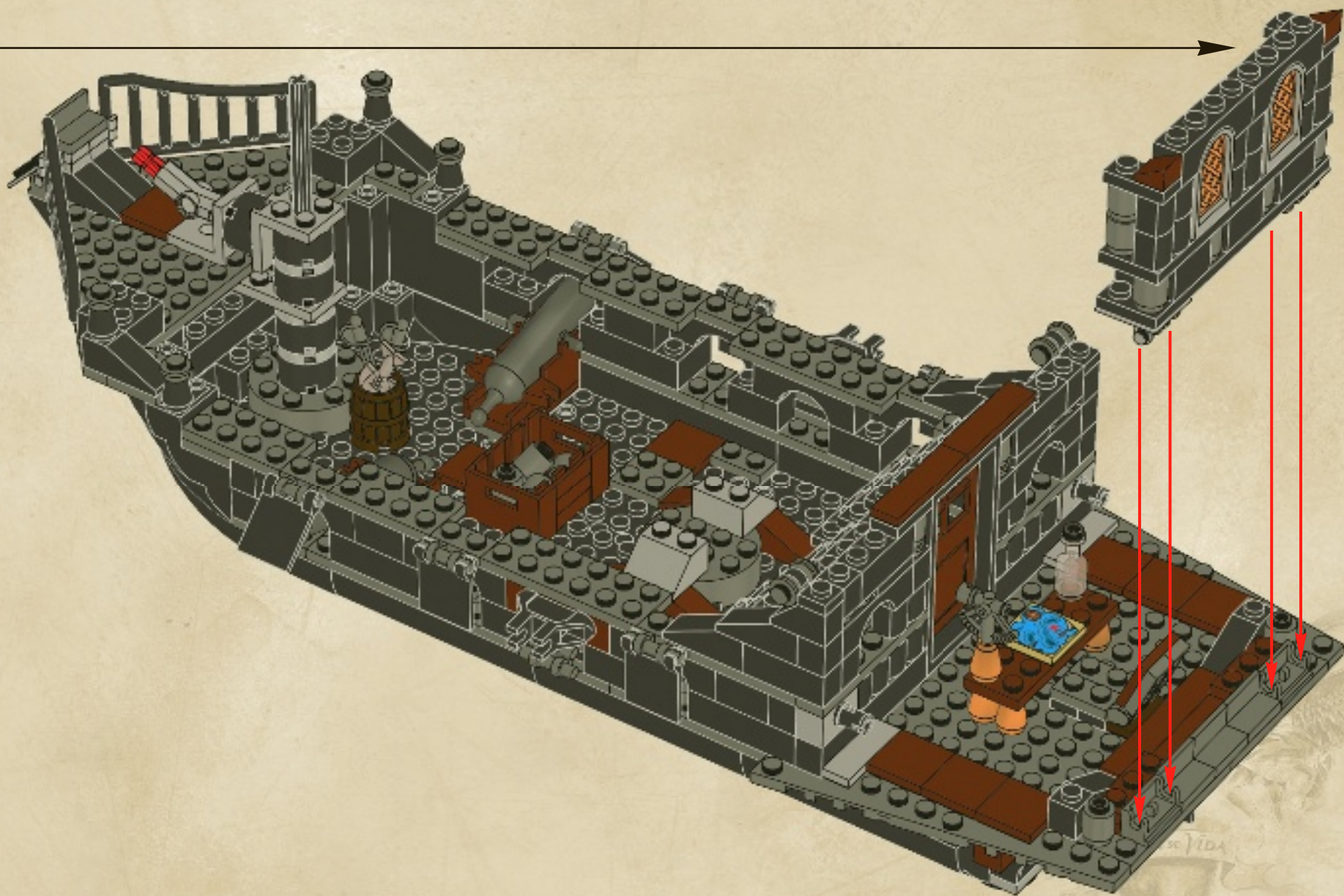

59

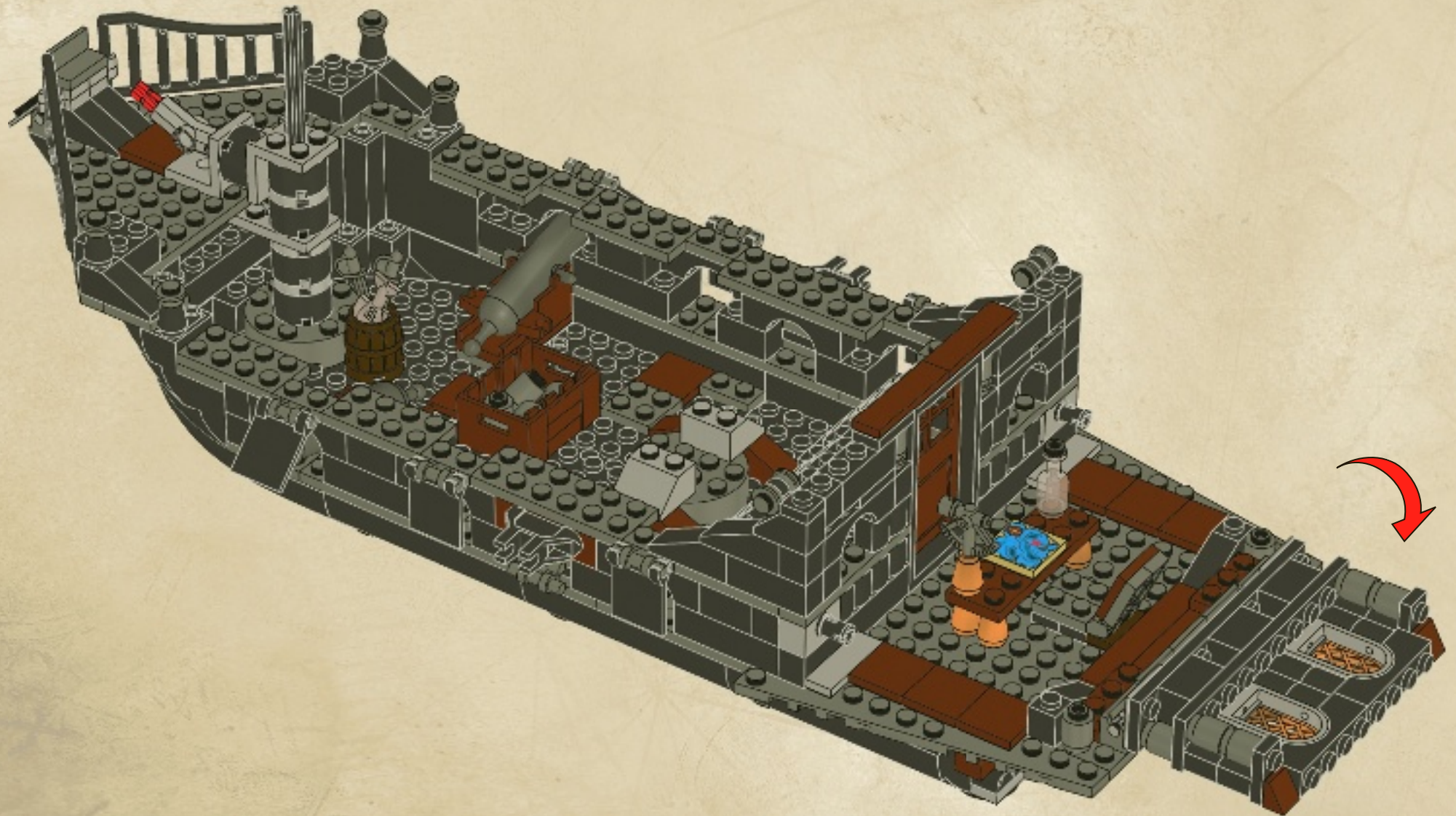

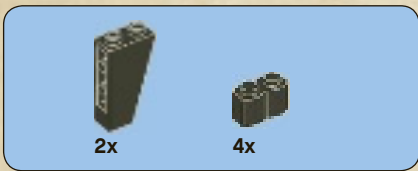

60

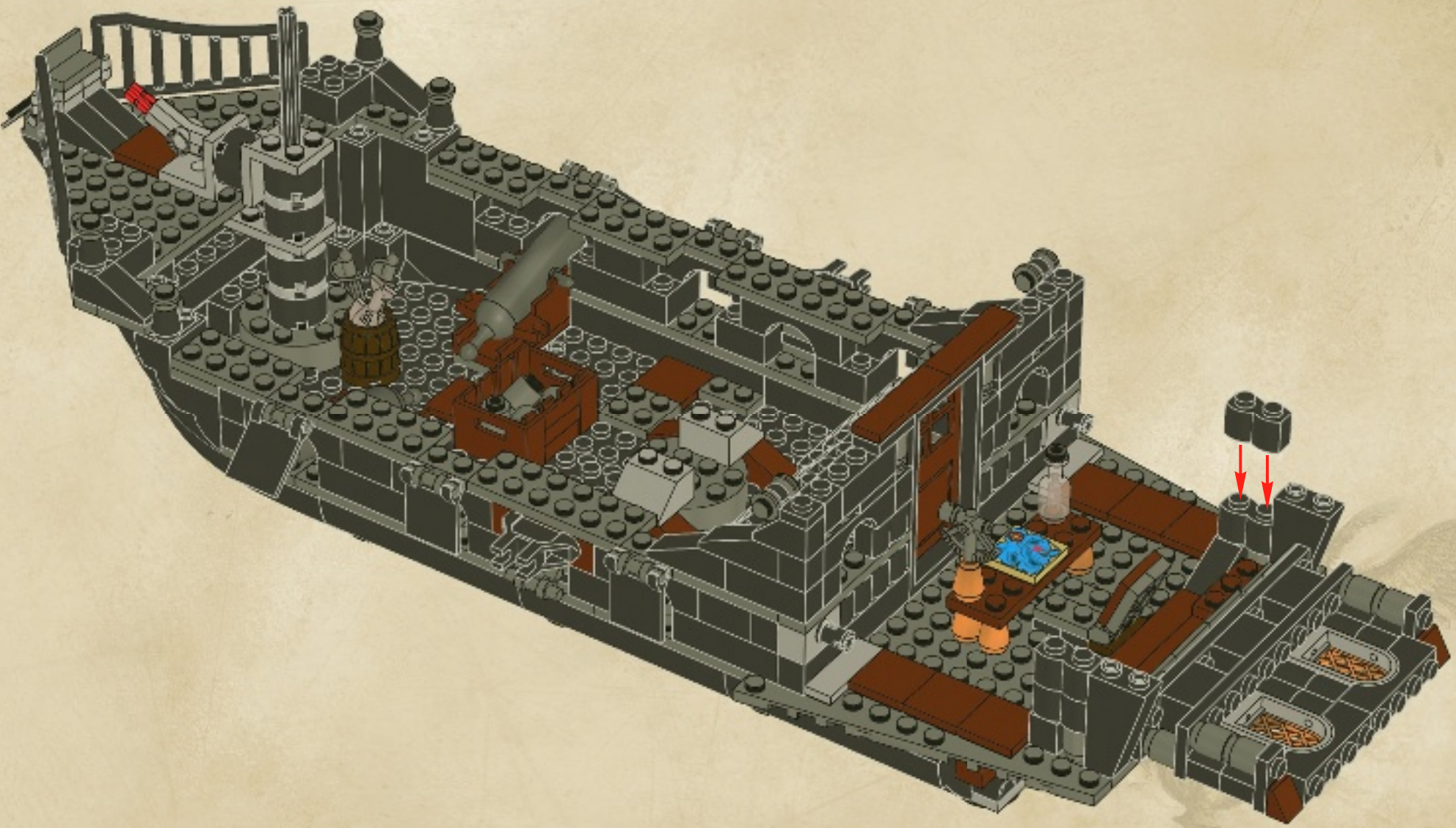



61

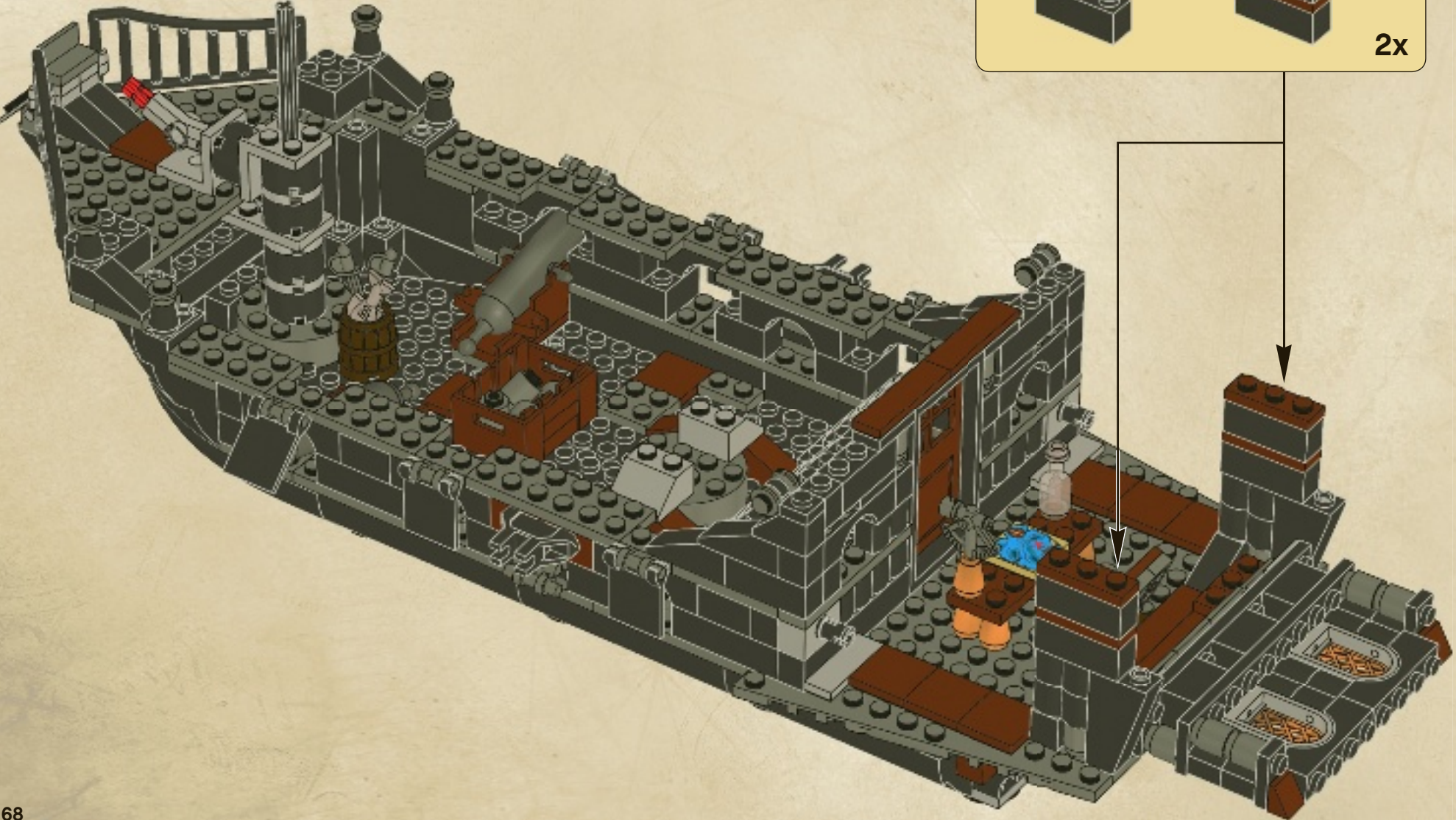
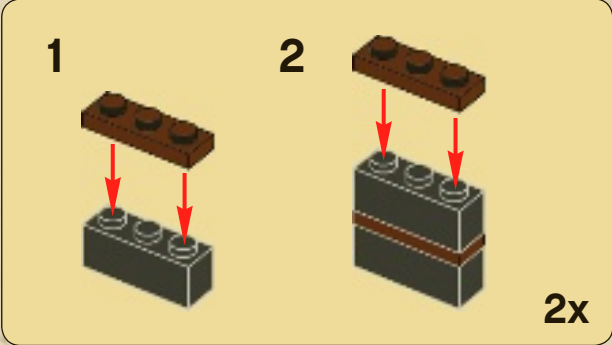

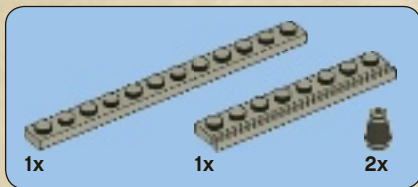

62

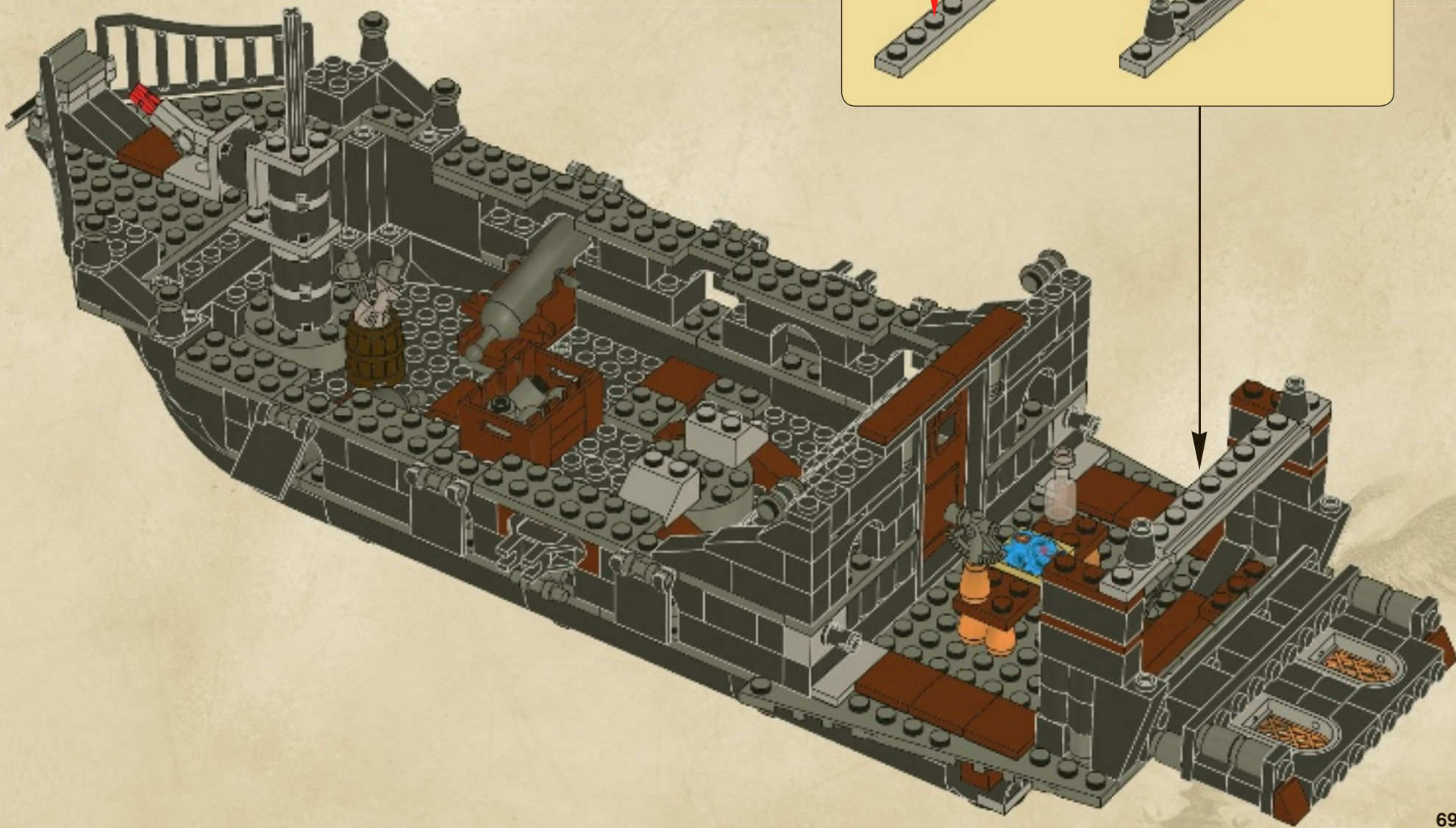
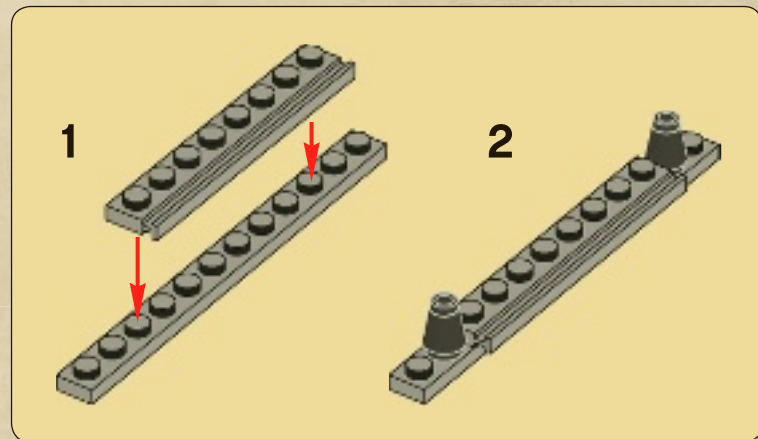

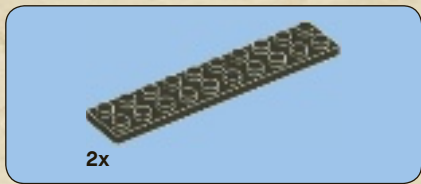

63

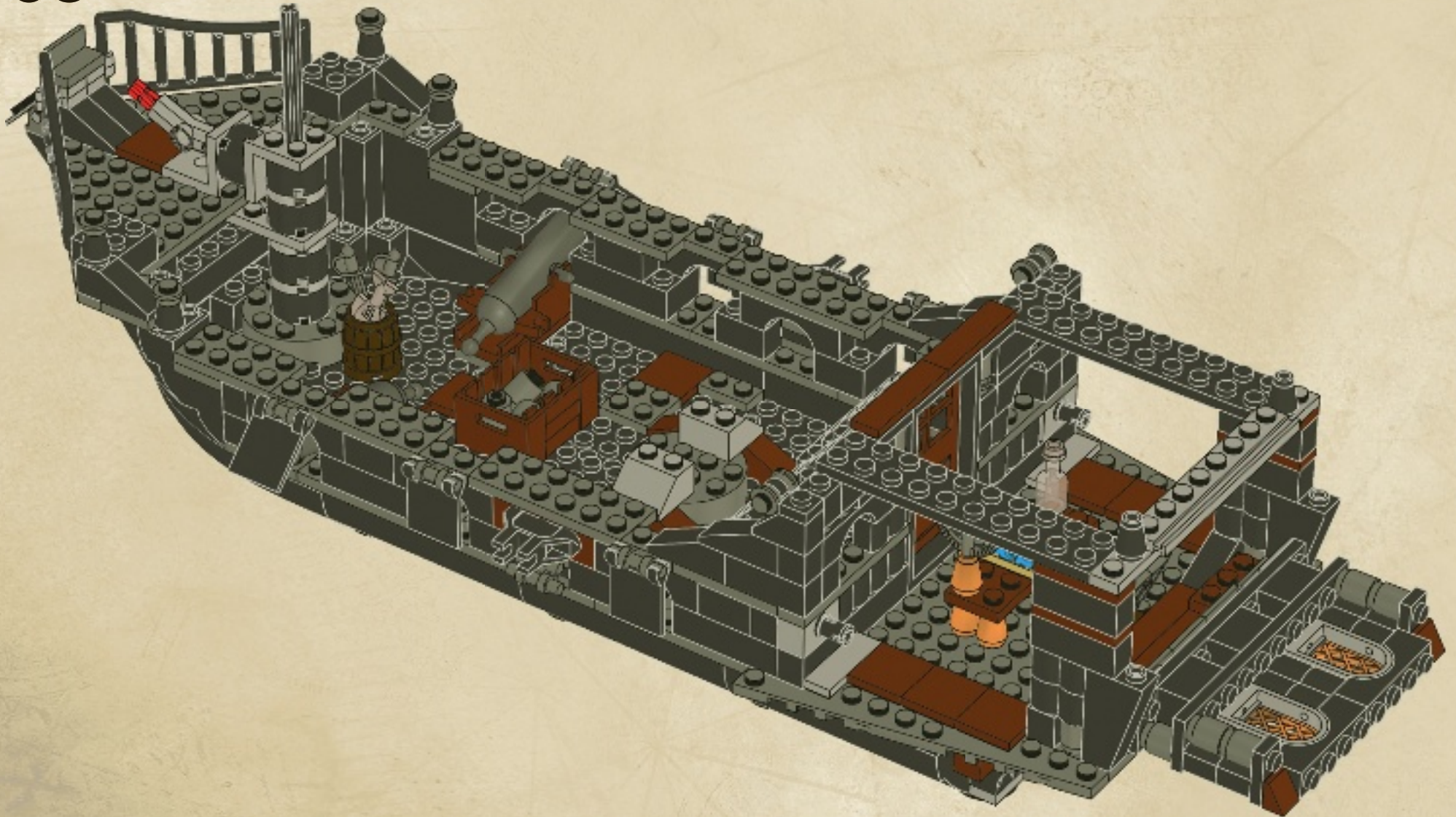

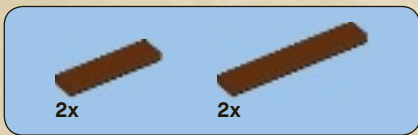

64

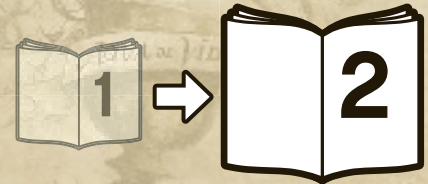
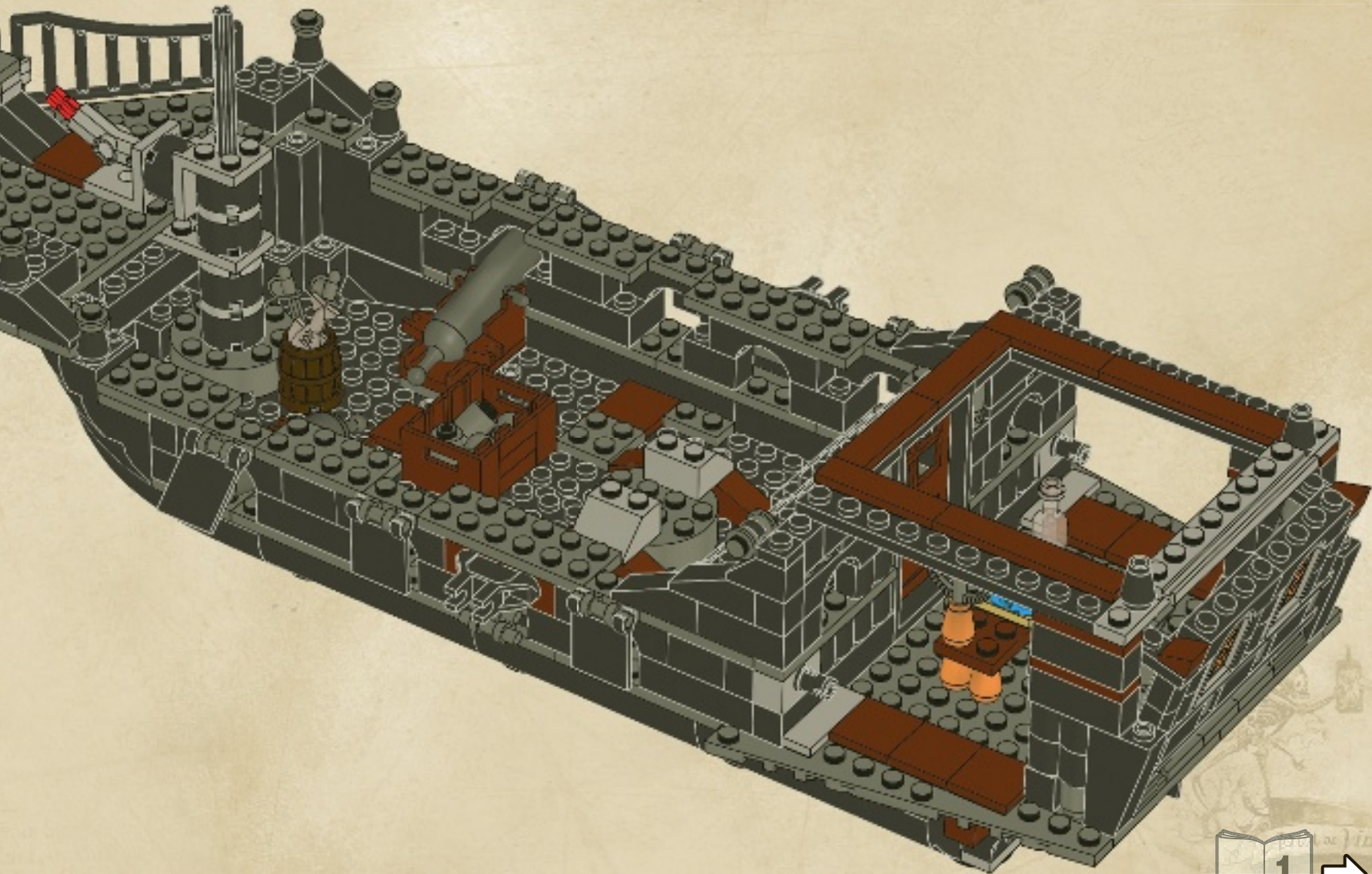



WIN!

Go to www.LEGOsurvey.com/product to fill out a survey for a chance to win a cool LEGO® Product. No purchase necessary. Open to all residents where not prohibited.



www.LEGO.com



www.LEGOsurvey.com/product

GEWINNE!

Nimm an der Umfrage auf www.LEGOsurvey.com/product teil und hab die Chance ein cooles LEGO® Produkt zu gewinnen! Die Teilnahme am Gewinnspiel führt zu keinerlei Kaufverpflichtungen. Teilnahme in allen nicht ausgeschlossenen Ländern möglich.

WIN!

Ga naar www.LEGOsurvey.com/product, vul een enquêteformulier in en maak kans op een cool LEGO® product. Geen aankoopverplichting. Iedereen mag deelnemen, uitgezonderd ingezetenden van landen waar een enquêteverbod geldt.

GAGNE!

Visite www.LEGOsurvey.com/product pour répondre à un questionnaire et avoir une chance de gagner un produit LEGO® très cool! Aucune obligation d'achat. Ouvert à tous les résidents des pays autorisés.

当てよう!

www.LEGOsurvey.com/product にアクセスして、アンケートにご記入ください。当選者にはレゴ製品を差し上げます。お買い上げの必要はありません。禁止されていない限り、すべての皆様にご利用いただけます。