



TECHNIC

42031



1

LEGO.com/building-app



2



3



Apple, the Apple logo, iPad, iPhone and iPod touch are trademarks of Apple Inc., registered in the U.S. and other countries. App Store is a service mark of Apple Inc.

Apple, le logo Apple, iPad, iPhone et iPod touch sont des marques de commerce d'Apple Inc., déposées aux États-Unis et dans d'autres pays. App Store est une marque de service d'Apple Inc. Apple, el logotipo de Apple, iPad, iPhone e iPod touch son marcas comerciales de Apple Inc. registradas en EE. UU. y otros países. App Store es una marca de servicio de Apple Inc.

Google Play is a trademark of Google Inc.
Google Play est une marque de commerce de Google Inc.
Google Play es una marca comercial de Google Inc.



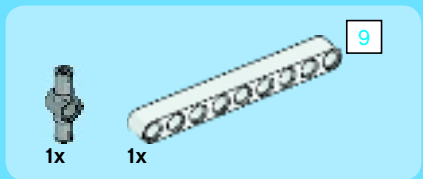
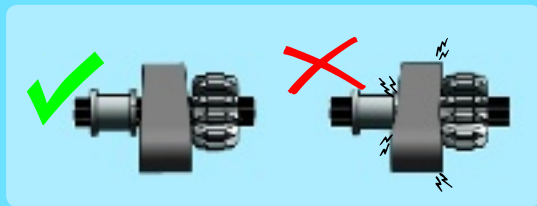
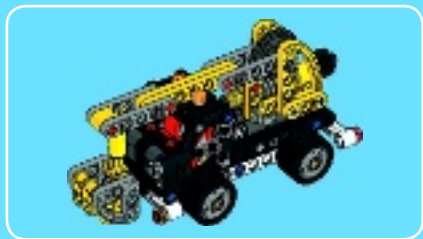

1

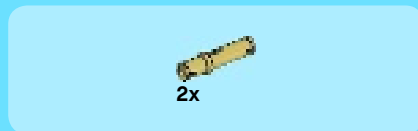
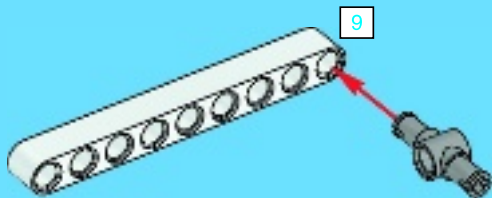

2

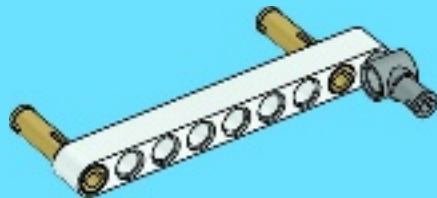



1x



1x

3

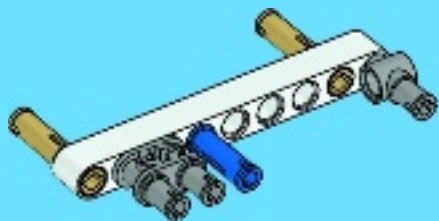

2x



1x

9

4

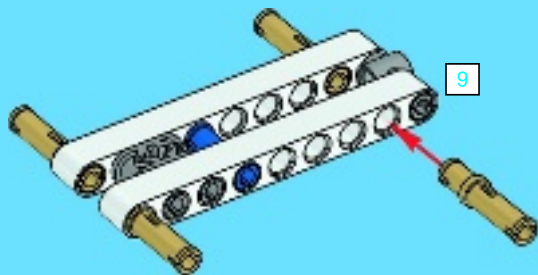

9

4



9

1:1



5

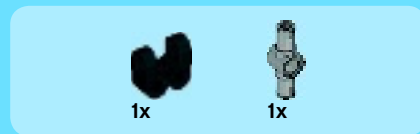
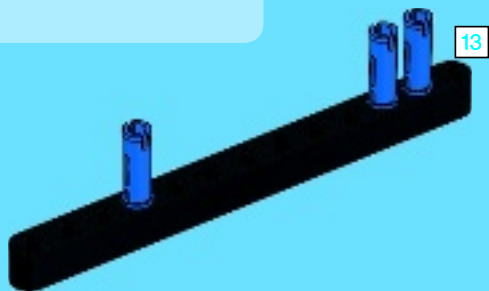

6

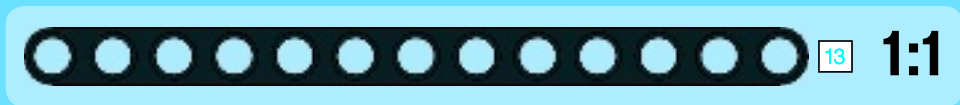
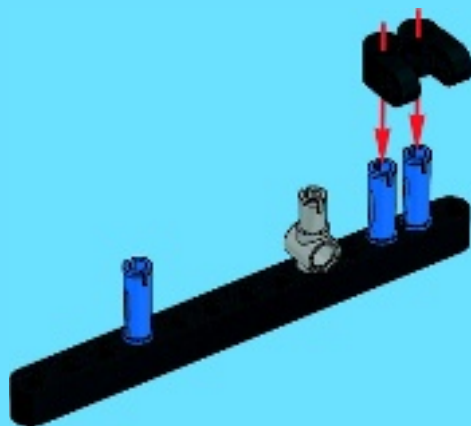

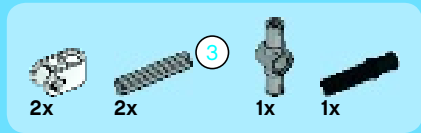

7

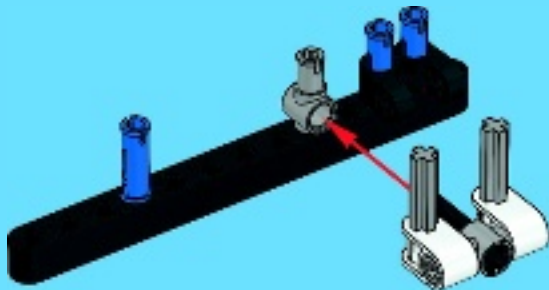
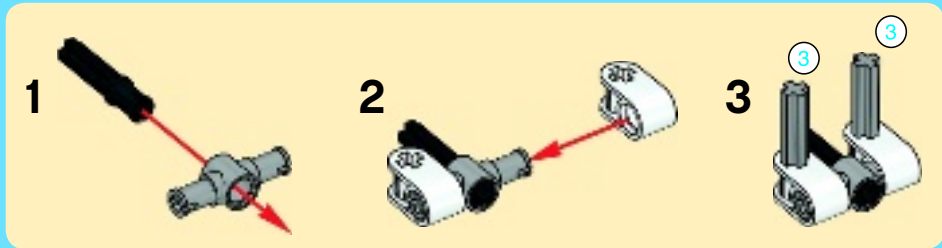

6





1x

8

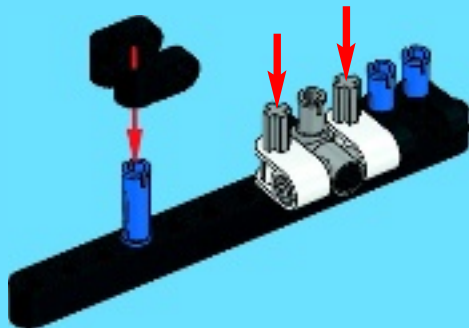

1x



1x



1x



1x

9

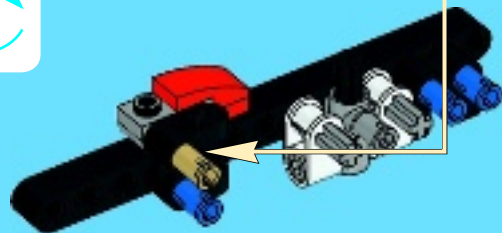



10

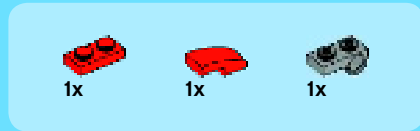
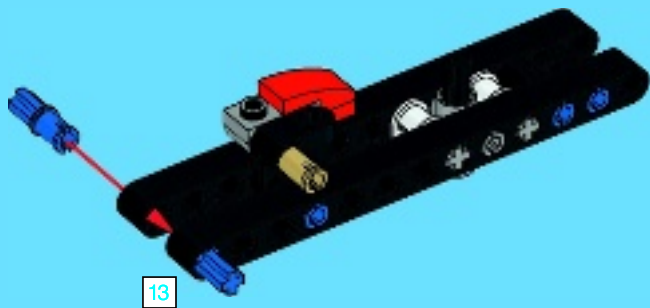

11

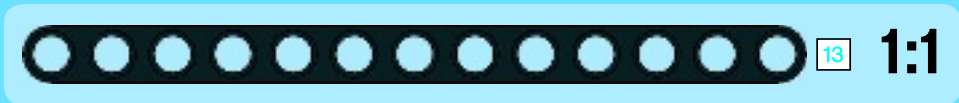
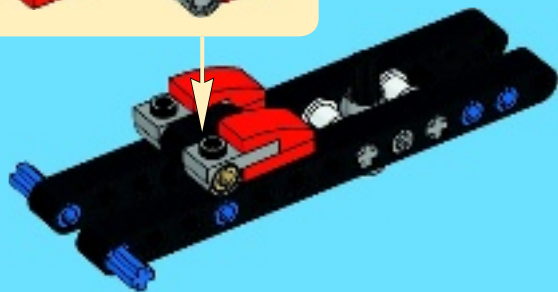
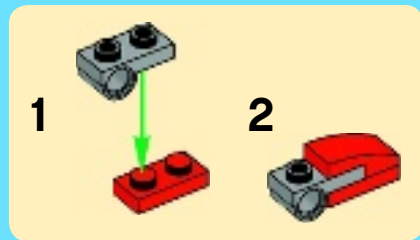



1x



3x

12

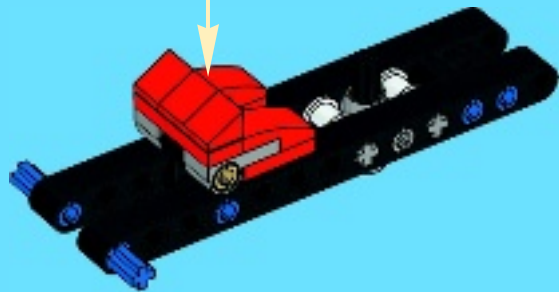
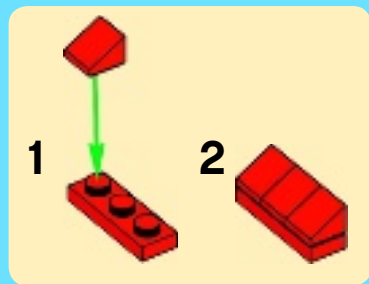

13

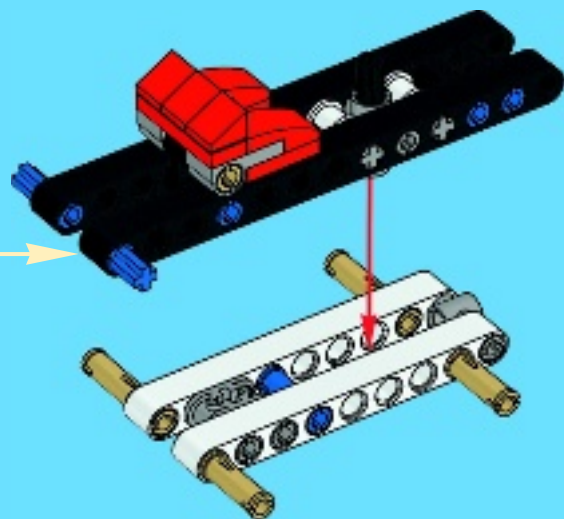

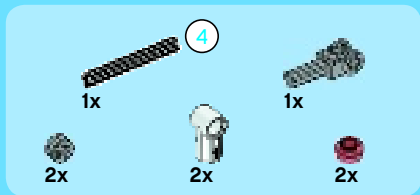

14

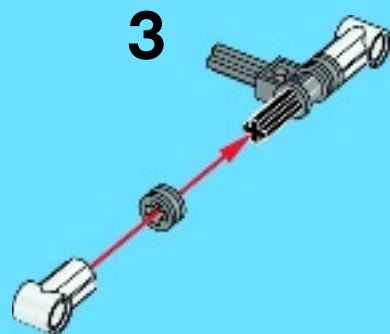
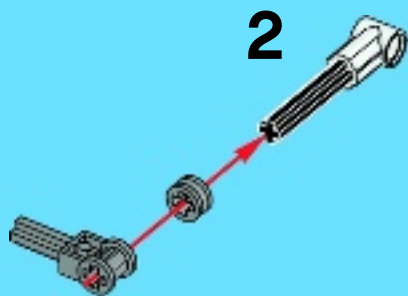
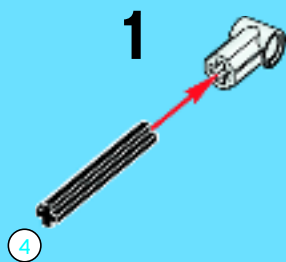

4

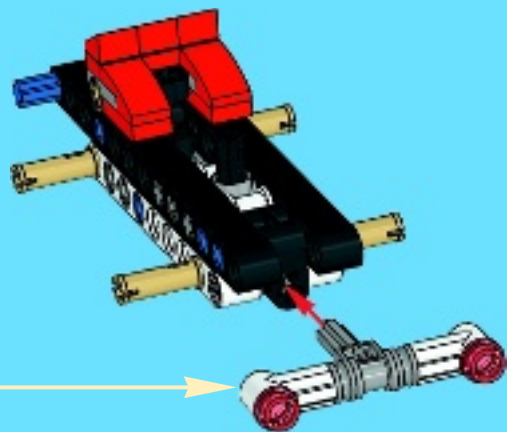
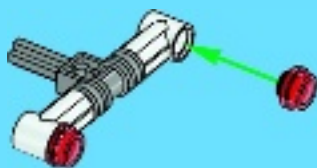



15

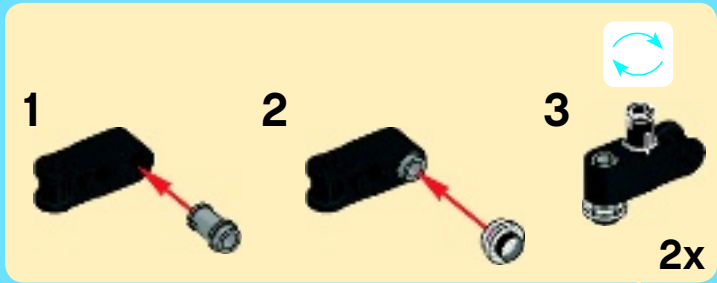



16

1



2



3

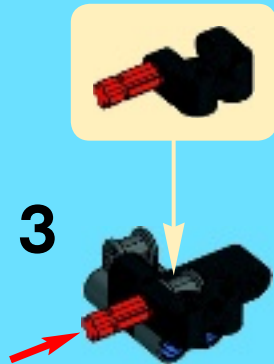

4

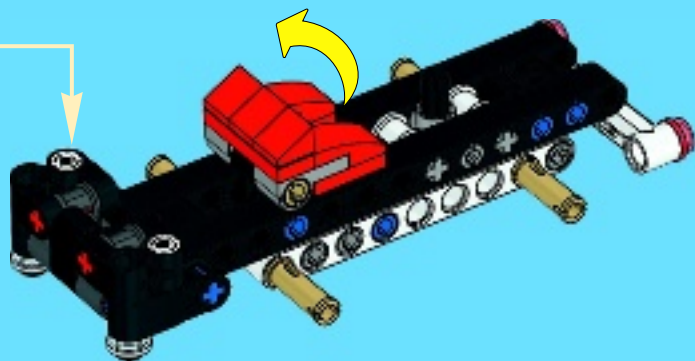
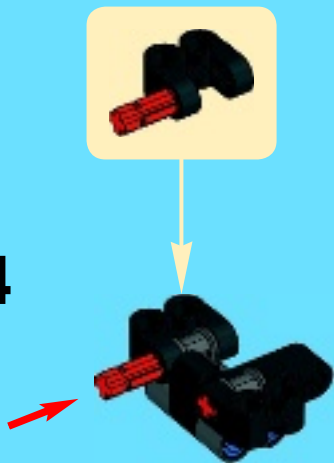

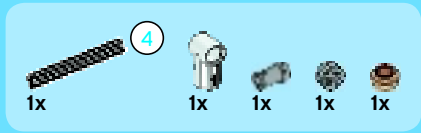

17

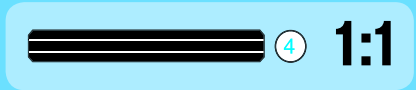
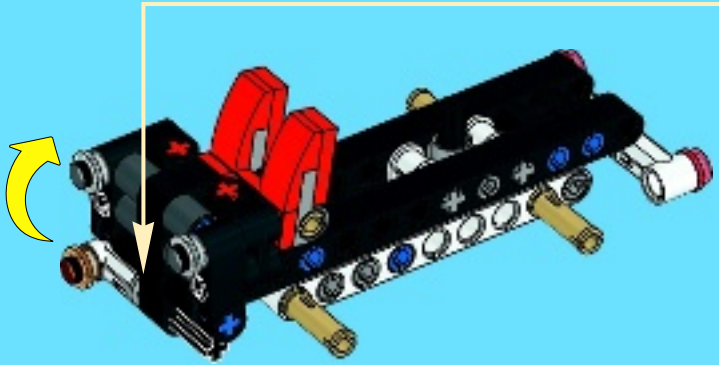
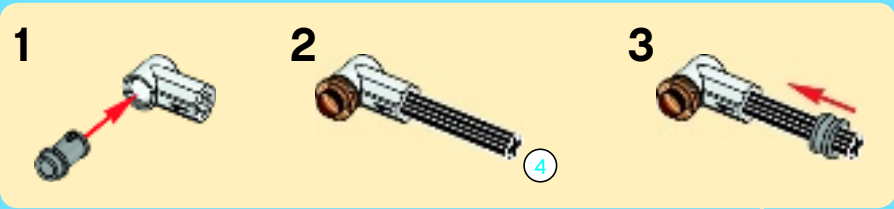



1x

18

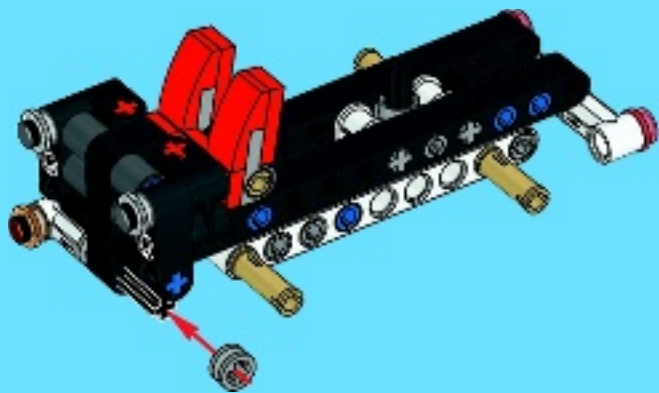

1x



1x



1x

19

1

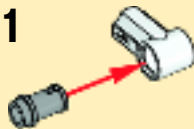

2

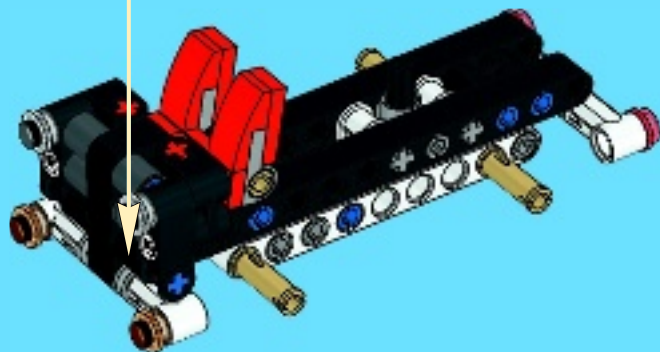



1x



2x



2x

20

1



2



3

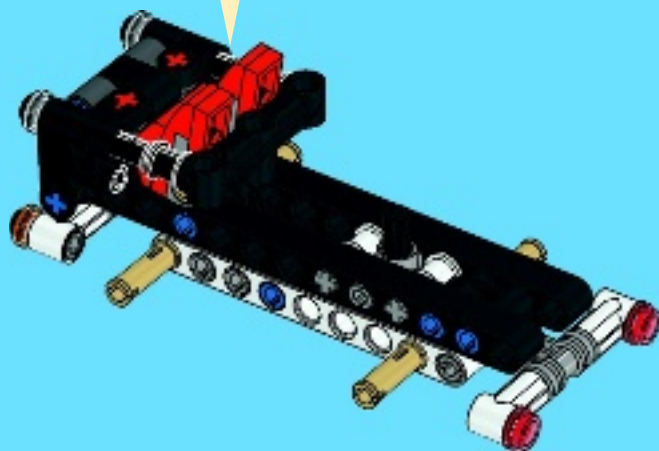

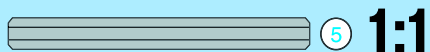
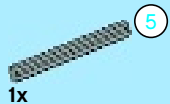

21

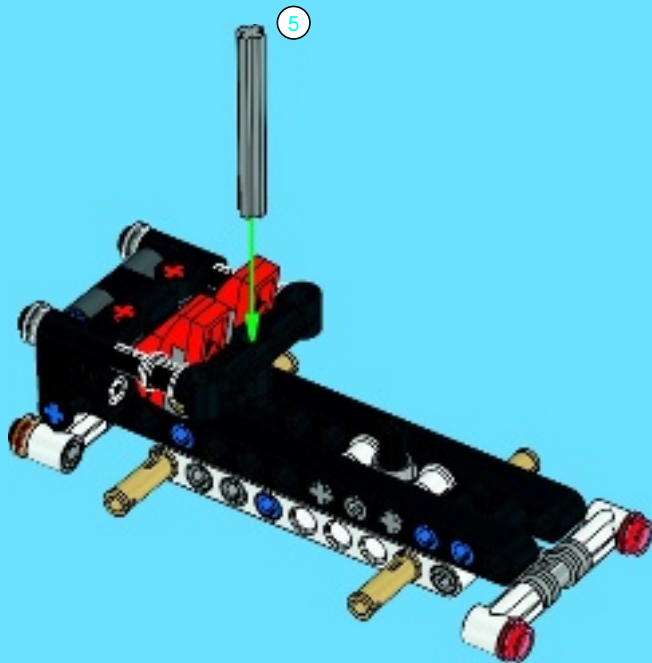

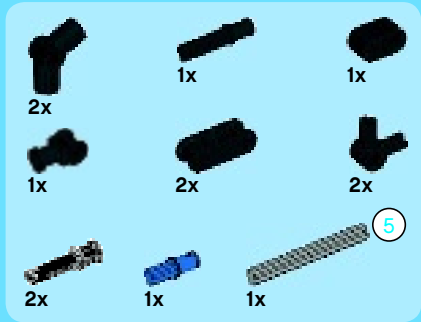
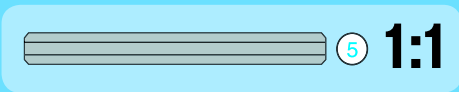

22

1



2



3

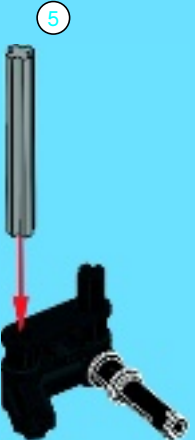

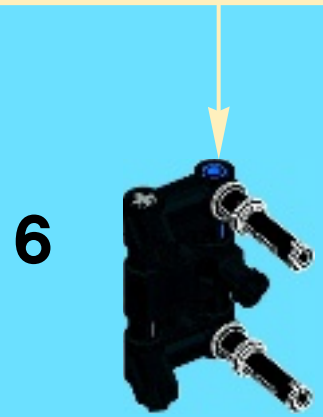
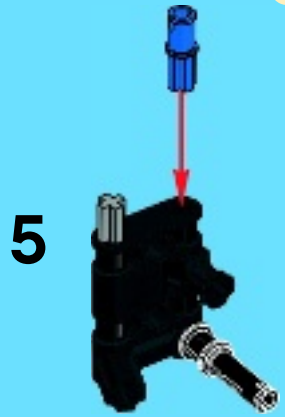
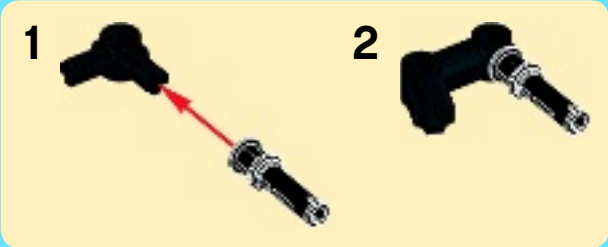

7

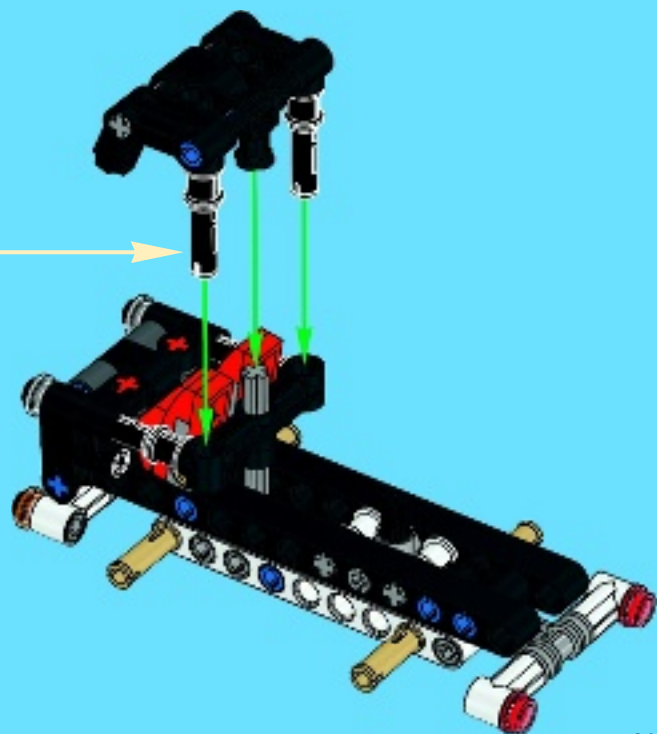



2x



2x

23

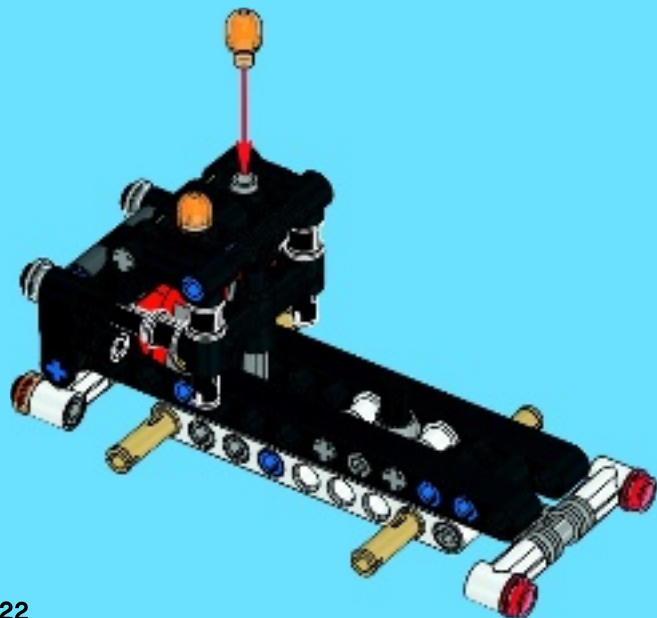

22



4x



4x

24





25

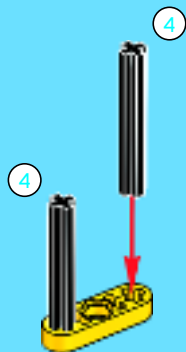

26





1x



1x

27

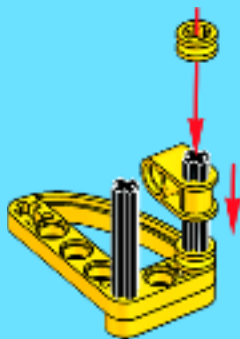

24



1x



1x



1x

3

28

1



2

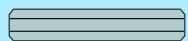
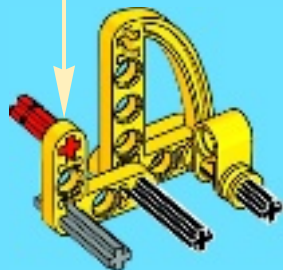

3

1:1



2x



1x

29

1



2

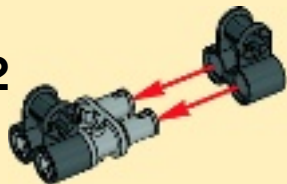

2x



1x

30

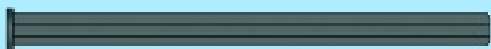
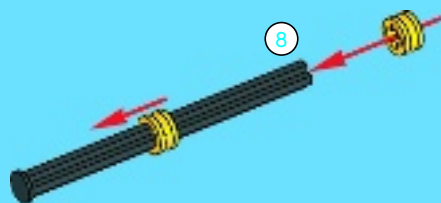

8

1:1



1x



1x

31

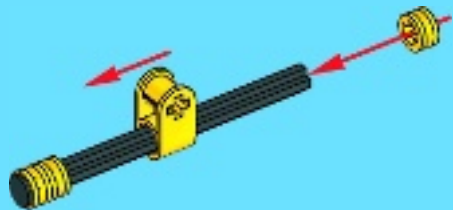

1x



1x

32



33

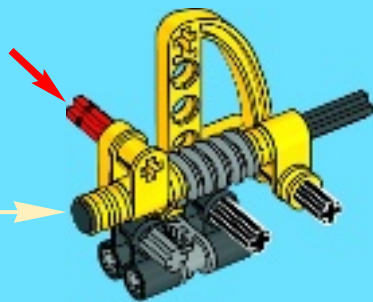

34

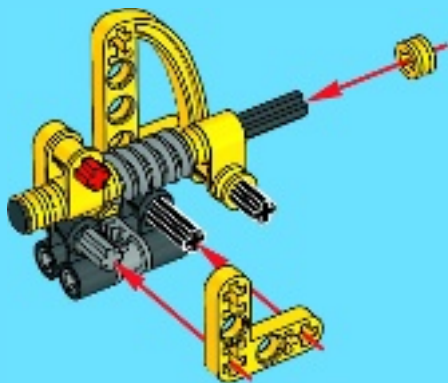

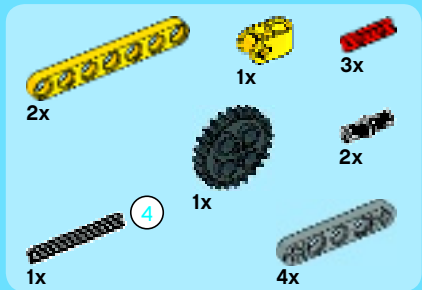
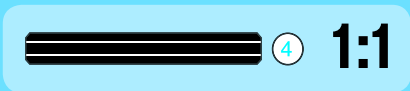

35

1



2



3

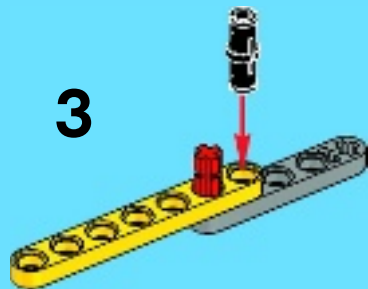

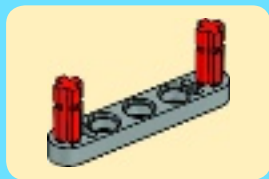

4

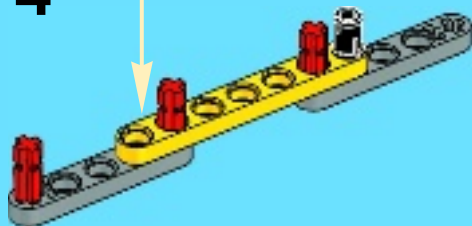

5

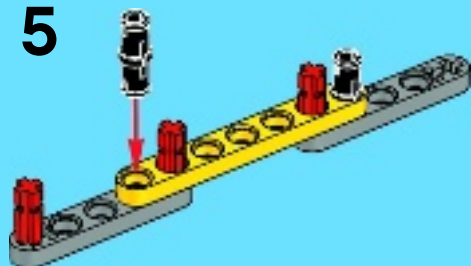

6

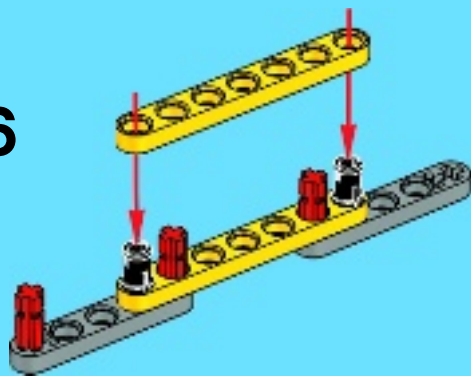

7

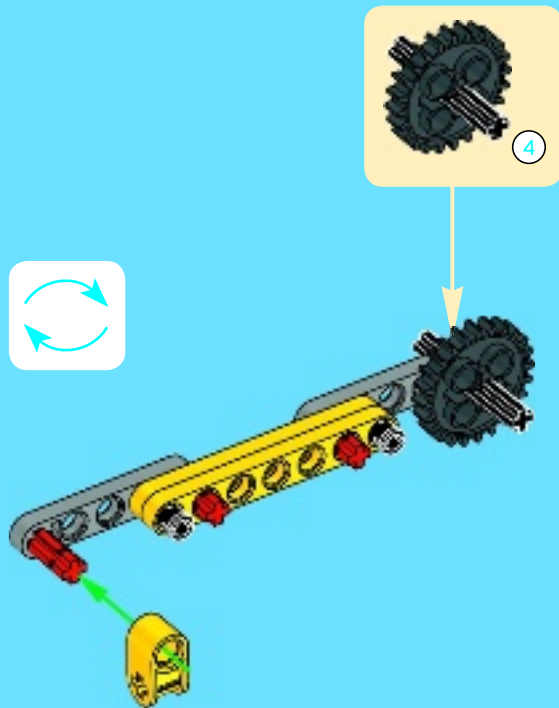

8

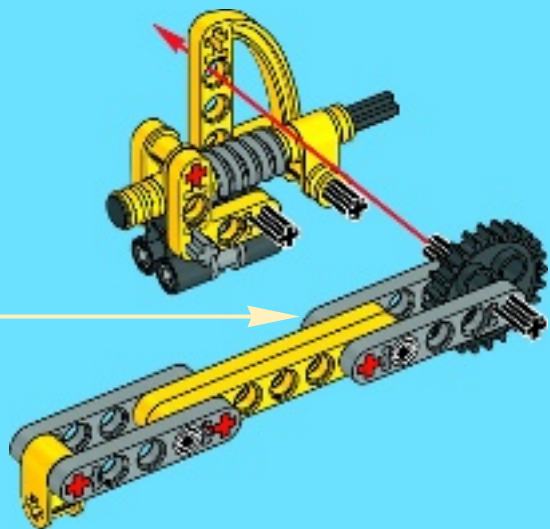
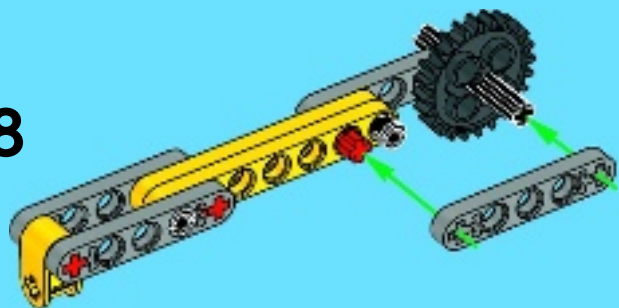

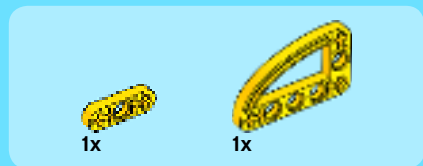

36

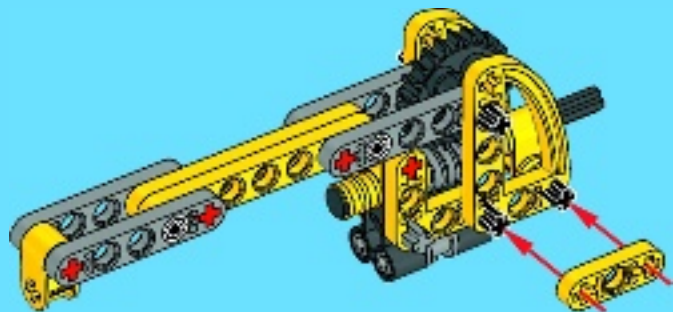

32

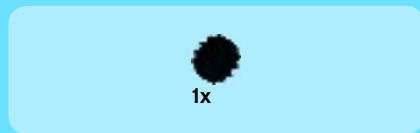

37

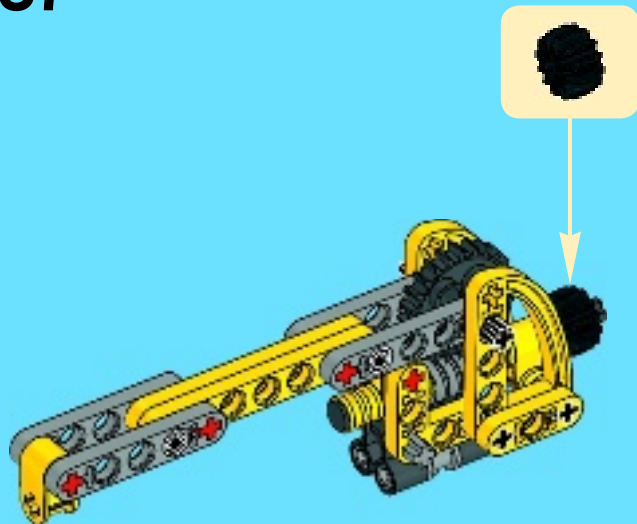

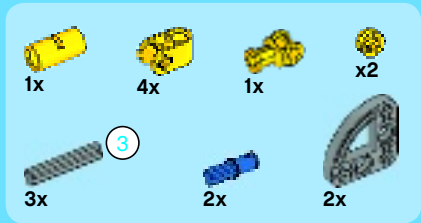
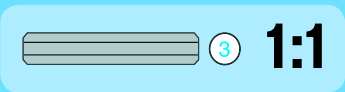

38

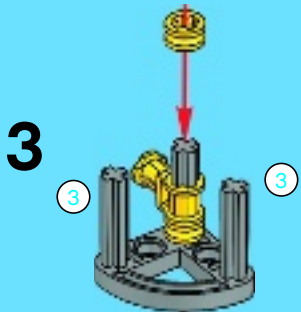
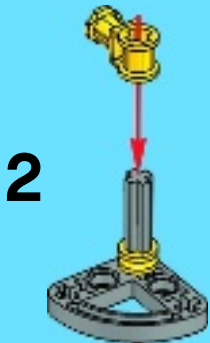
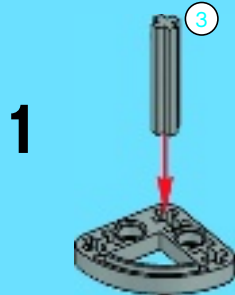

4



5



6



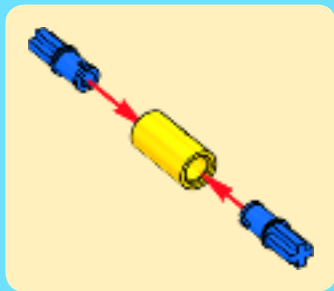

7

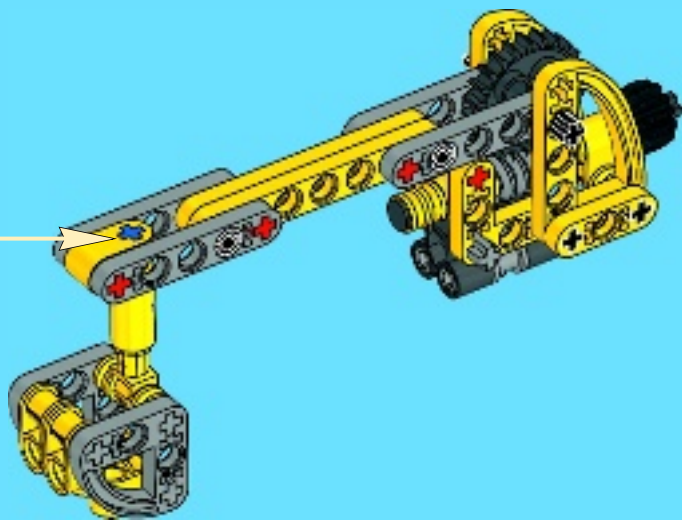

39

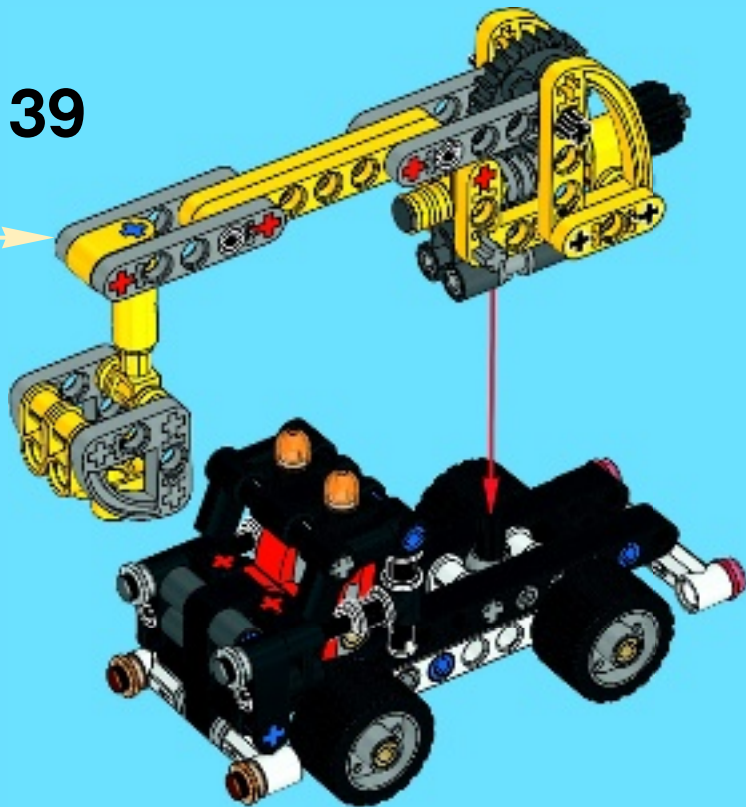



TECHNIC

42031



1

LEGO.com/building-app



2



3



Apple, the Apple logo, iPad, iPhone and iPod touch are trademarks of Apple Inc., registered in the U.S. and other countries. App Store is a service mark of Apple Inc.

Apple, le logo Apple, iPad, iPhone et iPod touch sont des marques de commerce d'Apple Inc., déposées aux États-Unis et dans d'autres pays. App Store est une marque de service d'Apple Inc.

Apple, el logotipo de Apple, iPad, iPhone e iPod touch son marcas comerciales de Apple Inc. registradas en EE. UU. y otros países. App Store es una marca de servicio de Apple Inc.

Google Play is a trademark of Google Inc.

Google Play est une marque de commerce de Google Inc.

Google Play es una marca comercial de Google Inc.



Available on the
App Store

ANDROID APP ON
Google play



TECHNIC

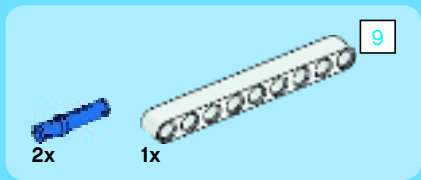

1

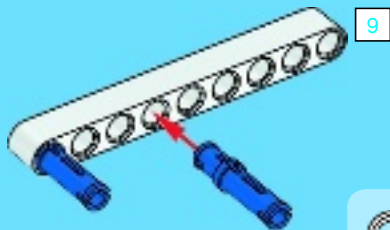

2

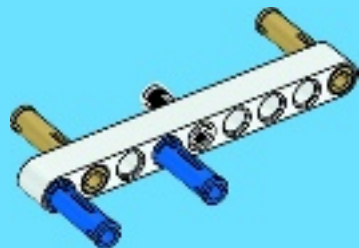

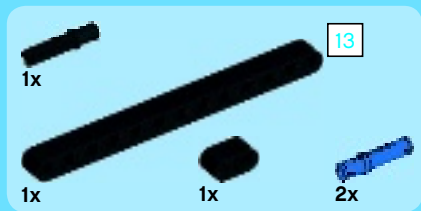

3

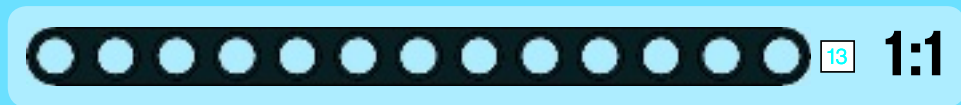
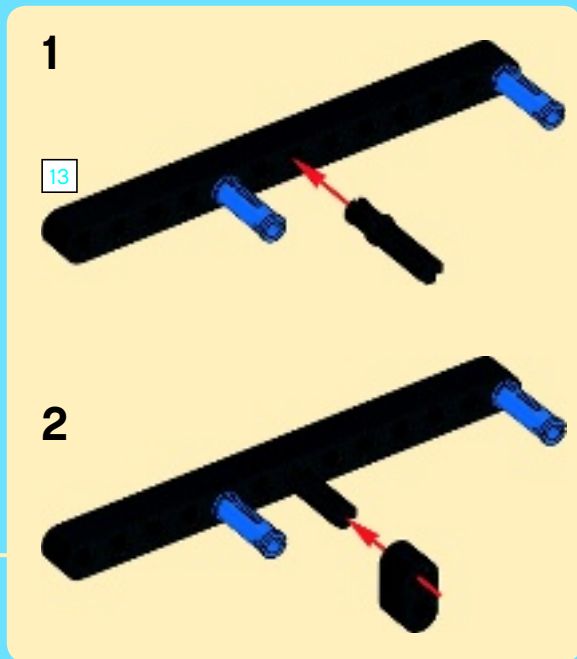
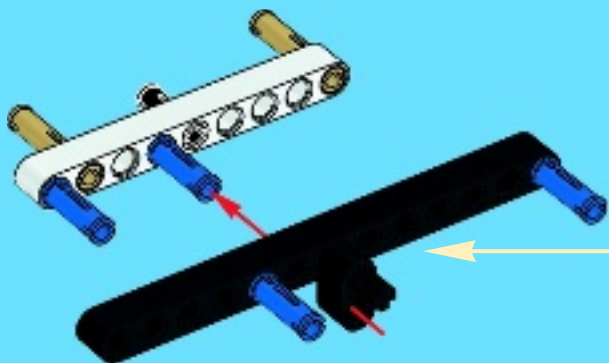

4



1x

4



1x



1x

5





1x



1x

1

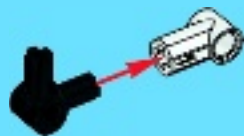

1x

2

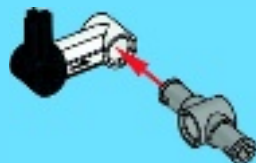

6



1x



2x

3

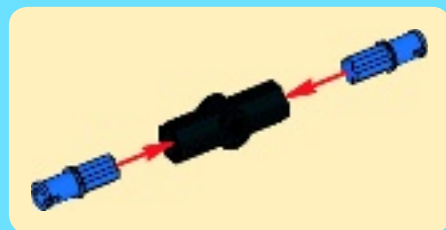



1x



1x

4

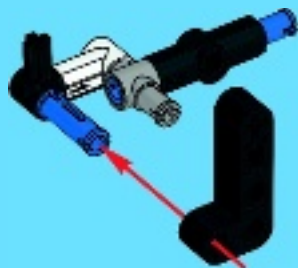

1x



1x

5

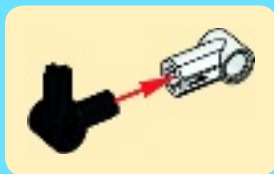



1x

6



8

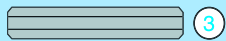

3

1:1



2x



1x

3

7

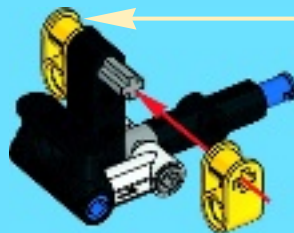

3



2x

8



6

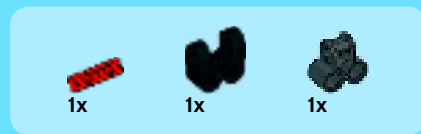
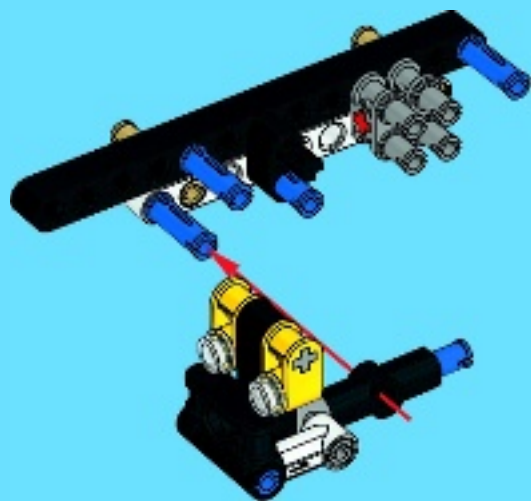

7

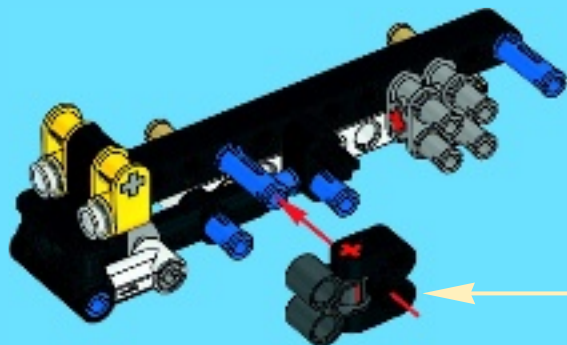



1x

8

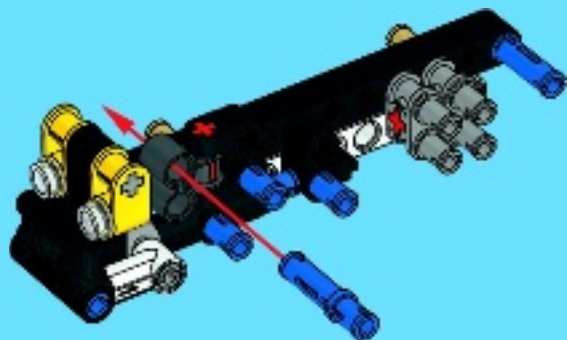

2x



2x



2x

9

1

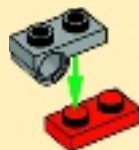

2



2x

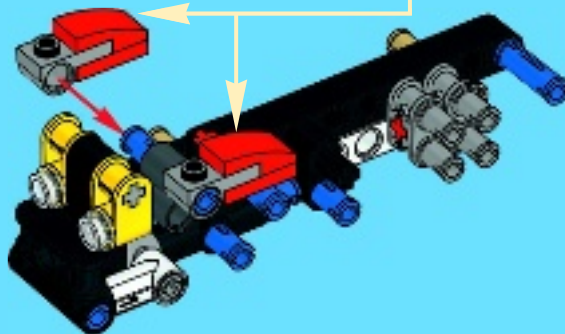



1x



3x

10

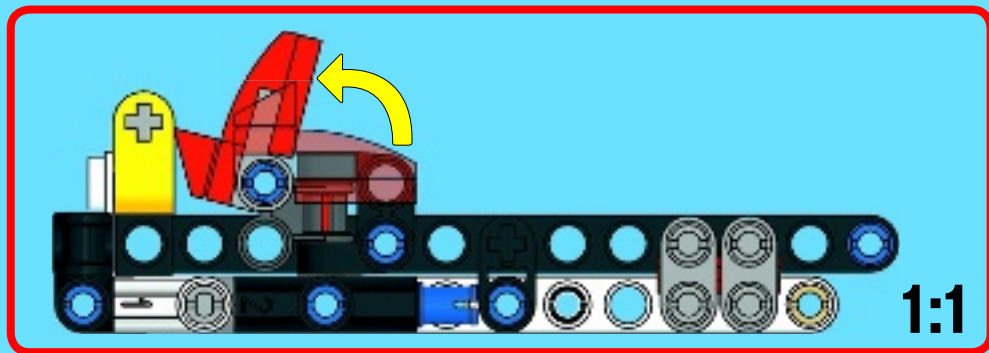
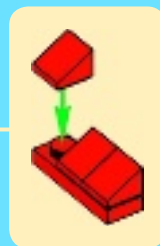
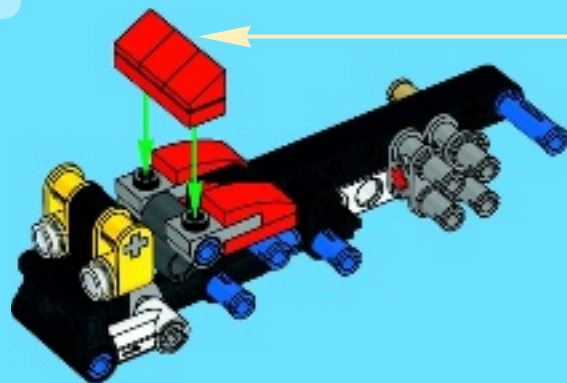

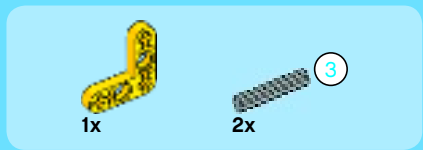

1

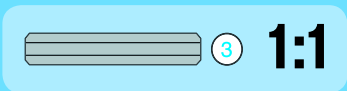
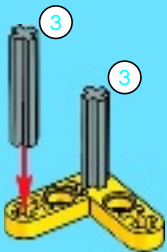

2



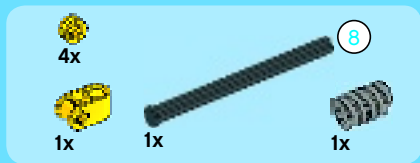

3

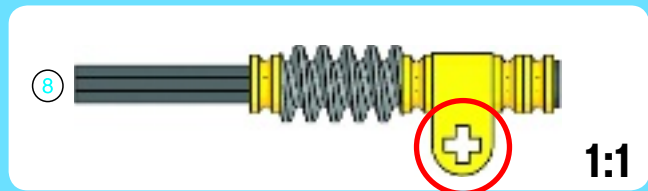
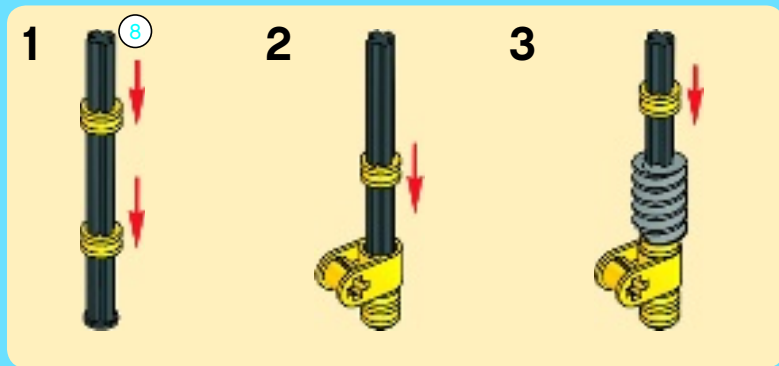



1x



1x

4

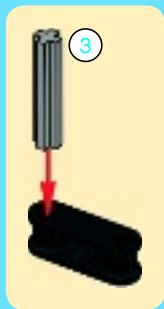

3

1:1



1x



1x

5





1x

6



2x

7

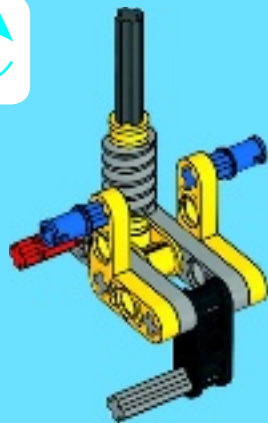

12

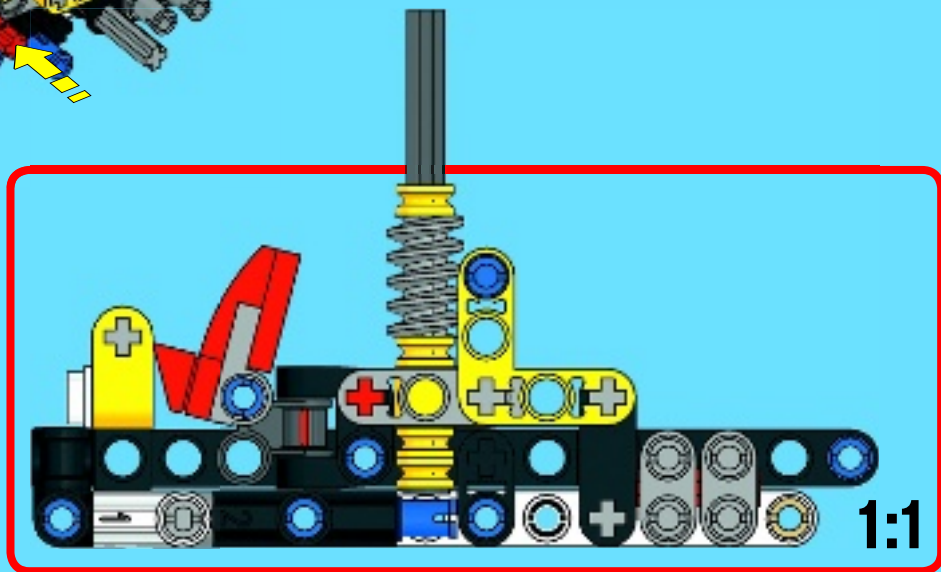
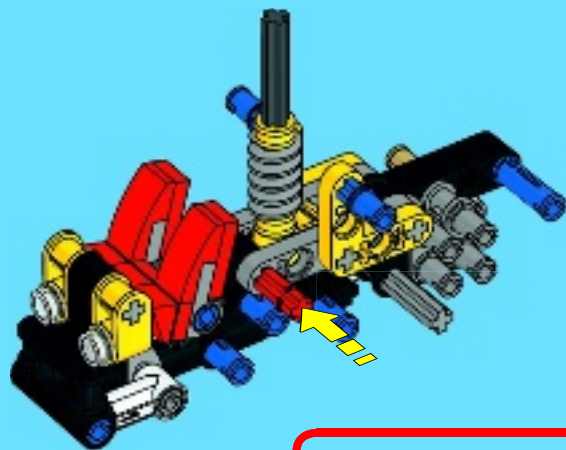

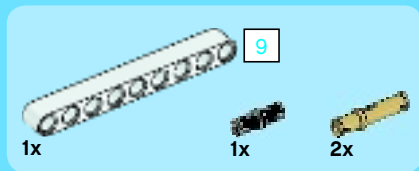

13

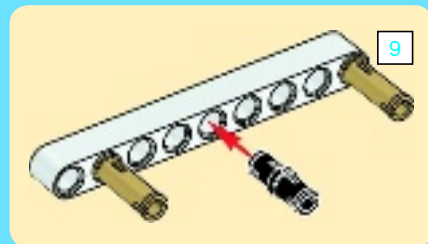
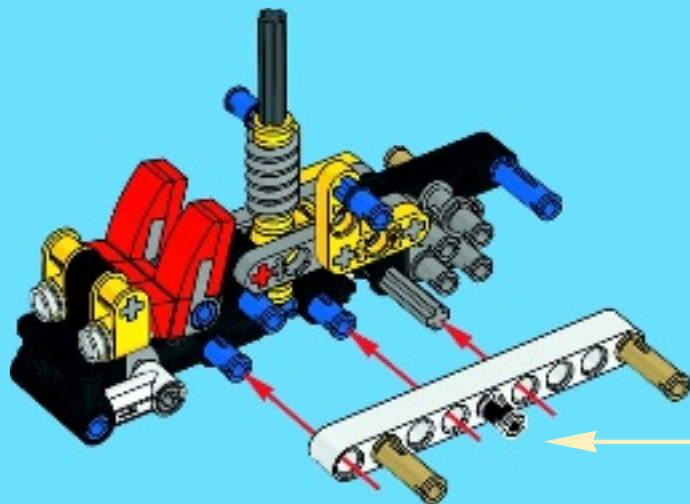

9

1:1



1x

14

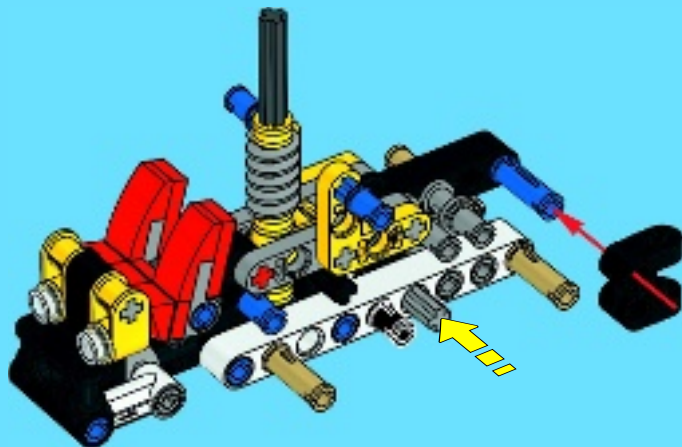

13

1x

15

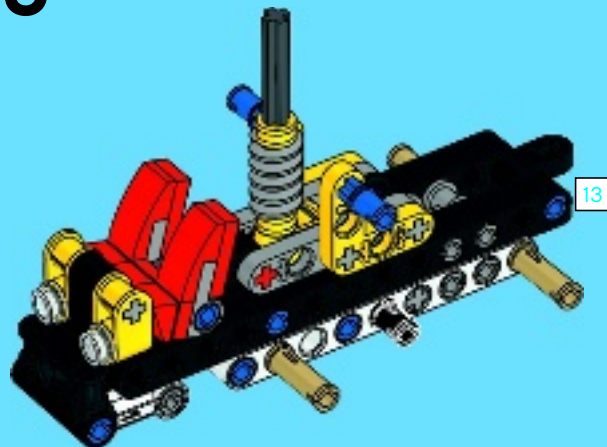

13



13

1:1

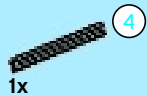

1

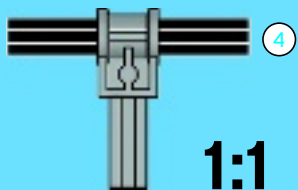

1:1



2x

2



20



2x

3



4x

4

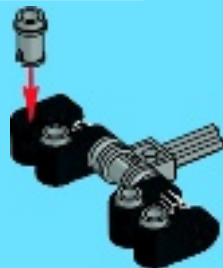



2x



2x

5



16

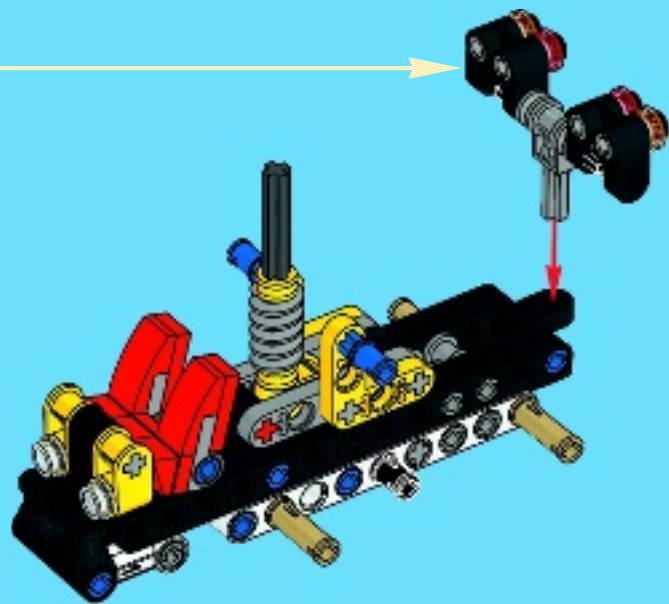



1x



1x

1



1x

2

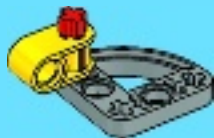

1x



1x

3

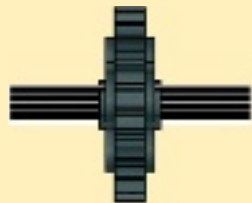

4

1:1

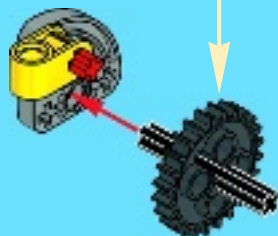



1x

4

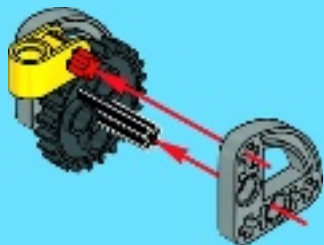

17

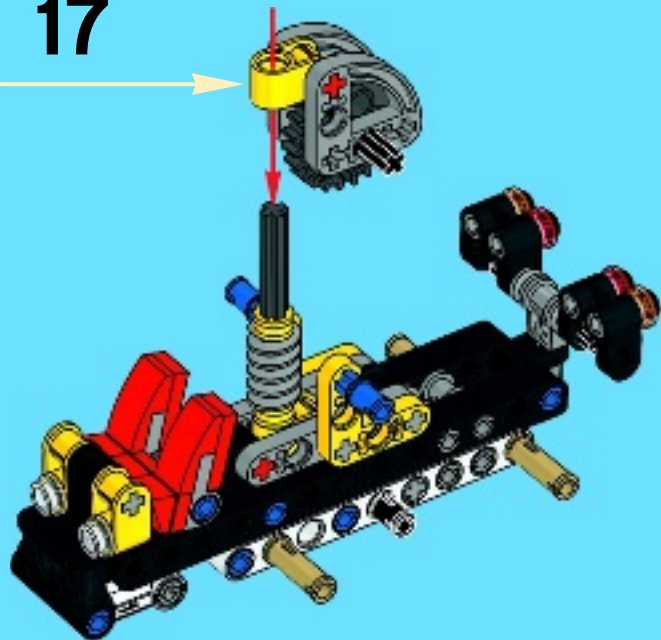

18

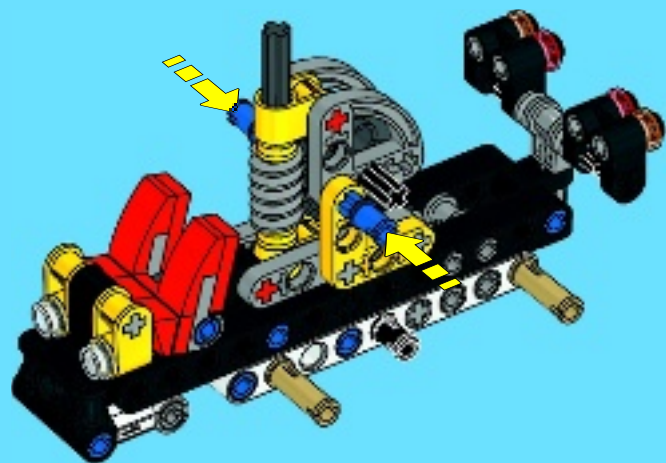

1x



1x

19

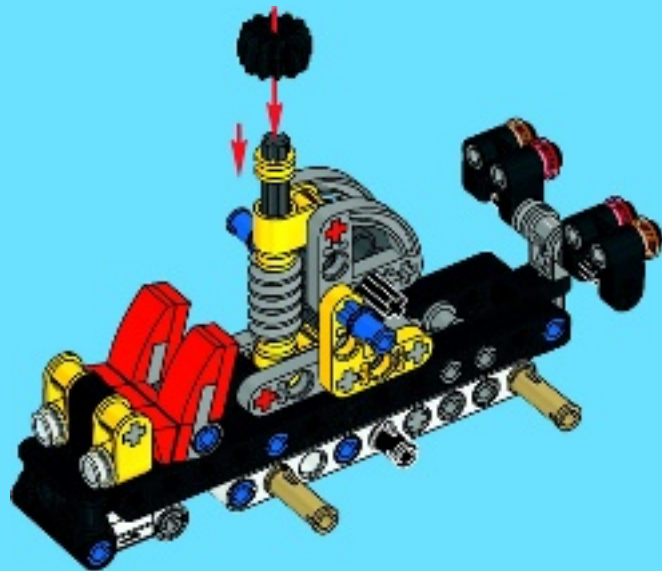

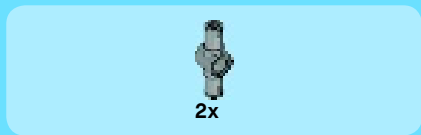

2x

1

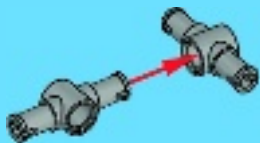

1x

2

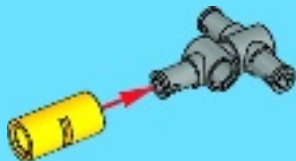

1x

1:1

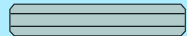

3

3

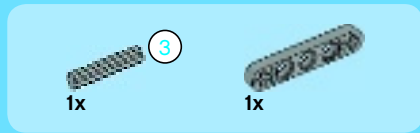
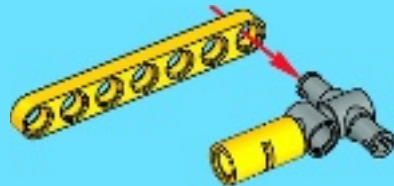

1x

3

1x

4

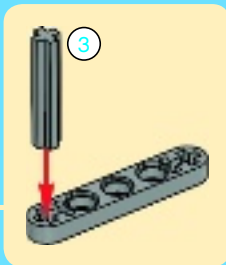
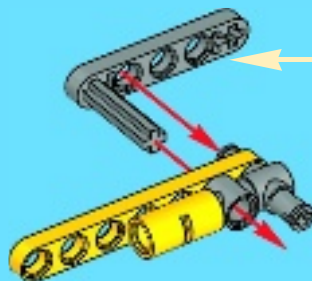

3



1x



1x

5



1x

6

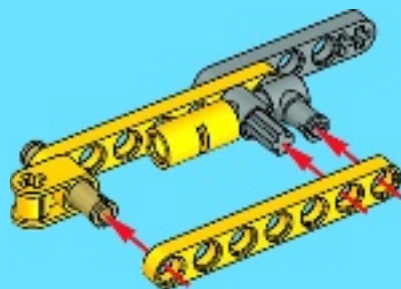



1x



1x



1x

20

7

1



2

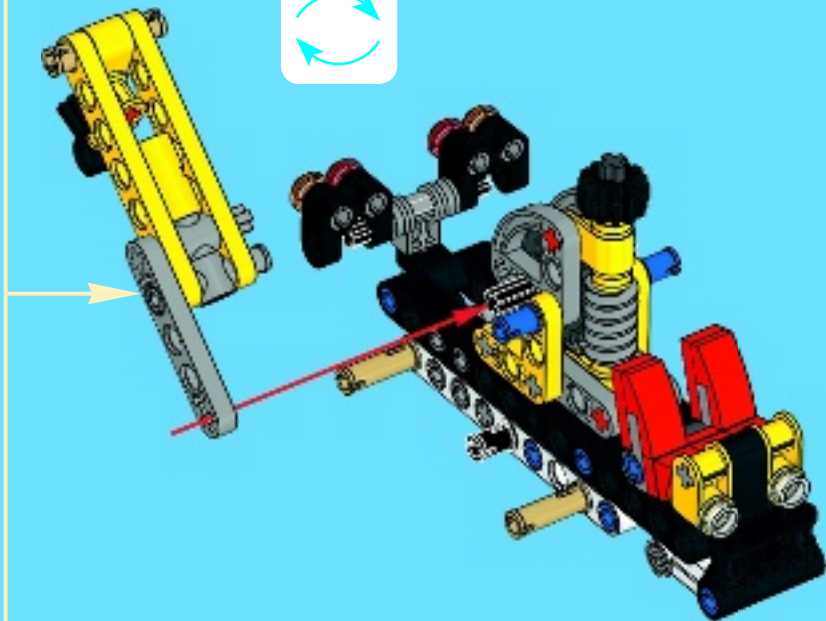
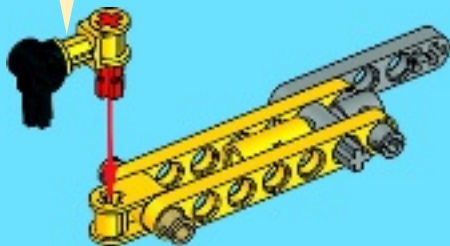



1x

21

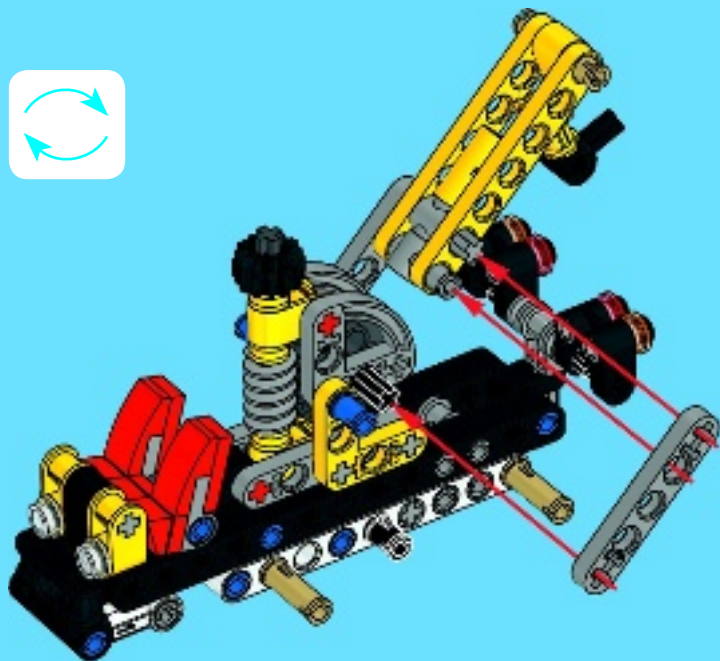

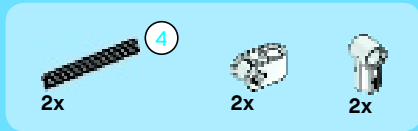

22

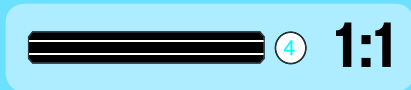
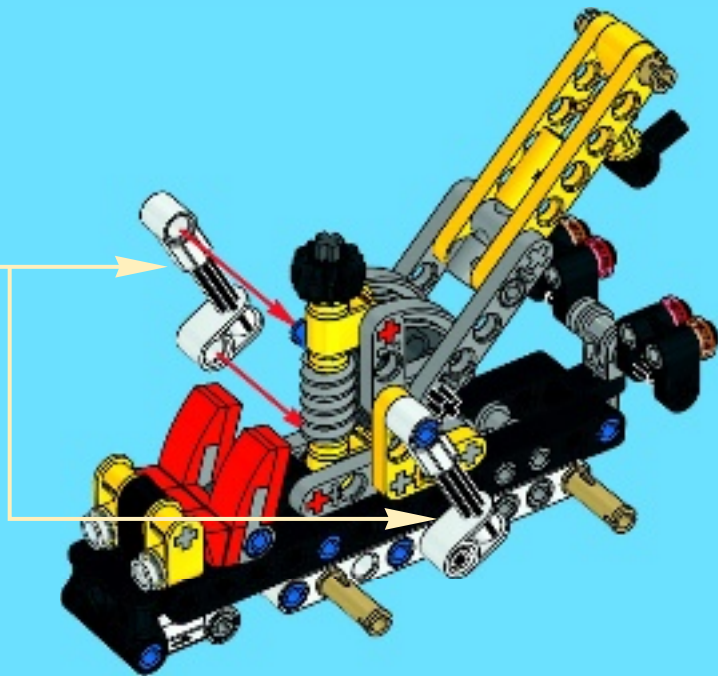
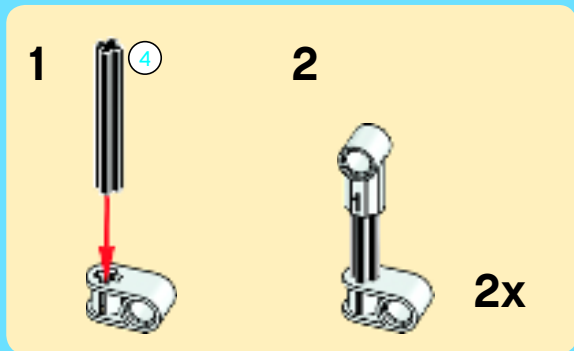

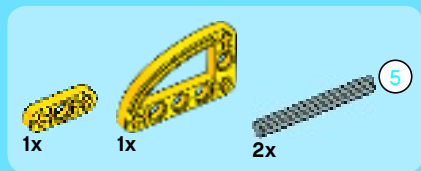

23

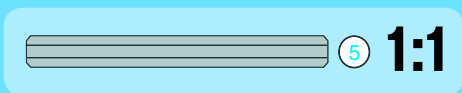
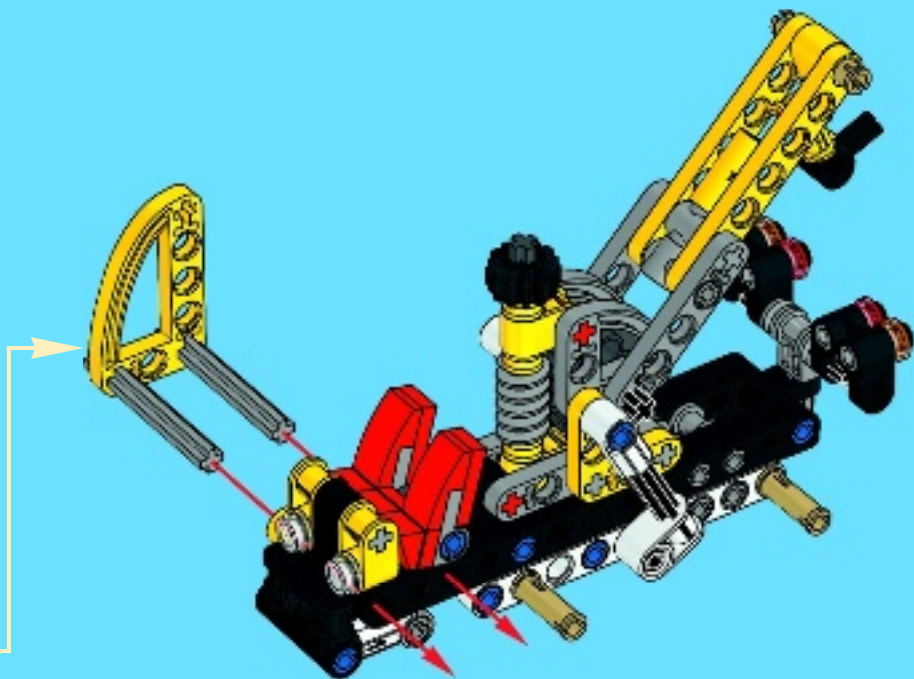
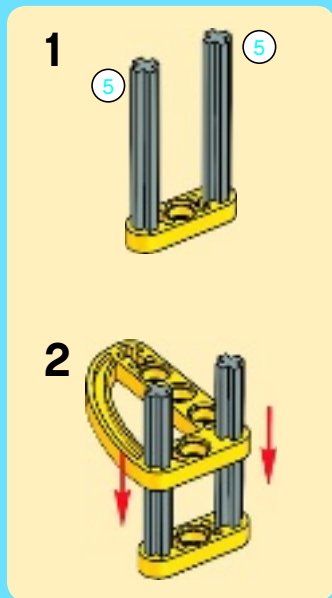

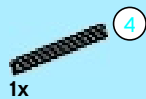

1



2

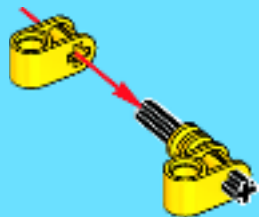

3



4

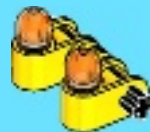

24

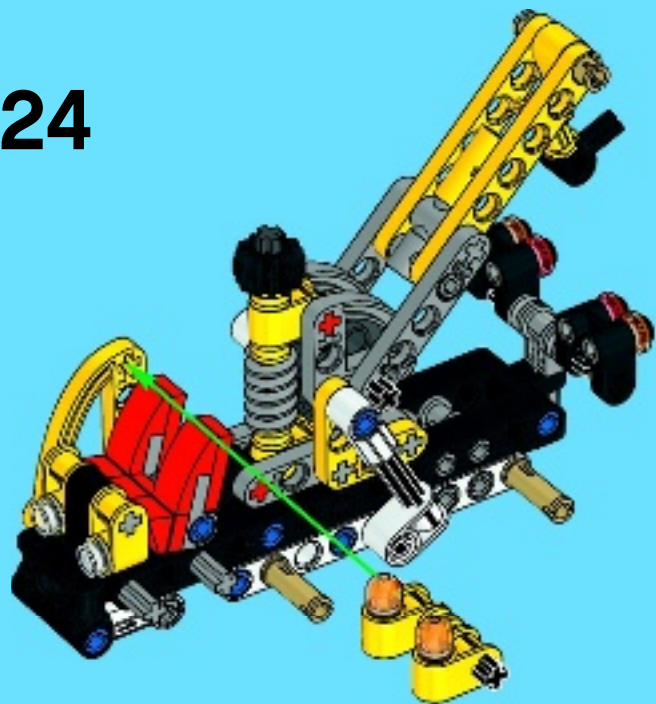

25

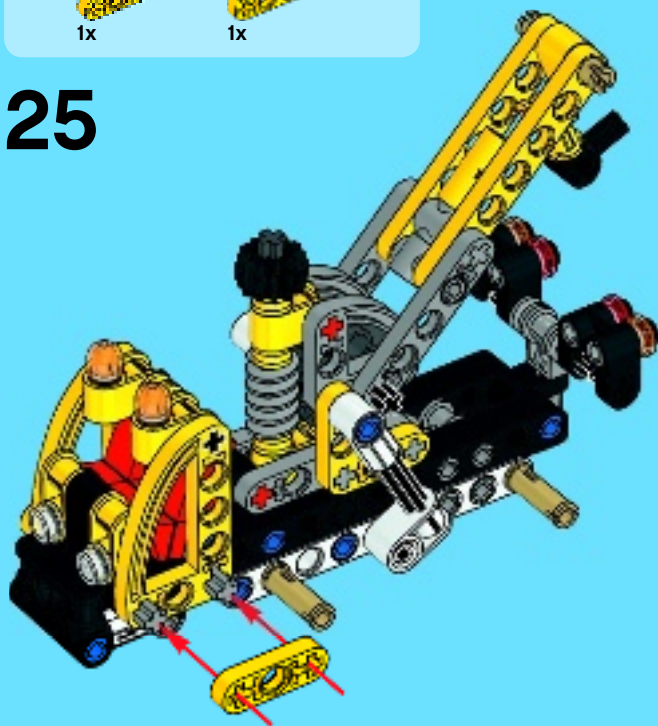



4x



4x

26



4x



9

2x
6001831



2x
4173670



4x
4118981



5x
4514554



3x
4504379



2x
6029946



2x
302321



1x
362321



6x
4142865



5x
4206482



6x
4514553



7x
4173666



2x
4112289



2x
4107823



2x
4128554



2x
4114672



9x
4239601



1x
4107800



1x
4526983



4x
4639695



1x
4120017



13

2x
4522933



1x
6006140



2x
4173970



2x
4121667



4x
4162857



1x
4107783



4x
4121715



4x
6099801



2x
4107084



1x
4107081



2x
6089119



4x
4140801



4

5x
370526



1x
4177431



2x
3005740



2x
3005741



2x
4222960



2x
4524365



2x
6089147



4x
4299119



3x
4560175



2x
4531184



4x
6029206



4x
4211573



6x
4211483

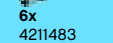

6x
4211815



2x
4211888



1x
4211536



5

2x
4211639



1x
4211510



4x
4210655

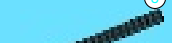

8

1x
4499858



1x
4514558



Customer Service

Kundenservice

Service Consommateurs

Servicio Al Consumidor

LEGO.com/service or dial



00800 5346 5555 :



1-800-422-5346 :



LEGO *TECHNIC*

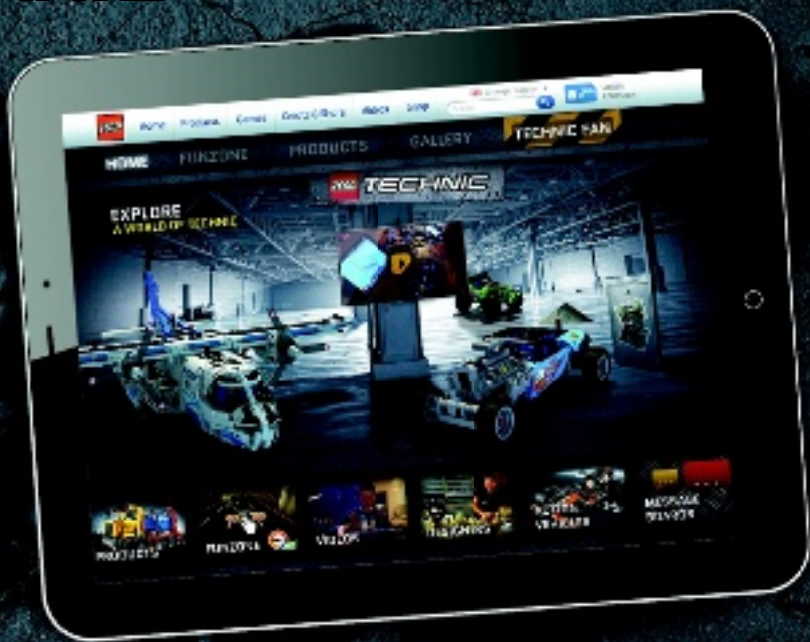

LEGO.com/technic

WIN

GO TO WWW.LEGO.COM/PRODUCTFEEDBACK AND
GIVE US YOUR SHORT **FEEDBACK** ABOUT THIS
LEGO® SET FOR A CHANCE TO WIN
A COOL LEGO PRIZE.



LEGO.com/productfeedback

GEWINNE



Erzähle uns auf
www.LEGO.com/productfeedback

etwas über die Erfahrungen, die du mit
diesem LEGO® Set gemacht hast, und
sichere dir die Chance auf einen coolen
LEGO Preis!

GAGNE



Rends-toi sur
www.LEGO.com/productfeedback

et donne-nous quelques commentaires
sur ce produit LEGO® pour avoir une
chance de gagner un prix LEGO !

GANAN



Visita
www.LEGO.com/productfeedback

y envíanos tu opinión acerca de este set
LEGO®. ¡Participarás en el sorteo de un
premio LEGO!

获取奖品



登录
www.LEGO.com/productfeedback

给出关于此乐高®套装的简短反馈，
就有机会获得炫酷乐高高奖品

LEGO and the LEGO logo are trademarks of the/son des marques de commerce du/son marcas registradas de LEGO Group. ©2015 The LEGO Group.

6112233 / 6112234