



# The Beatles Yellow Submarine

21306



- Booklet available in English on
- Heft in deutscher Sprache erhältlich auf
- Livret disponible en français sur
- Folleto disponible en español en
- Folheto disponível em português em
- A fűzet magyarul ezen a honlapon olvasható
- Libretto disponibile in italiano su
- 如需中文版手册，请访问 [www.LEGO.com/ideas](http://www.LEGO.com/ideas)



When the spectacular Yellow Submarine debuted in 1968, it was instantly recognized as a landmark film that took animation beyond anything seen before. Together with LEGO®

fan designer Kevin Szeto, we are proud to present our version of the iconic submersible as our 15<sup>th</sup> product in the LEGO Ideas series.



John



Paul



George



Ringo



Jeremy

# The story behind the story



The Yellow Submarine began its voyage when the producers of the American animated Beatles TV series approached The Beatles with an idea for a full-length feature. From the very beginning, the filmmakers wanted the feature to have a fresh, highly stylized look inspired by the modern art styles of the time.

The animated film they created was a fantasy tale full of adventure, music and colorful characters. On one side stands the evil Chief Blue Meanie, his henchman Max and the Blue Meanie Army that also includes the Apple Bonkers, Evil Clowns and Snapping Turks. On the other, John, Paul, George and Ringo come

together with the strange, riddle-speaking Jeremy Hillary Boob, Ph.D and the old sailor, Captain Fred.

At the center of the adventure is the remarkable Yellow Submarine, the magical craft that carries the Beatles beneath the waves from Liverpool, across wondrous seas to the shores of Pepperland.

When the film premiered in London on July 17<sup>th</sup> 1968, the colorful, visual feast was met with widespread critical acclaim and is still seen as a groundbreaking piece of animation almost half a century later.

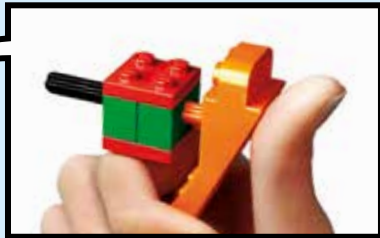
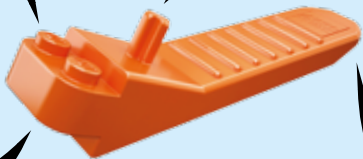
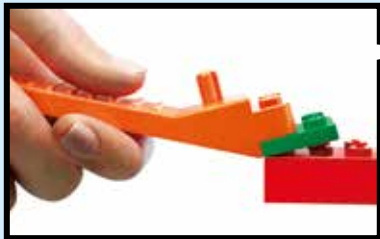

[LEGO.com/brickseparator](https://LEGO.com/brickseparator)

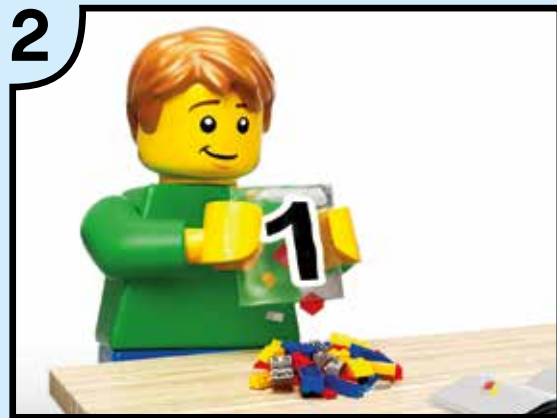

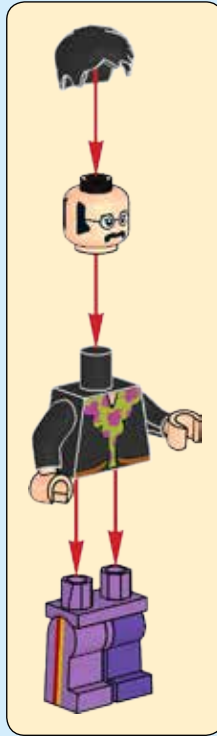

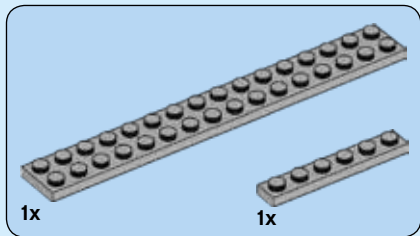

**1**

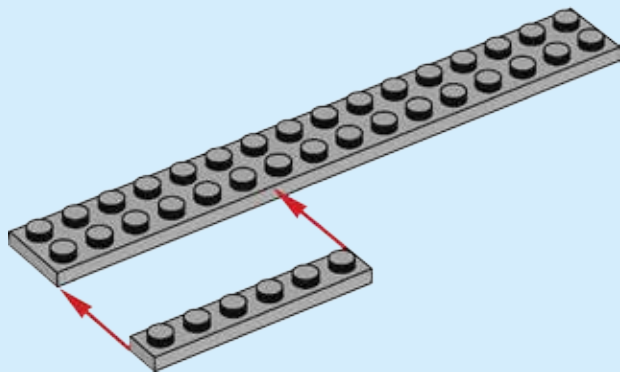

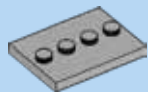

4x

2

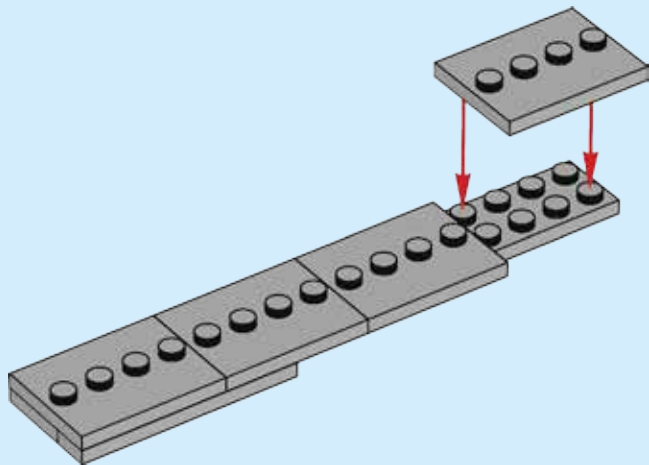

8



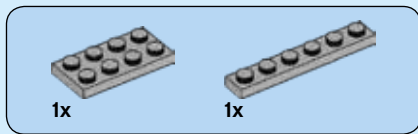

3

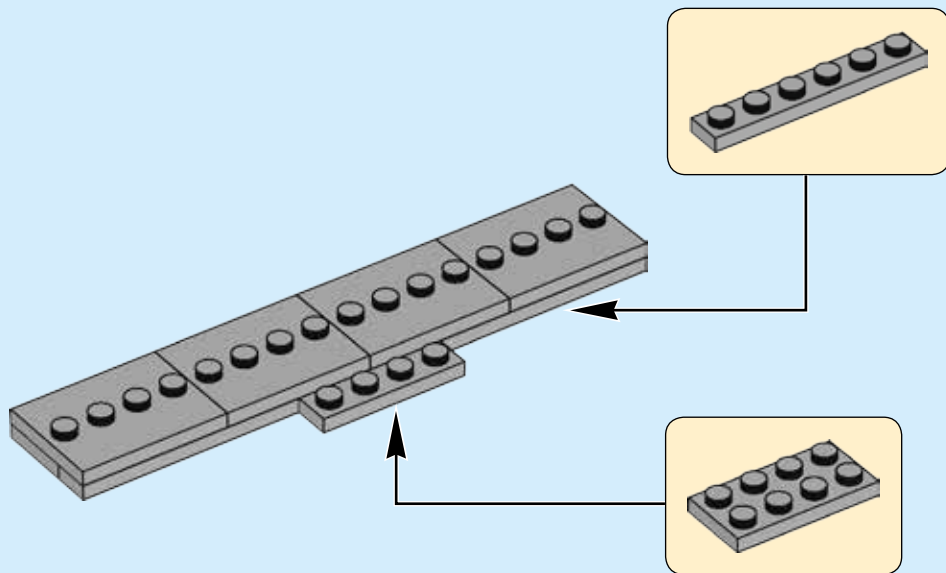



2x



2x

4

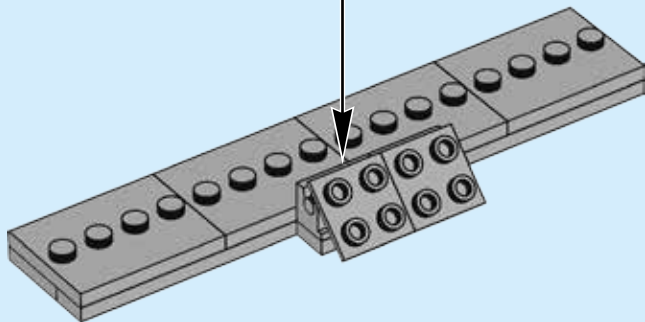
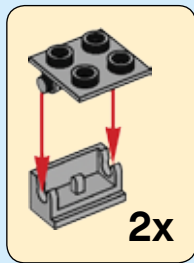



5

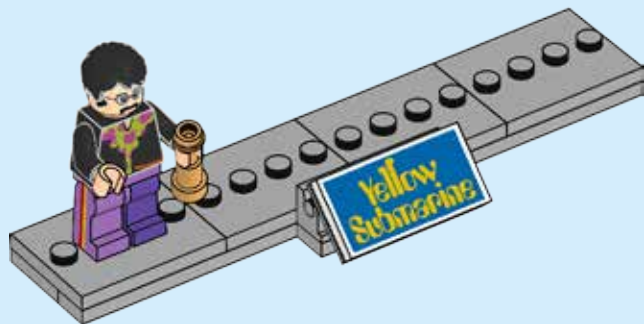

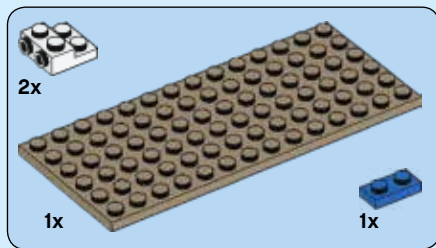
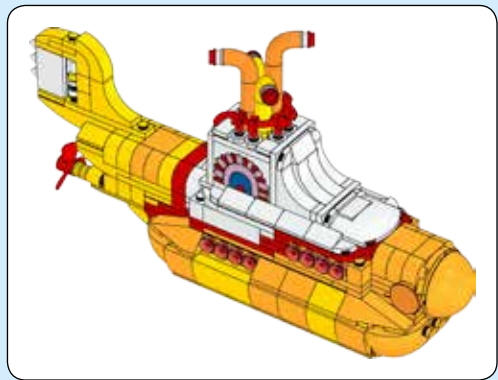

1

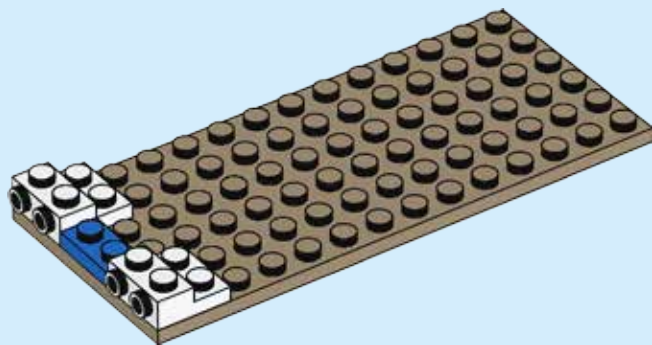



2

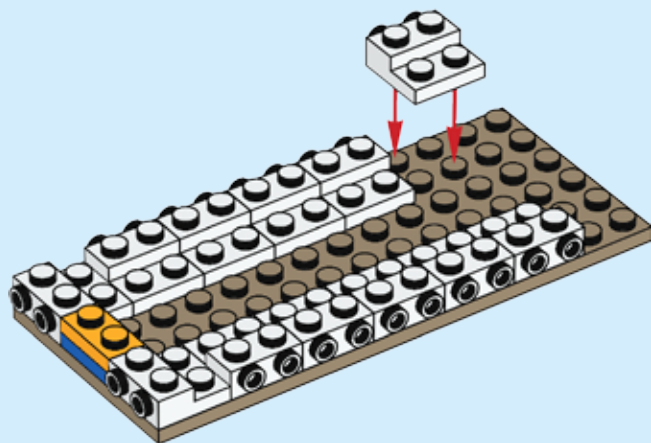



2x

3

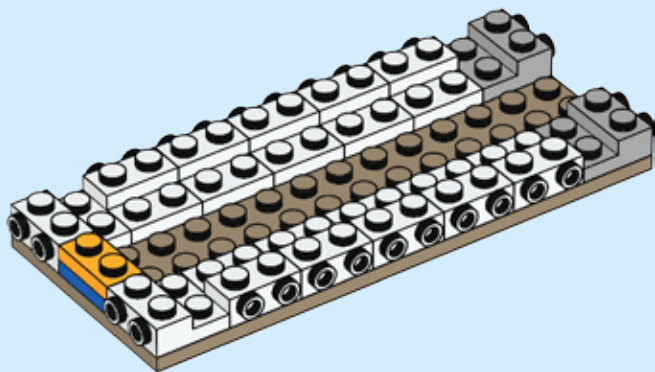



4x

4

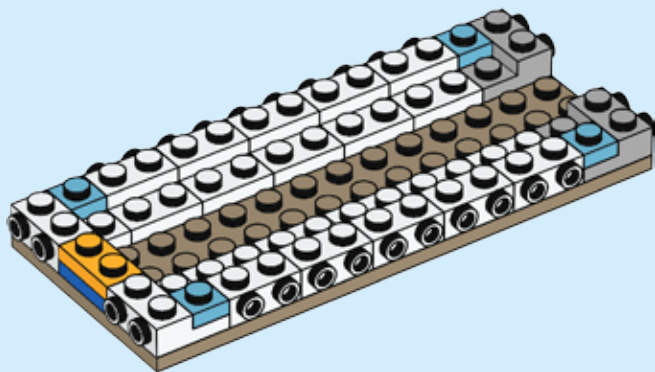

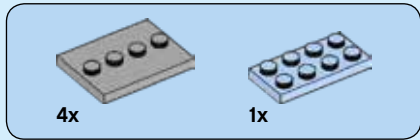

5

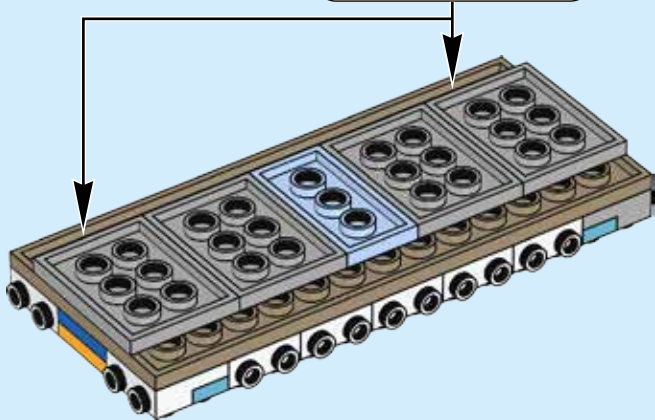
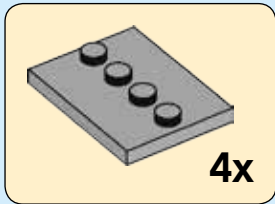
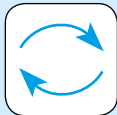





6

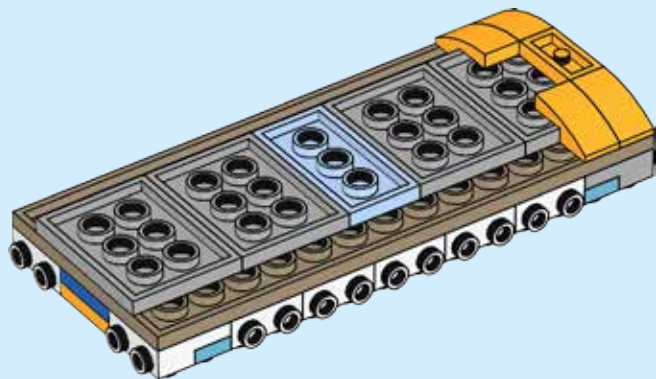



7

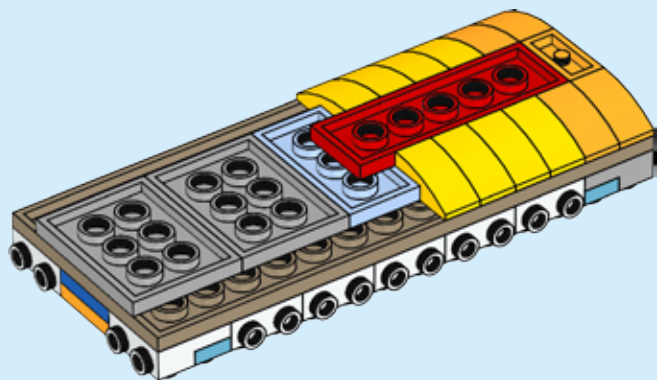



8

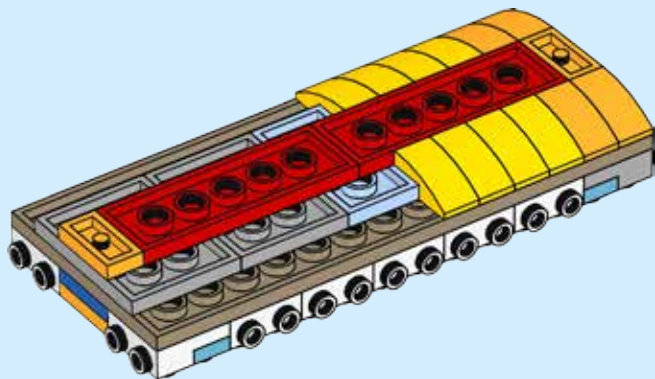



16x

9

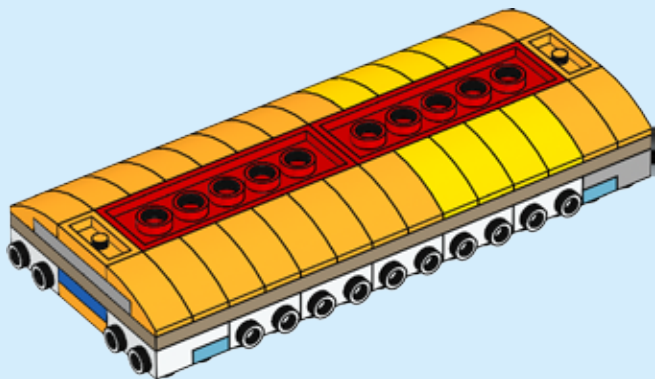



10

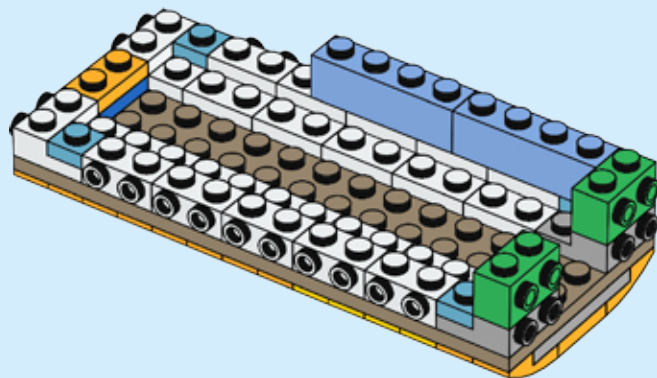
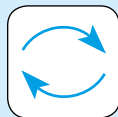



11

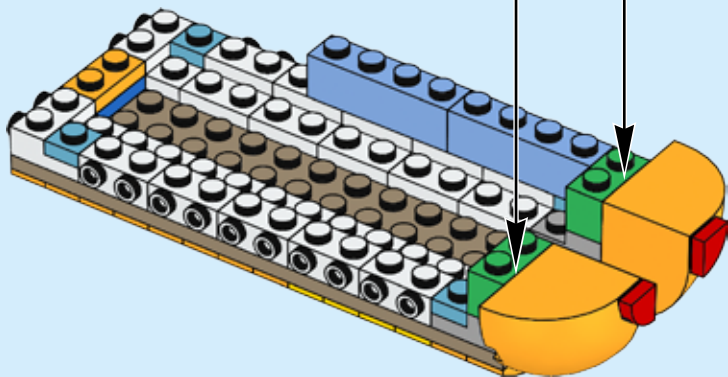
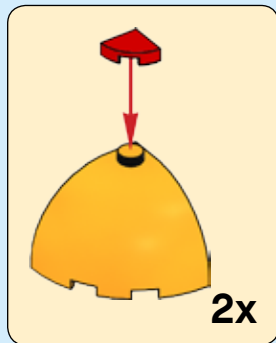



12

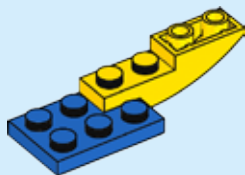

13

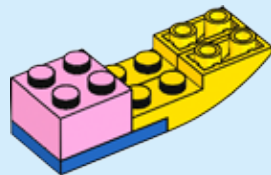



2x

14

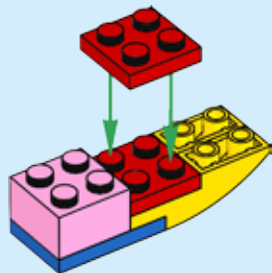

24



1x

15

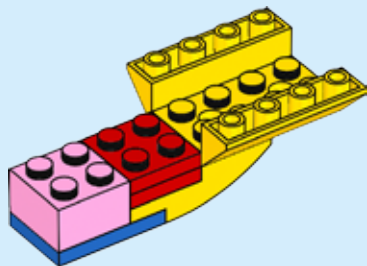





16

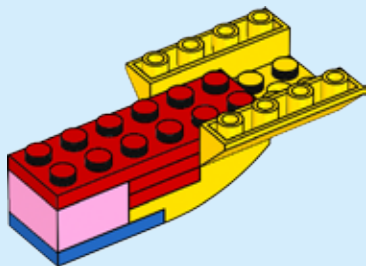

17

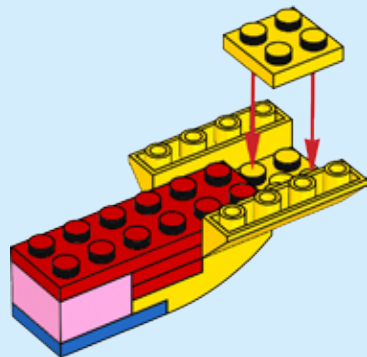

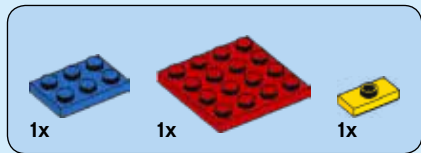

18

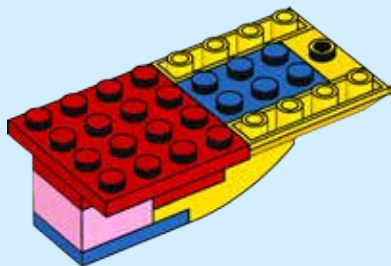

26



19

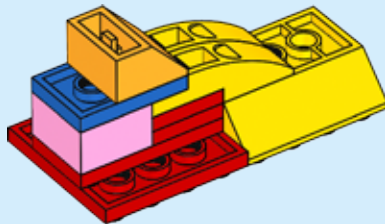
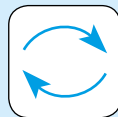

20

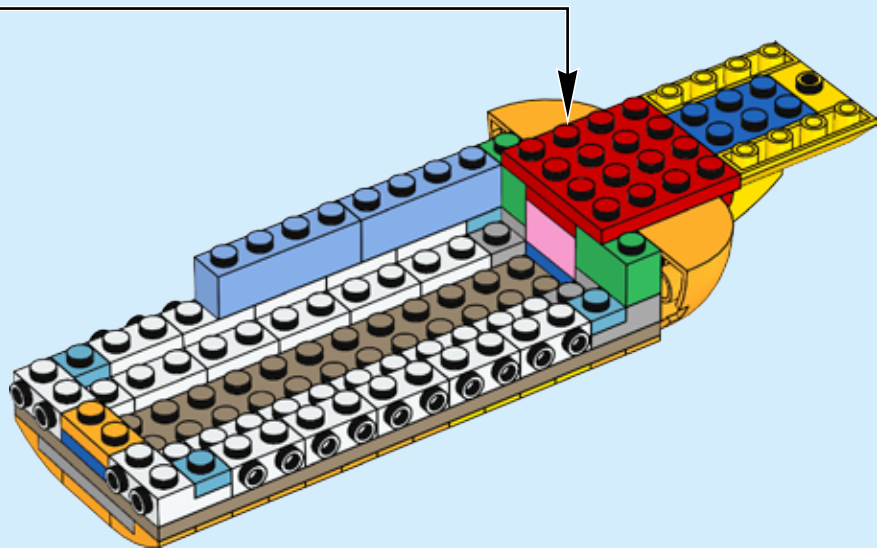

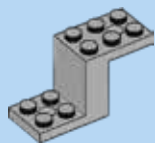

1x

21

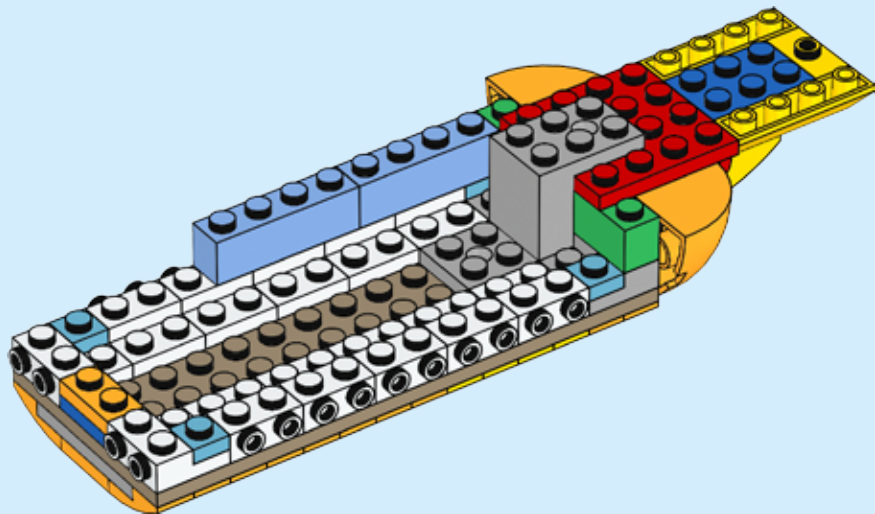

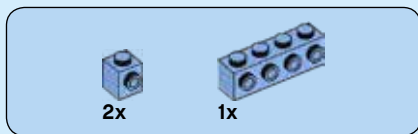

22

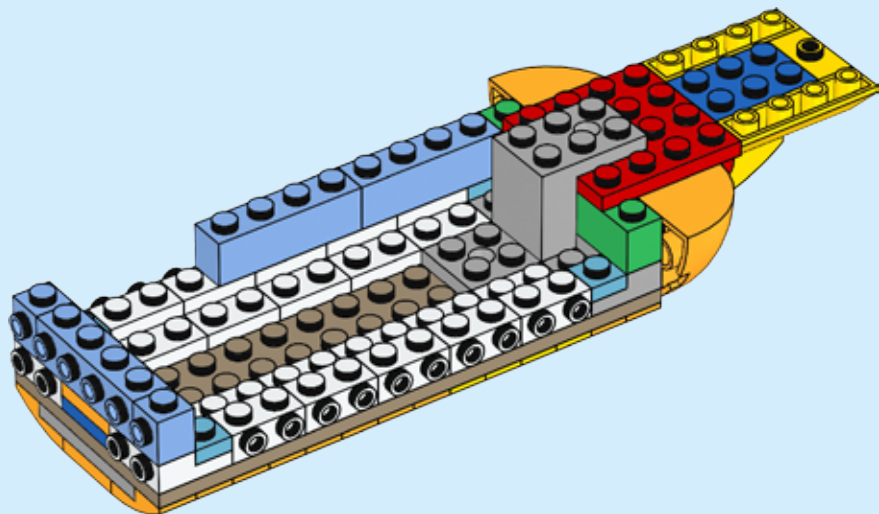



2x



1x

# 23

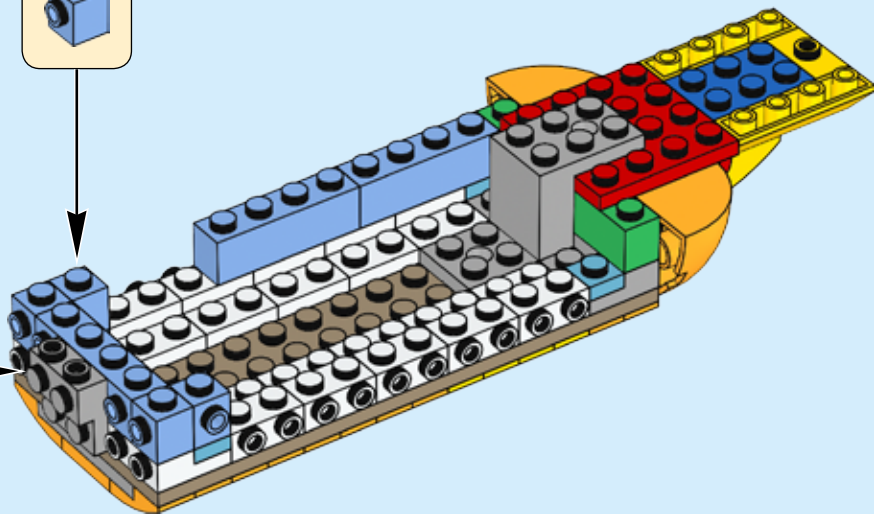
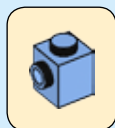



24

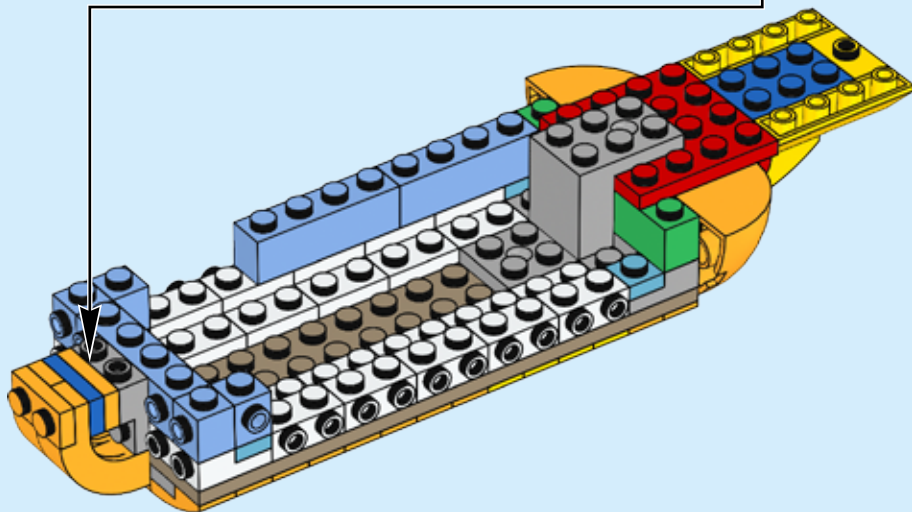
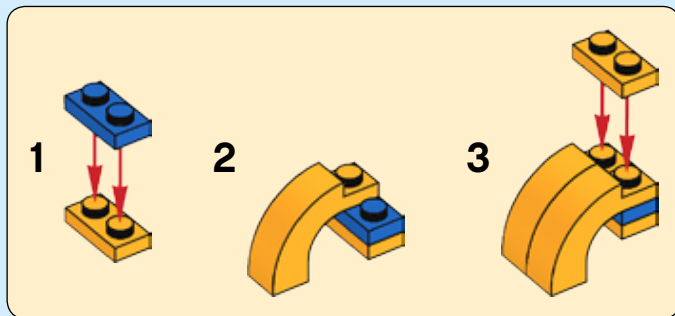



2x

25

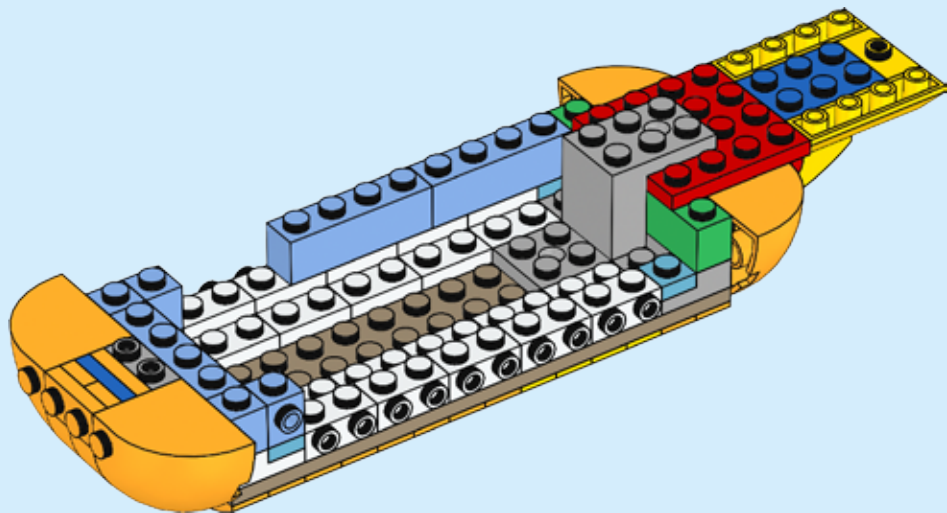





2x

26

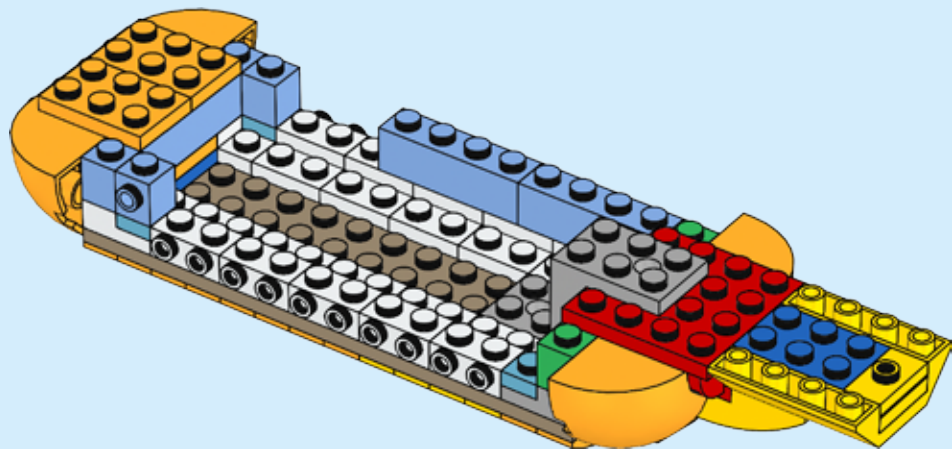

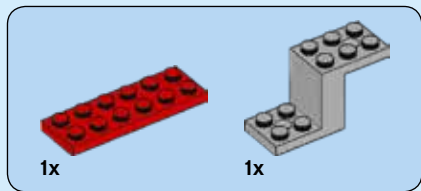

27

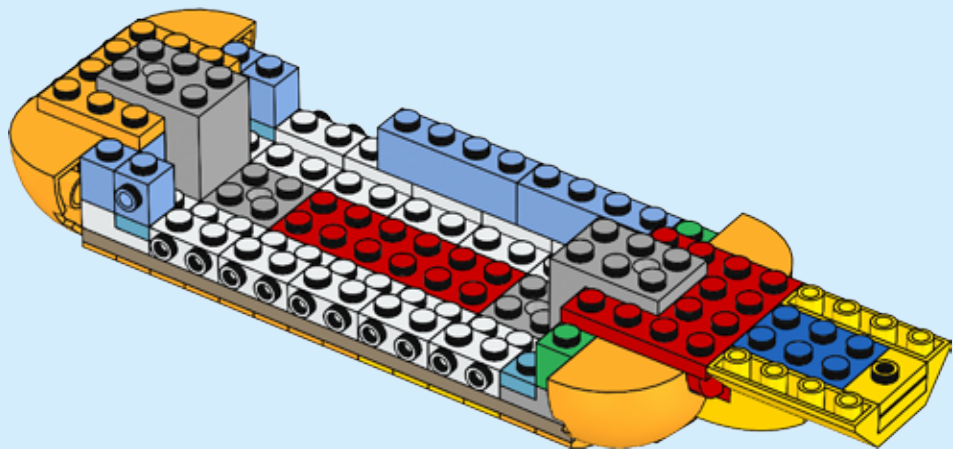

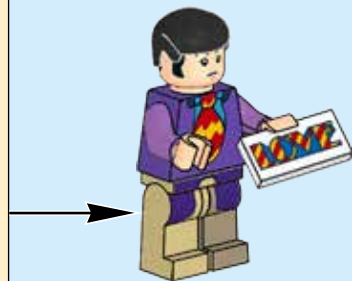
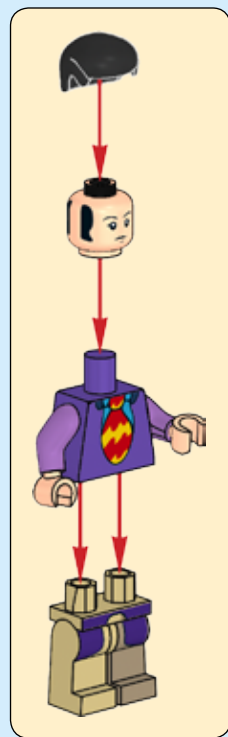
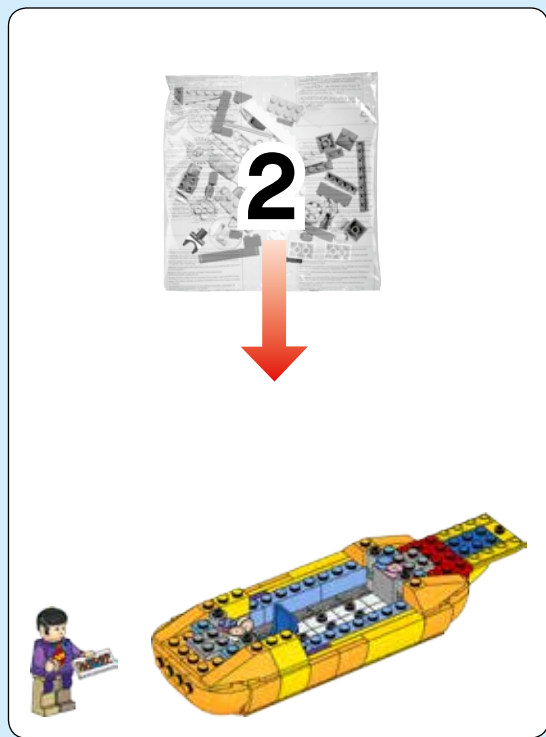



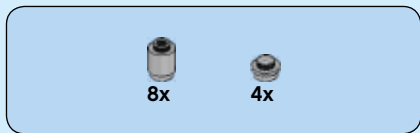

28

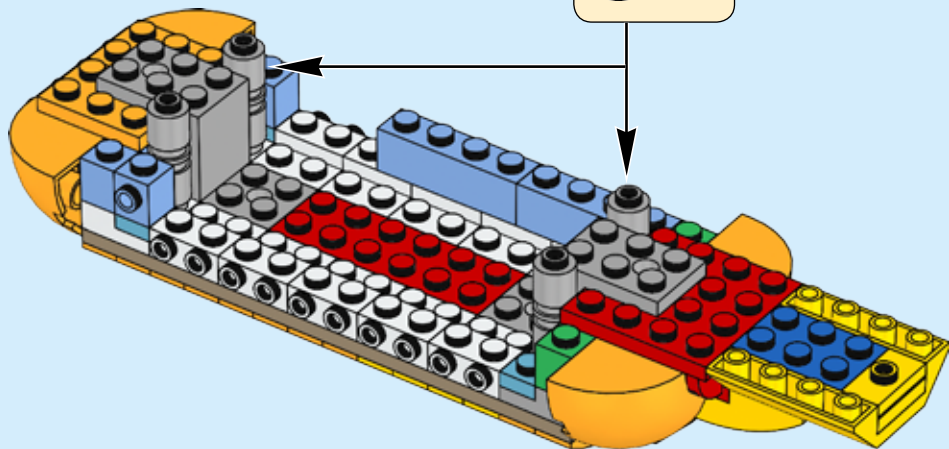
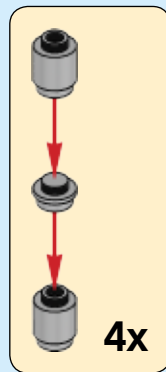



10x

29

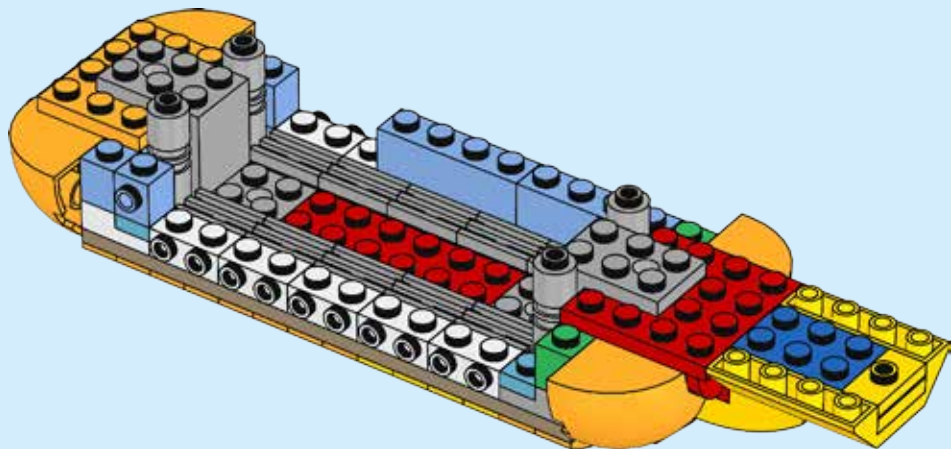

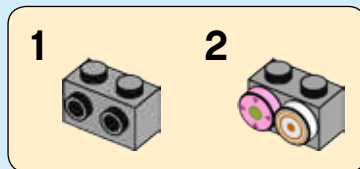
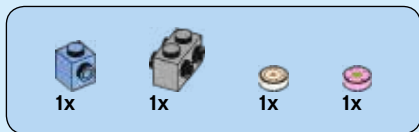

30

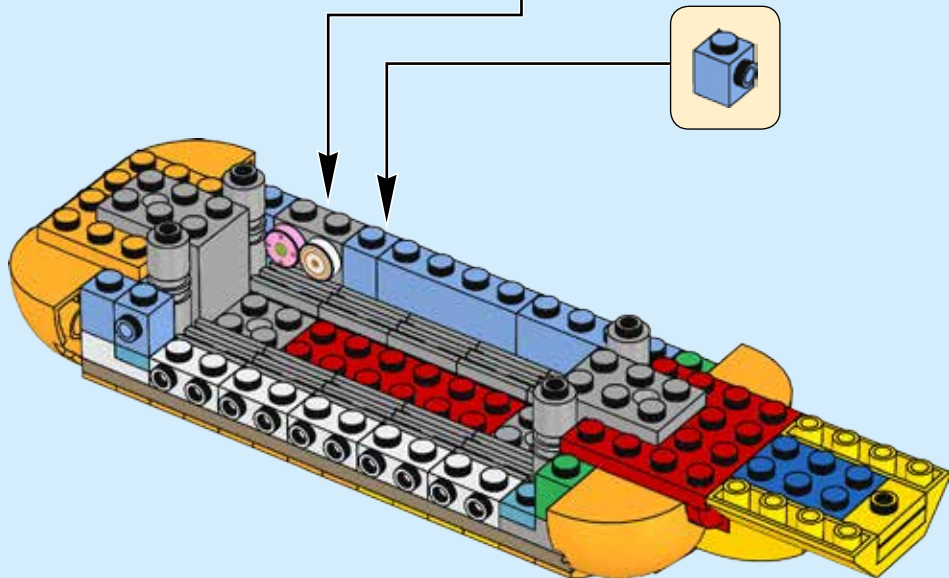



2x



6x

# 31



2x

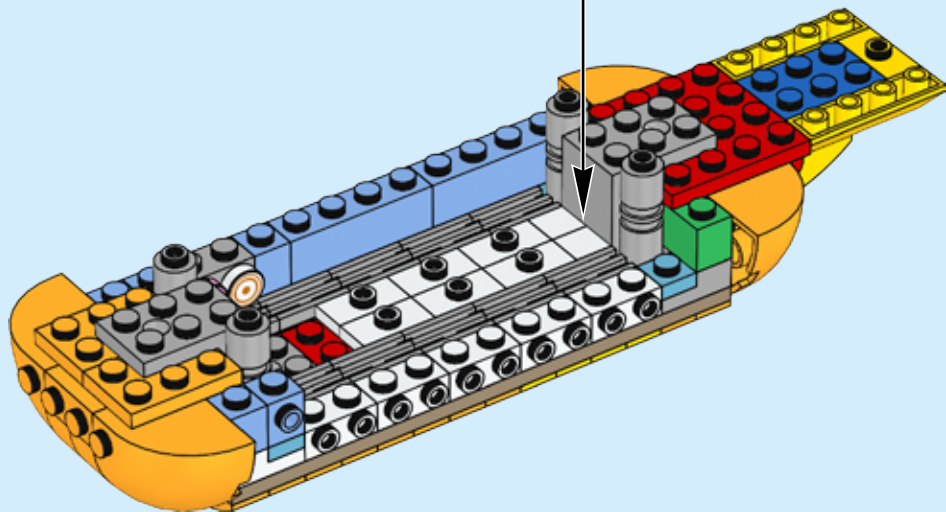





32

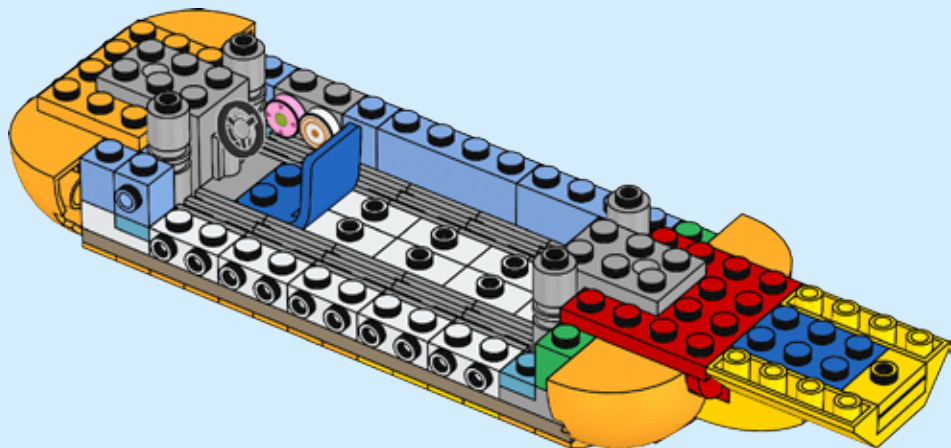



1x



2x

# 33

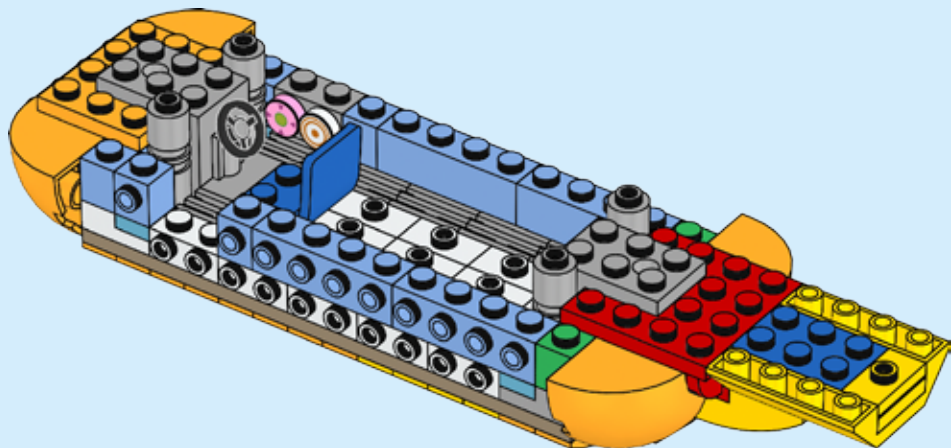

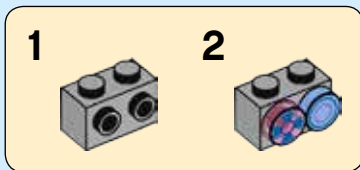
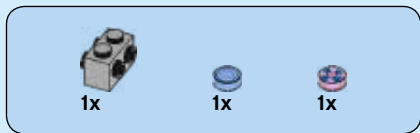

34

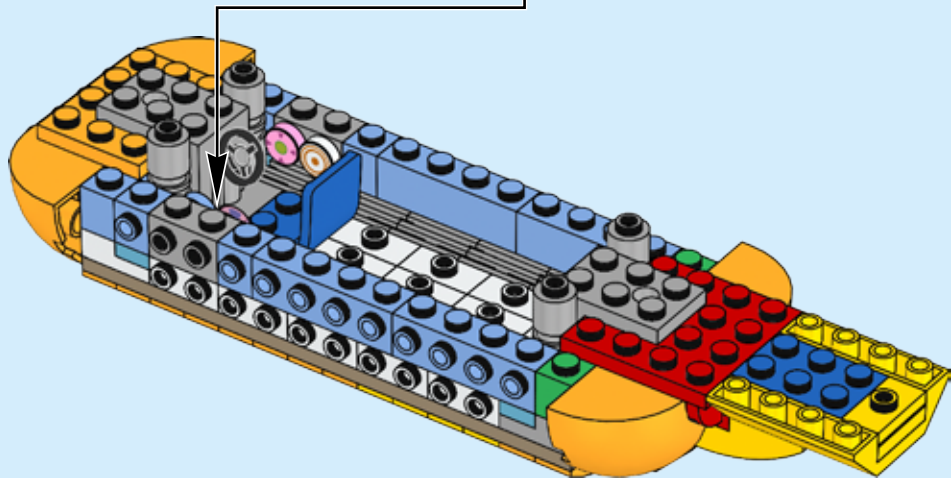

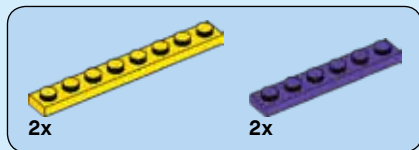

35

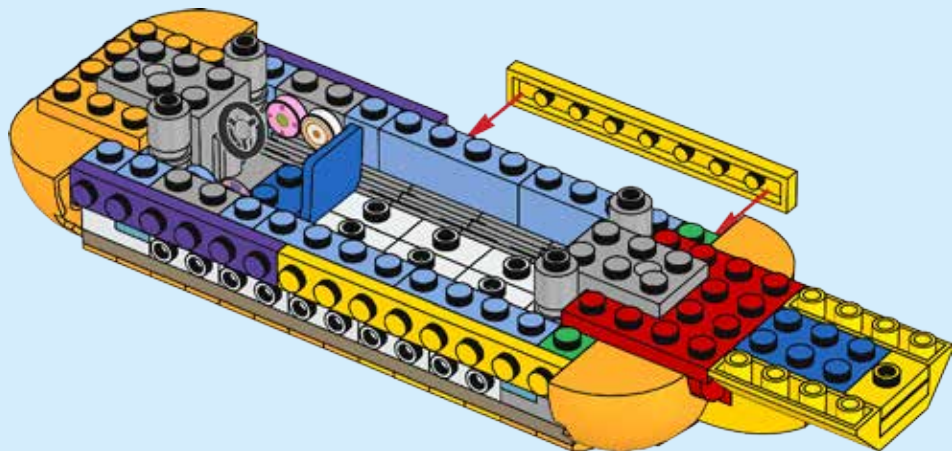



36

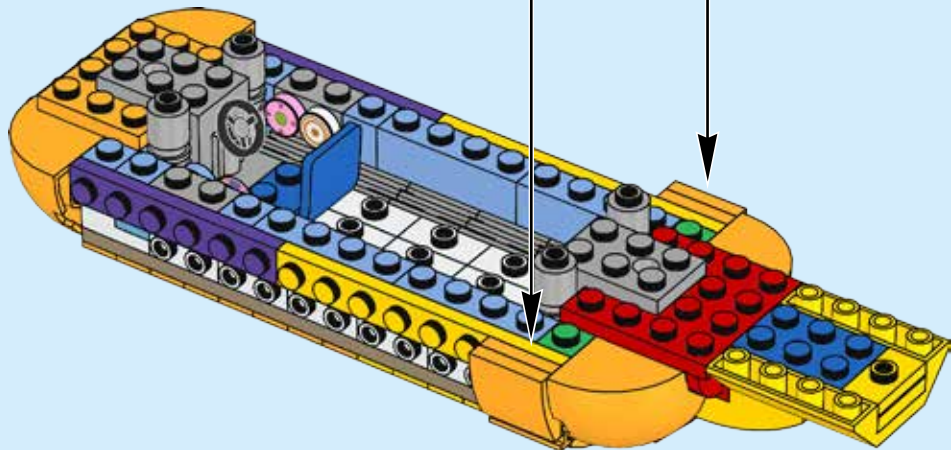
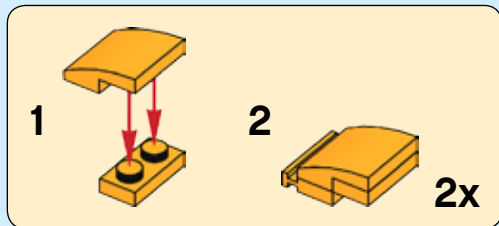

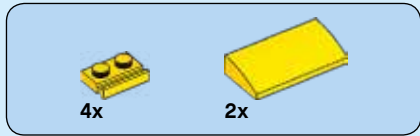

37

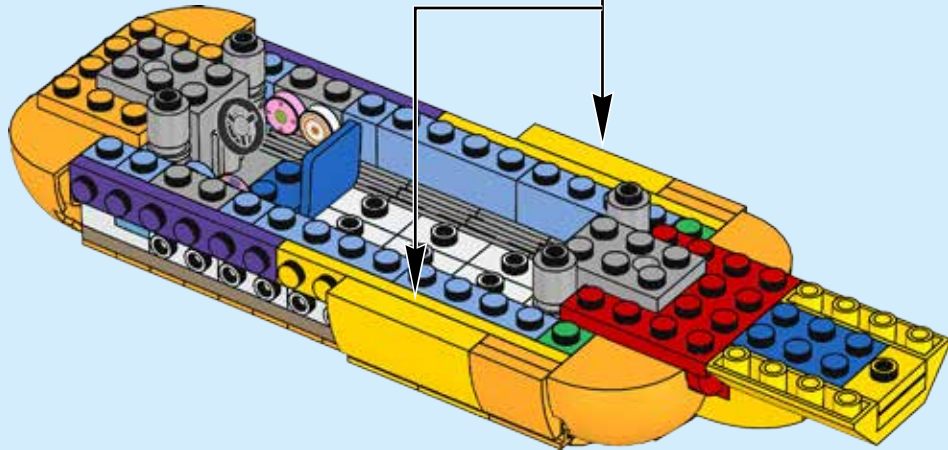
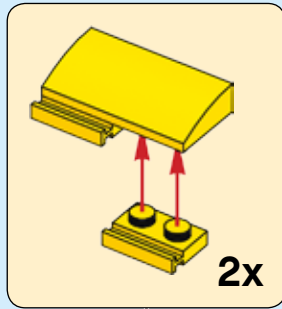

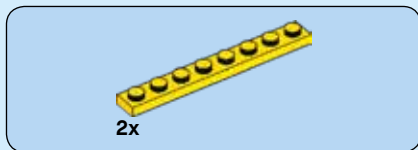

38

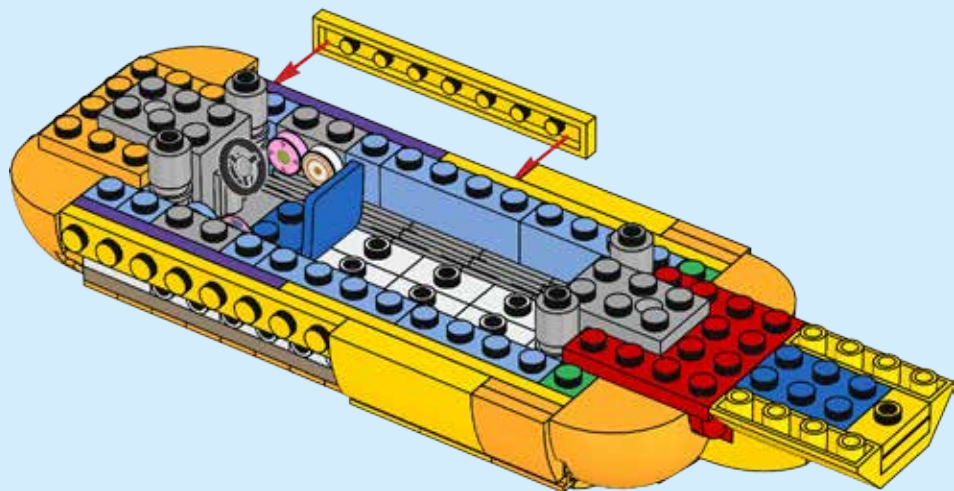

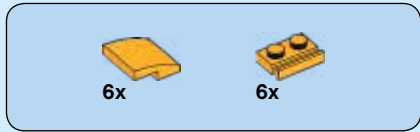

39

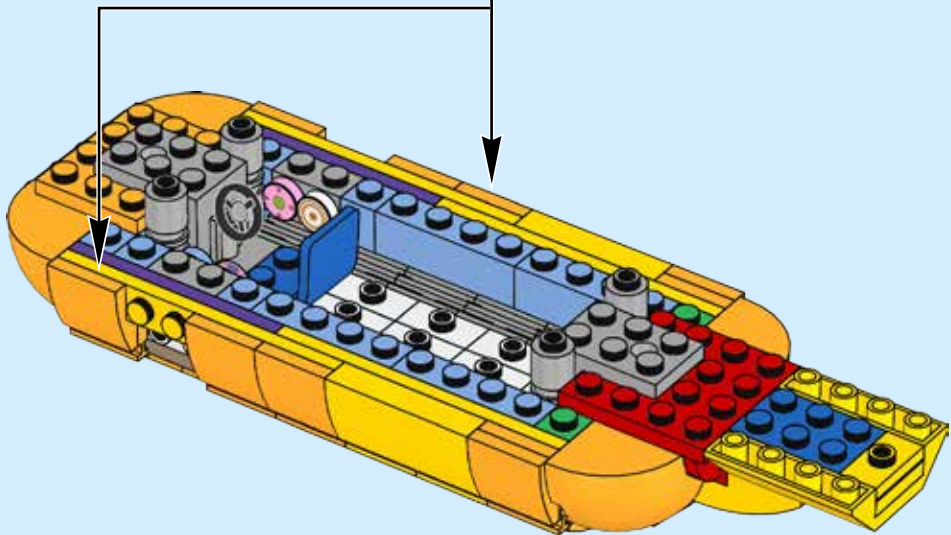
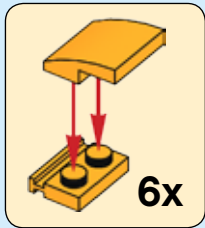



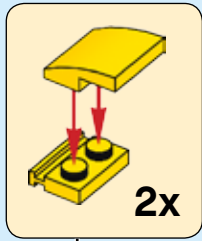
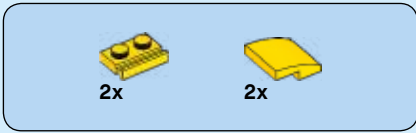

40

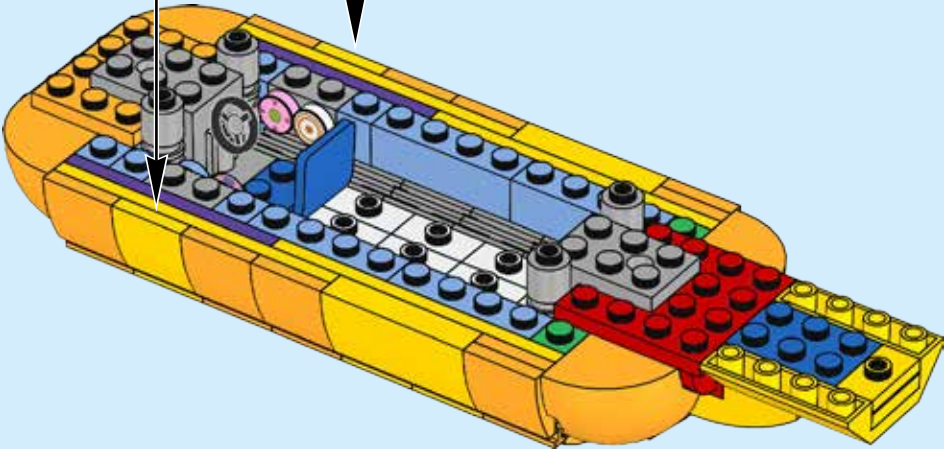

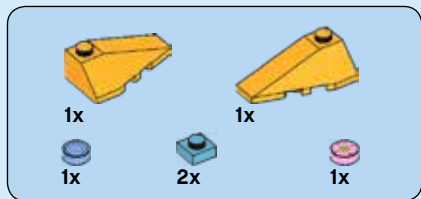

41

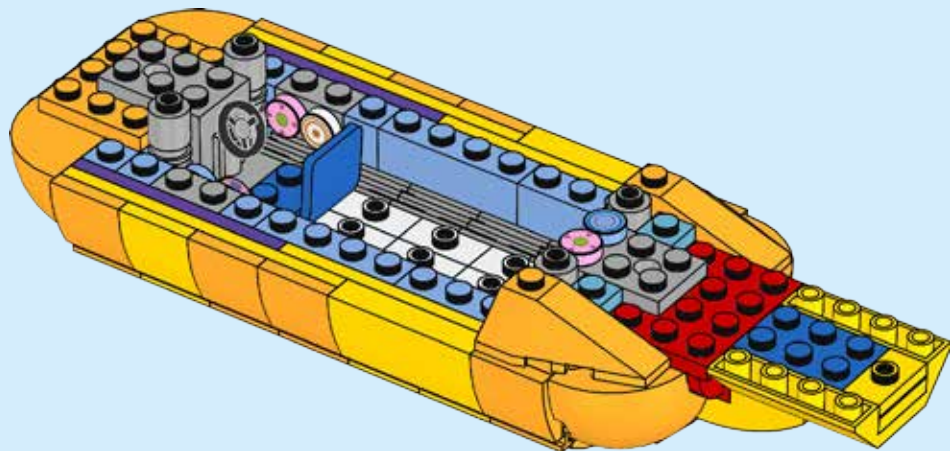



2x



1x



1x

# 42

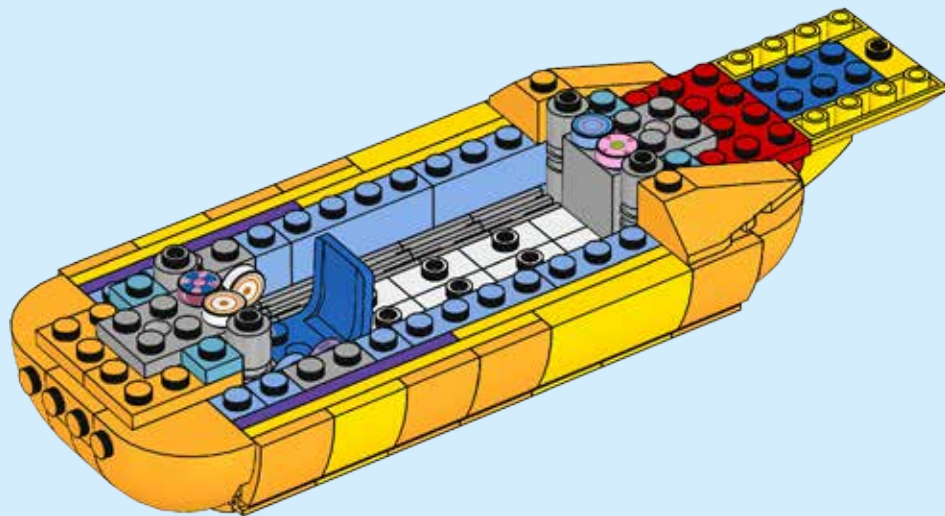

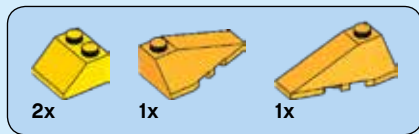

43

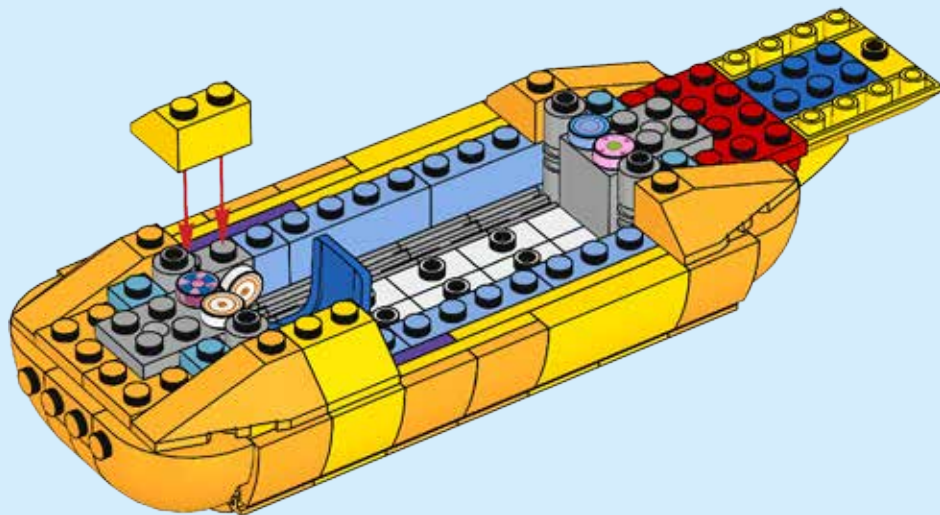

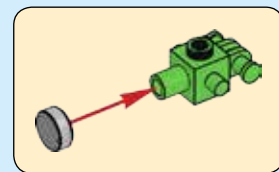
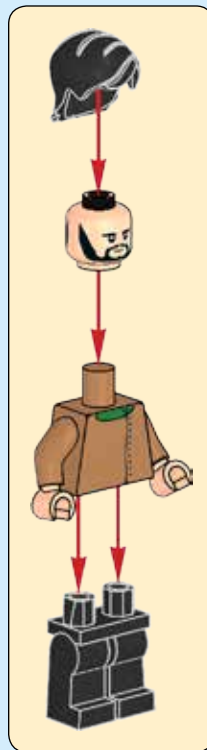
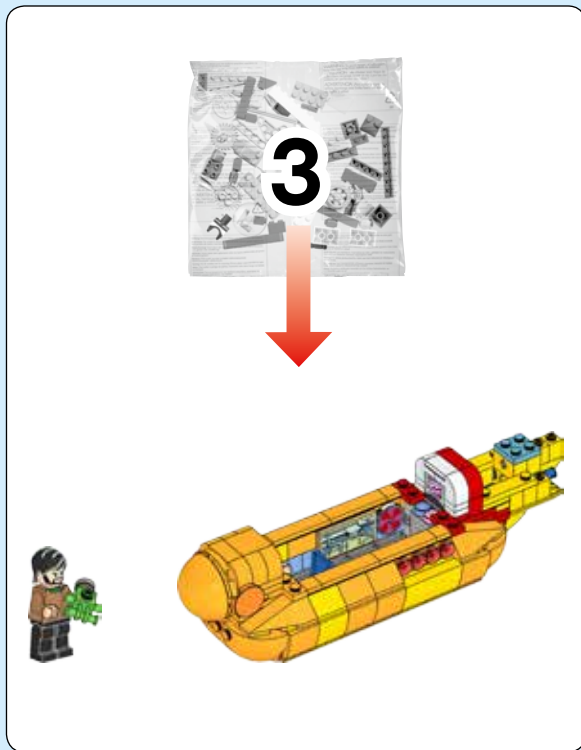





44

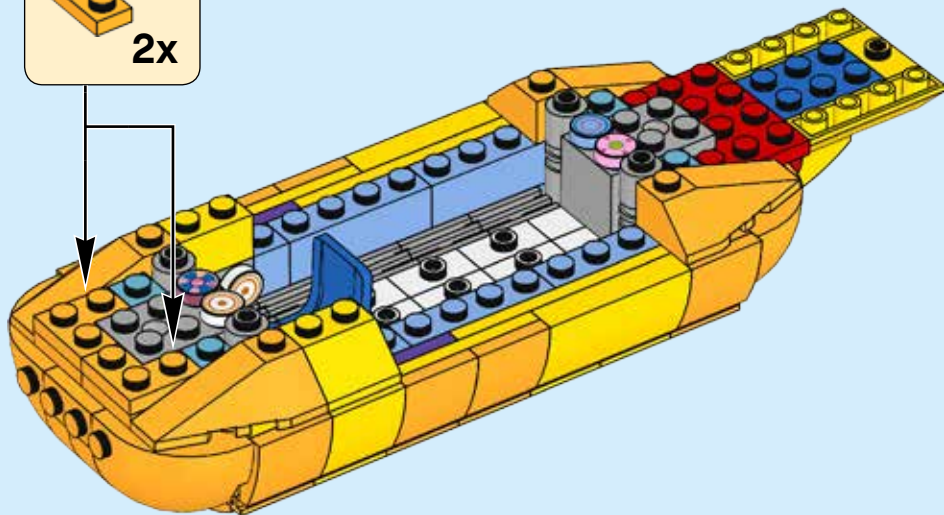



2x

45

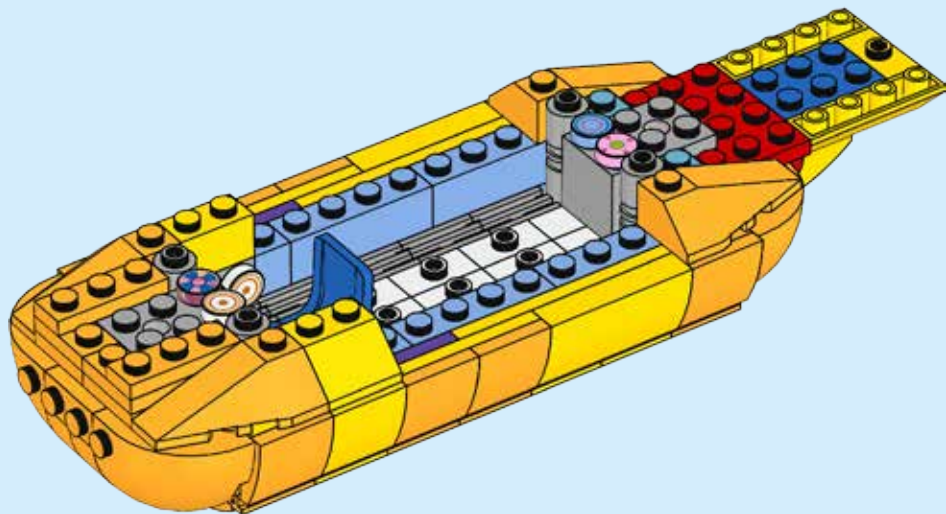





46

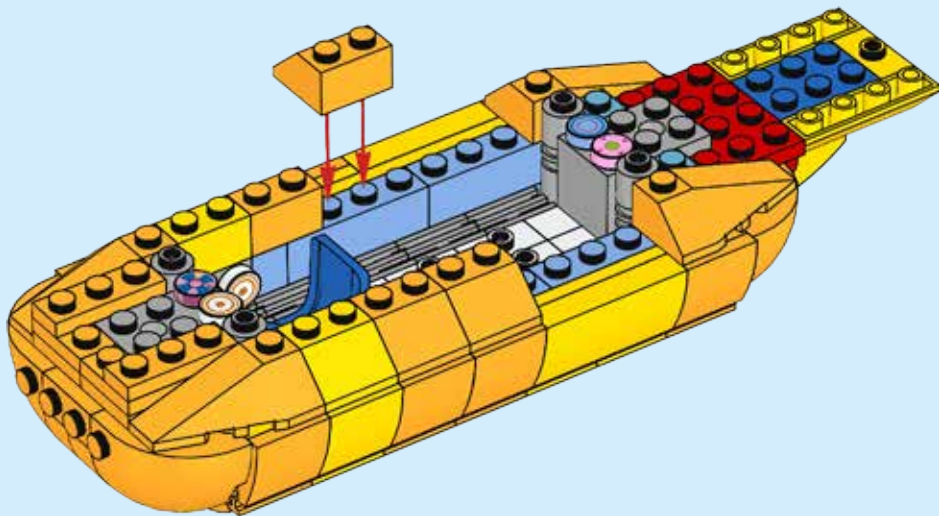



47

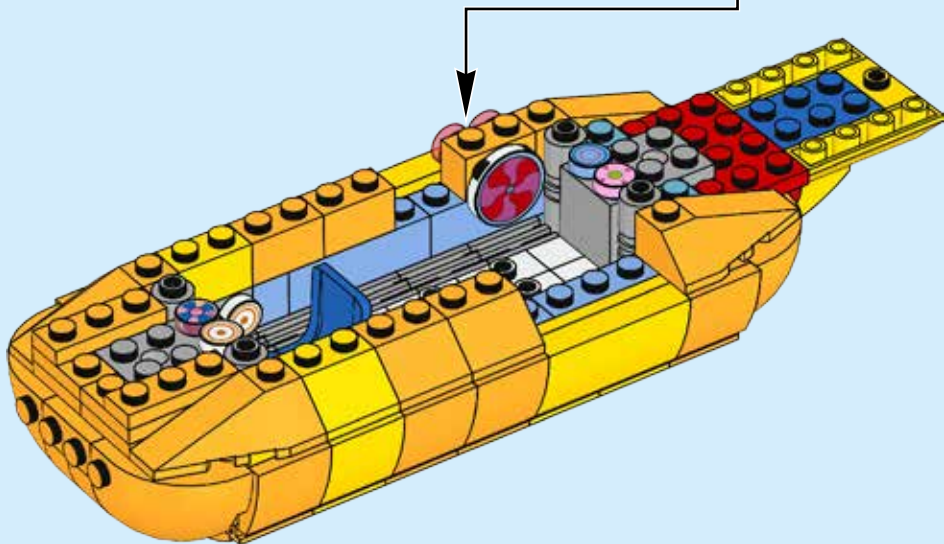



48

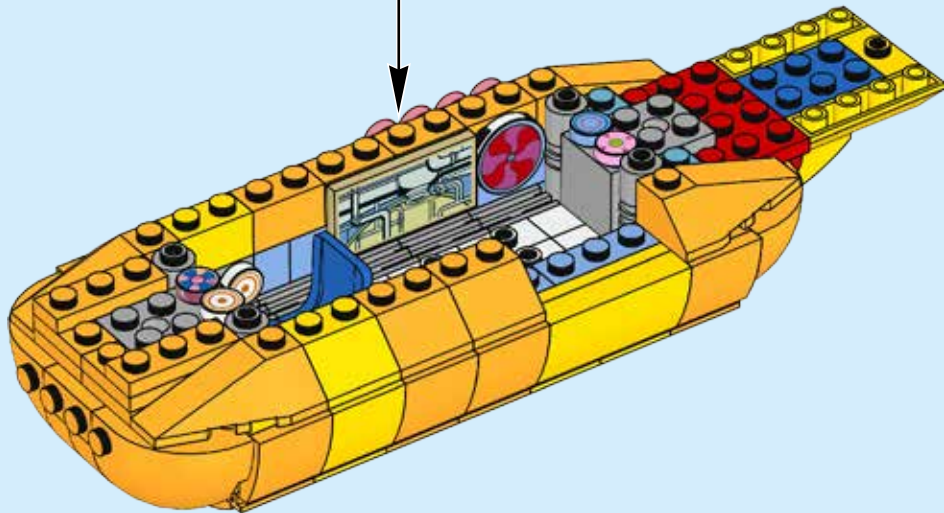
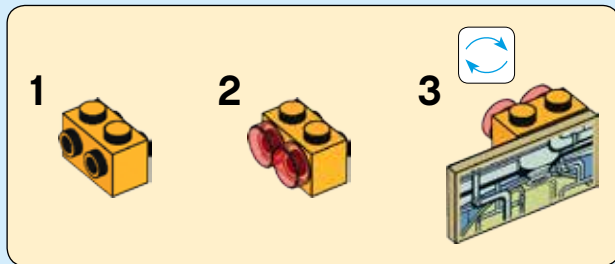



49

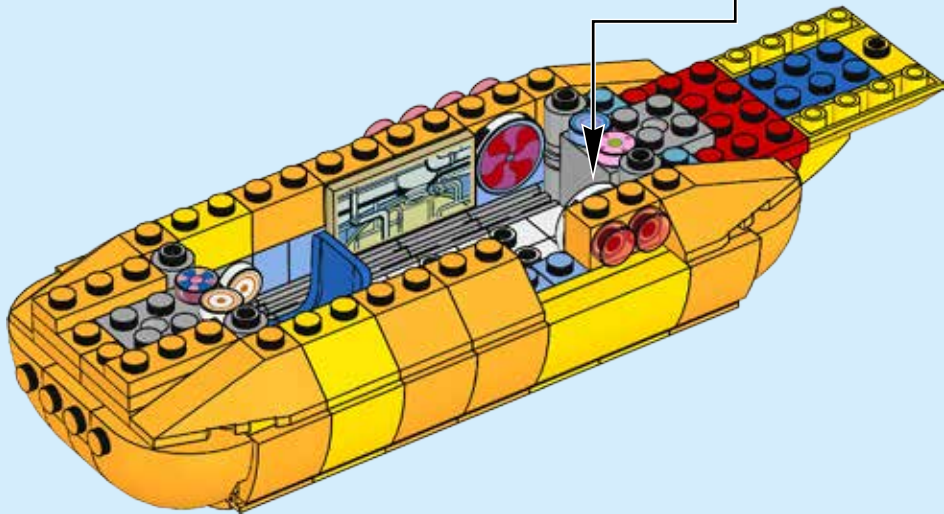



50

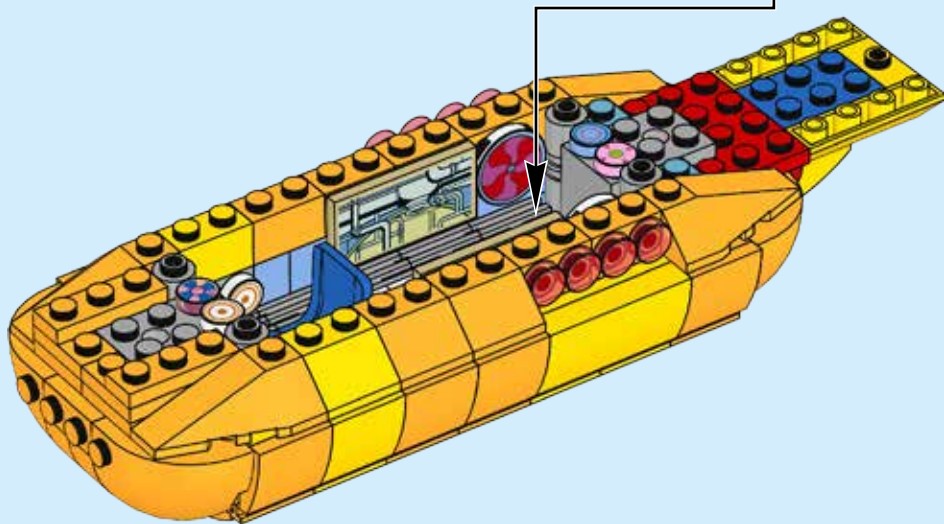
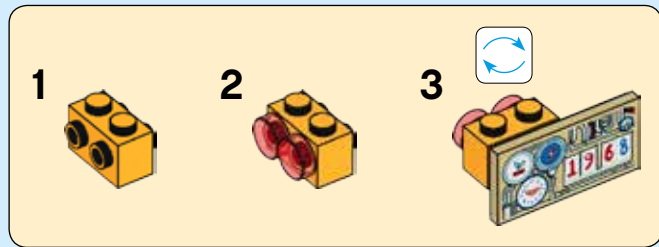

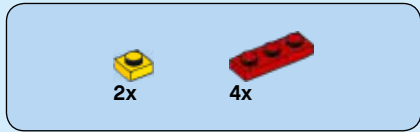

51

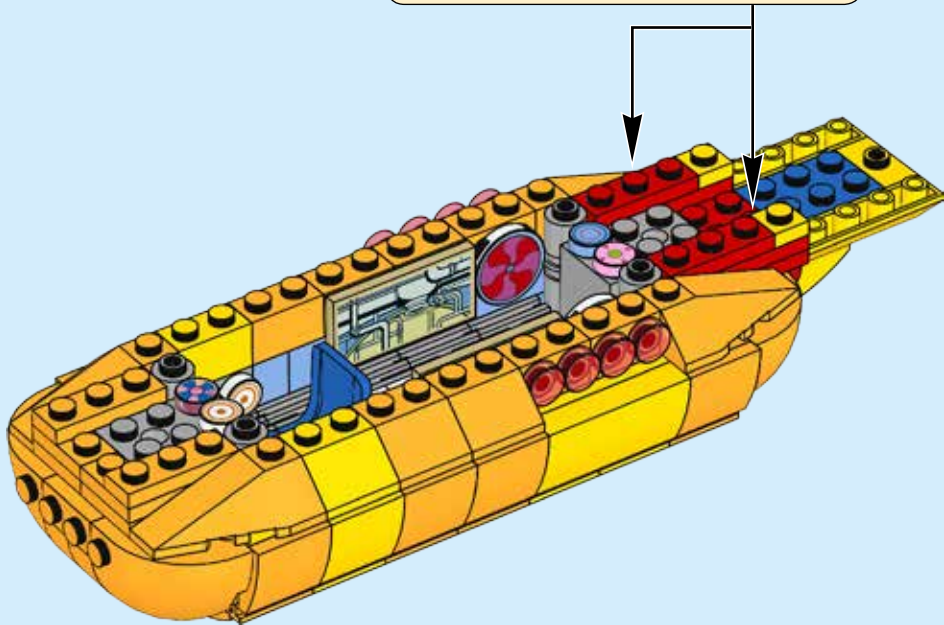
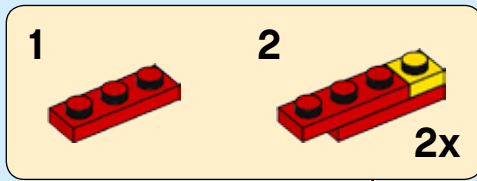



2x



2x

# 52

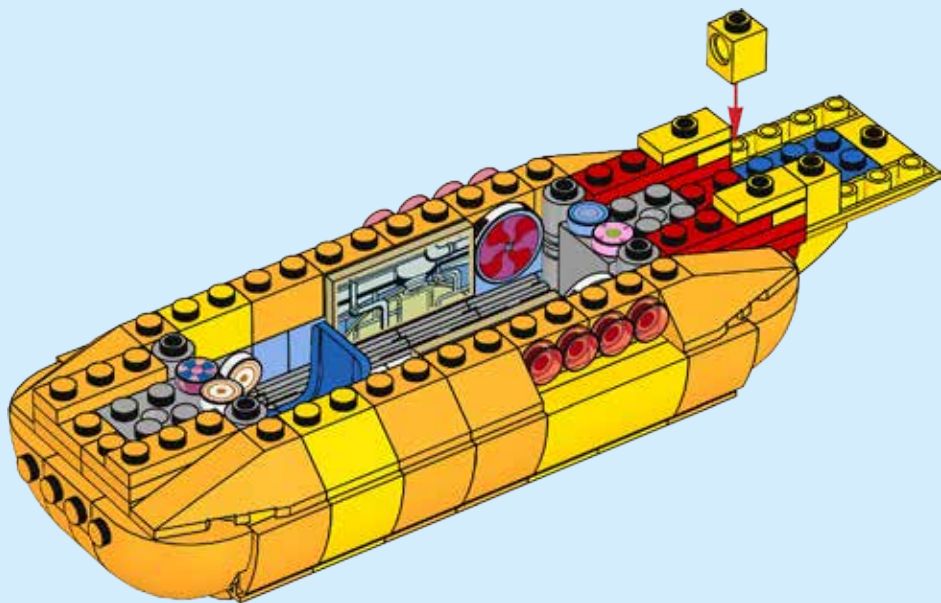



53

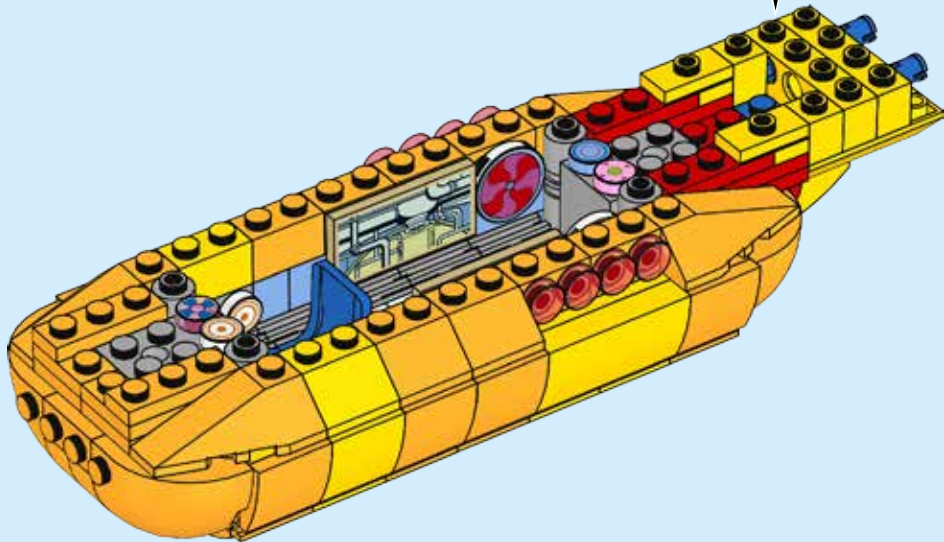
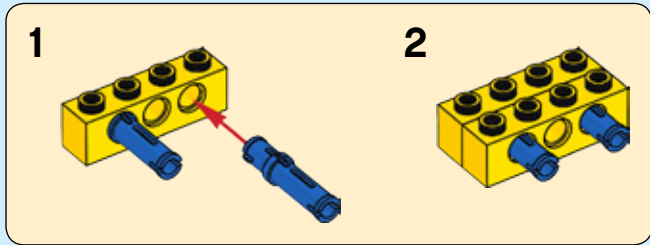



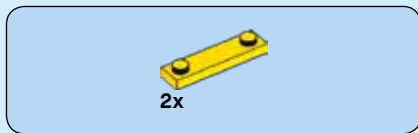

54

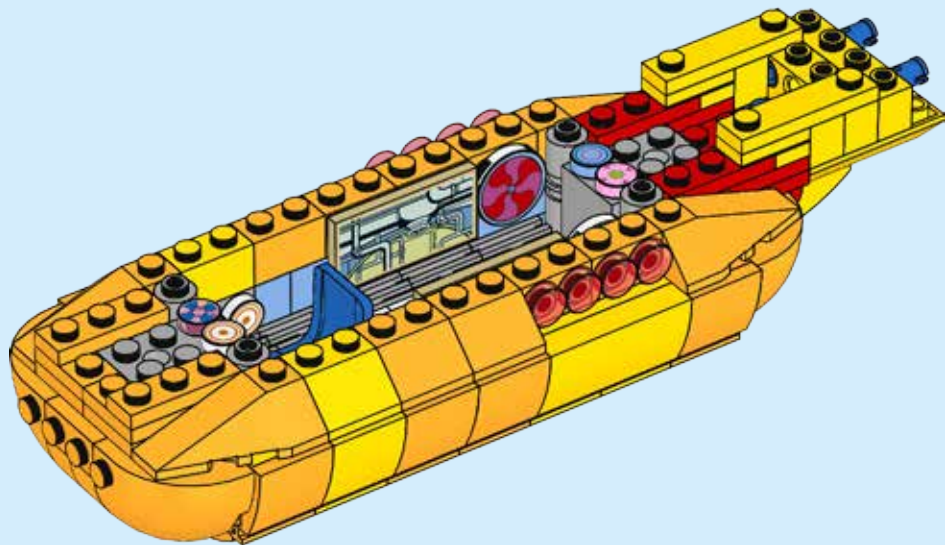



2x

55

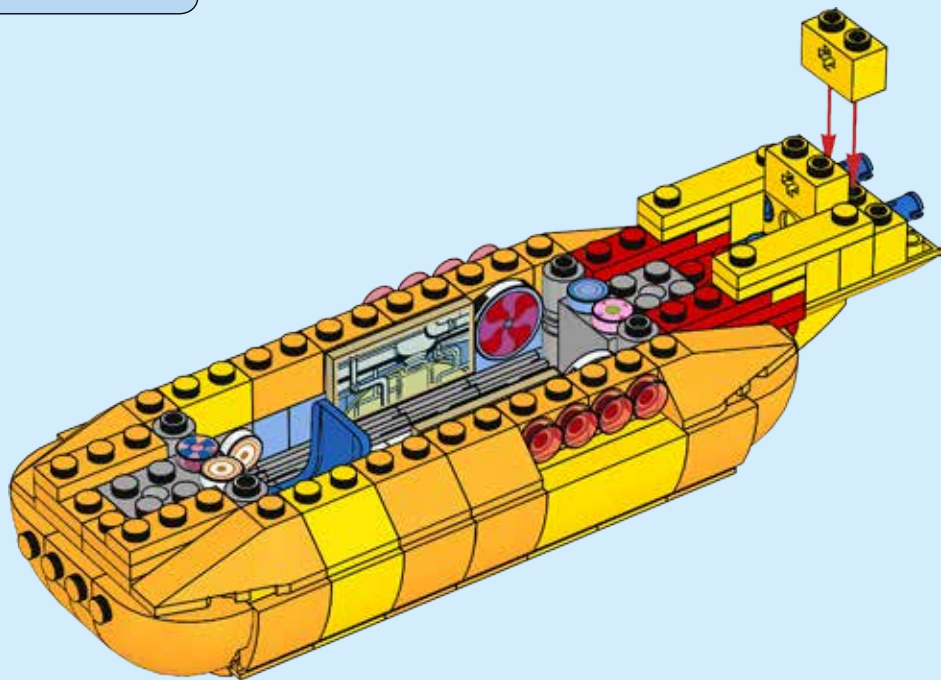

66



56

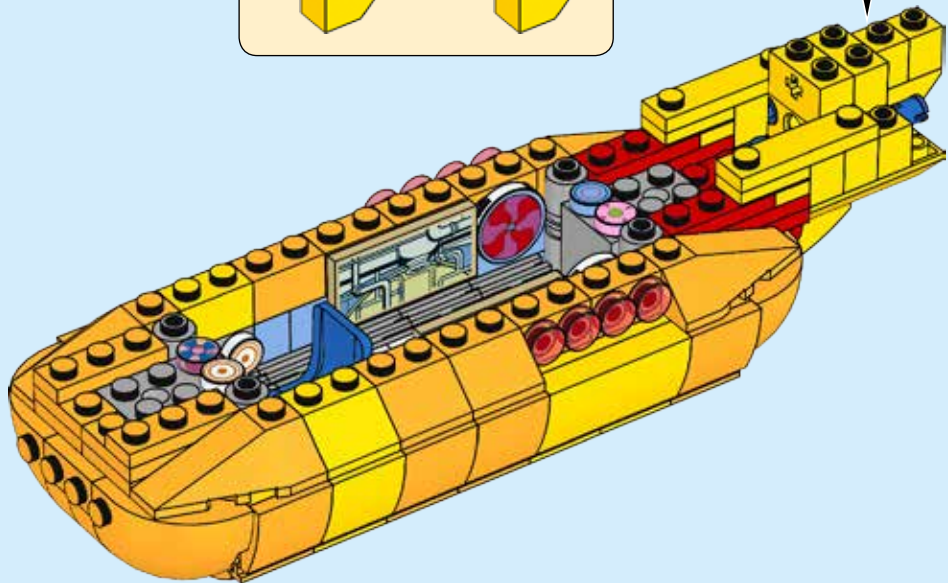
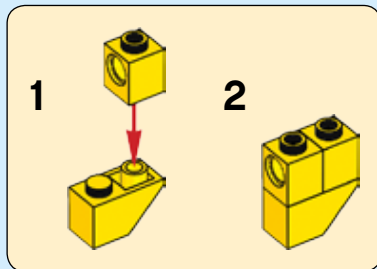

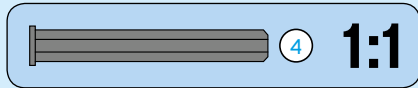
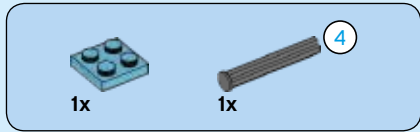

57

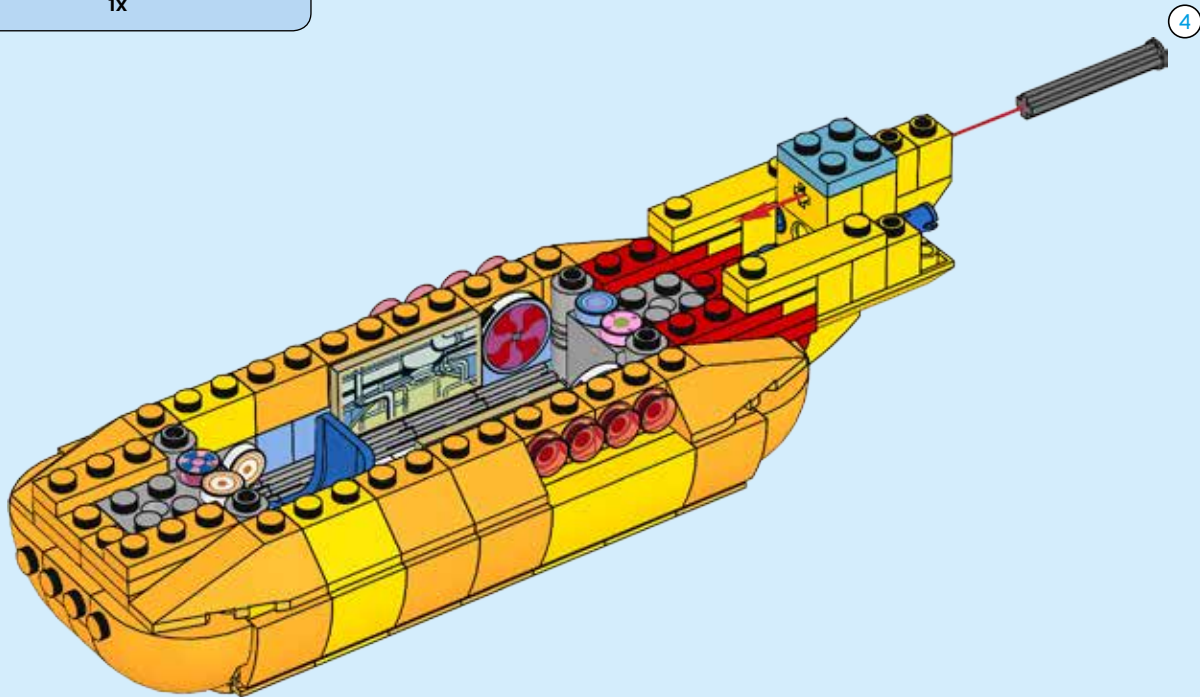

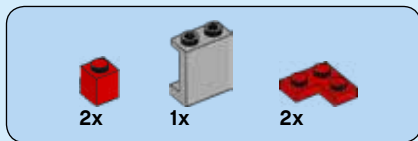

58

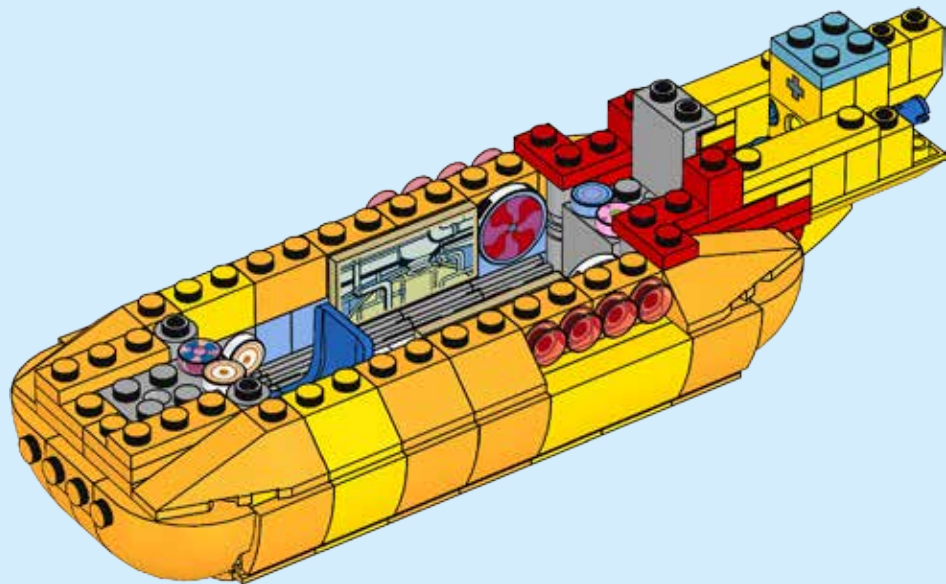



4x

59

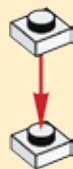

2x

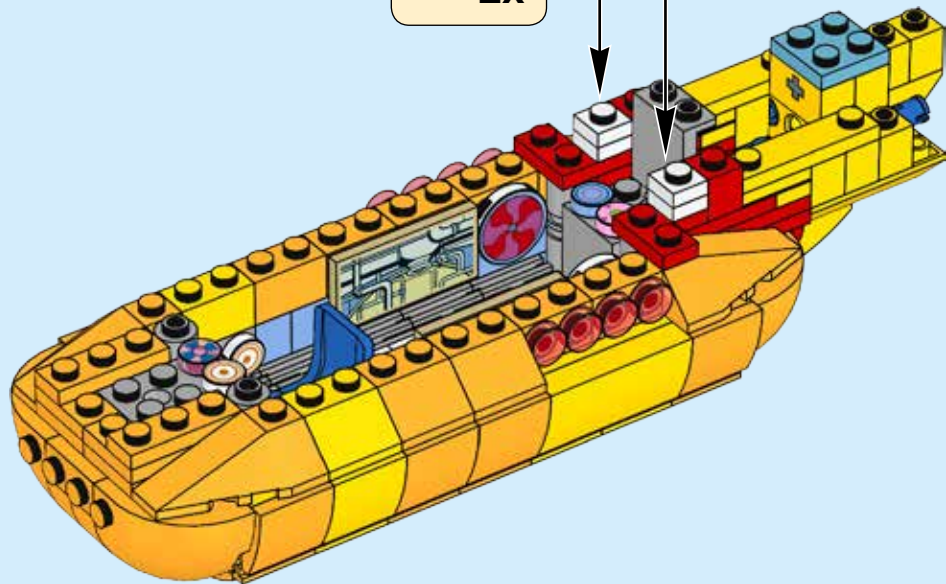

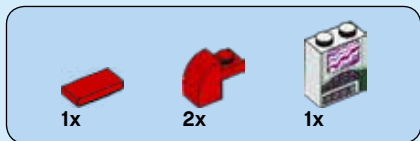

60

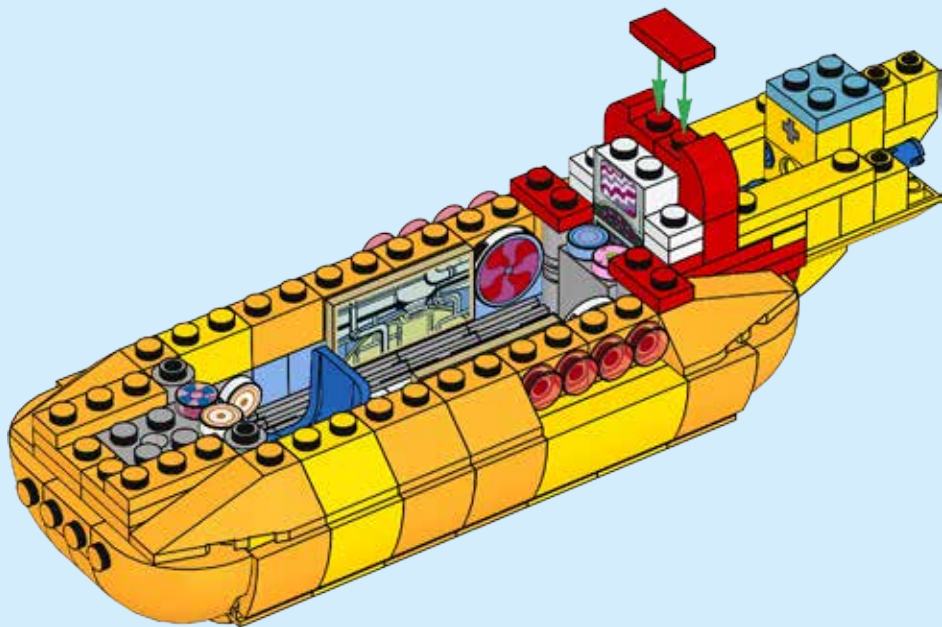



1x



2x

61

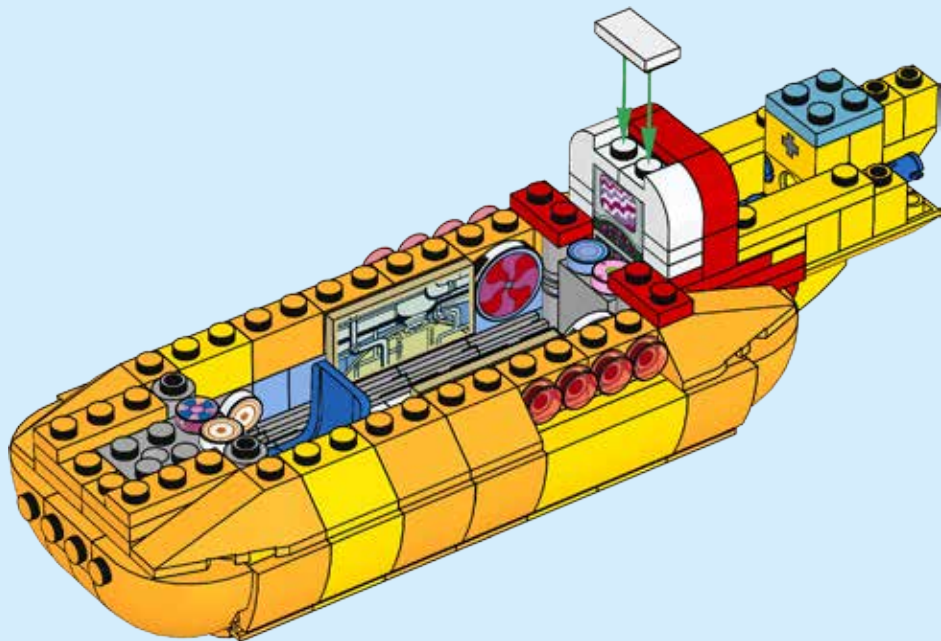



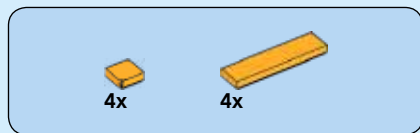

62

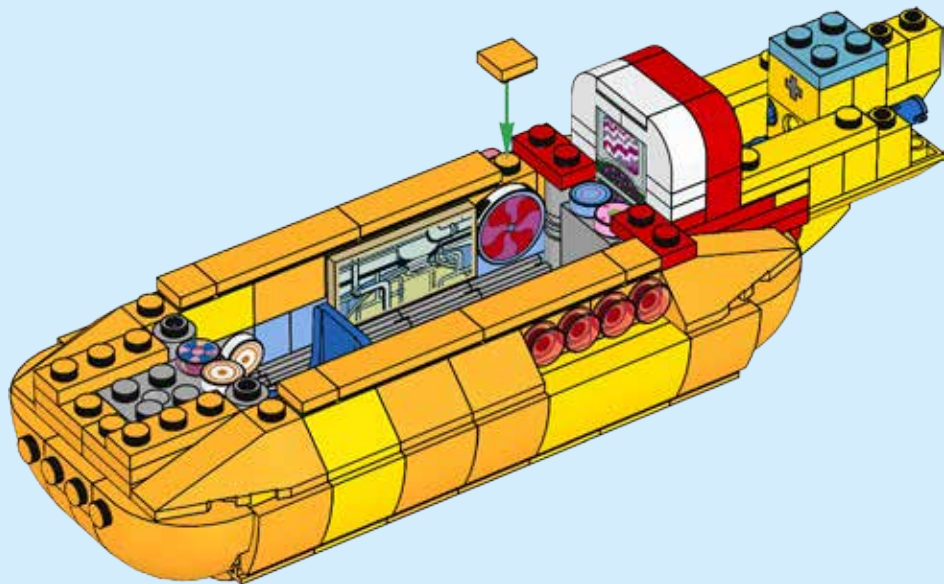



2x



2x

# 63

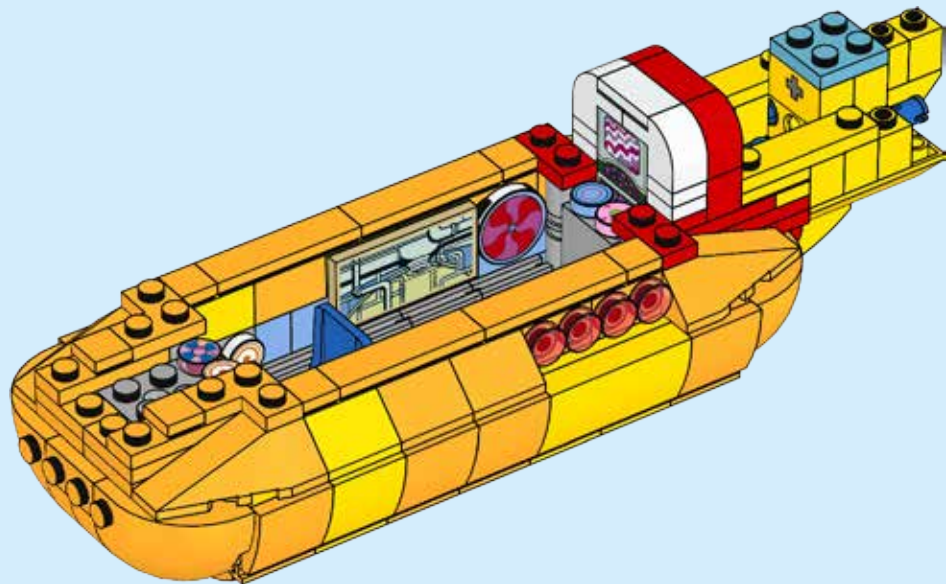

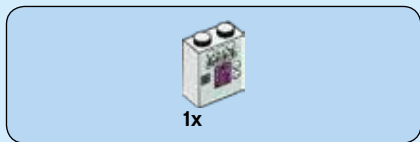

64

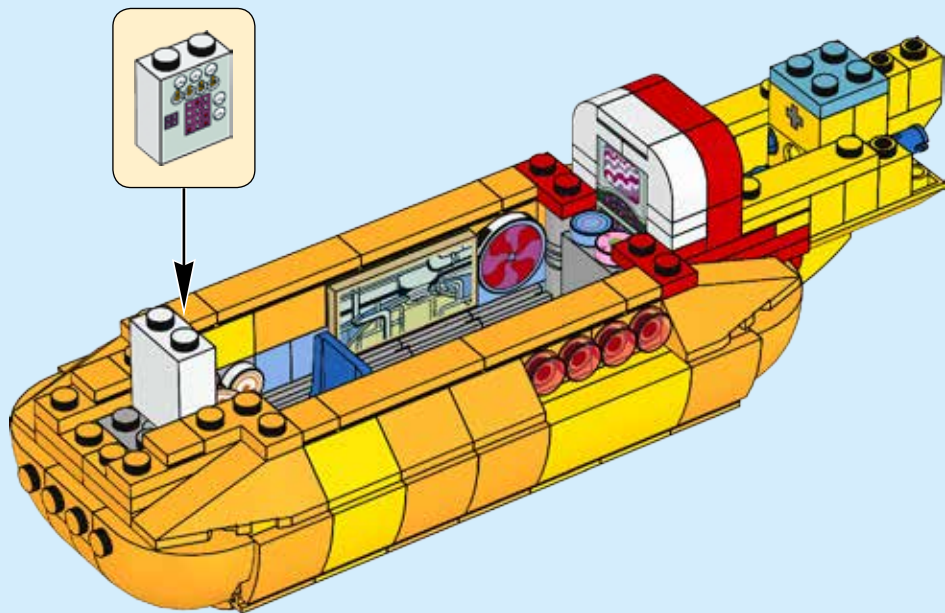



4x



1x

# 65

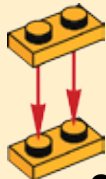

2x

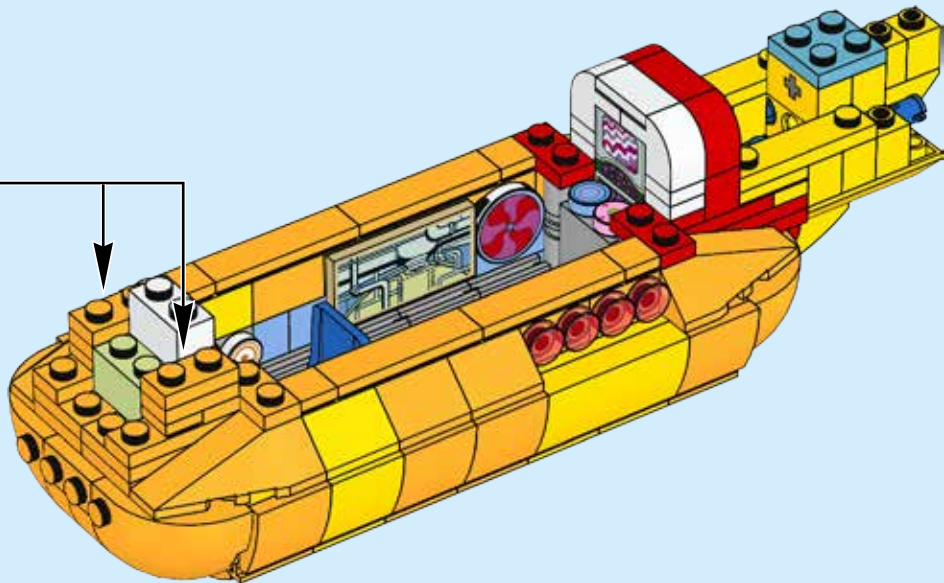



2x



1x

66

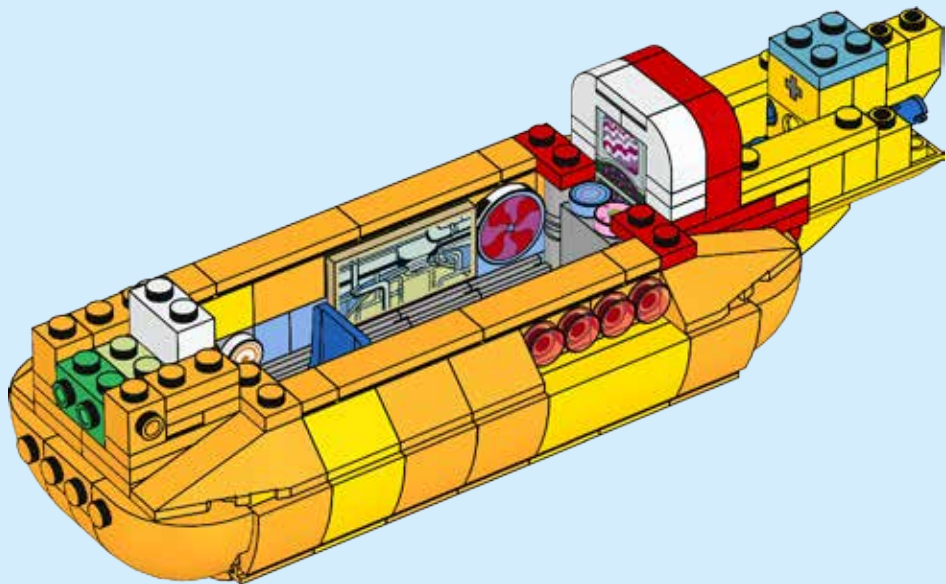

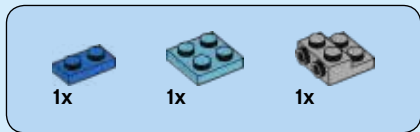

67

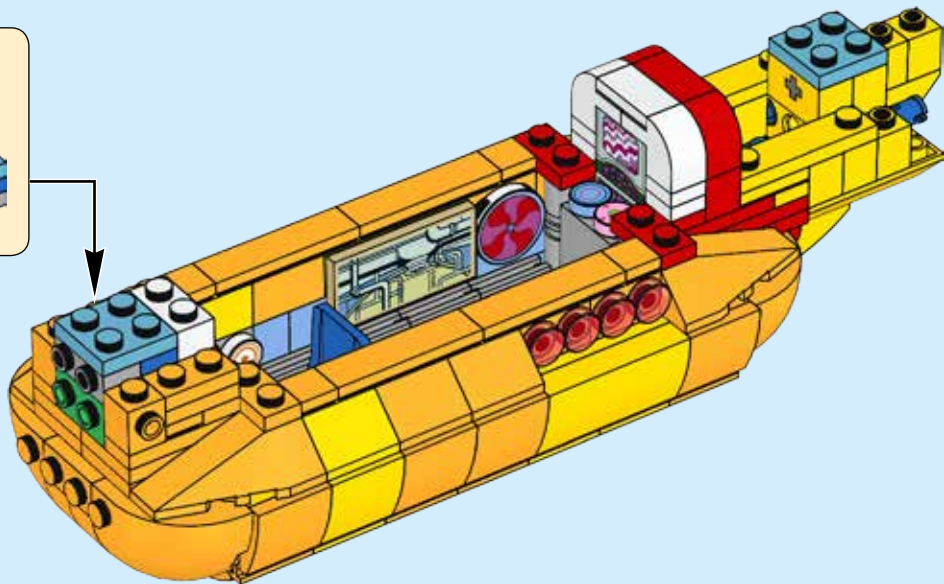
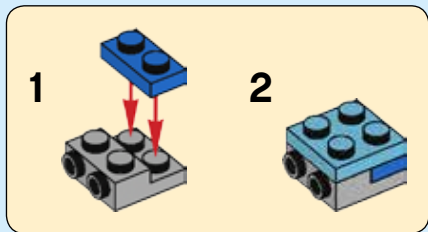



6x

68

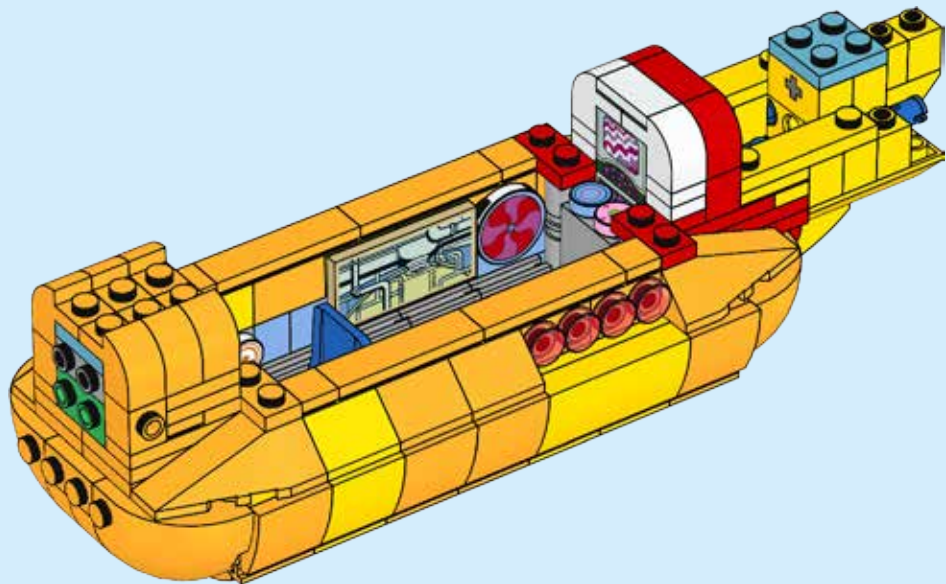



1x



1x

69

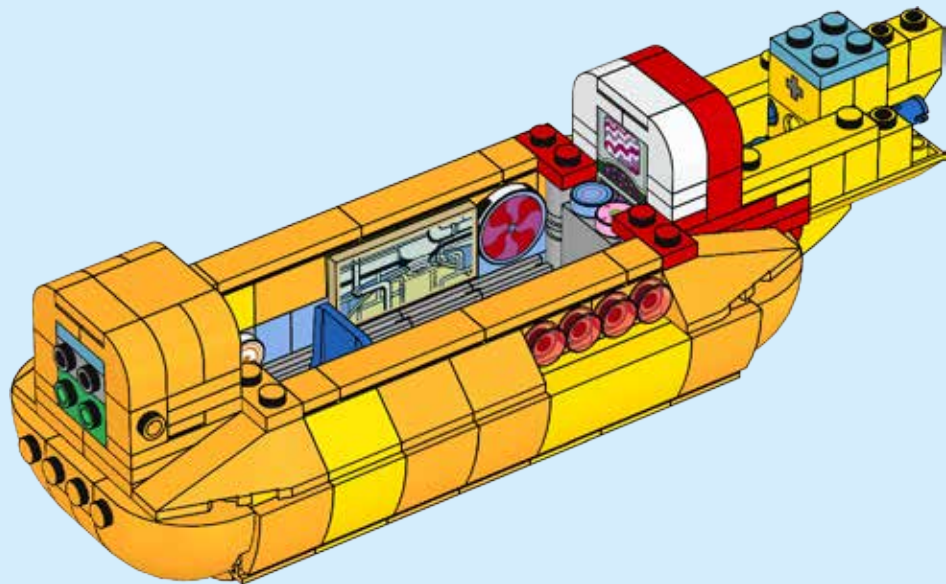



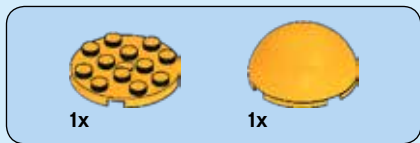

70

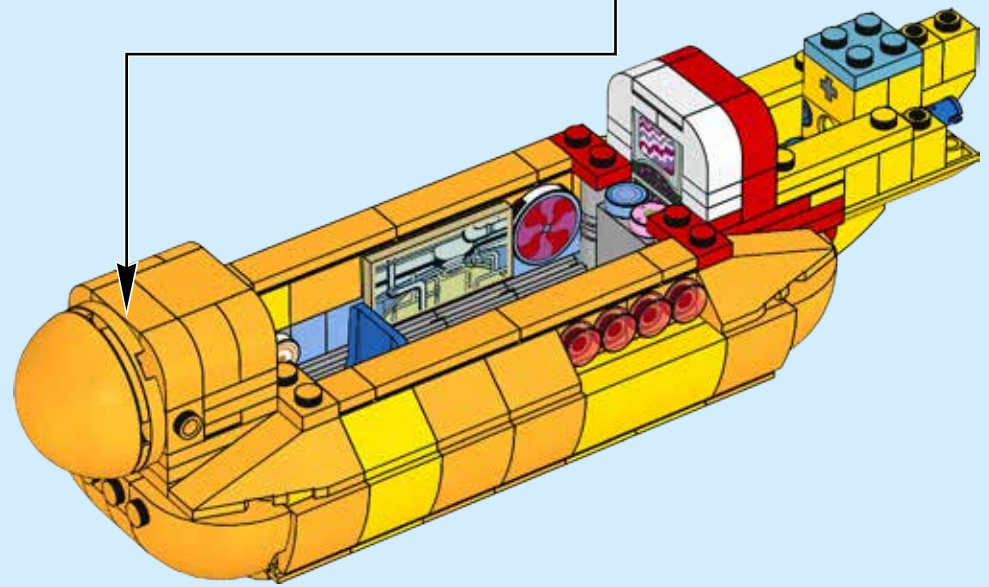



2x

71

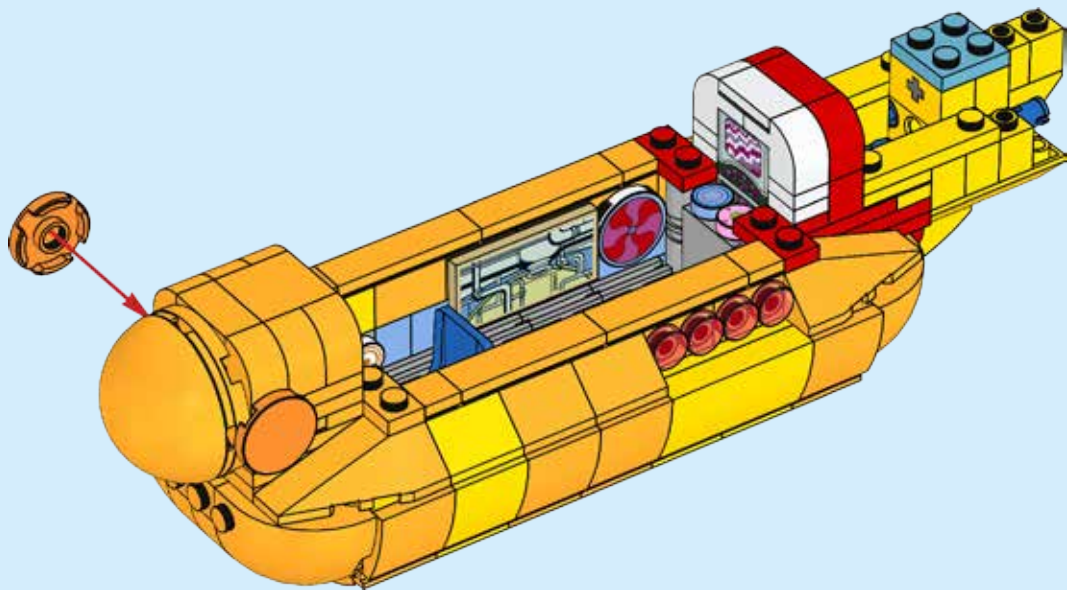

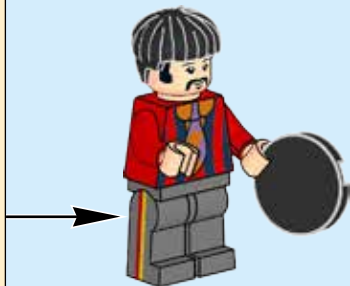
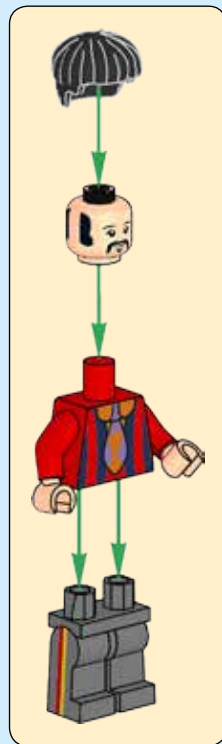
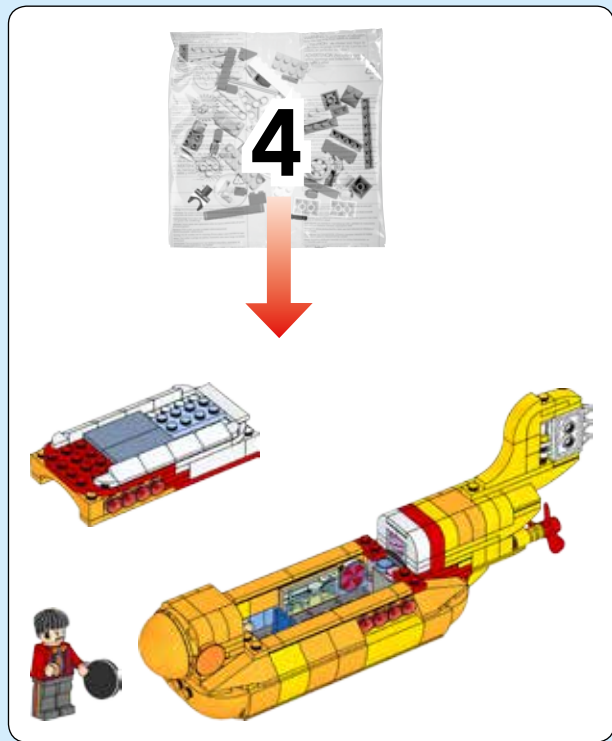

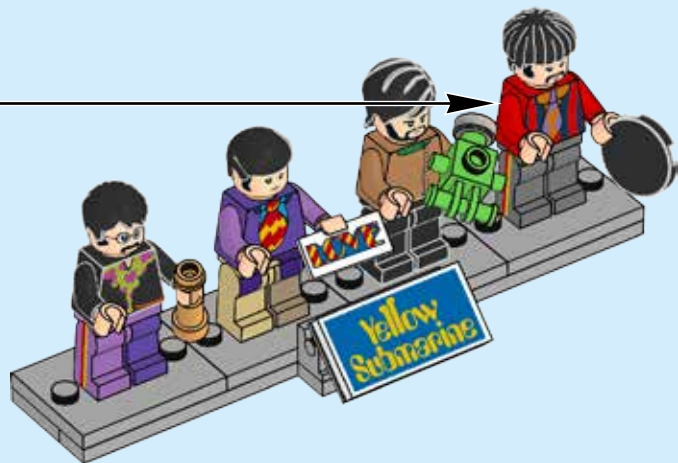

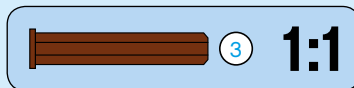
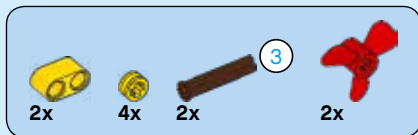

72

1

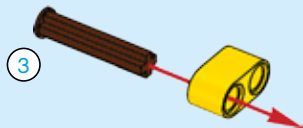

2

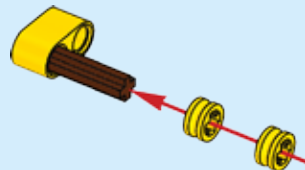

3

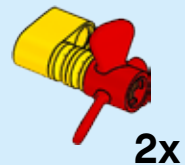

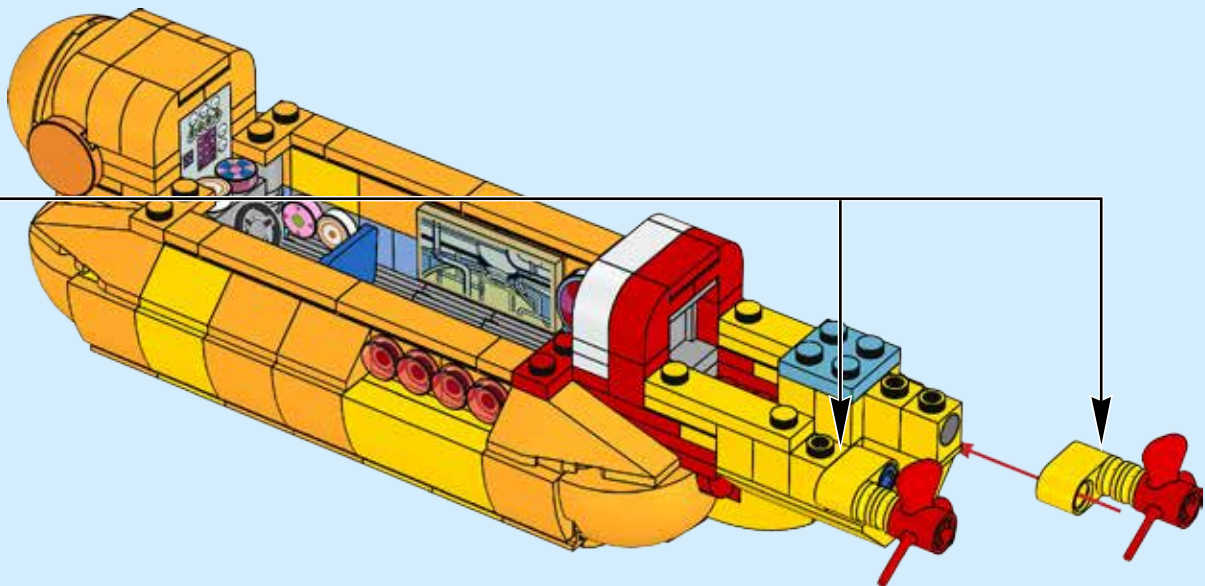



73

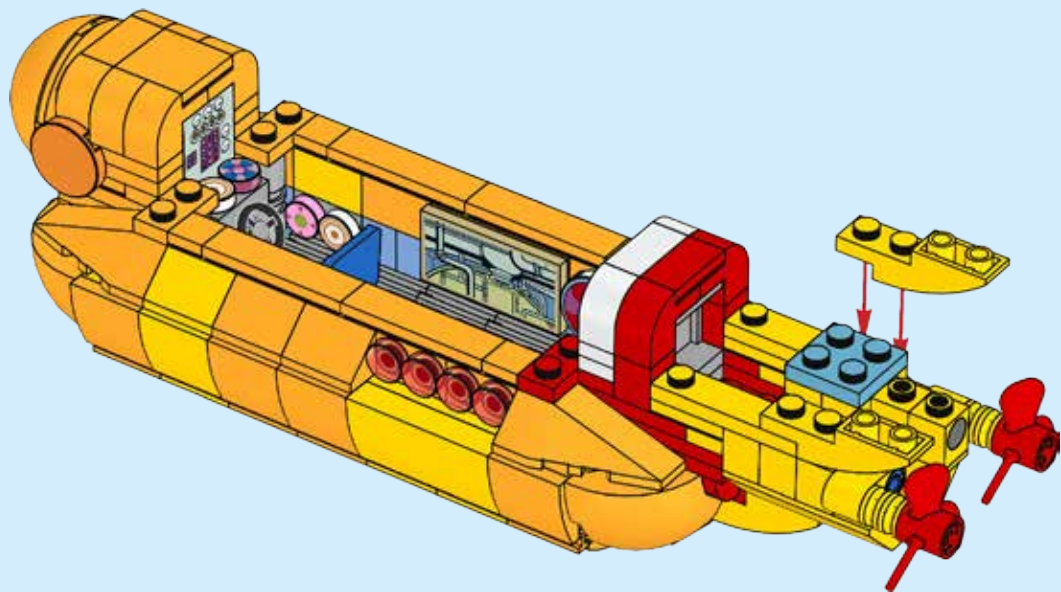



4x

74

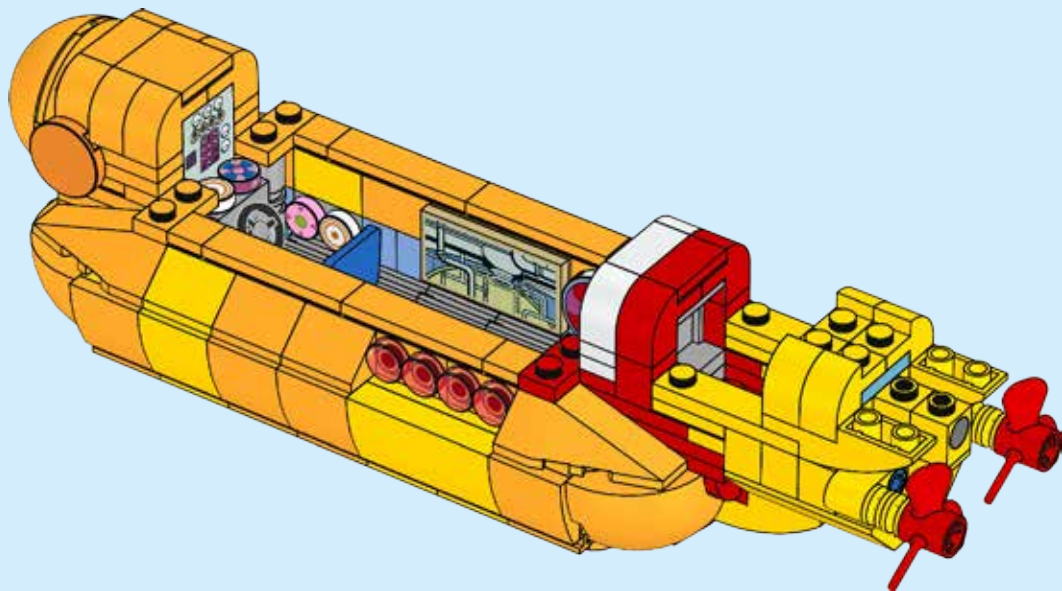





2x

75

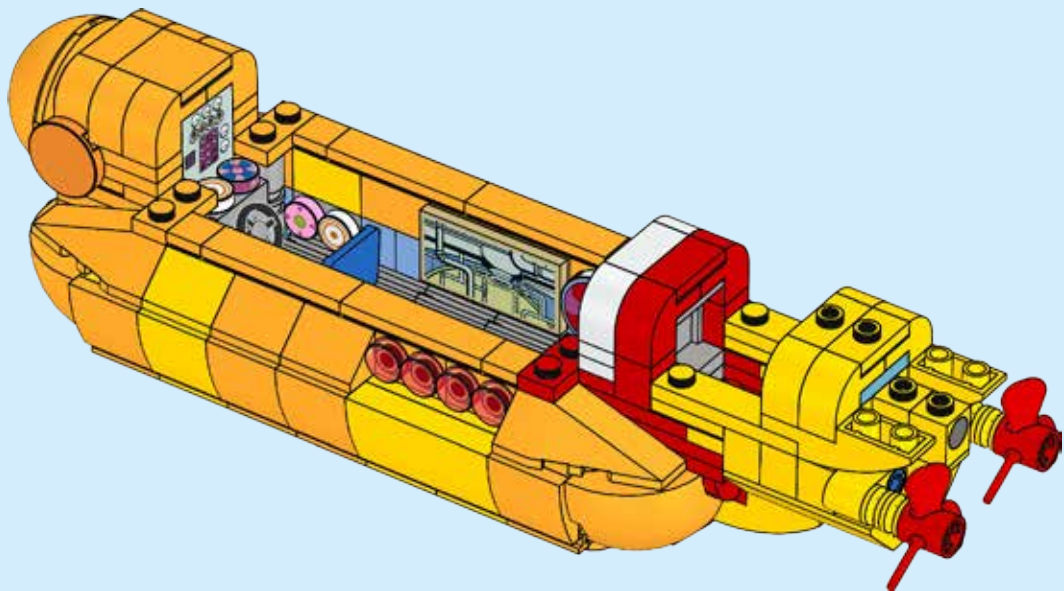

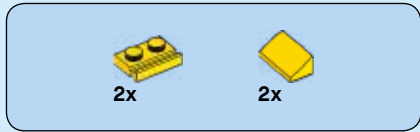

76

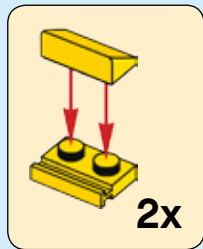
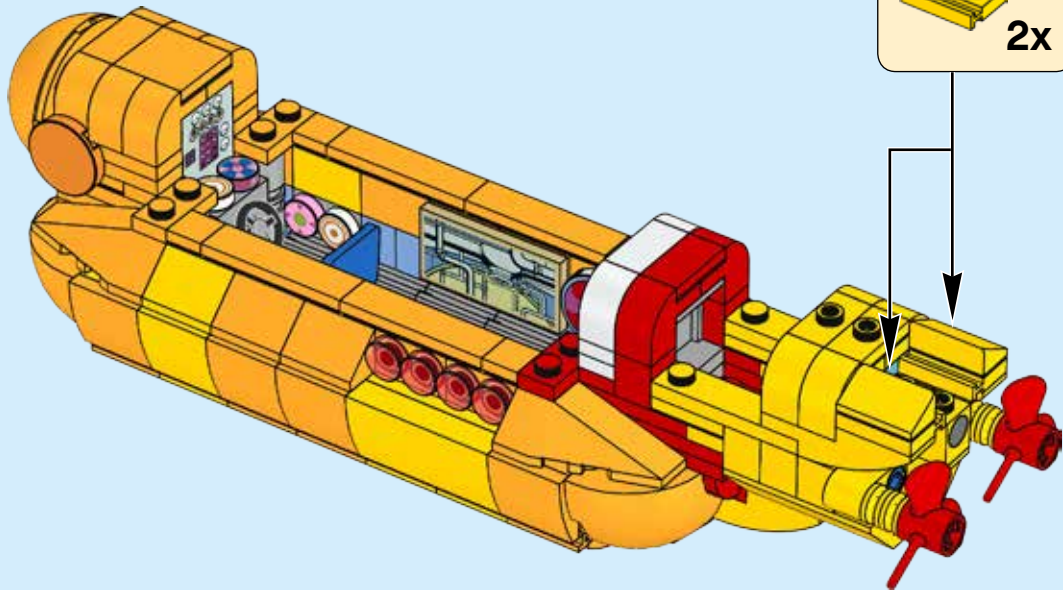

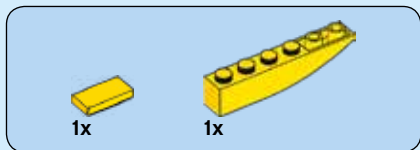

77

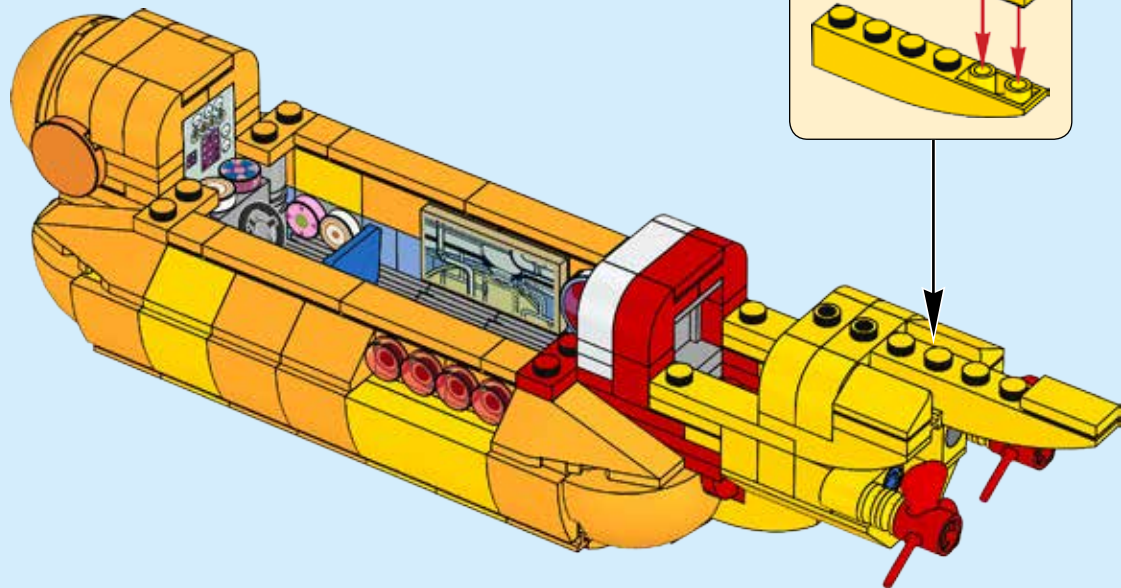

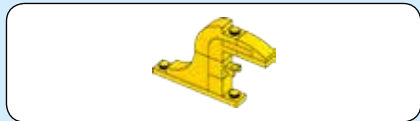

78

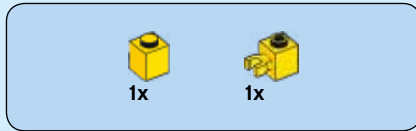
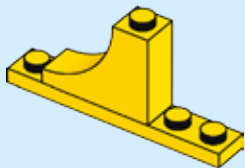

79

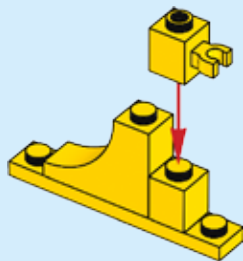



# 80

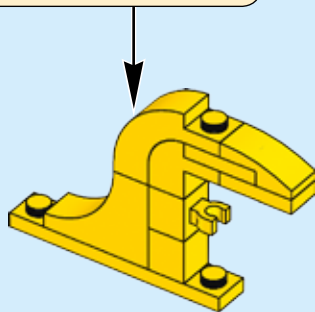
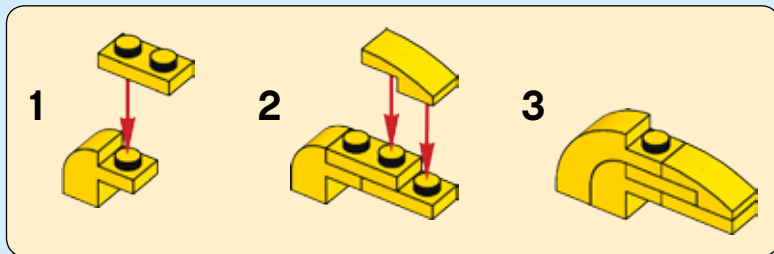

81

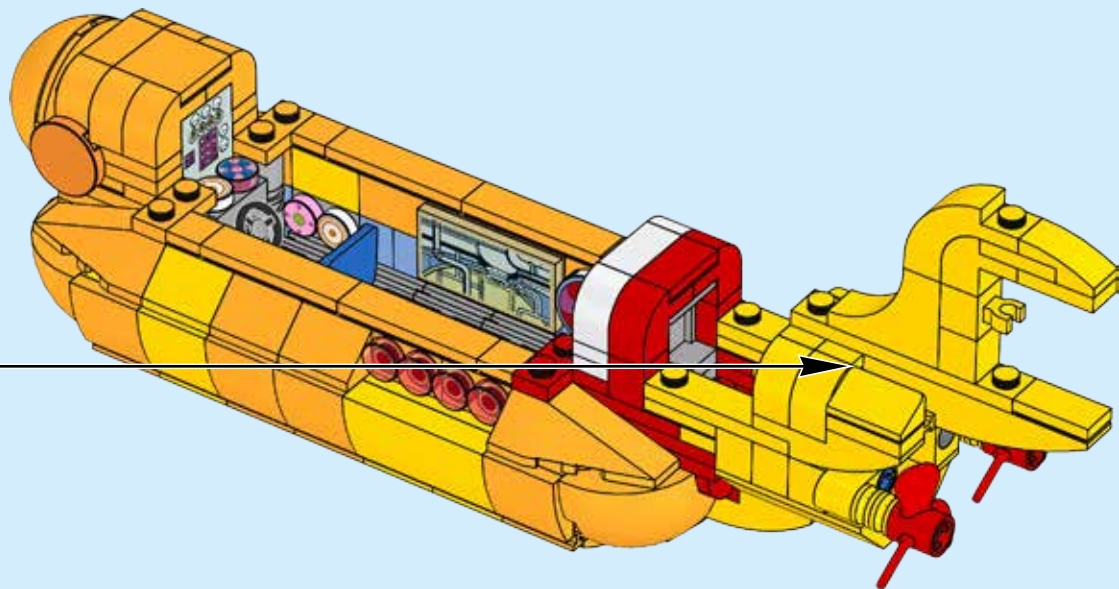

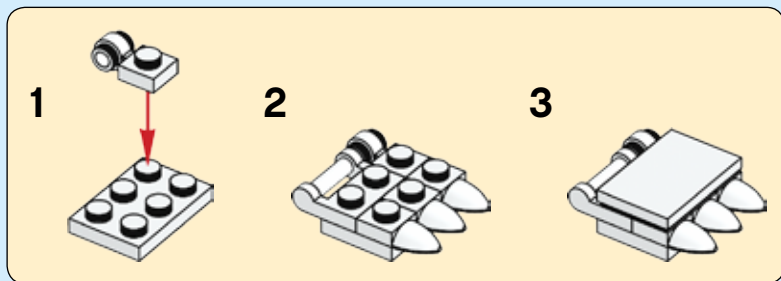
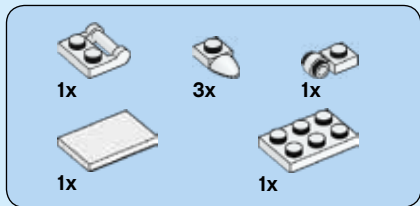

82

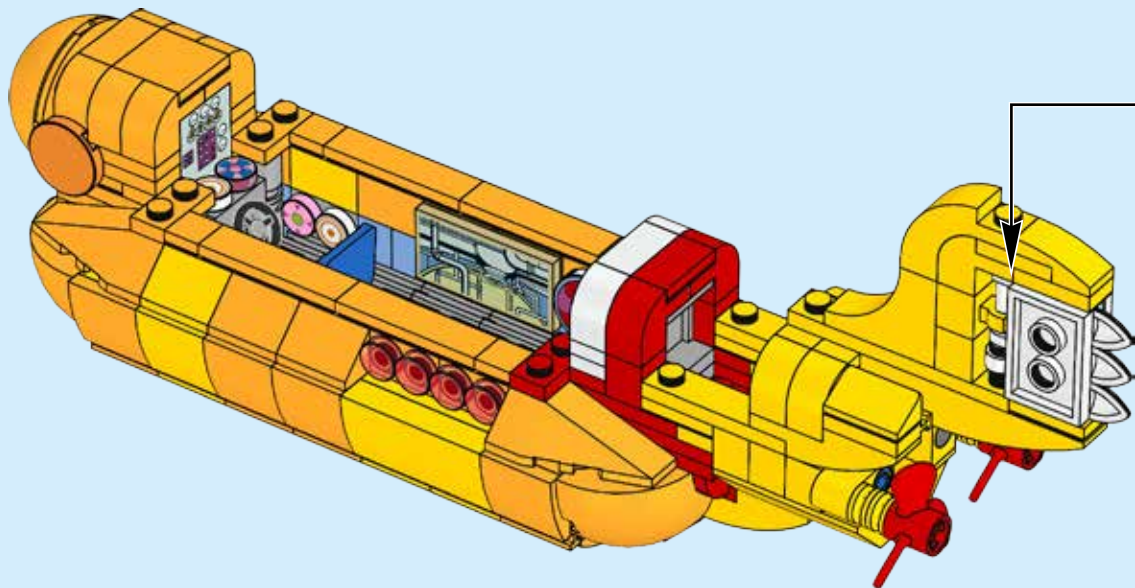



1x



2x



2x



2x



1x



4x

# 83

1

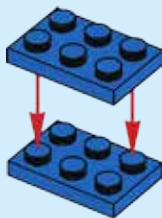

2

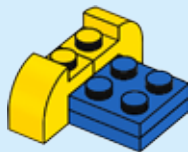

3

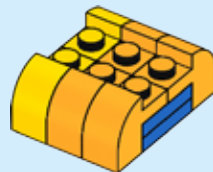



4

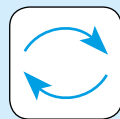
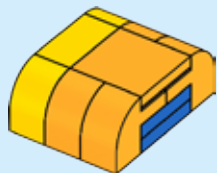

5

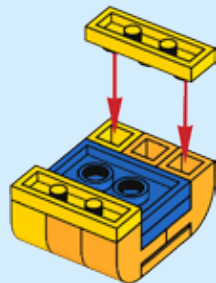

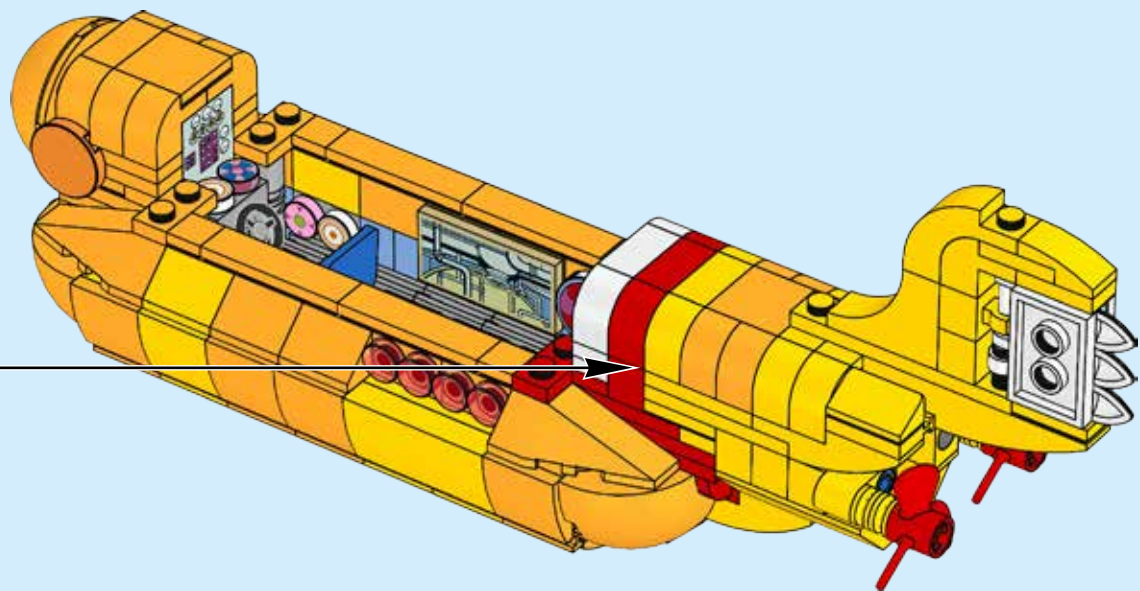

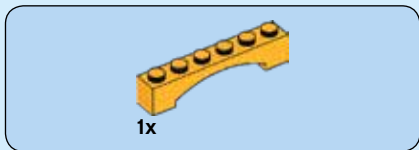

84

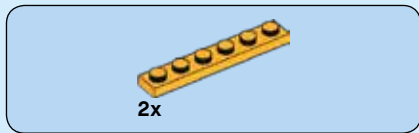
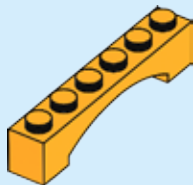

85

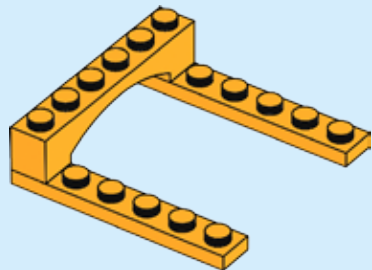

8x

4x

# 86

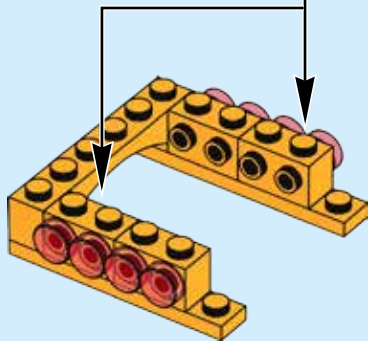

1x

# 87

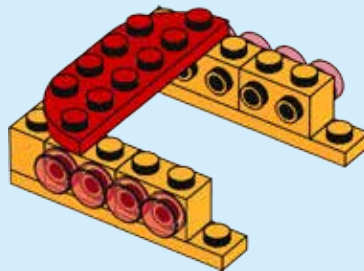
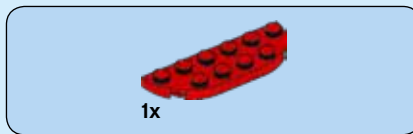

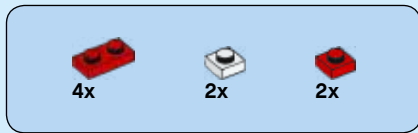

88

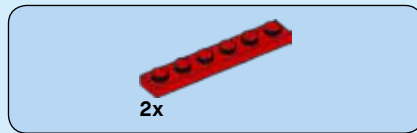
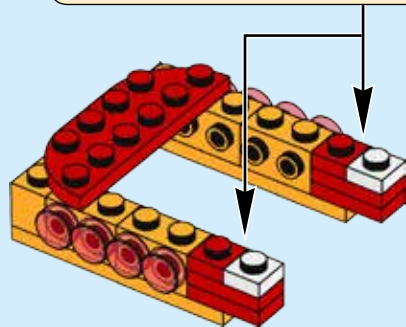
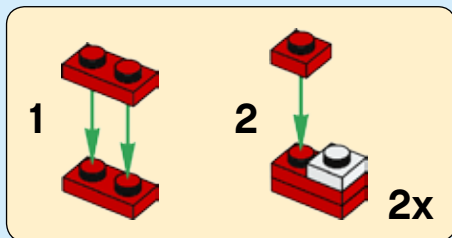

89

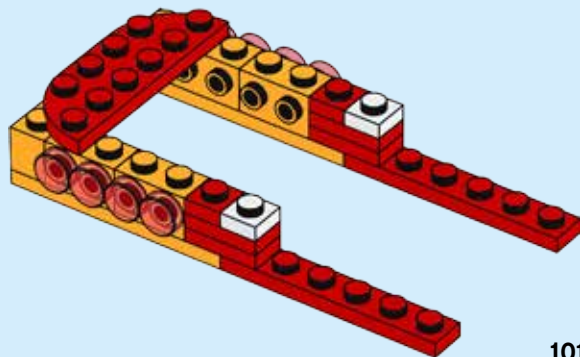

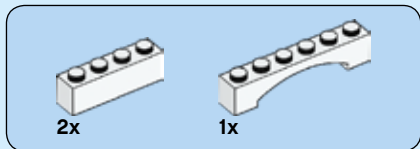

90

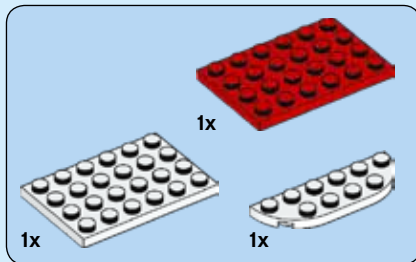
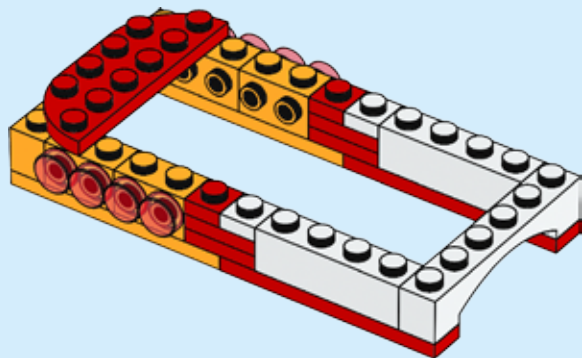

91

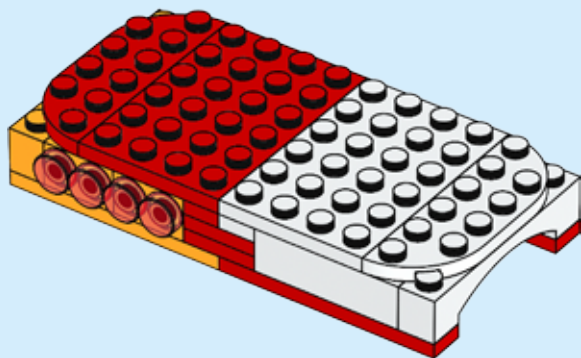

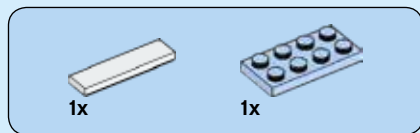

92

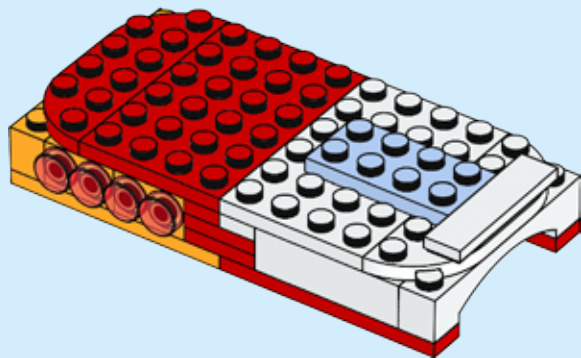



2x

93

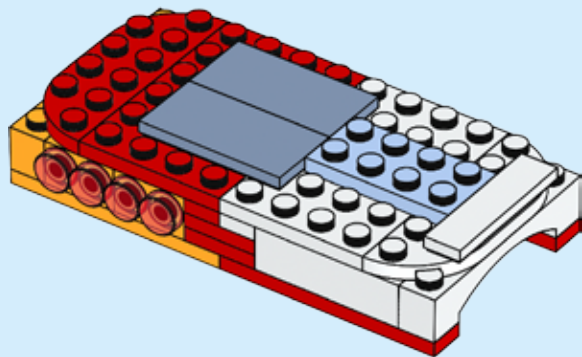

8x



4x

94

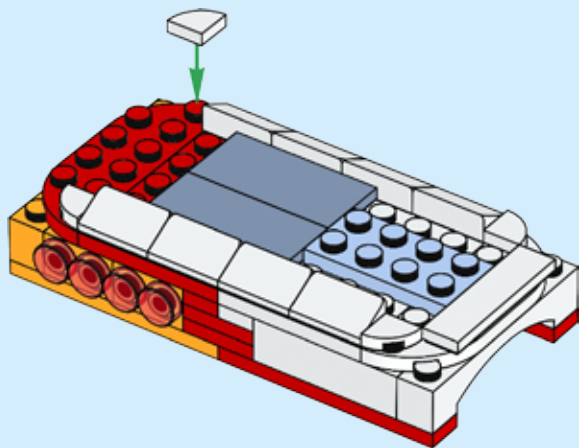



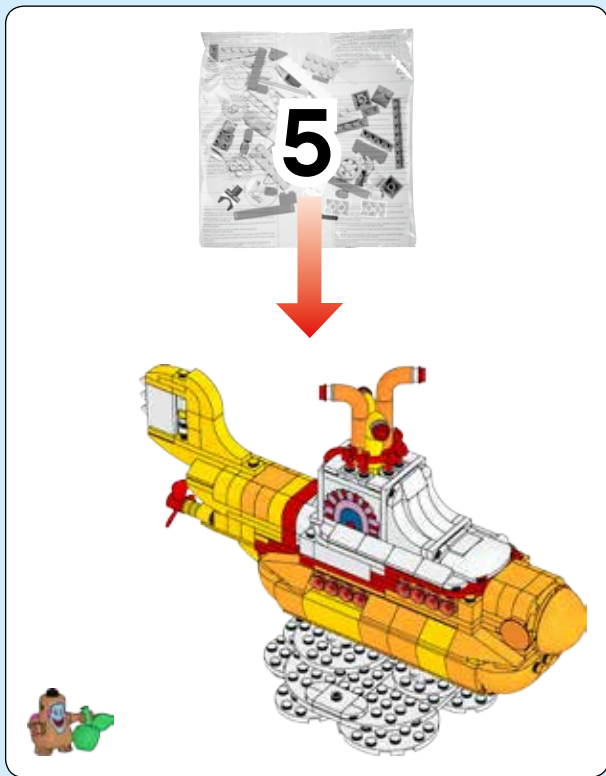



2x

95

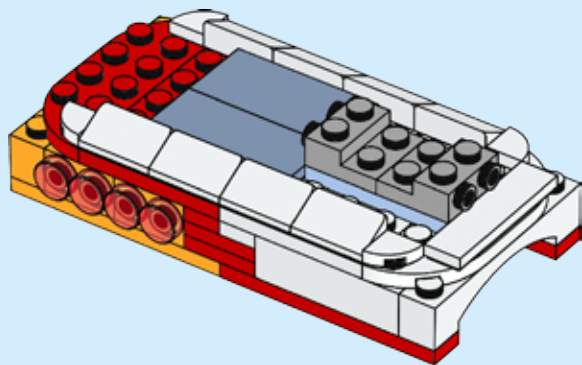

2x

96

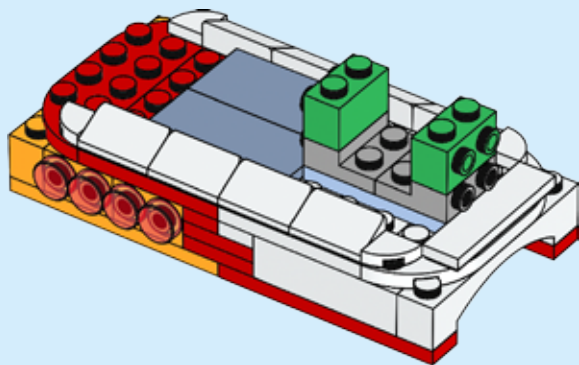



97

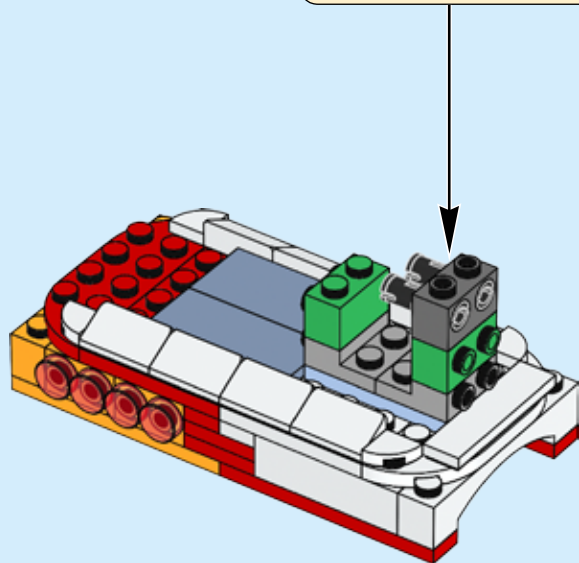
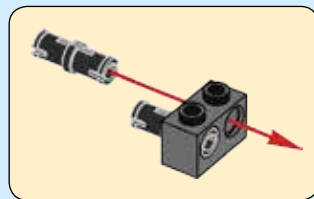

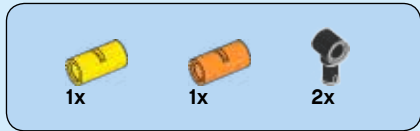

98

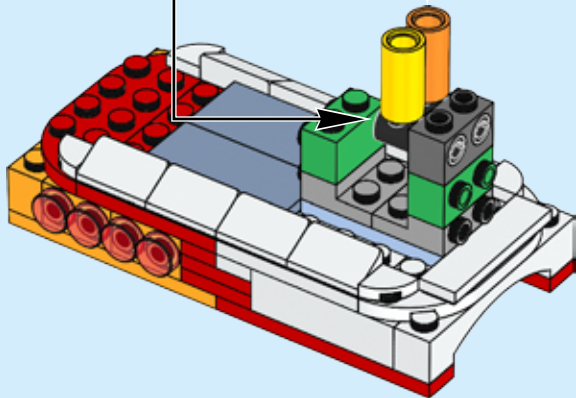
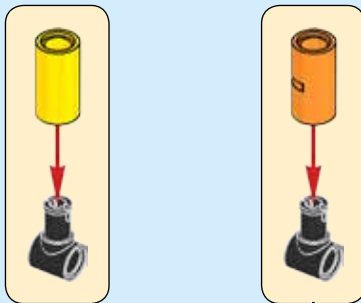



99

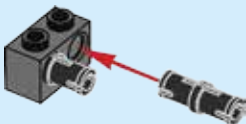

100

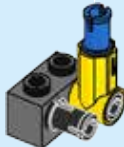
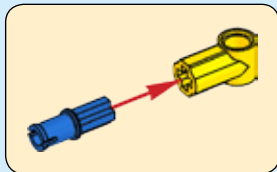



1x



1x

# 101

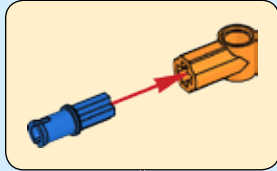

1x



1x

# 102

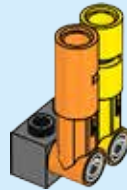

103

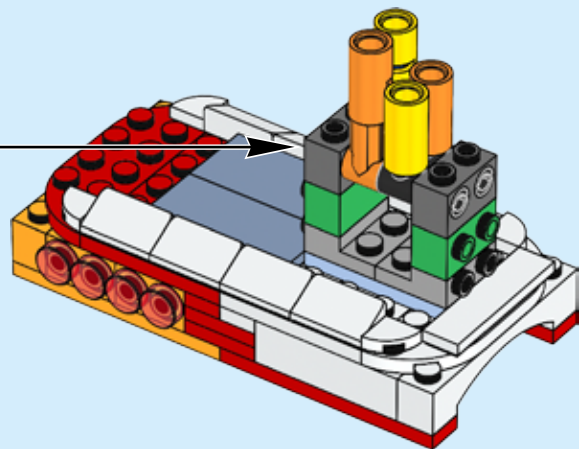

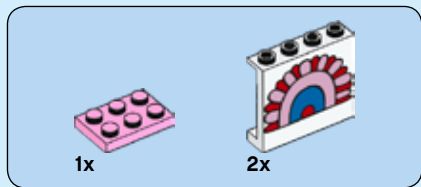

104

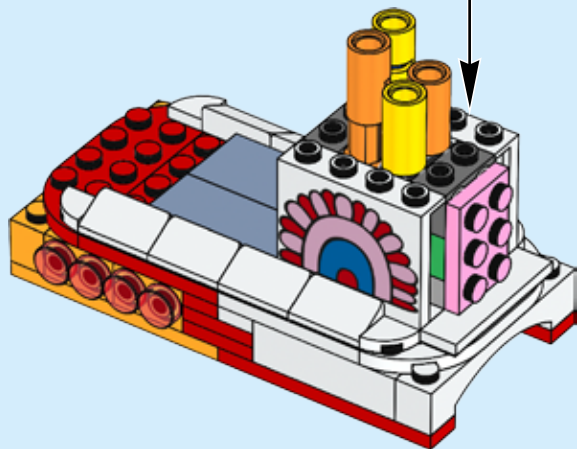
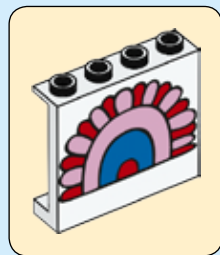



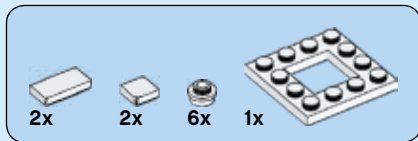

105

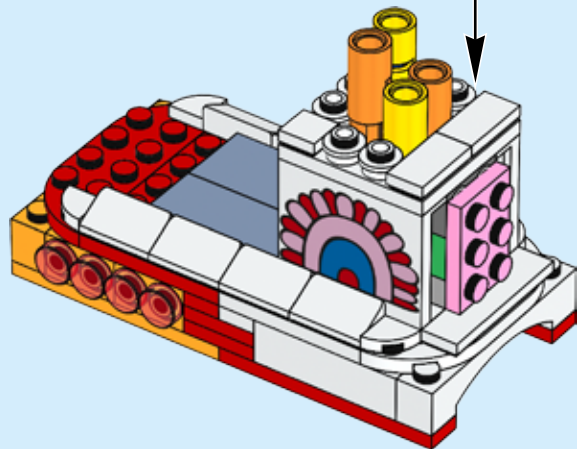
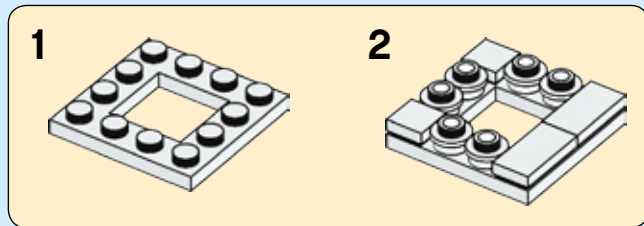

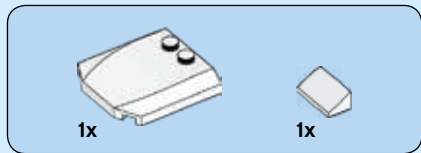

106

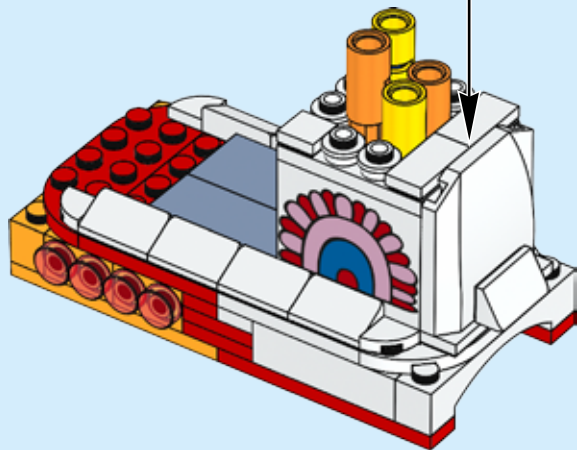
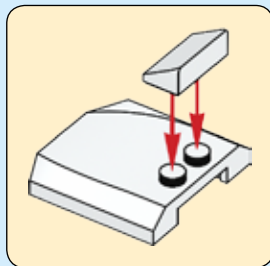



6x

# 107

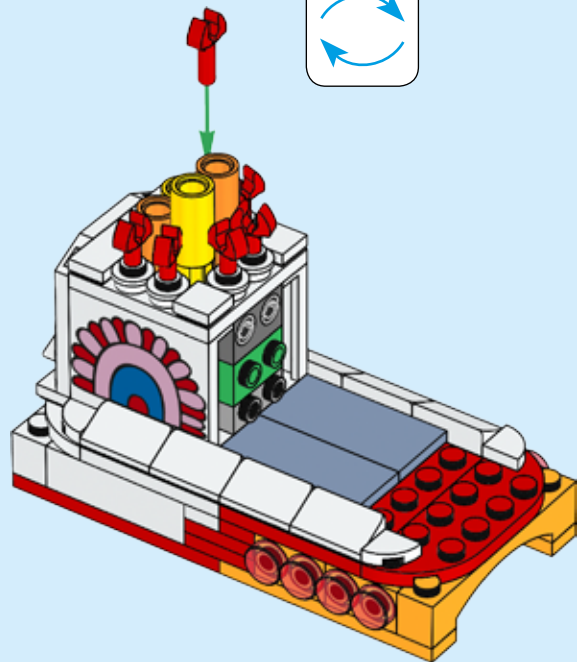
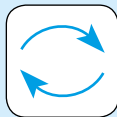

4x

# 108

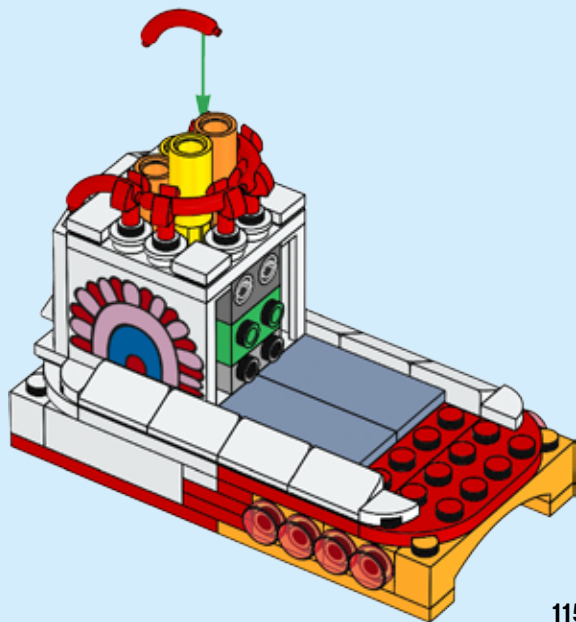

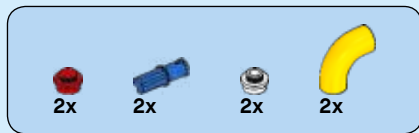

109

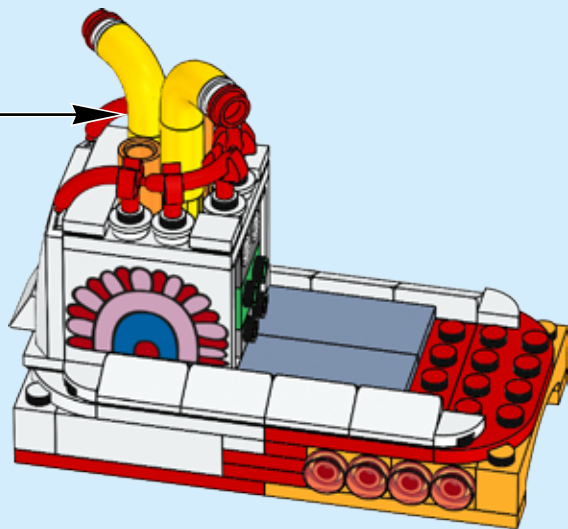
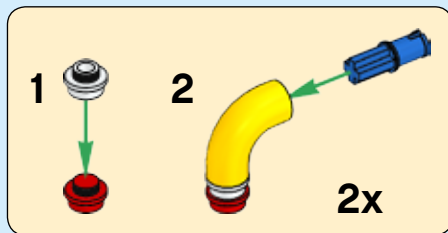

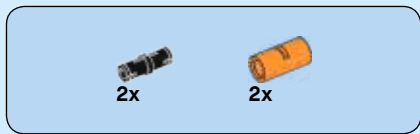

110

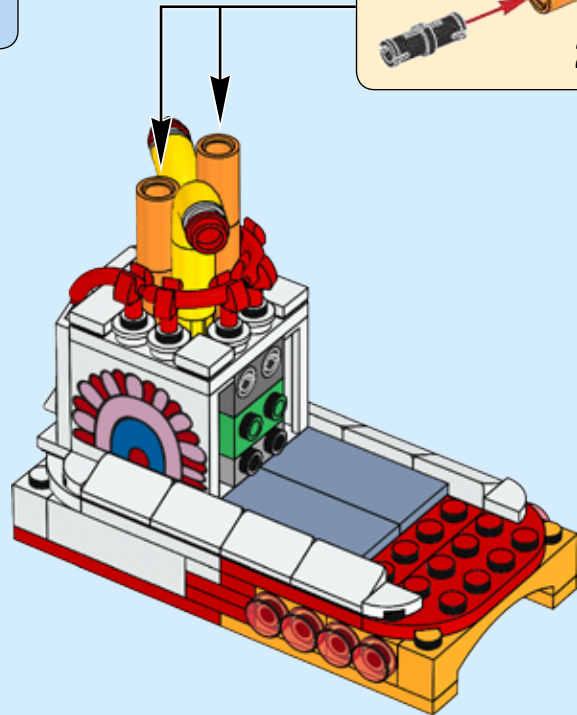
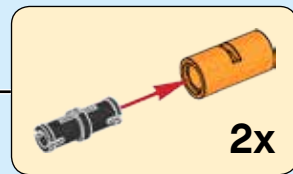

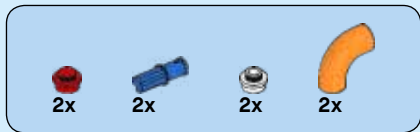

111

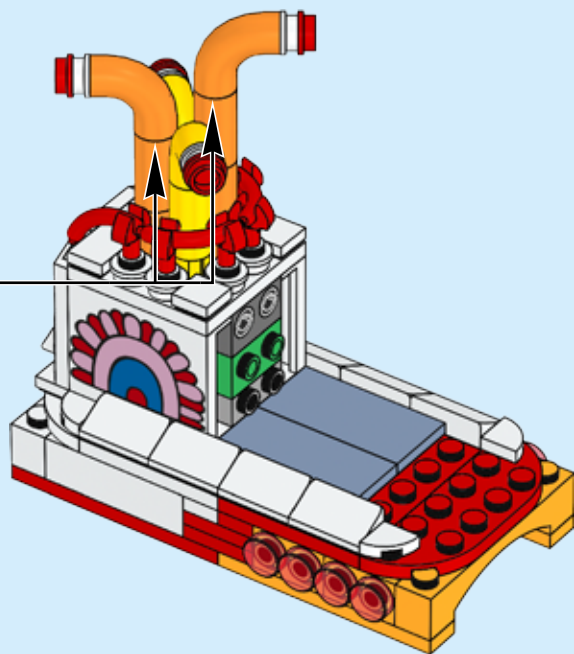
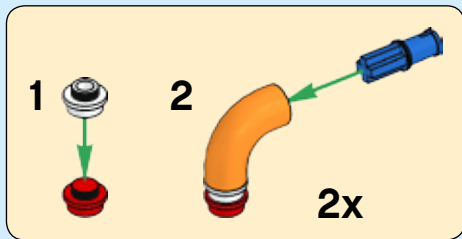

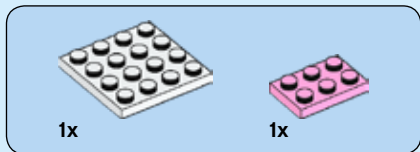
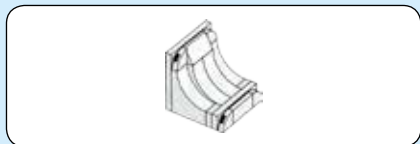

**112**

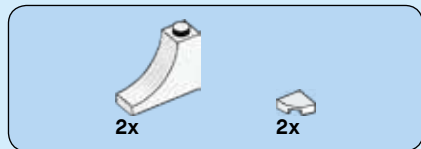

**113**

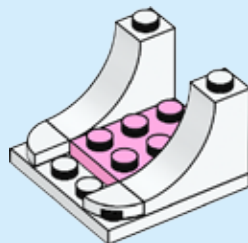

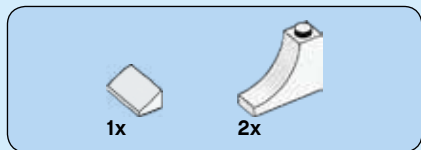

114

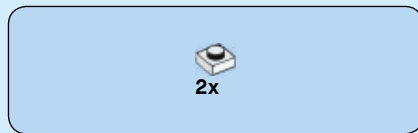
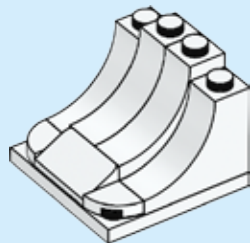

115

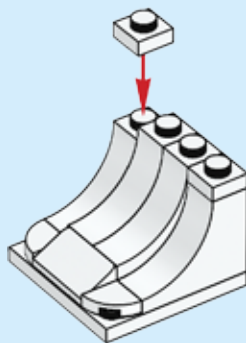



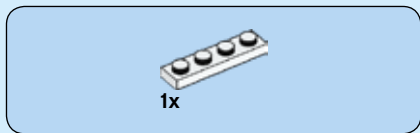

116

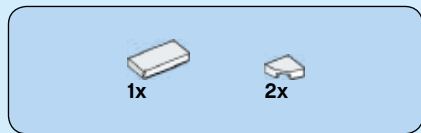
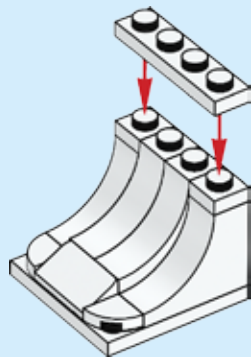

117

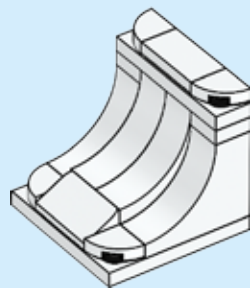

118

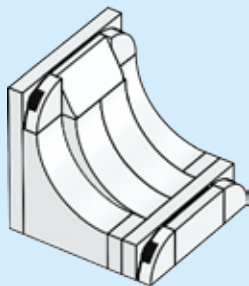
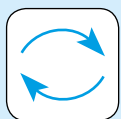

119

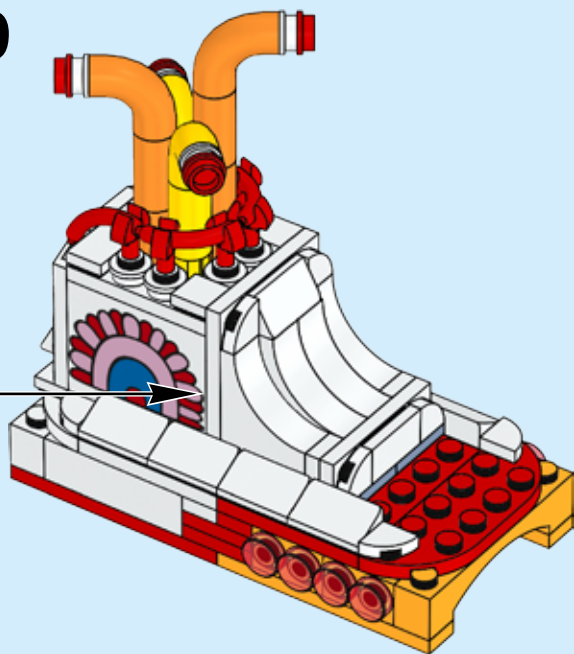



120

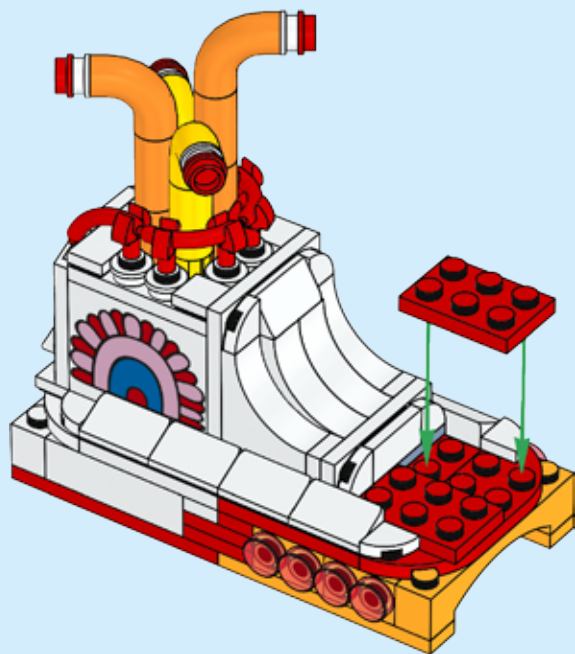

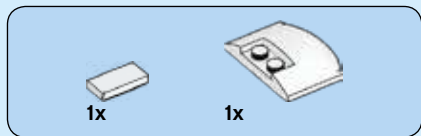

121

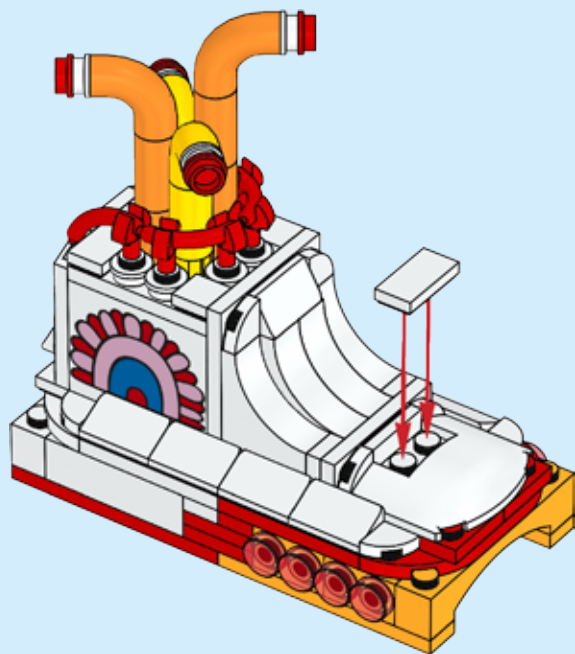

124

122

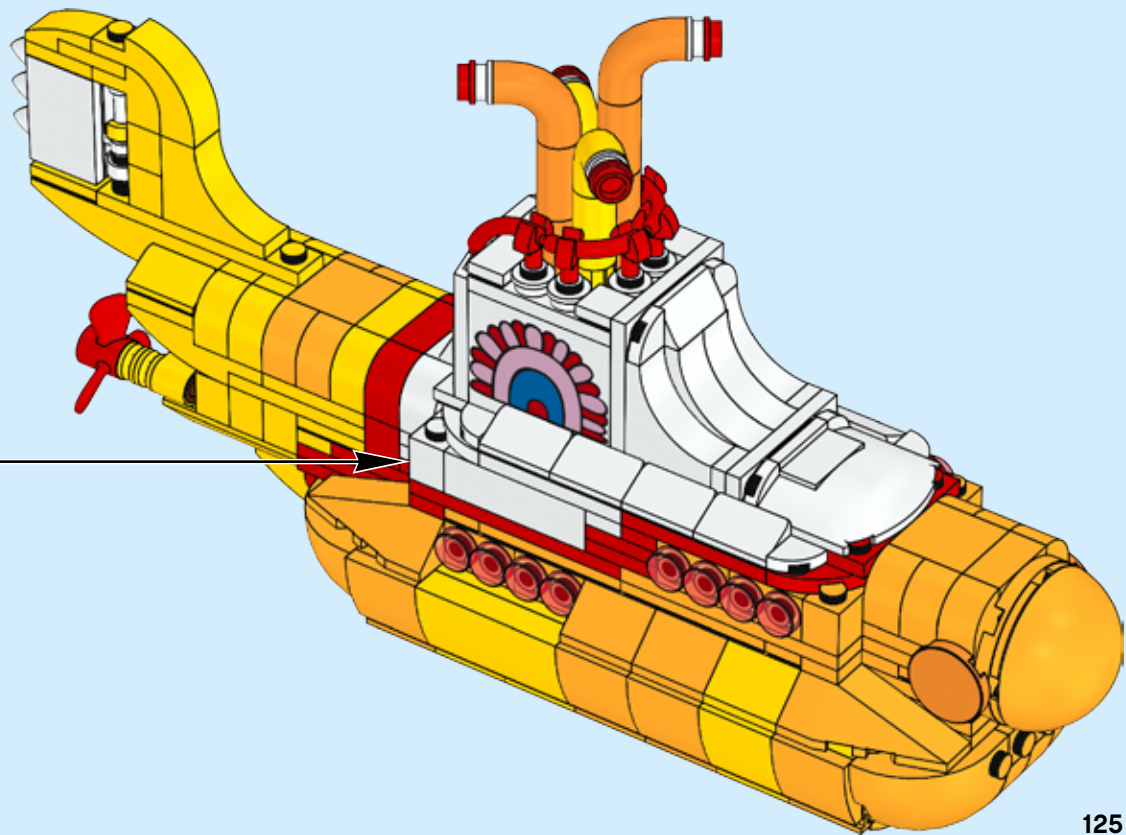

125

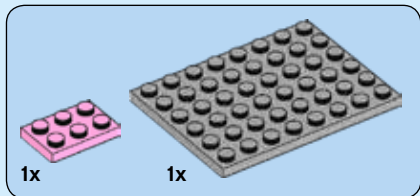
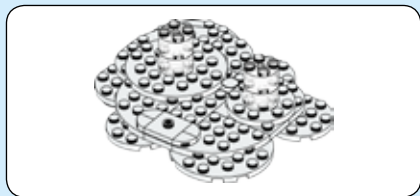

123

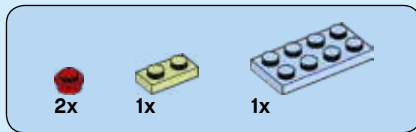
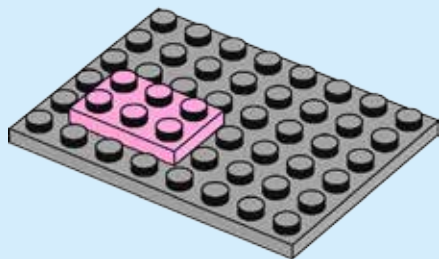

124

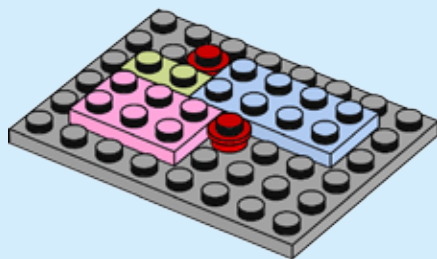

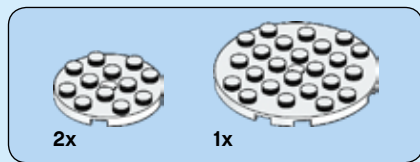

125

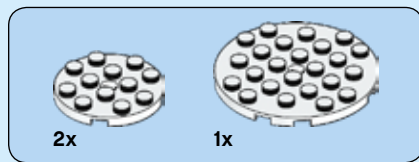
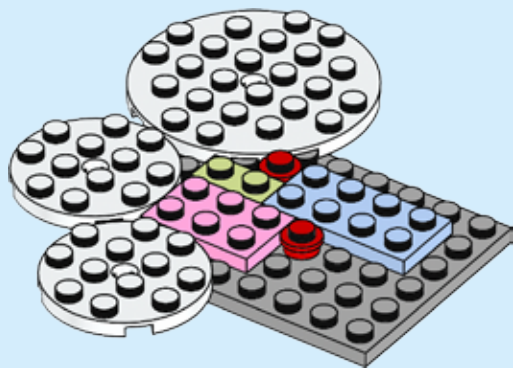

126

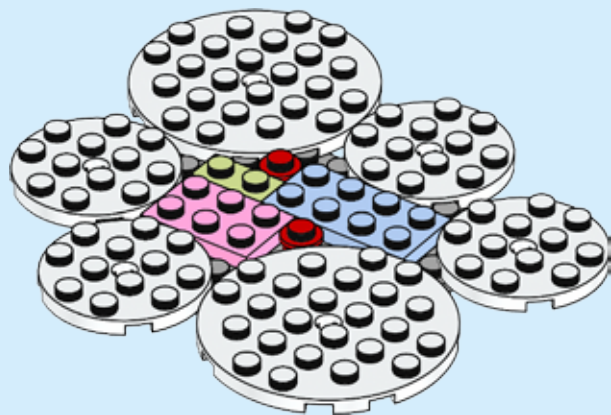



7x

127

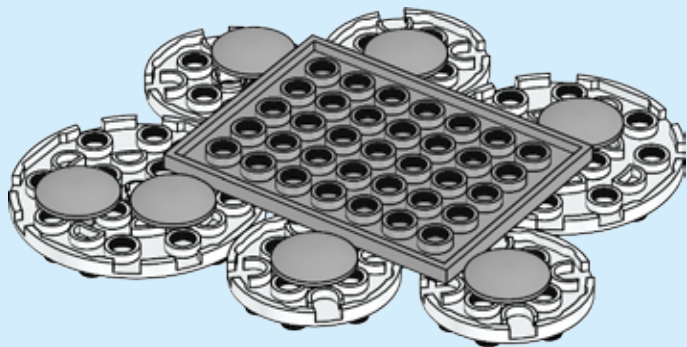
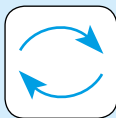

128



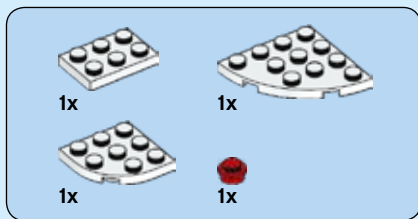

128

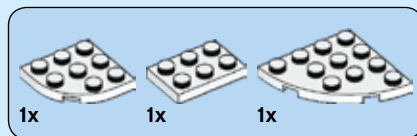
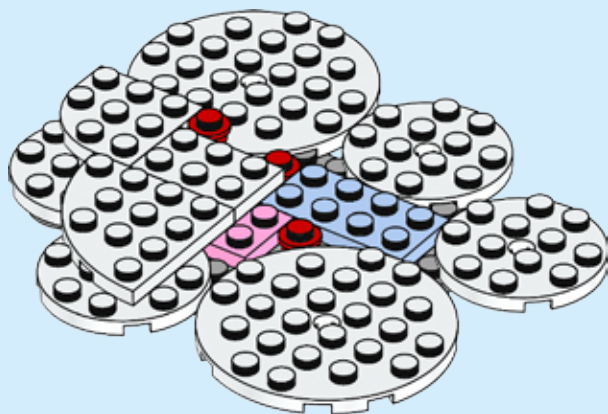
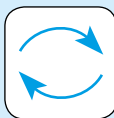

129

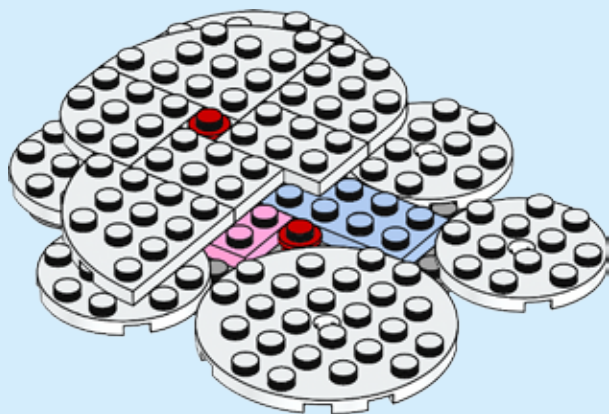



1x



1x

# 130

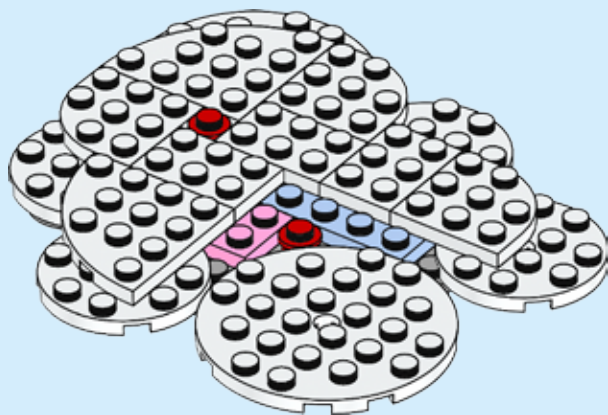

130



1x



1x



1x

# 131

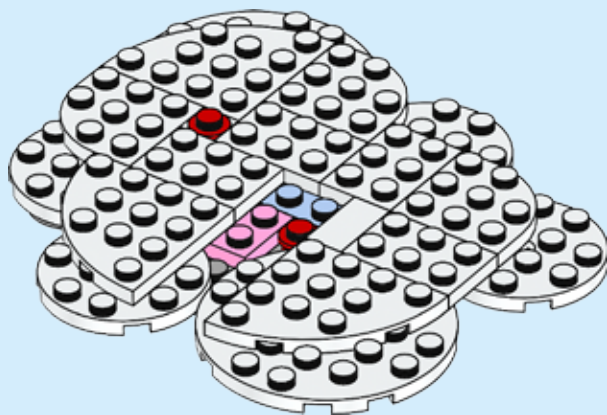



132

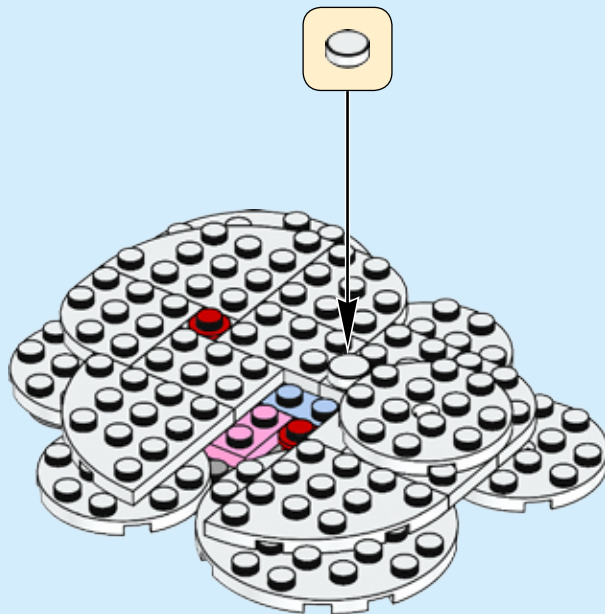

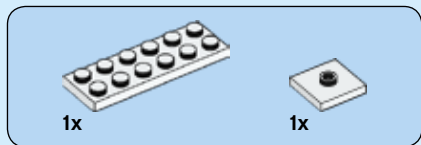

133

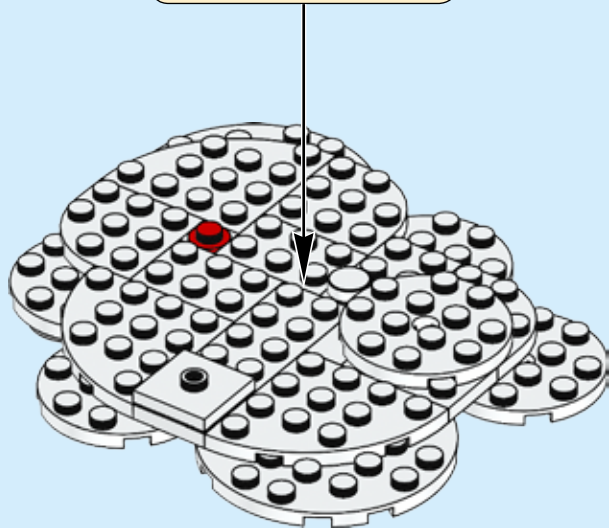
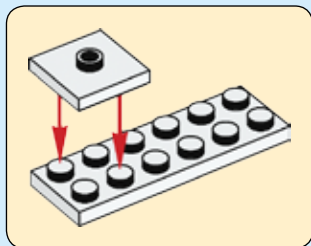

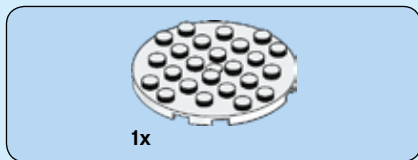

134

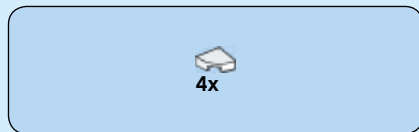
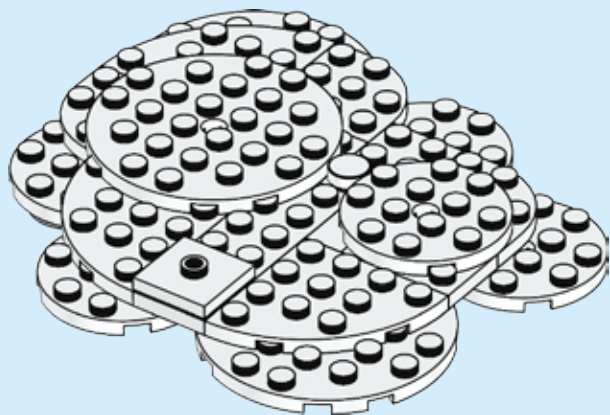

135

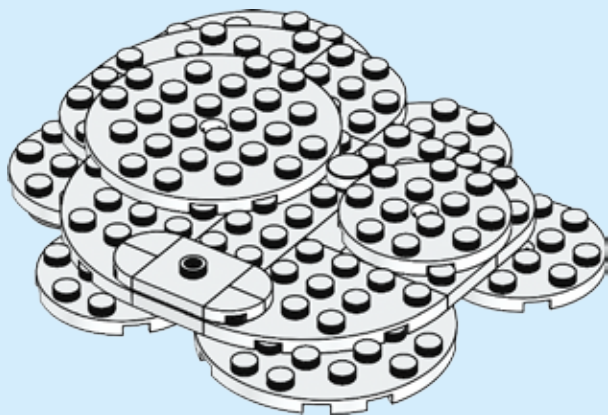



4x

136



2x

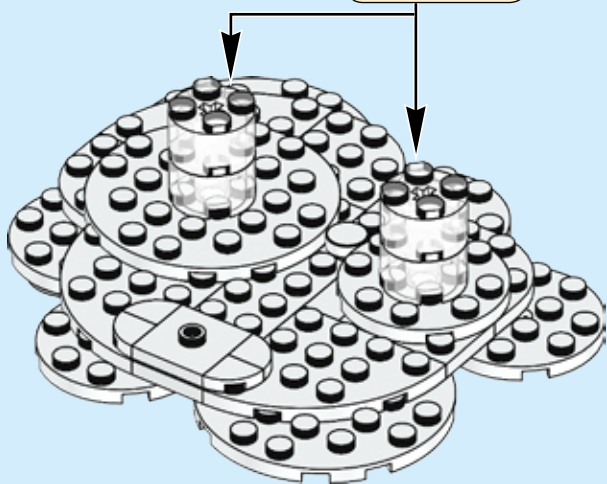

137

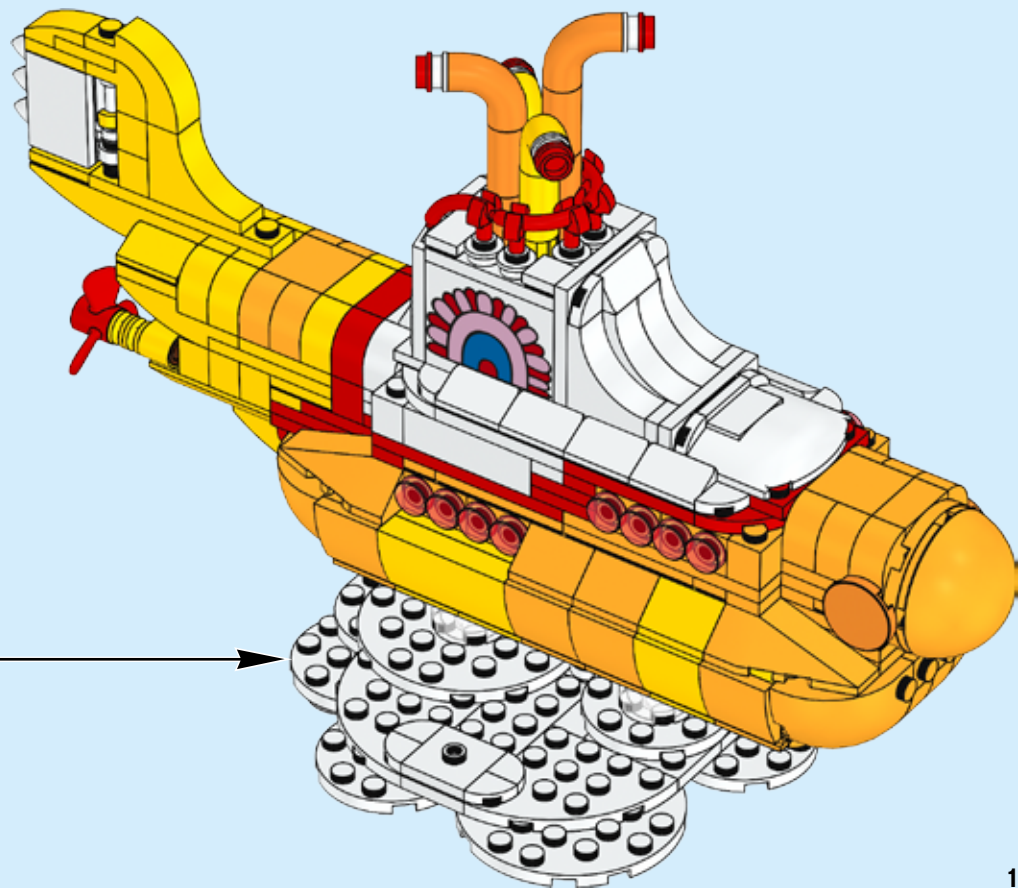

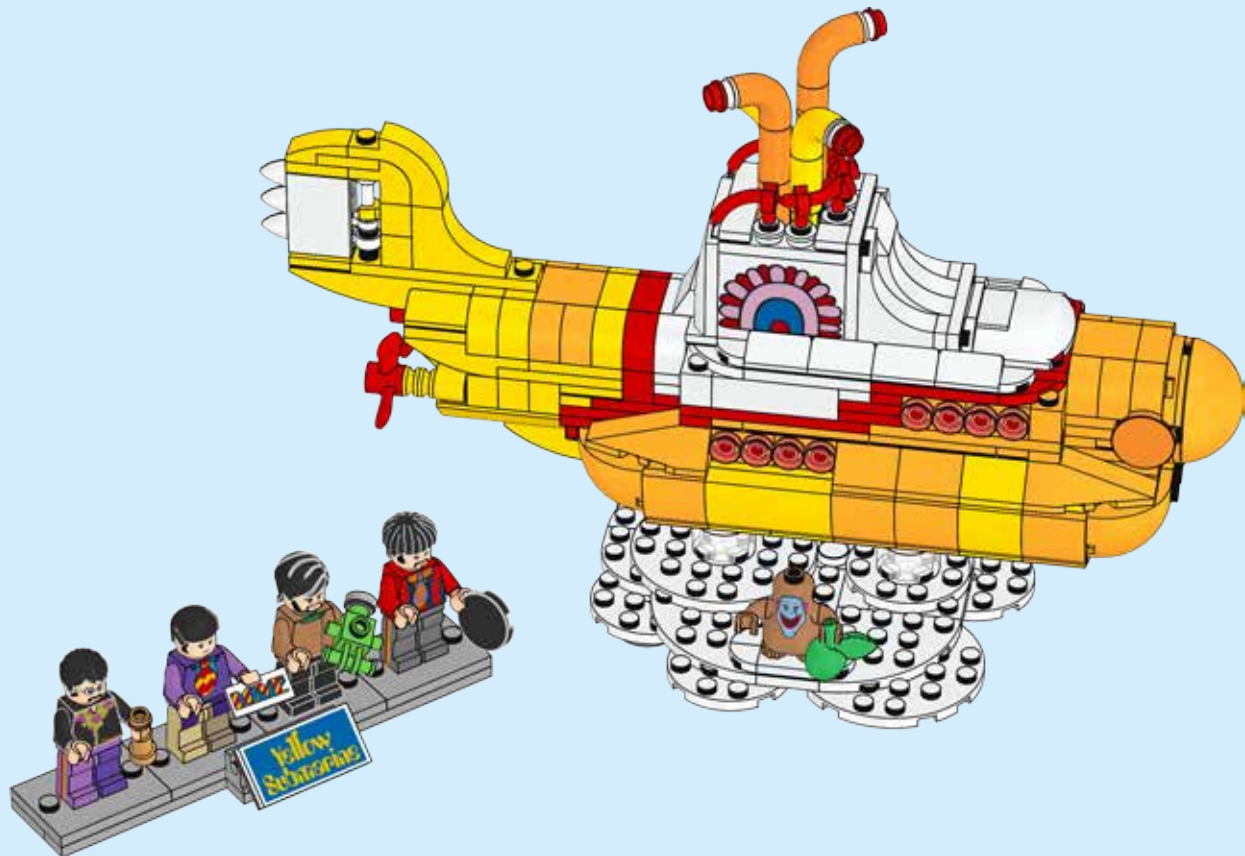



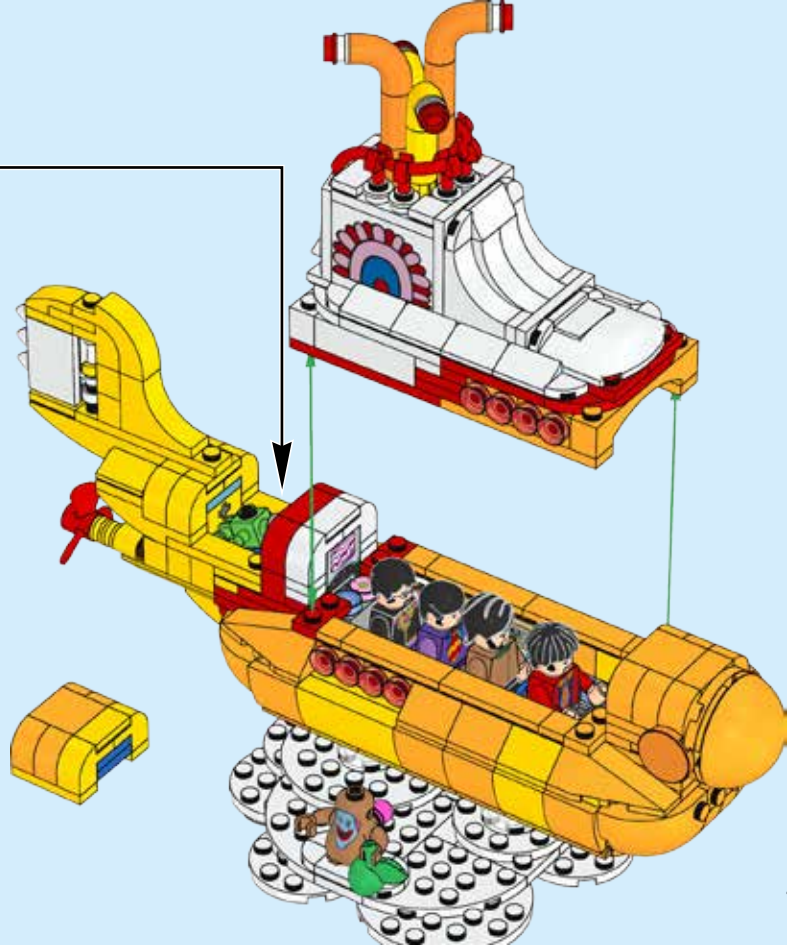

## A word from the fan designer

Designing the Yellow Submarine allowed Kevin Szeto to indulge two of his passions: The Beatles and designing with LEGO® bricks.

“As an amateur musician and songwriter, I have always been drawn to the music of the Beatles. The Yellow Submarine is bright, fun, and colorful,

which also makes it a good subject to translate into LEGO form.”

“I completed the main structure of the Yellow Submarine over one weekend, but I probably spent another half dozen weeknights tweaking details here and there. I would estimate I spent about 25 - 30 hours designing and building the initial model.”

“When the model hit 10,000 supporters on LEGO Ideas, I was, of course, totally ecstatic. To be just one of the thousands of contributors to this platform has been a fun and rewarding experience.”



Kevin Szeto  
Fan Designer



## LEGO® designer

LEGO® Designer Justin Ramsden was also a fan of the movie and was delighted to be a part of this LEGO Ideas project.

“I watched the film when I was younger and was really inspired by how it oozed so much imagination – comparable to how I view LEGO elements. I’m also a massive fan of The Beatles, having grown up with their music all my life, so to see The Beatles in LEGO form is a dream come true.”

“Kevin did a great job with his model, and many of the ideas and details could be used in the final set, but as a LEGO designer I had to ensure that the final version offered an enjoyable and stable LEGO building experience.”

“There are many new elements included within the model (and old elements in new colors); two of my favorites are the 2x3 tile and the ¼ circle tile. As a LEGO designer I’ve wanted these elements for ages, so I’m pleased to finally get my hands on them!”

Justin Ramsden  
LEGO Designer



1x 6175984	1x 6174934	1x 4243812	1x 379501	2x 6174891	2x 609121	2x 366621	4x 4143346	4x 654124	2x 6132263	2x 302324
1x 6175982	6x 6051511	1x 6167450	1x 6018101	1x 6174910	2x 302421	2x 302421	2x 6135494	2x 4233484	2x 362324	5x 6092583
2x 301001	6x 306901	1x 6182017	5x 4515347	1x 6174902	4x 302321	4x 302321	1x 6175899	2x 4550348	1x 4652261	2x 306924
10x 4547489	2x 6177074	3x 4224792	3x 4550745	1x 6175422	1x 306921	1x 306921	1x 6175321	1x 366524	1x 302224	1x 302224
2x 609101	1x 6174728	1x 6126046	1x 6147792	1x 6175422	2x 242021	2x 242021	6x 4121715	1x 6173894	1x 6029947	1x 6029947
4x 6110019	2x 609101	12x 6172366	1x 4178429	1x 4243814	2x 302221	2x 302221	2x 6073231	4x 6146298	2x 6079007	2x 6079007
4x 6110019	5x 302101	1x 4632566	3x 4178429	1x 302221	4x 302221	4x 302221	1x 6070695	2x 4187122	2x 6173898	2x 6173898
8x 302401	1x 6156667	1x 4222017	3x 6109817	1x 303221	2x 302121	2x 302121	1x 9339	2x 4188357	4x 4239601	4x 4239601
4x 307001	1x 243101	12x 6046979	1x 303201	4x 379521	1x 407923	1x 407923	1x 6175970	2x 302424	1x 6175158	1x 4107066
1x 6174905	1x 371001	10x 4547649	1x 4193068	4x 379521	2x 300521	2x 300521	1x 390126	1x 4515354	1x 6097644	2x 4526983
1x 4646844	1x 6174905	1x 4646844	1x 4193068	1x 6108802	7x 614121	7x 614121	1x 6175970	1x 300524	2x 370124	8x 4141630
2x 6170390	2x 6170390	2x 6170390	2x 6170390	2x 6170390	2x 4514553	2x 4514553	1x 4526110	1x 300524	2x 370124	8x 4141630



**Customer Service**  
**Kundenservice**  
**Service Consommateurs**  
**Servicio Al Consumidor**

**LEGO.com/service or dial**



: 00800 5346 5555  
 : 1-800-422-5346

SHARE YOUR IDEA  
TEILE DEINE IDEE  
PARTAGE TON IDÉE  
COMPARTÉ TU IDEA  
PARTILHA A TUA IDEIA  
TEDD KÖZZÉ AZ ÖTLETED  
分享您的观点

LEGO® REVIEW  
LEGO® PRÜFUNG  
EXAMEN PAR LEGO®  
REVISIÓN DE LEGO®  
AVALIAÇÃO LEGO®  
LEGO® VÉLEMÉNYEZÉS  
乐高®评论



GATHER SUPPORT  
HOL' DIR UNTERSTÜTZUNG  
RASSEMBLE DES VOTES  
GANA APOYOS  
OBTÉM APOIO  
SZEREZZ TÁMOGATÁST  
获得更多支持



NEW LEGO® PRODUCT  
NEUES LEGO® PRODUKT  
NOUVEAU PRODUIT LEGO®  
NUEVO PRODUCTO LEGO®  
NOVO PRODUTO LEGO®  
ÚJ LEGO® TERMÉK  
新的乐高®产品



[LEGO.COM/IDEAS](http://LEGO.COM/IDEAS)



## Do you like this LEGO® Ideas set?

The LEGO Group would like your opinion on the new product you have just purchased. Your feedback will help shape the future development of this product series. Please visit:

[LEGO.com/productsurvey](https://www.lego.com/productsurvey)

By completing our short feedback survey, you will be automatically entered into a drawing to win a LEGO® prize.

See website for official rules and details. Open to all countries where not prohibited.

LEGO and the LEGO logo are trademarks of the LEGO Group. ©2016 The LEGO Group.

©2016 Apple Corps Ltd. All rights reserved. A Beatles™ product licensed by Apple Corps Ltd. "Beatles" is a trademark of Apple Corps Ltd. "Apple" and the Apple logo are exclusively licensed to Apple Corps Ltd.

©2016 Subafilms Ltd. A Yellow Submarine™ product. ™ Trade Mark of Subafilms Ltd ©1968. Authorised Beatles™ merchandise.



6200017