



THE NINJAGO MOVIE

70610





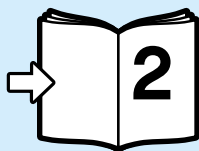
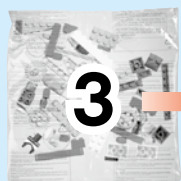
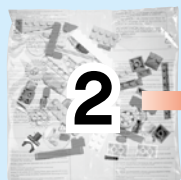
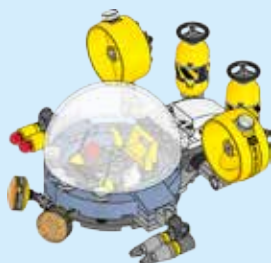

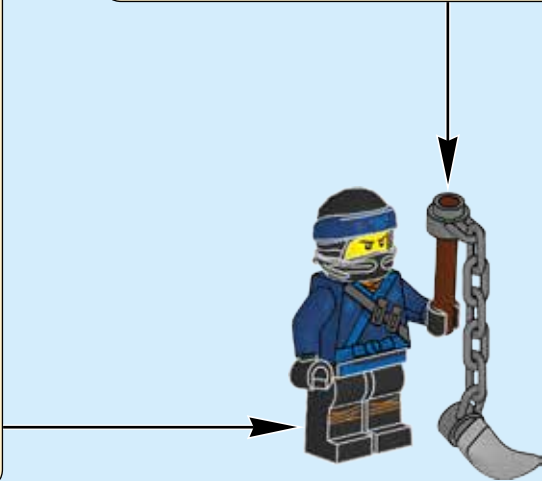
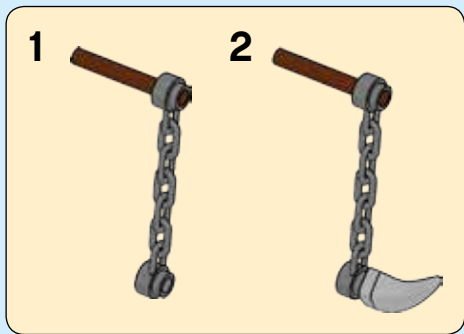
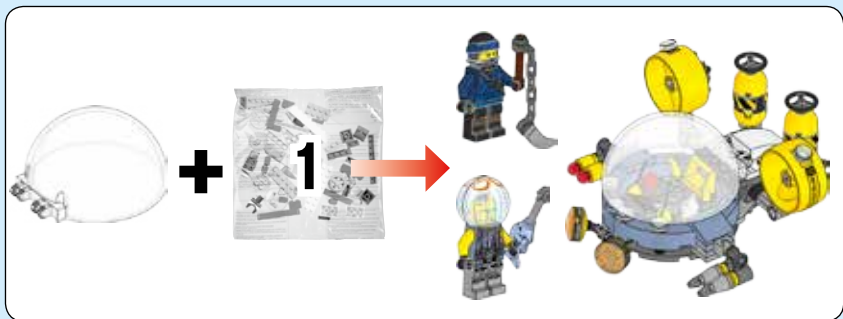

1

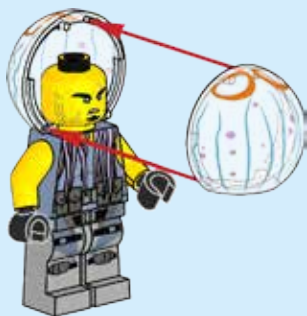

2

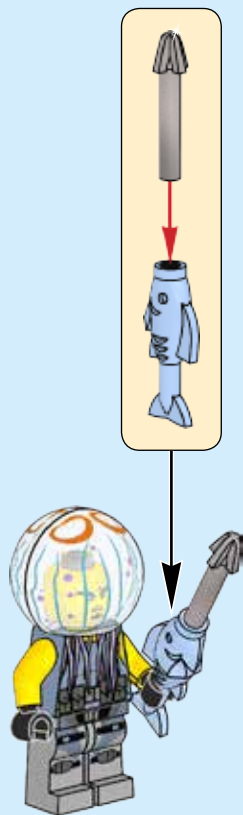



1x



1x

1





1x

2

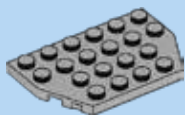
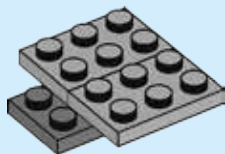

1x

3

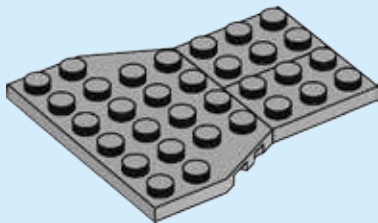



2x

4

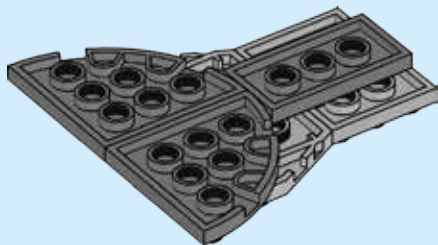
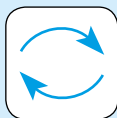

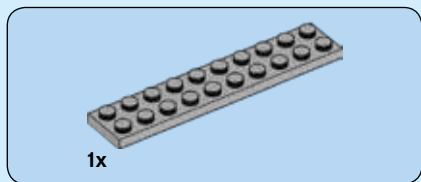

5

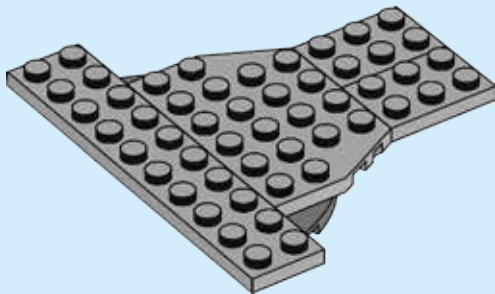
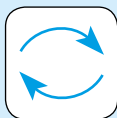



2x

6

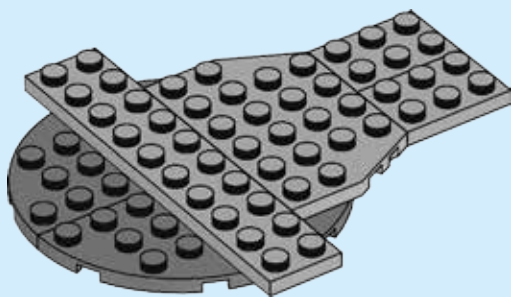



1x



1x

7

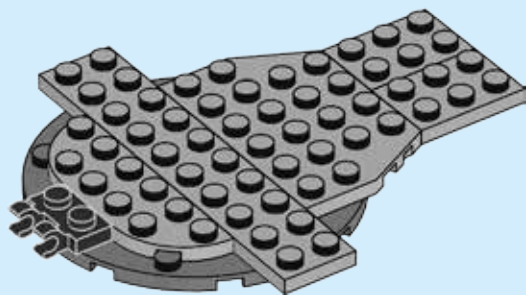



2x



2x

8

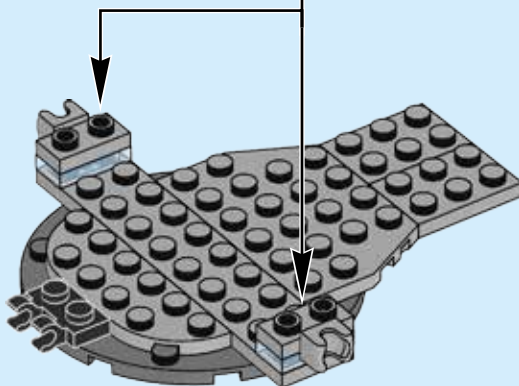
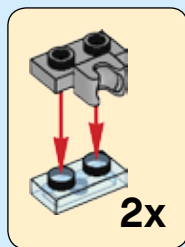

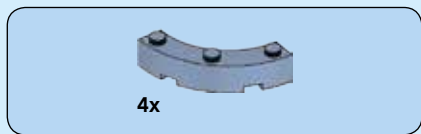

9

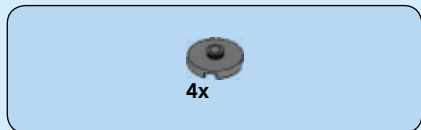
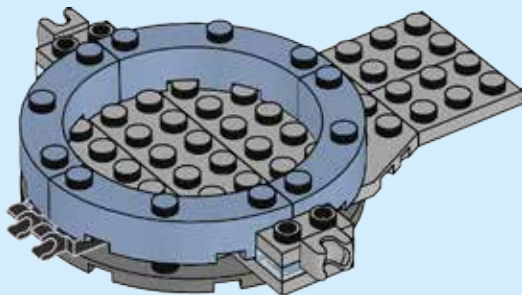

10

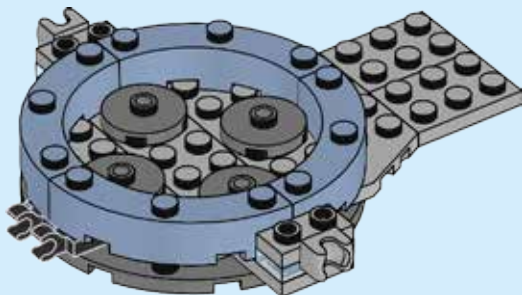



11

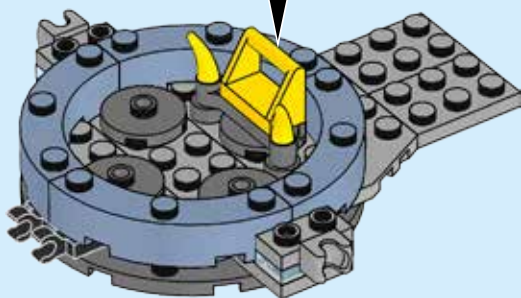
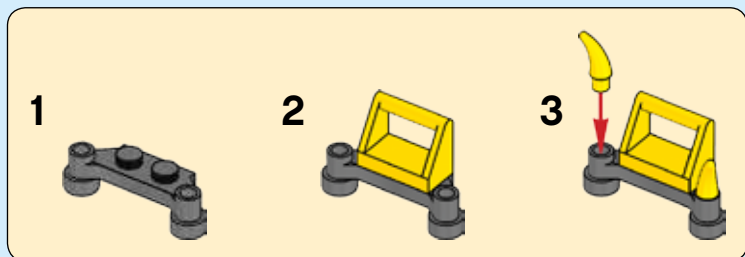



12

1



2



3

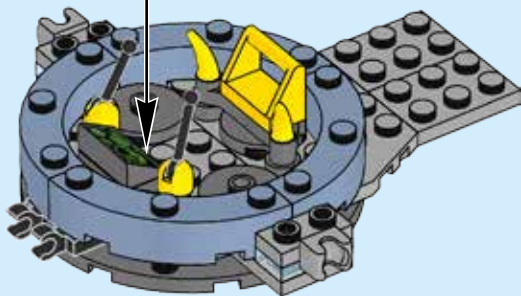



1x



1x

13

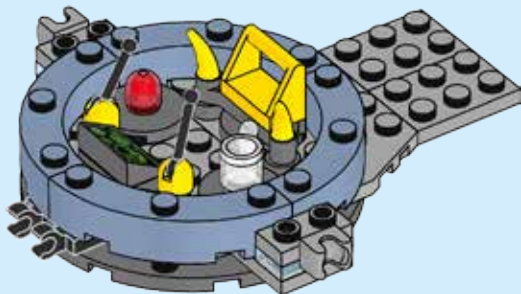



4x



2x

14

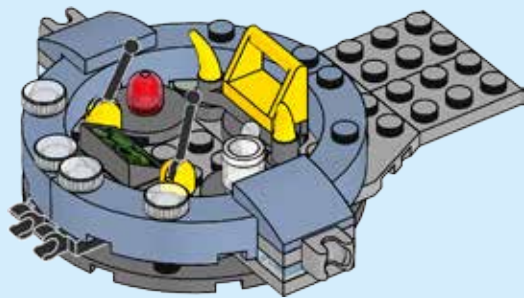



1x



2x

15

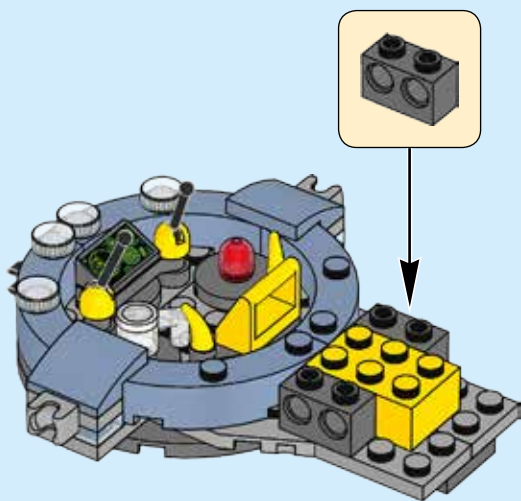

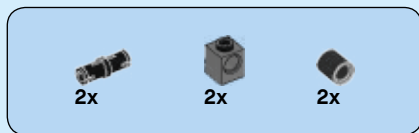

16

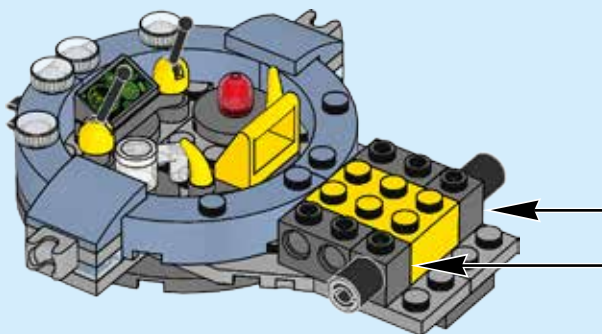
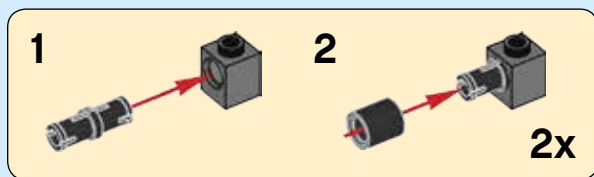



1x

17

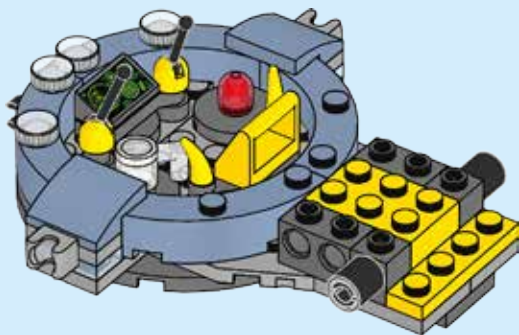



18

1

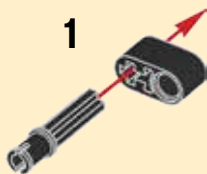

2



2x

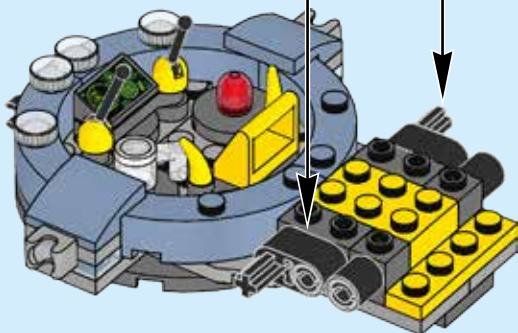



2x

19

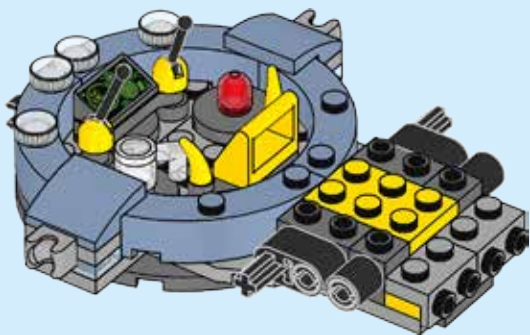



20

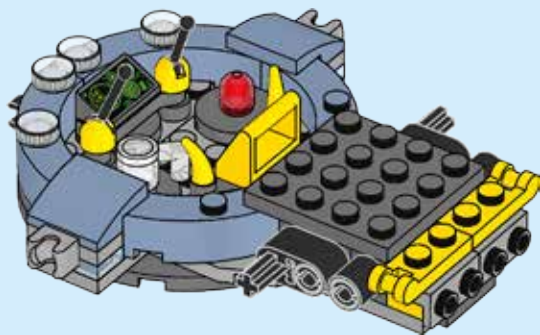



1x



2x

22

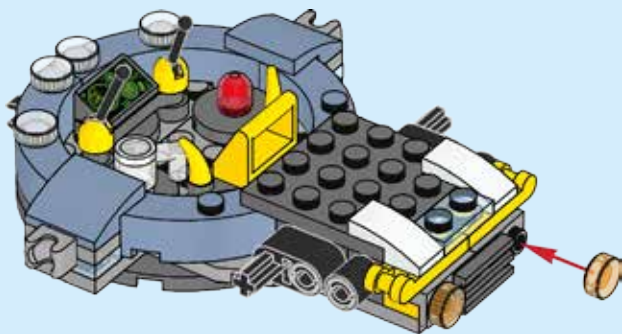



2x

23

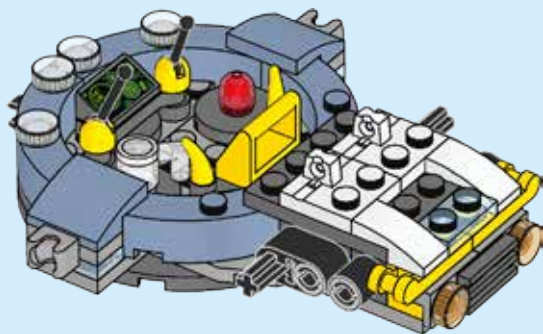



1x

24

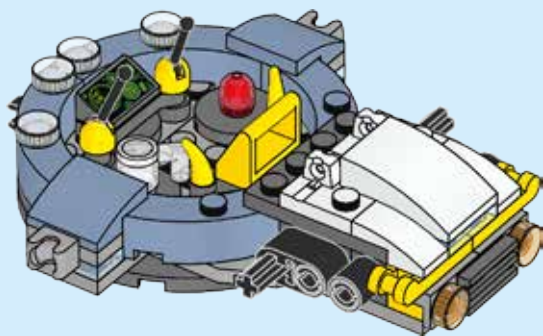

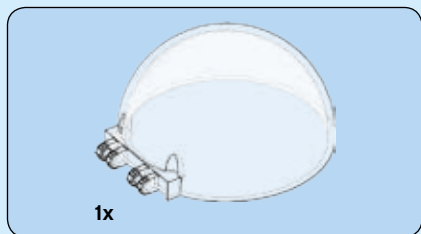

25

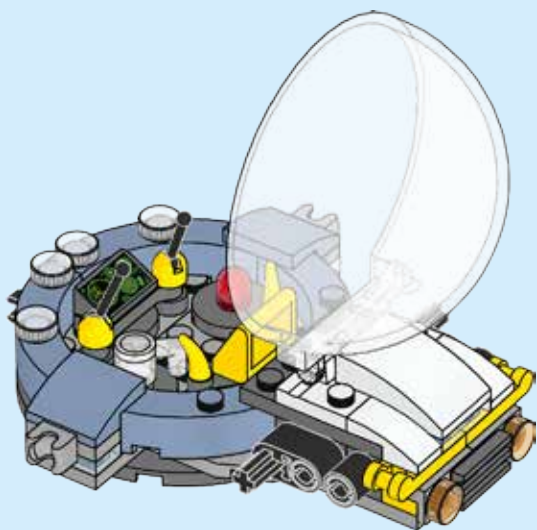



26

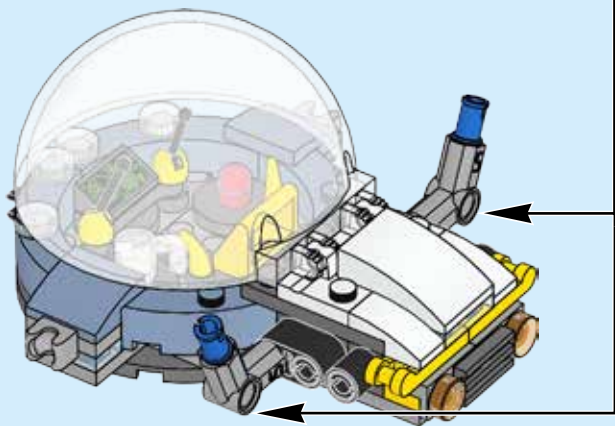
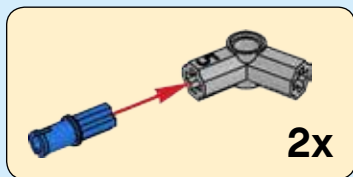



27

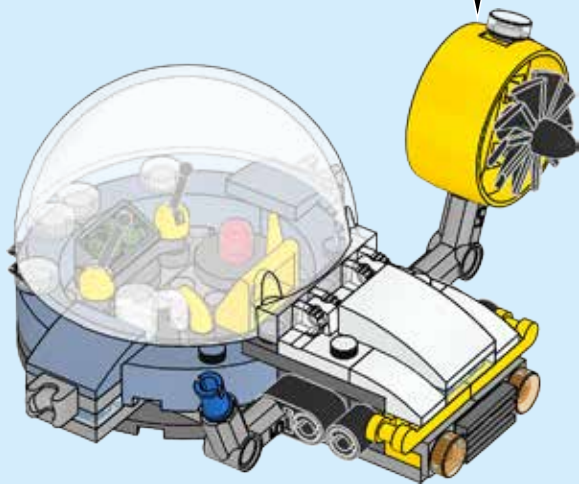
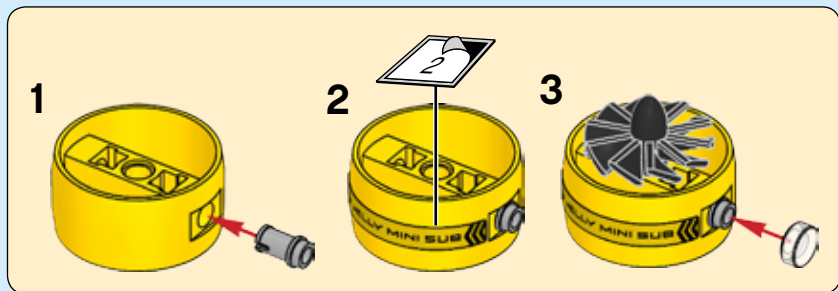



28

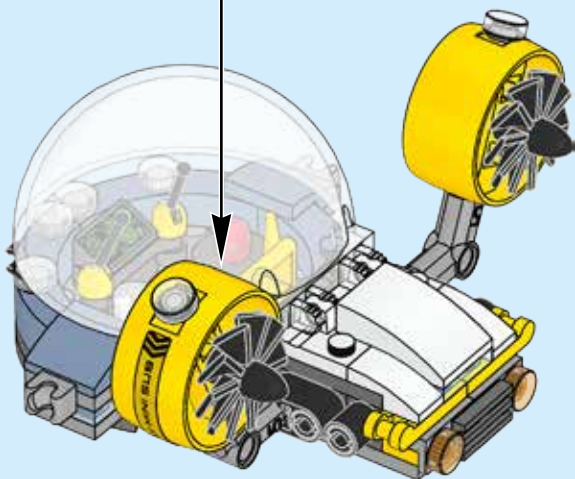
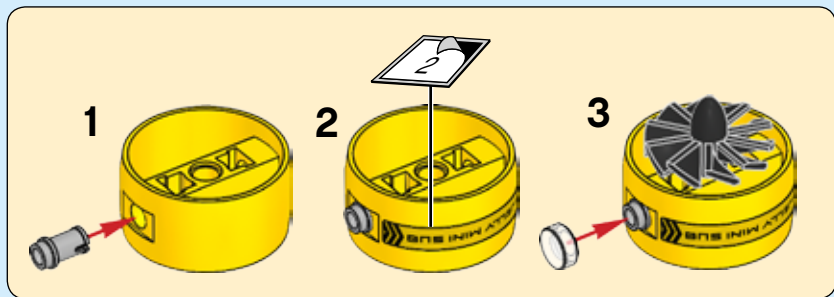

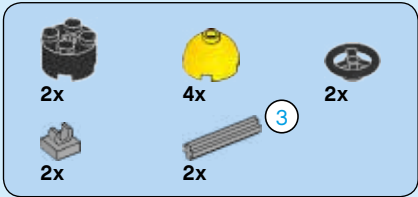
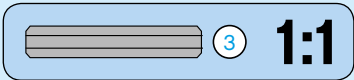

29

1

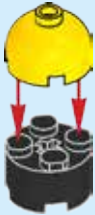

2



3



4



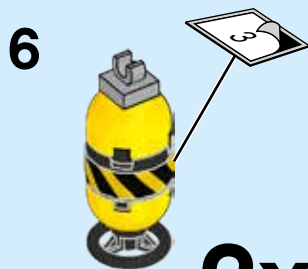

2x

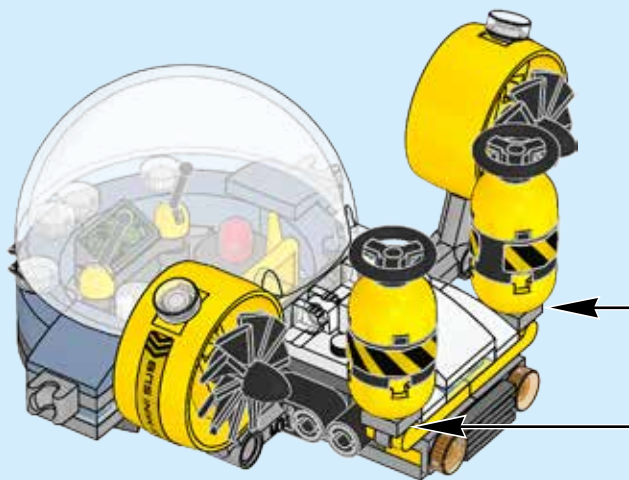



2x



2x

30

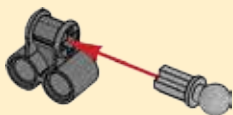

2x

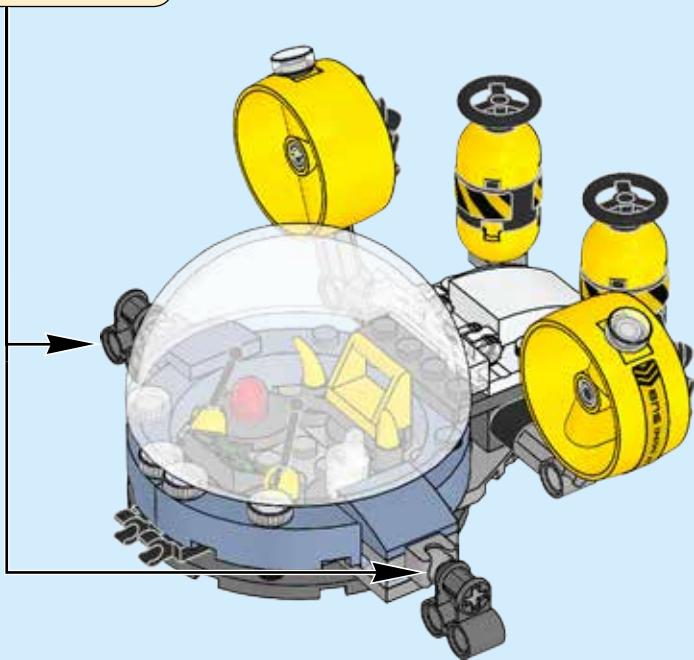



2x



2x



2x



2x

31

1

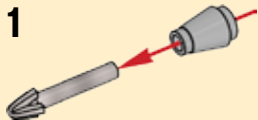

2

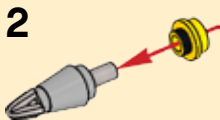

3

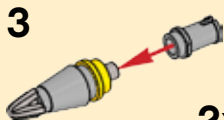

2x

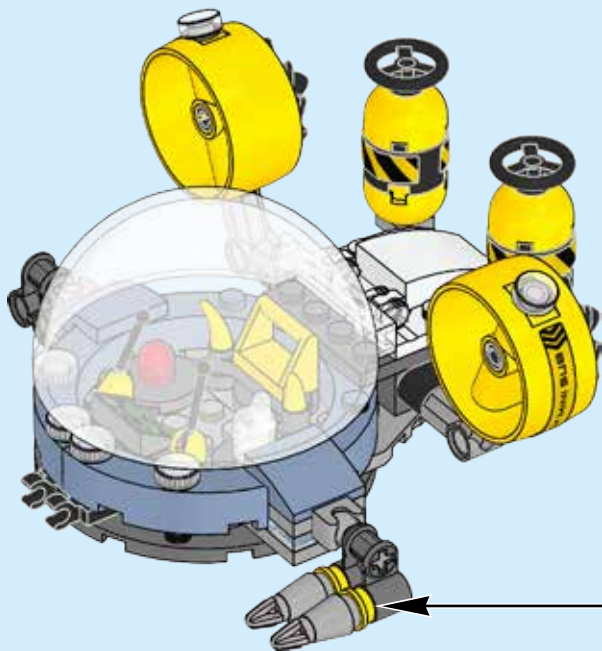



2x



2x



2x



32

1

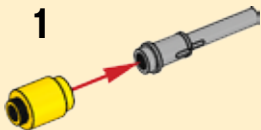

2



2x

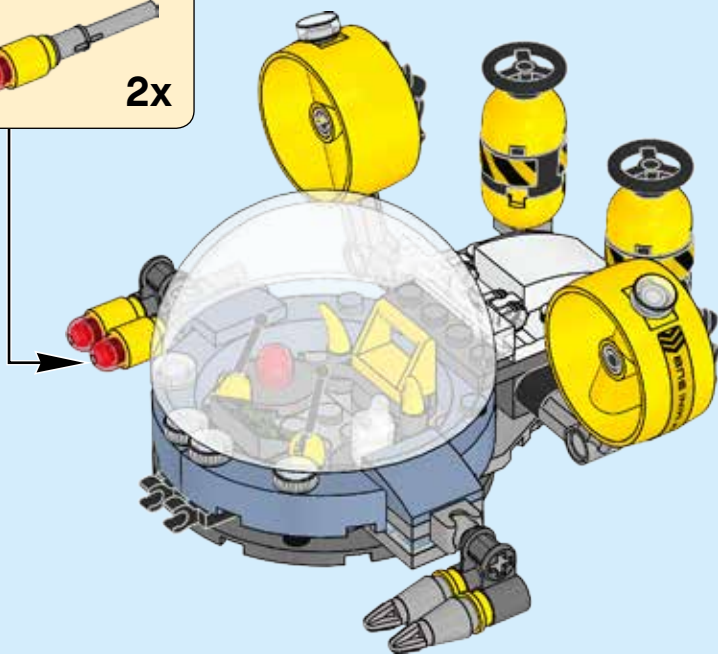



2x



2x



2x



2x

33

1

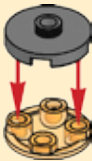

2

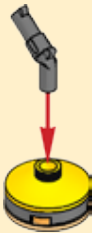

2x

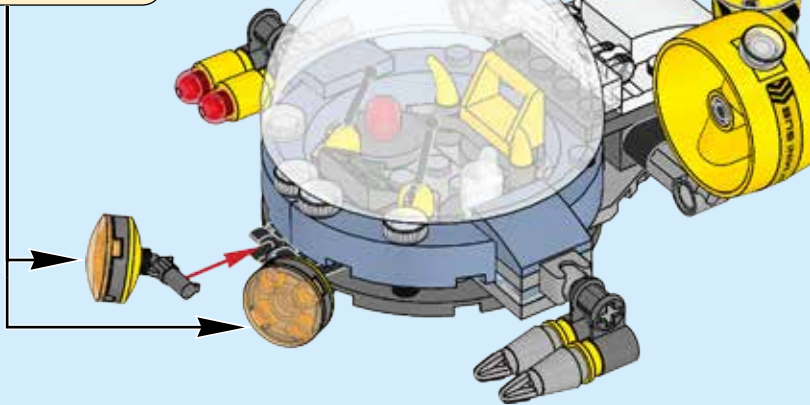

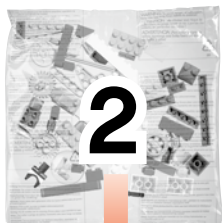

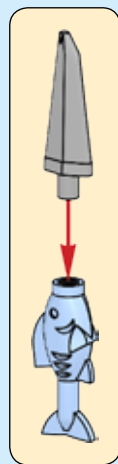
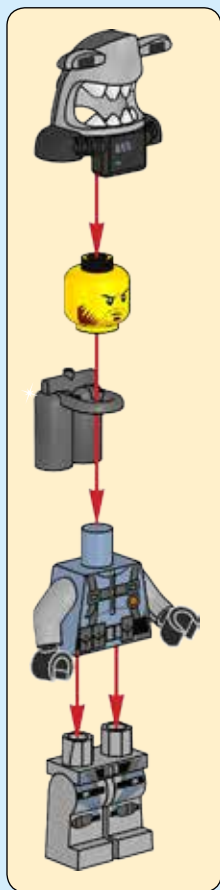



1x

34

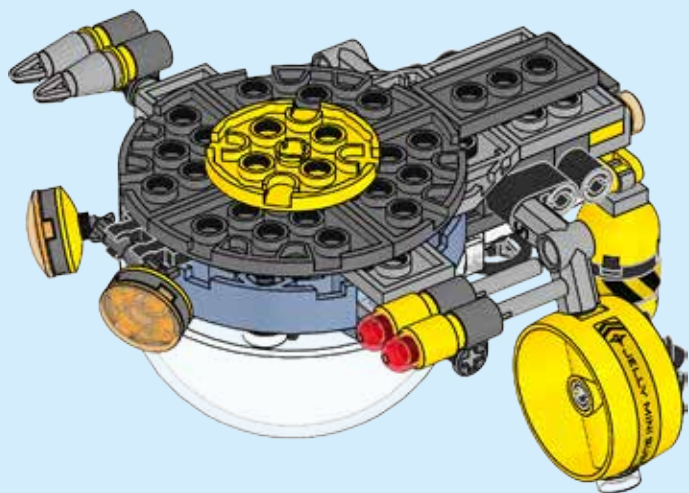
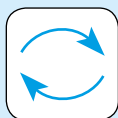

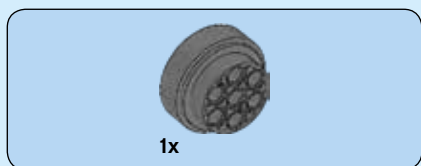

35

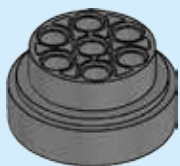



1x



1x

36

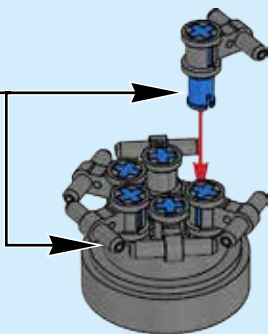
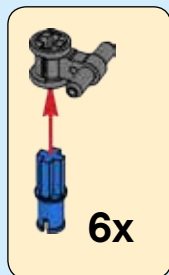



6x



1x



1x

37

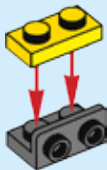



1x

38



1x

39





1x

40



1x



1x

41

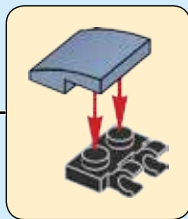

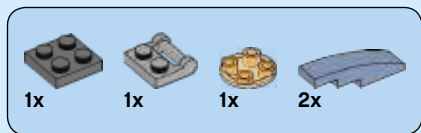

42

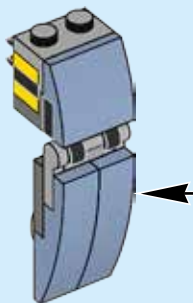
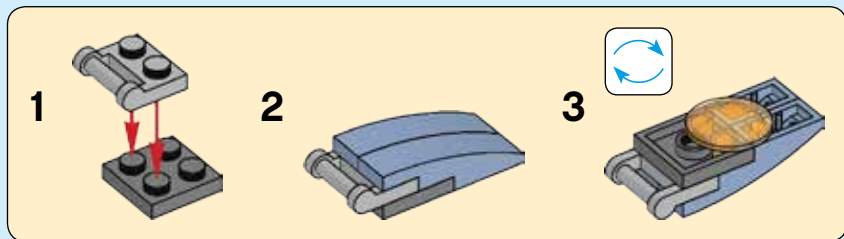

6x

43

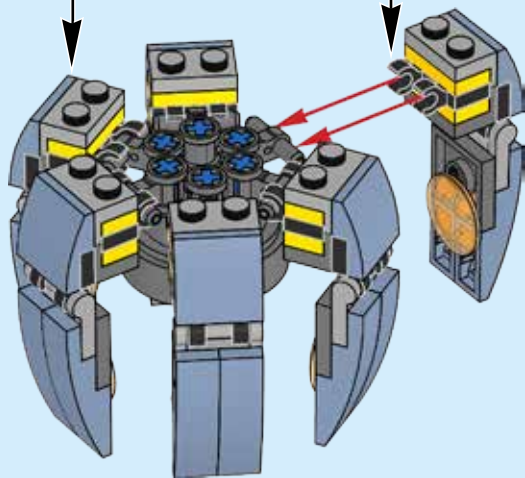

44

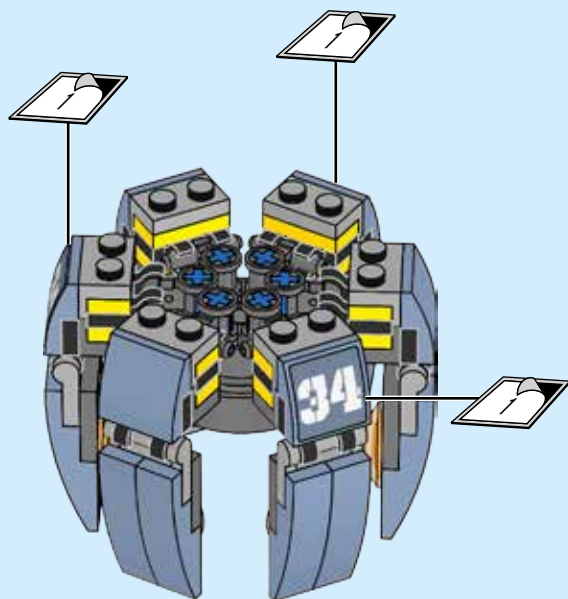

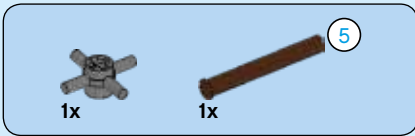

45

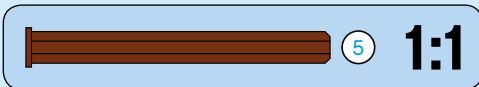
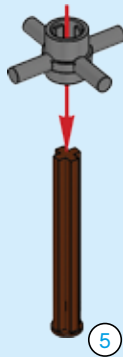

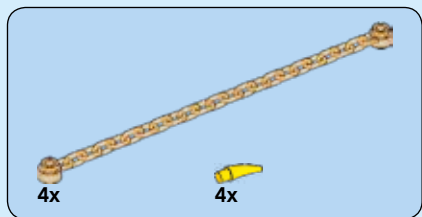

46

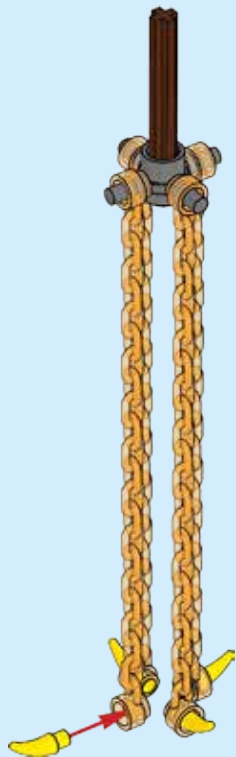

47

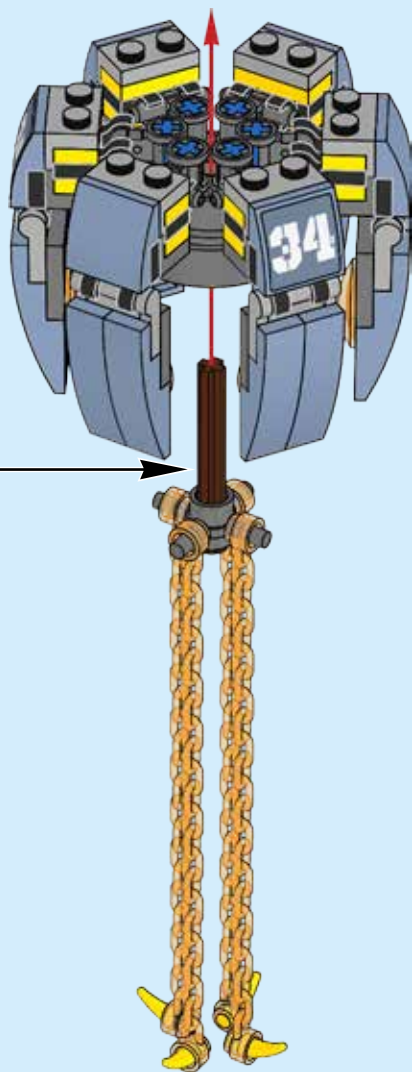



1x

48

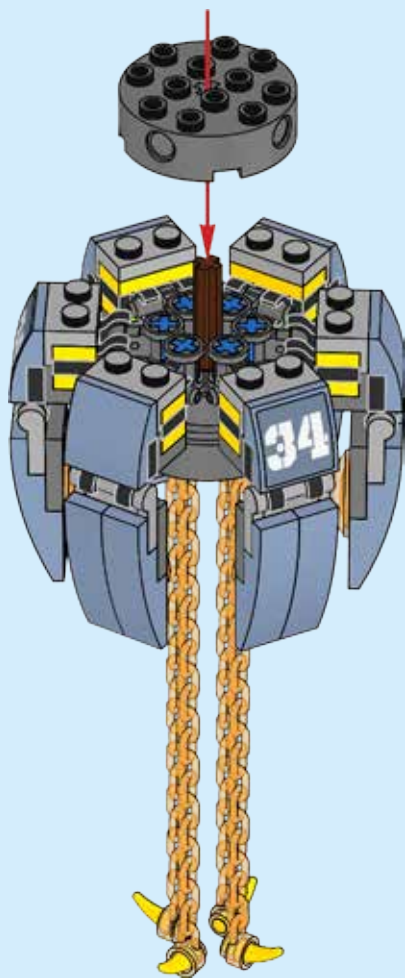

52

49

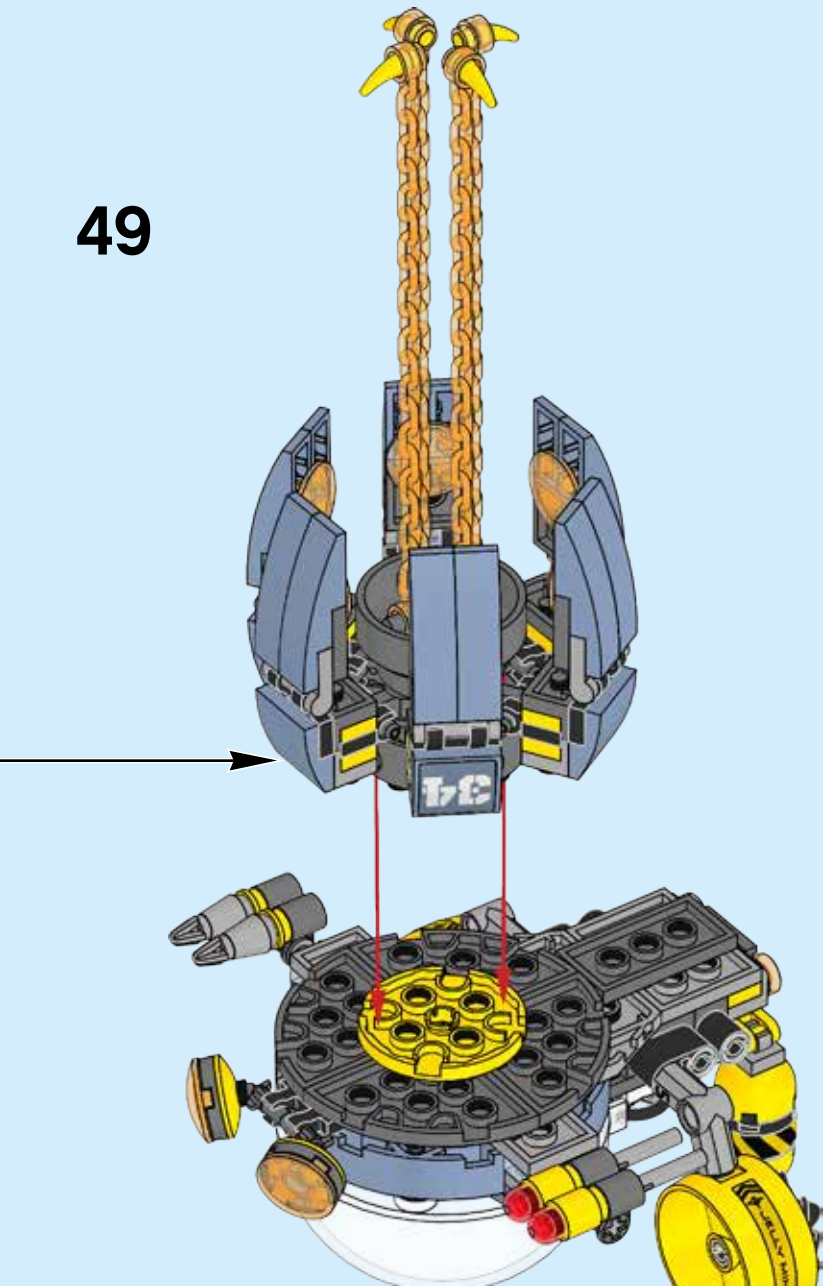

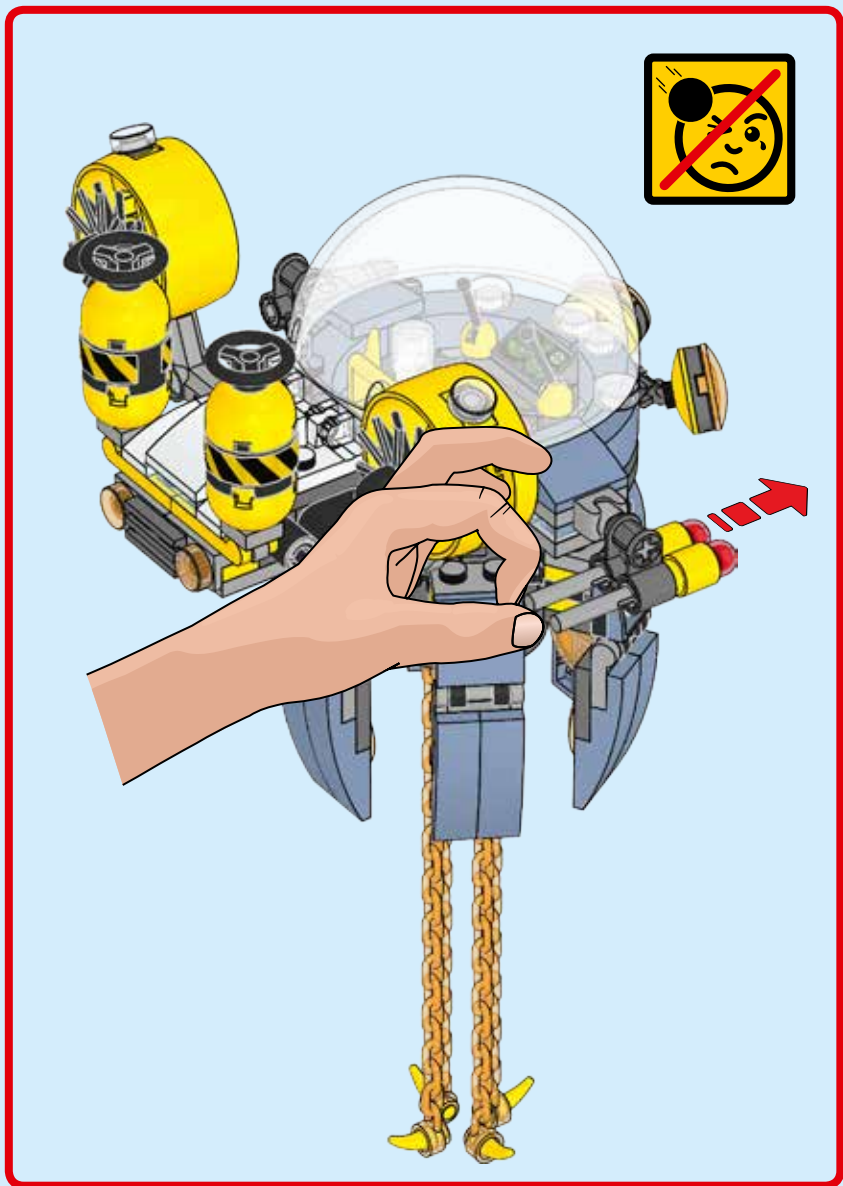



WIN

GO TO WWW.LEGO.COM/PRODUCTFEEDBACK
AND GIVE US YOUR SHORT **FEEDBACK**
ABOUT THIS LEGO® SET FOR A CHANCE
TO WIN A COOL LEGO PRIZE.

Terms & Conditions apply



LEGO.com/productfeedback

GEWINNE

Erzähle uns auf
www.LEGO.com/productfeedback

etwas über die Erfahrungen, die du mit
diesem LEGO® Set gemacht hast, und
sichere dir die Chance auf einen coolen
LEGO Preis!

Es gelten die Teilnahmebedingungen

获取奖品

登录
www.LEGO.com/productfeedback

给出关于此乐高®套装的简短反馈，
就有机会获得炫酷乐高奖品

《条款及条件》适用

GAGNE

Rends-toi sur
www.LEGO.com/productfeedback

et donne-nous quelques commentaires
sur ce produit LEGO® pour avoir une
chance de gagner un prix LEGO !

Voir Conditions Générales

경품 당첨 기회

www.LEGO.com/productfeedback

페이지로 이동하여 이 레고® 세트에 대한
간략한 피드백을 보내 주시고 멋진 레고
경품을 탈 수 있는 기회도 잡으십시오

약관 적용

GANA

Visita
www.LEGO.com/productfeedback

y envíanos tu opinión acerca de este
set LEGO®. ¡Participas en el sorteo
de un premio LEGO!

Términos y Condiciones aplicables

ЗАПОЛНИ АНКЕТУ И ПОЛУЧИ ПРИЗ

Перейди по ссылке
www.LEGO.com/productfeedback

ответь всего на несколько во-
просов об этом наборе LEGO®,
и у тебя появится шанс выиграть за-
мечательный приз от компании LEGO.

Применяются Условия и правила
участия

THE LEGO NINJAGO MOVIE © & ™ Warner Bros. Entertainment Inc. & The LEGO Group. LEGO, the LEGO logo, NINJAGO and the Brick and Knob configurations are trademarks of the LEGO Group. ©2017 The LEGO Group. All rights reserved.
(s17).

6207799



THE NINJAGO MOVIE

70610



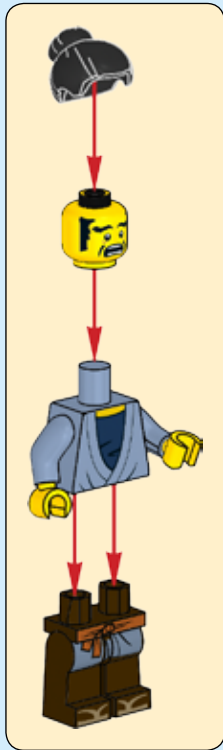
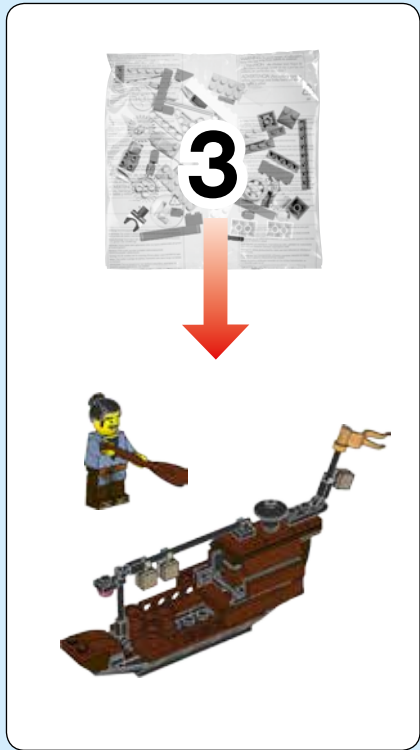

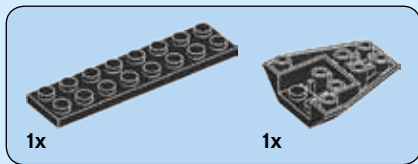

1

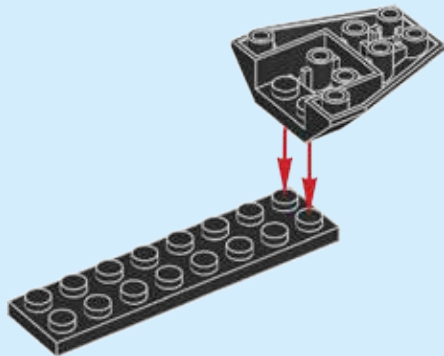

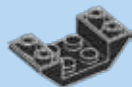

3x

2

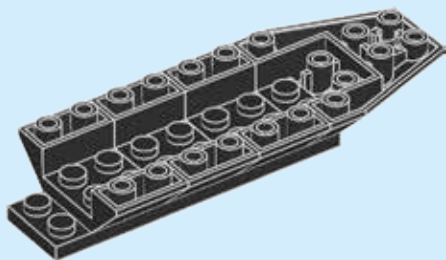

4

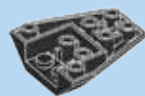

1x

3

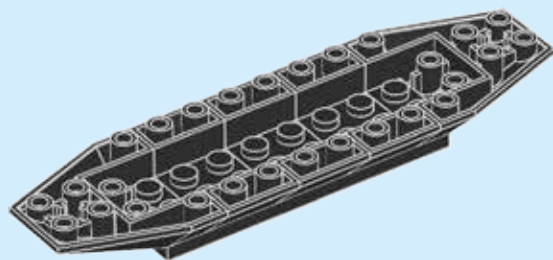

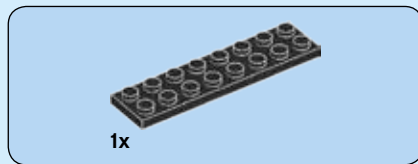

4

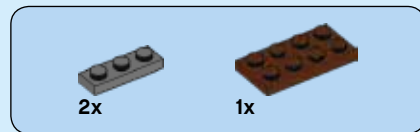
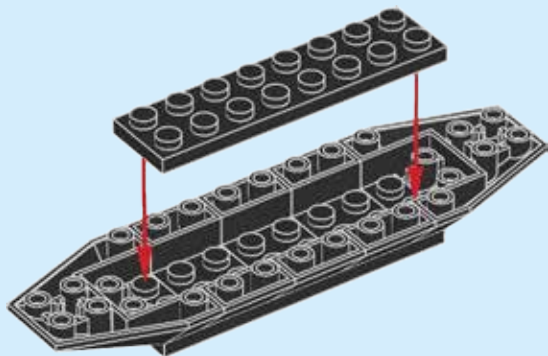

5

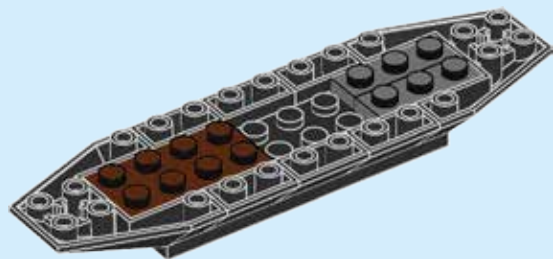

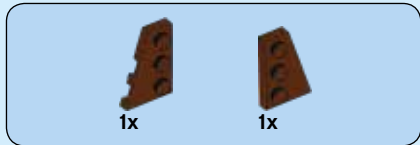

6

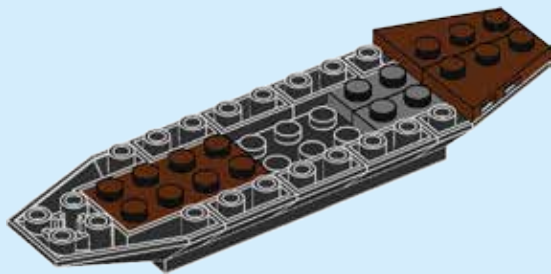

6



7

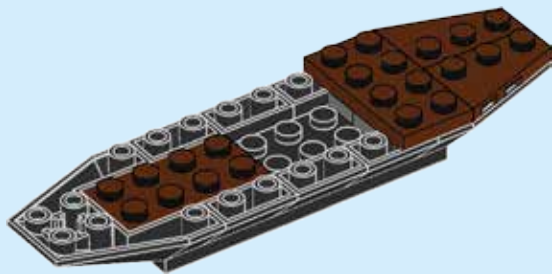



8

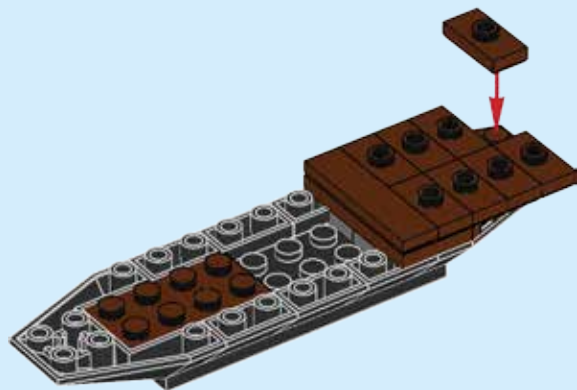

9

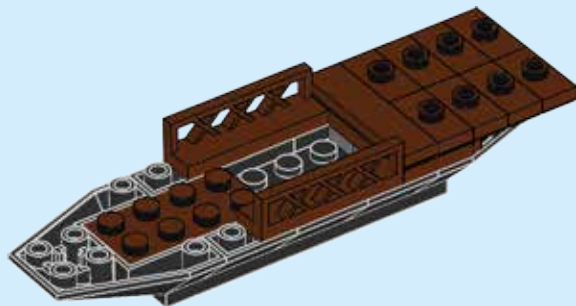

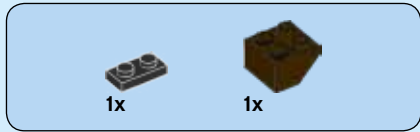

10



11

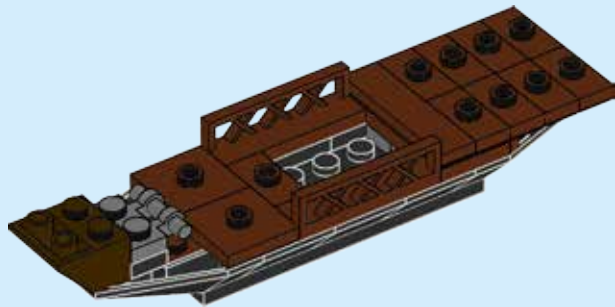



2x

12

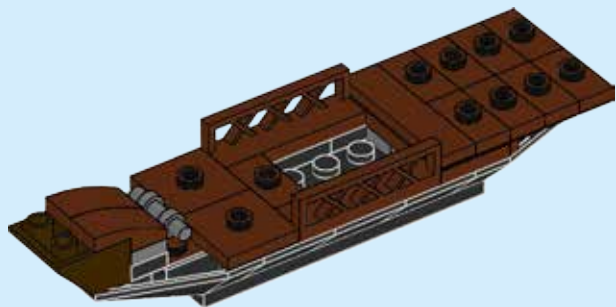

1x

13

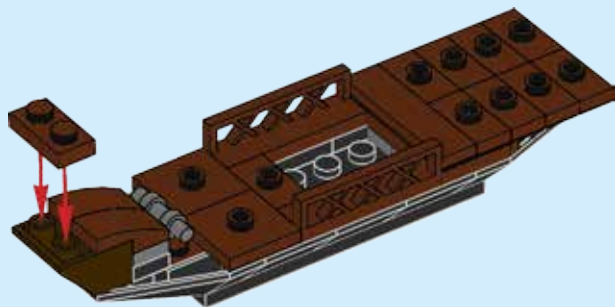



4x

14

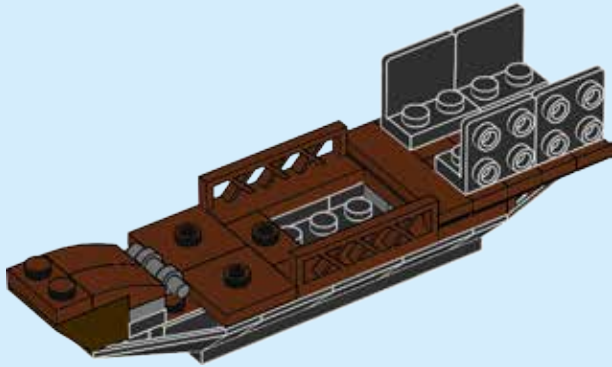

10



1x

15

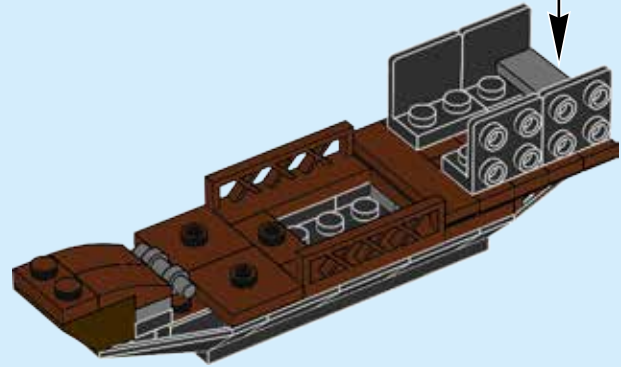
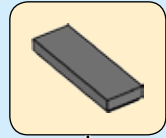



1x

16

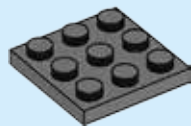

2x

17

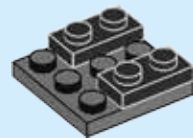



18

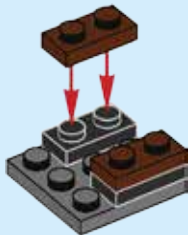

19

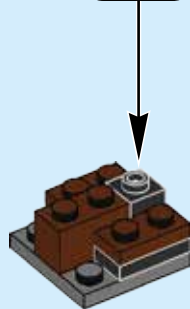



1x

20

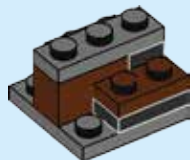

1x



1x

21

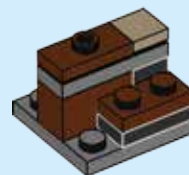



2x



2x

22

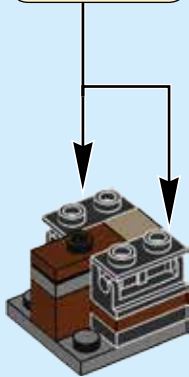
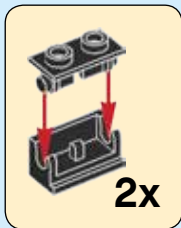

23

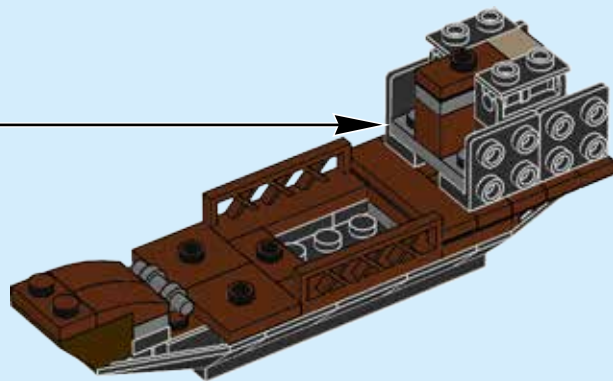

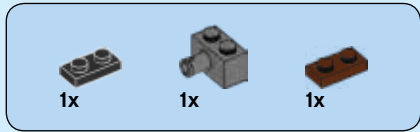

24

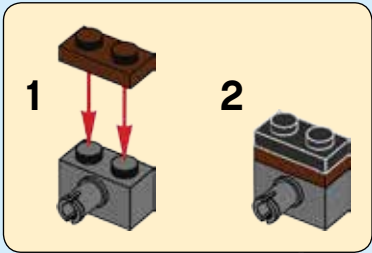

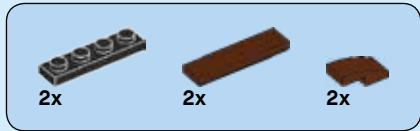

25

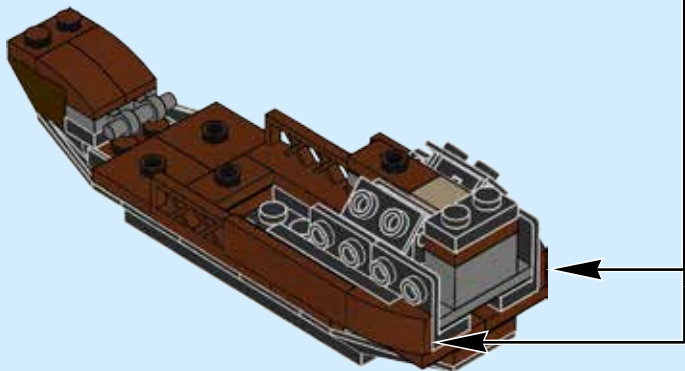
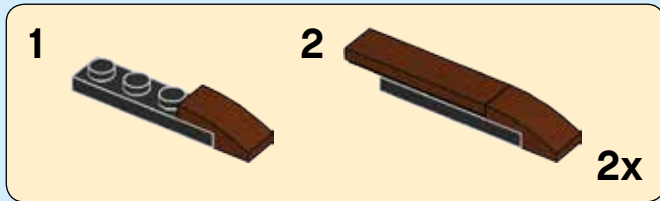



26

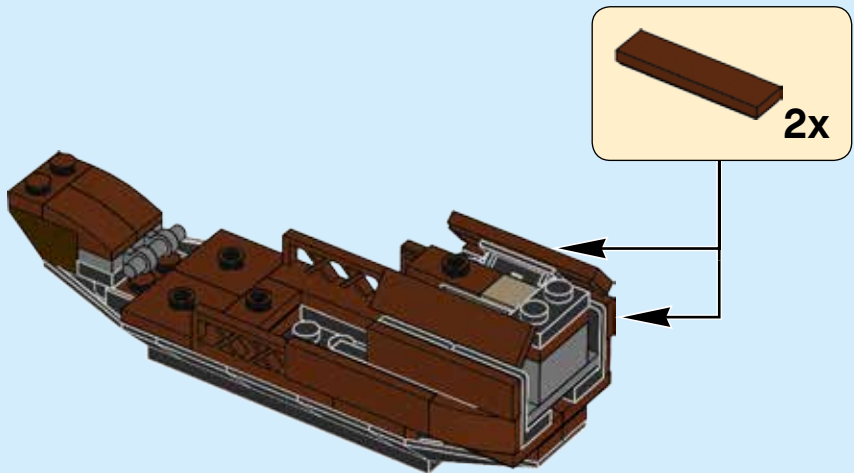



27

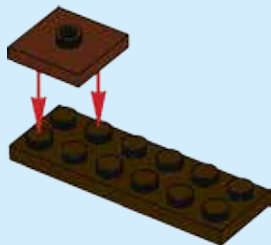

28





1x



1x



1x

29



1x



1x

30

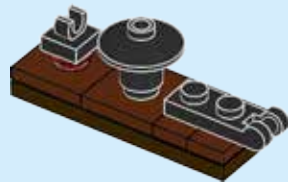

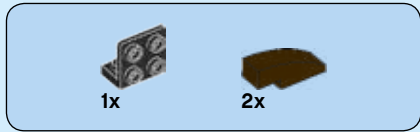

31

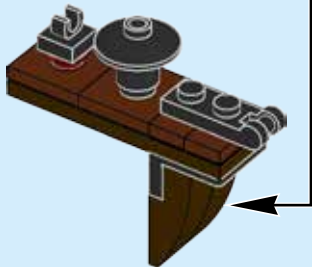
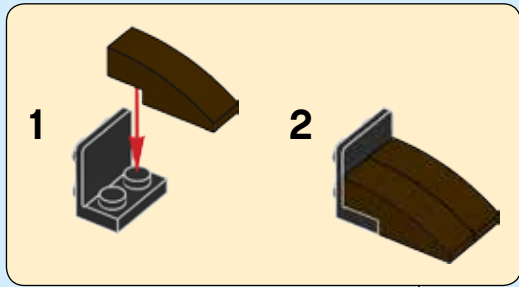

32

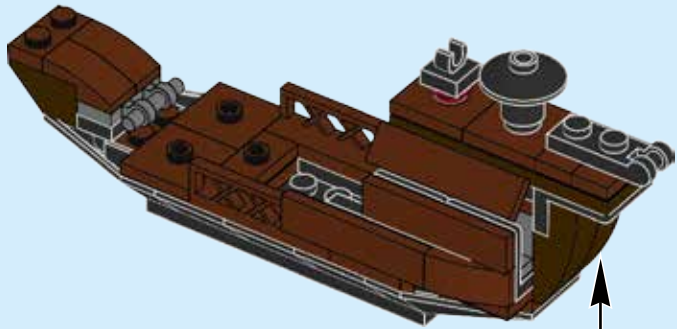



33

1



2

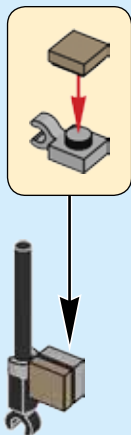

3

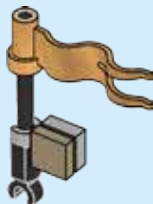

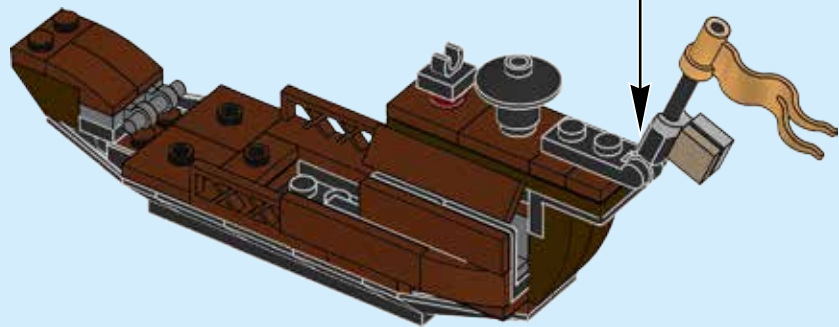



3x

34





1x



1x

35

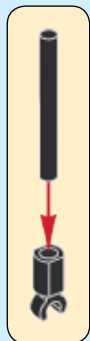



1x



1x

36



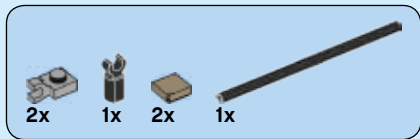

37

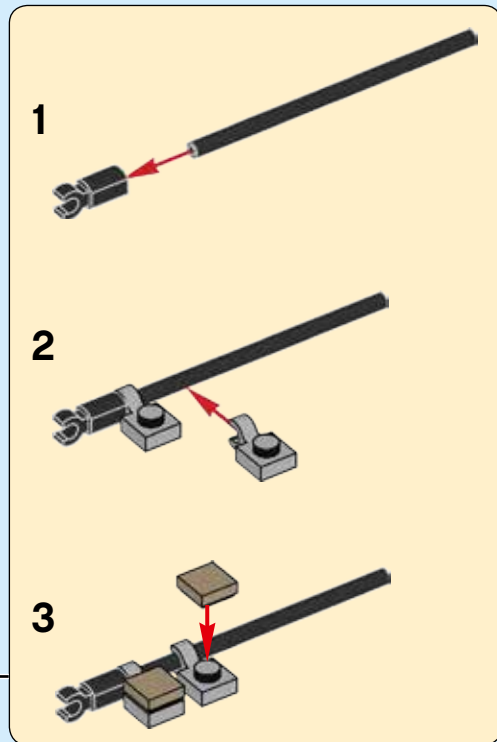
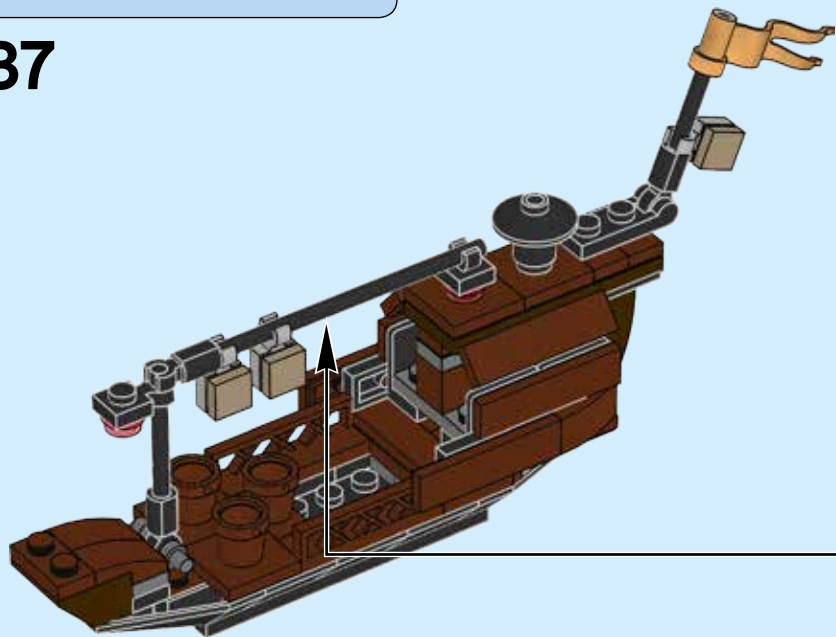

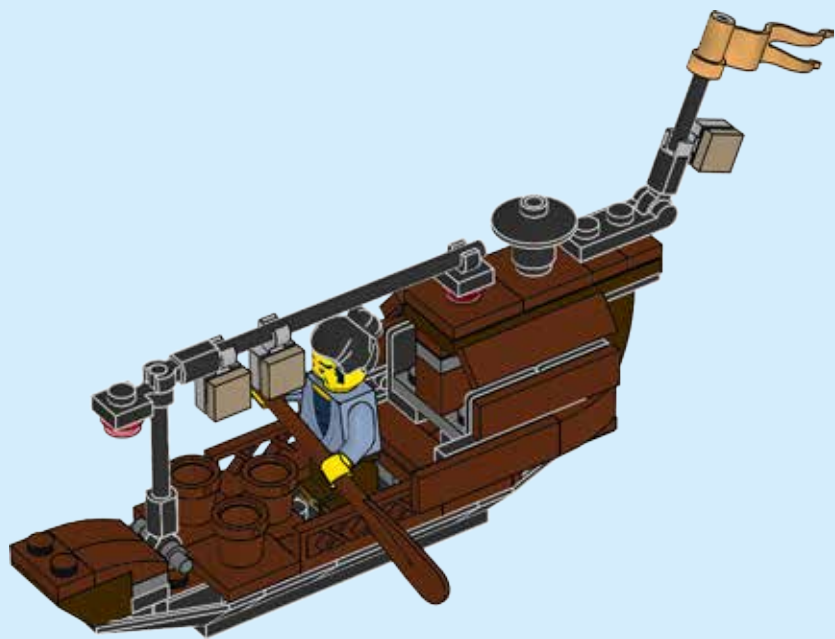



THE
NINJAGO
MOVIE

LEGO.COM/NINJAGOMOVIE



THE NINJAGO MOVIE

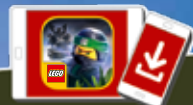

LEGO® WU-CRU
LEGO.com/apps



LEGO.COM/NINJAGOMOVIE



THE NINJAGO MOVIE



70606



70607



70608



70609



70611



70612



70614



70618



70615



70617



©2017 The LEGO Group. THE LEGO NINJAGO MOVIE © The LEGO Group & WB/EI.



THE NINJAGO MOVIE

VIDEOGAME



7TM
www.pegi.info
PROVISIONAL



PC



GAMES

LEGO.com/videogames



LEGO



WORLDS

UNLOCK MODEL IN GAME / Separate purchase required
MODELL IM SPIEL FREISCHALTEN / Separater Kauf erforderlich
DÉBLOQUEZ LE MODÈLE EN JEU / Achat séparé requis
SBLOCCA MODELLO NEL GIOCO / Da acquistare separatamente
DESBLOQUEAR MODELO EN EL JUEGO / A la venta por separado
DESBLOQUEAR MODELO NO JOGO / É necessária compra em separado
MODELL KIOLDÁSA A JÁTÉKBAN / Külön vásárlás szükséges
在游戏里解锁模型 / 需分开购买

PPA72V



LEGO THE MINIFIGURE MOVIE





















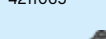







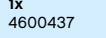





















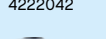







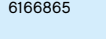





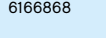

7

www.pegi.info
PROVISIONAL

TT GAMES
LEGO GAMES

LEGO WORLDS software © 2017 TT Games Ltd. Produced by TT Games under license from the LEGO Group. LEGO, the LEGO logo, the Brick and the Knob configurations and the Minifigure are trademarks of the LEGO Group. © 2017 The LEGO group. All other trademarks and copyrights are the property of their respective owners. All rights reserved. WB GAMES LOGO, WB SHIELD: ™ & © Warner Bros. Entertainment Inc. (s17)

LEGO.com/worlds

 3x 4626196	 7x 4211194	 6x 6020189	 1x 4222192	 1x 4211065	 1x 6192758	 4x 4211483	 2x 4211029
 1x 6021336	 2x 6192371	 1x 6194290	 6x 4211094	 1x 4600437	 1x 6192565	 2x 6071229	 1x 6195495
 1x 6021339	 2x 4211186	 6x 6115080	 3x 4211133	 1x 4243831	 1x 6191864	 2x 4211375	 1x 4616840
 4x 6069984	 1x 6159763	 2x 4210655	 1x 4568734	 1x 4243831	 1x 6195487	 2x 4541978	 2x 4211815
 12x 6092590	 1x 4609635	 1x 4210631	 2x 6086709	 4x 4222042	 1x 4648296	 2x 4529241	 2x 4520320
 1x 4211149	 2x 6034044	 2x 4210762	 1x 4549886	 8x 6166865	 2x 6022199	 2x 4211551	 2x 4211396
 4x 4211150	 2x 4613762	 6x 6000606	 1x 4211097	 12x 6166868	 1x 4518687	 2x 6192577	 1x 6105964
 1x 6075208	 1x 6132212	 1x 4211087	 1x 4211097	 4x 6166870	 1x 6192605	 2x 6043656	 1x 4211725
 4x 4565394	 2x 4210639	 1x 4210660	 1x 6039176	 1x 6195406	 1x 6192605	 8x 4654582	 1x 4211462



2x
6088638



2x
6089119



1x
4515368



2x
371026



3x
4188534

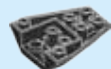

2x
6092952



1x
6193640



2x
303426



2x
6116604



2x
614326



4x
4121715



1x
6191921



2x
6006140



4x
302326



2x
393826



2x
393726



5x
6000650



13x
4556158



3x
6015891



1x
306226



2x
6121485



1x
6066102



1x
654126



1x
6099429



1x
6173926



1x
6191714



1x
4550017



1x
474026



2x
6057397



8x
4206482



6x
4650498



1x
626440



2x
6192645



3x
4497943



2x
3005741



4x
6055172



2x
6195347



1x
4504649



3x
6162578



4x
4216656



1x
243224



2x
306224



1x
6191858



1x
6194799



1x
6192818



1x
6195253



6x
6014033



2x
4169960



2x
74156



2x
6168644



12x
302324



2x
4515367



1x
300224



1x
371024



1x
4515349



2x
6100888



1x
6178629



3x
6121436



2x
4646865



8x
4278409



4x
6132438



Customer Service

Kundenservice

Service Consommateurs

Servicio Al Consumidor

LEGO.com/service or dial



: 00800 5346 5555

: 1-800-422-5346



THE LEGO NINJAGO MOVIE © & ™ Warner Bros. Entertainment Inc. & The LEGO Group. LEGO, the LEGO logo, NINJAGO and the Brick and Knob configurations are trademarks of the/son des marques registradas de LEGO Group. ©2017 The LEGO Group. All rights reserved/Tous droits réservés/Todos los derechos reservados. (s17)



BILLUND • DEUTSCHLAND
WINDSOR • MALAYSIA

**EXCLUSIVELY • EXKLUSIV • EXCLUSIVEMENT • EN EXCLUSIVA • ESCLUSIVO
EXCLUSIVAMENTE • KIZÁRÓLAGOSAN • 独家所有 • EKSKLUSIVT • ここだけの特典 • ÖZEL**



Manchester • Berlin • Oberhausen
Istanbul • Osaka • Shanghai • Tokyo



LEGO, the LEGO logo, the Brick and Knob configurations, NINJAGO, the Minifigure and LEGOLAND are trademarks of the LEGO Group. ©2017 The LEGO Group. LEGOLAND is part of Merlin Entertainments plc.

LEGOLAND.COM

6207801