

[LEGO.com/brickseparator](https://www.lego.com/brickseparator)

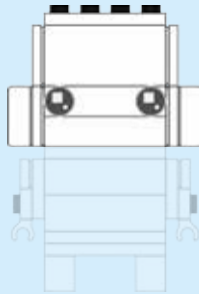

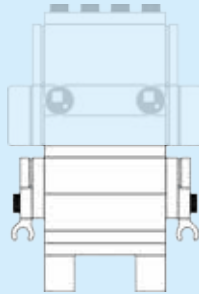

1

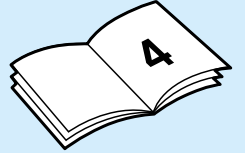
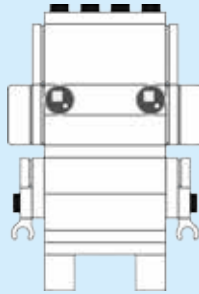
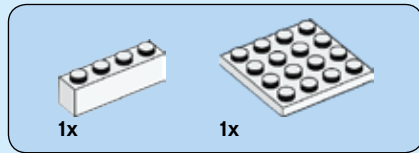
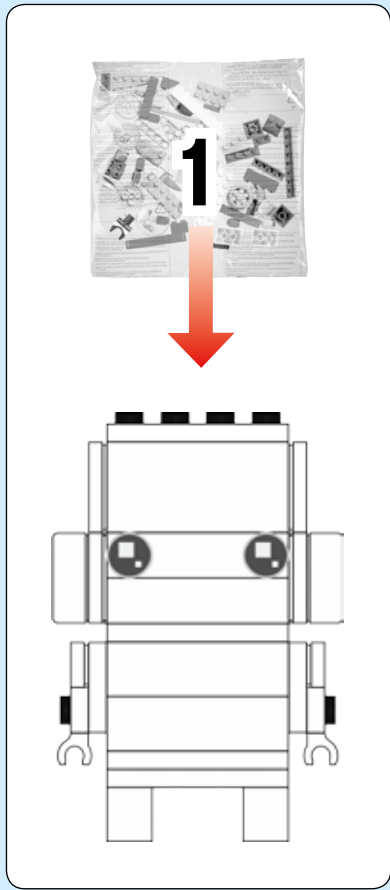
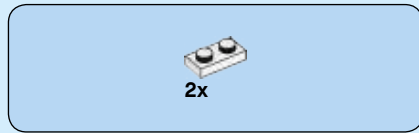

2

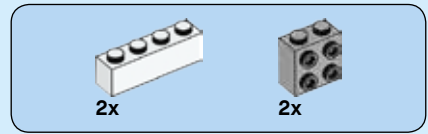
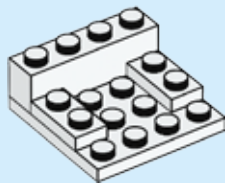

3

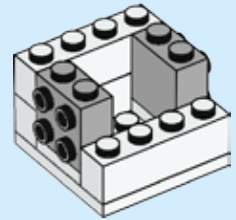

4

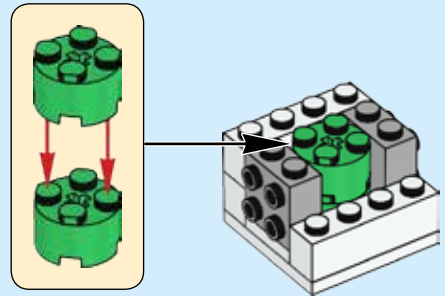

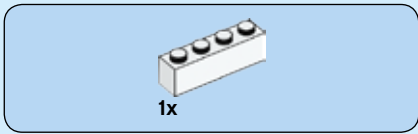

5

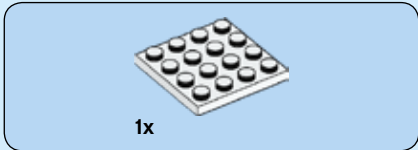
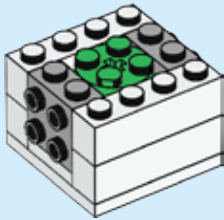

6

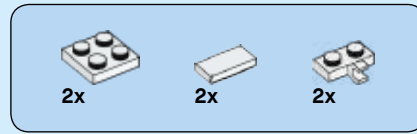
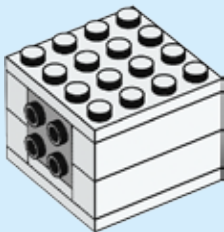

7

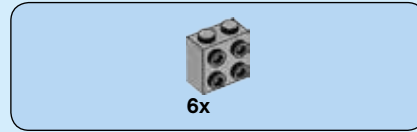
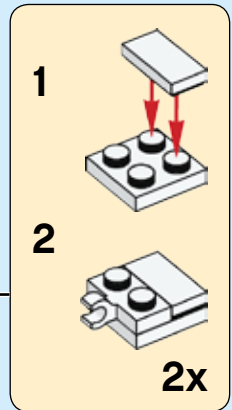
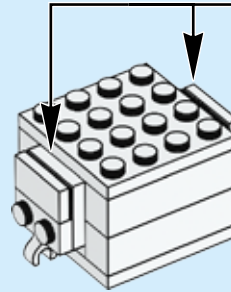

8

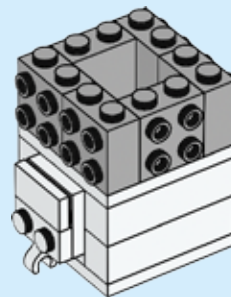

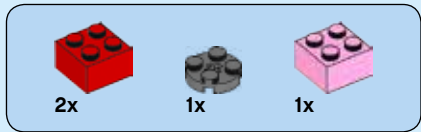

9

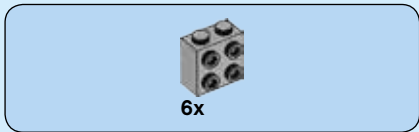
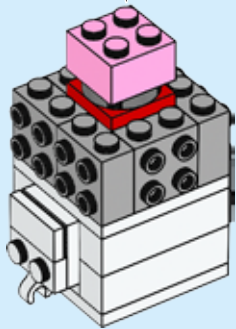
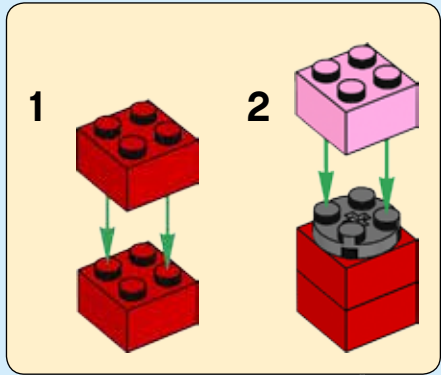

10

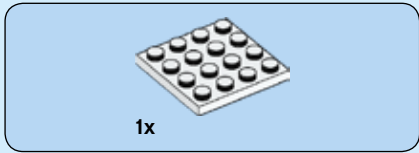
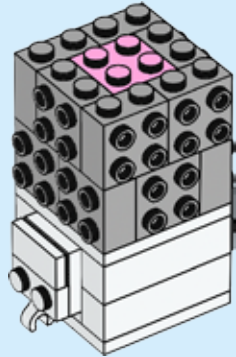

11

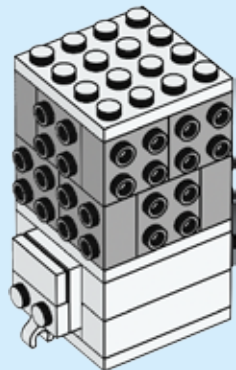

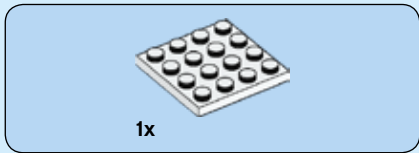

12

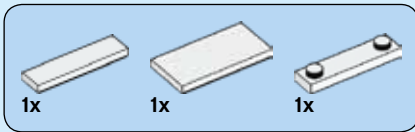
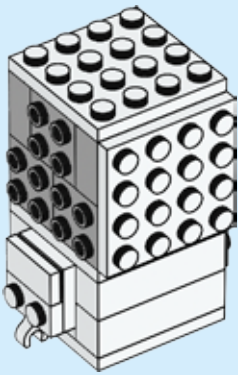

13

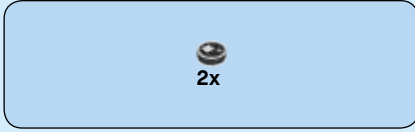
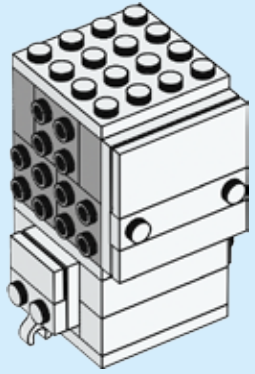

14

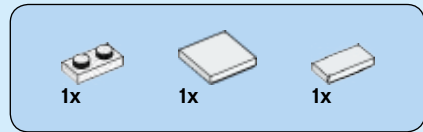
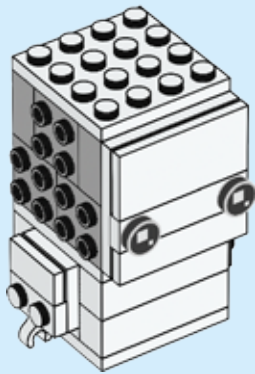

15

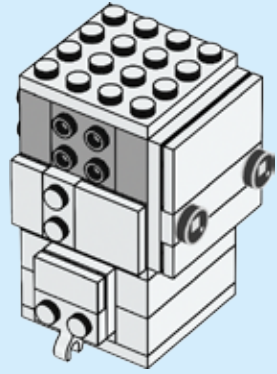

16

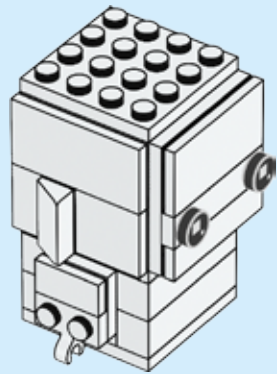

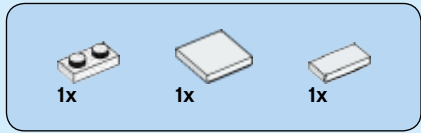

17

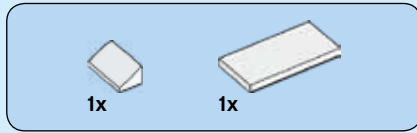
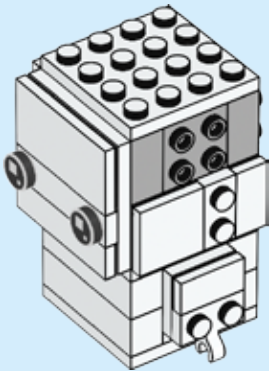
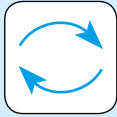

18

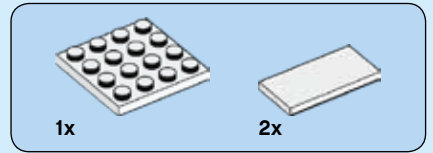
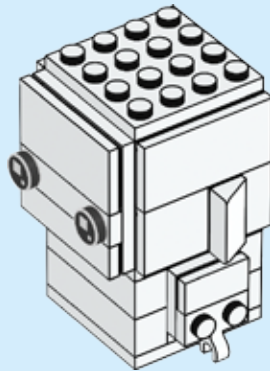

19

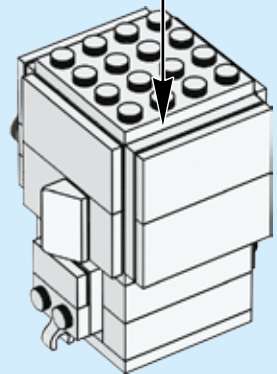
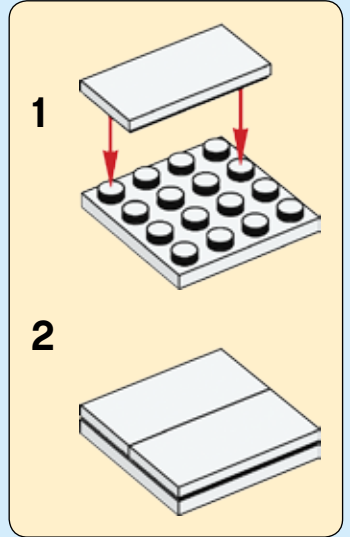



1x

20

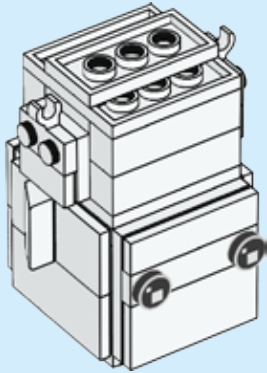

2x

21

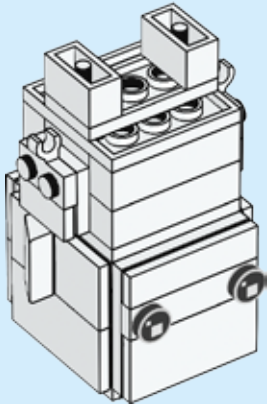

1x



1x



1x

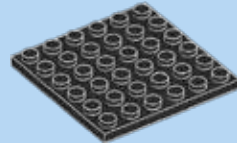

1x

22

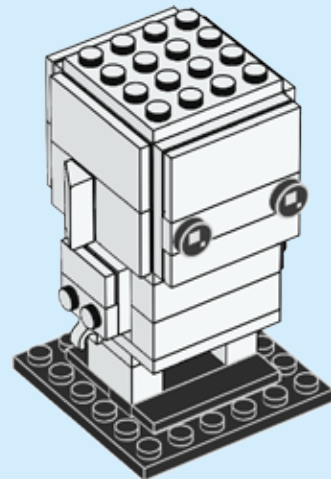
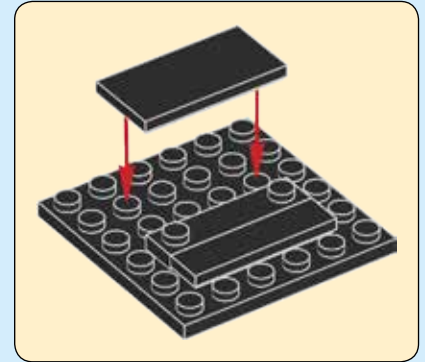
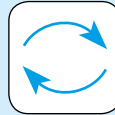





BRICK HEADZ

#BRICKHEADZ



GO
BRICK
ME

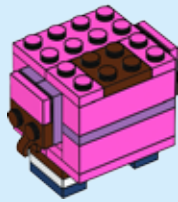
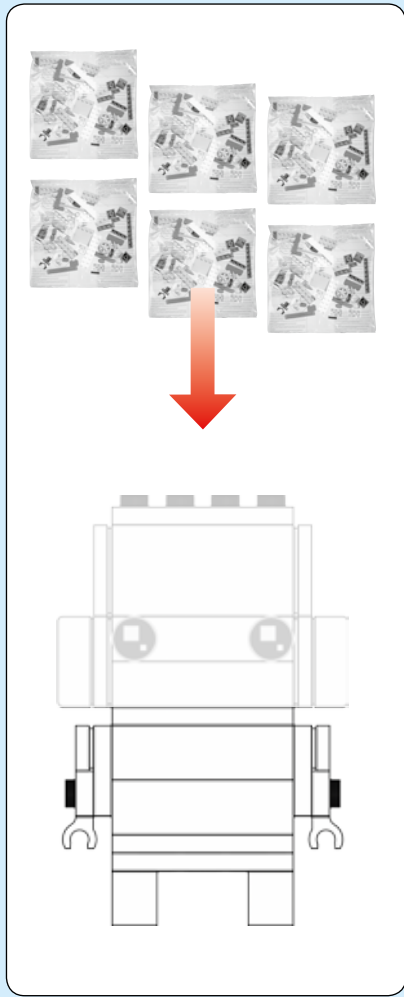



1

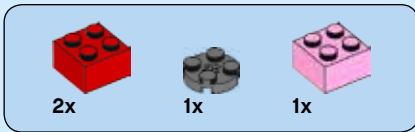
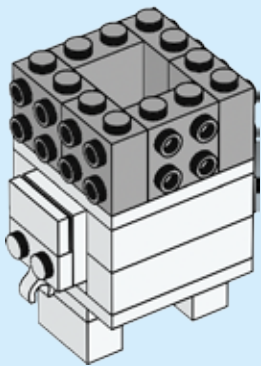

2

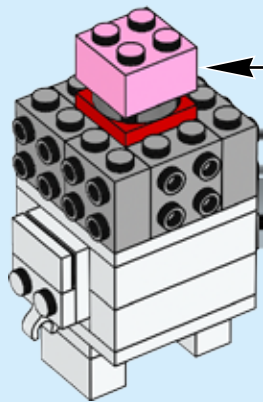
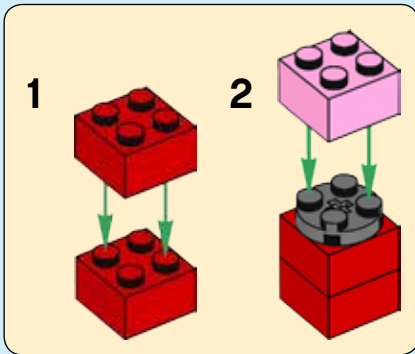

3

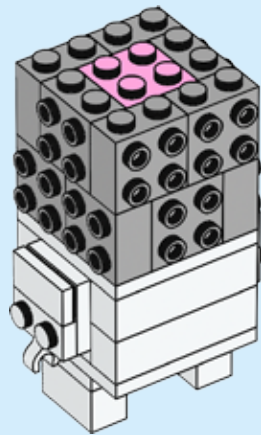

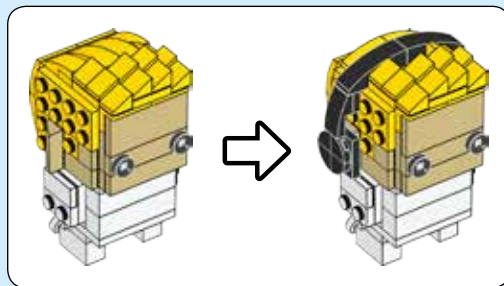
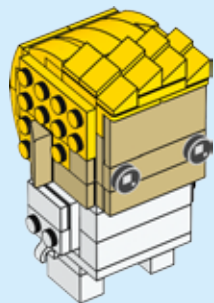
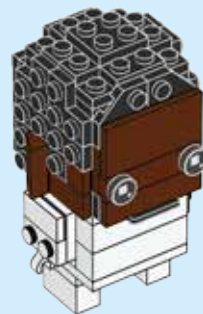
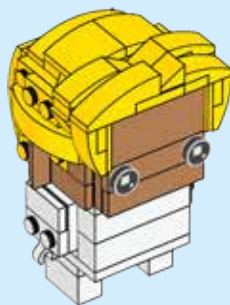
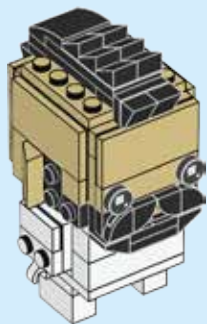
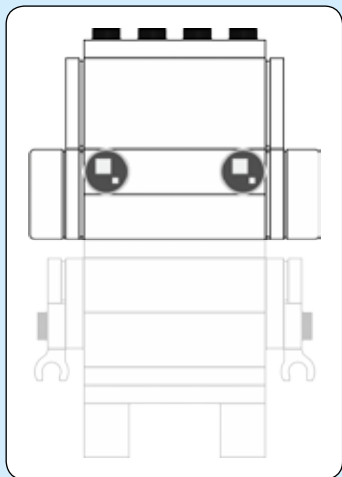

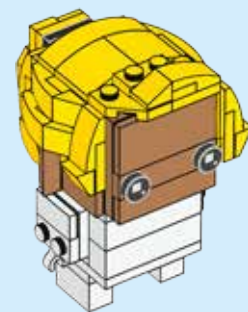
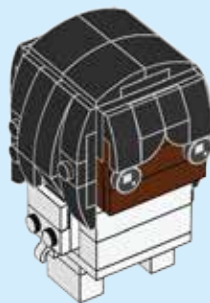
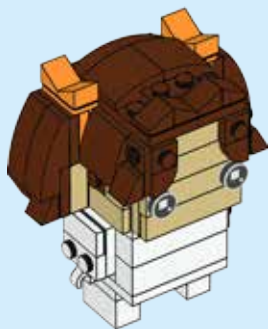
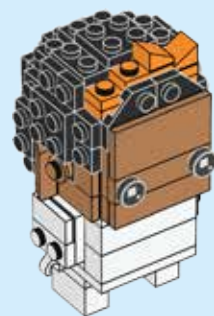
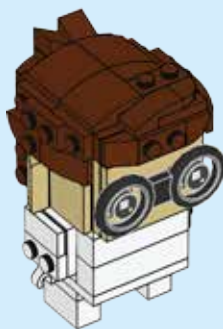
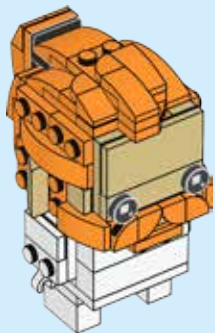
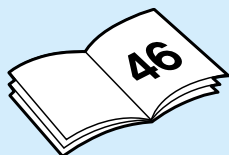
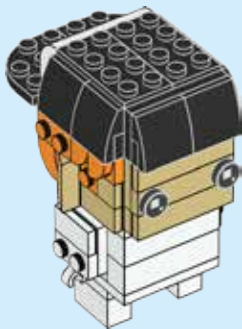



2x

1

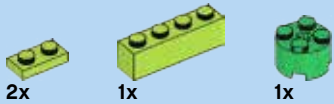
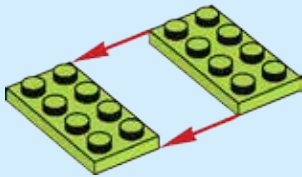

2

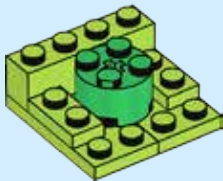

16

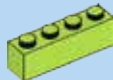

2x



1x



2x

3

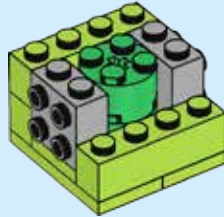

1x



2x

4

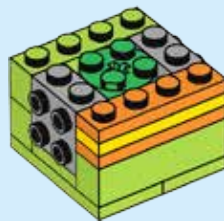
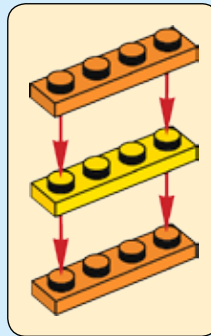

2x

5

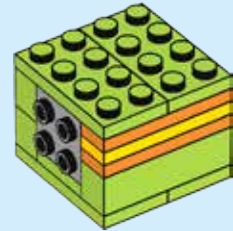

2x



2x

6

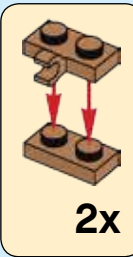

2x

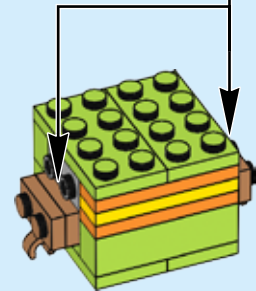



7

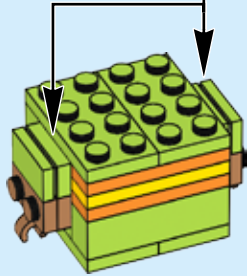
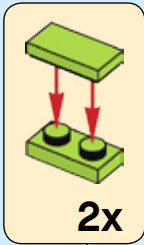

8

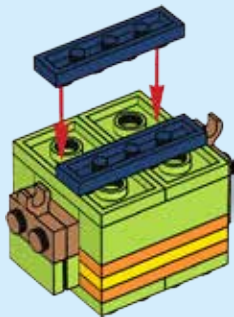
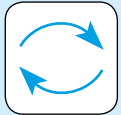

9

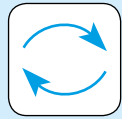
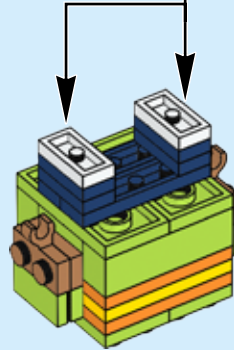
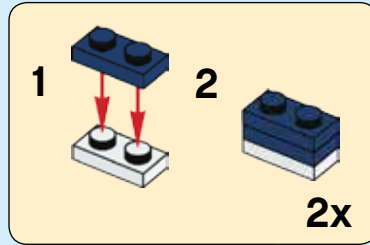

10

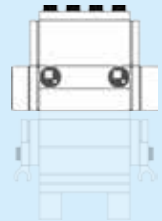
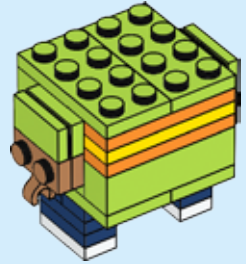

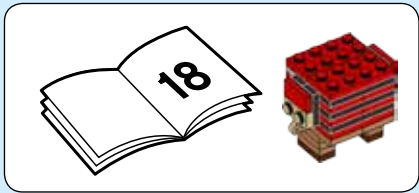

1

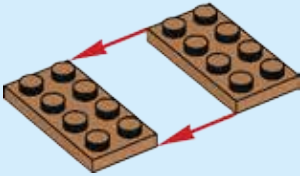

2

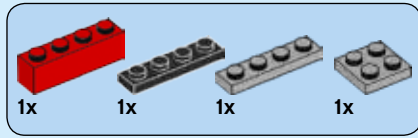

3

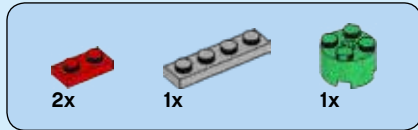
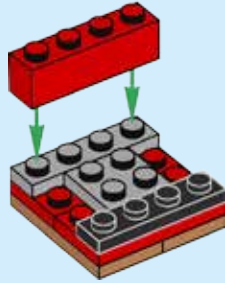

4

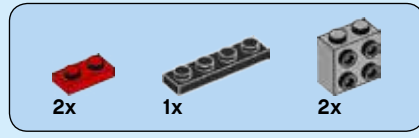
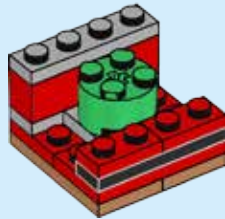

5

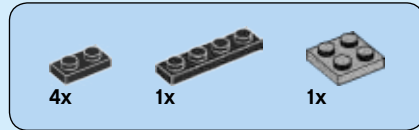
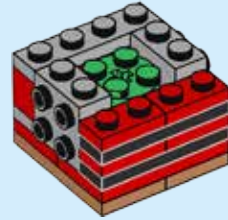
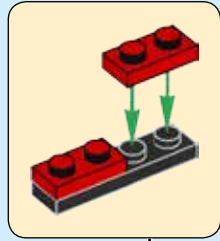

6

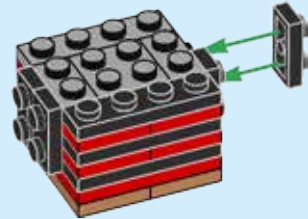

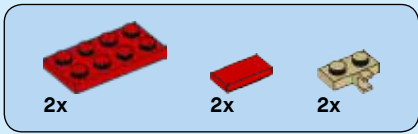

7

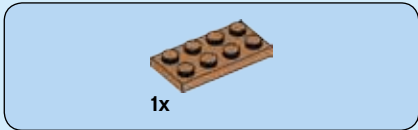
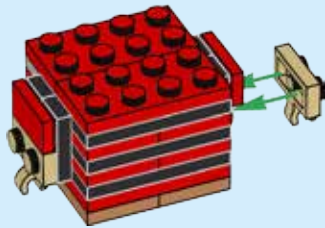

8

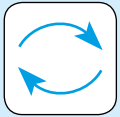

9

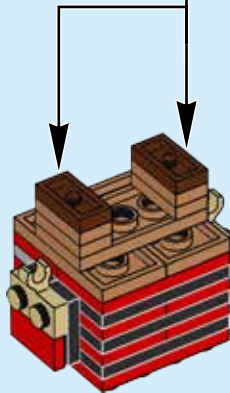
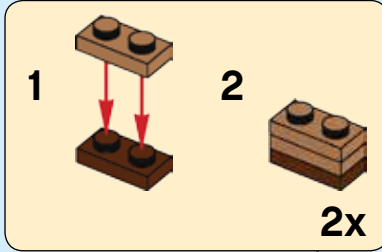

10

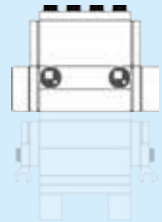
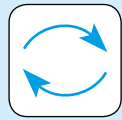

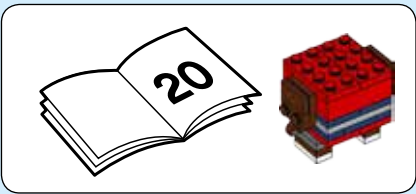

1

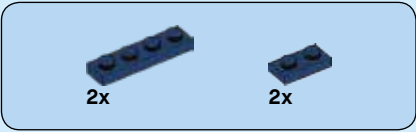
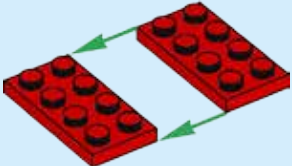

2

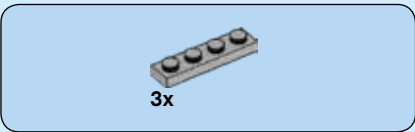
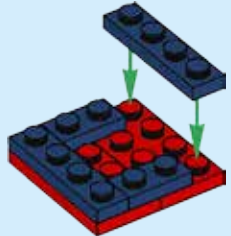

3

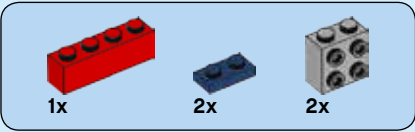
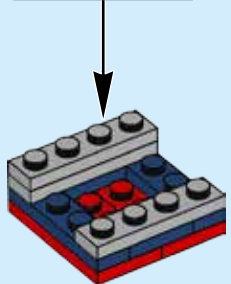
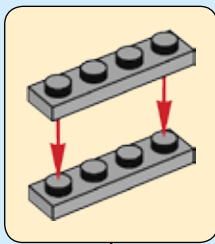

4

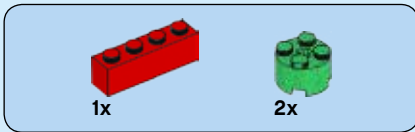
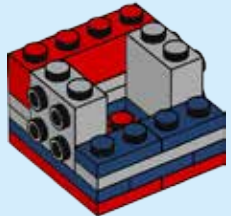

5

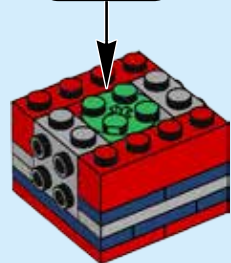
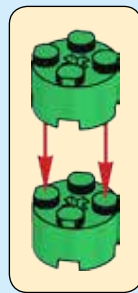

6

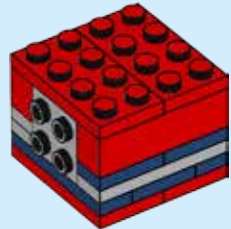



7

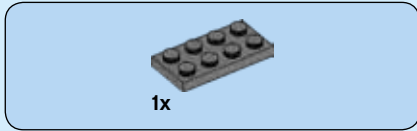
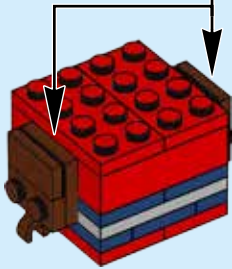

8

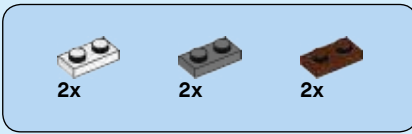
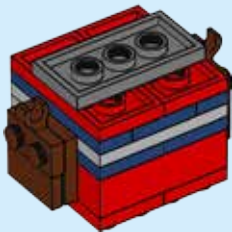
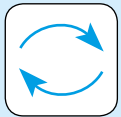

9

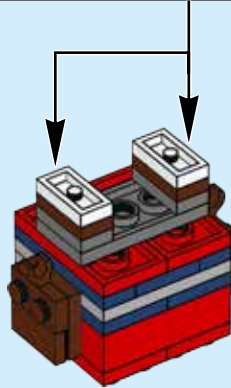
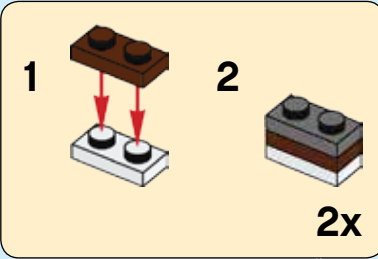

10

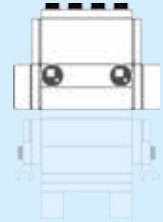
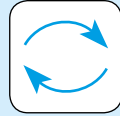



1

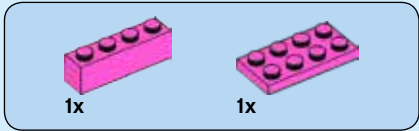
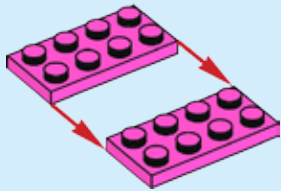

2

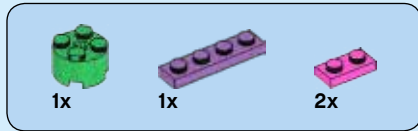
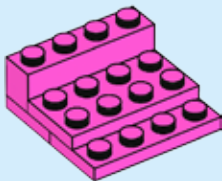

3

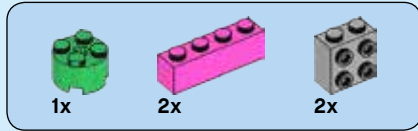
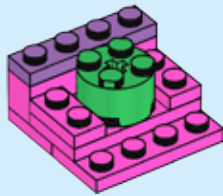

4

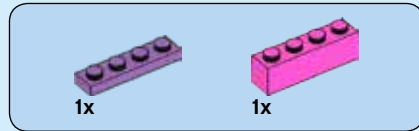
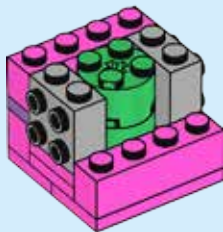

5

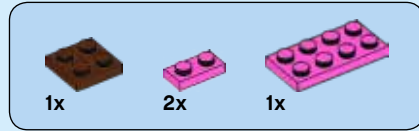
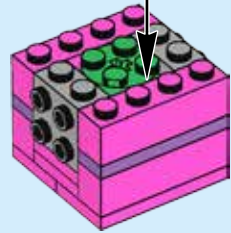
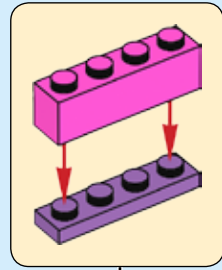

6

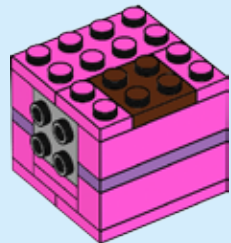

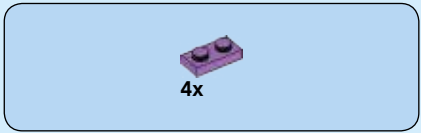

7

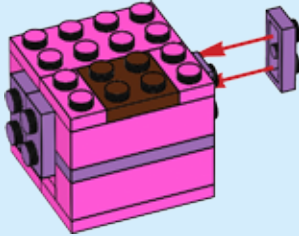

8

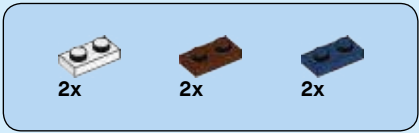
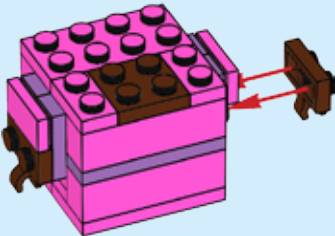

9

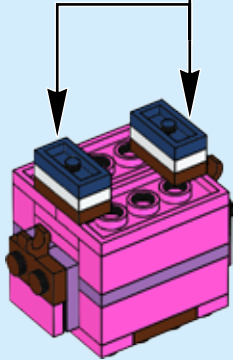
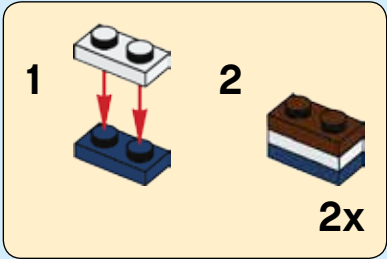
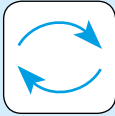

10

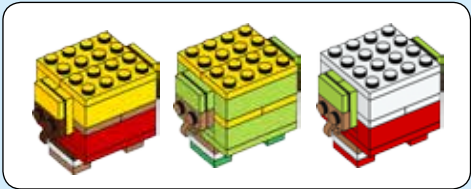
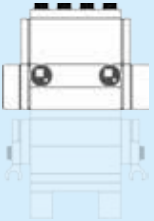
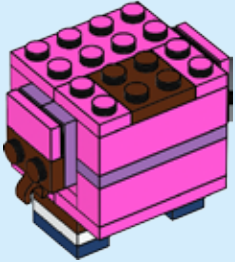
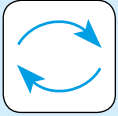



2x

1

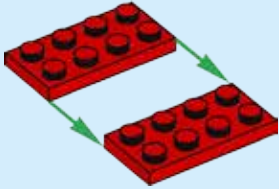

1x

2



2x

3

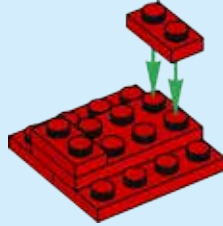

2x

4x

4

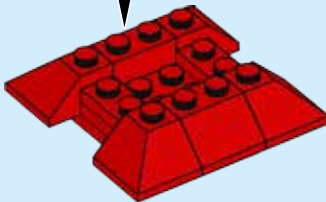
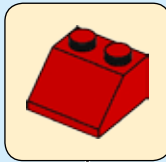

4x

1x

5

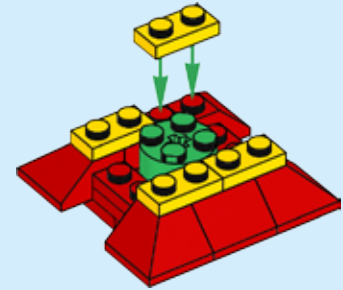

2x

1x

2x

6

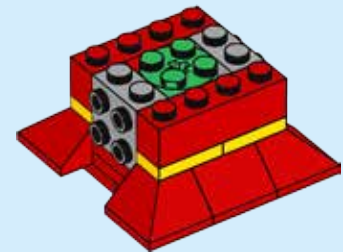



7

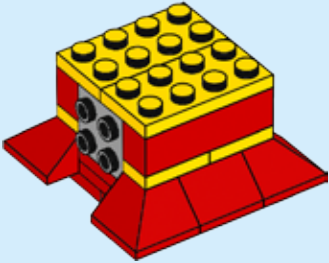

8

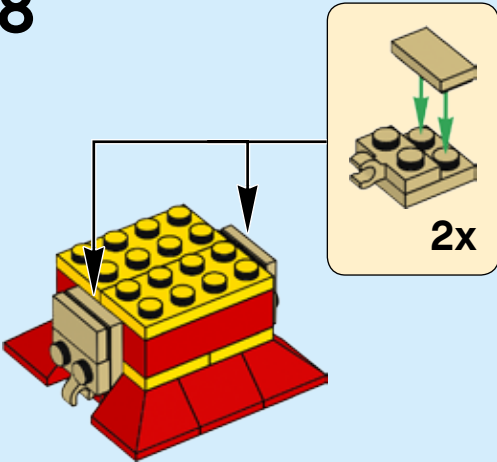

9

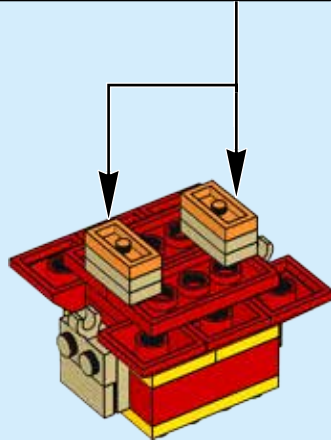
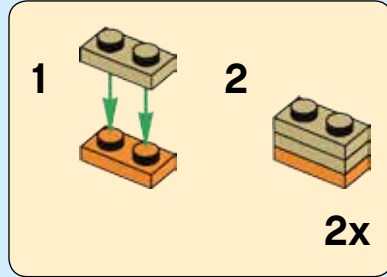
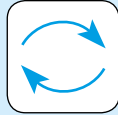

10

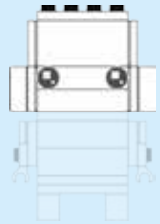
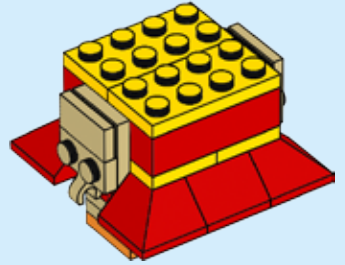
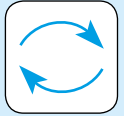

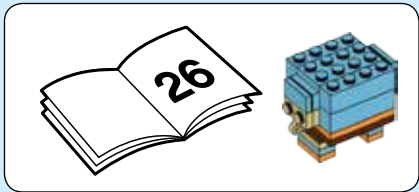

1

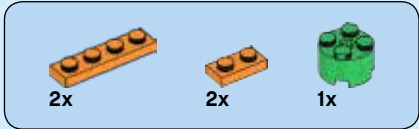
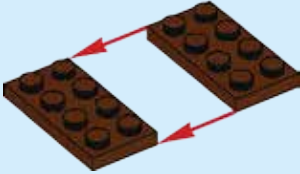

2

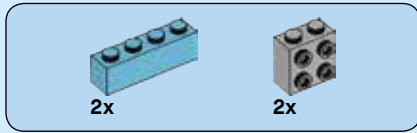
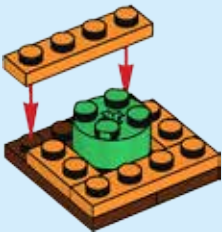

3

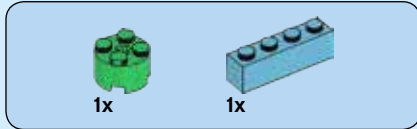
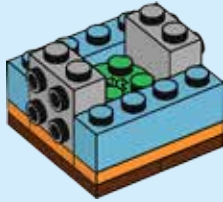

4

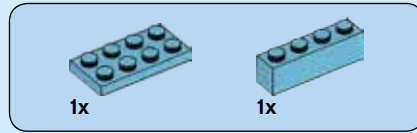
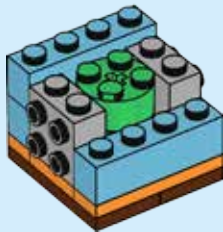

5

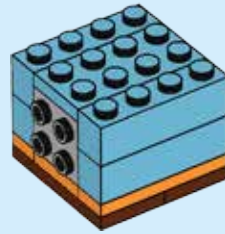

6

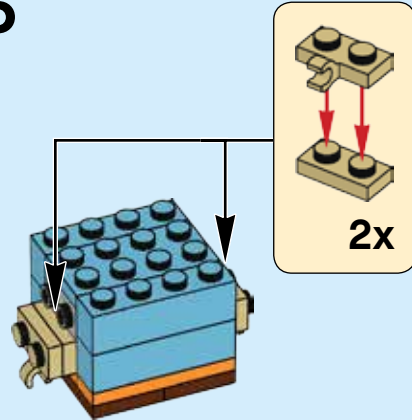

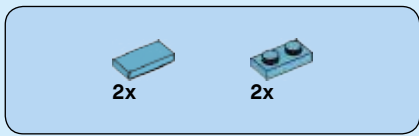

7

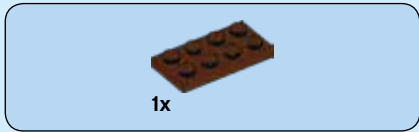
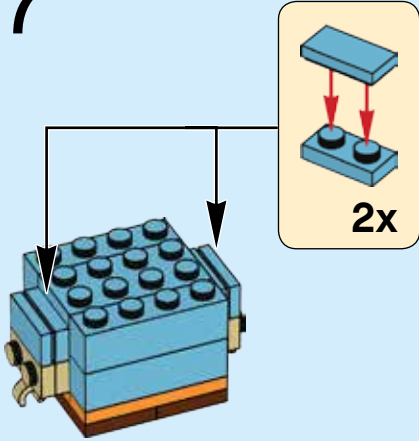

8

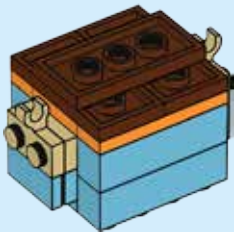
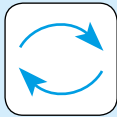

9

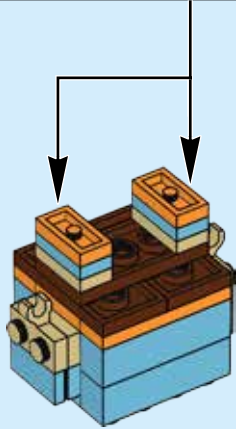
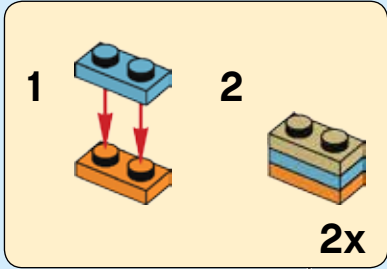

10

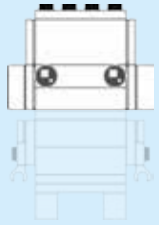
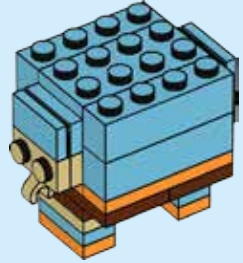
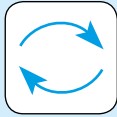

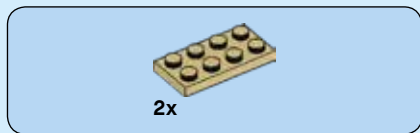

1

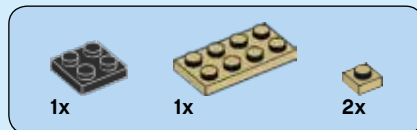
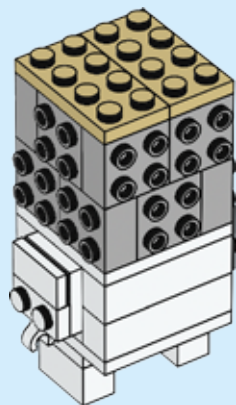

2

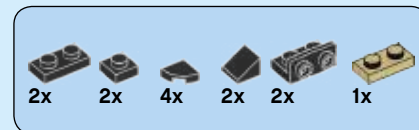
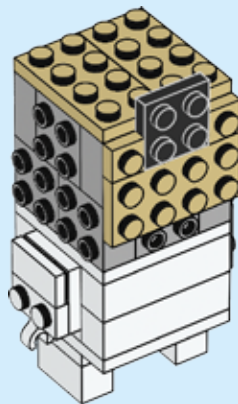

3

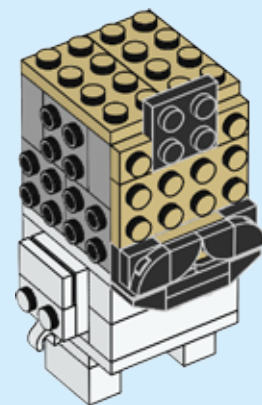
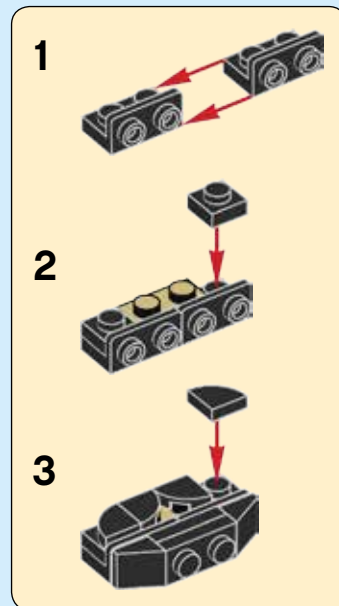

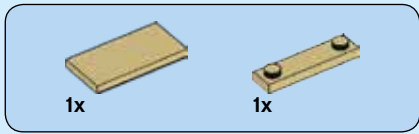

4

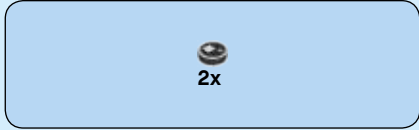
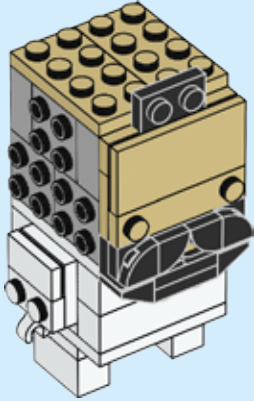

5

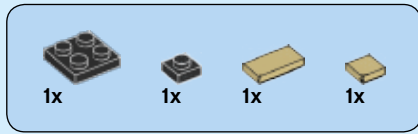
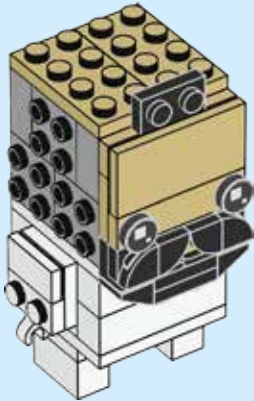

6

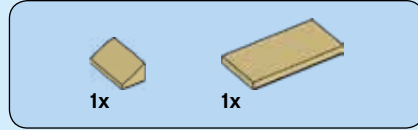
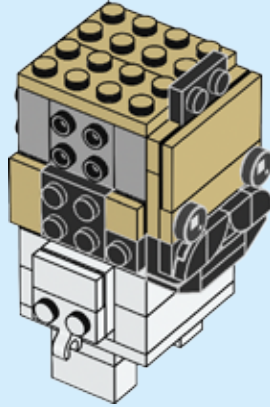

7

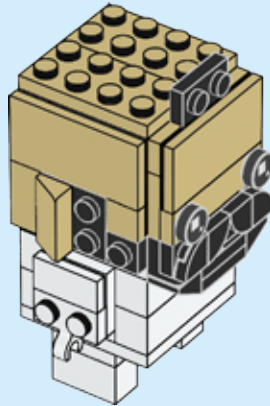

8

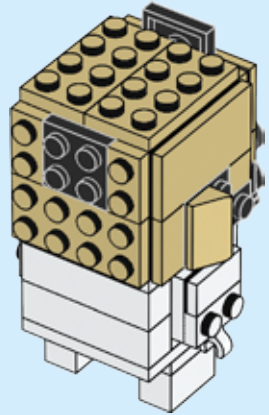
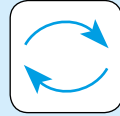

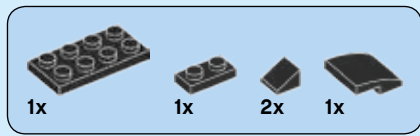

9

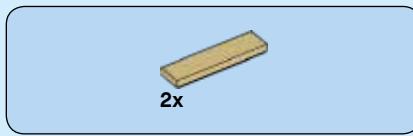
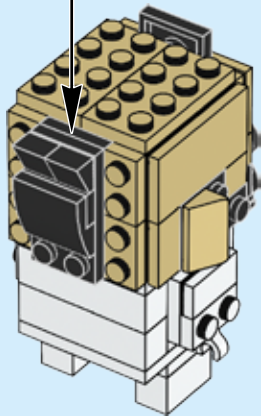
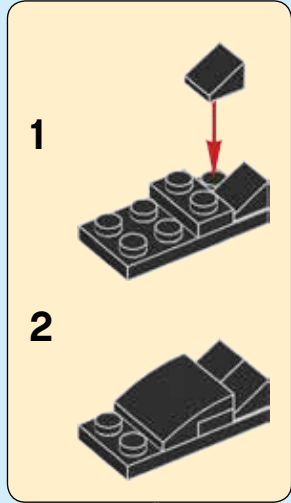

10

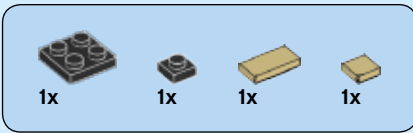
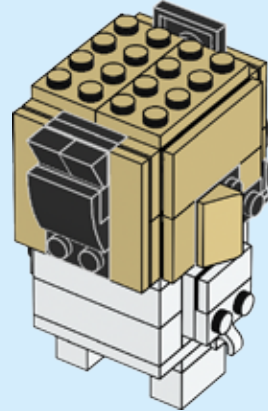

11

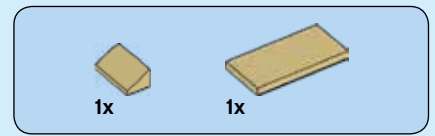
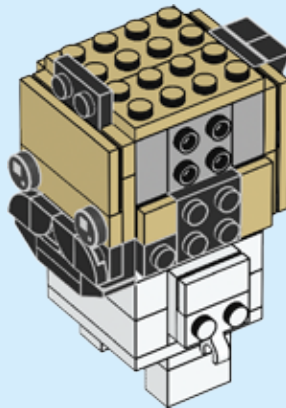
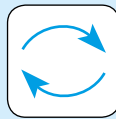

12

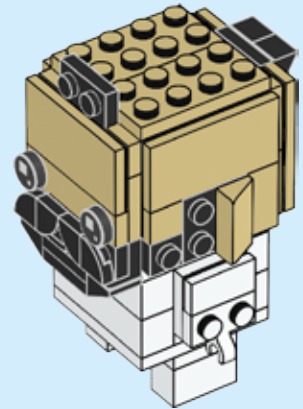

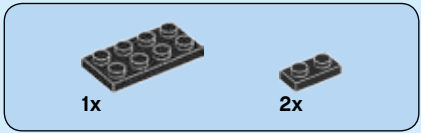

13

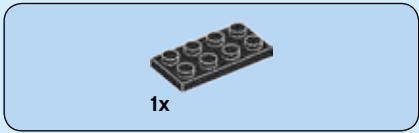
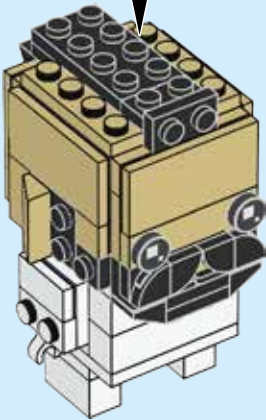
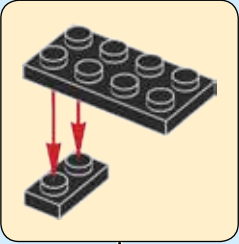

14

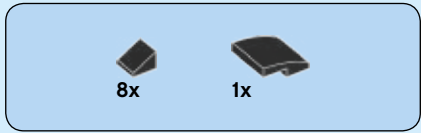
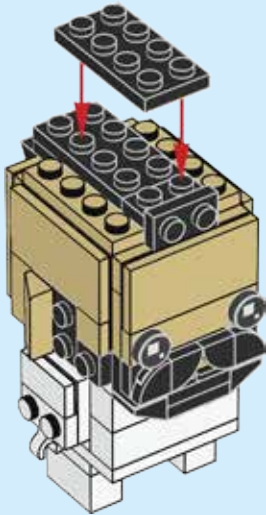

15

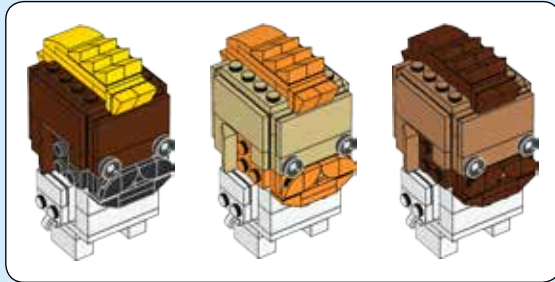
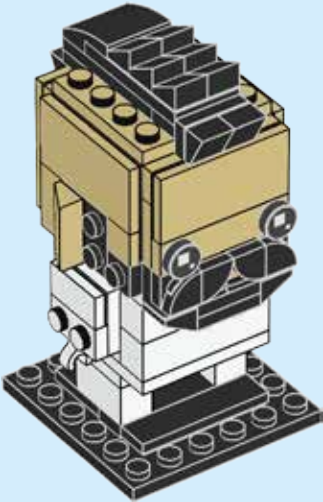



1

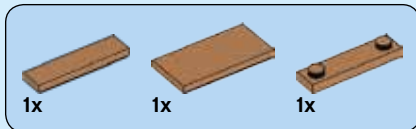
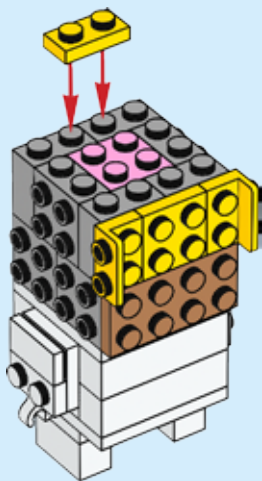

2

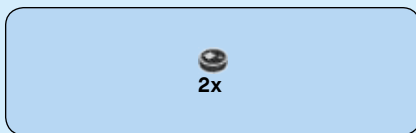
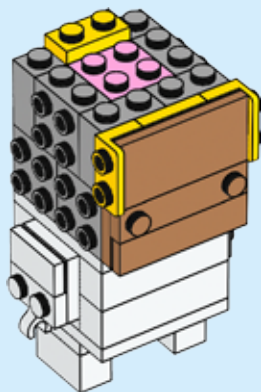

3

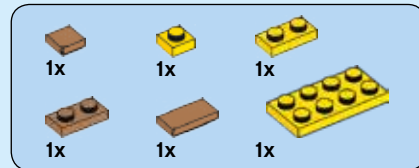
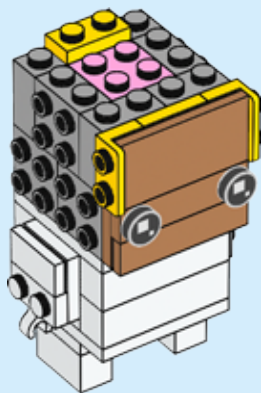

4

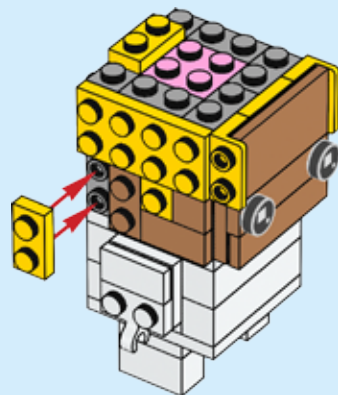



5

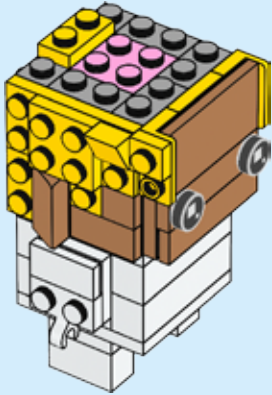

6

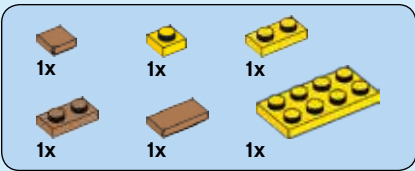
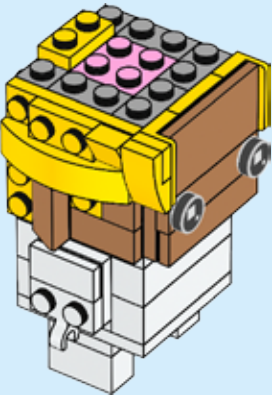

7

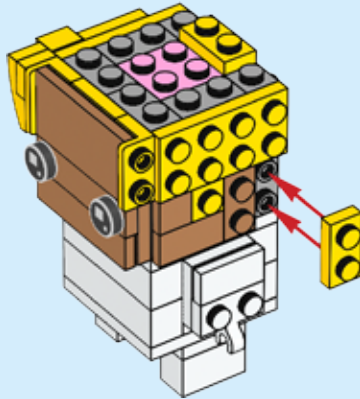
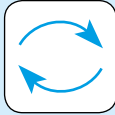

8

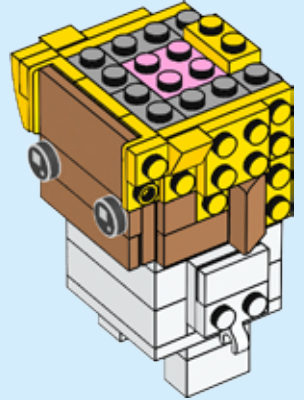

9

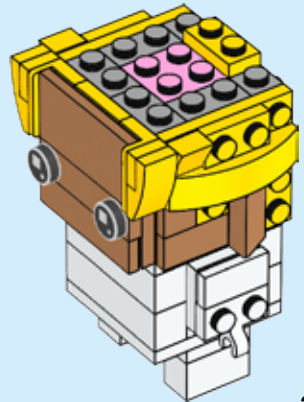



2x

10

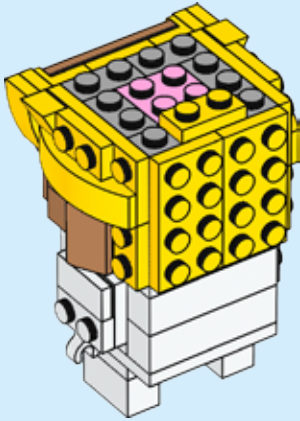
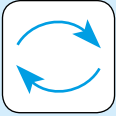

1x

11

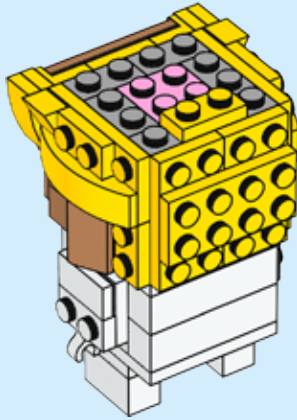

4x

12

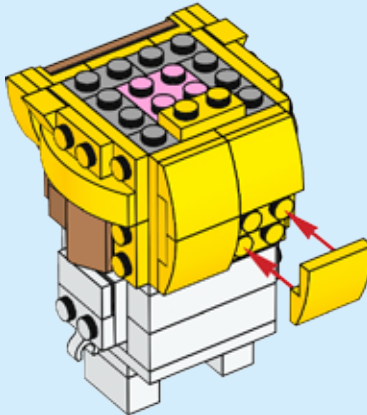

1x



1x



1x



1x



1x

13

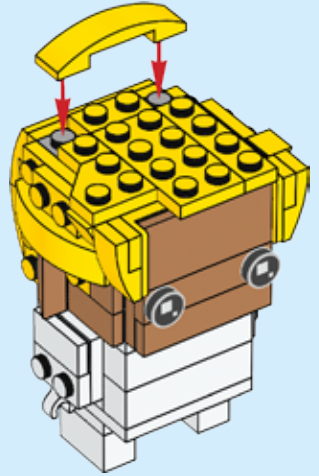
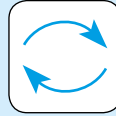



1x



2x



2x

14

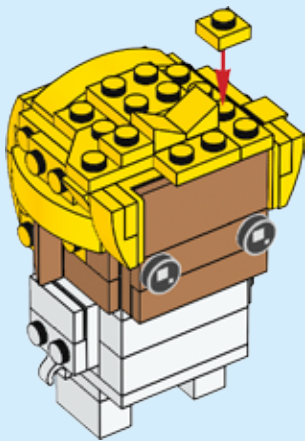

1x



2x

15

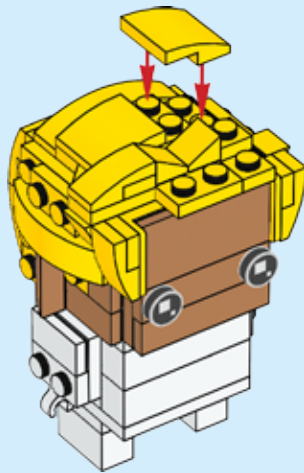

1x



1x



1x



2x

16

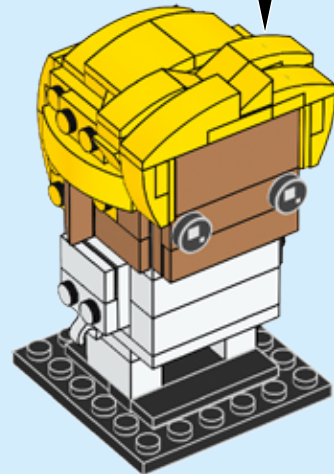
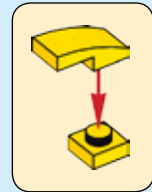



1

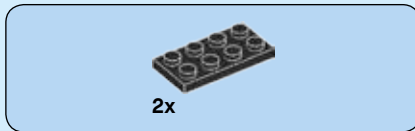
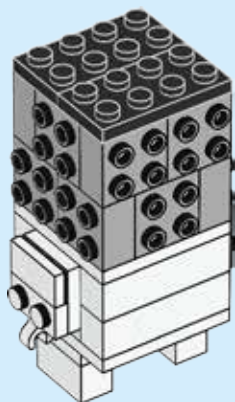

2

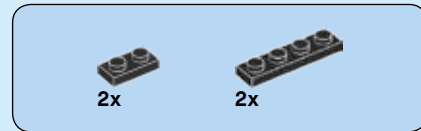
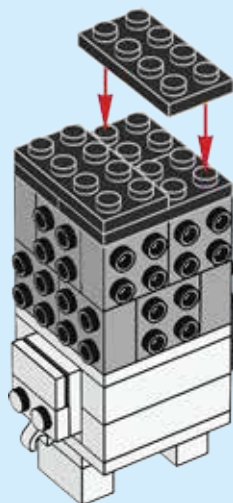

3

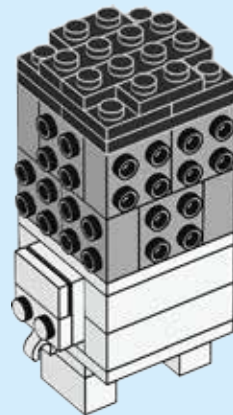

4

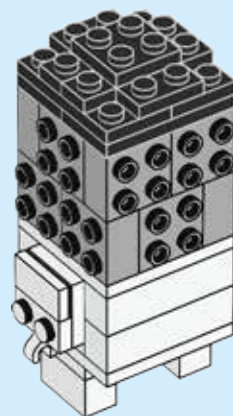

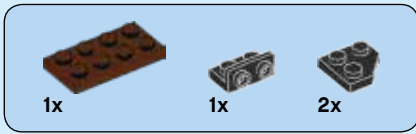

5

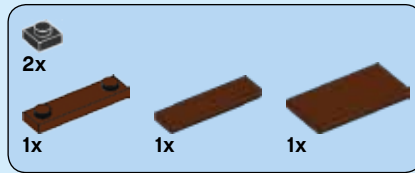
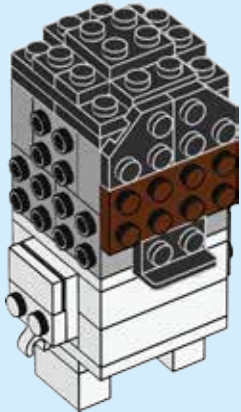

6

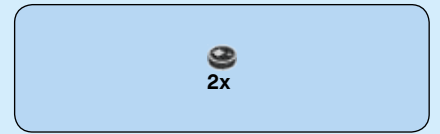
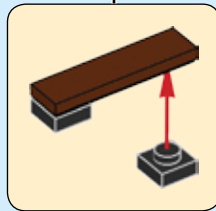
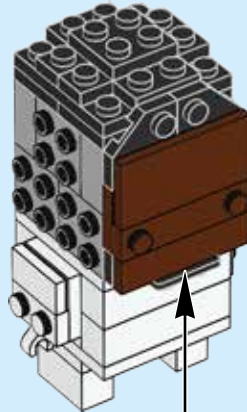

7

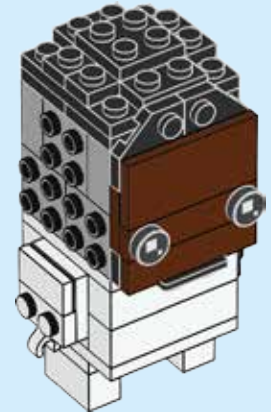

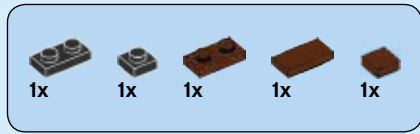

8

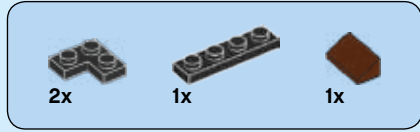
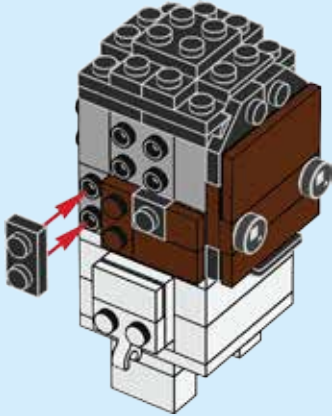

9

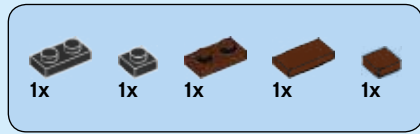
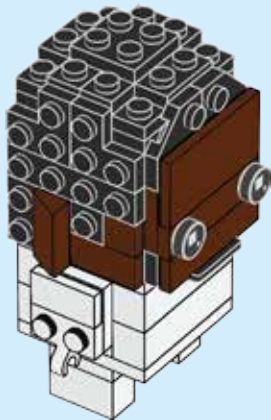

10

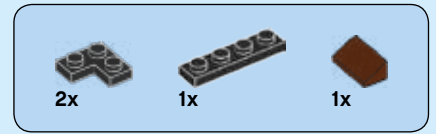
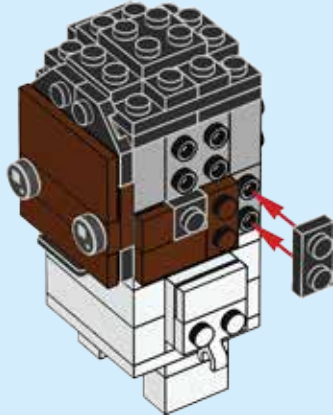
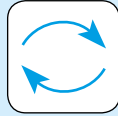

11

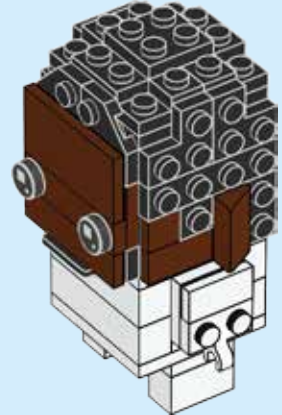



12

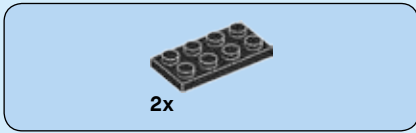
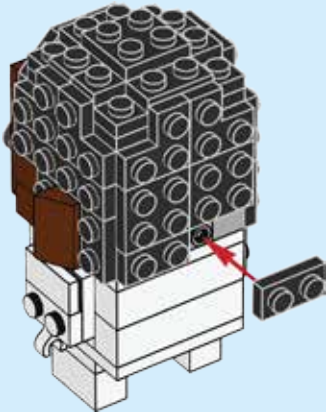
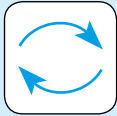

13

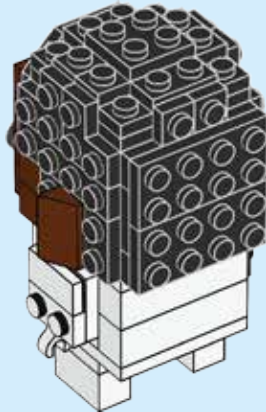

14

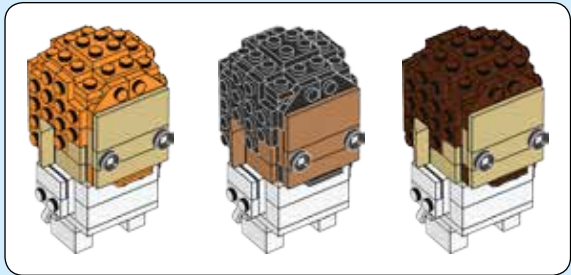
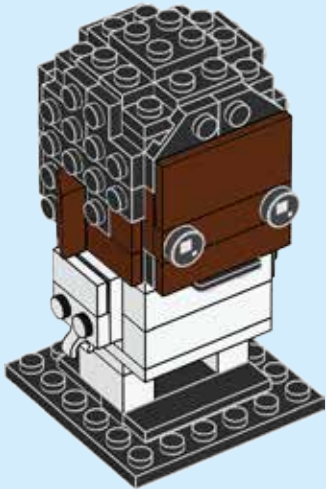



1

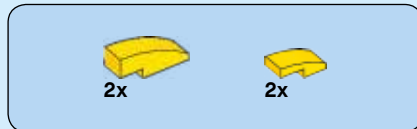
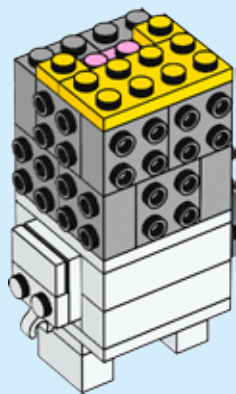

2

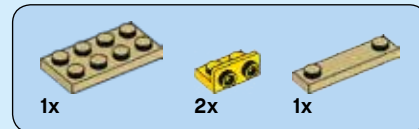
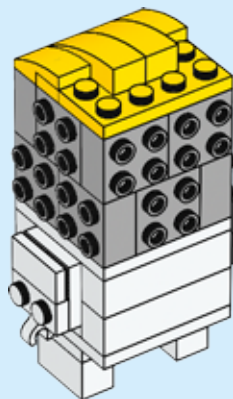

3

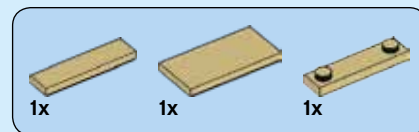
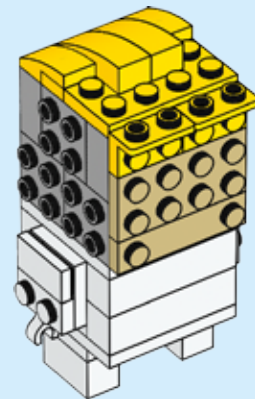

4

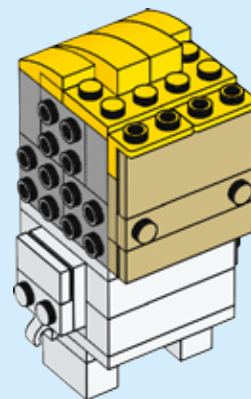

2x

5

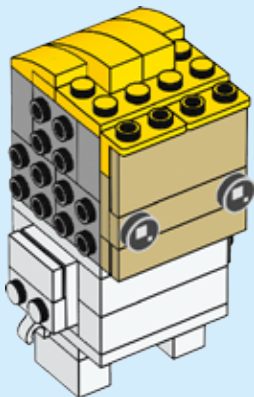

2x

6

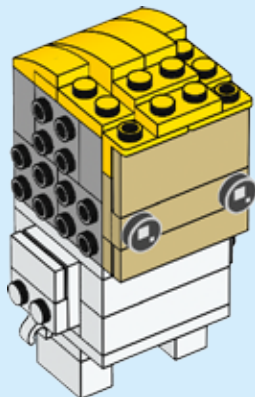

10x

7

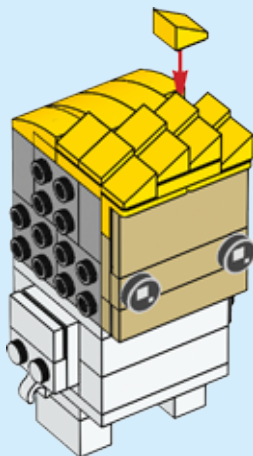

1x

1x

1x

1x

8

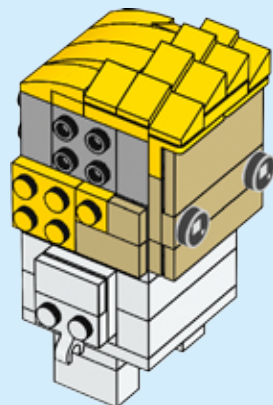

1x

1x

9

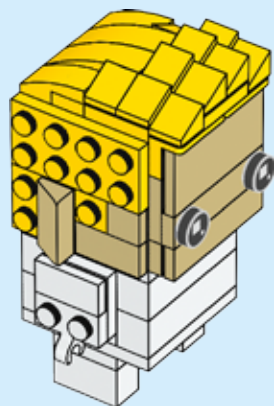

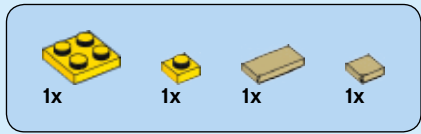

10

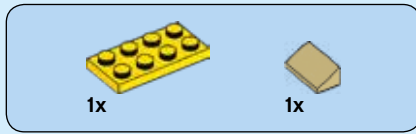
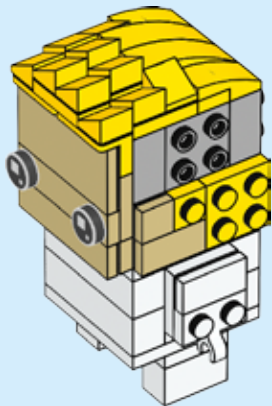
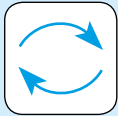

11

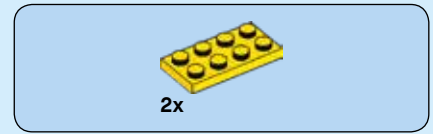
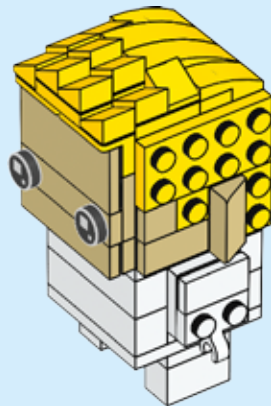

12

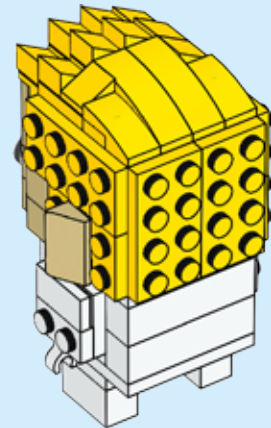
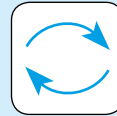



1x

13

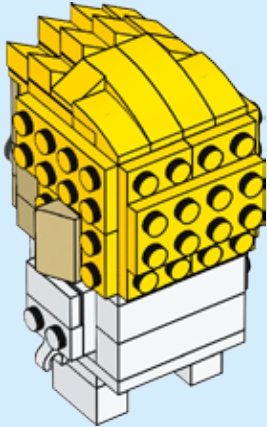

4x

14

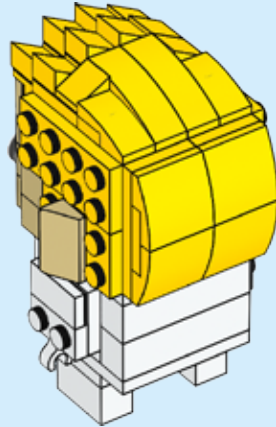

15

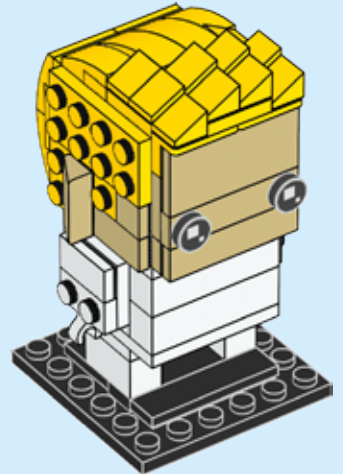
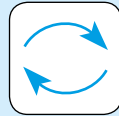

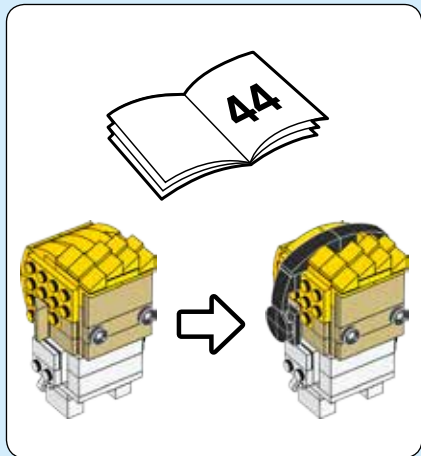

1

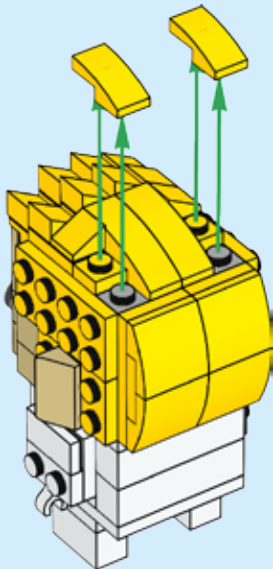

2

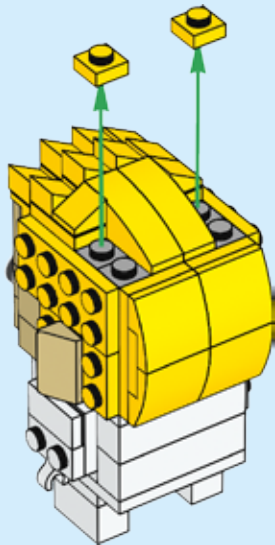

3

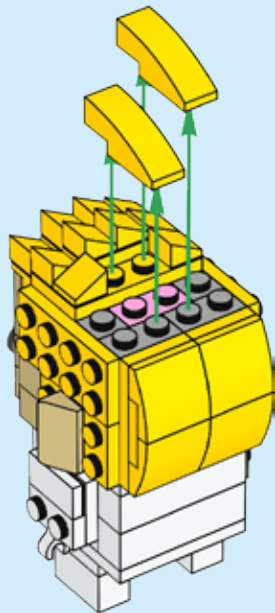

4

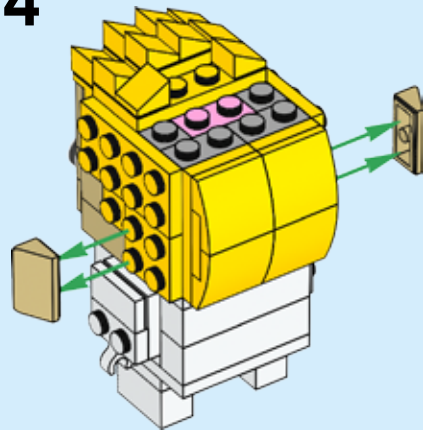

5

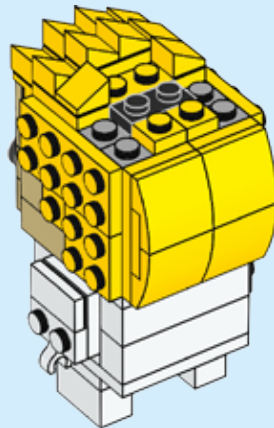

2x



2x

6

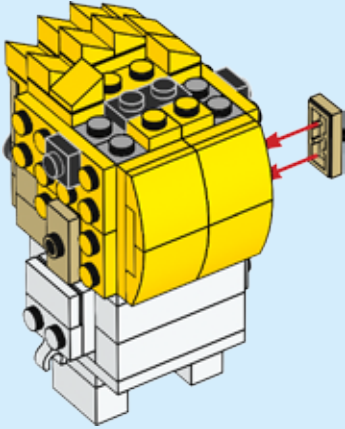

2x



2x



2x



7

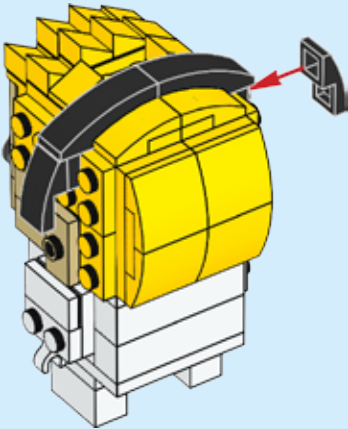

2x



8x



8

1



2



2x

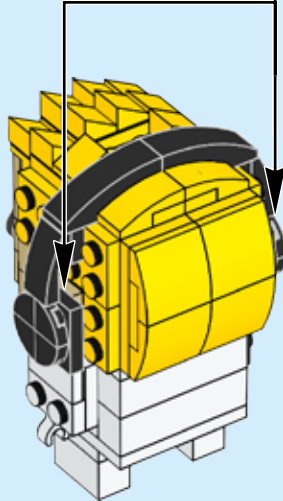

9

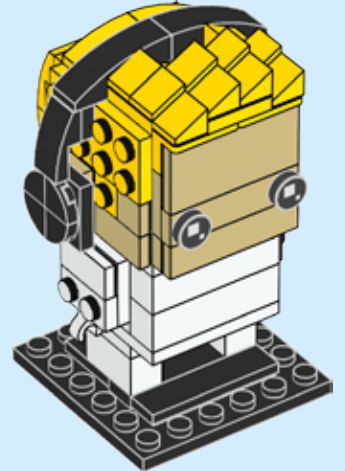
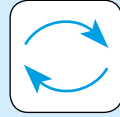



1

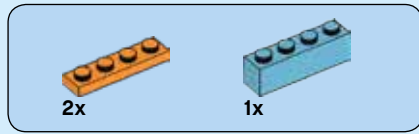
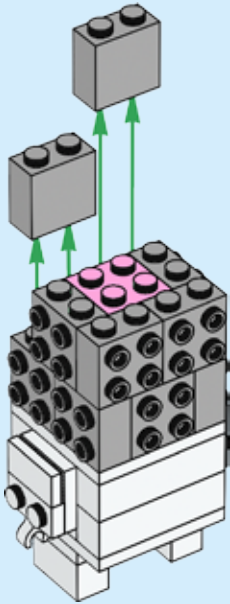

2

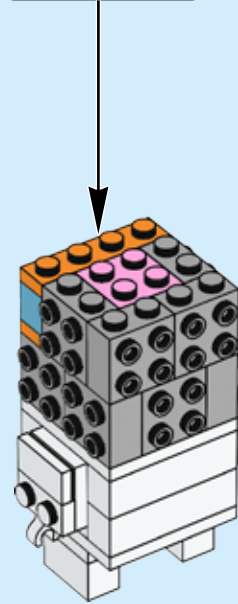
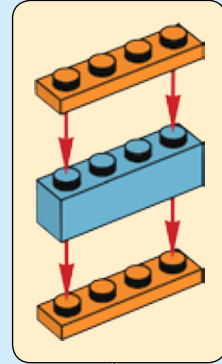

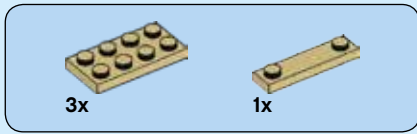

3

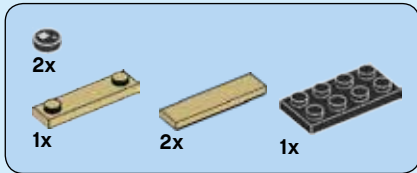
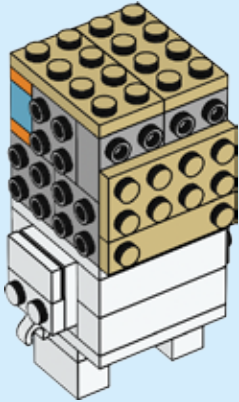

4

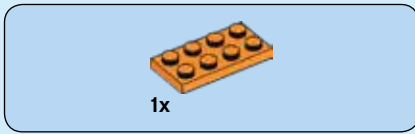
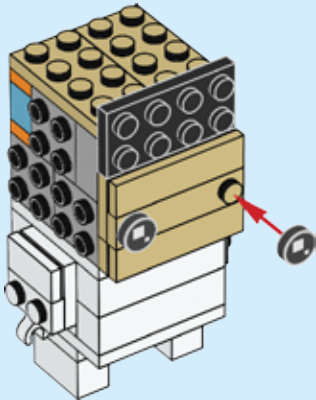

5

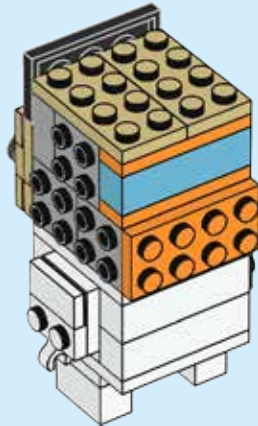
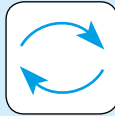

6

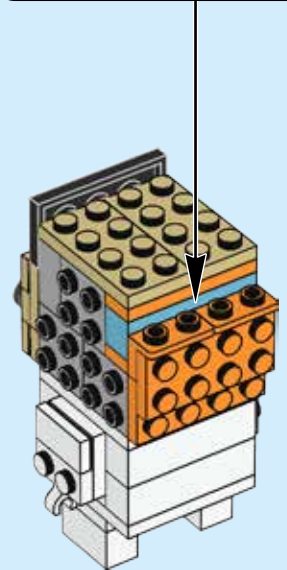
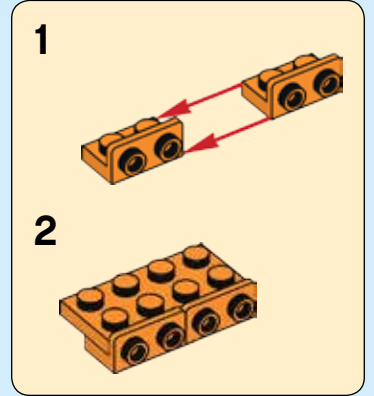

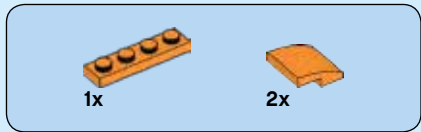

7

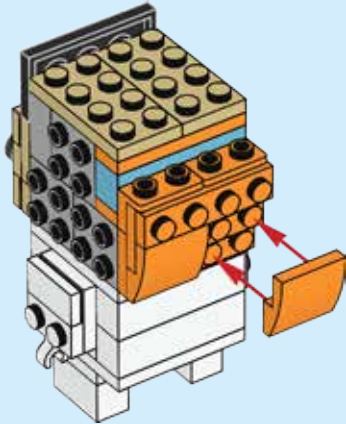

8

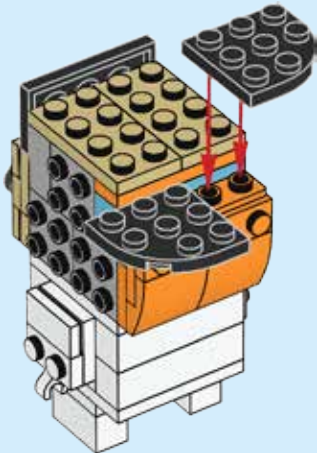

9

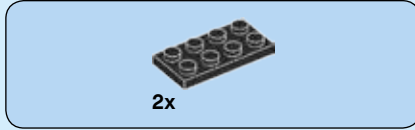
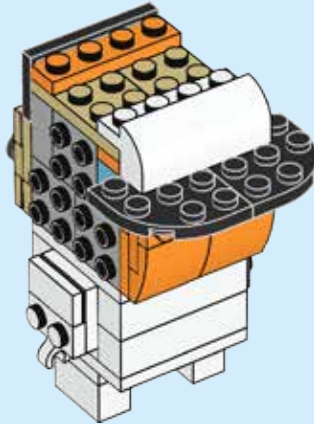

10

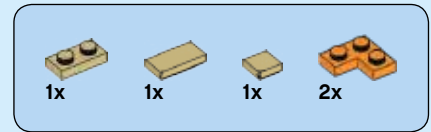
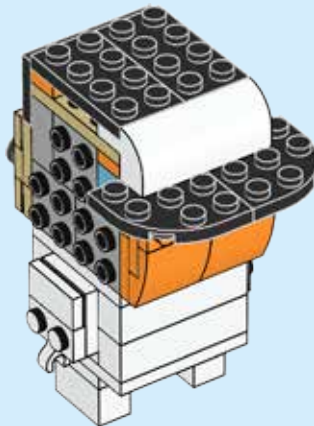

11

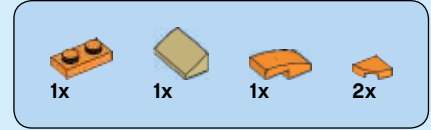
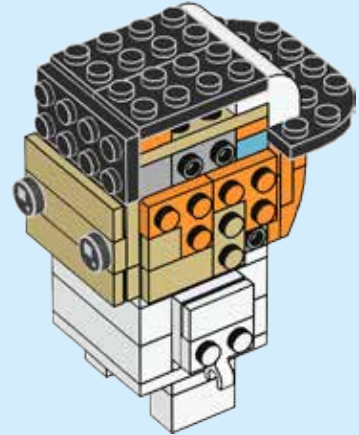

12

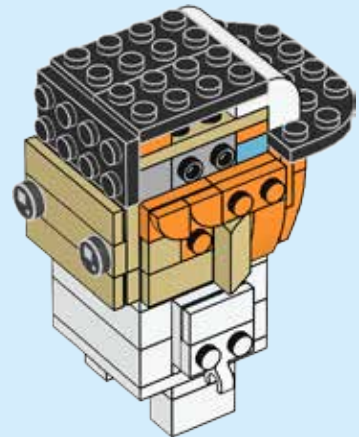

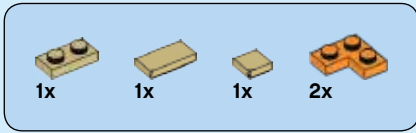

13

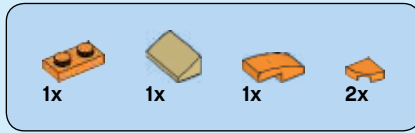
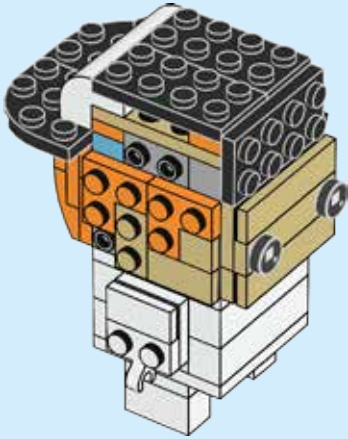
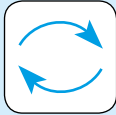

14

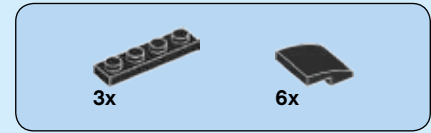
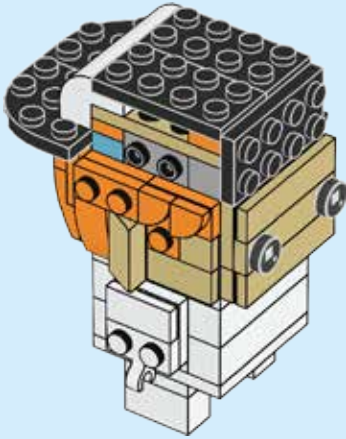

15

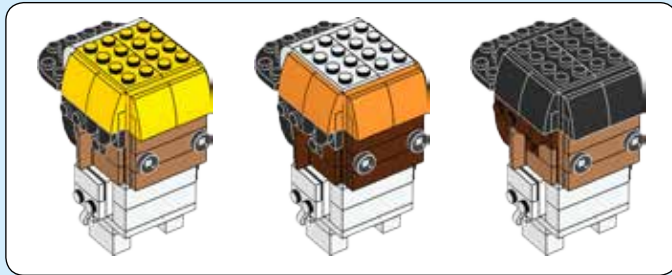
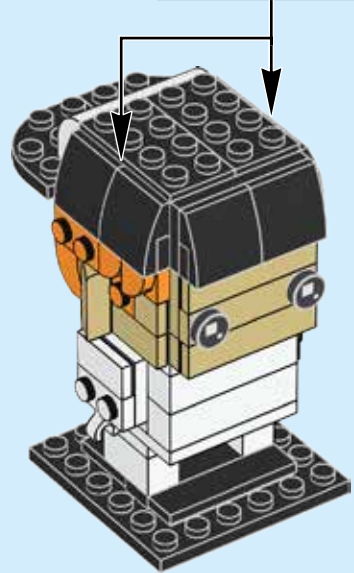
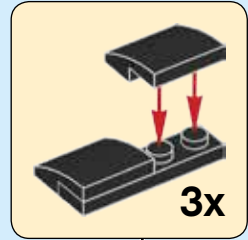



1

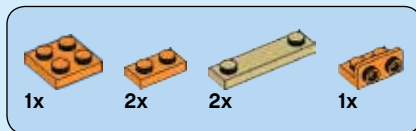
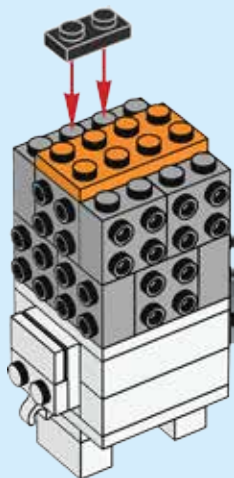

2

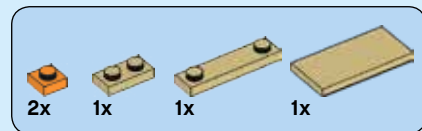
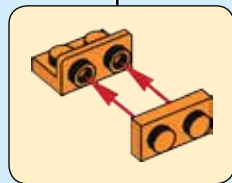
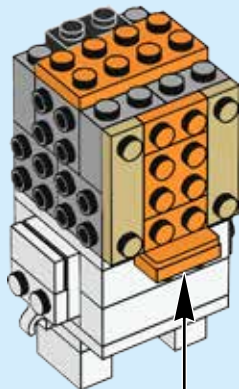

3

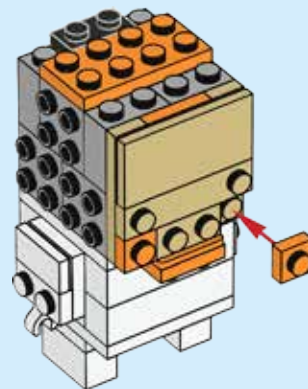

4

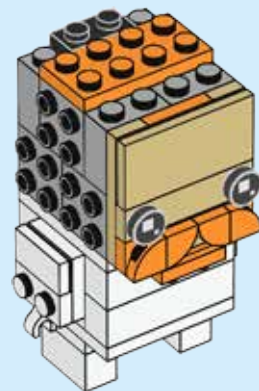

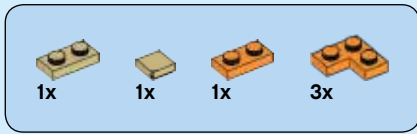

5

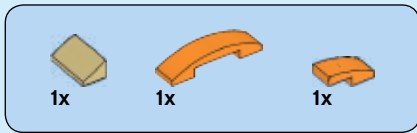
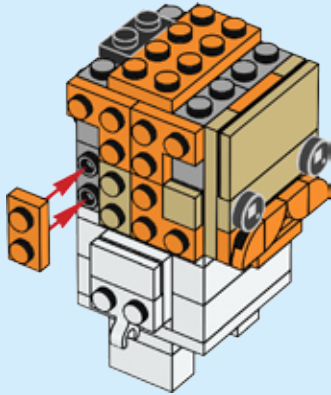

6

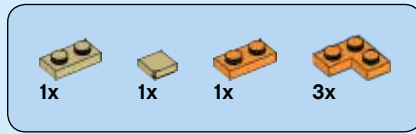
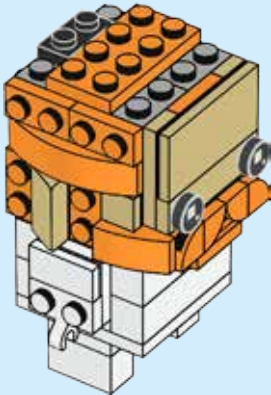

7

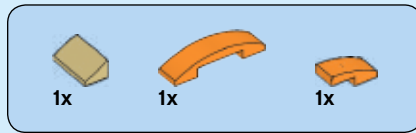
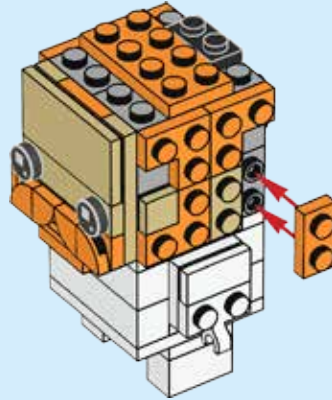
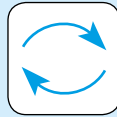

8

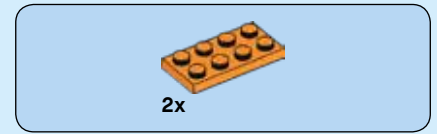
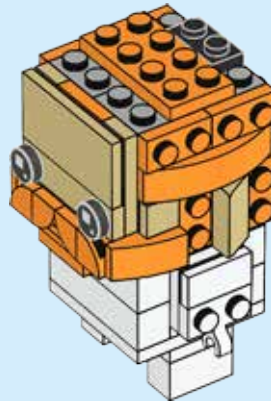

9

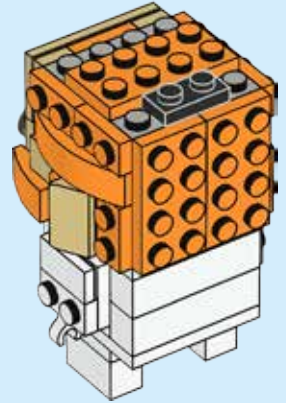
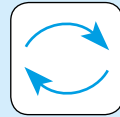

10

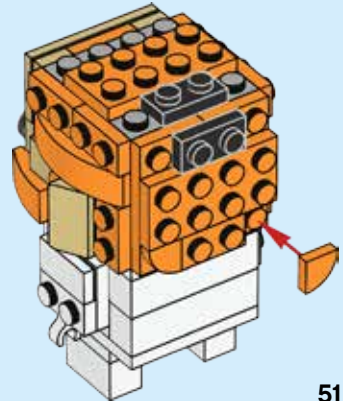

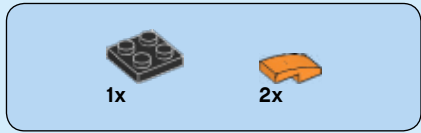

11

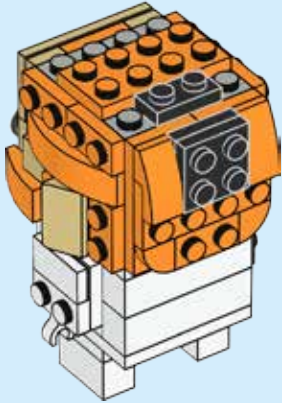

12

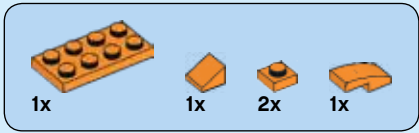
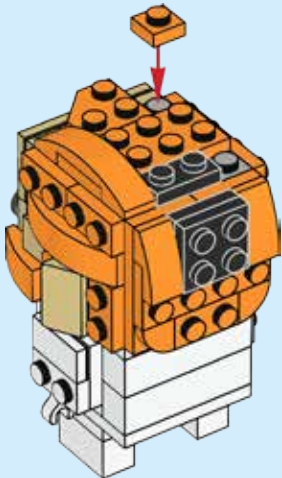

13

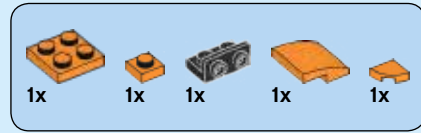
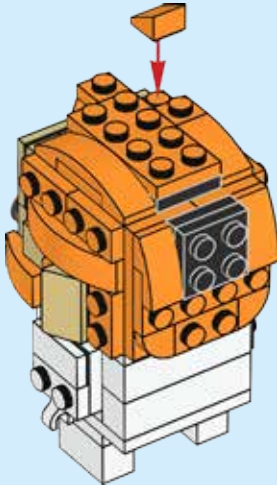

14

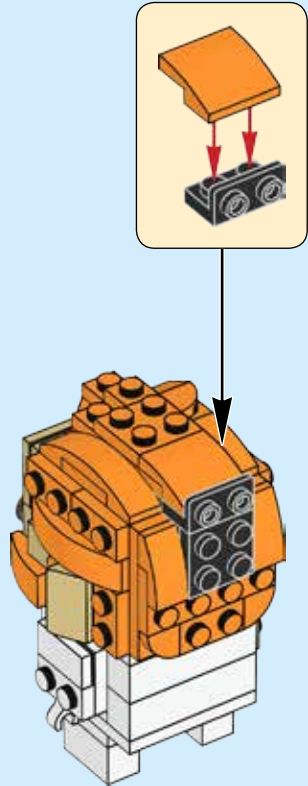



2x



1x

15

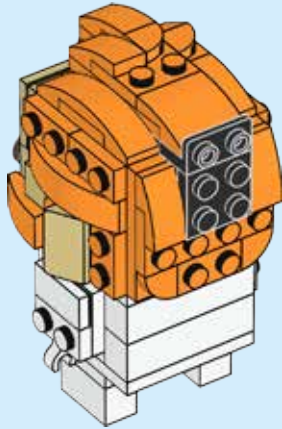

1x

16

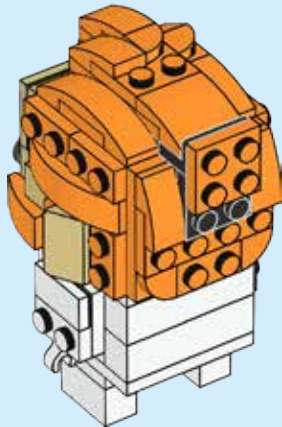

2x



2x

17

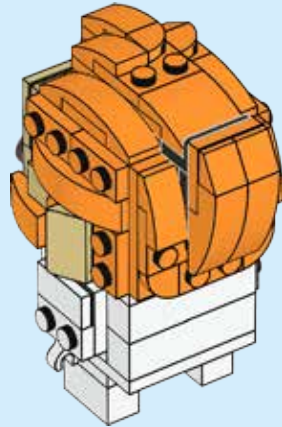

18

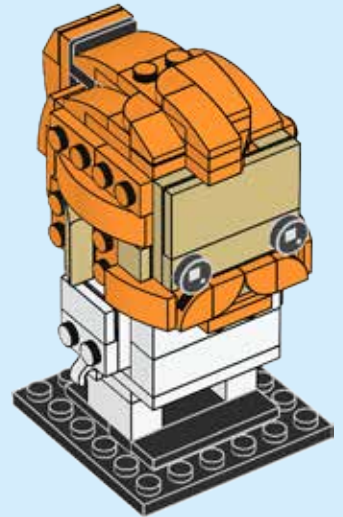
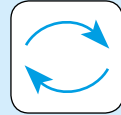

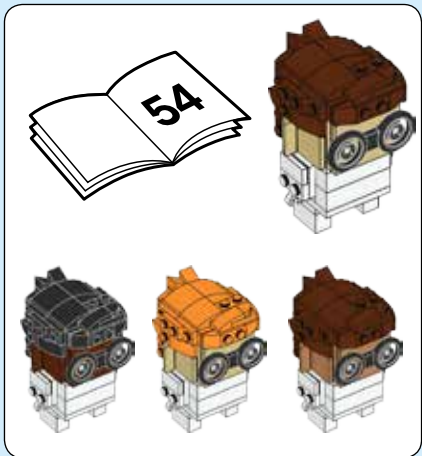

1

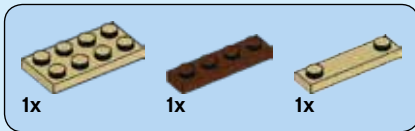
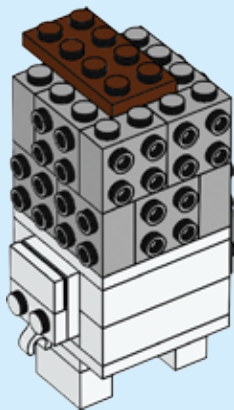

2

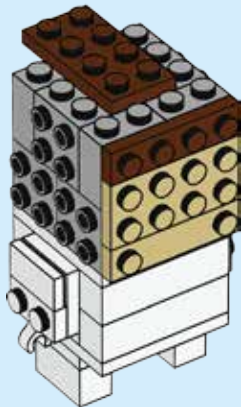

3

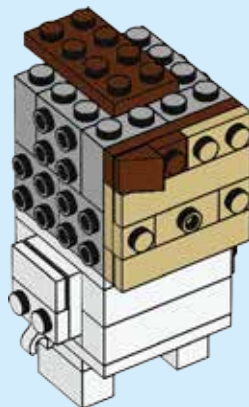

4

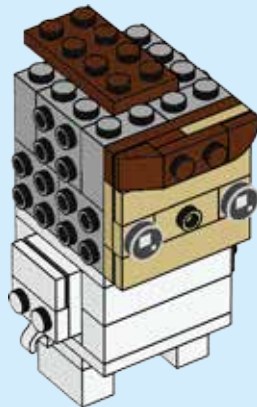

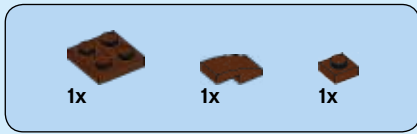

5

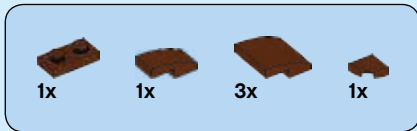
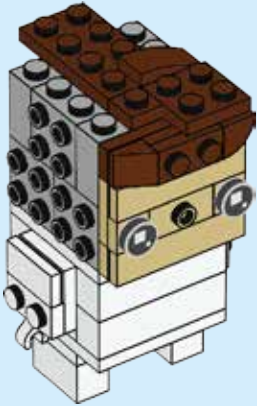

6

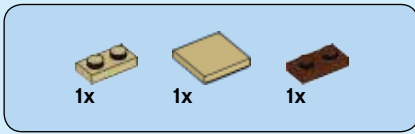
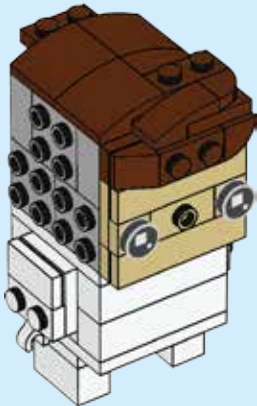

7

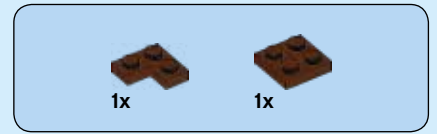
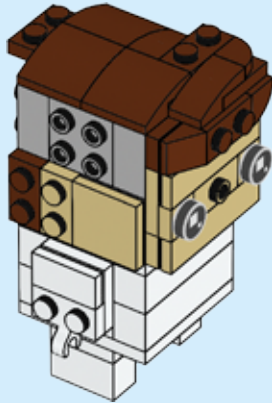

8

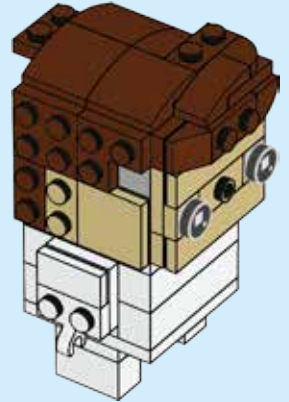

9

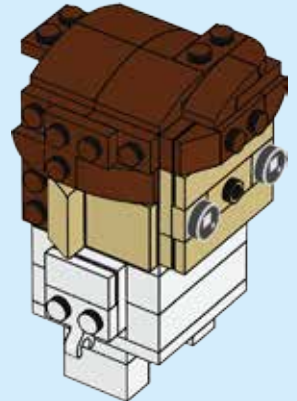

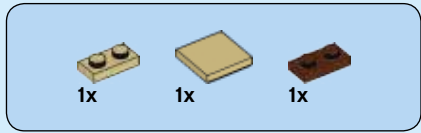

10

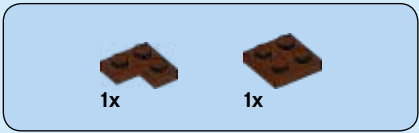
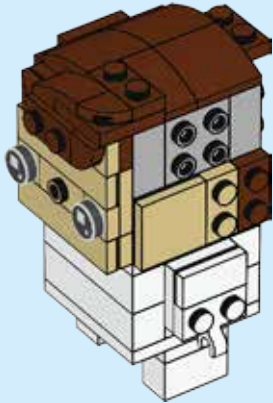

11

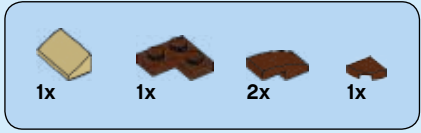
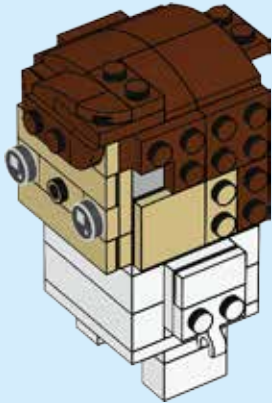

12

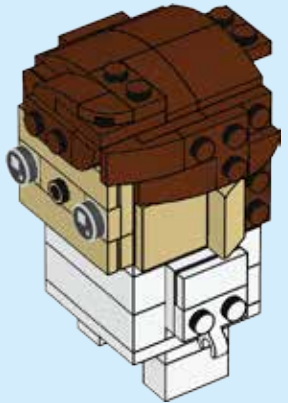



13

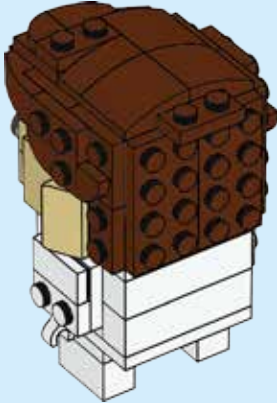

14

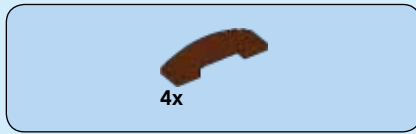
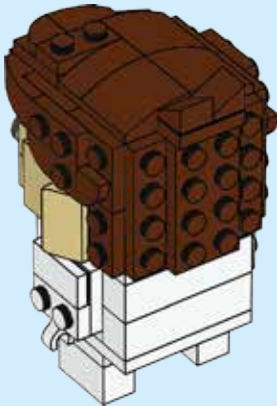

15

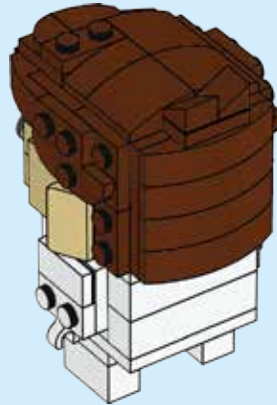

16

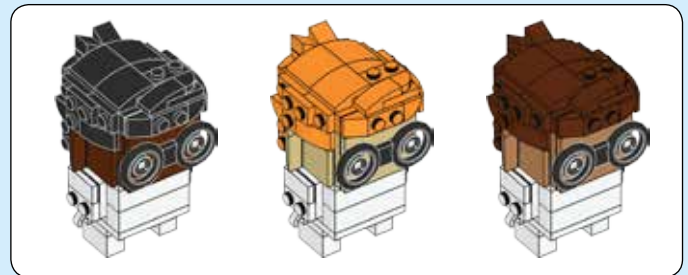
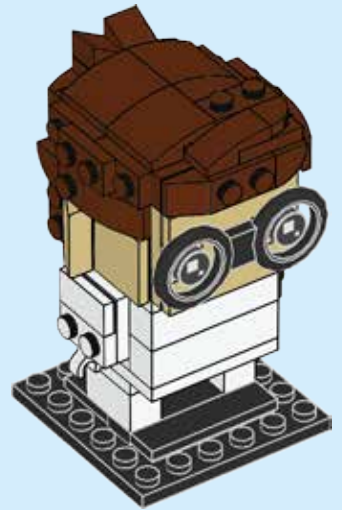
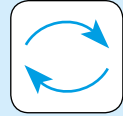

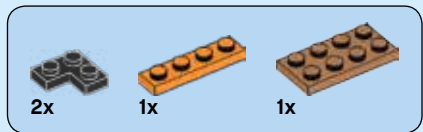

1

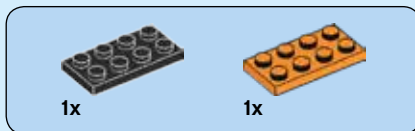
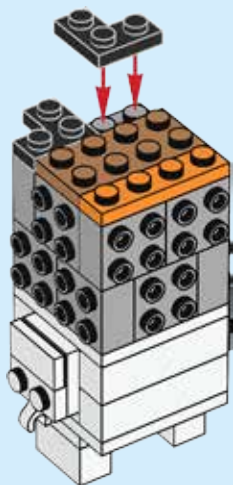

2

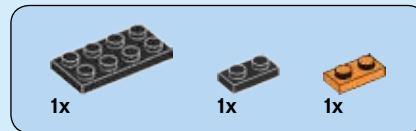
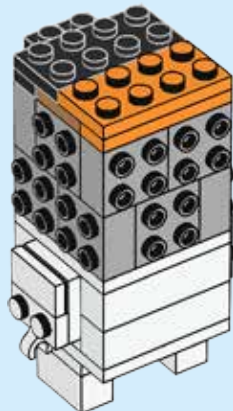

3

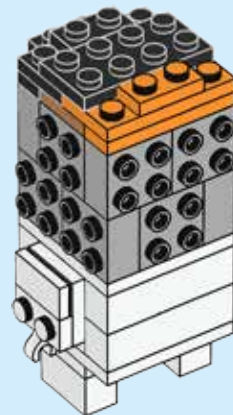

4

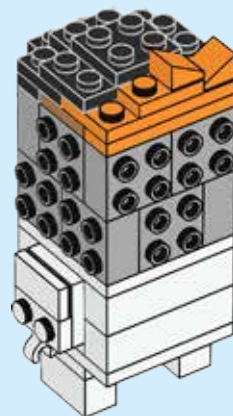

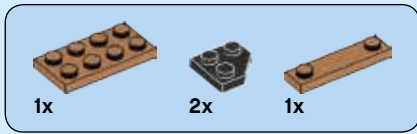

5

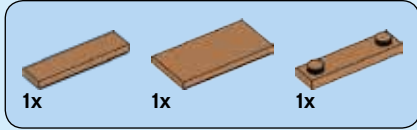
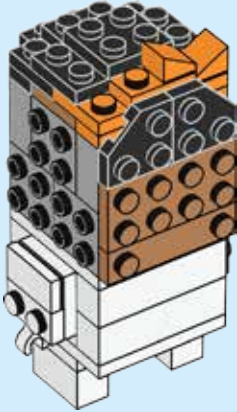

6

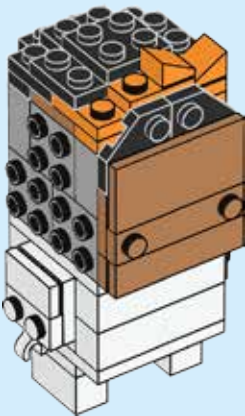

7

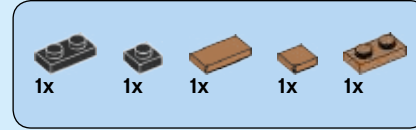
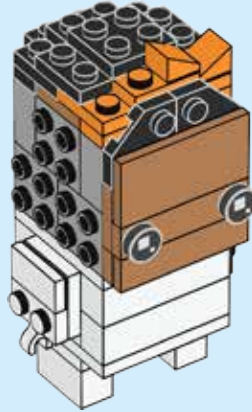

8

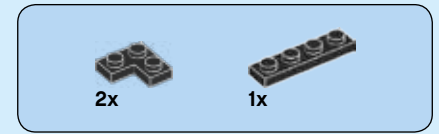
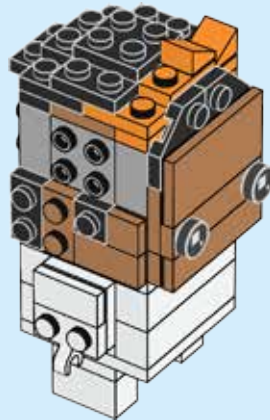

9

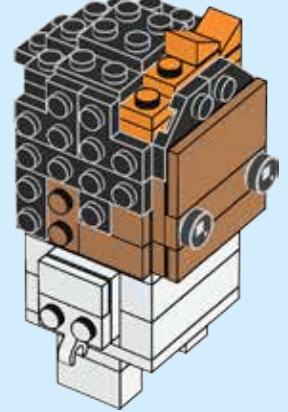

10

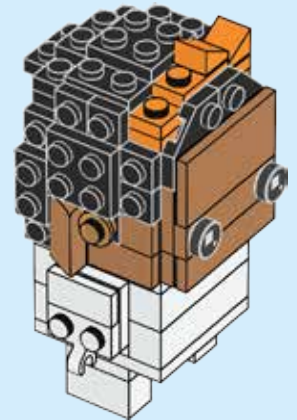

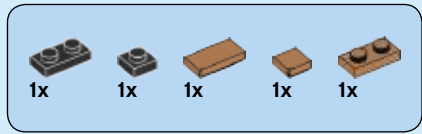

11

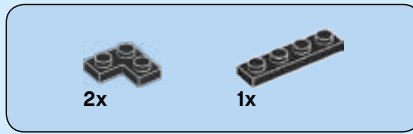
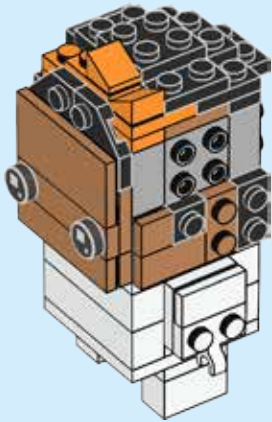
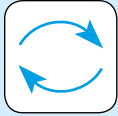

12

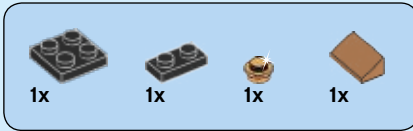
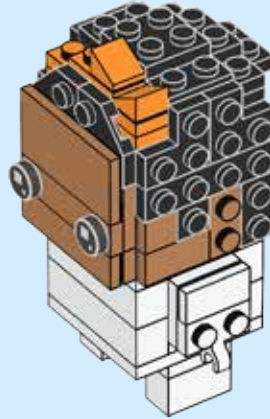

13

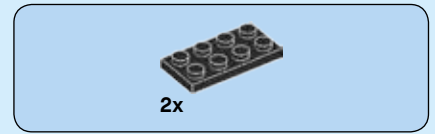
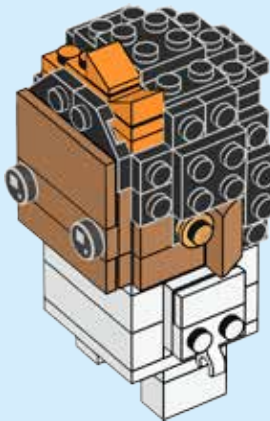

14

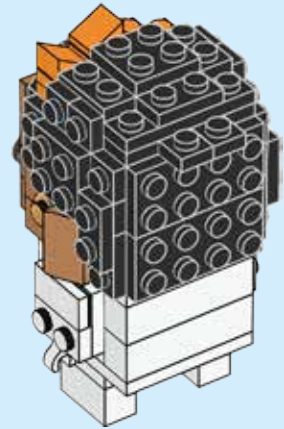
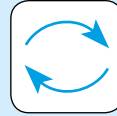

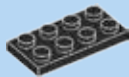

2x

15

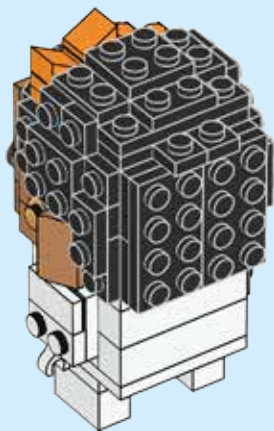

1x



1x

16

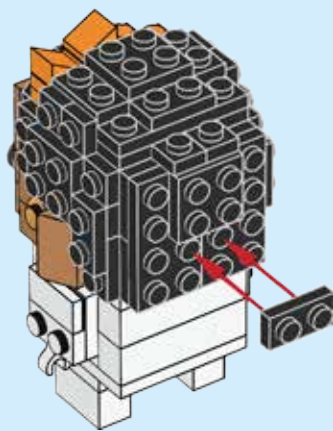

17

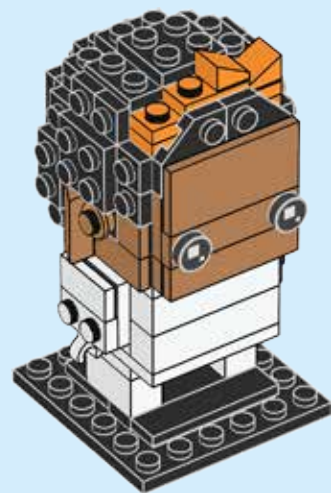
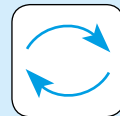

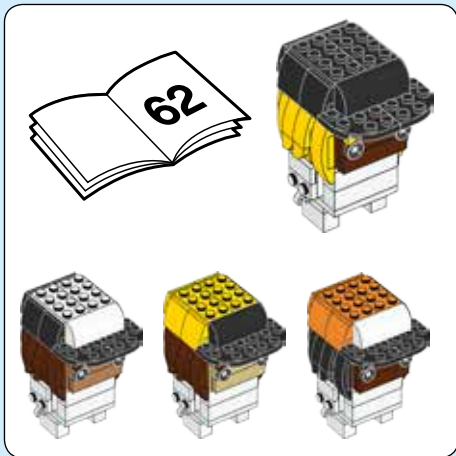

1

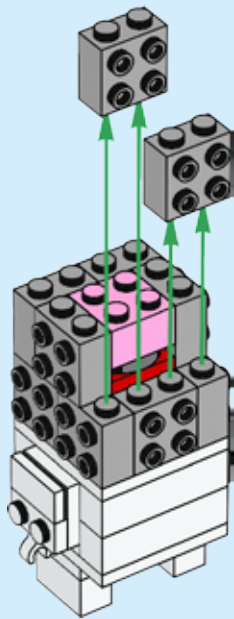

2

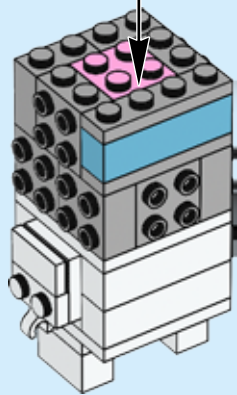
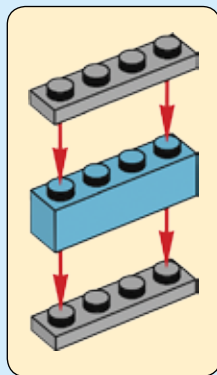

3

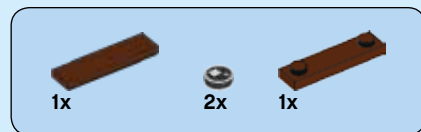
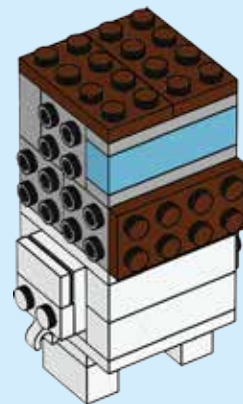

4

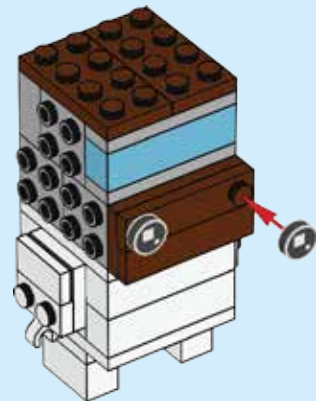

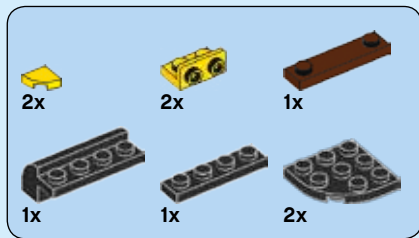

5

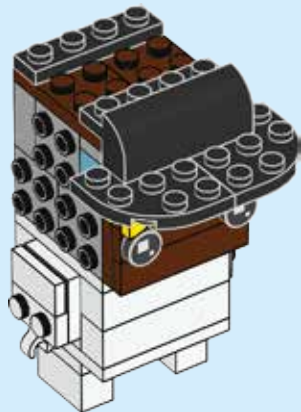

6

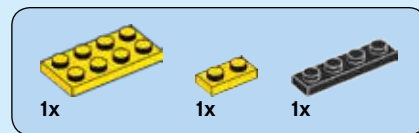
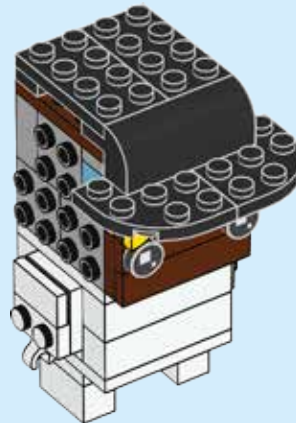

7

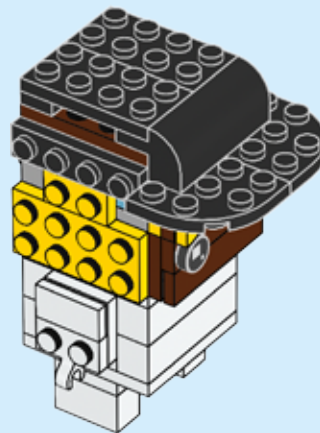

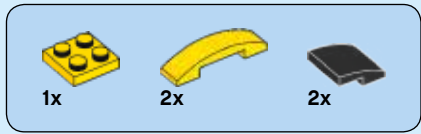

8

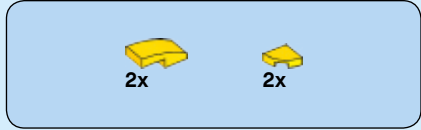
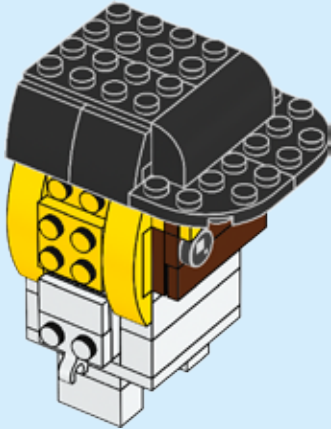

9

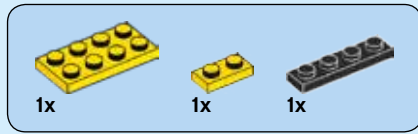
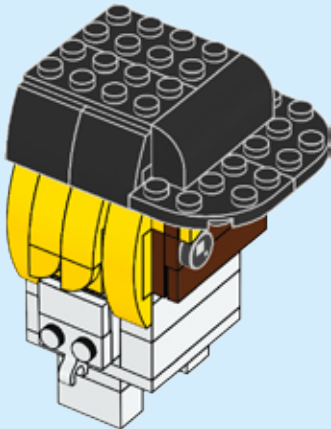

10

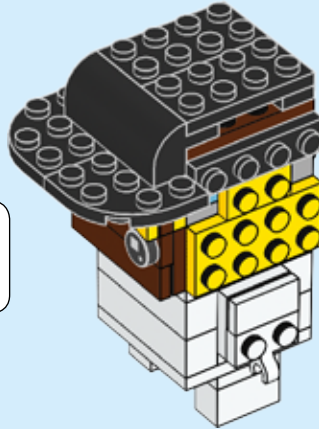
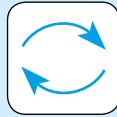

11

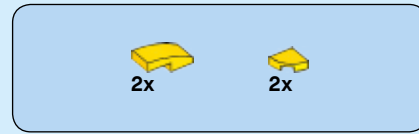
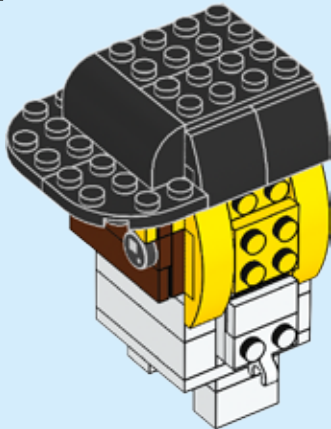

12

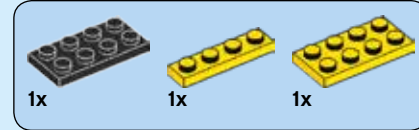
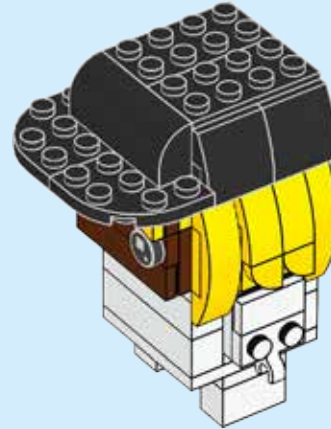

13

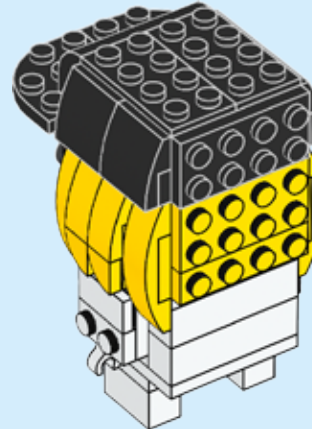



14

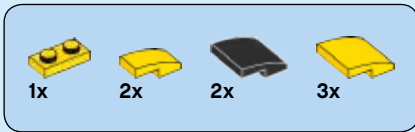
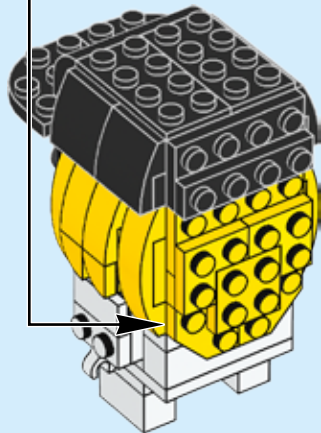
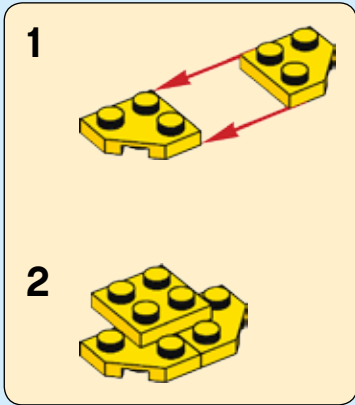

15

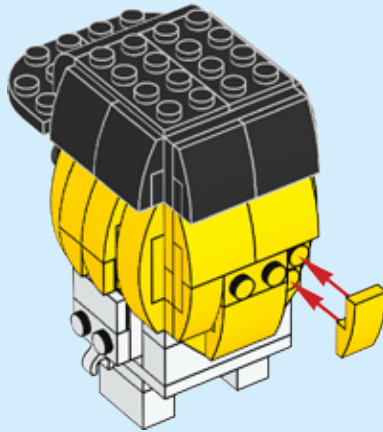

16

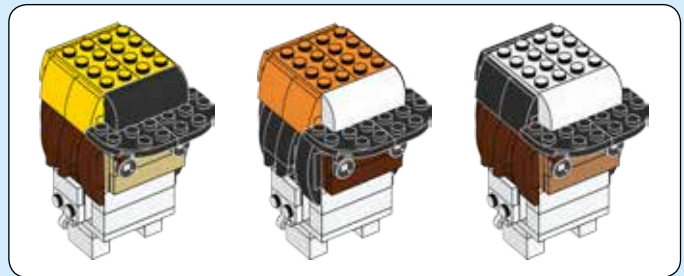
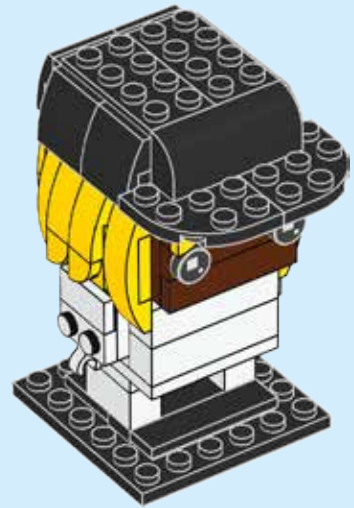
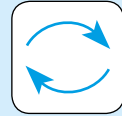

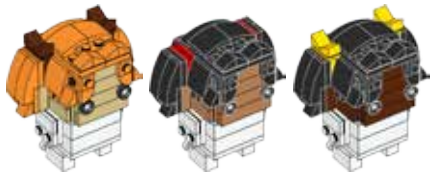

2x



1x

1

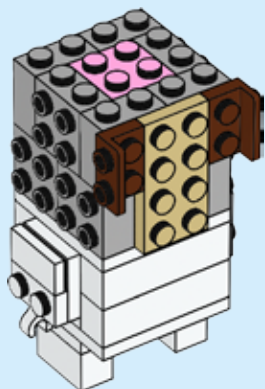

2x



1x



3x

2

1

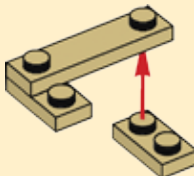

2

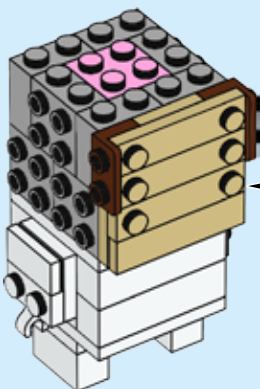
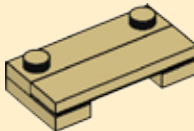

2x



2x



2x

3

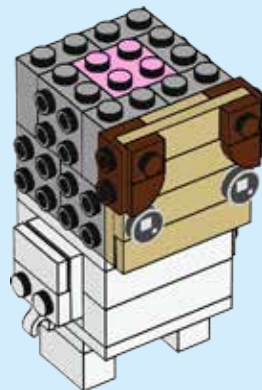

1x



2x

4

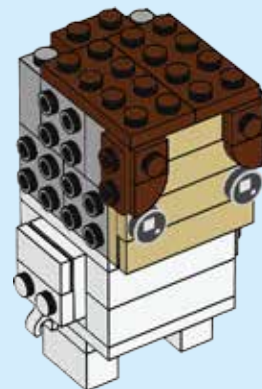

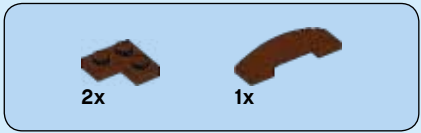

5

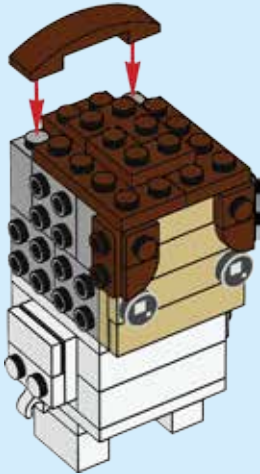

6

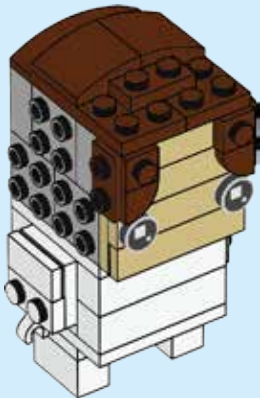

7

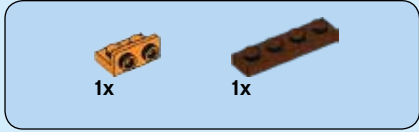
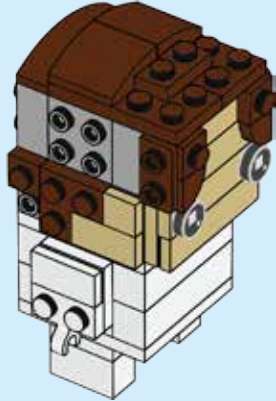

8

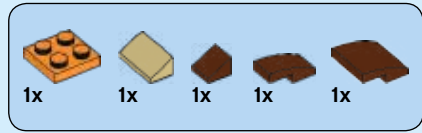
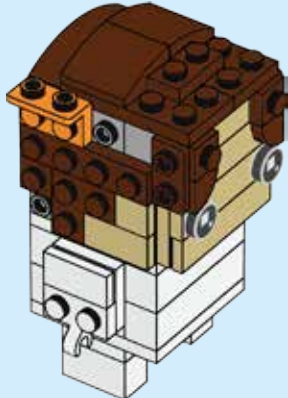

9

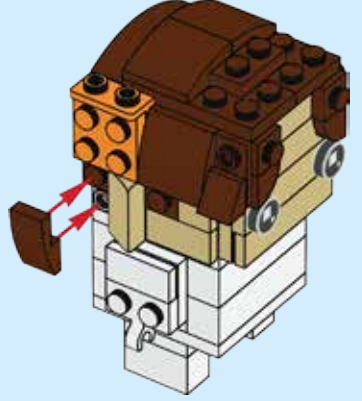

10

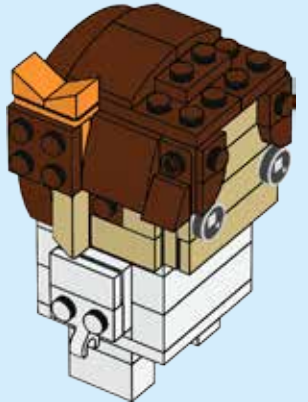

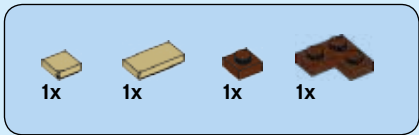

11

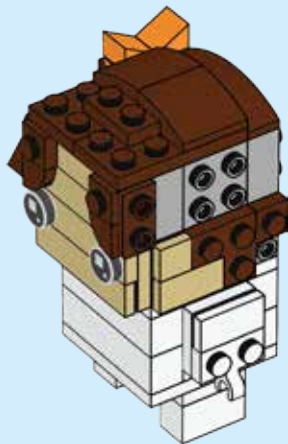
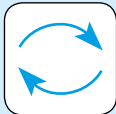

12

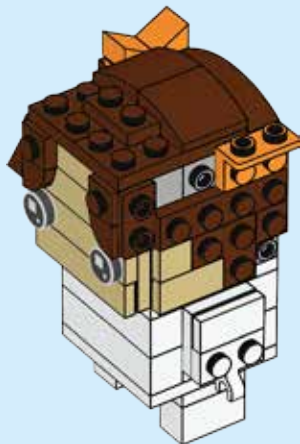

13

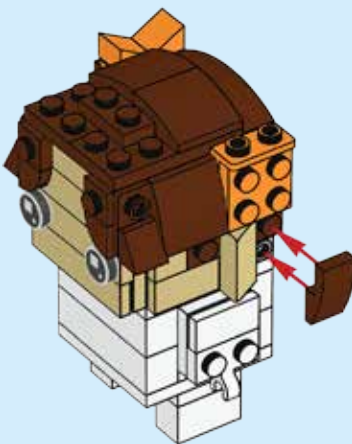

14

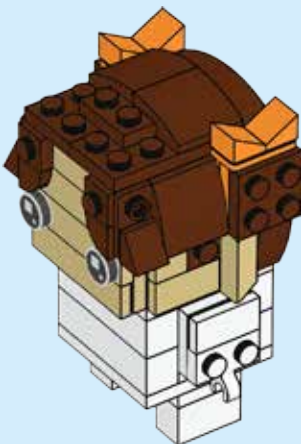

15

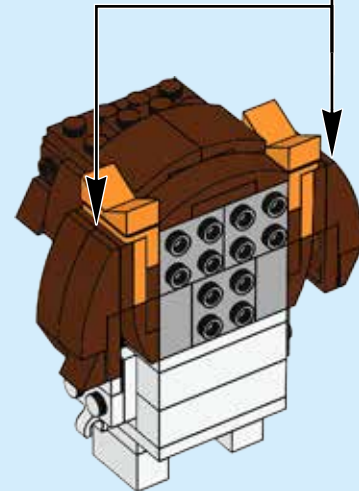
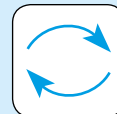



2x

16

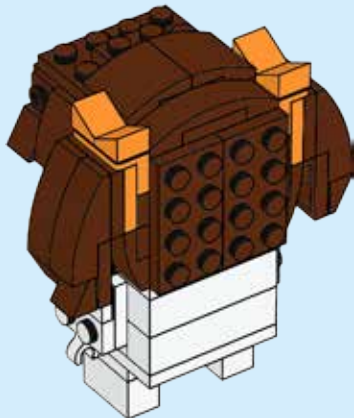

1x

17

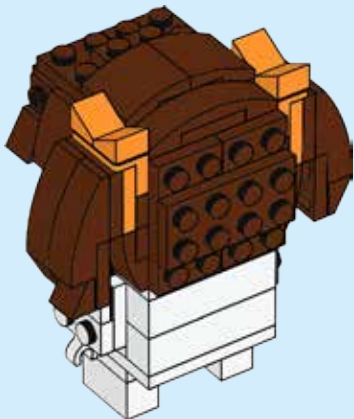

4x

18

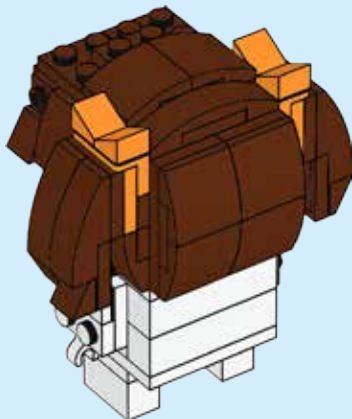

4x

19

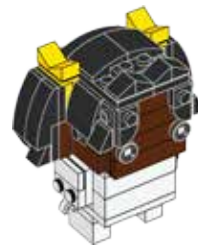
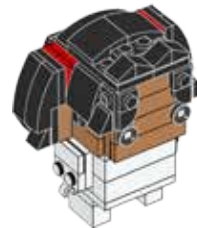
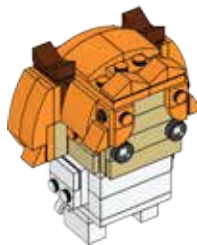
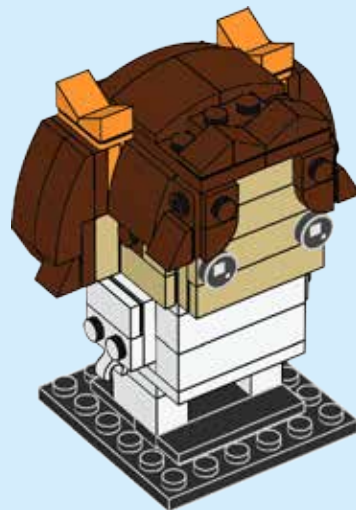
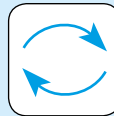

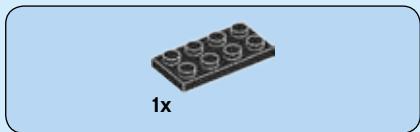
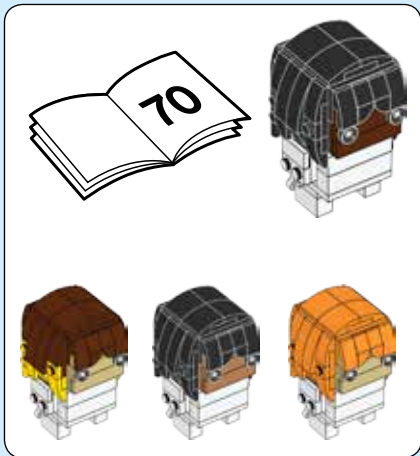

1

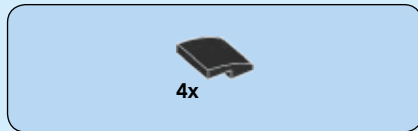
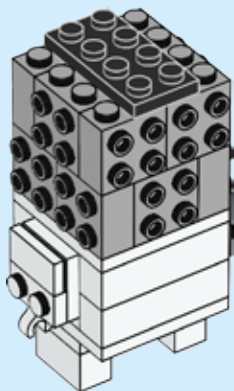

2

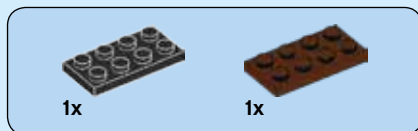
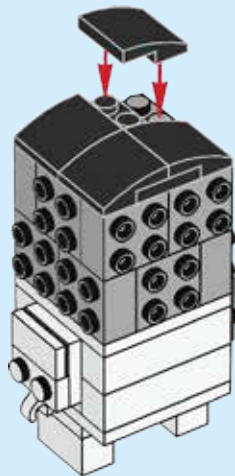

3

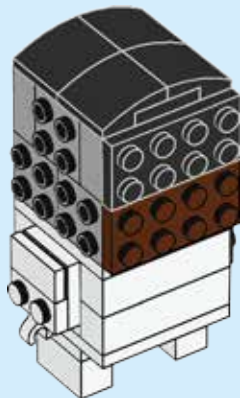

4

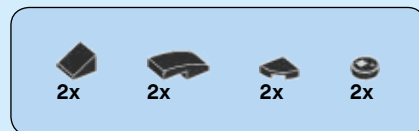
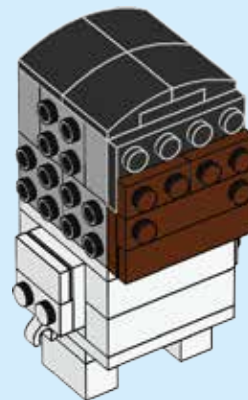

5

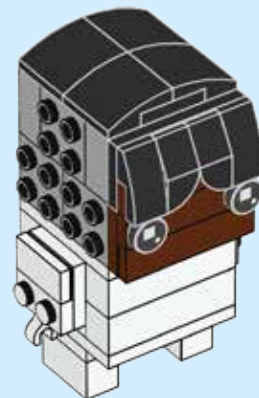



3x



1x

6

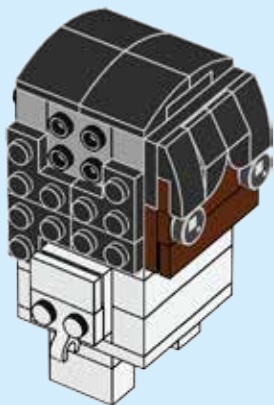

1x



2x



1x



1x



1x

7

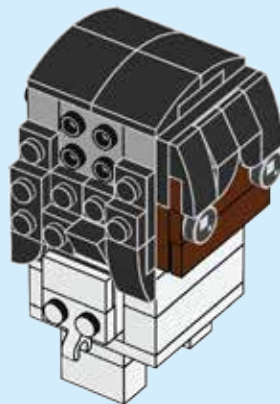

2x



2x



1x

8

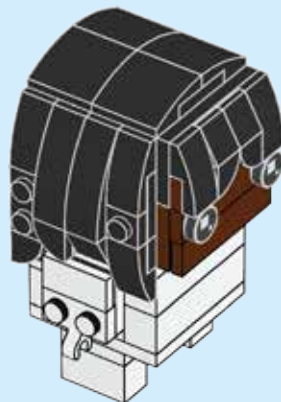

3x



1x

9

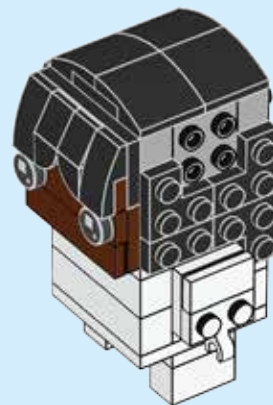
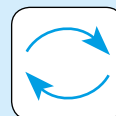



10

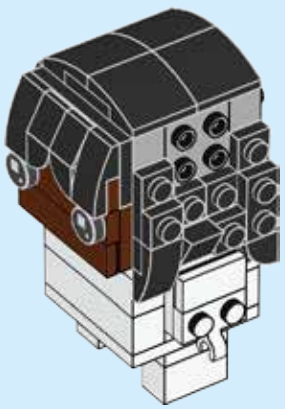

11

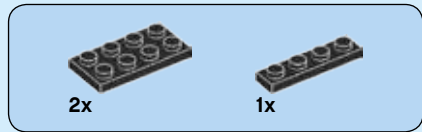
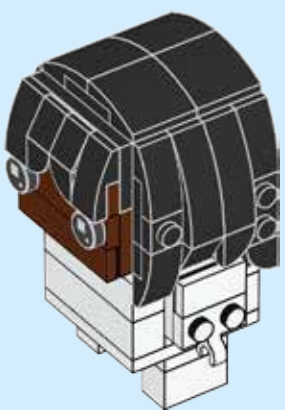

12

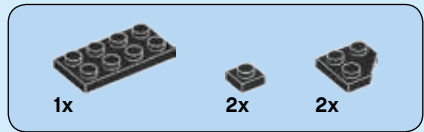
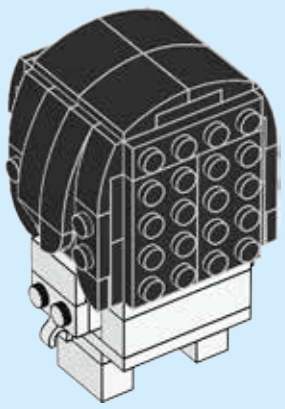
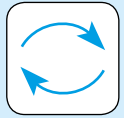

13

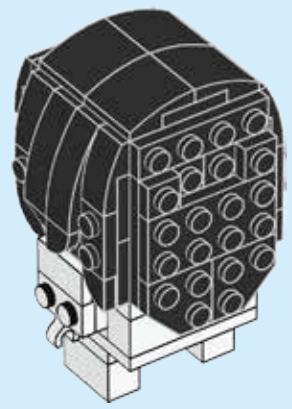

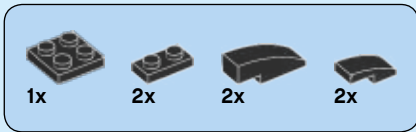

14

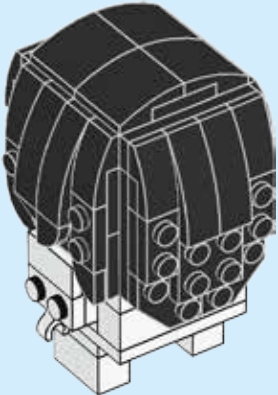

15

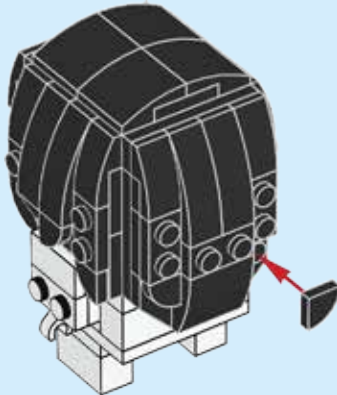

16

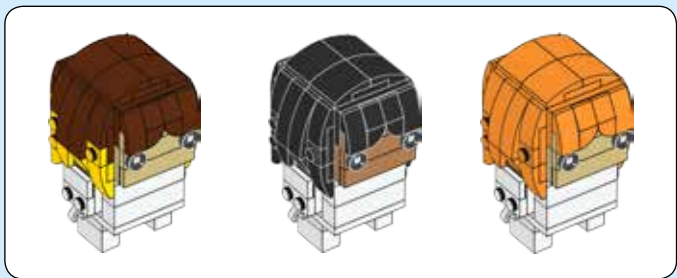
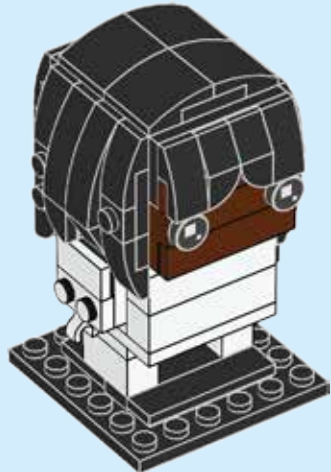
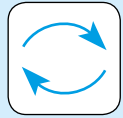



5

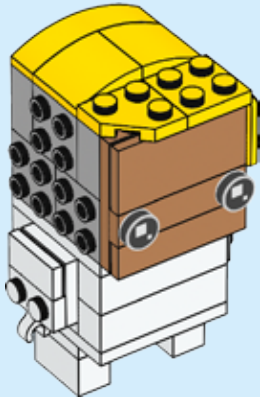

6

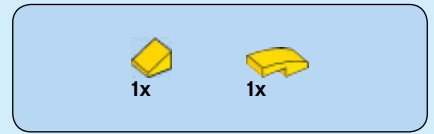
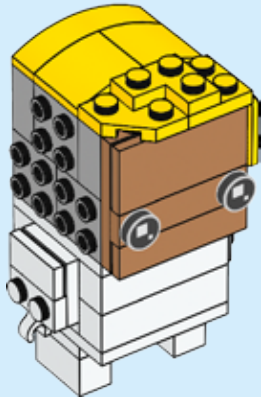

7

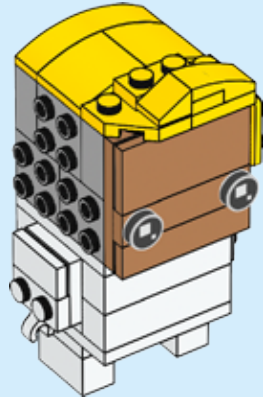

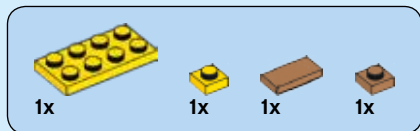

8

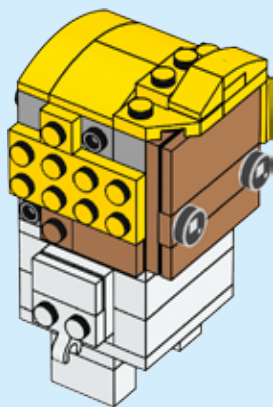

9

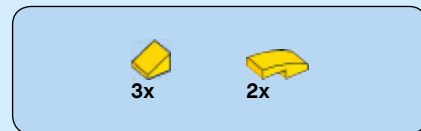
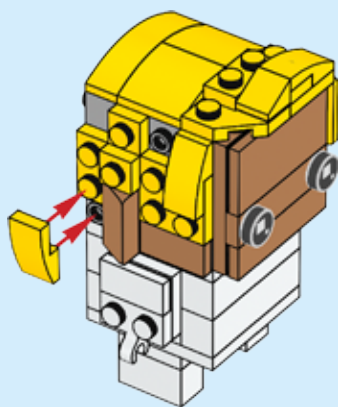

10

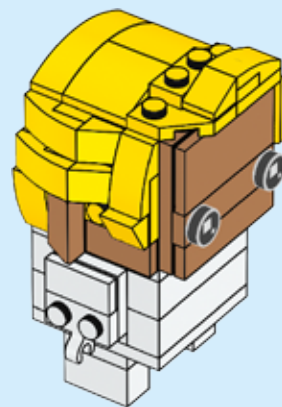



11

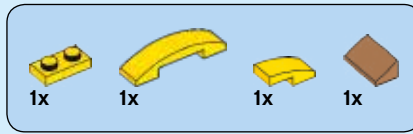
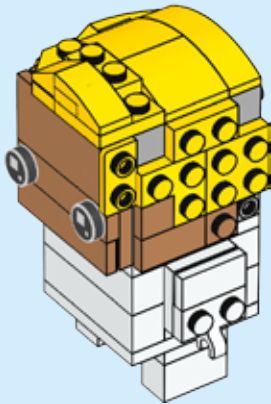
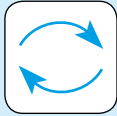

12

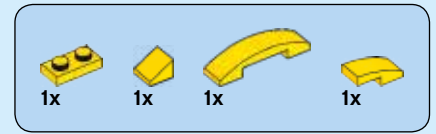
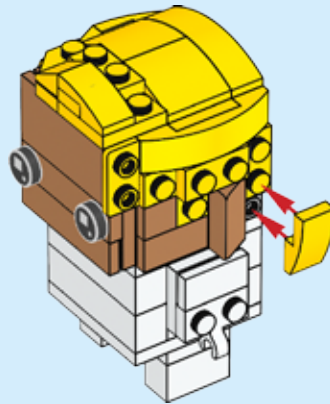

13

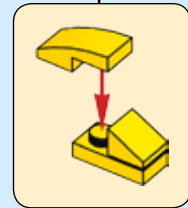
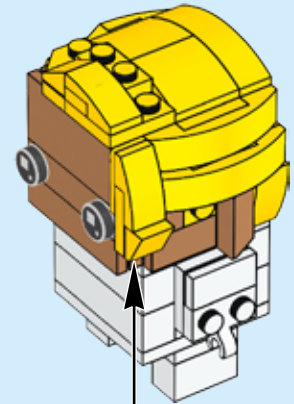



2x

14

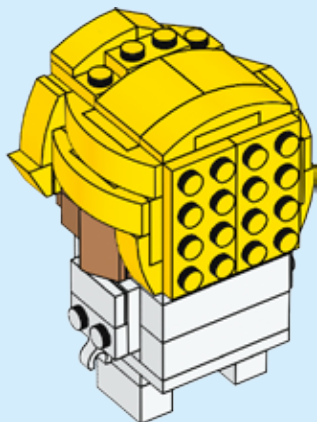
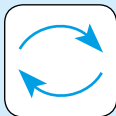

1x



1x

15

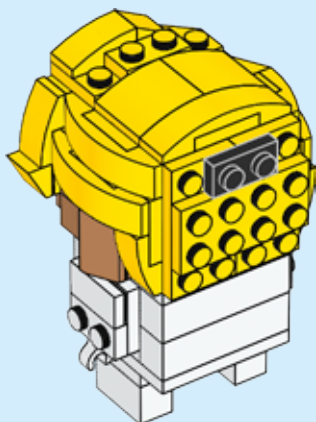

1x



2x



2x

16

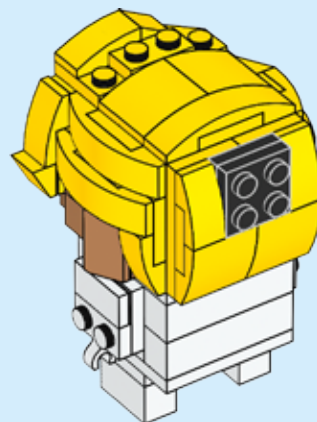

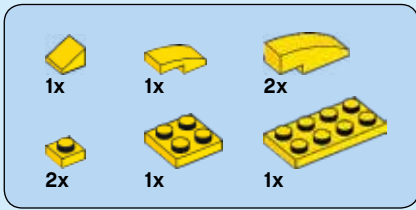

17

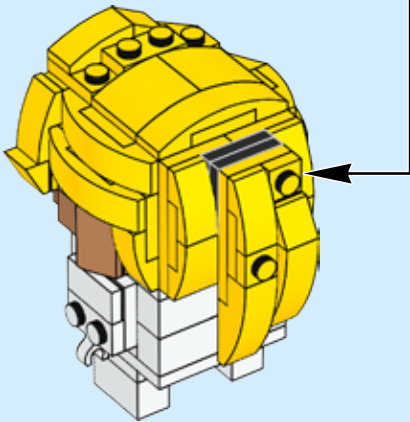
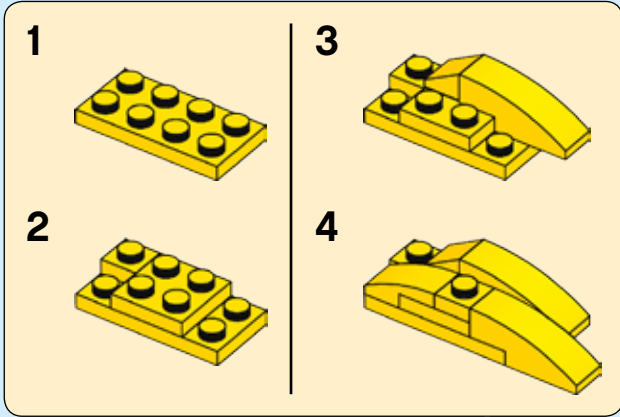

18

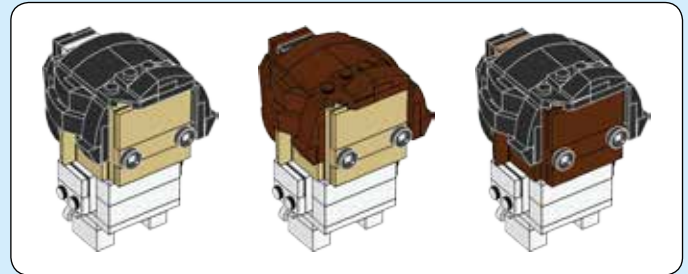
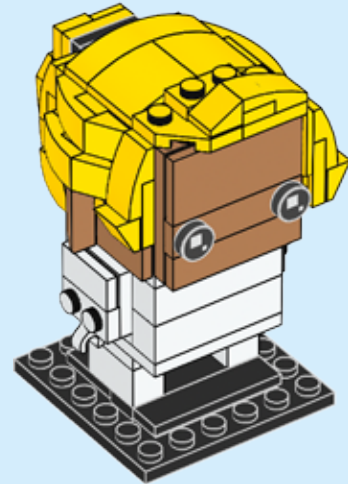
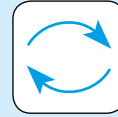

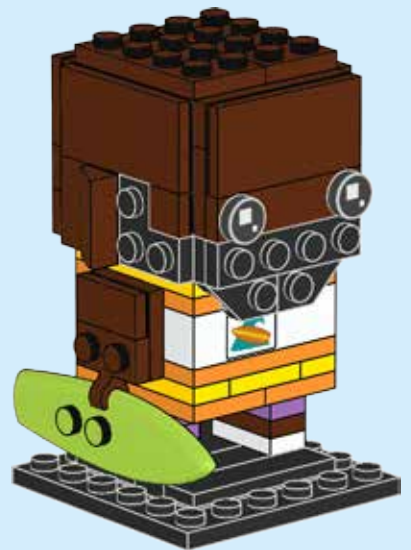
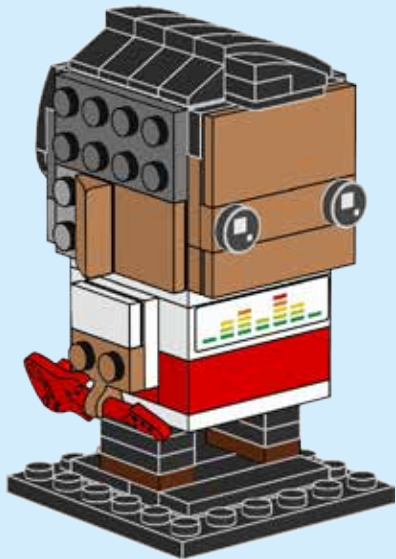
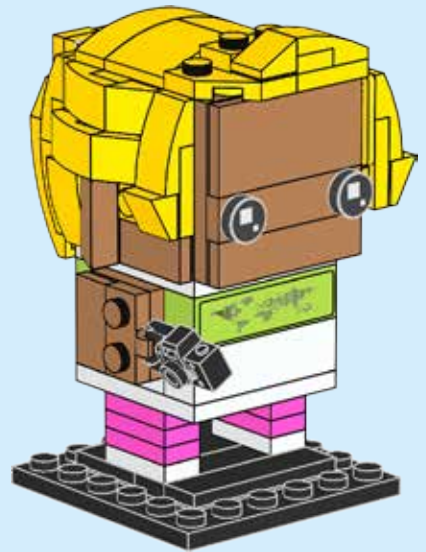
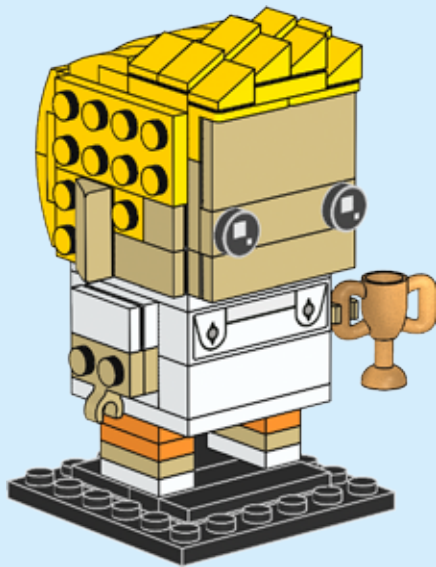

































































































#BRICKHEADZ

GO BRICK YOUR COLLECTION

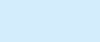

 BRICK
HEADZ

LEGO.COM/BRICKHEADZ

 2x 4547489	 5x 4243812	 28x 6123809	 4x 4251378	 8x 6195183	 1x 6104328	 4x 4613153
 2x 300401	 4x 4159553	 4x 4211397	 4x 302328	 8x 302424	 4x 6178627	 2x 243126
 5x 306901	 2x 4125253	 4x 4211445	 2x 371028	 12x 4504381	 12x 4504382	 2x 4599499
 2x 6070712	 4x 4624086	 2x 4211042	 1x 389921	 10x 6029947	 8x 302426	 4x 371026
 12x 302301	 4x 6177314	 4x 4211063	 2x 306921	 2x 6195184	 8x 6172383	 2x 4227392
 2x 306801	 4x 4114026	 4x 4211065	 6x 302321	 8x 302324	 1x 4106552	 1x 6174252
 2x 302201	 2x 6092587	 2x 4500125	 2x 303921	 2x 6057458	 10x 6047276	 1x 6174252
 1x 243101	 4x 4113917	 6x 4164037	 4x 300321	 6x 242024	 2x 6174243	 2x 4560182
 4x 301001	 2x 4114084	 4x 4234716	 4x 4163087	 4x 302224	 8x 302326	 6x 302026
 1x 4597131	 2x 4185177	 4x 4234716	 1x 6121723	 10x 6079007	 2x 6020193	 1x 6208550
 1x 608101	 3x 6173056	 4x 4537936	 4x 301021	 6x 4247771	 4x 302226	 1x 6208551
 1x 302001	 3x 4550324	 4x 4537936	 4x 301021	 4x 371024	 10x 6053077	 1x 6208551
 5x 4560178	 4x 6122047	 1x 6102906	 4x 302021	 4x 4613151	 6x 242026	 2x 395826
 5x 4560178	 4x 6122047	 1x 6102906	 4x 302021	 6x 302024	 6x 4251161	 2x 395826

8x
4524929

8x
6173925

12x
4504371

8x
4177932

10x
6055069

2x
6218367

2x
6218368

10x
6067913

4x
4159007

6x
6106027

6x
4251969

4x
4650977

4x
4118782

6x
4158355

8x
6149677

12x
4221744

12x
4504376

2x
4211288

1x
6134672

1x
6134673

4x
6035291

4x
6185998

2x
6092590

12x
4211150

4x
4211151

10x
6069984

2x
6218366

2x
6174856

10x
6146858

6x
4211257

2x
4271949

6x
4216695

6x
6018773

1x
4211235

3x
6210077

4x
4658005

4x
4211190

3x
4211194

4x
4579690

10x
4211186

4x
6215606

2x
6177146

4x
6218358

4x
6021997

4x
6218360

4x
6218361

2x
6218364

2x
6102990

2x
6056383

3x
6102998

3x
6218363

4x
6093494

4x
6218359

4x
4619512

2x
4619524

6x
6057387

2x
6056381

4x
4621542

4x
6056263

2x
4550359

1x
4499710

1x
6240515

4x
4528981

2x
4502089

6x
6097419

2x
4649741

4x
6036238

4x
4655256

2x
4523159

1x
6181575

2x
4633691

Customer Service

Kundenservice

Service Consommateurs

Servicio Al Consumidor

LEGO.com/service or dial



: 00800 5346 5555

: 1-800-422-5346



WIN

GO TO [WWW.LEGO.COM/PRODUCTFEEDBACK](http://www.LEGO.COM/PRODUCTFEEDBACK) AND
GIVE US YOUR SHORT **FEEDBACK** ABOUT THIS
LEGO® SET FOR A CHANCE TO WIN
A COOL LEGO PRIZE.

Terms & Conditions apply

LEGO.com/productfeedback

GEWINNE

Erzähle uns auf
www.LEGO.com/productfeedback

etwas über die Erfahrungen, die du mit
diesem LEGO® Set gemacht hast, und
sichere dir die Chance auf einen coolen
LEGO Preis!

Es gelten die Teilnahmebedingungen

GAGNE

Rends-toi sur
www.LEGO.com/productfeedback

et donne-nous quelques commentaires
sur ce produit LEGO® pour avoir une
chance de gagner un prix LEGO !

Voir Conditions Générales

GANAN

Visita
www.LEGO.com/productfeedback

y envíanos tu opinión acerca de este set
LEGO®. ¡Participarás en el sorteo de un
premio LEGO!

Términos y Condiciones aplicables

获取奖品

登录
www.LEGO.com/productfeedback

给出关于此乐高®套装的简短反馈，
就有机会获得炫酷乐高奖品

《条款及条件》适用