

1



2



3



4





1



2



3

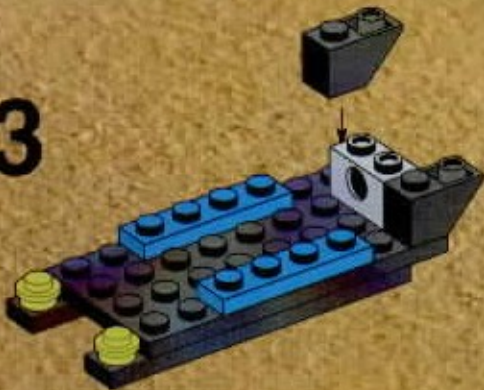

4



5



6

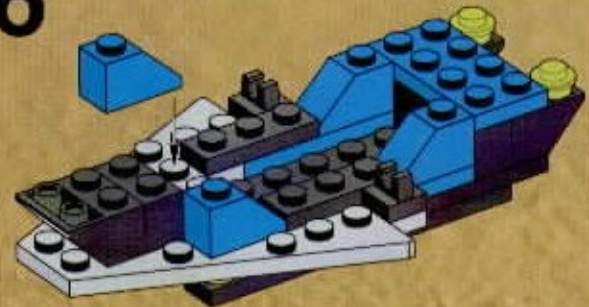

7

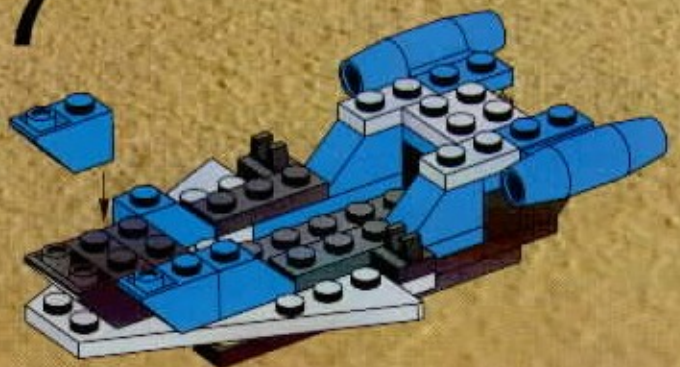

8

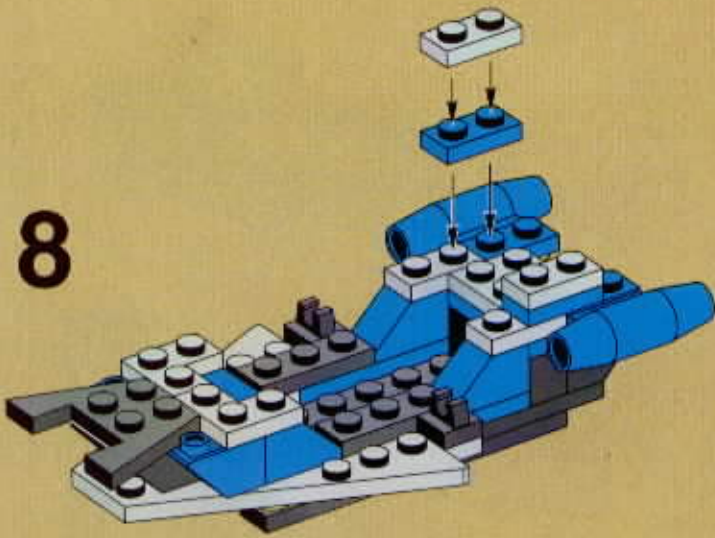

9

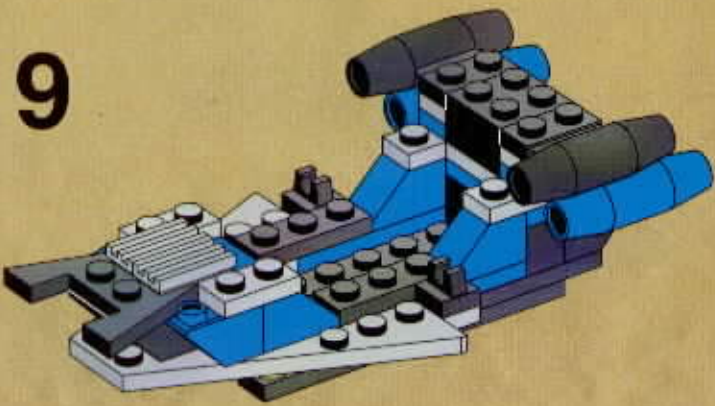

10

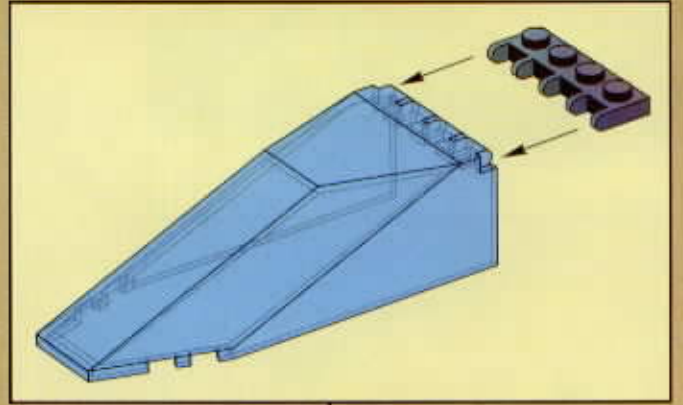
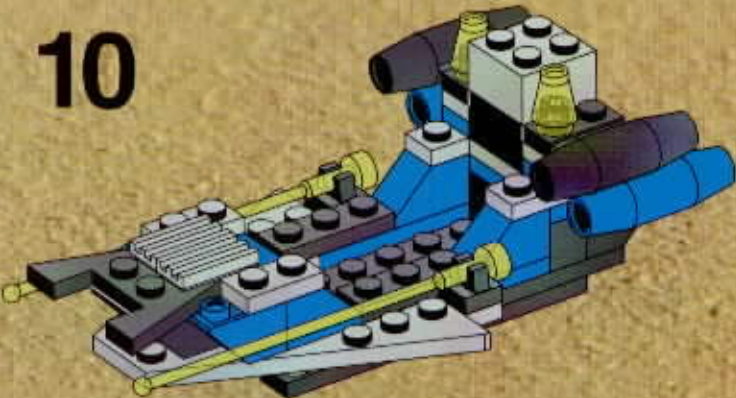

11

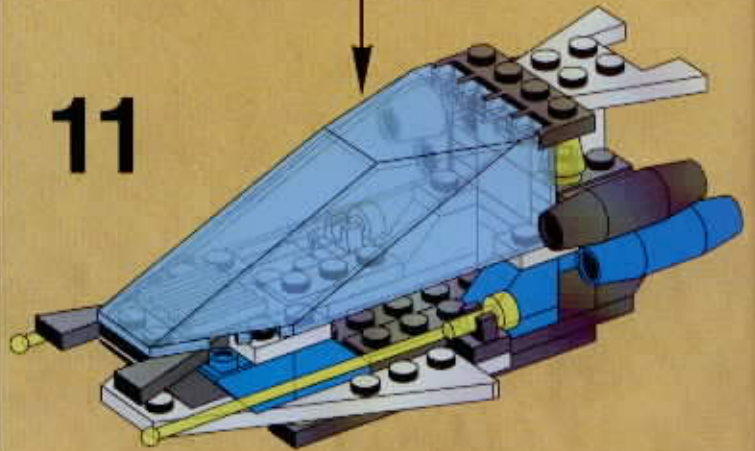

12

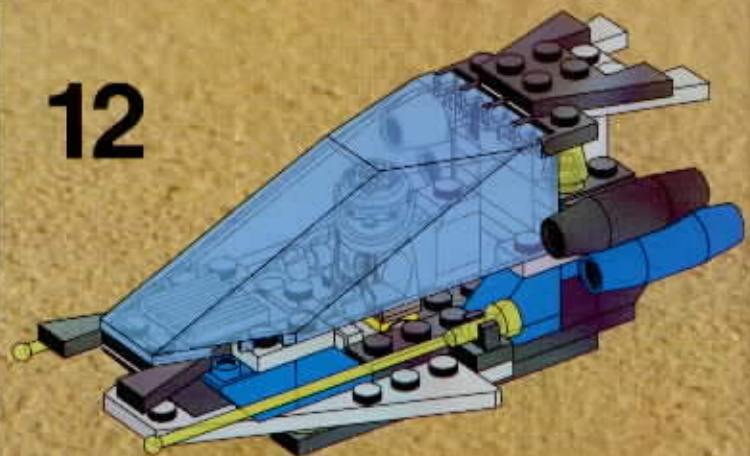

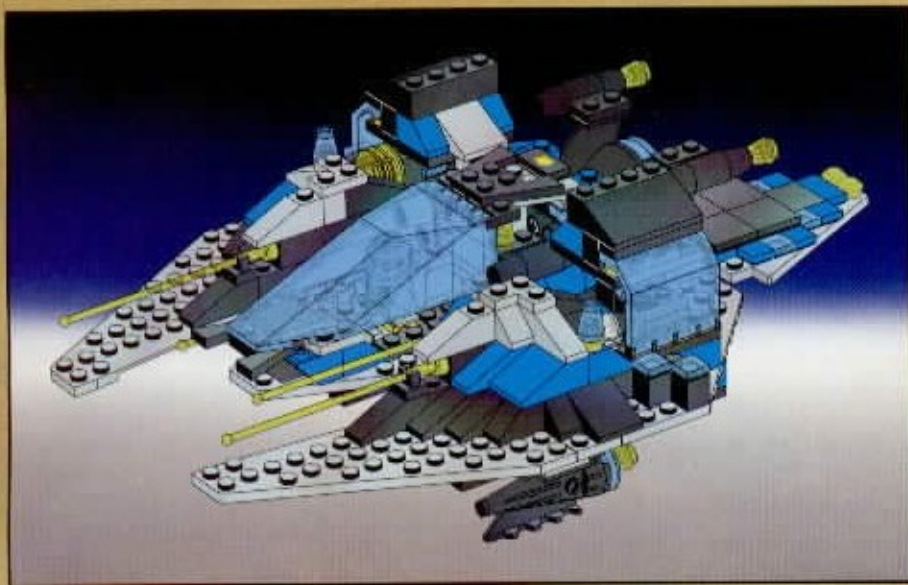

1



2

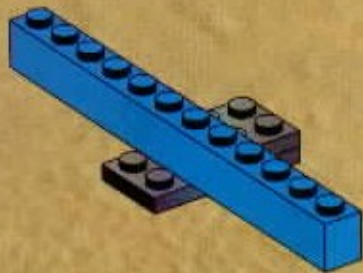

3

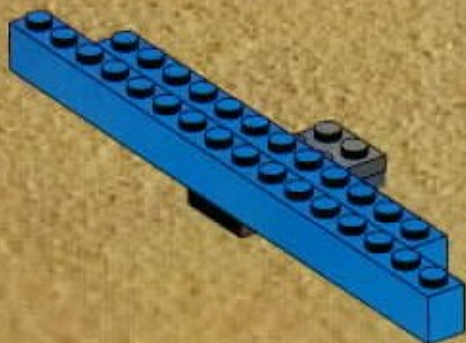

4

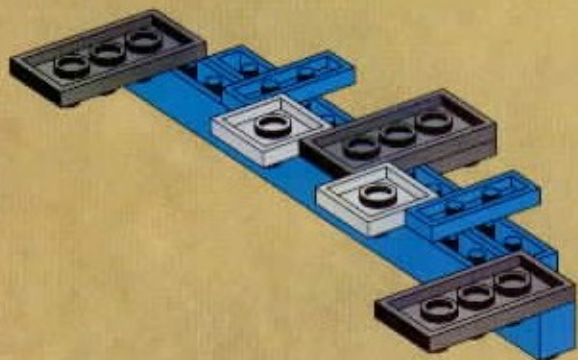

5

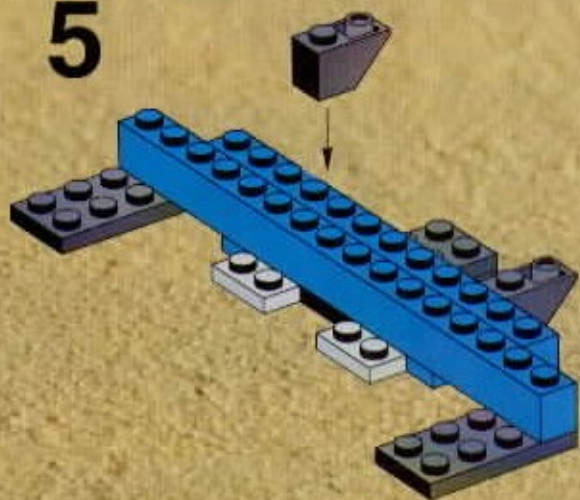

6

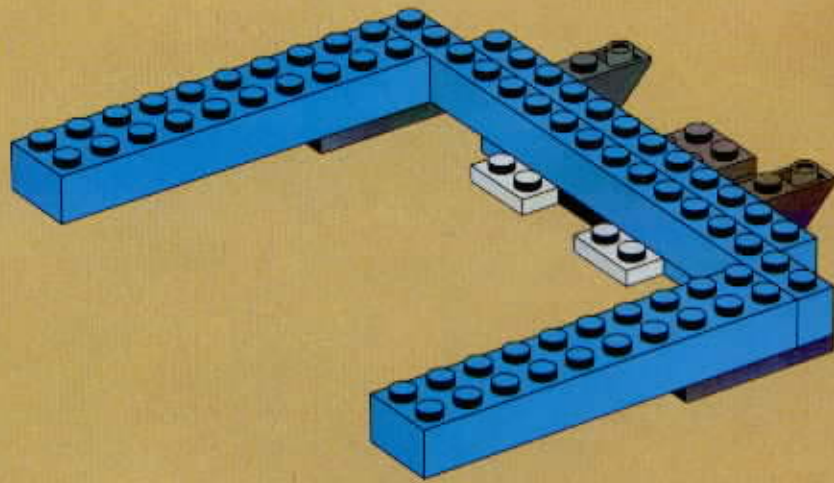

7

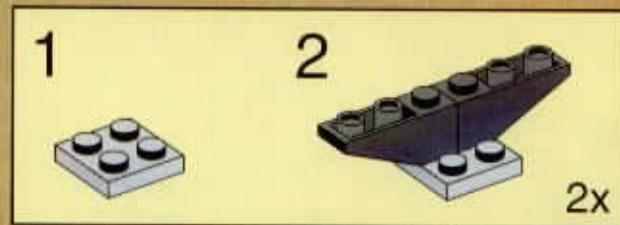
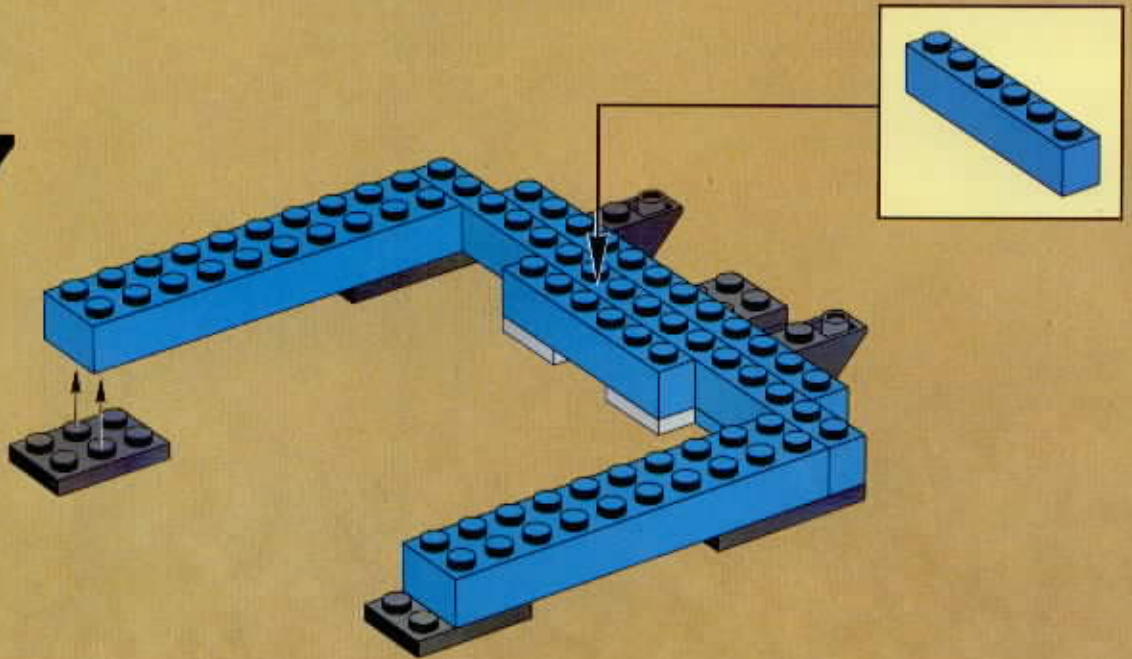

8

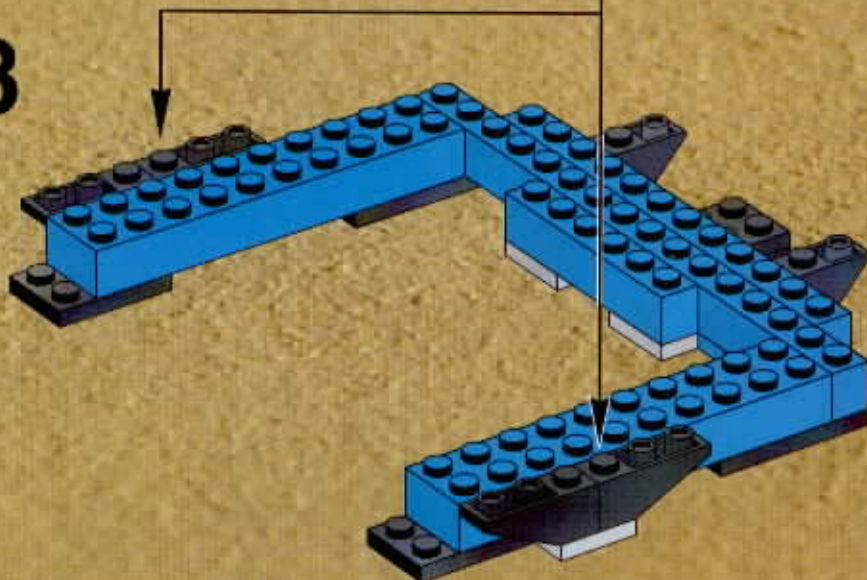

1



2



3



4



5

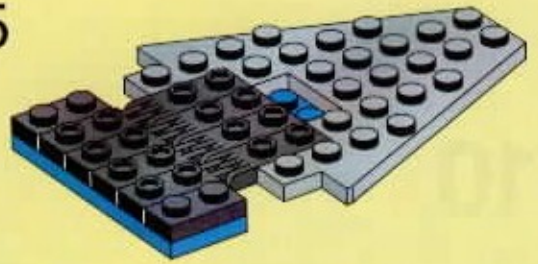

6



7

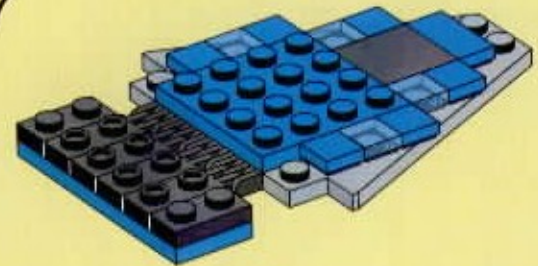

8

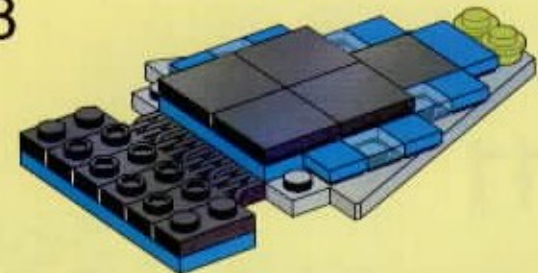

9

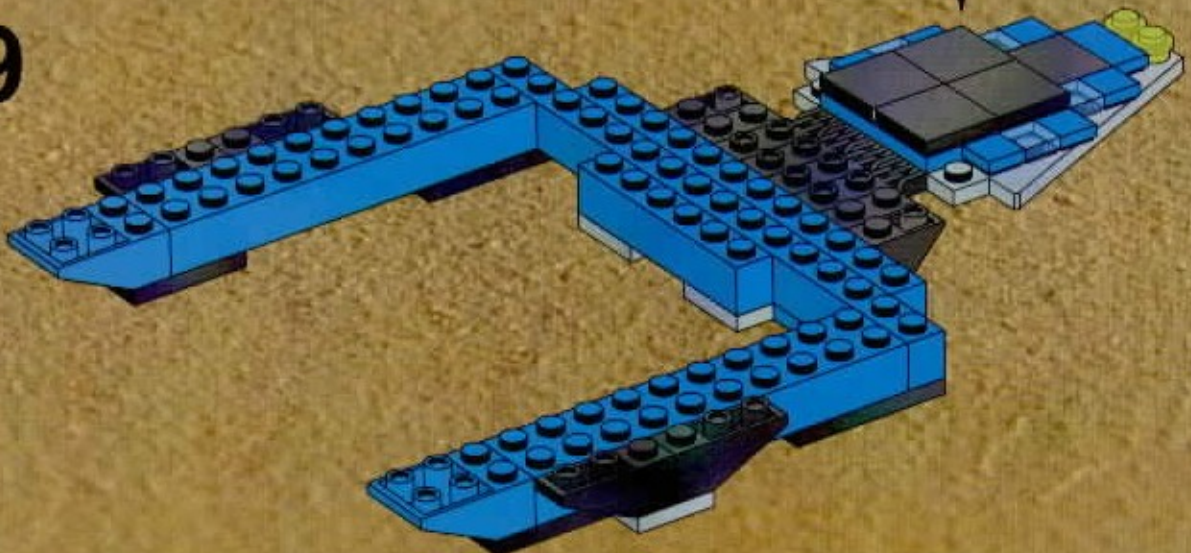

10

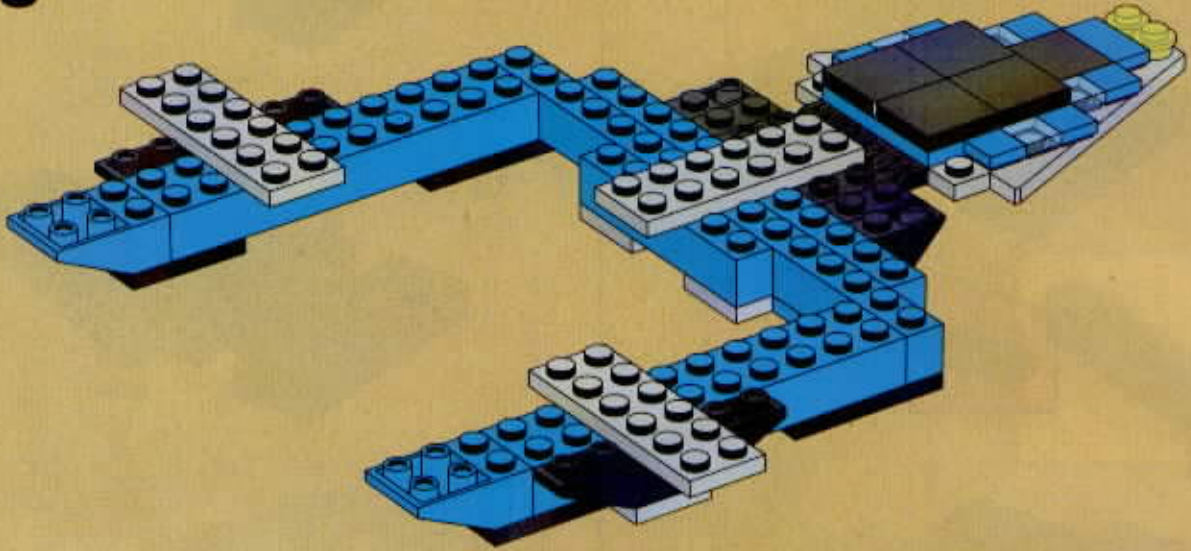

11

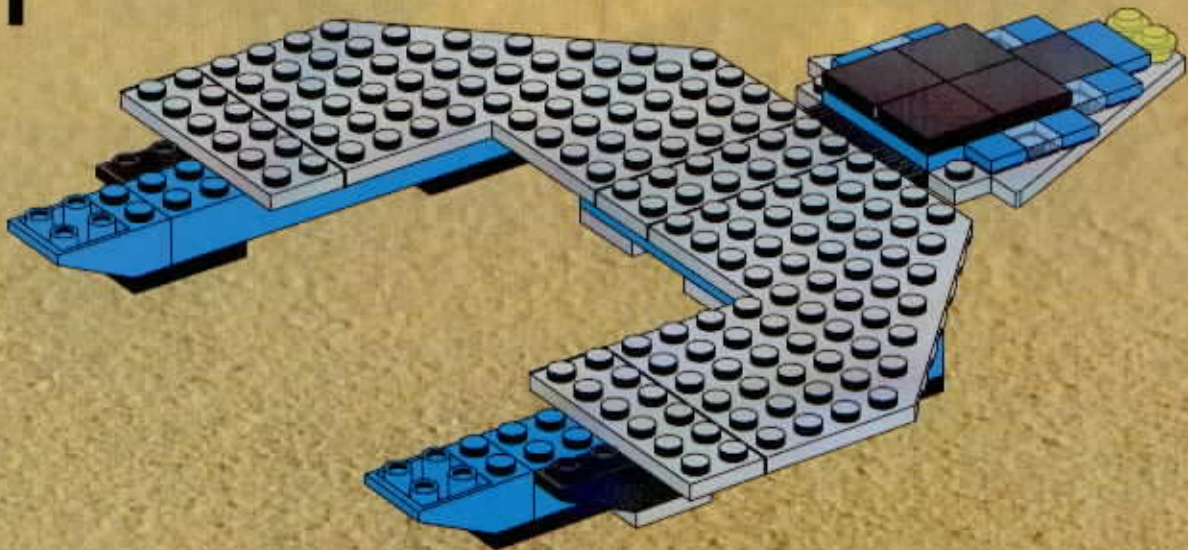



12

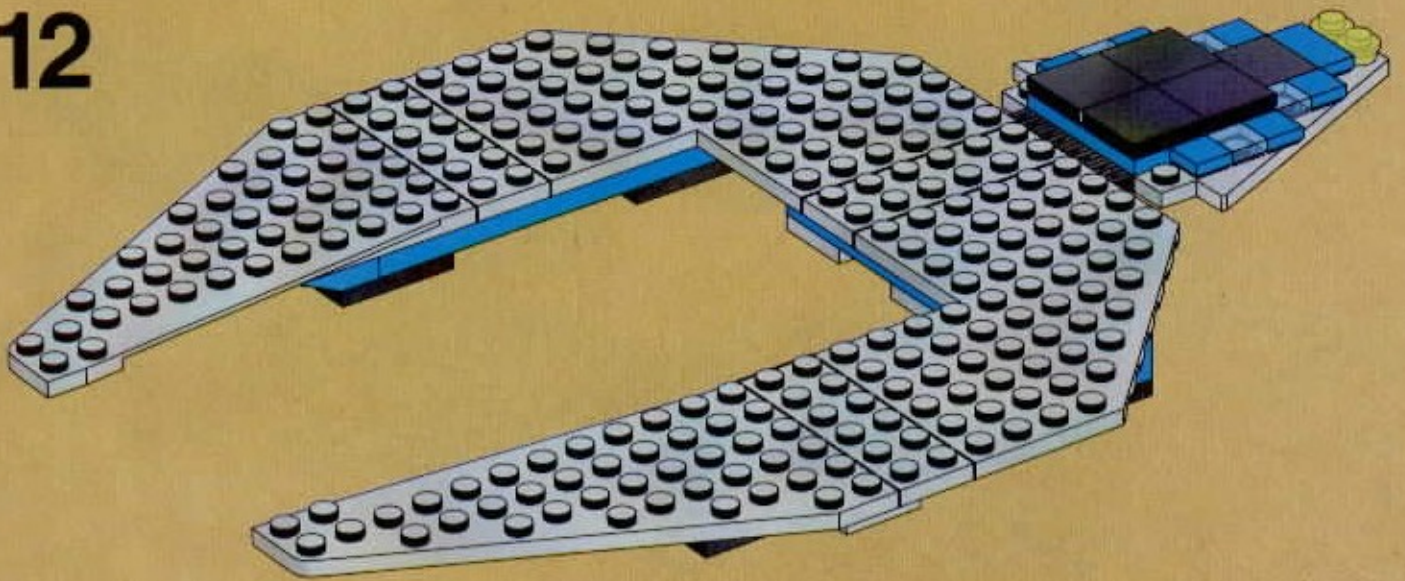

13

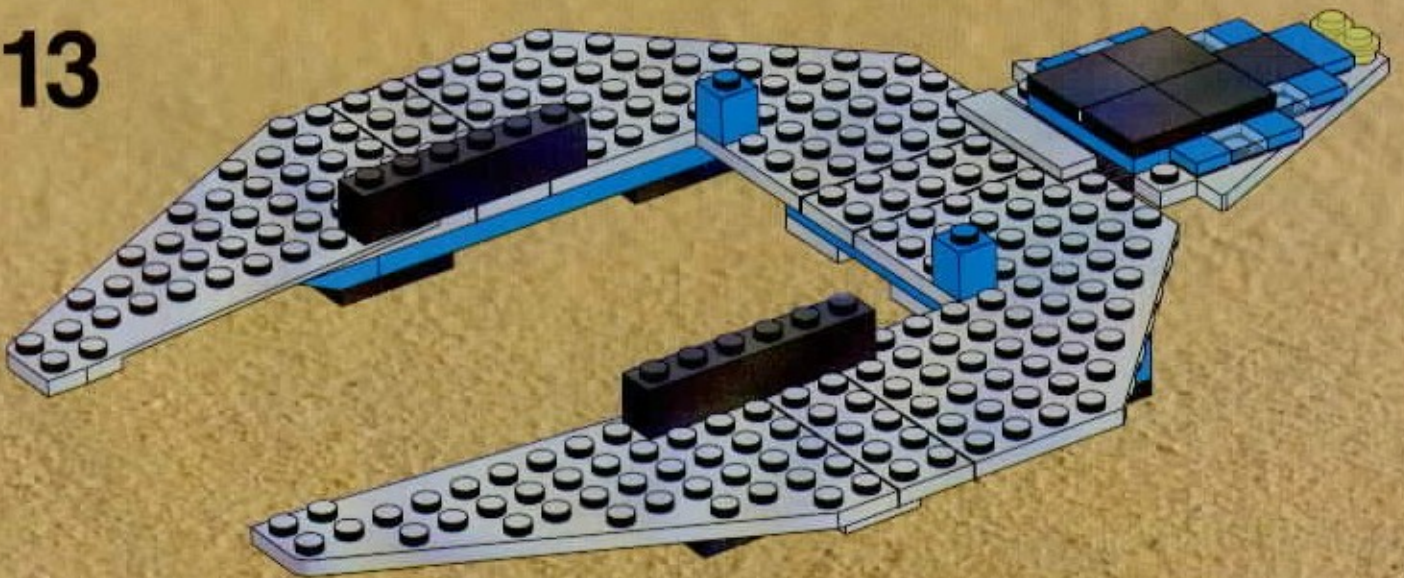

14

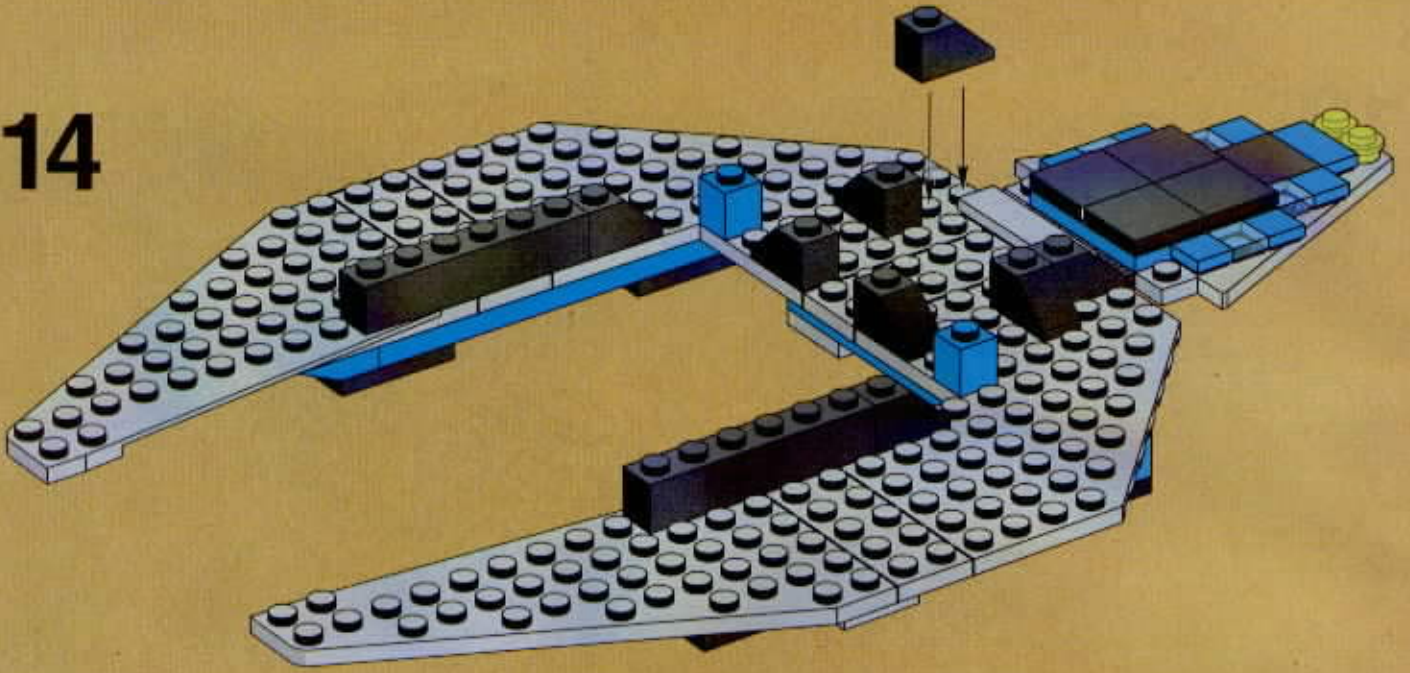

15

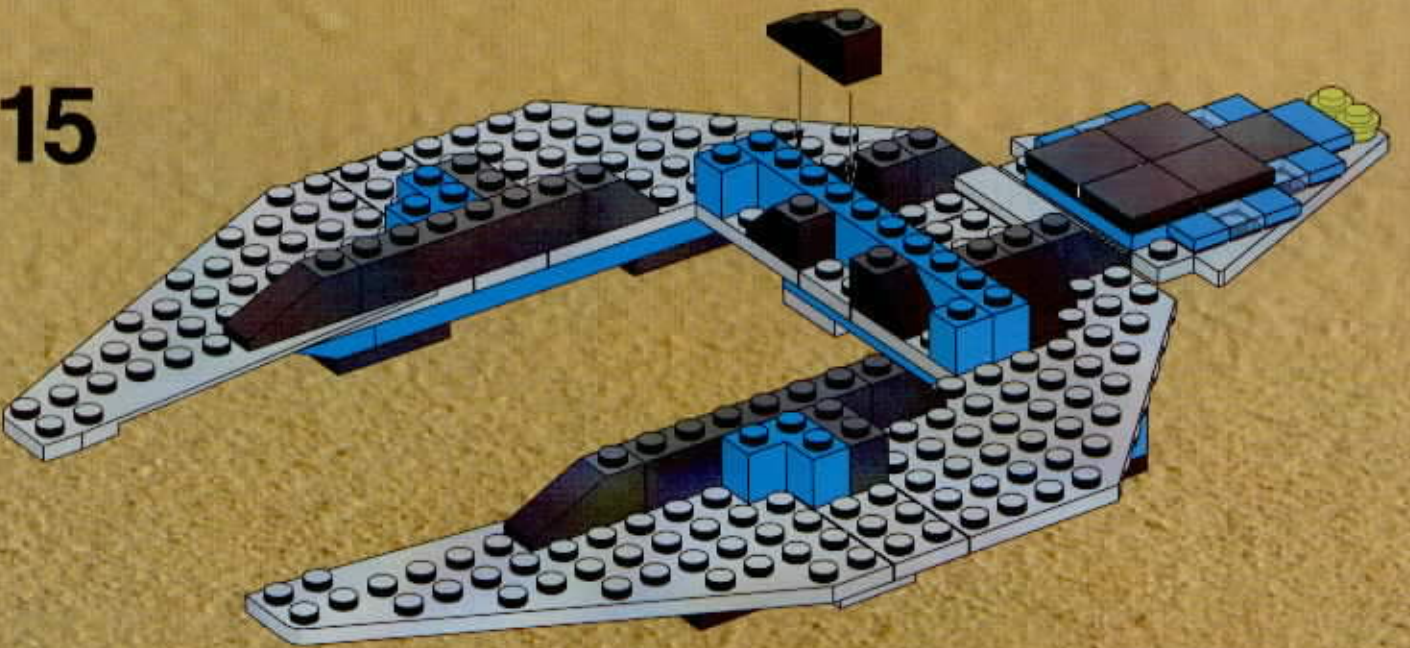

16

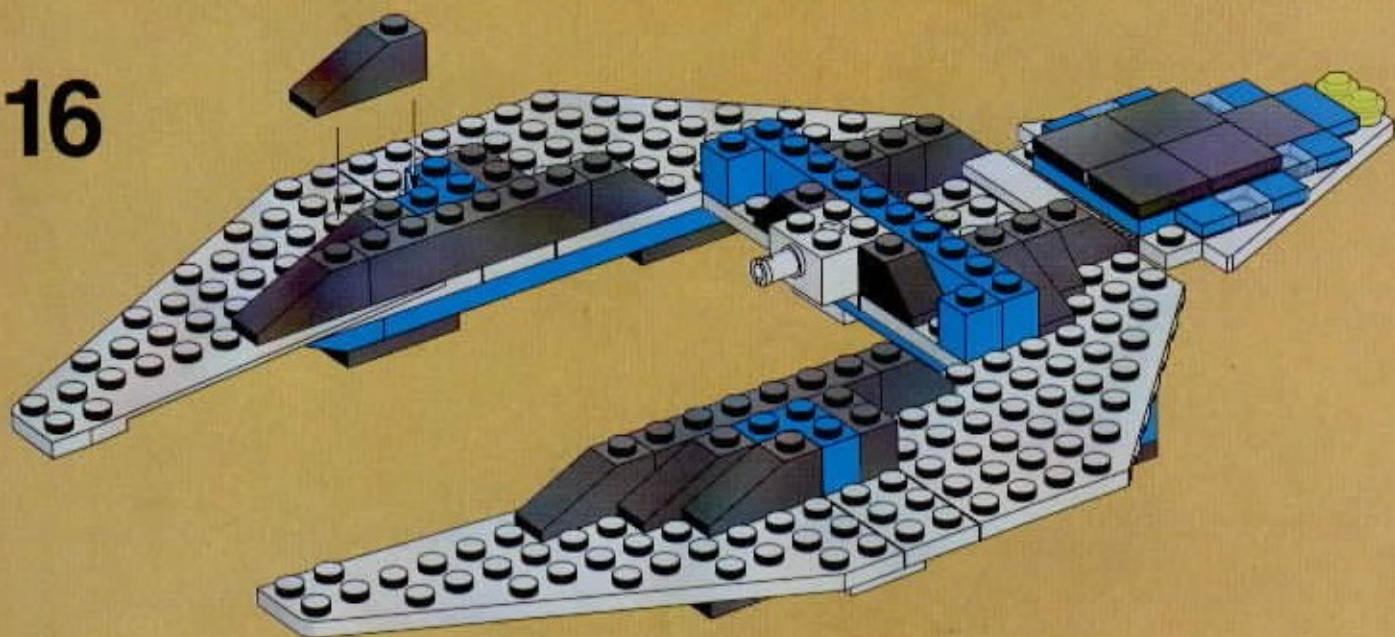

17

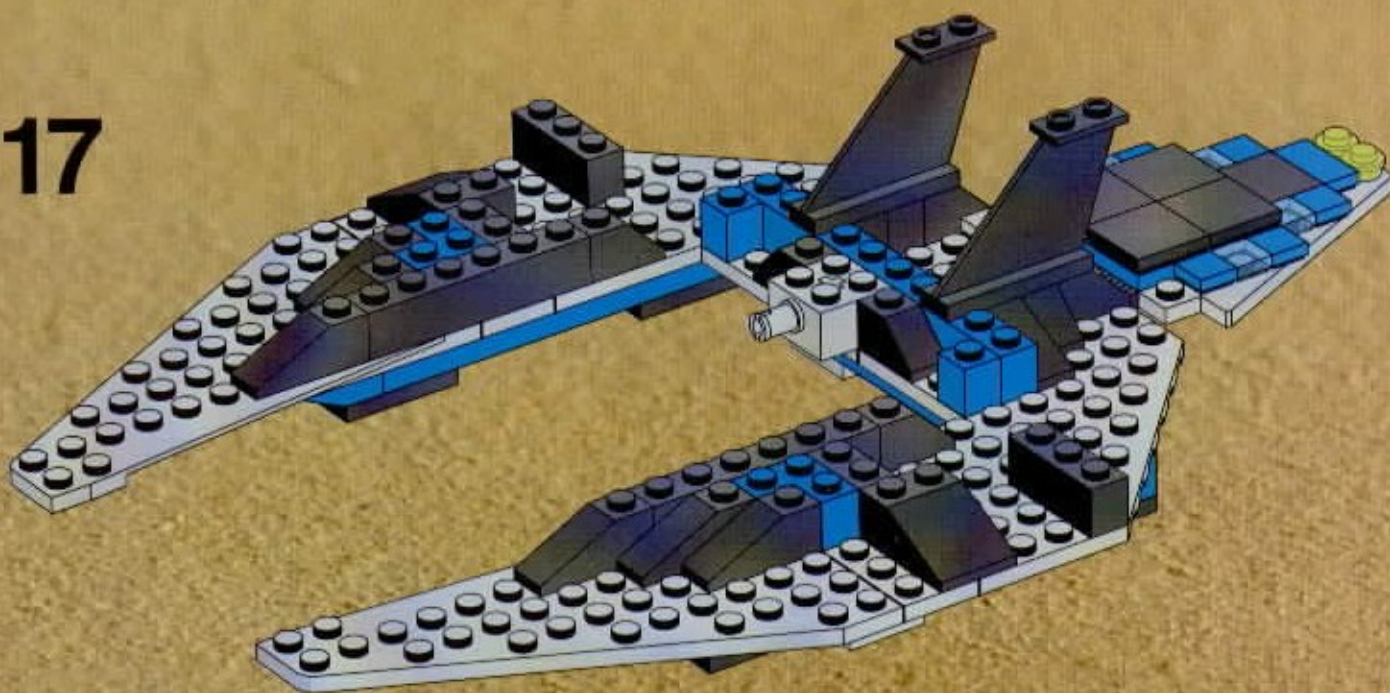

18

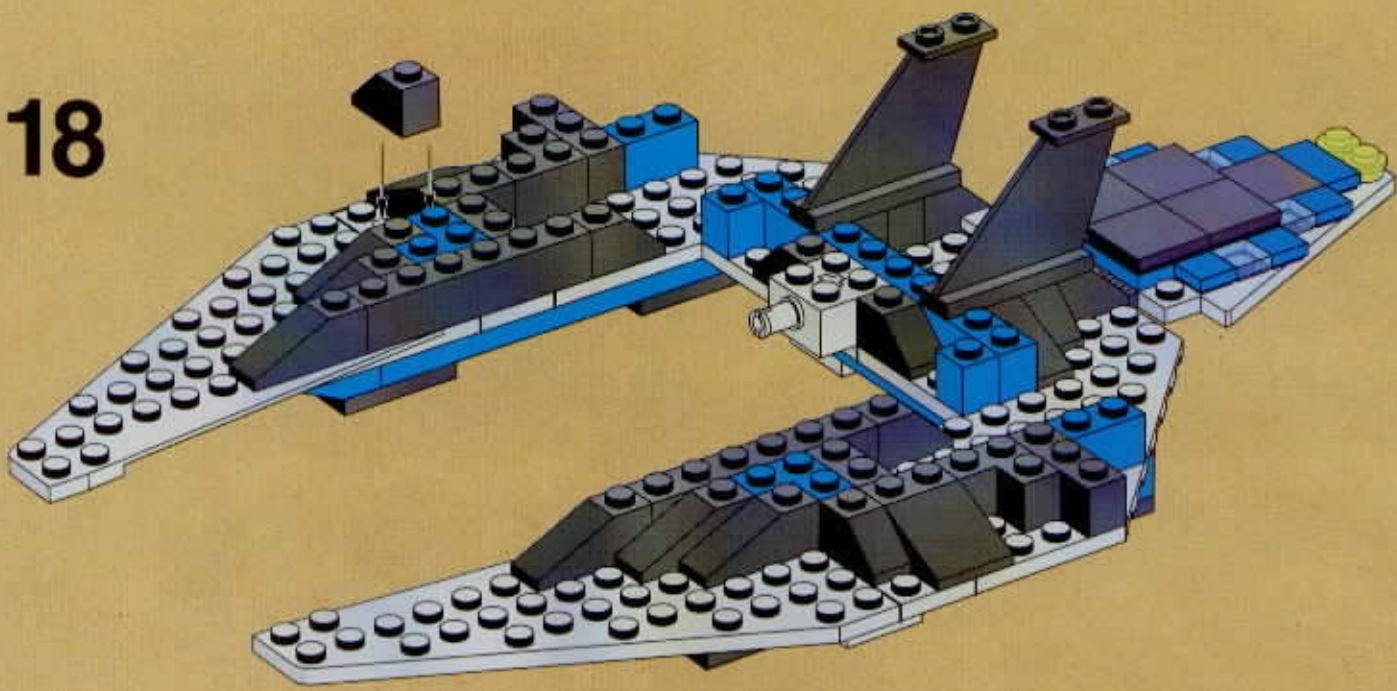

19

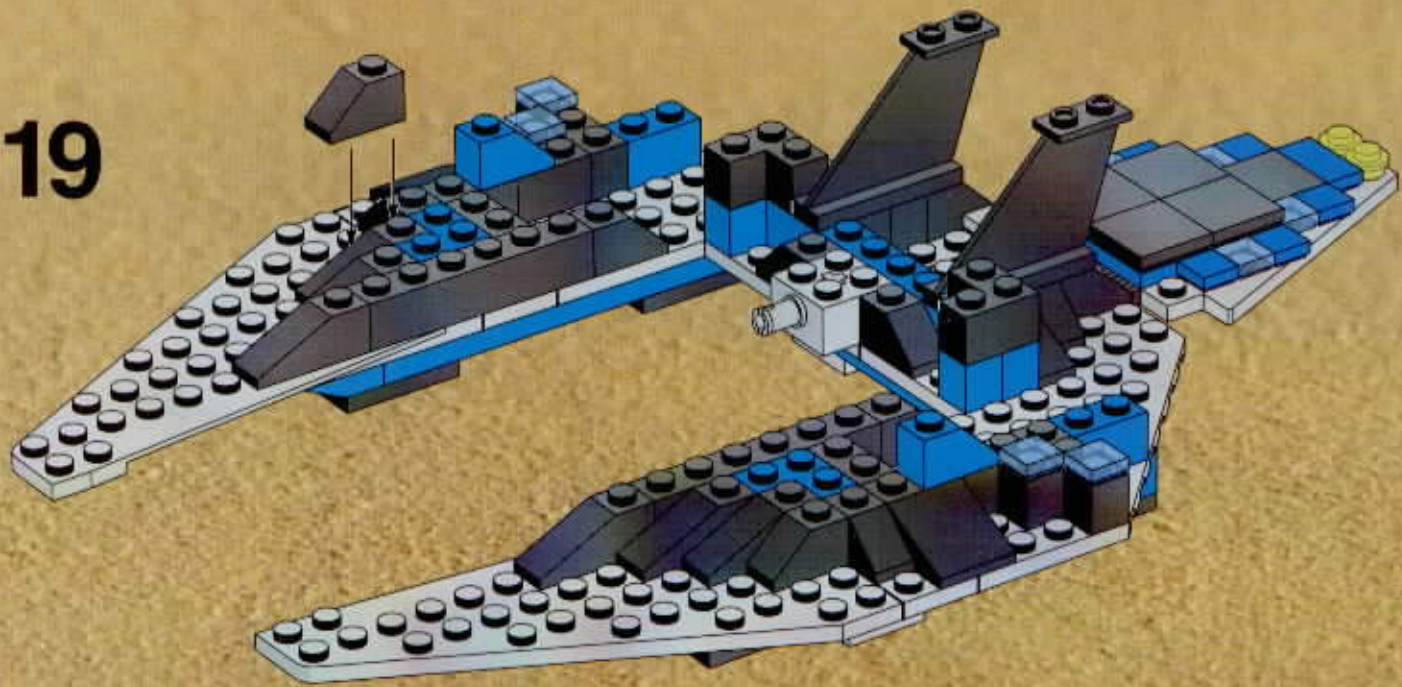

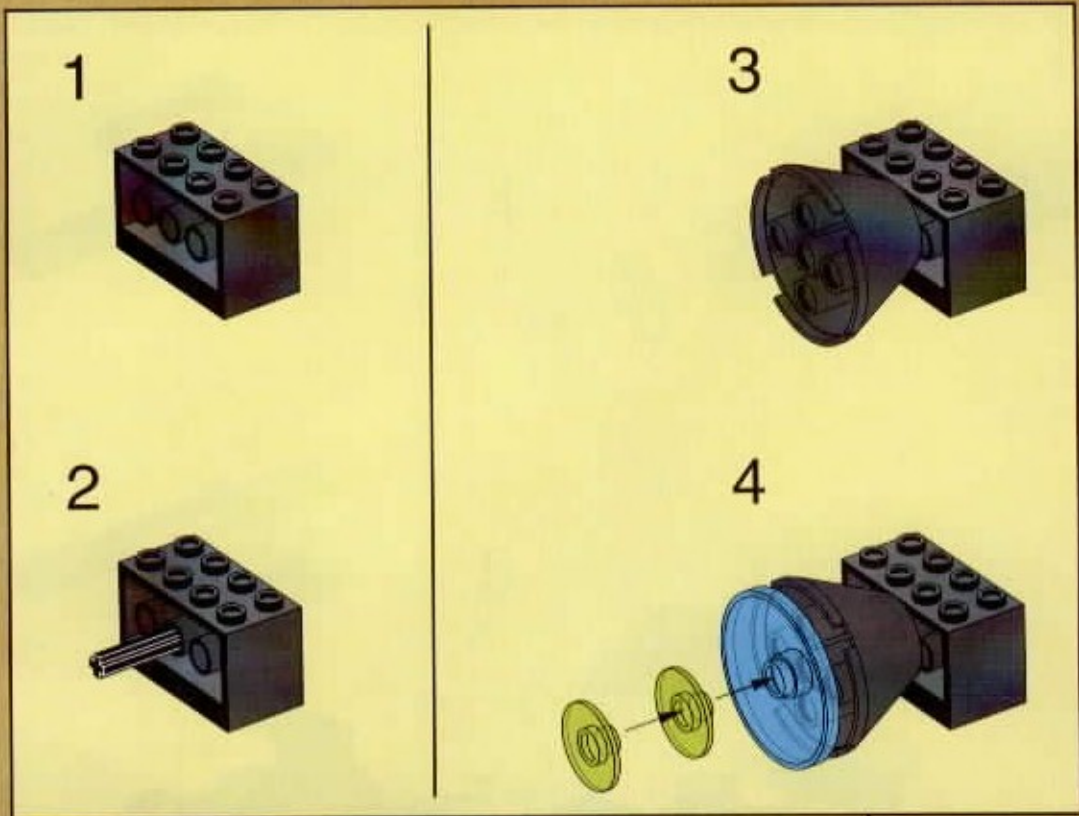

20

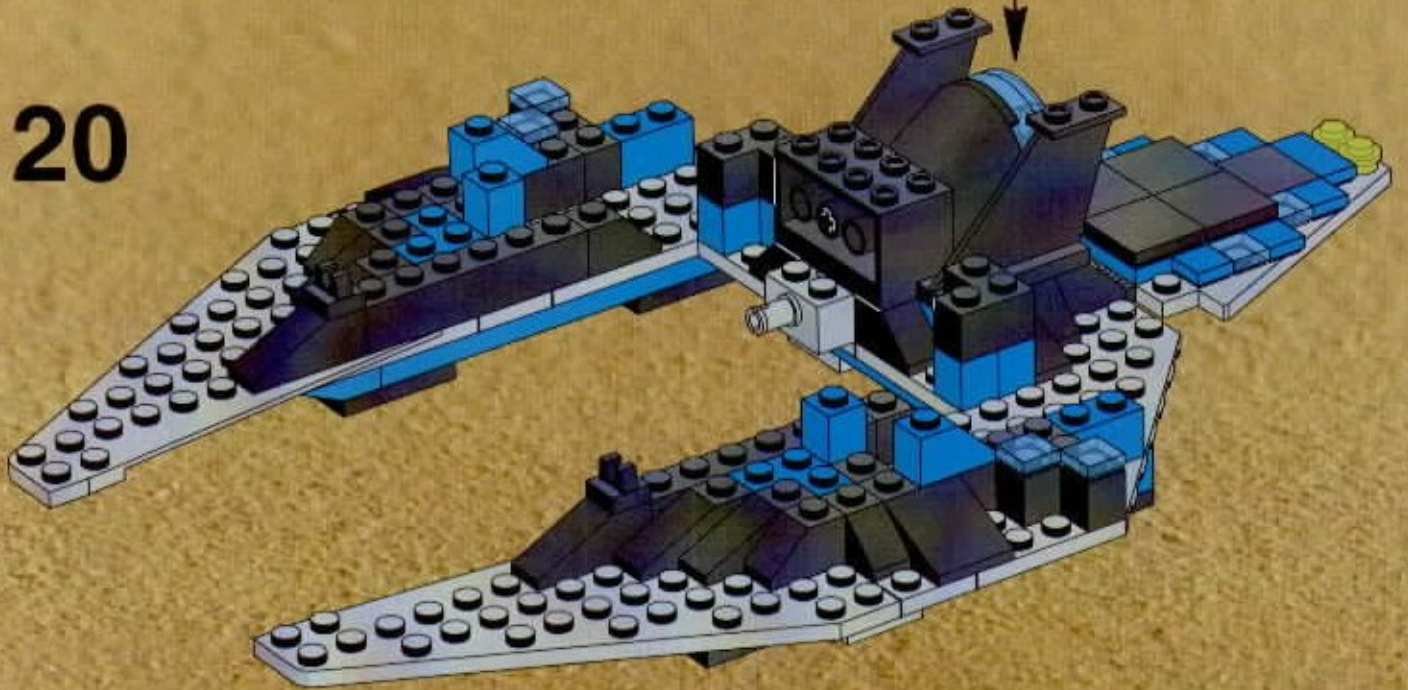

21

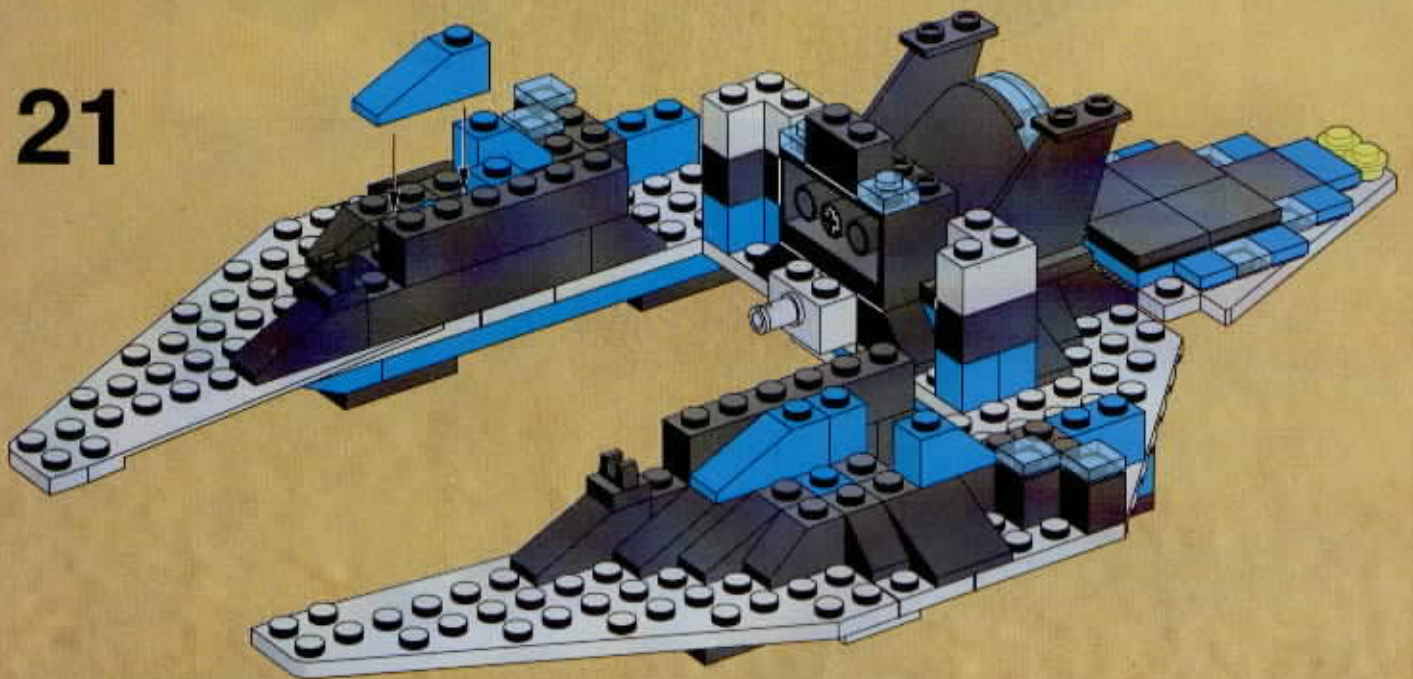

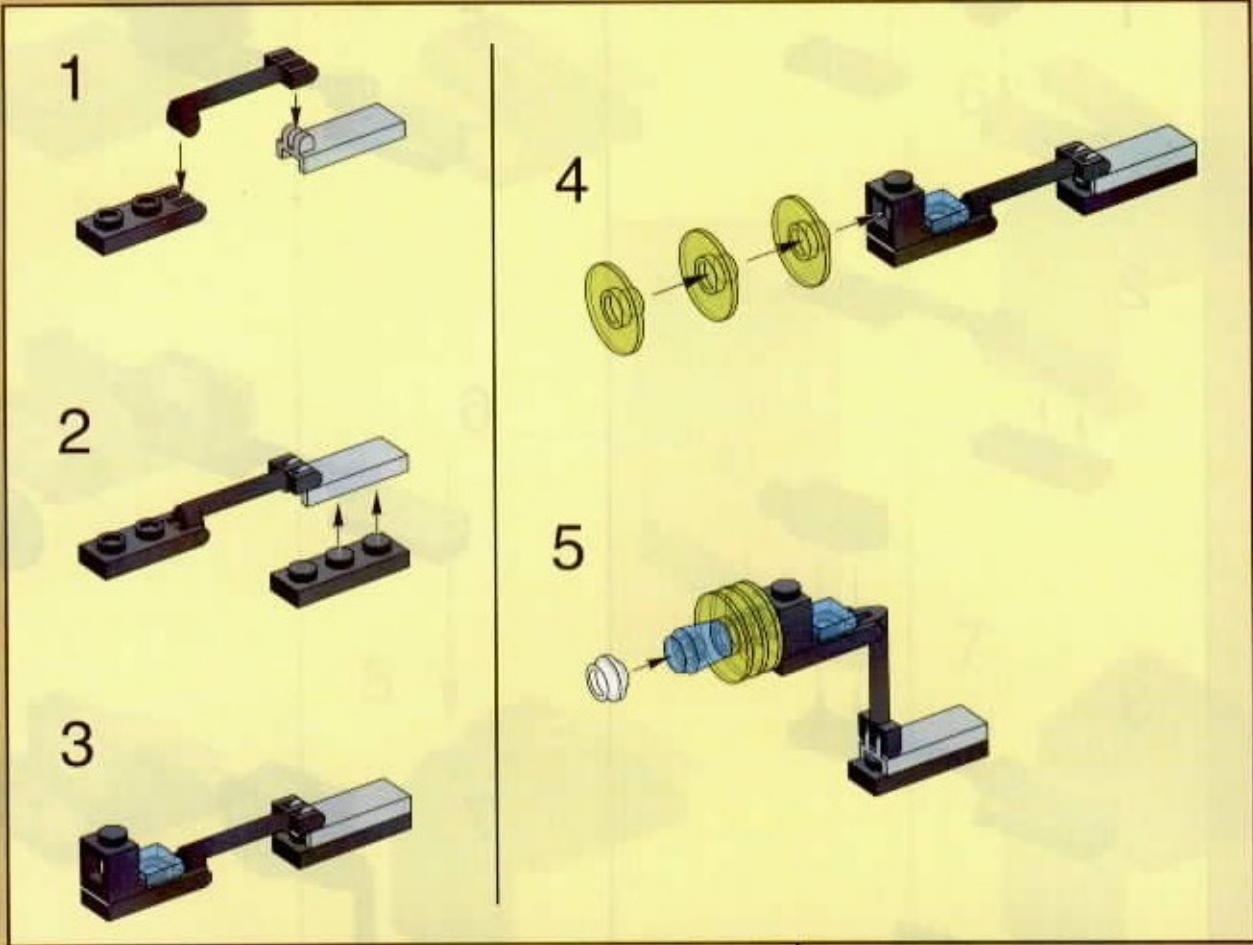

22

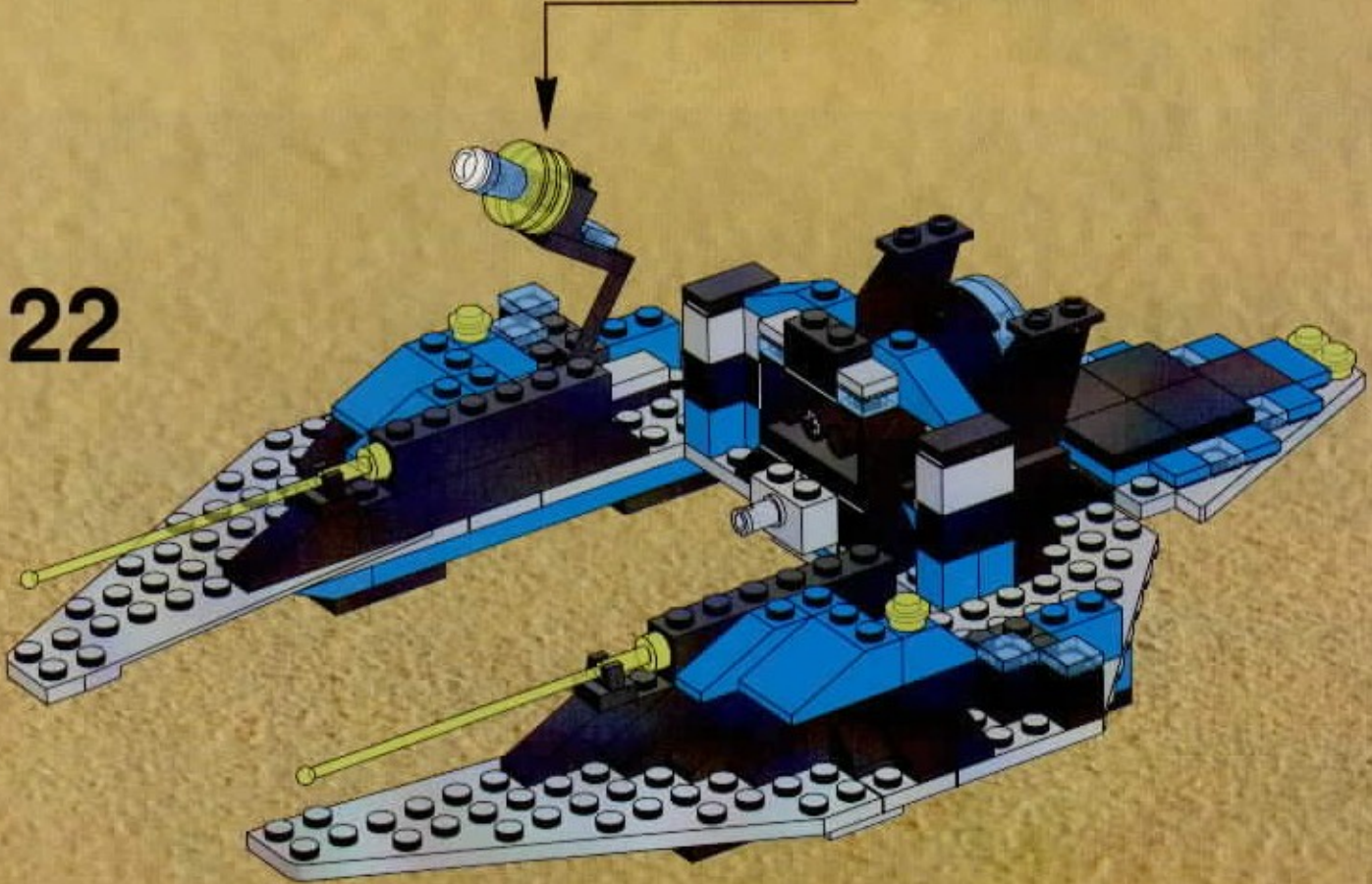

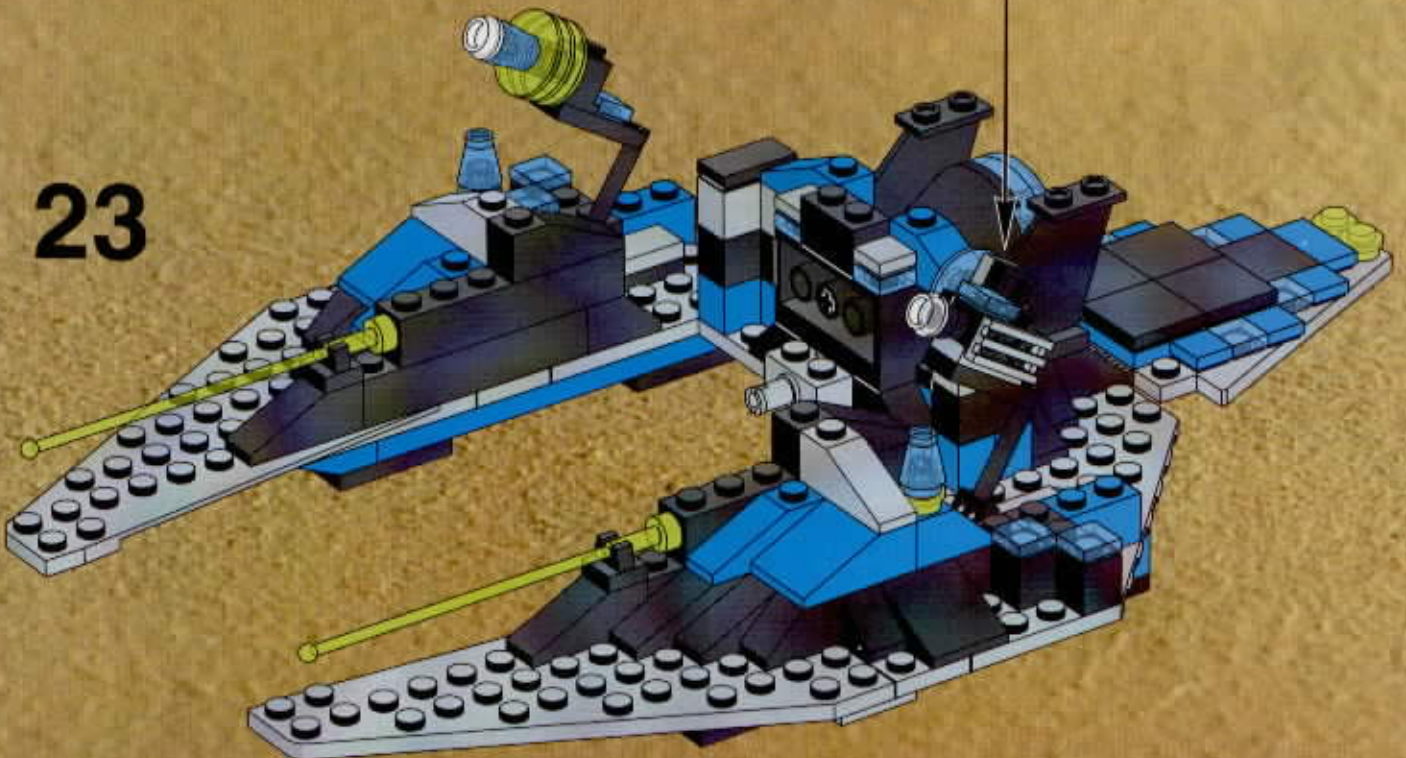
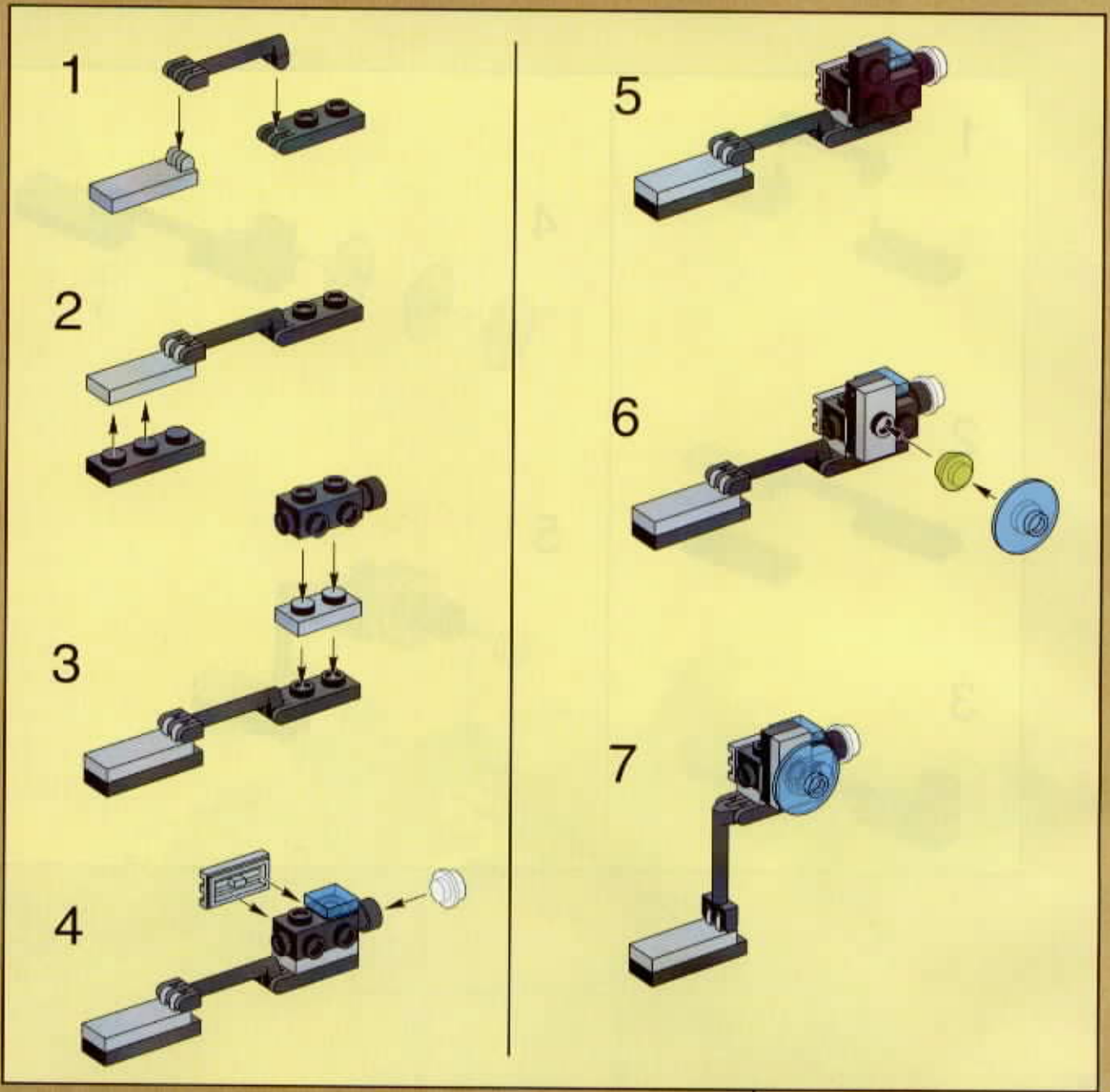



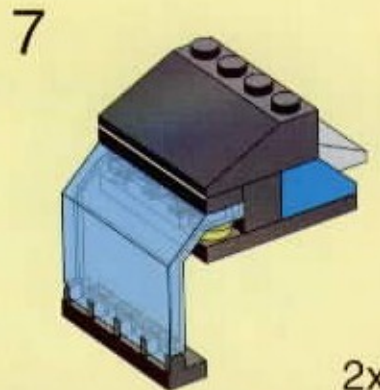
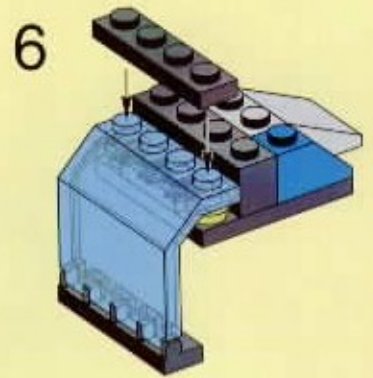
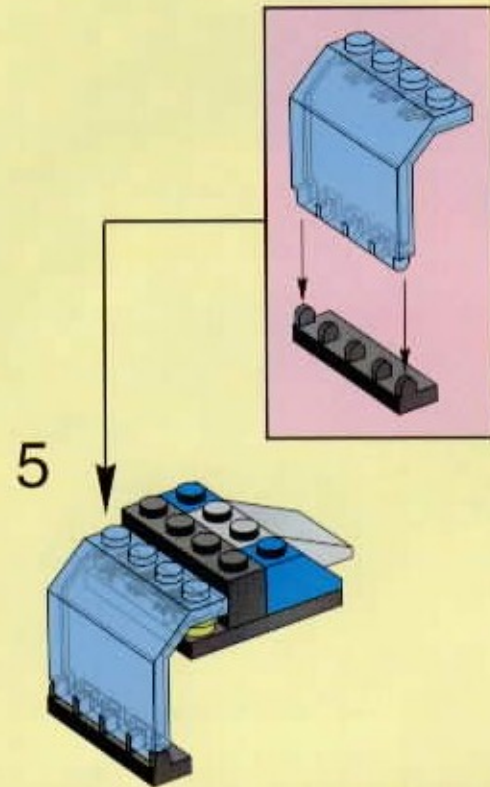
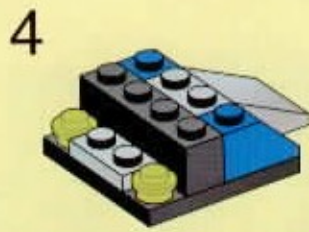
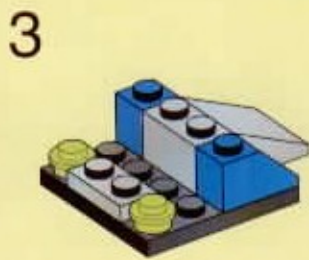
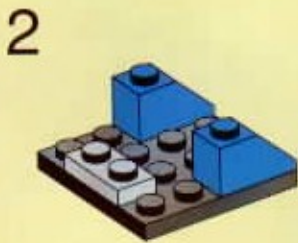

2x

24

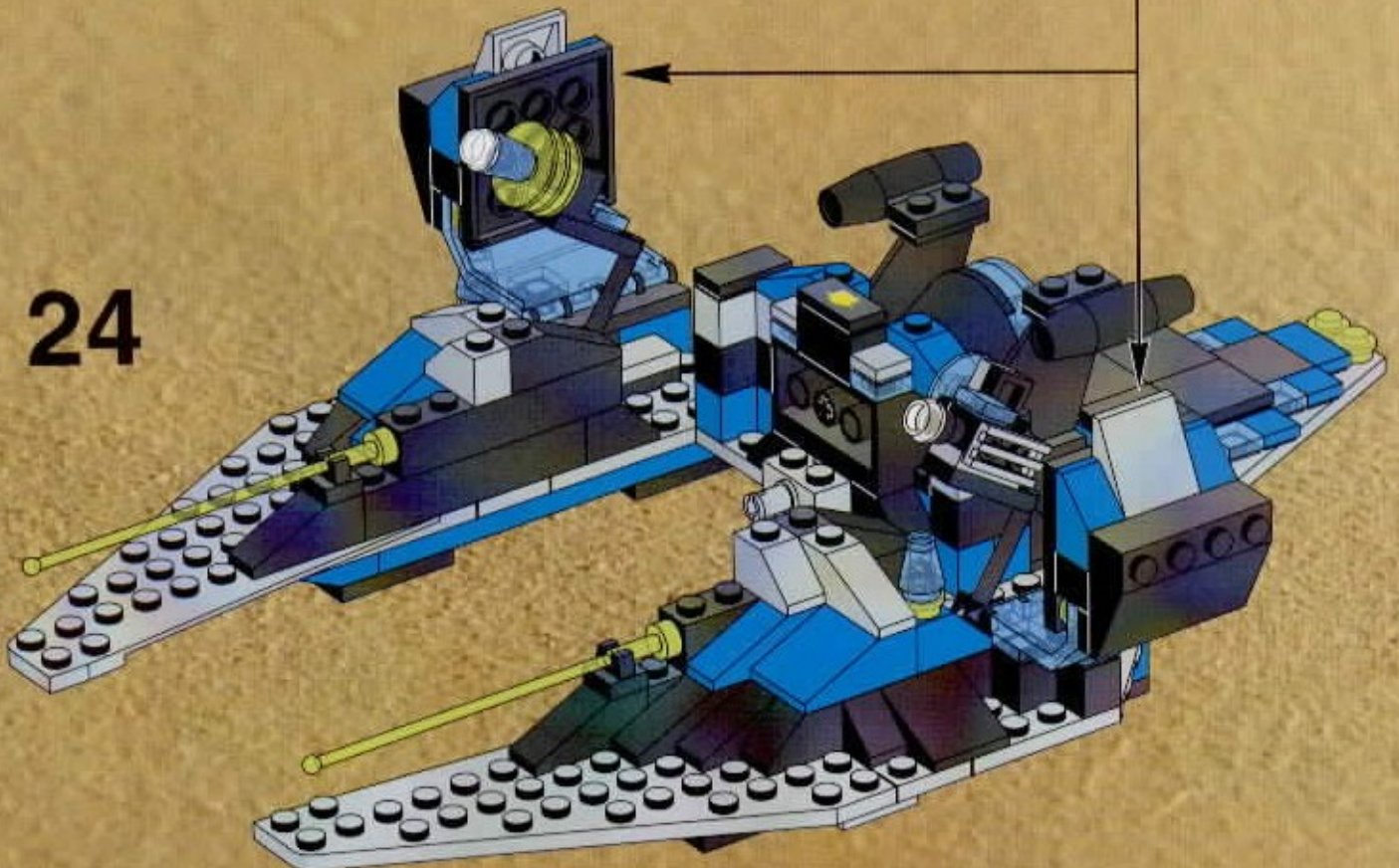

25

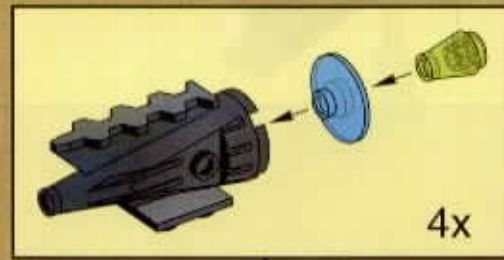
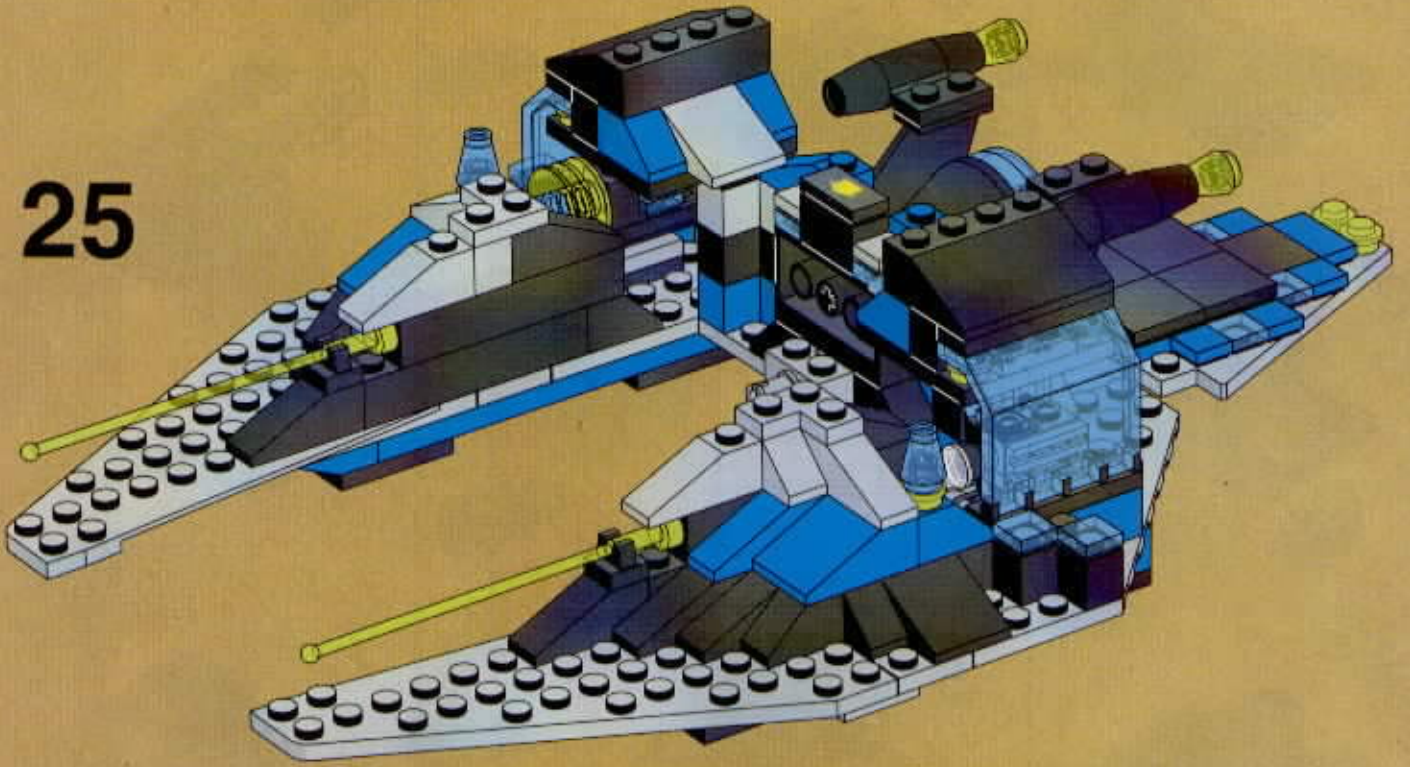

26

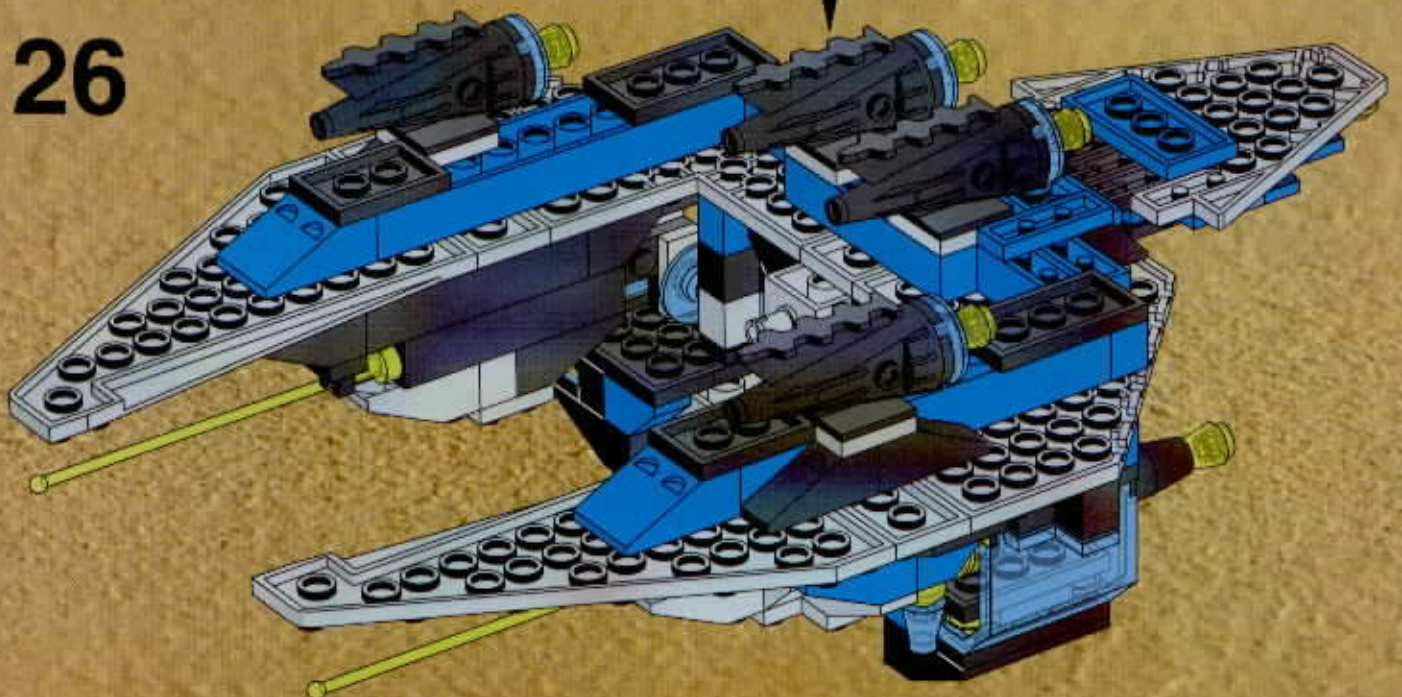

27

