



40574





We're switching from plastic to paper-based packaging. That's why you might find a mix of paper and plastic in our boxes!

Wir stellen von Kunststoffverpackungen auf Verpackungen auf Papierbasis um. Möglicherweise findest du deshalb sowohl Papier als auch Kunststoff in unseren Boxen!

Nous abandonnons progressivement les emballages en plastique au profit d'emballages à base de papier. Il est donc possible que vous trouviez à la fois du papier et du plastique dans nos boîtes !

Stiamo passando dagli imballaggi di plastica a quelli basati su carta. Ecco perché potreste trovare un mix di carta e di plastica nelle nostre confezioni!

Estamos sustituyendo las bolsas de plástico por bolsas con base de papel. ¡Por eso, puede que encuentres una mezcla de papel y de plástico en nuestras cajas!

Estamos a substituir as nossas embalagens de plástico por embalagens à base de papel. Por isso poderá encontrar um misto de papel e plástico nas nossas caixas!

Átállunk a műanyagról a papír alapú csomagolásra. Ezért előfordulhat, hogy a dobozainkban papír és műanyag zacskót egyaránt találasz!

Mēs pārejam no plastmasas iepakojuma uz iepakojumu, kurā izmantots papīrs. Tāpēc mūsu kārbās var būt gan papīra, gan plastmasas daļas.

Trecem de la ambalajele din material plastic la ambalaje pe bază de hârtie. Iată de ce s-ar putea să găsești un amestec de hârtie și material plastic în cutiile noastre!

我们正在从塑料包装向纸基包装过渡。这就是为什么你可能会发现我们的包装盒中同时出现塑料和纸质材料！

[LEGO.com/sustainable-packaging](https://www.lego.com/sustainable-packaging)

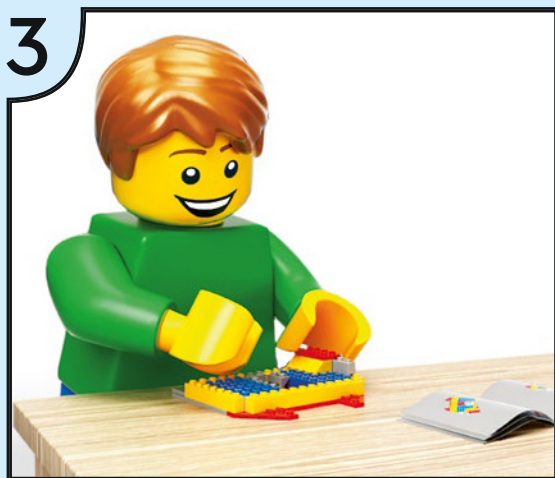

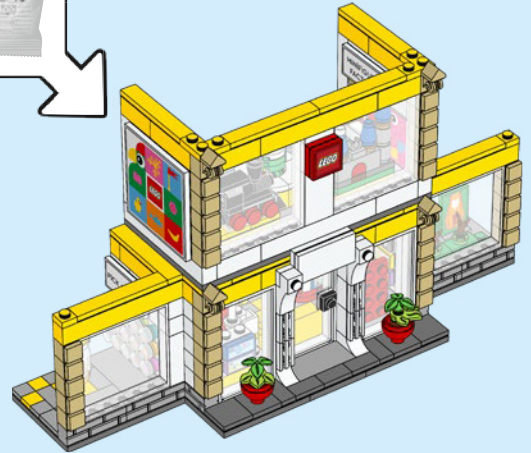
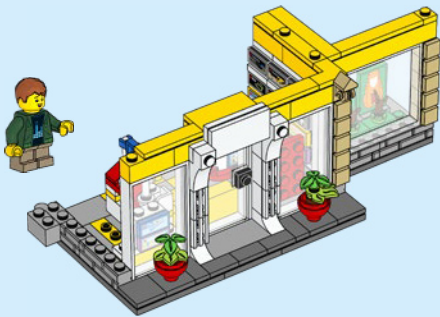
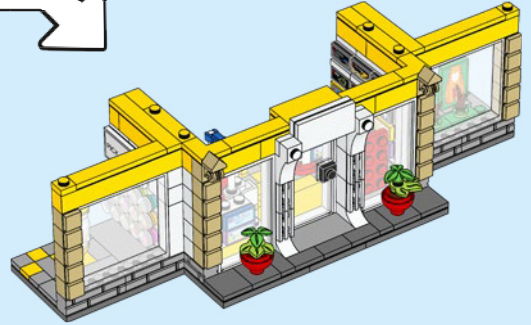
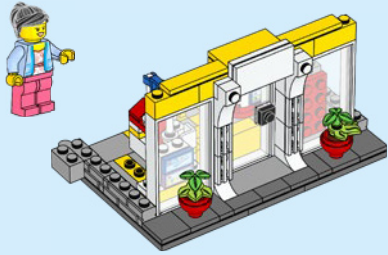

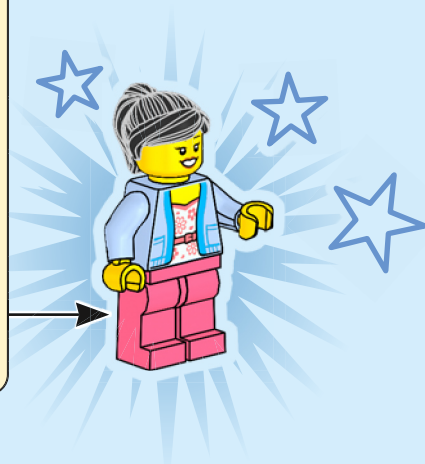
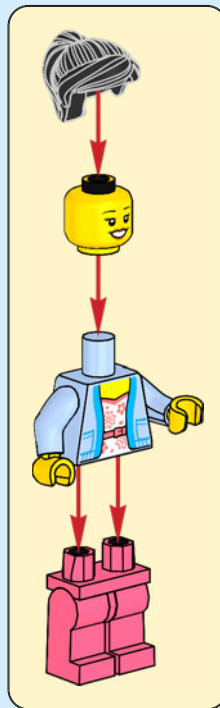

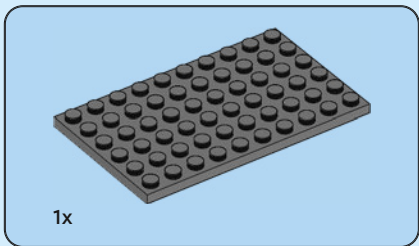

1x

1

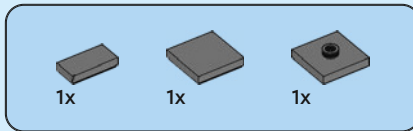
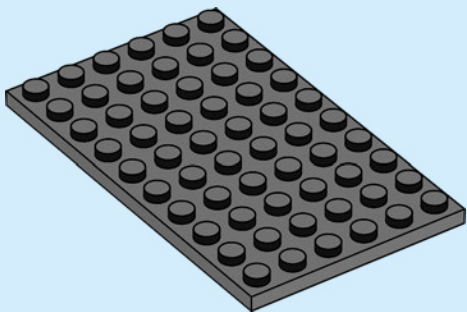

2

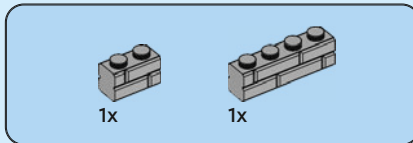
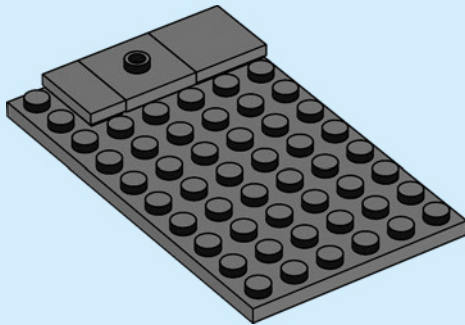

3

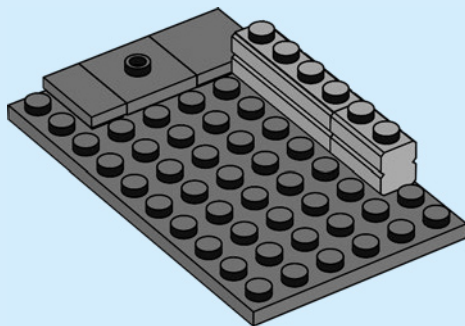

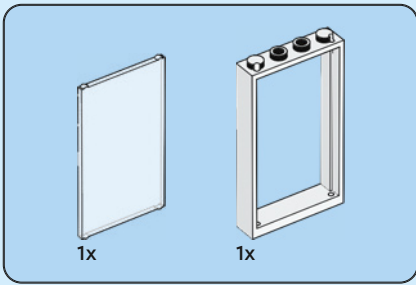

4

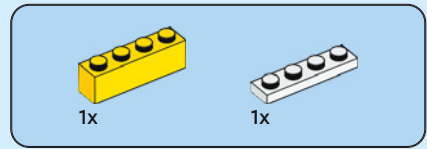
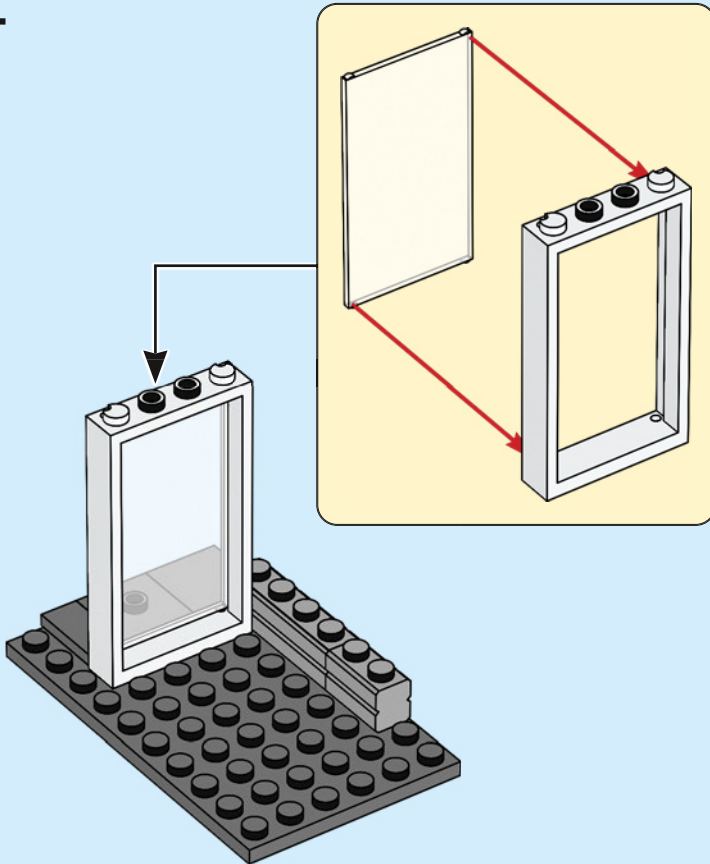

5

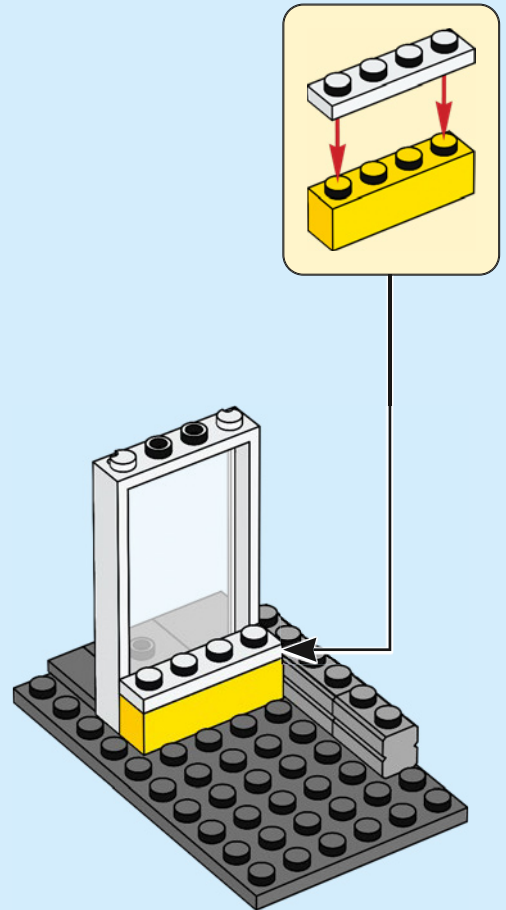

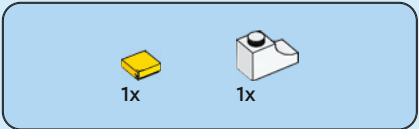

6

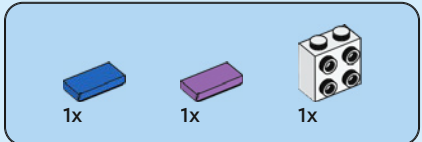
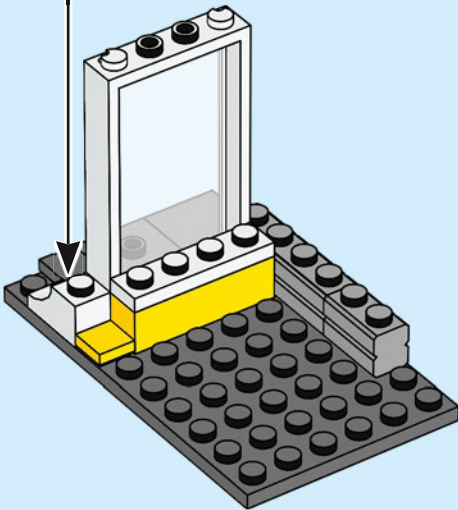
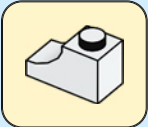

7

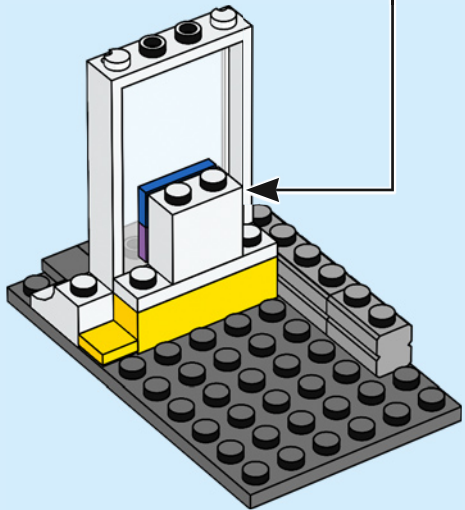
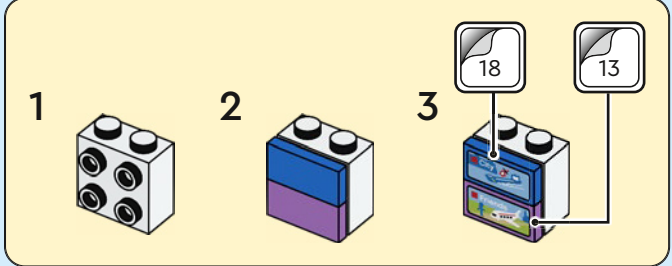

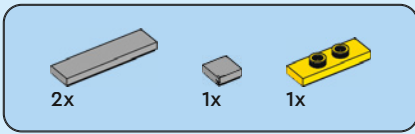

8

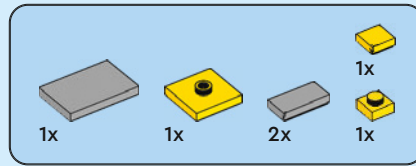
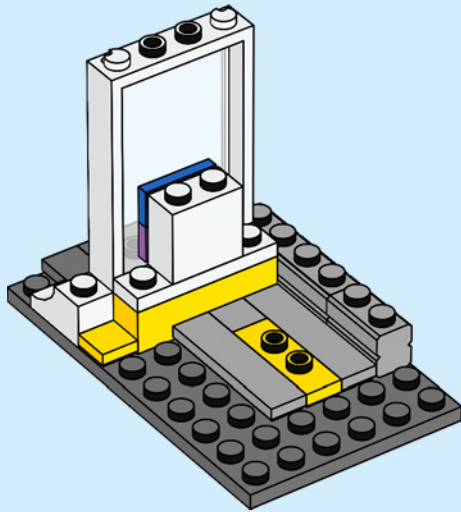

9

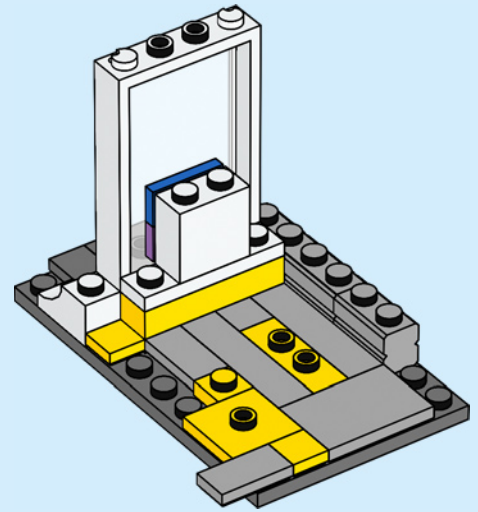

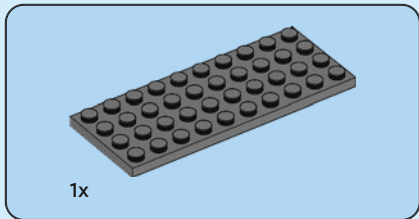

10

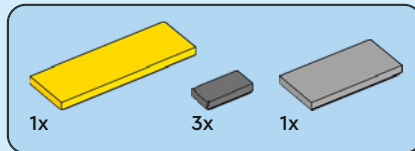
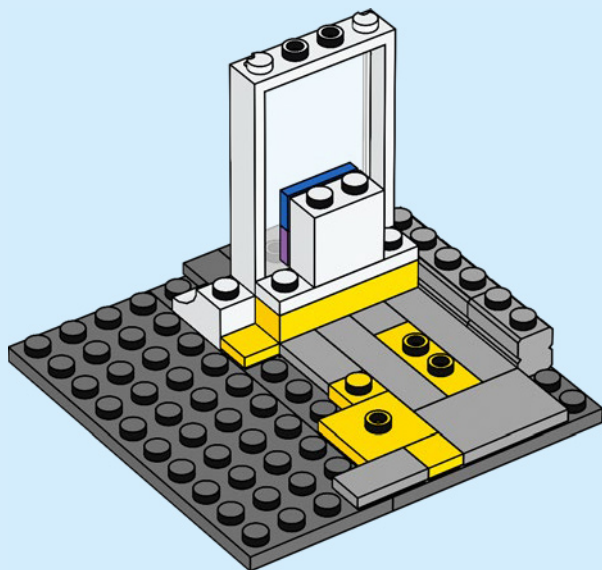

11

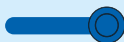
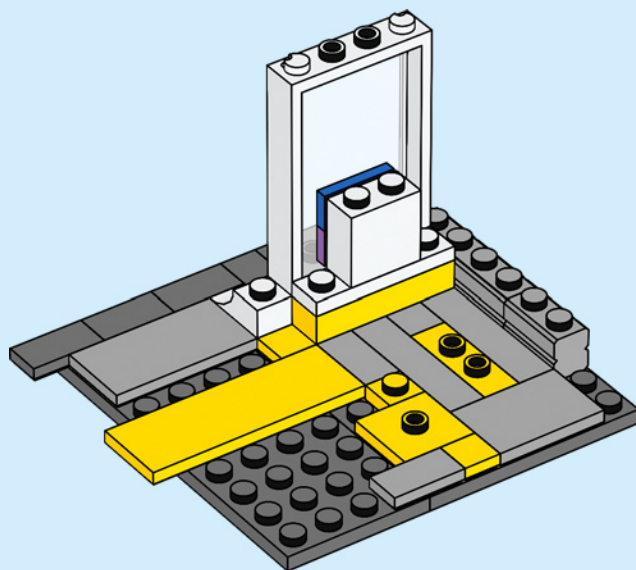

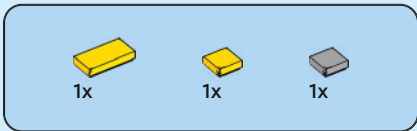

12

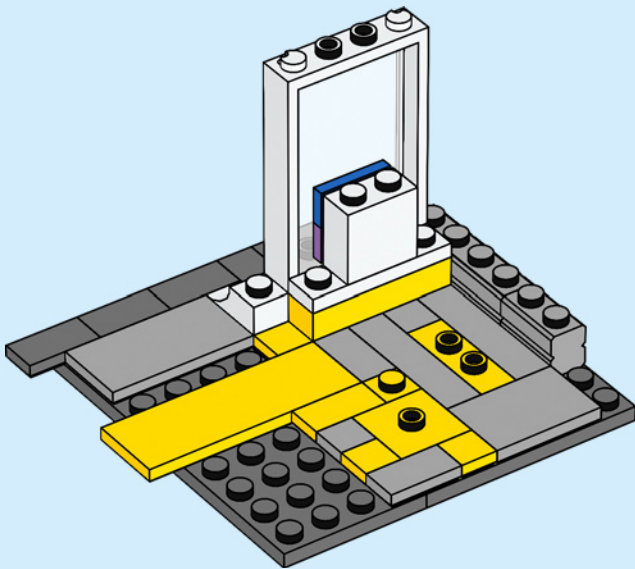

13

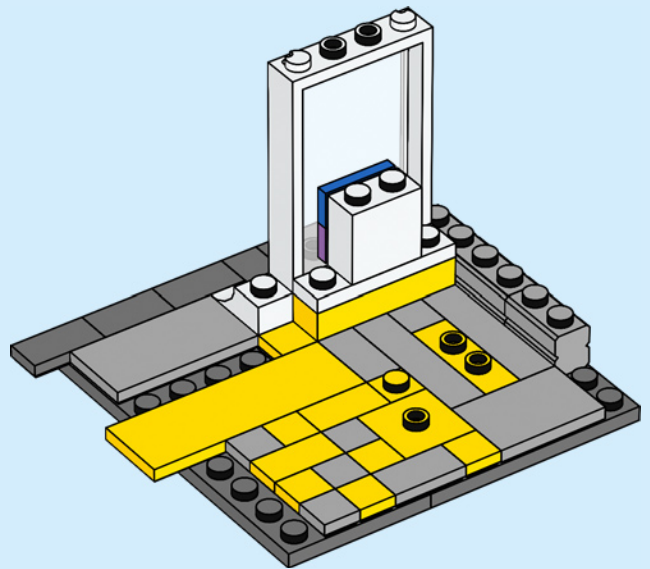

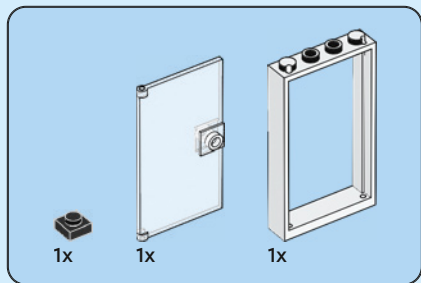

14

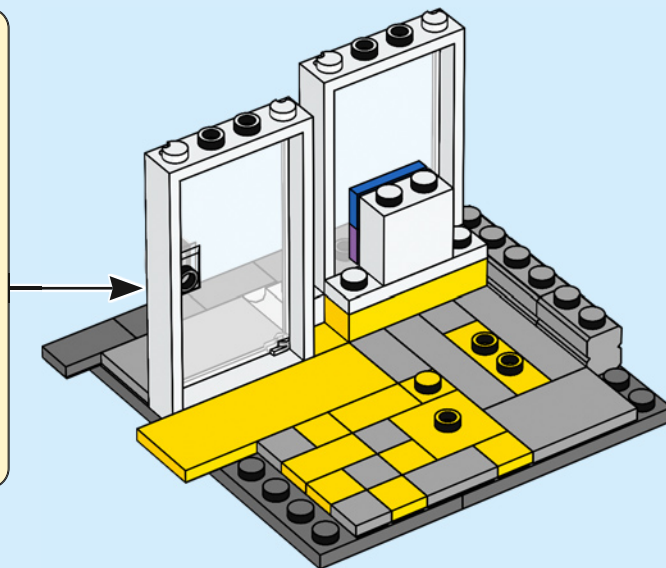
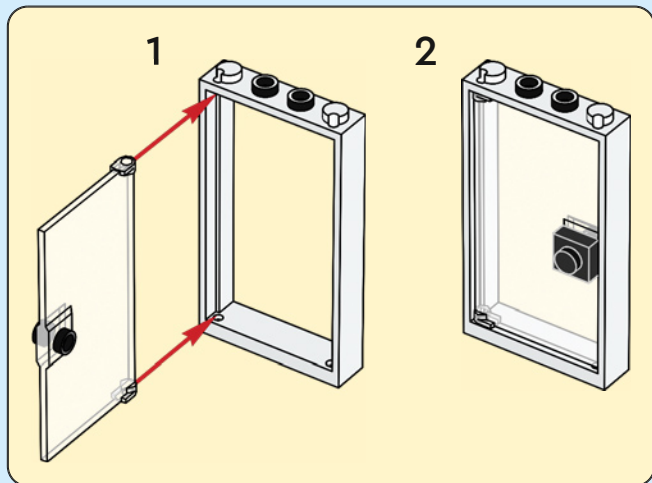

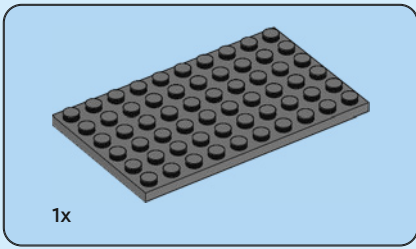

15

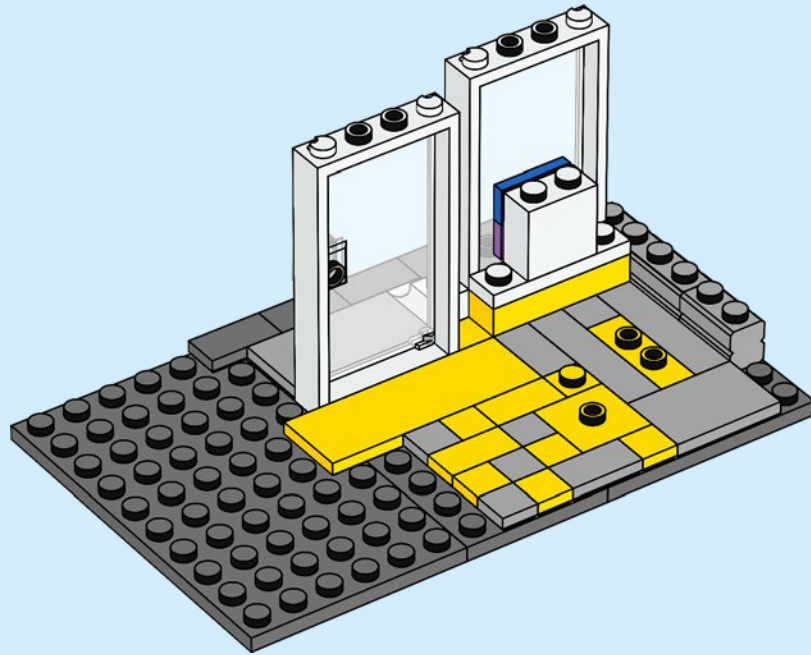

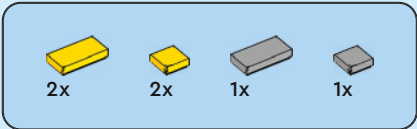

17

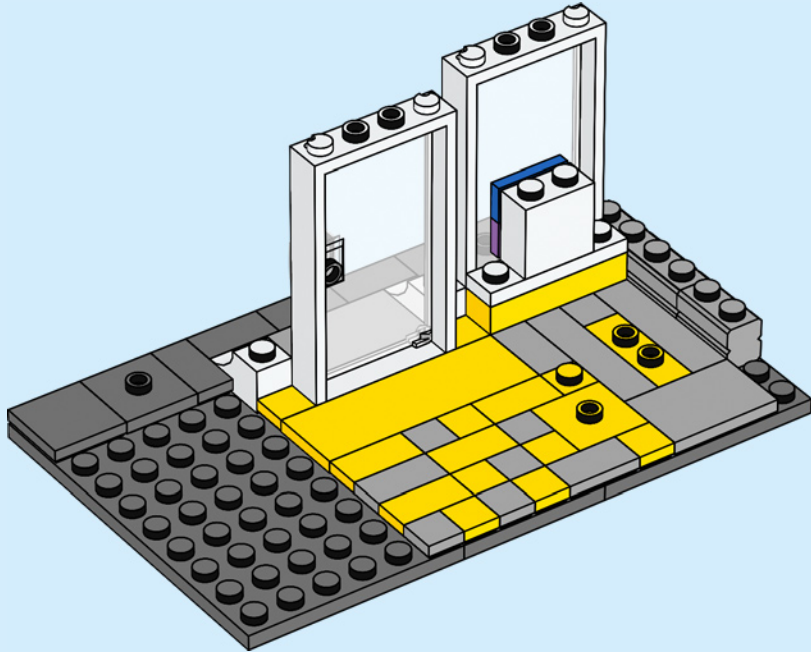

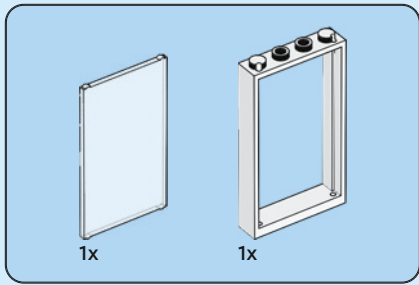

18

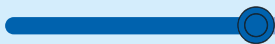
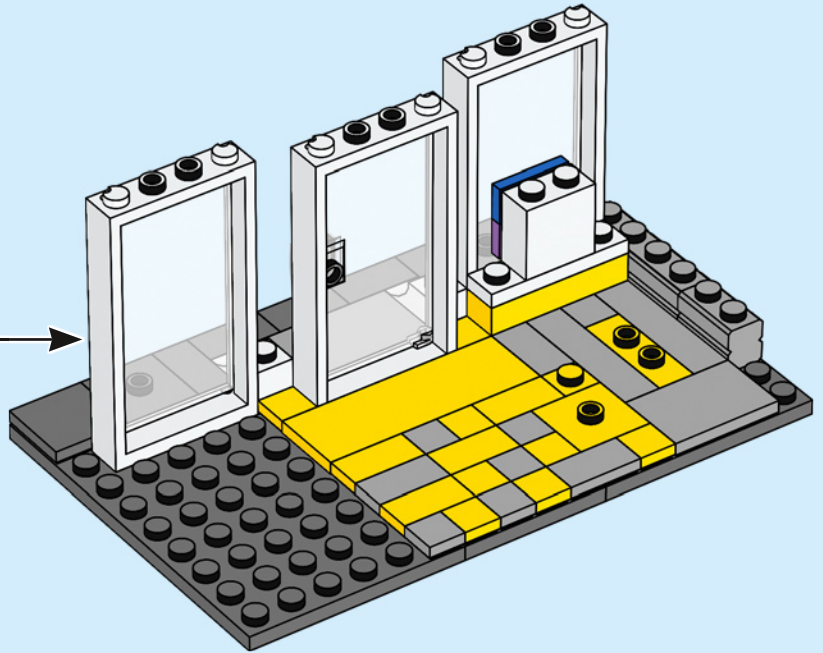
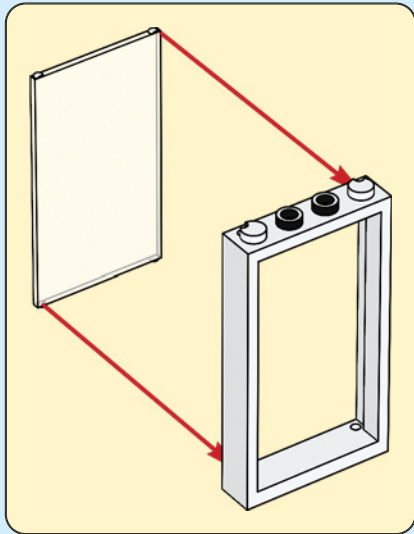

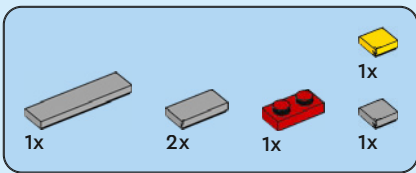

19

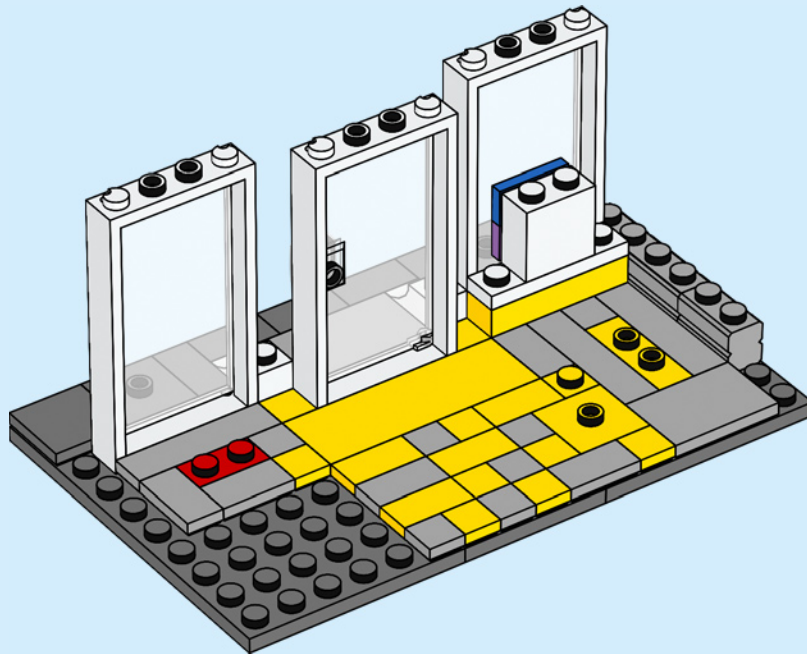

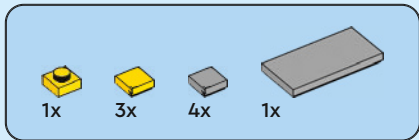

20

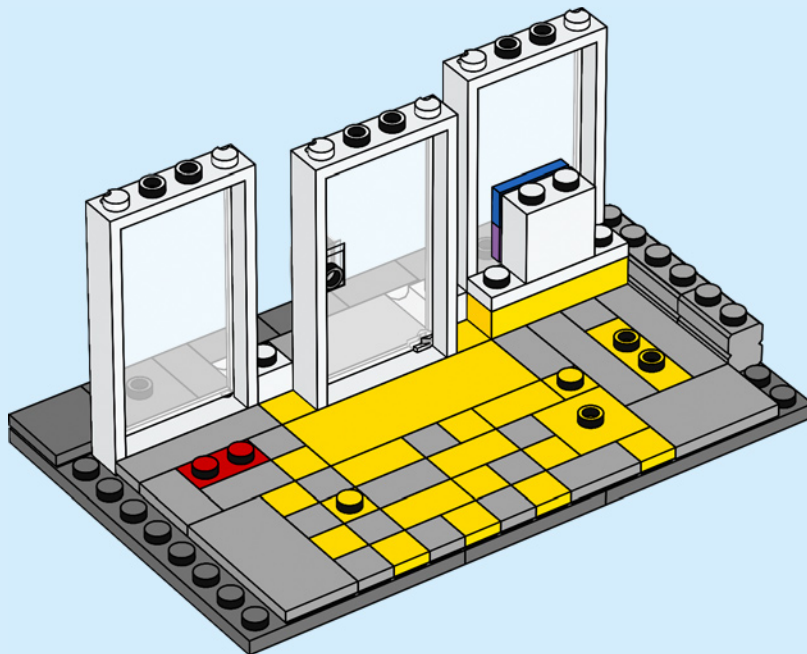

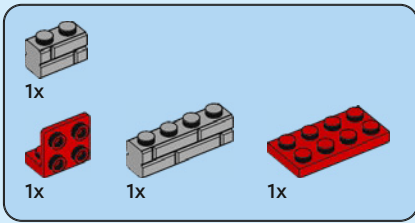

21

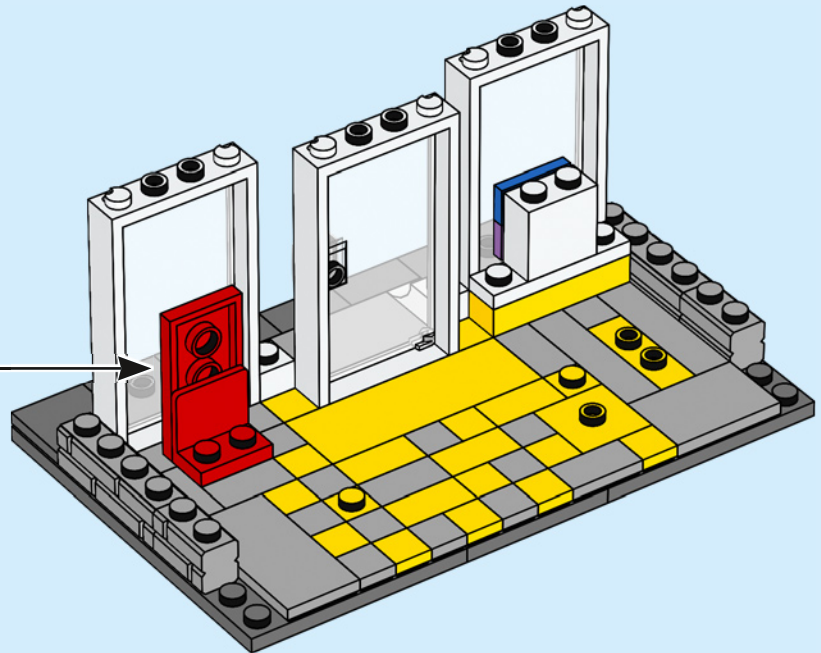
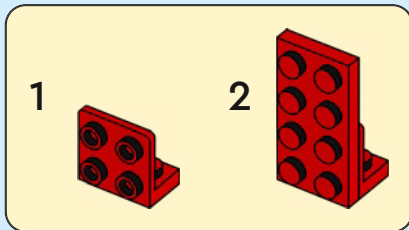

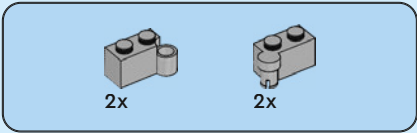

22

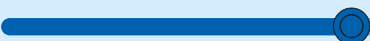
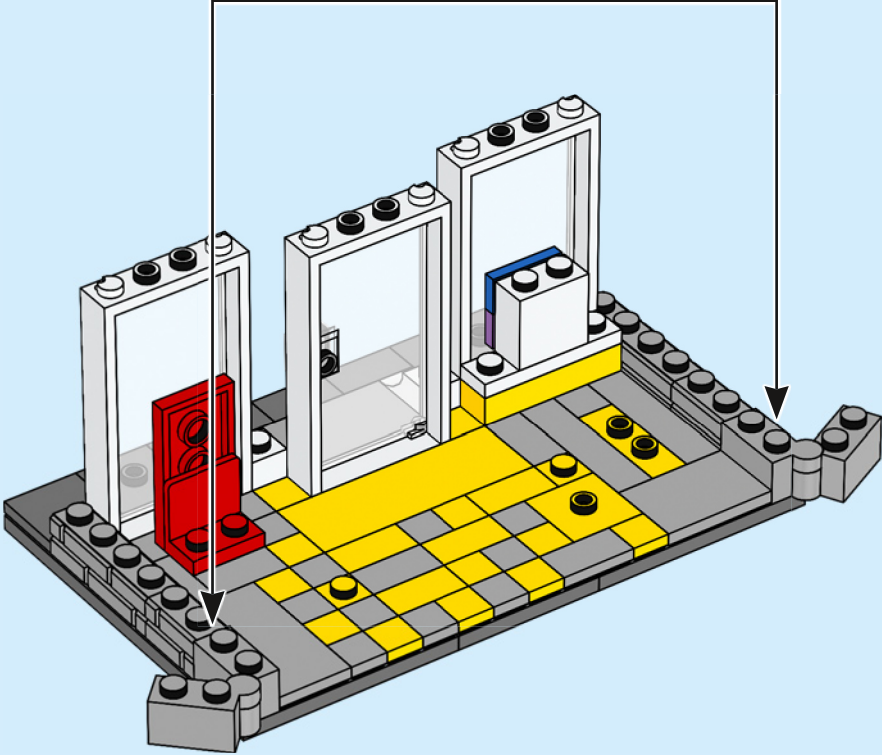
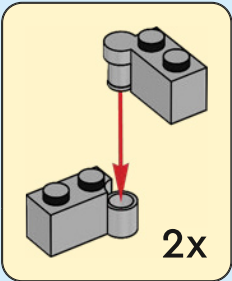

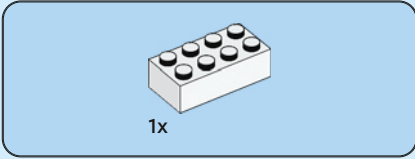
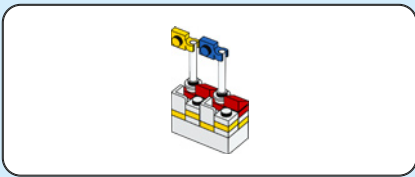

23

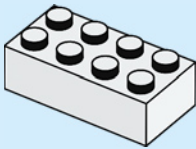

24

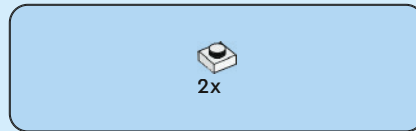
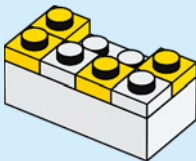

25

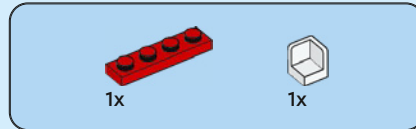
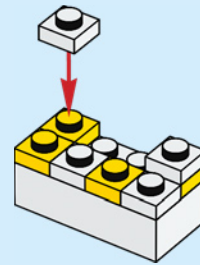

26

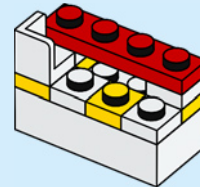



1x



1x

27

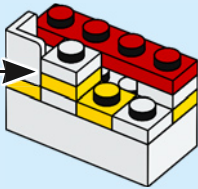
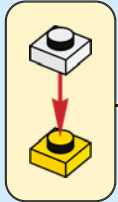

2x



2x

28

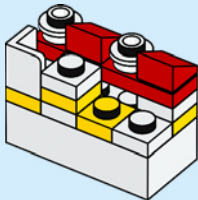

1x



1x



1x

29

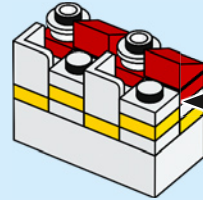
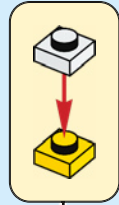

2x



1x



1x

30

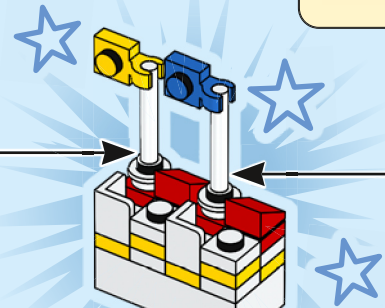
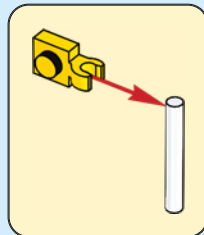
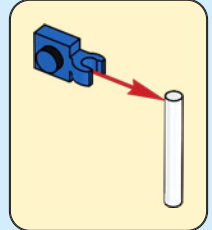

31

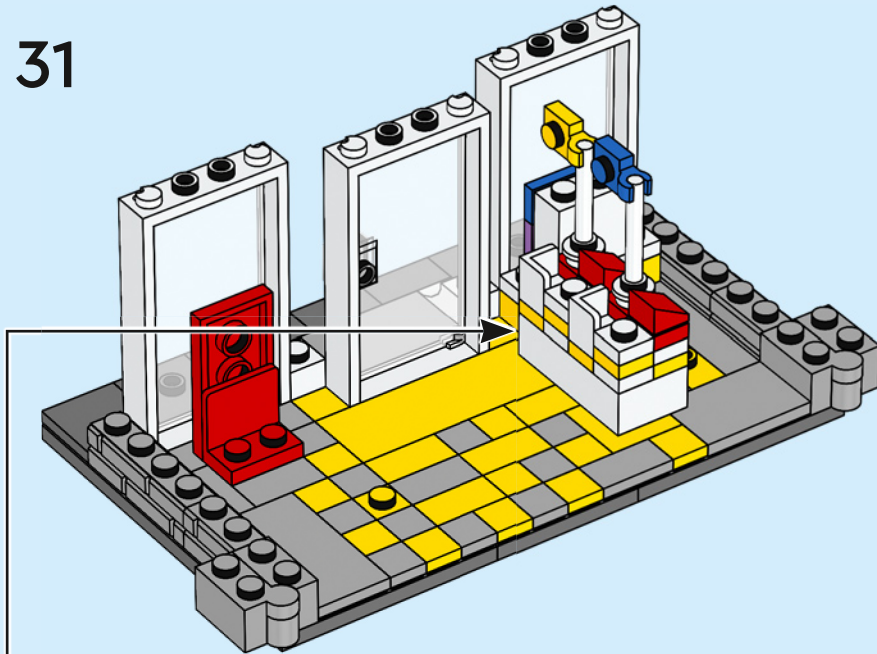

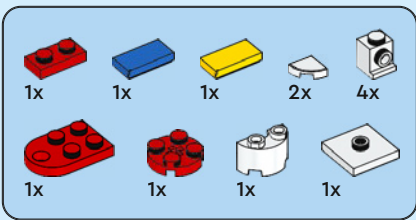

32

1



2

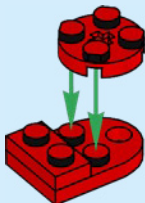

3

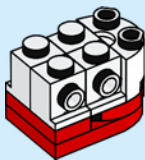

4

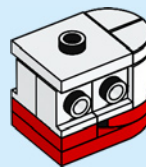

1

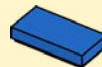

2



1



2



5



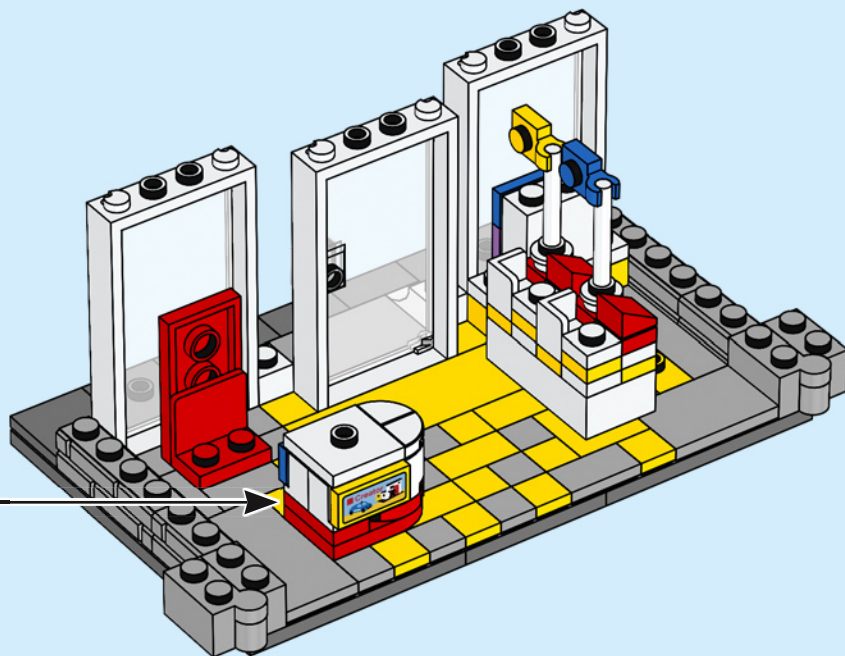

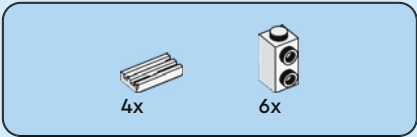

33

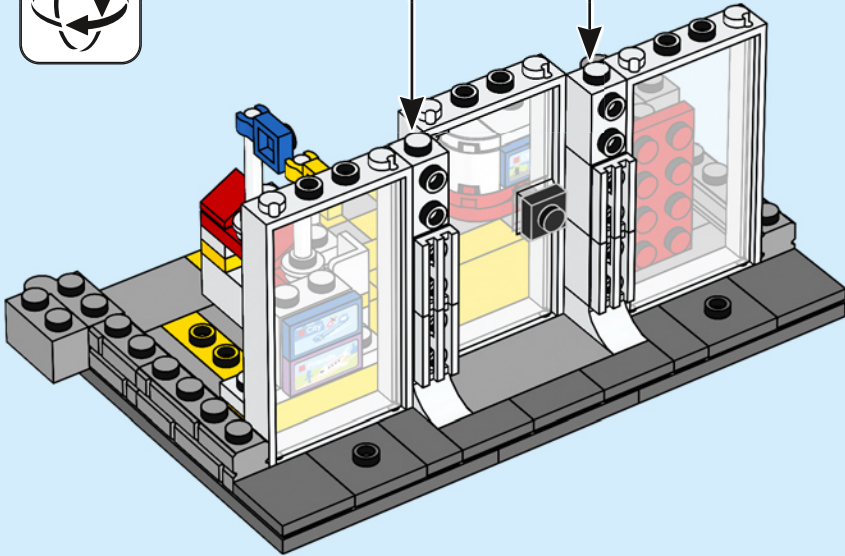
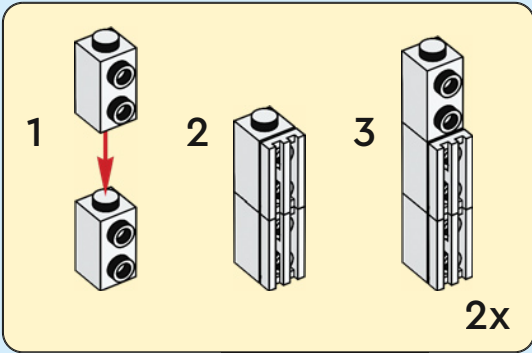

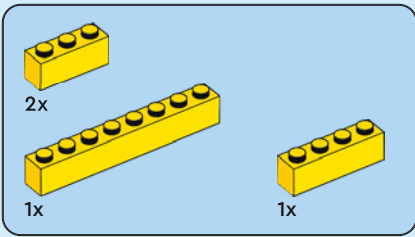

34

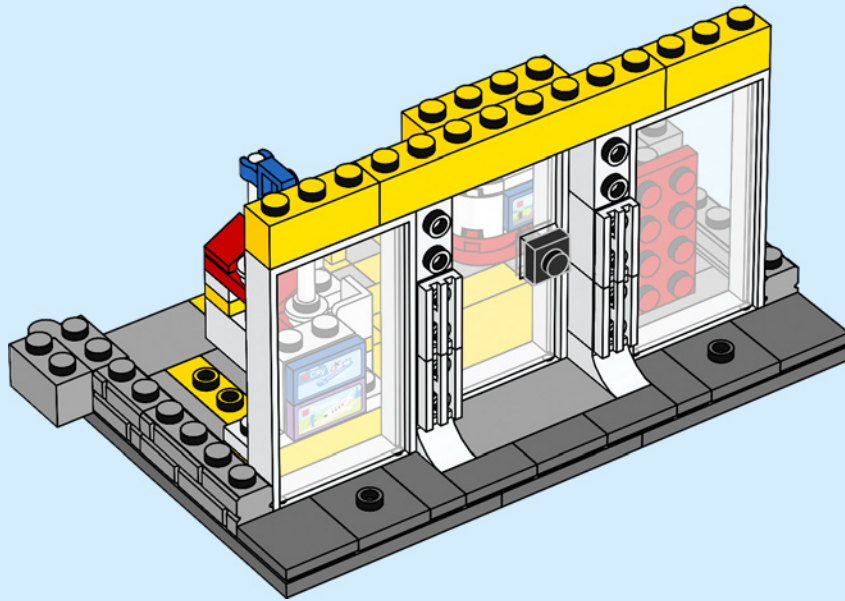

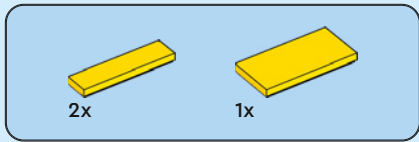

35

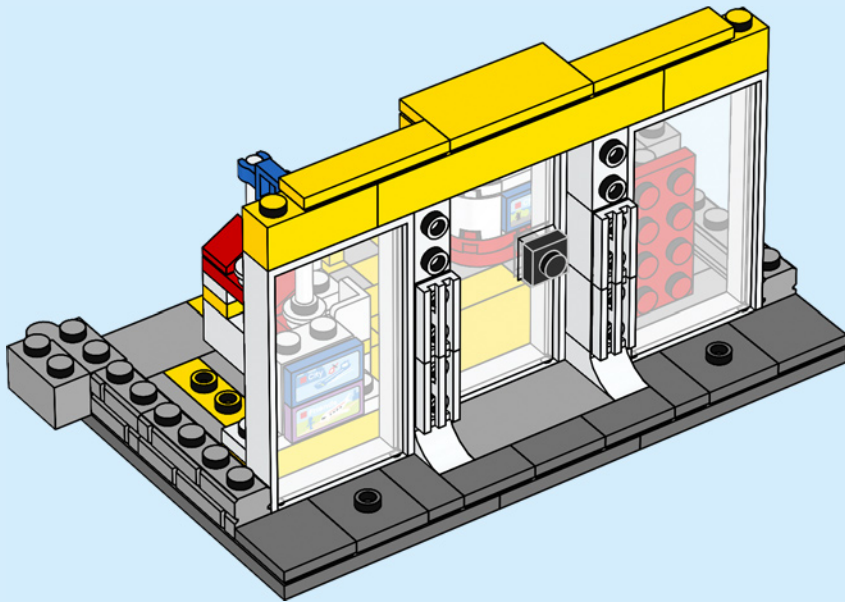

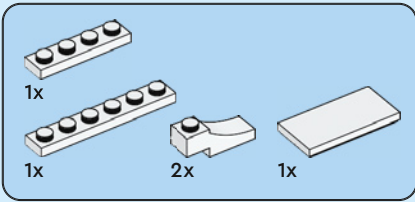

36

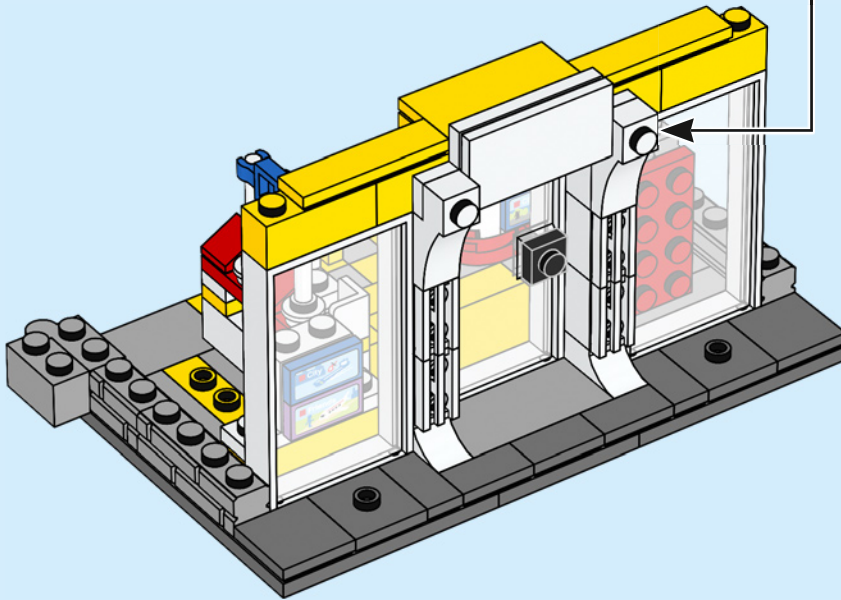
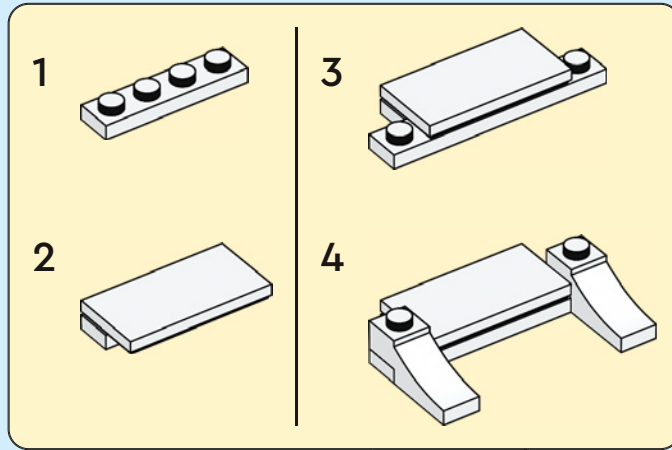

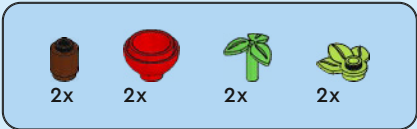

37

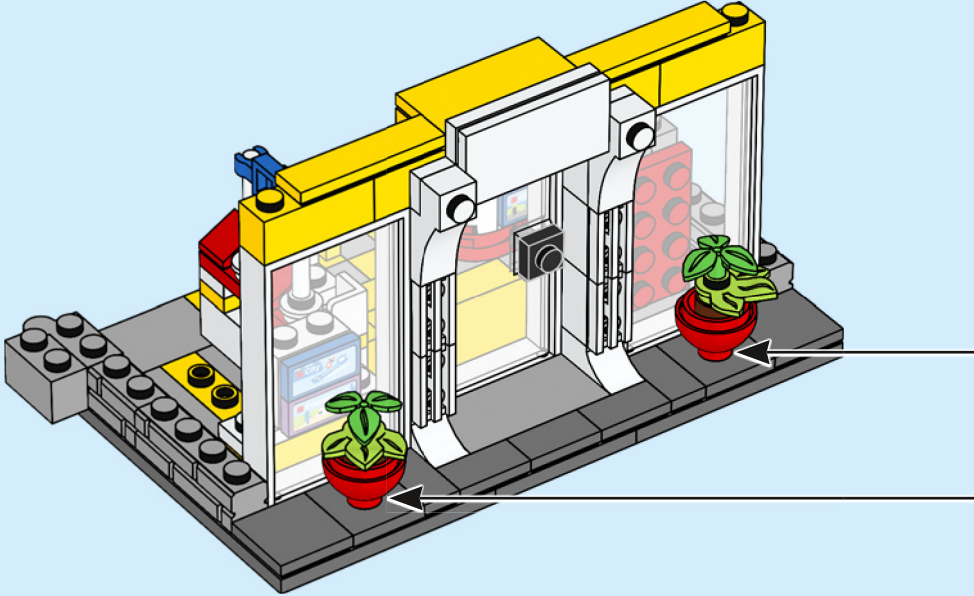
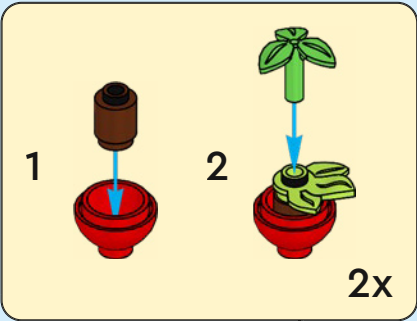

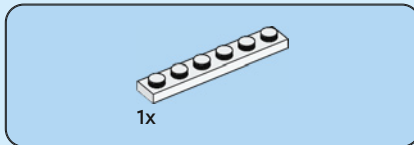
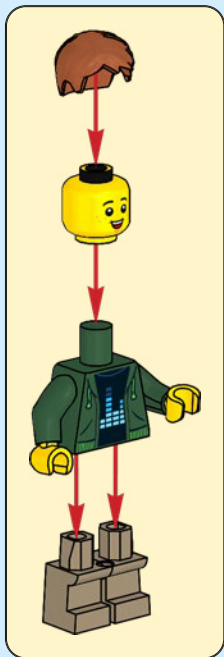

38

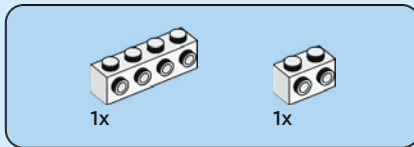
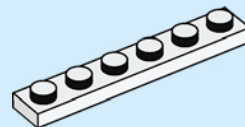

39

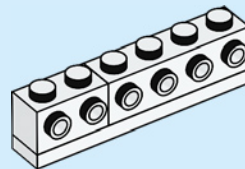



3x

40

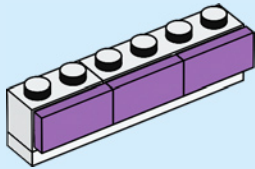

1x



2x

42

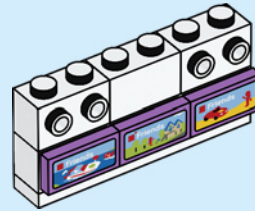

2x

41

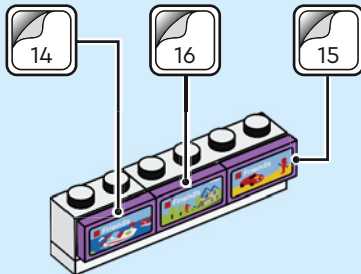

43



44

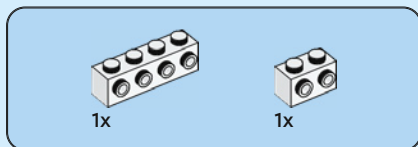
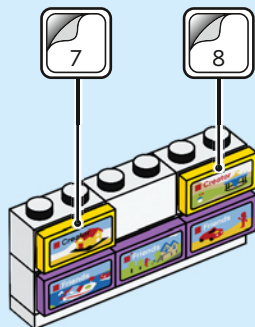

45

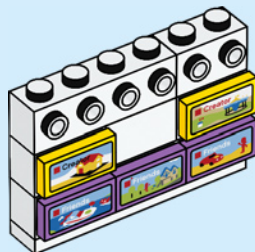

46

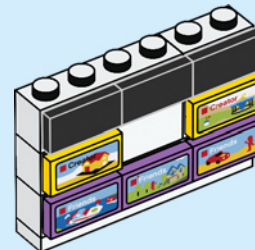
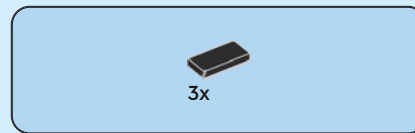

47

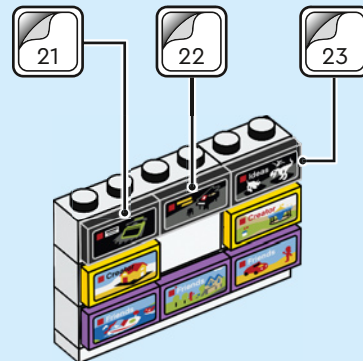



3x

48



1x



1x

49



3x

50



51



52



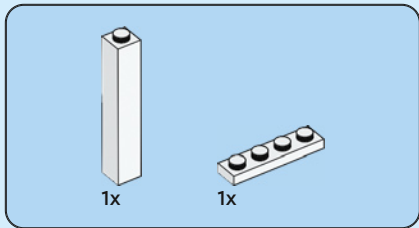

53

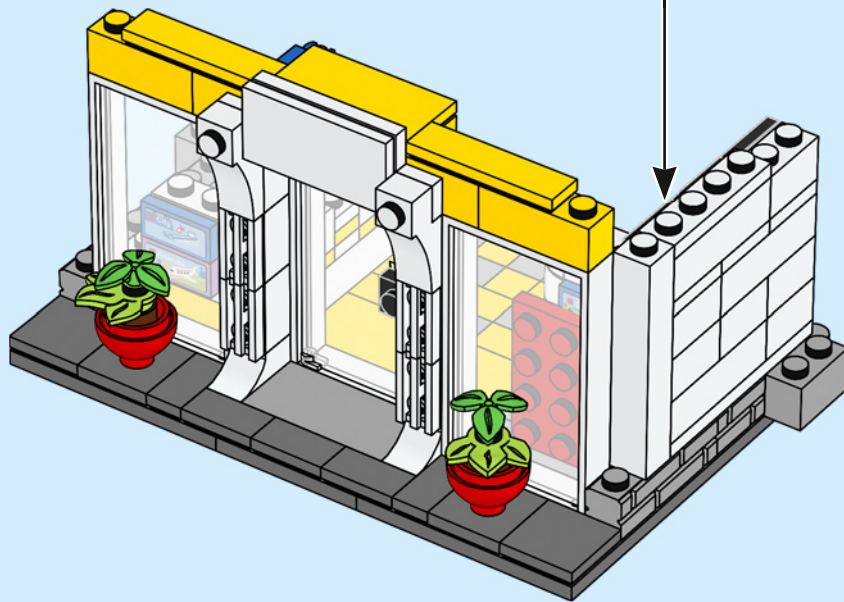
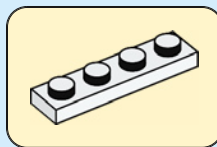

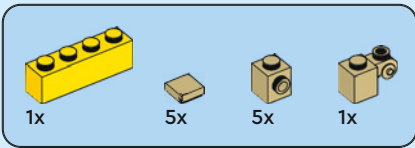

54

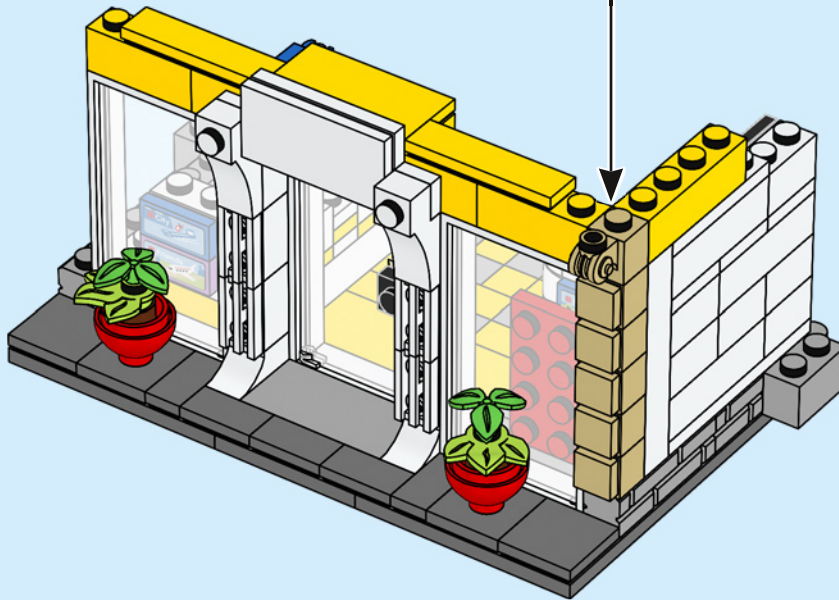
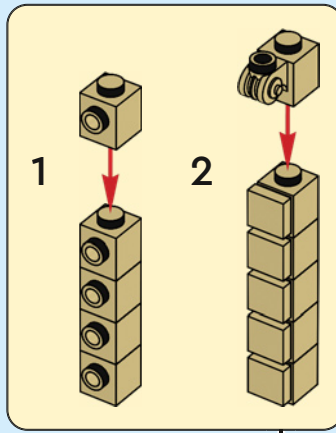



1x

55

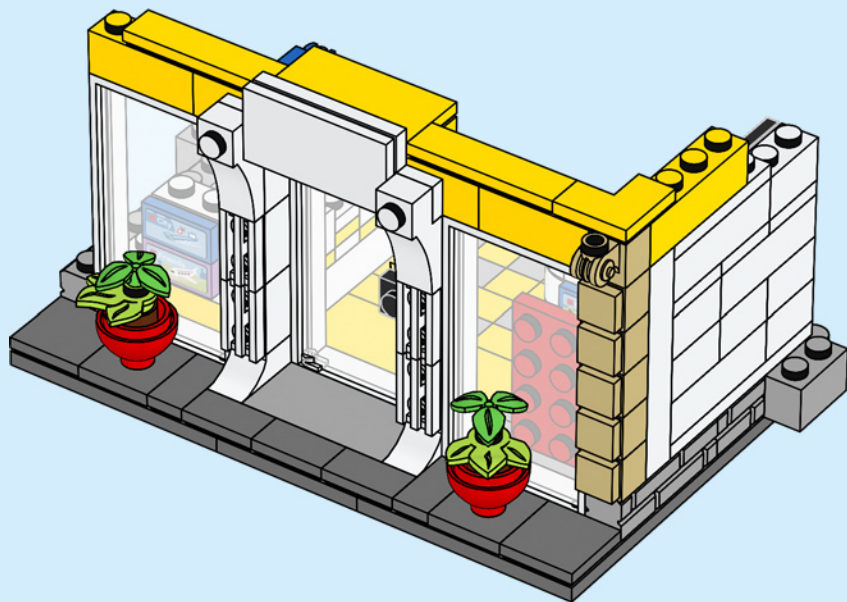

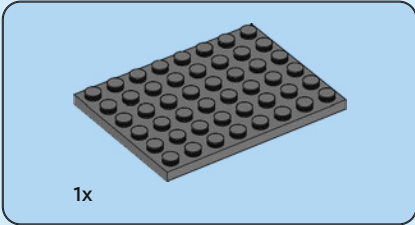
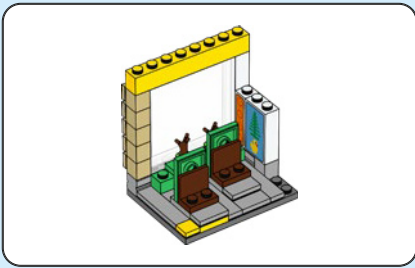

1x

56

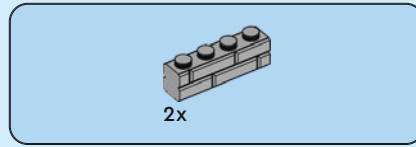
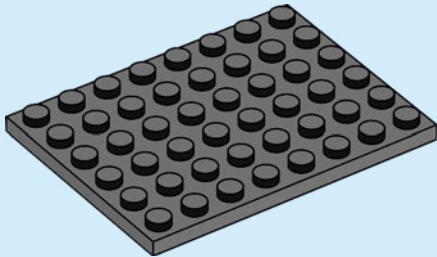

2x

57

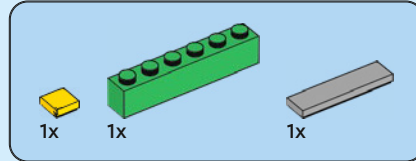
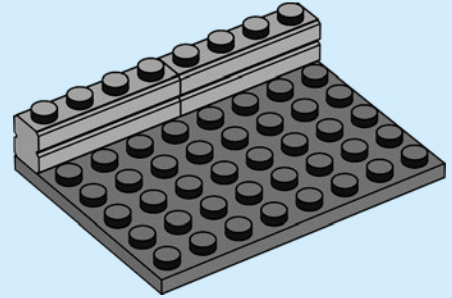

1x

1x

1x

58

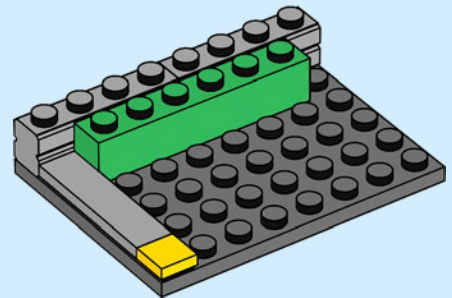

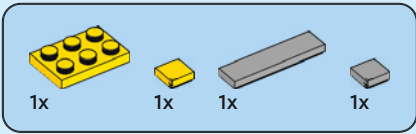

59

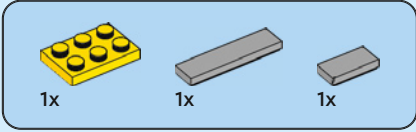
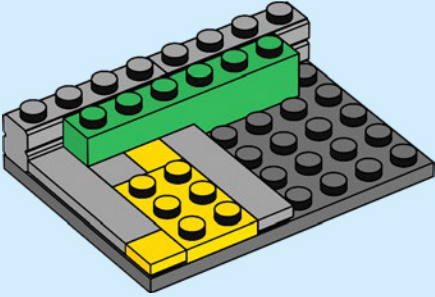

60

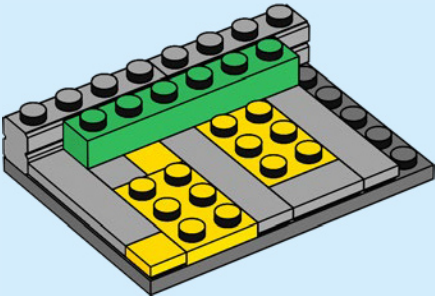

61

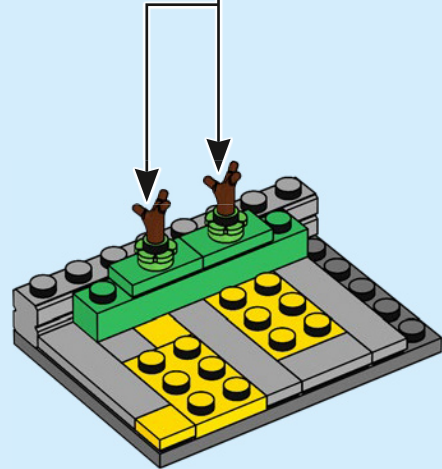
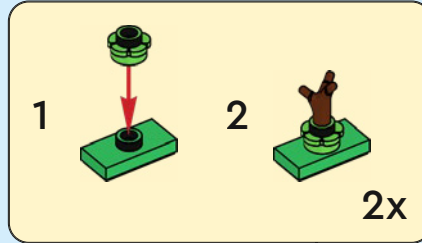



1x



1x

62

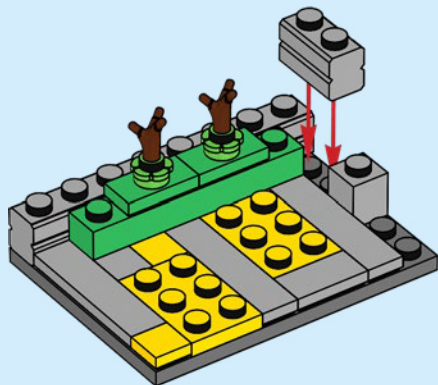

2x



2x

63

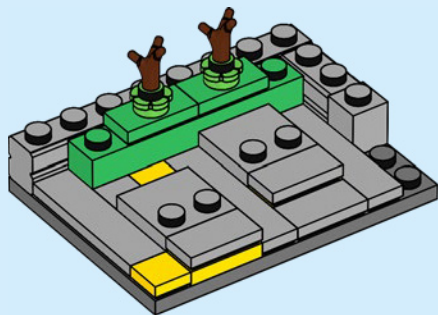

1x

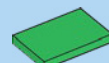

1x

64

1



2



3

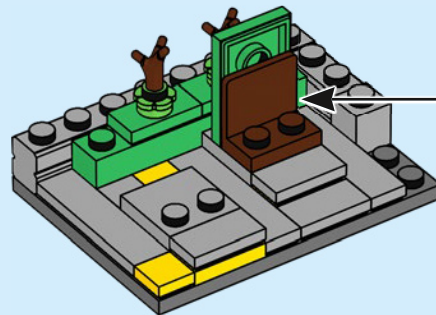

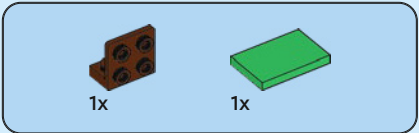

65

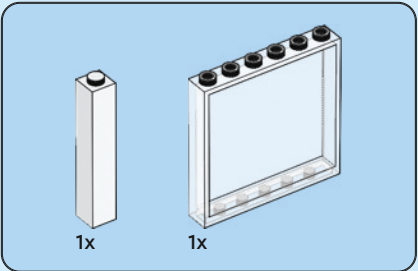
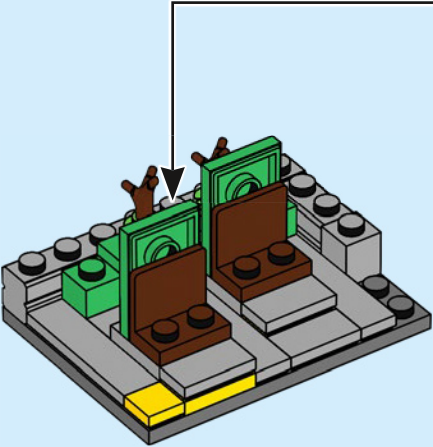
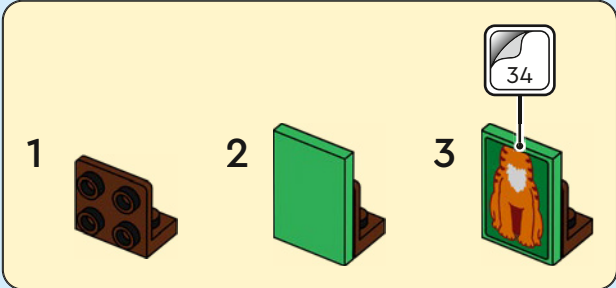

66

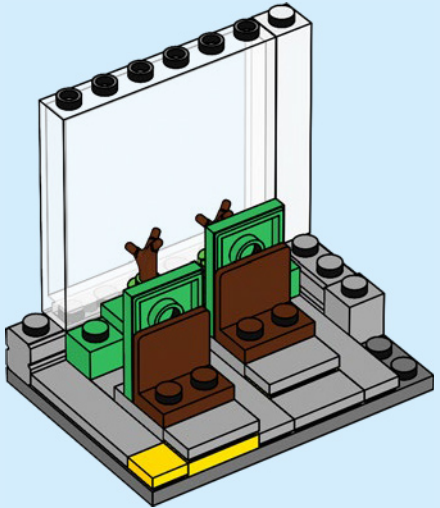



5x



5x

67

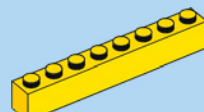
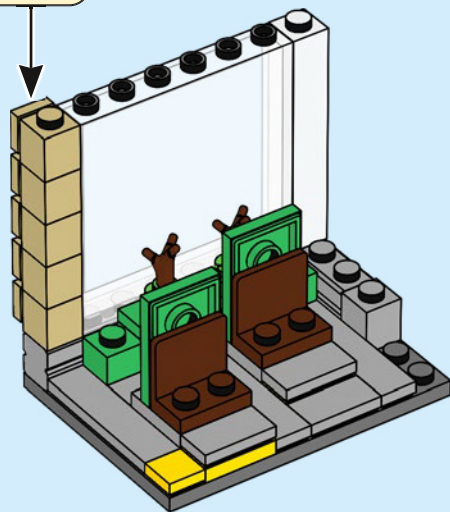
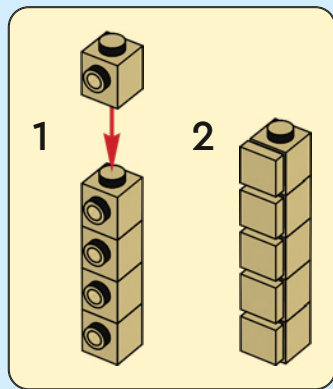

1x

68

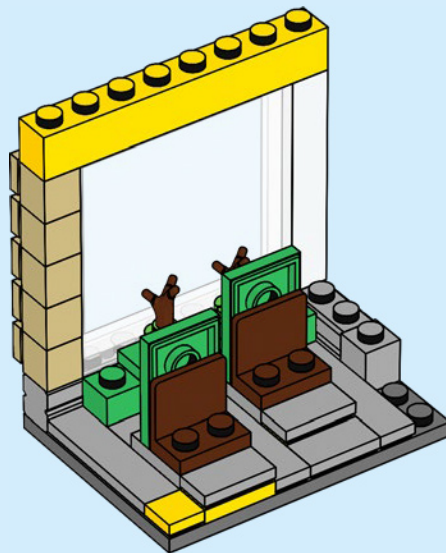

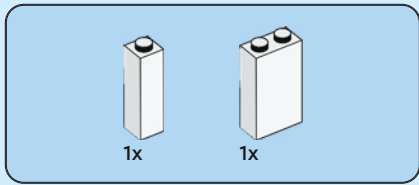

69

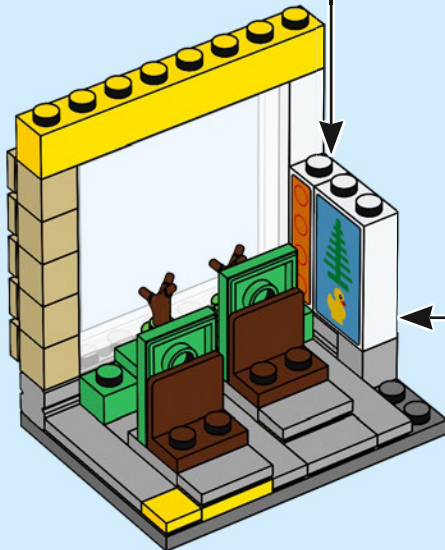
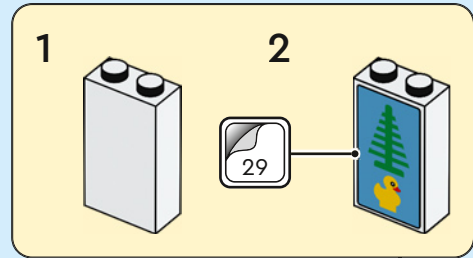
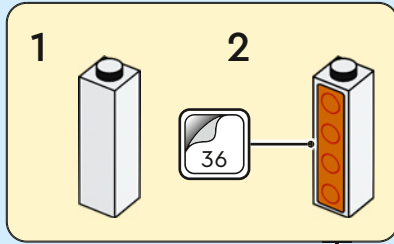

70

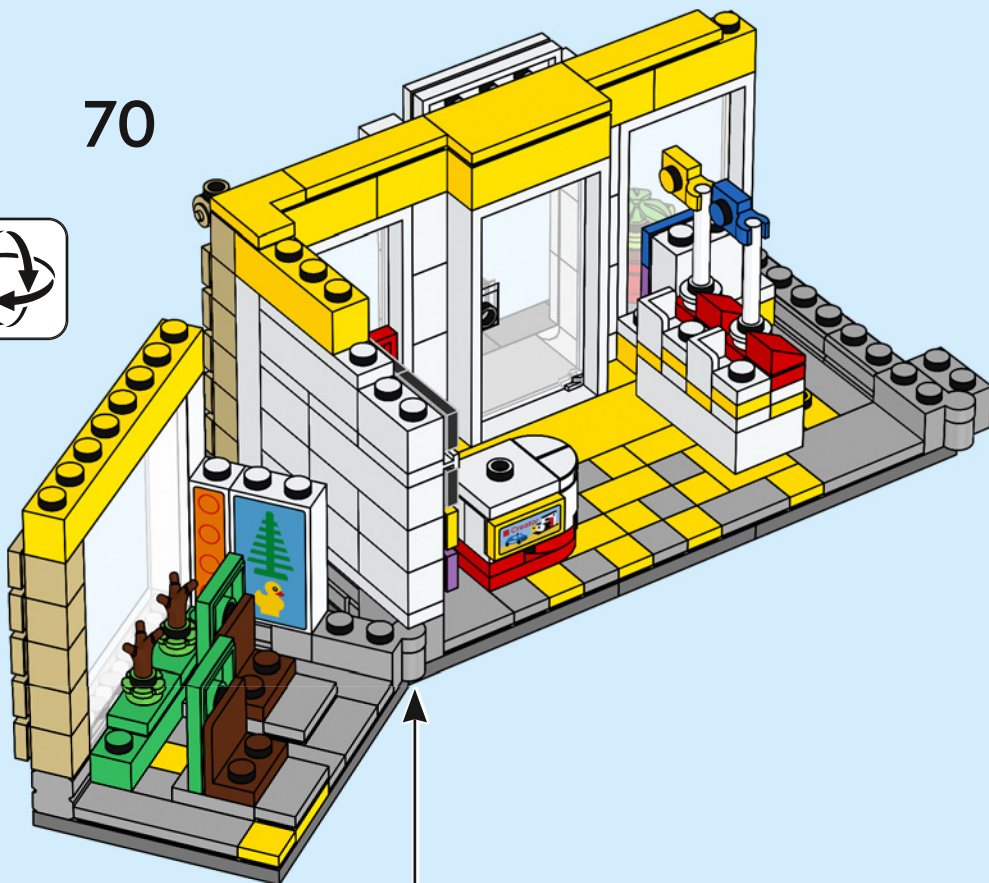

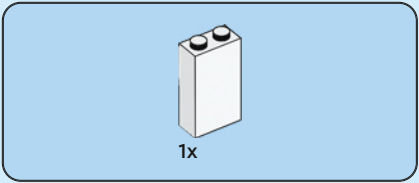

71

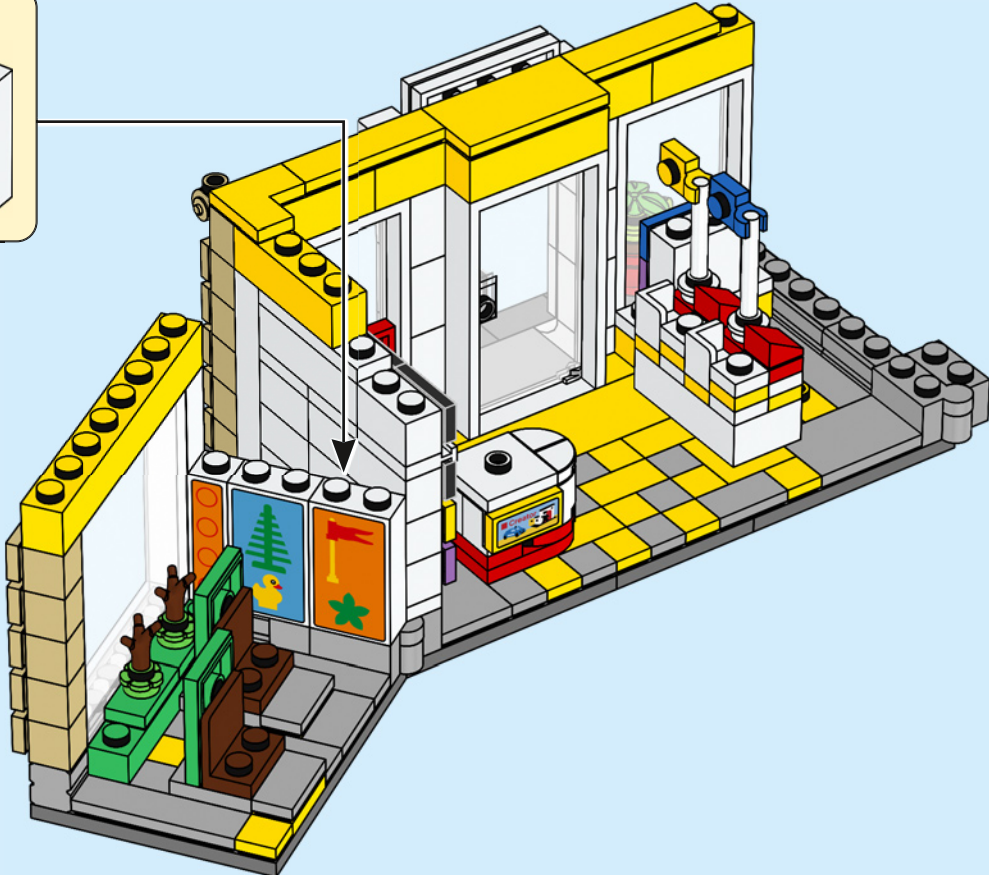
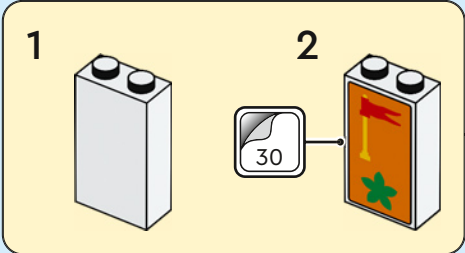

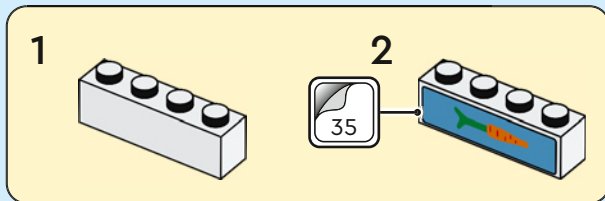
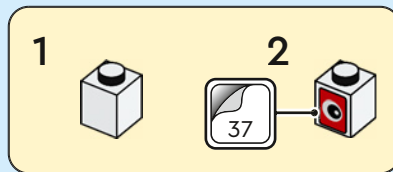
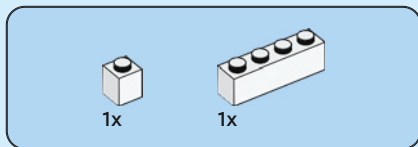

72

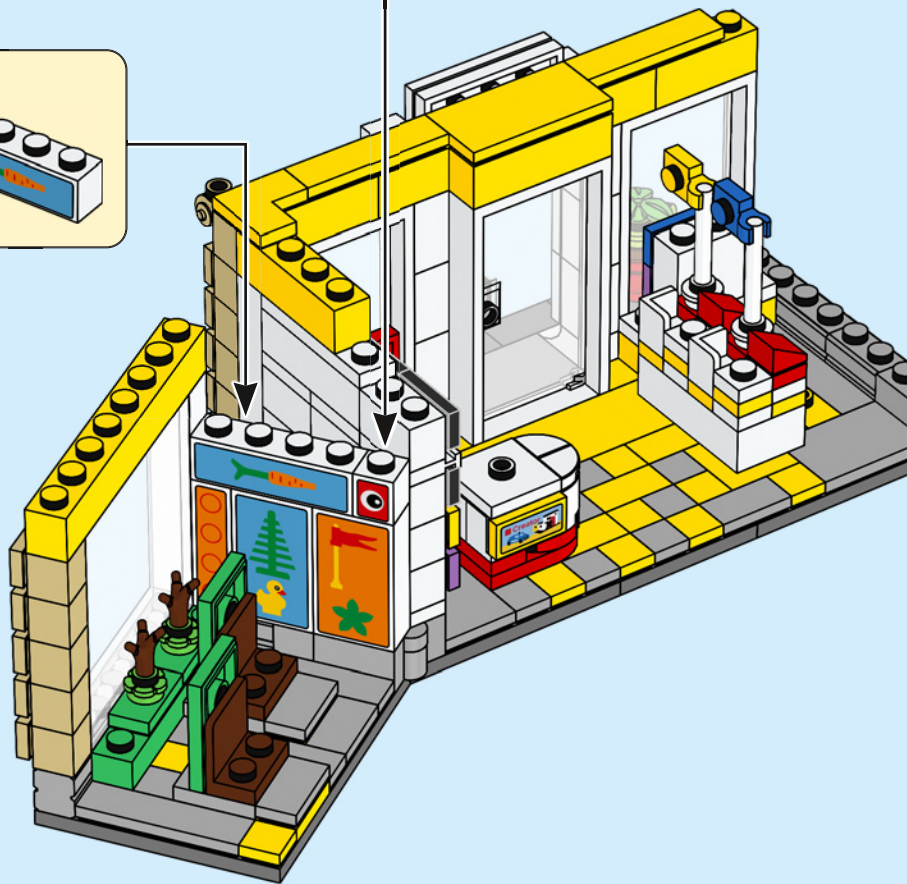



1x



1x

73

1

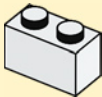

2

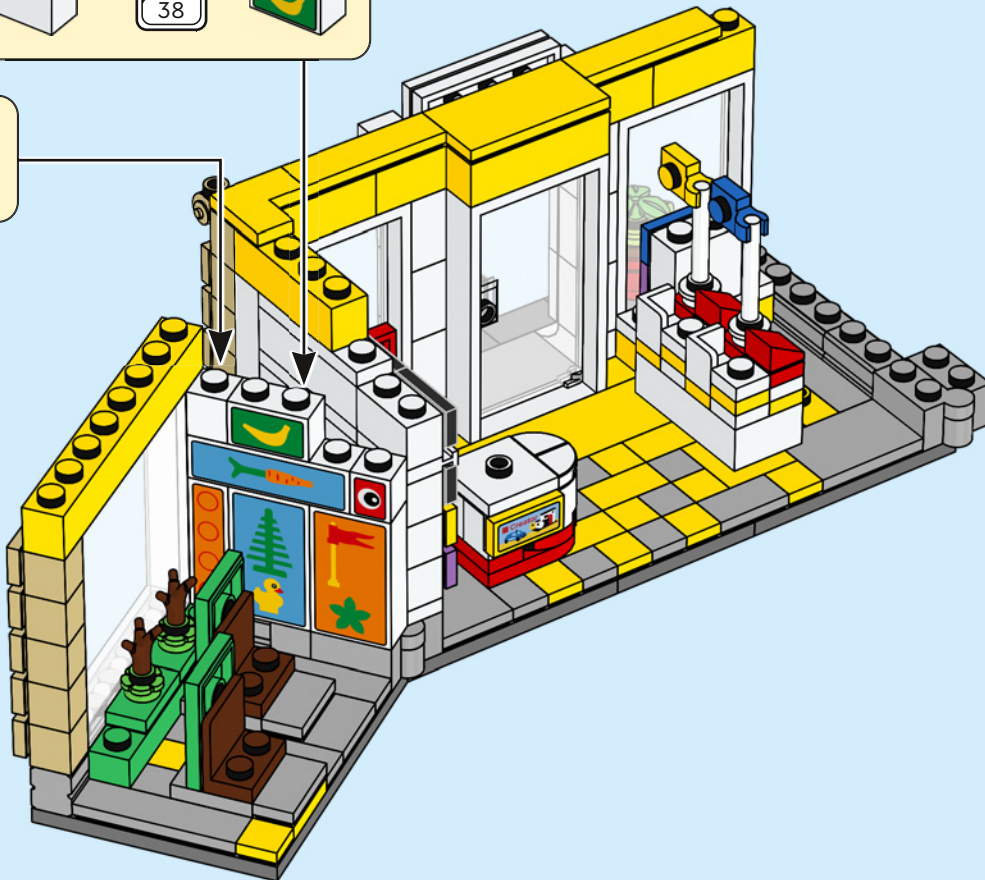

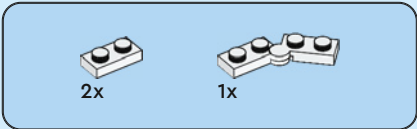

74

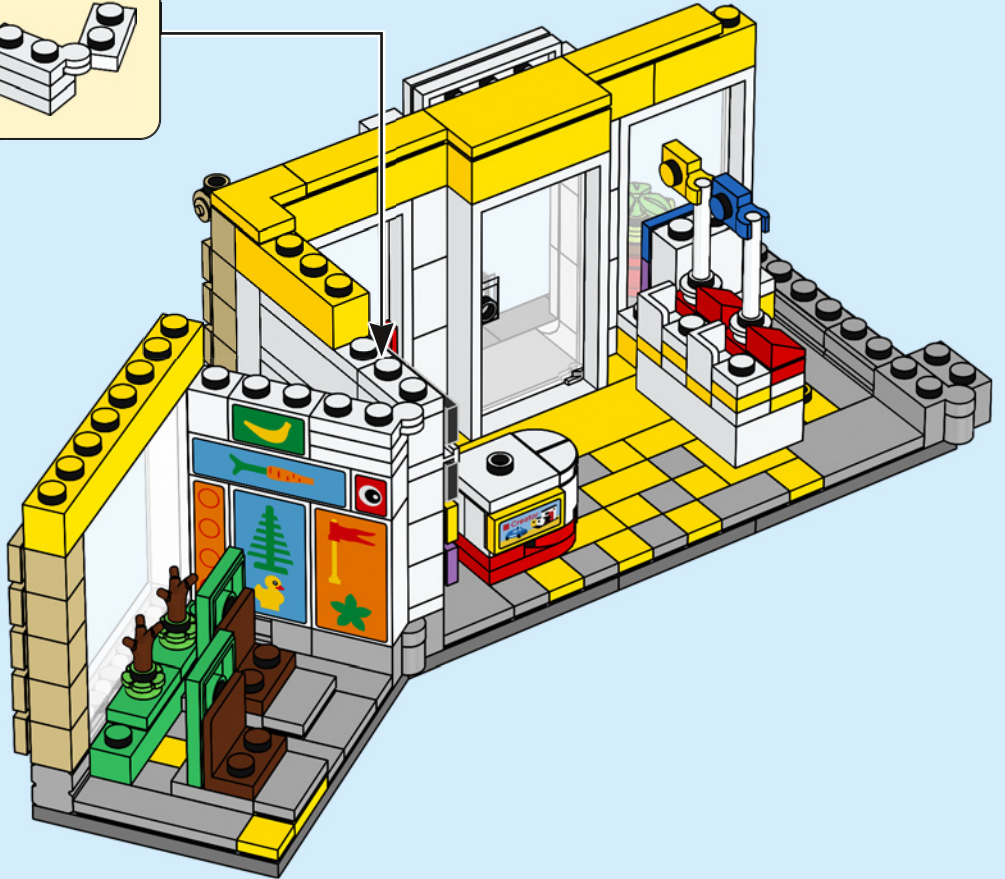
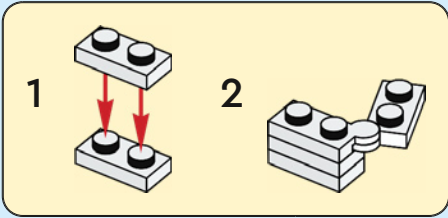

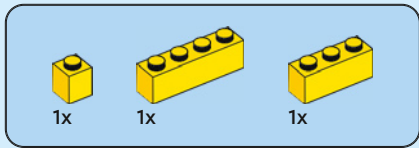

75

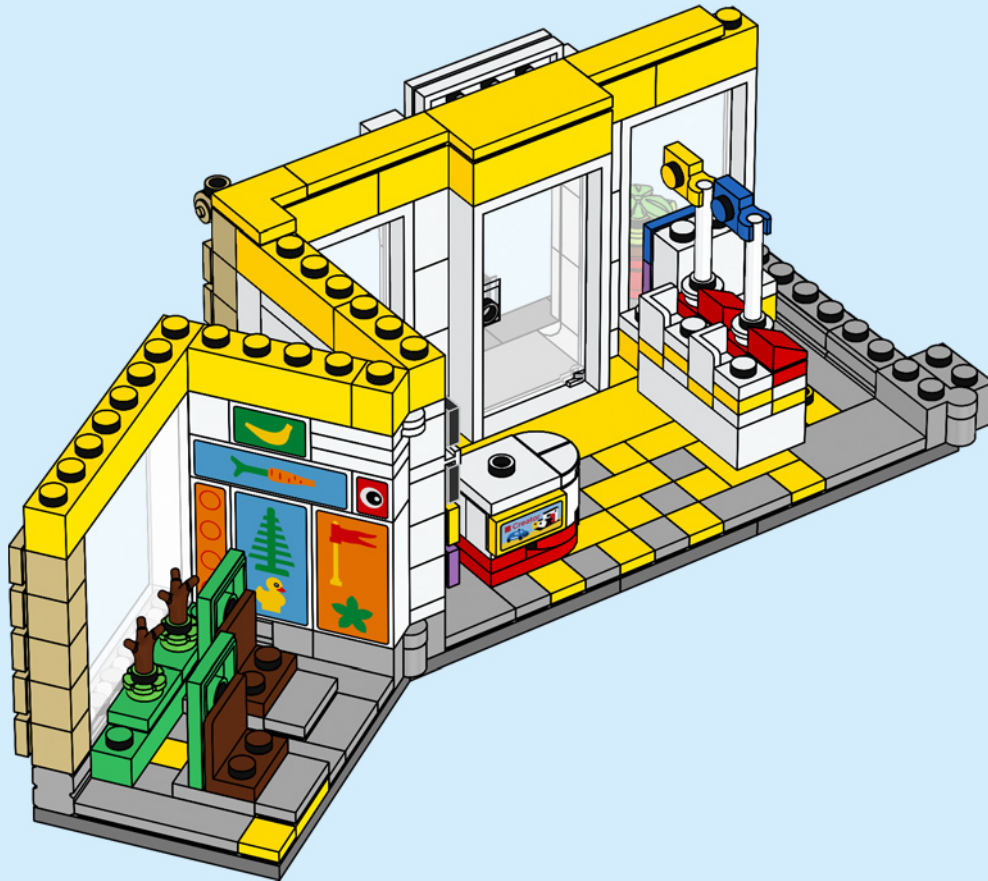

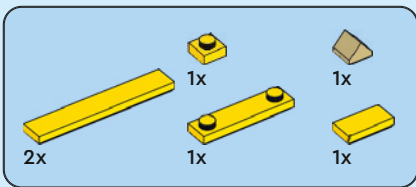

76



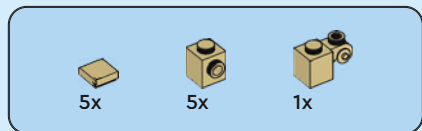

77

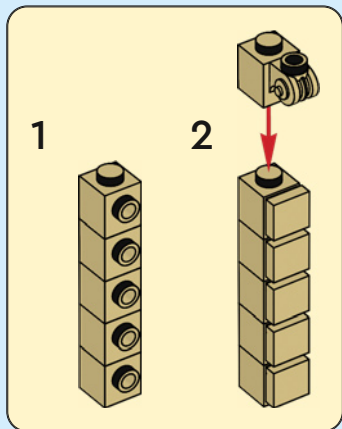

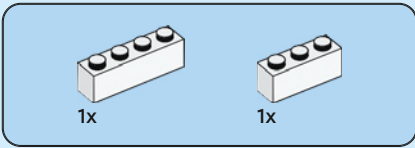

78

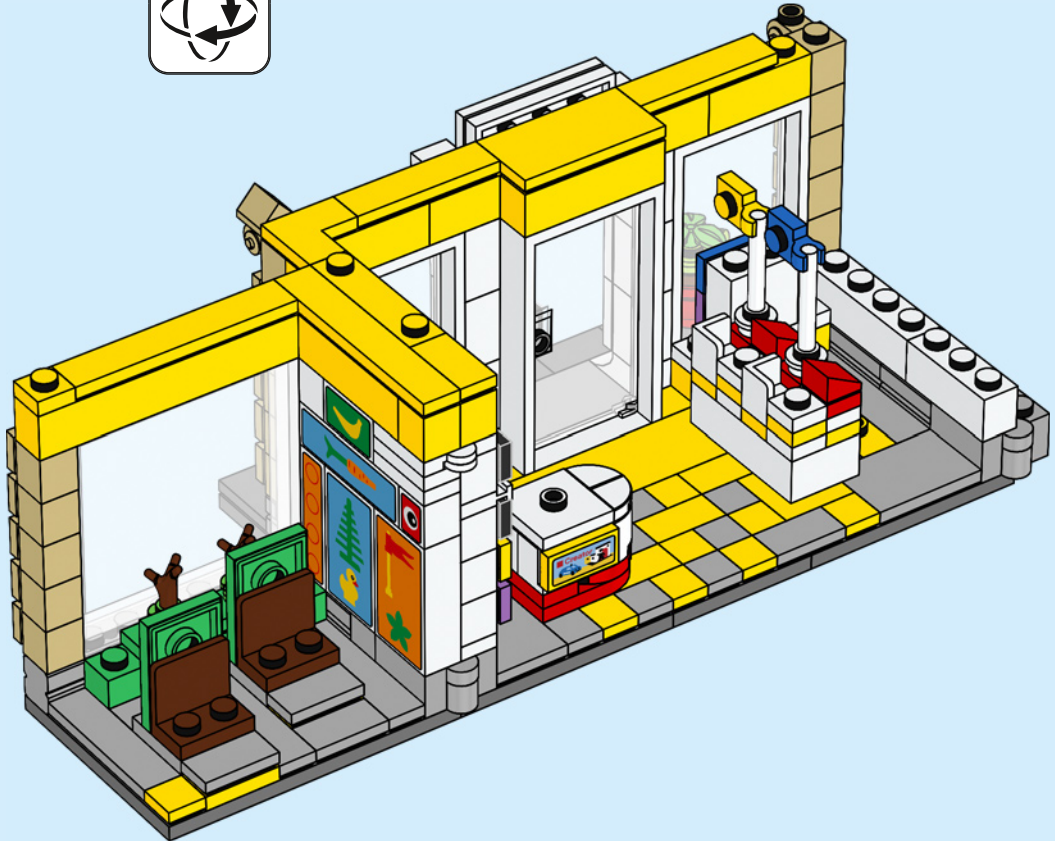

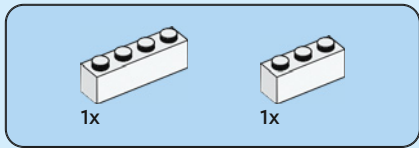

79

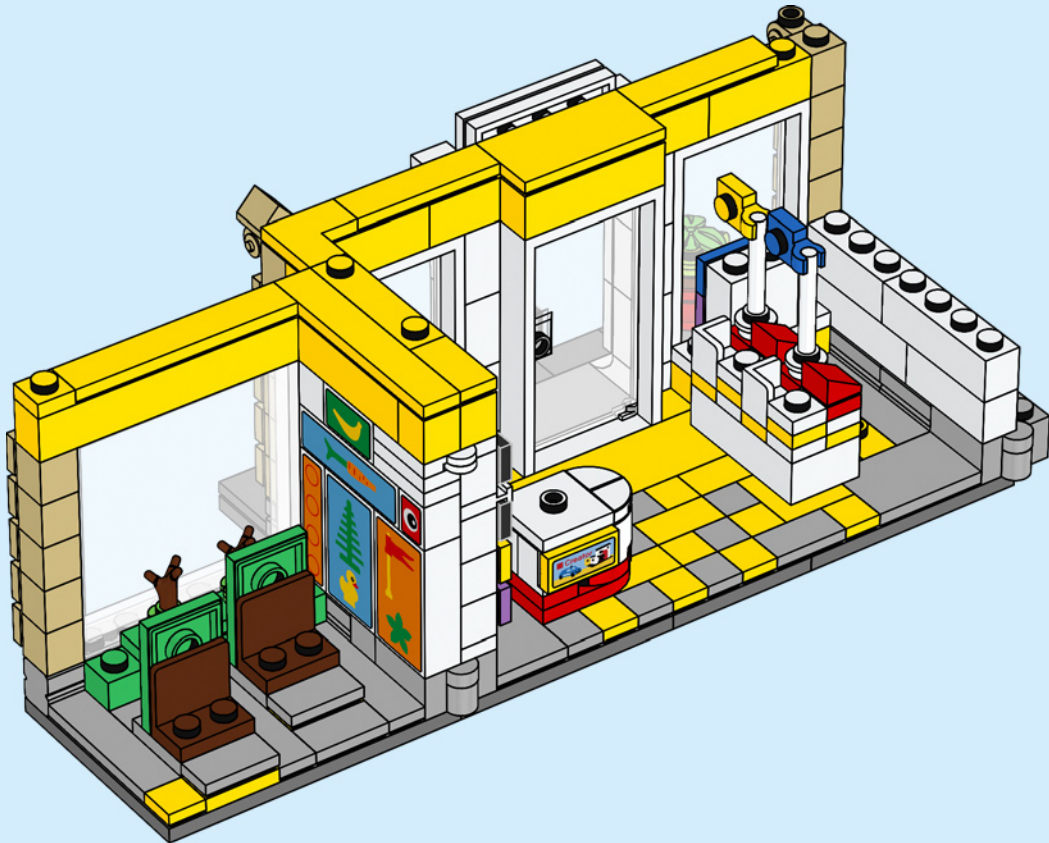

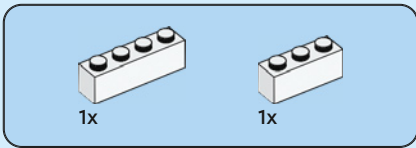

80

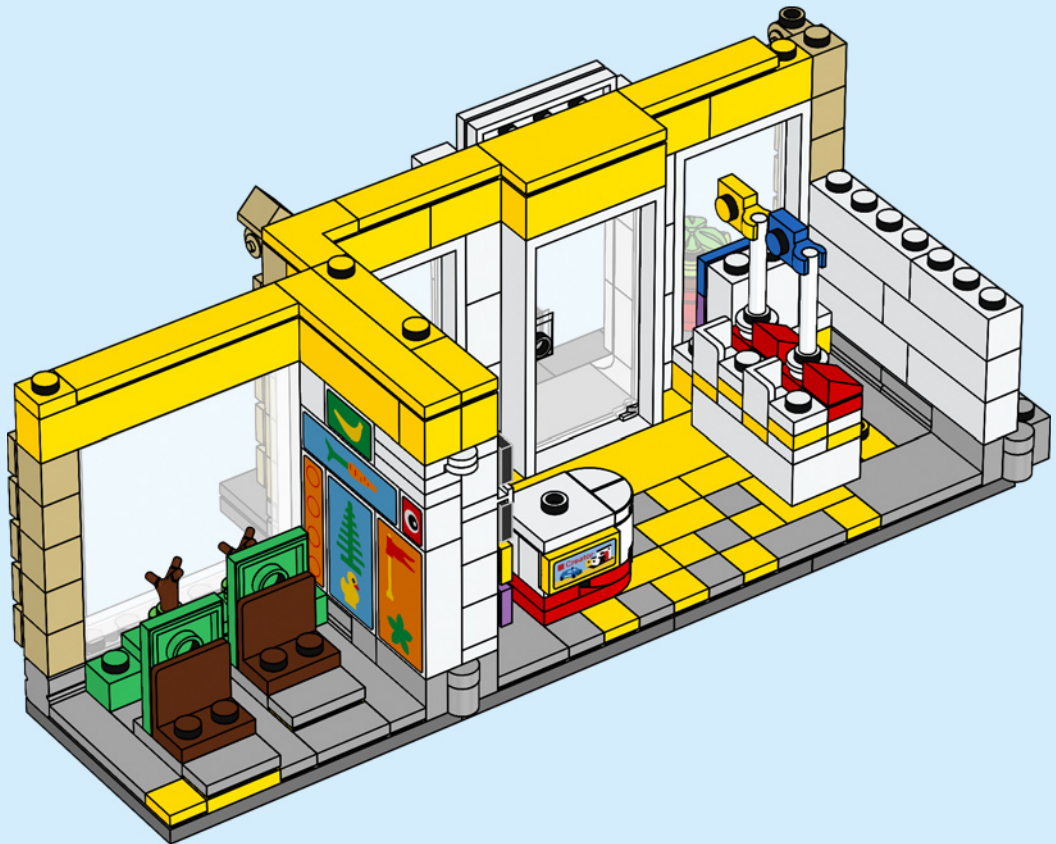

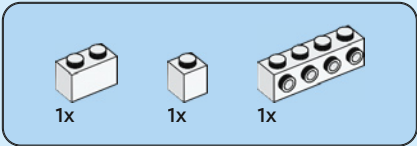

81

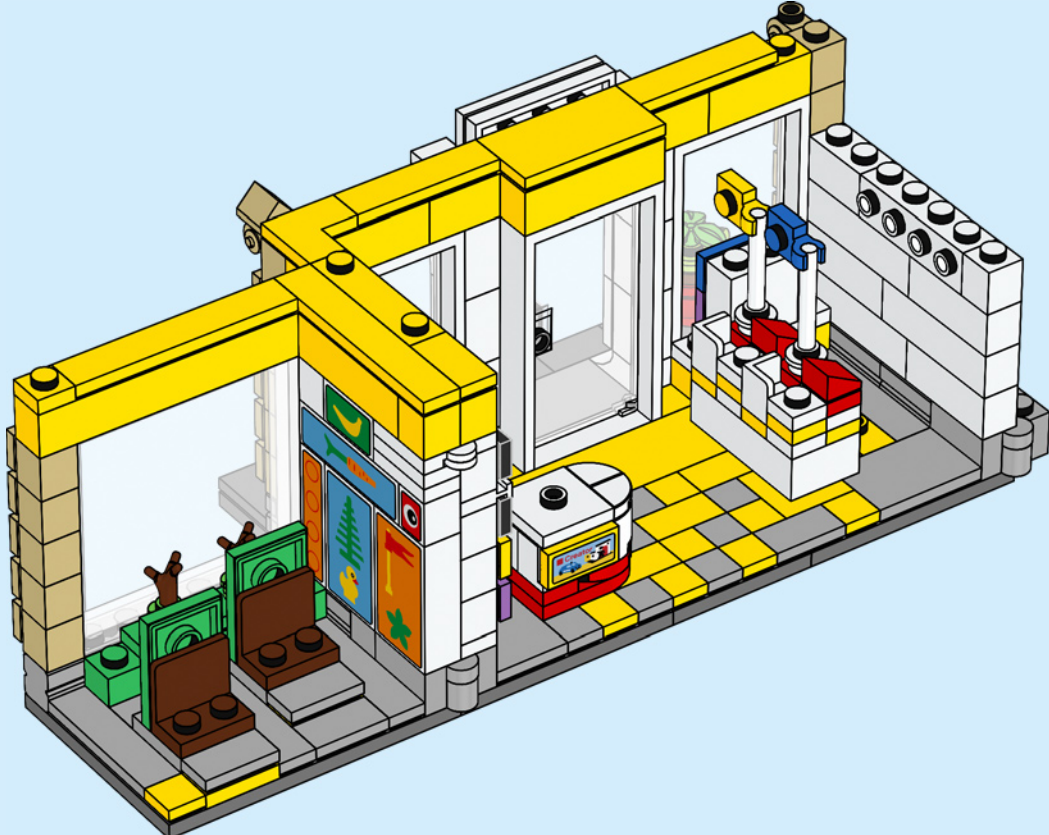



1x



1x

82

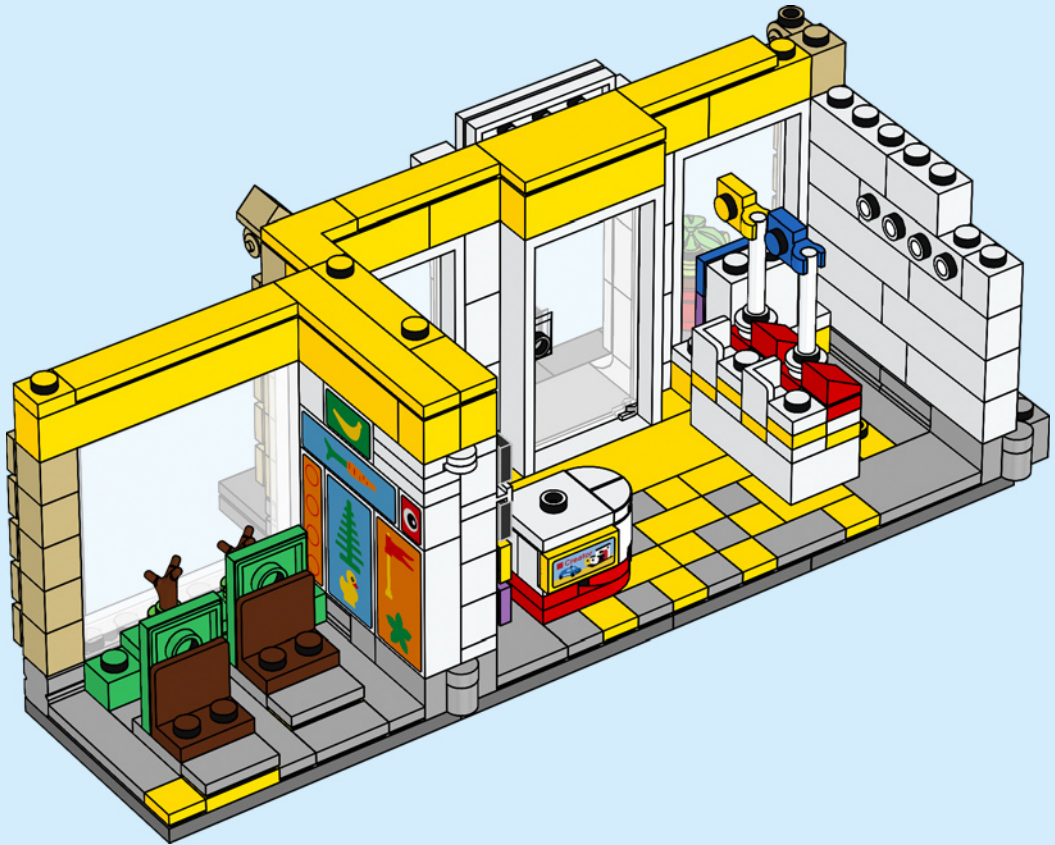

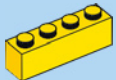

1x

83

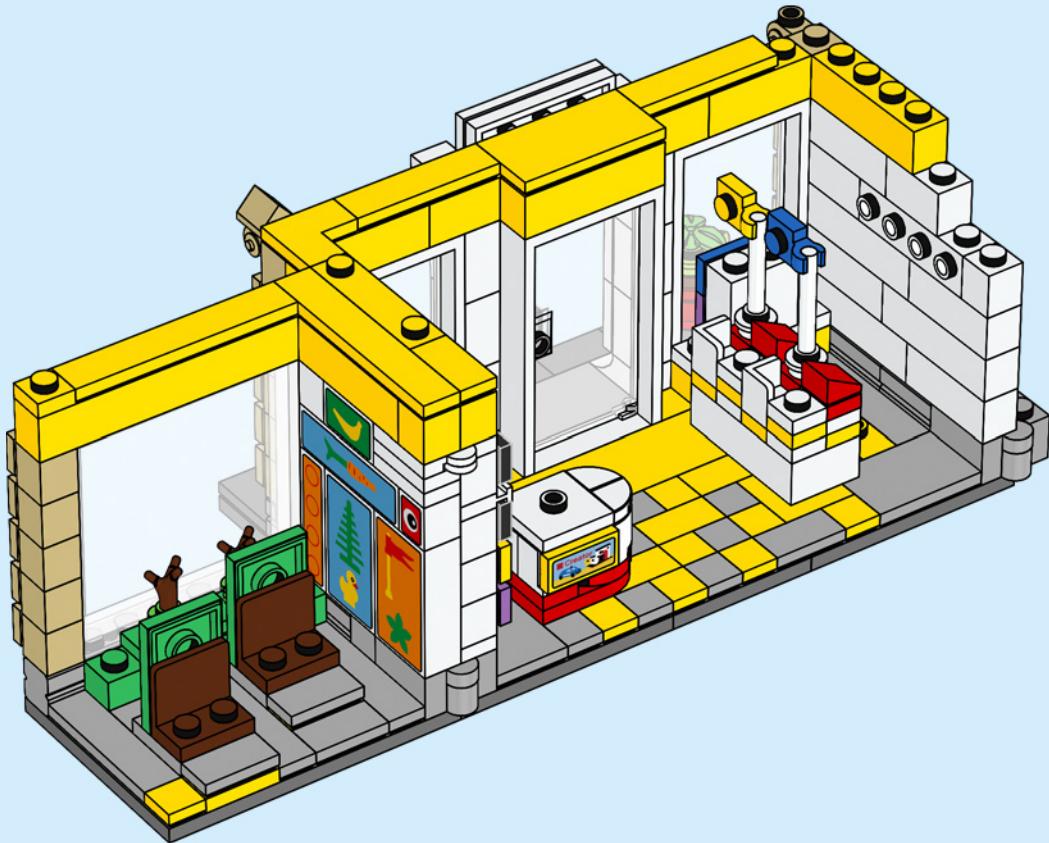



1x

84

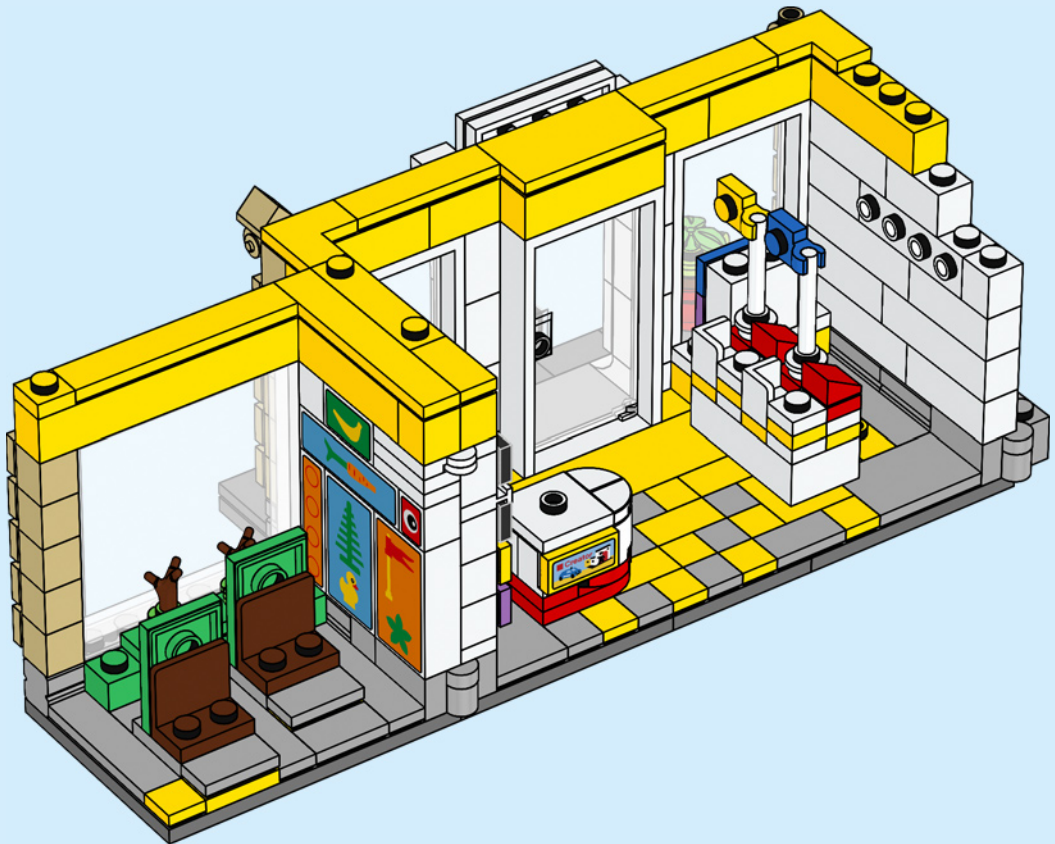

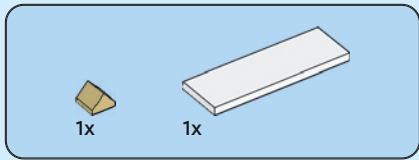

85

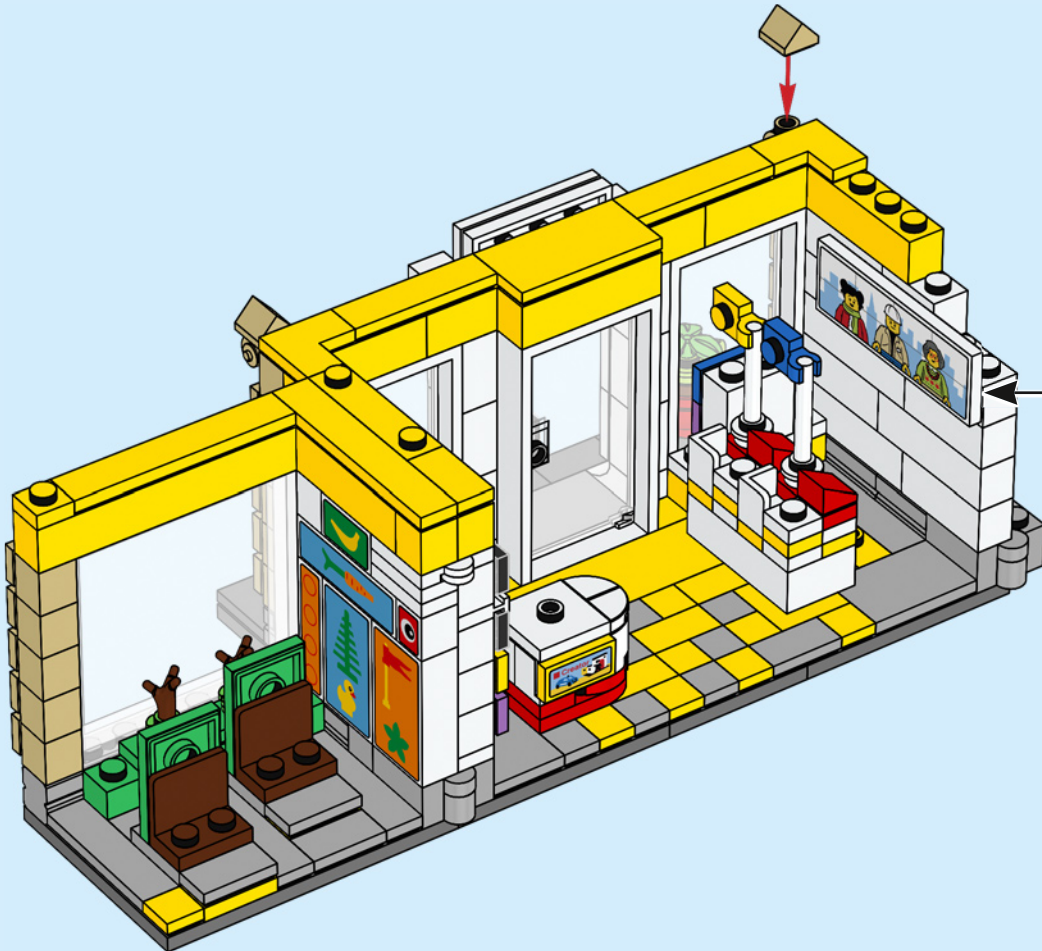
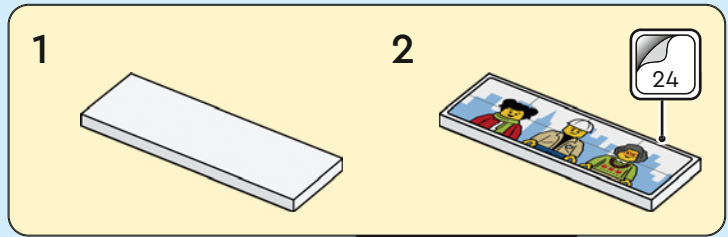

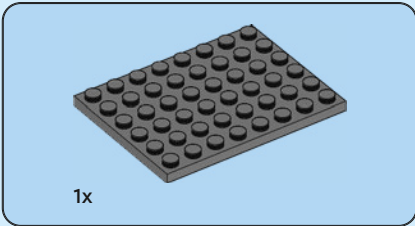
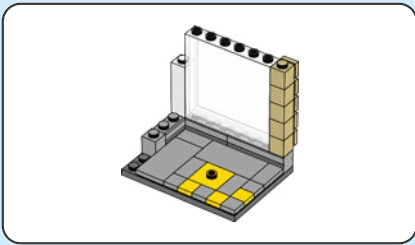

1x

86

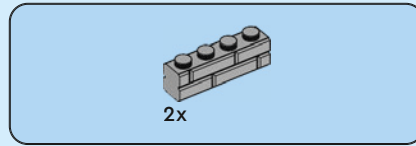
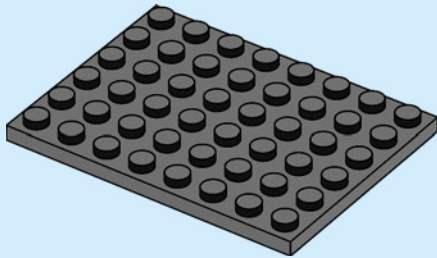

2x

87

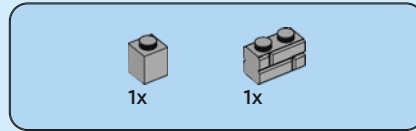
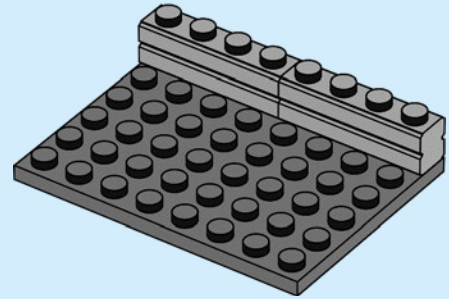

1x

1x

88

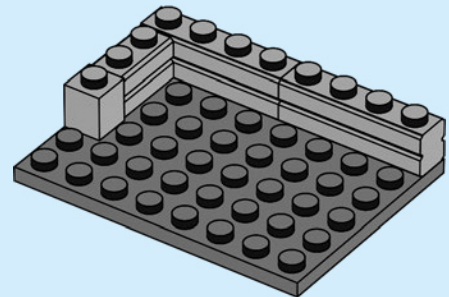

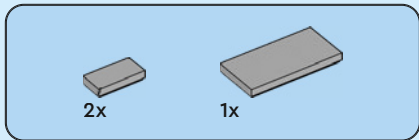

89

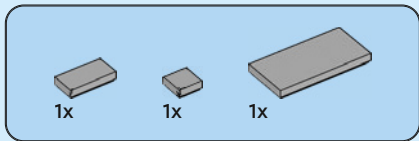
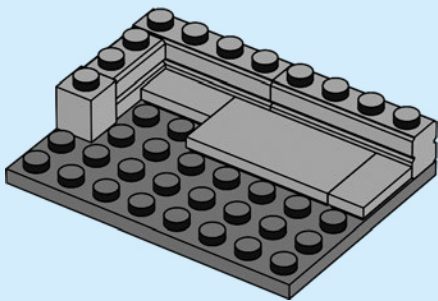

90

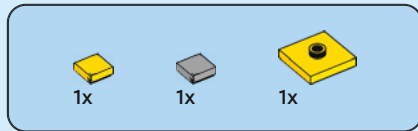
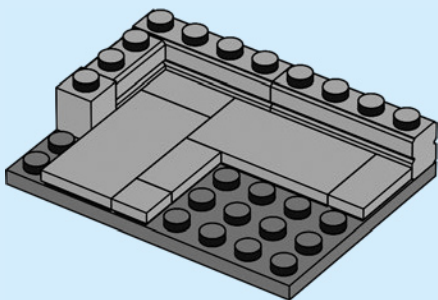

91

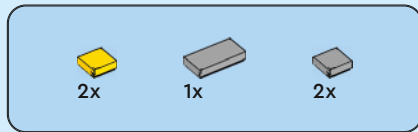
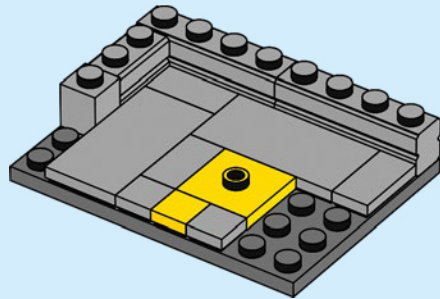

92

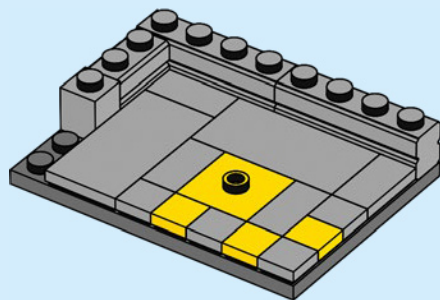

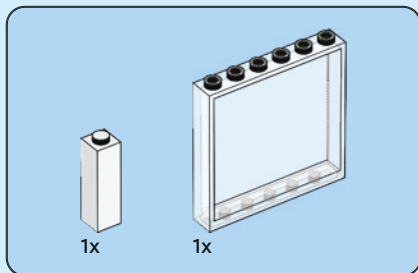

93

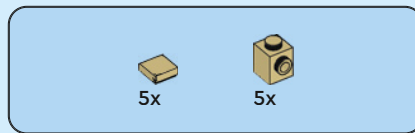
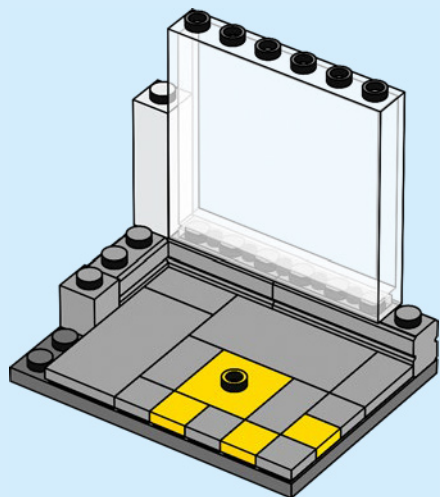

94

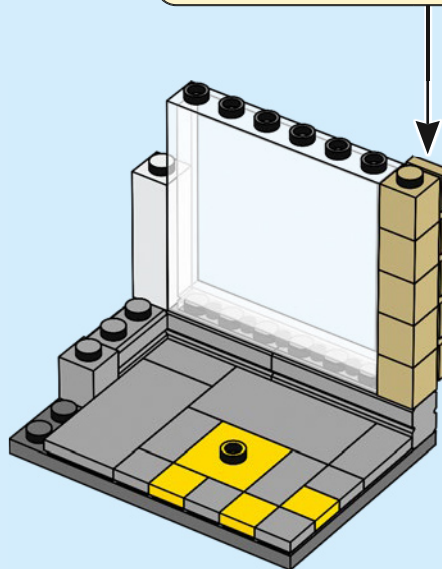
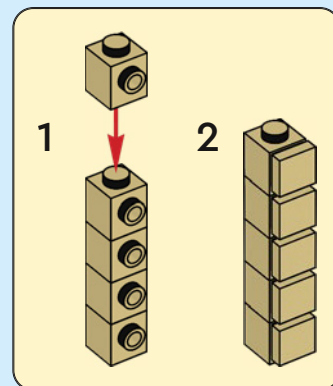

95

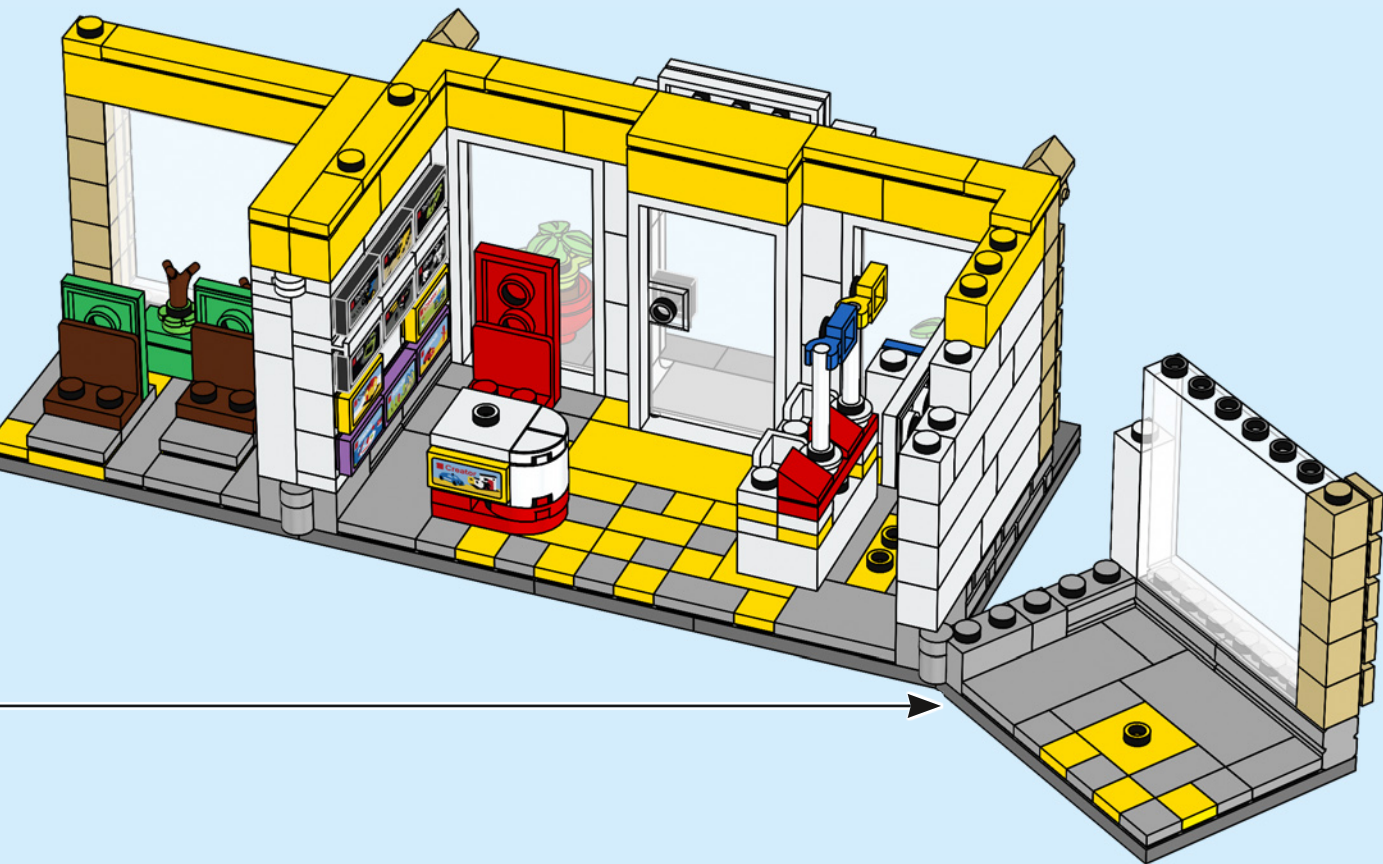



96

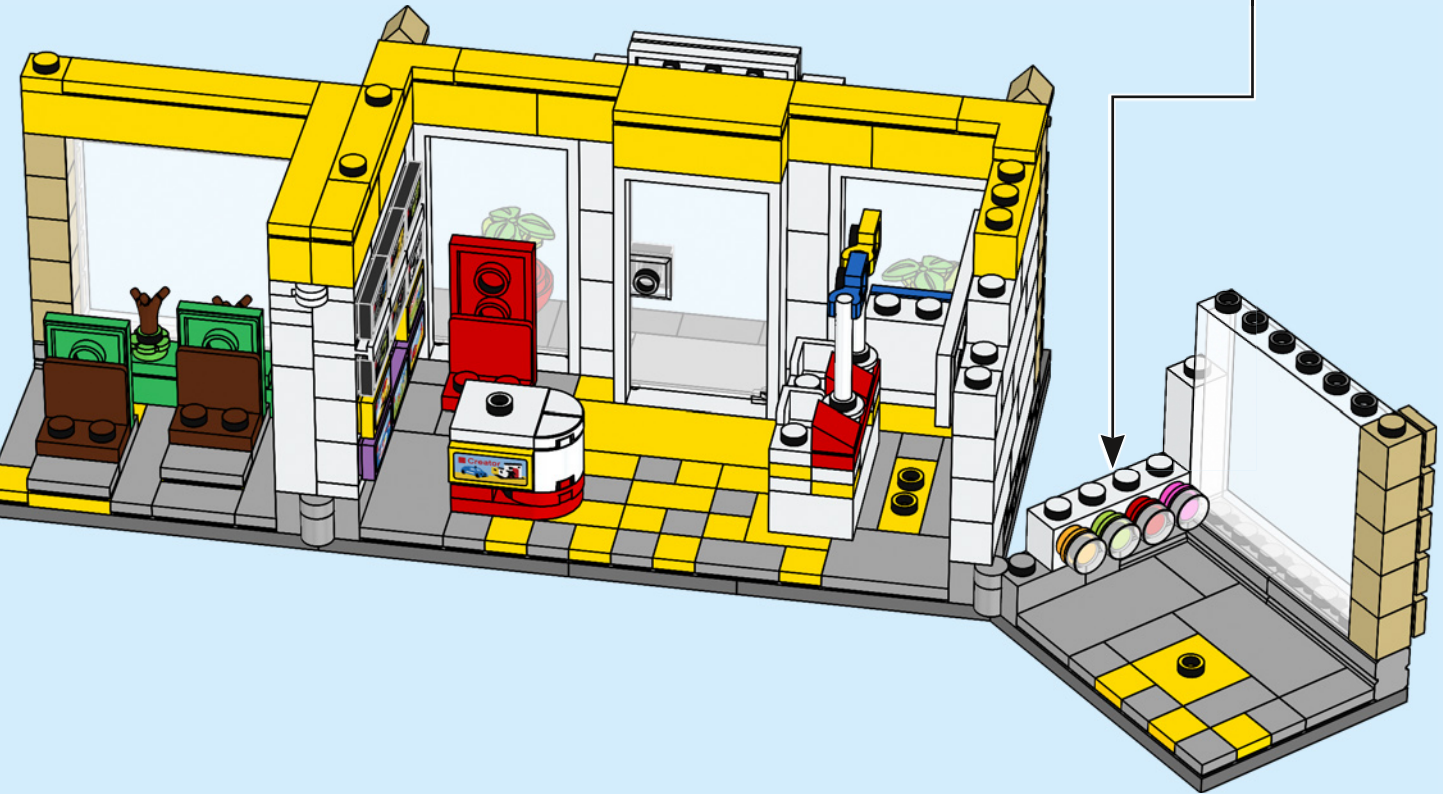
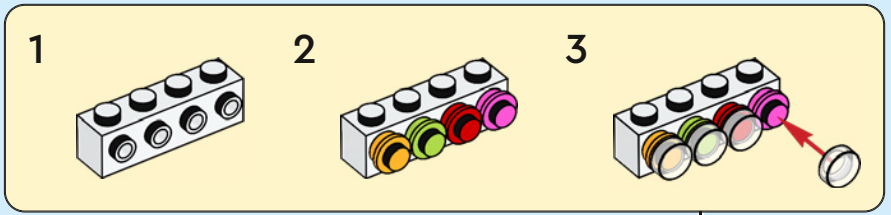



2x



1x



2x



1x

97

1



2



1



2

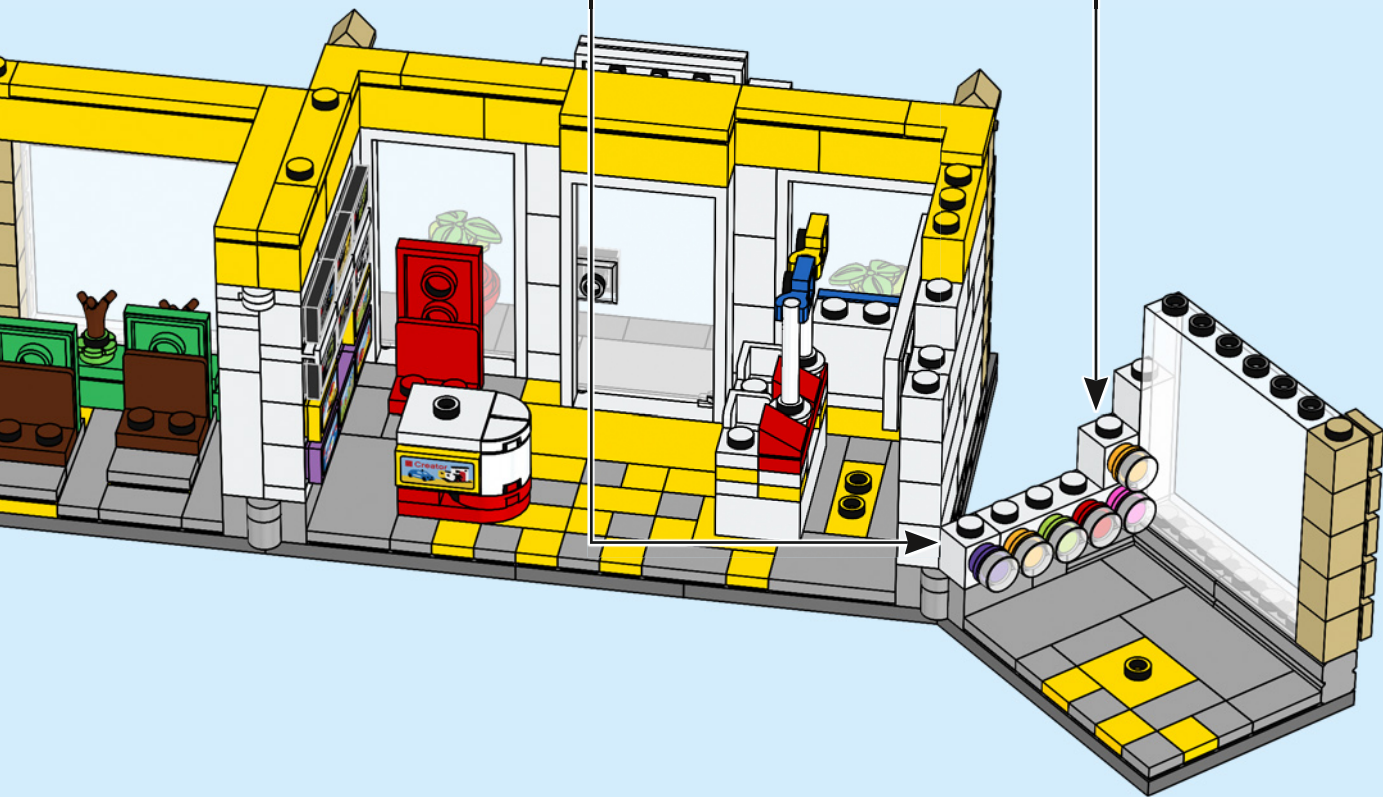



98

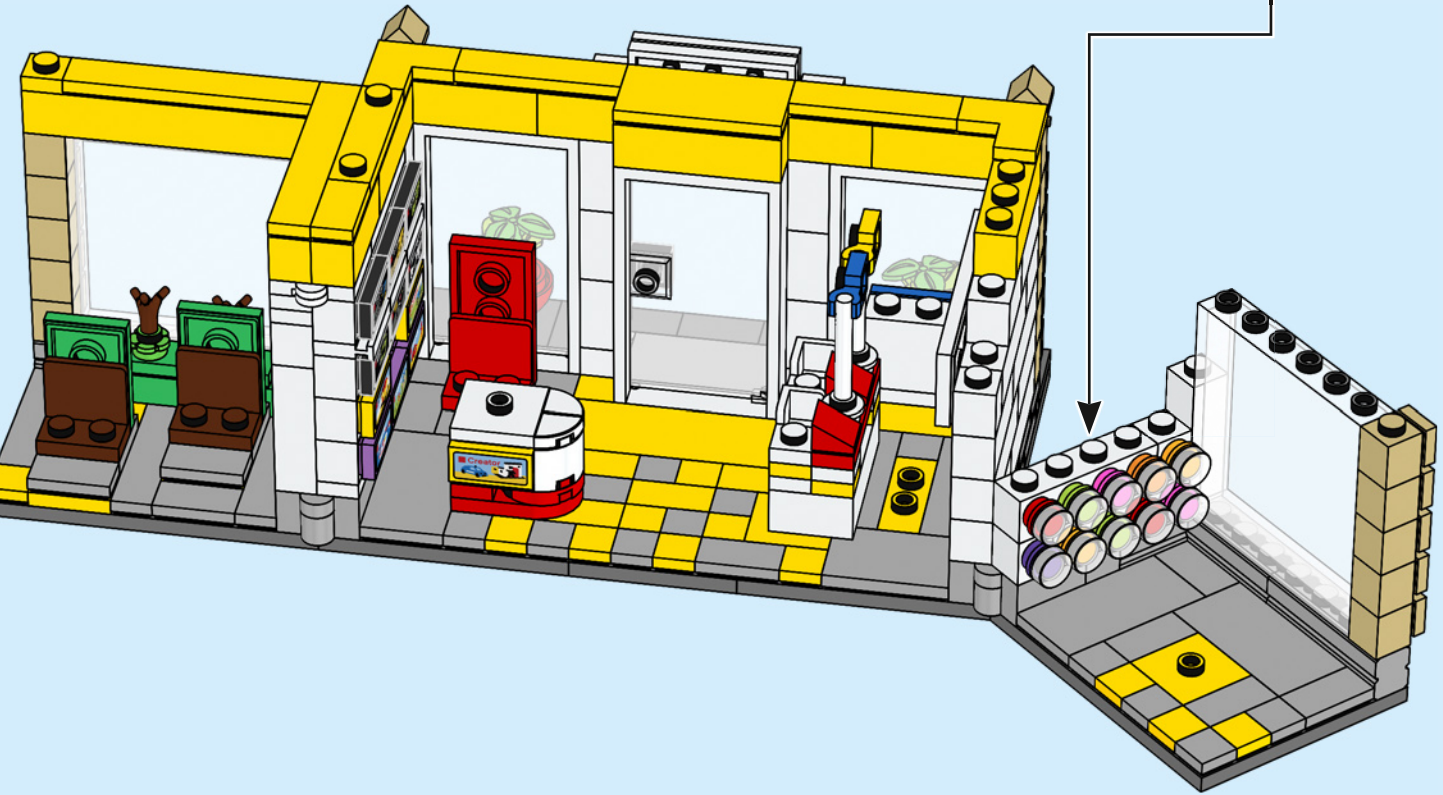
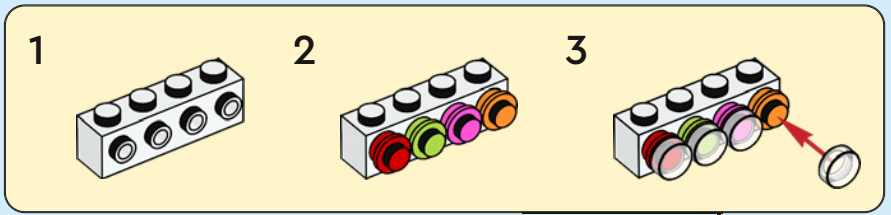



99

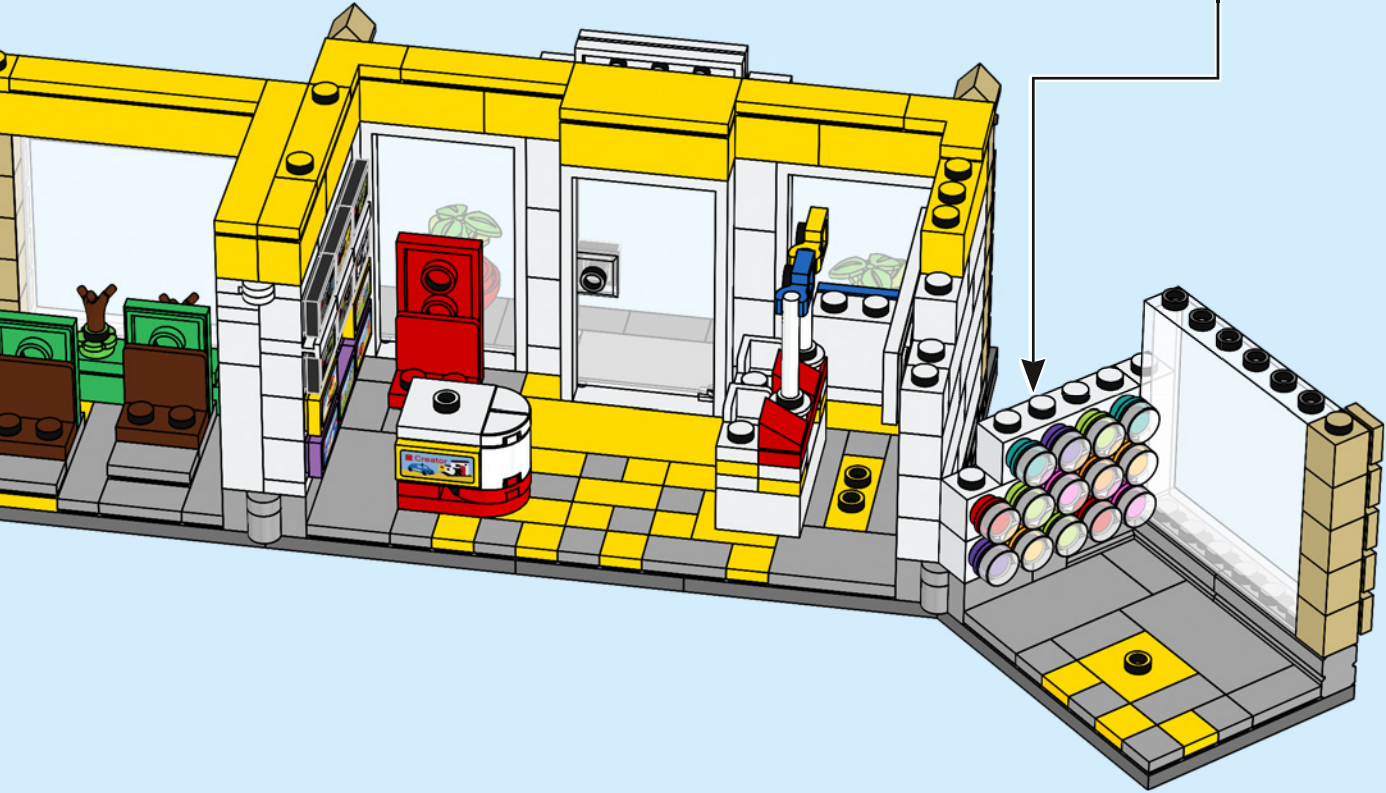
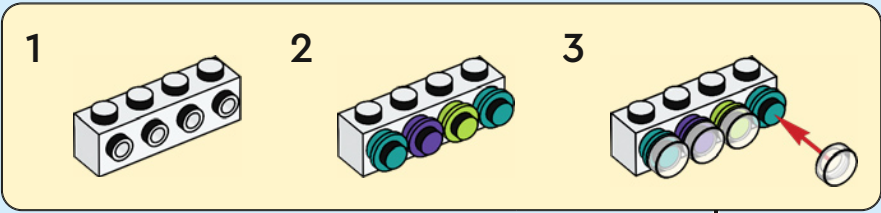

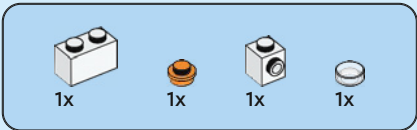

100

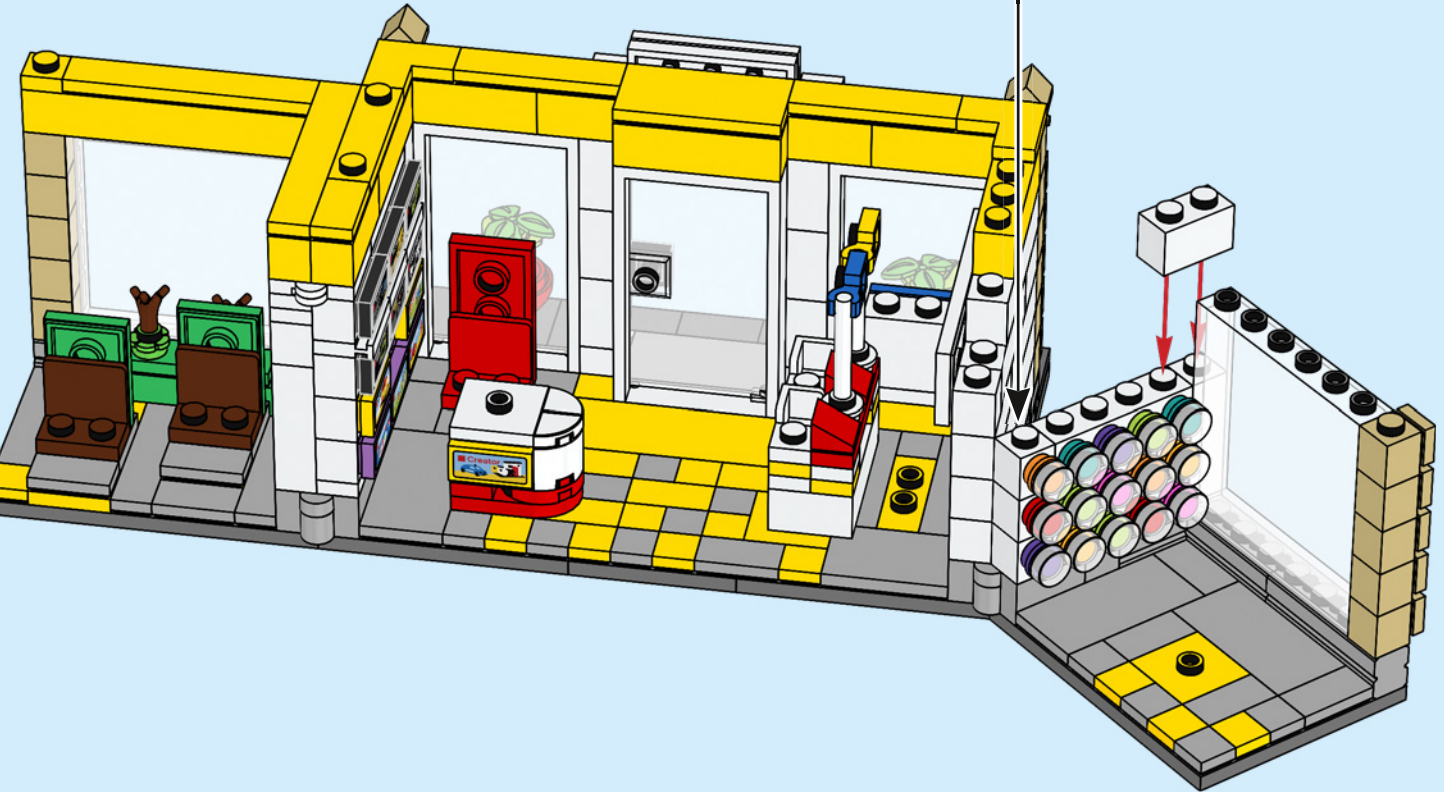
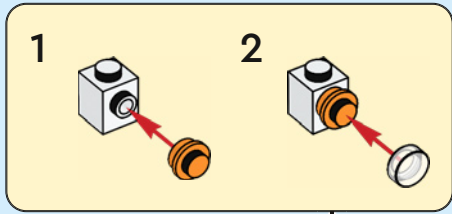

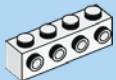

1x

101

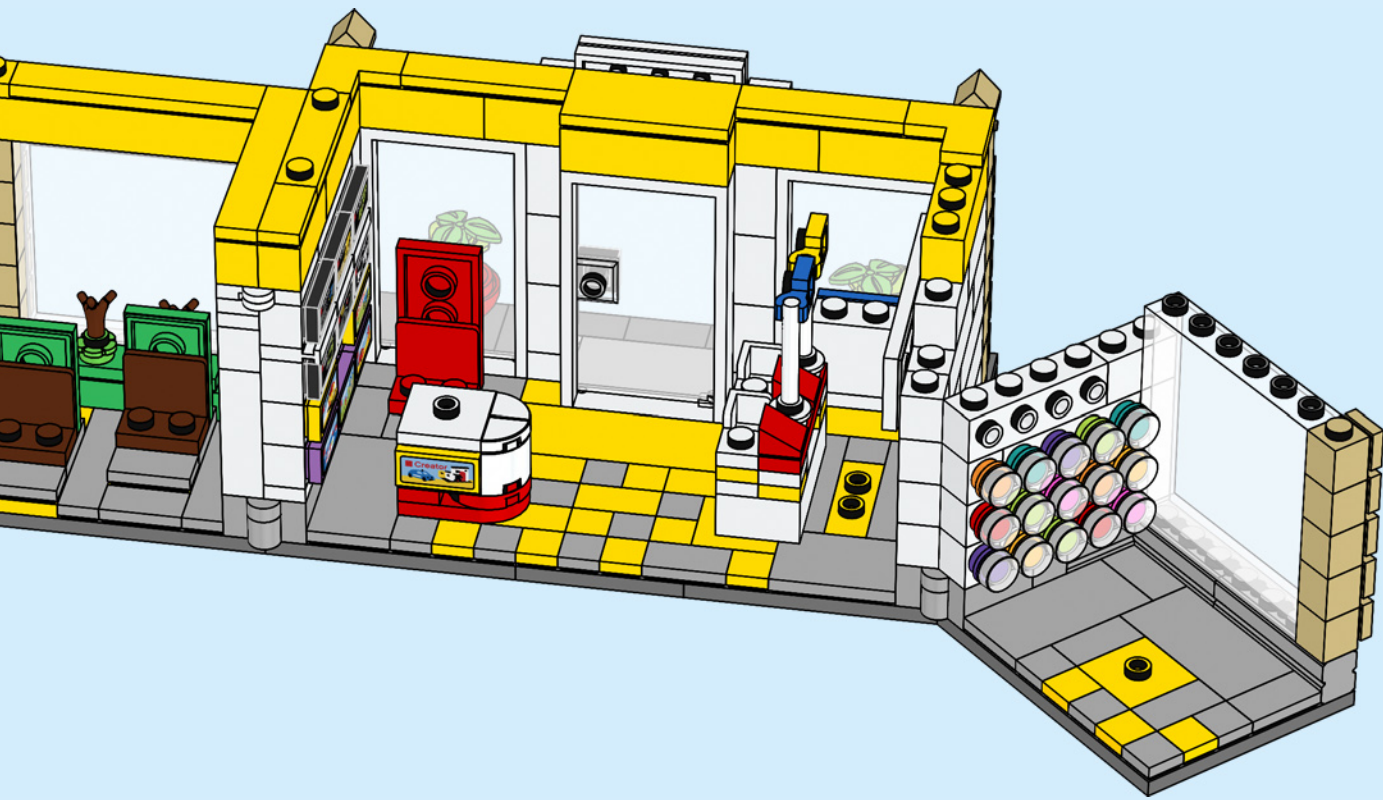

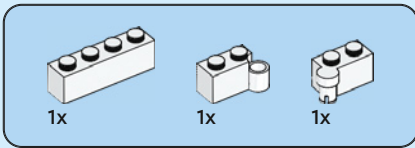

102

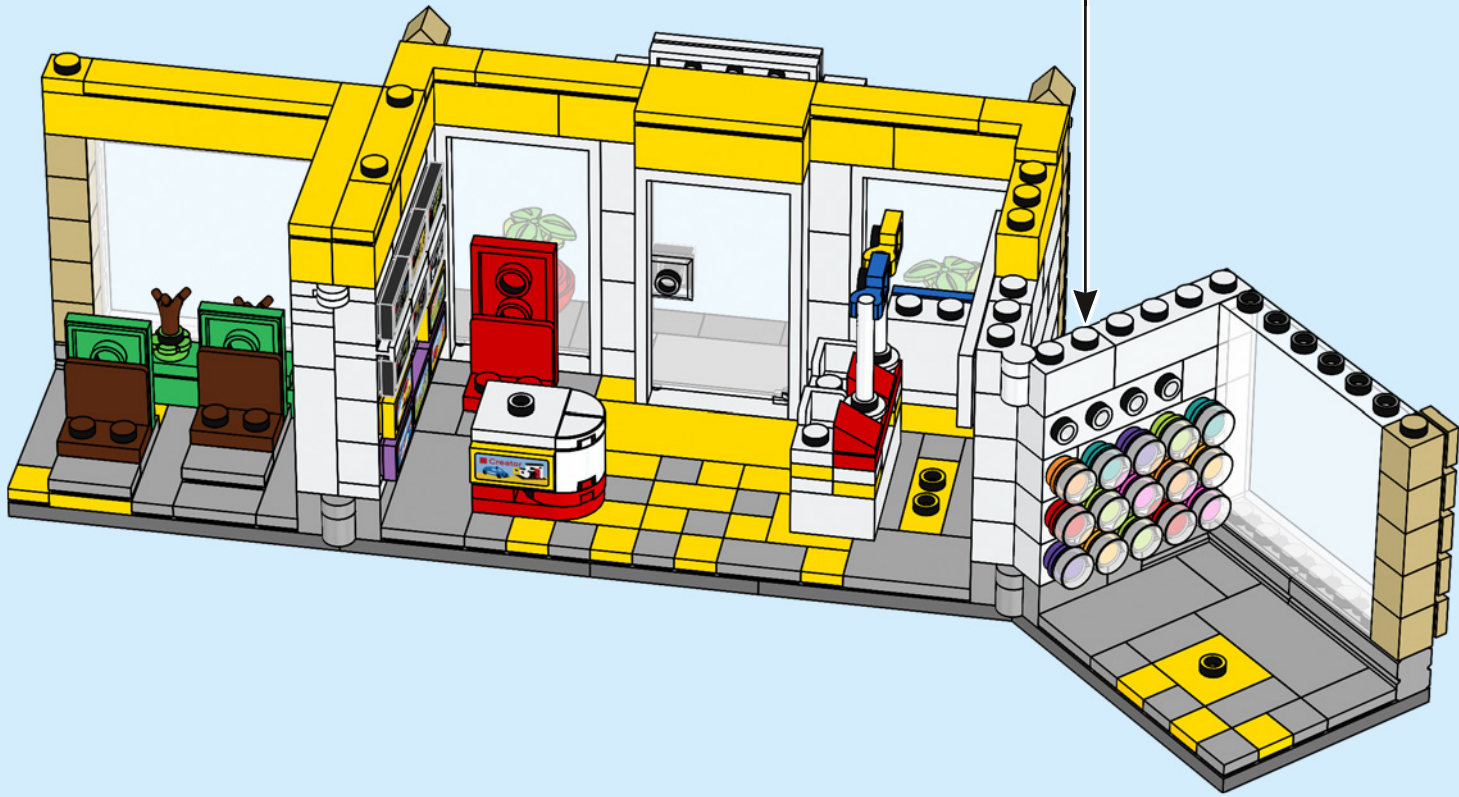
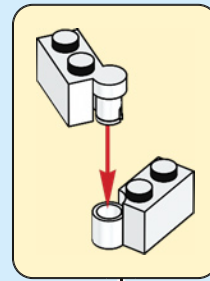

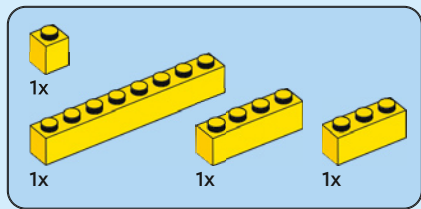

103

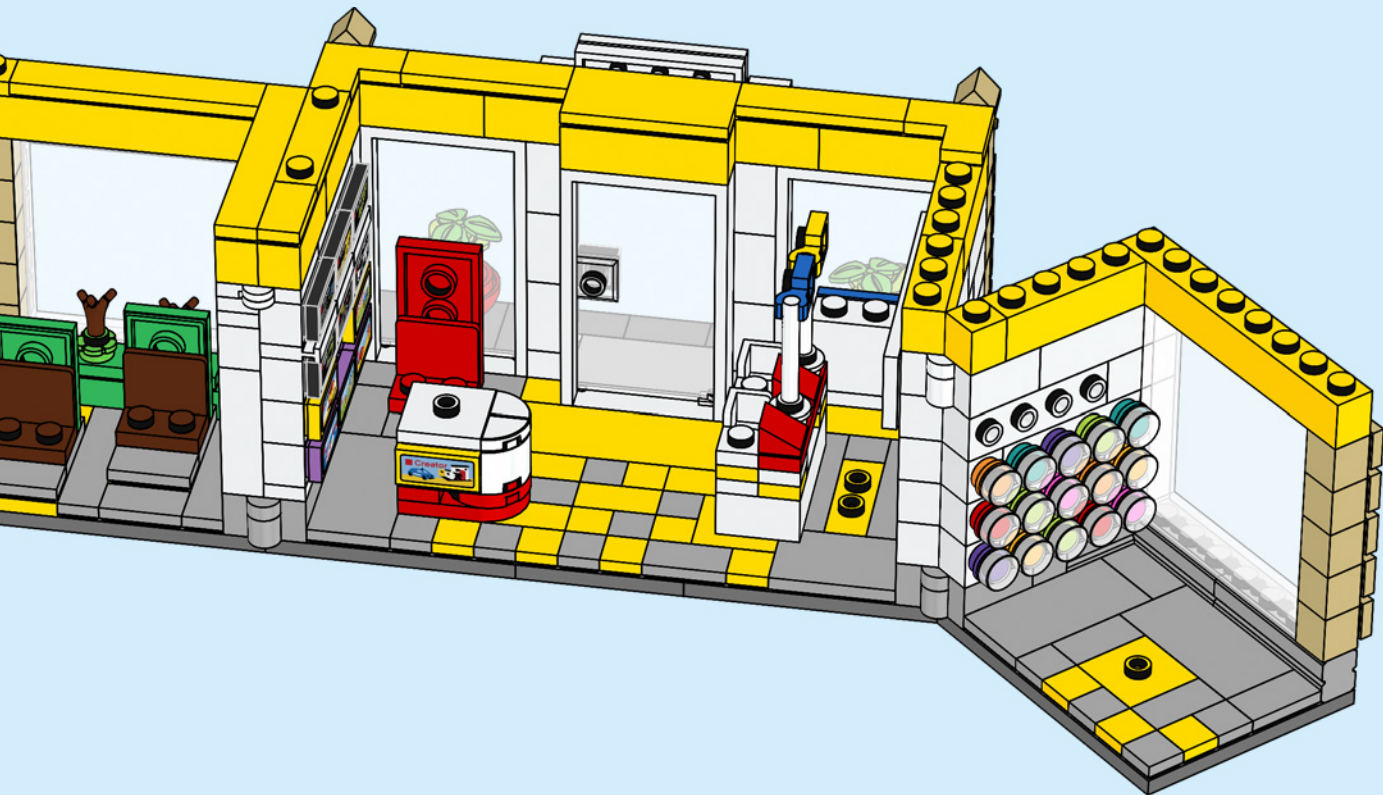

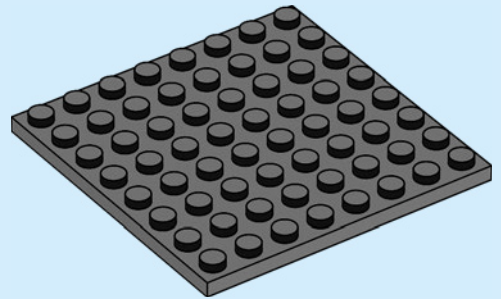
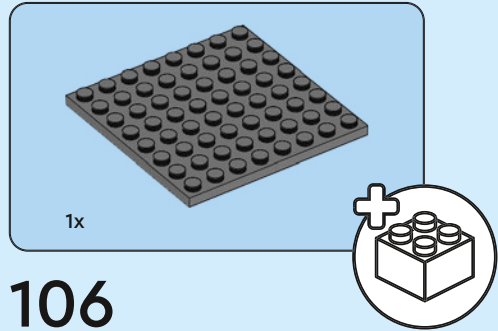
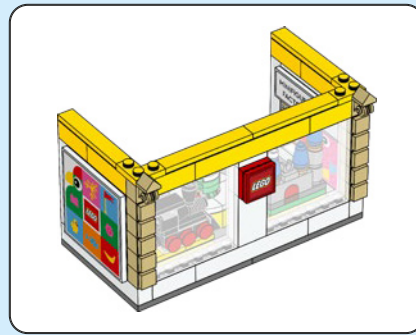
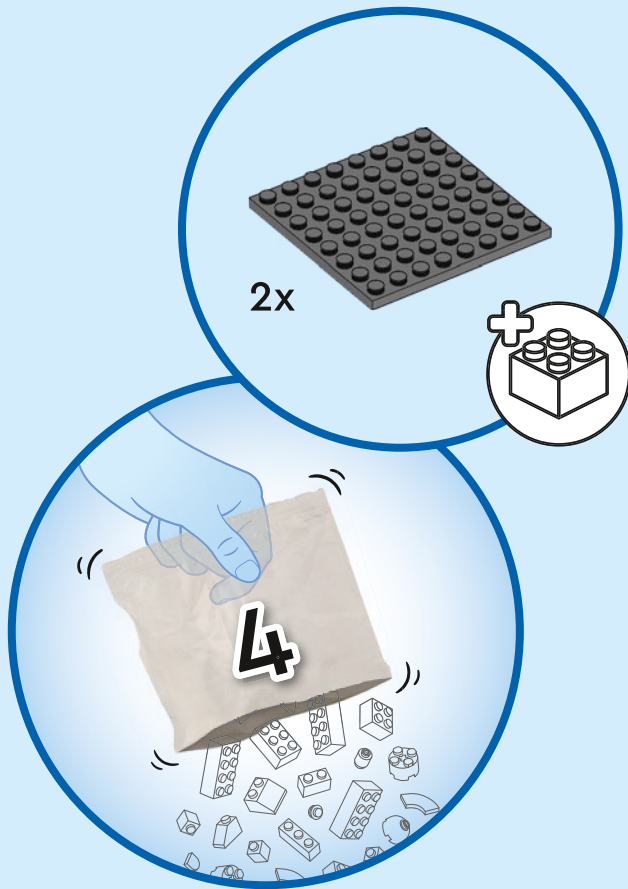

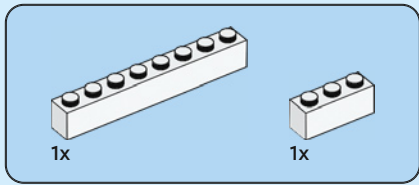

107

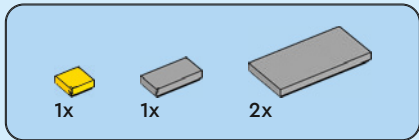
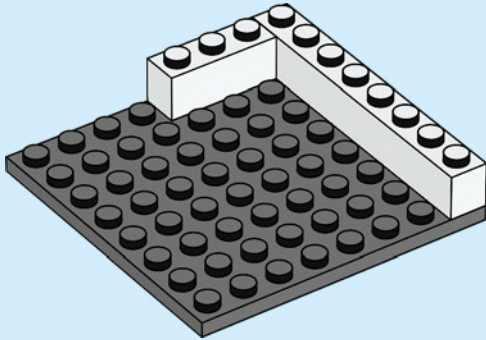

108

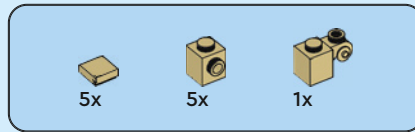
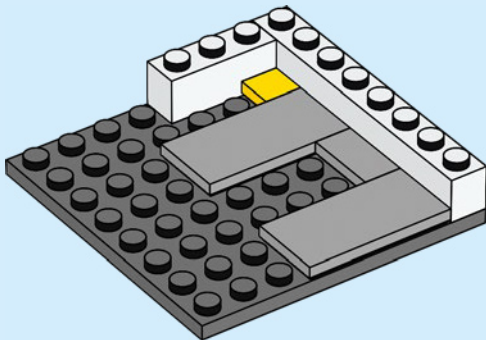

109

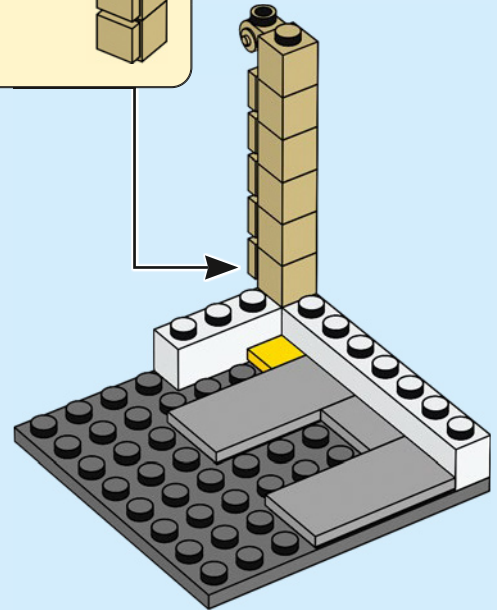
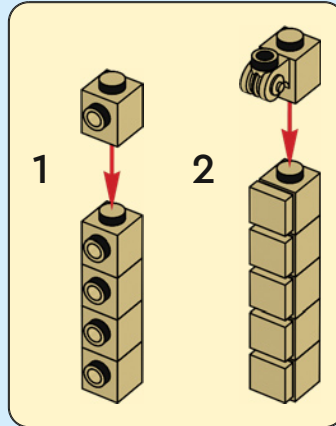

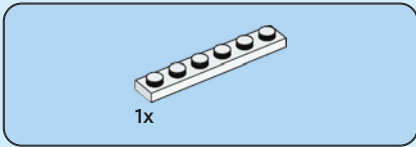

110

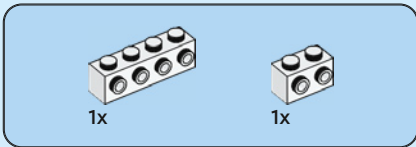
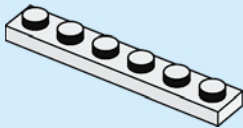

111

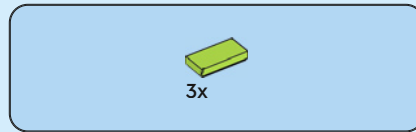
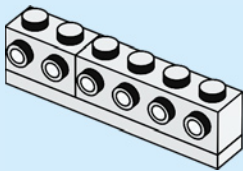

112

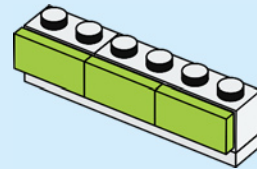

113

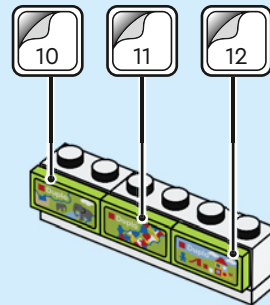

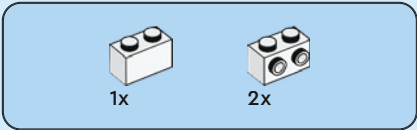

114

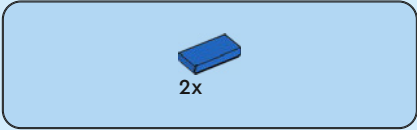
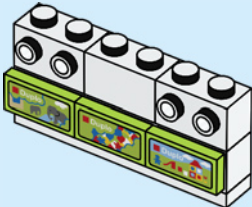

115

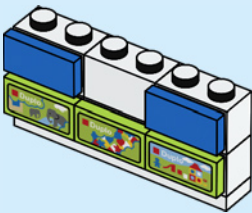

116

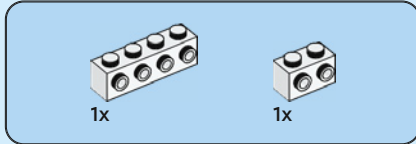
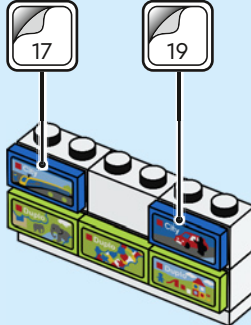

117

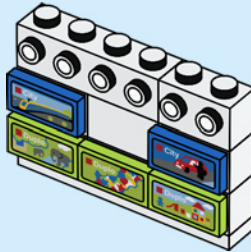



3x

118

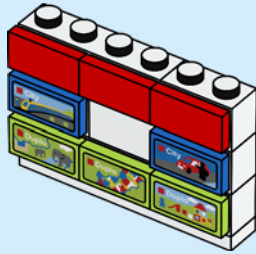

119

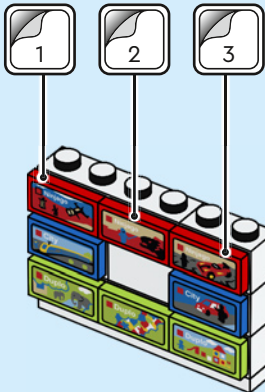

3x

120

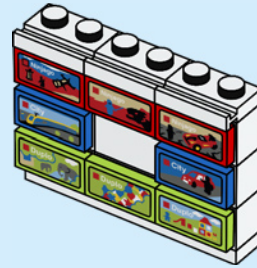

1x

121

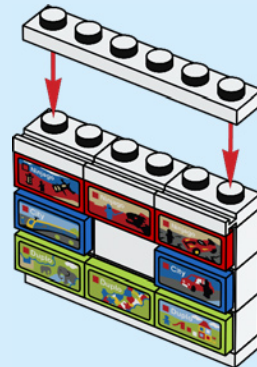

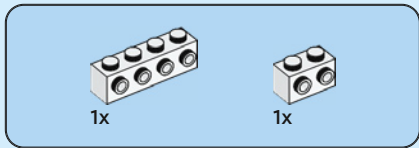

122

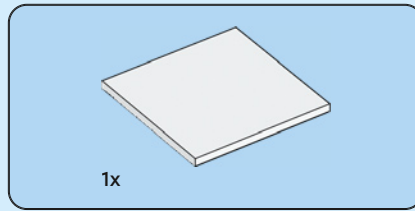
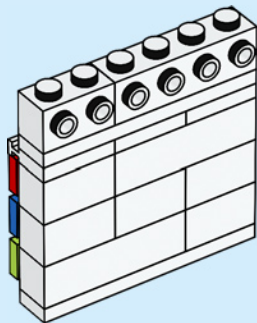

123

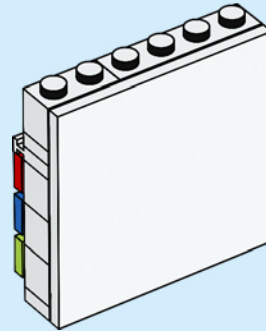

124

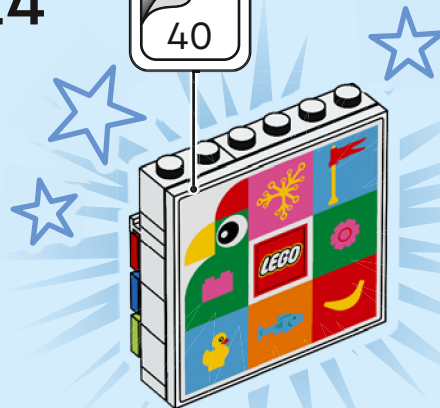

125

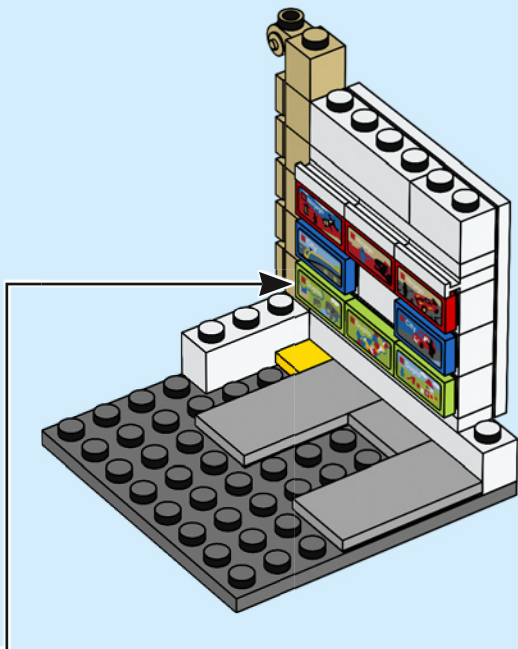

126

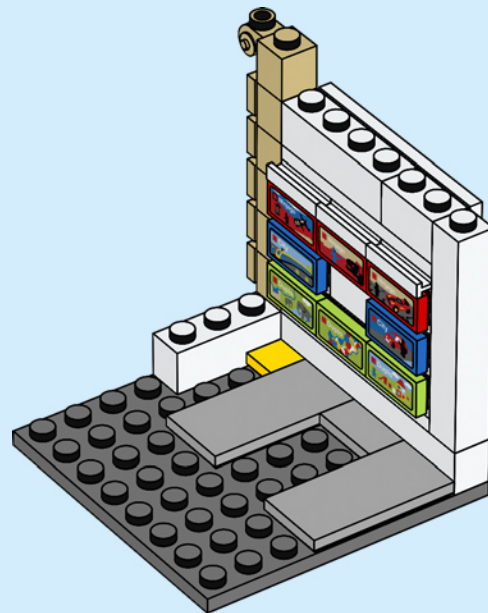
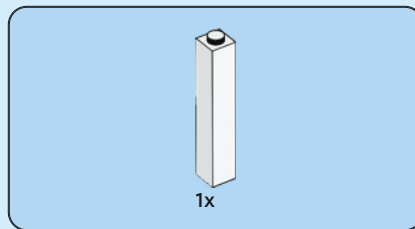

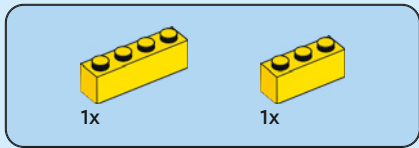

127

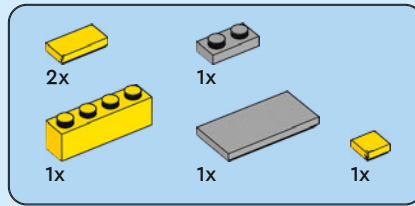
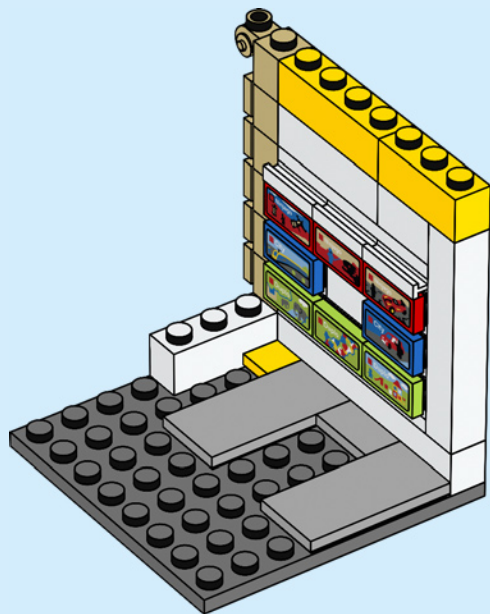

128

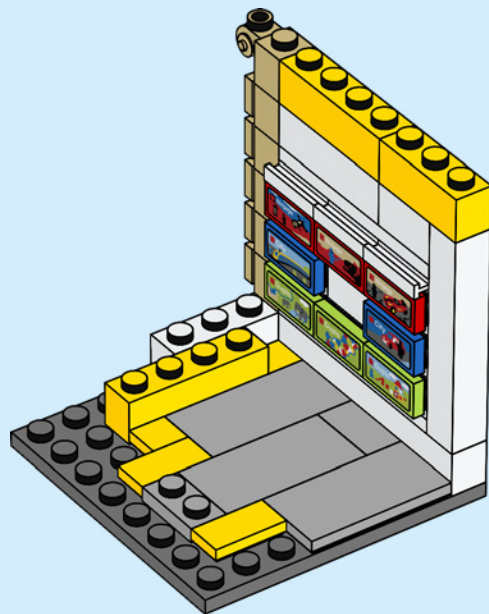

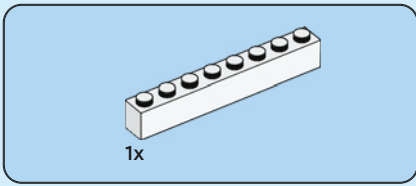

129

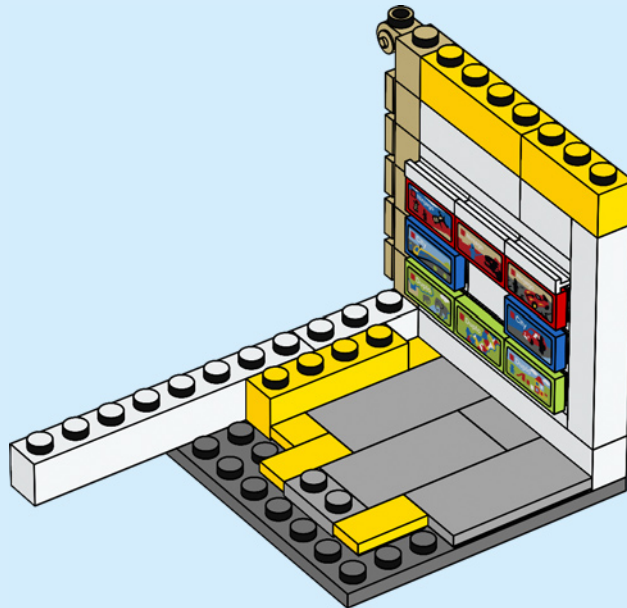

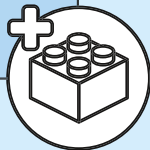
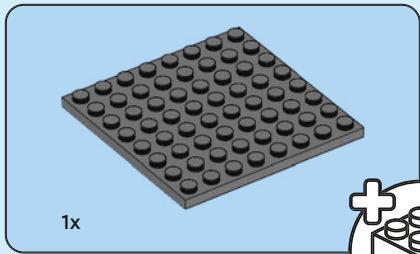

130

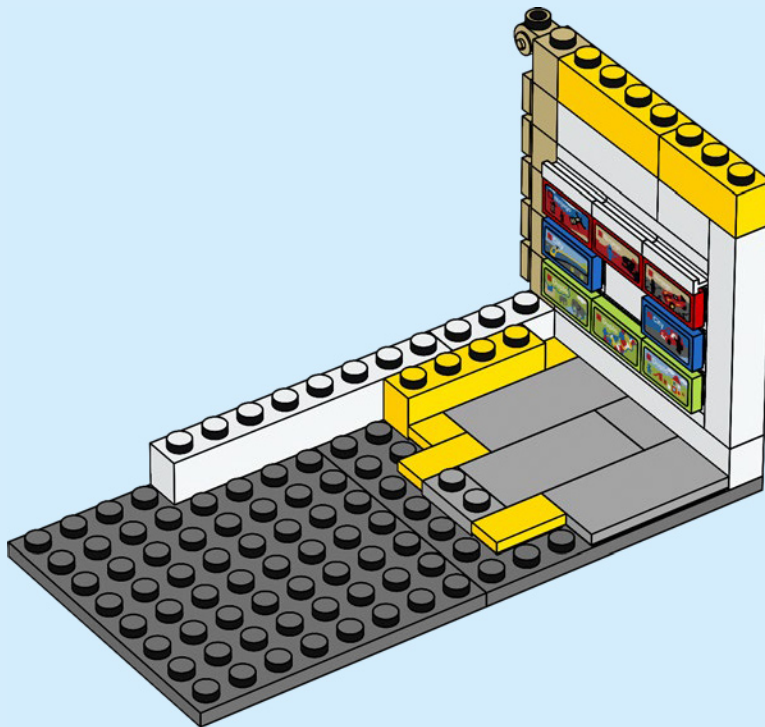

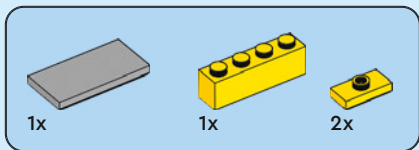

132

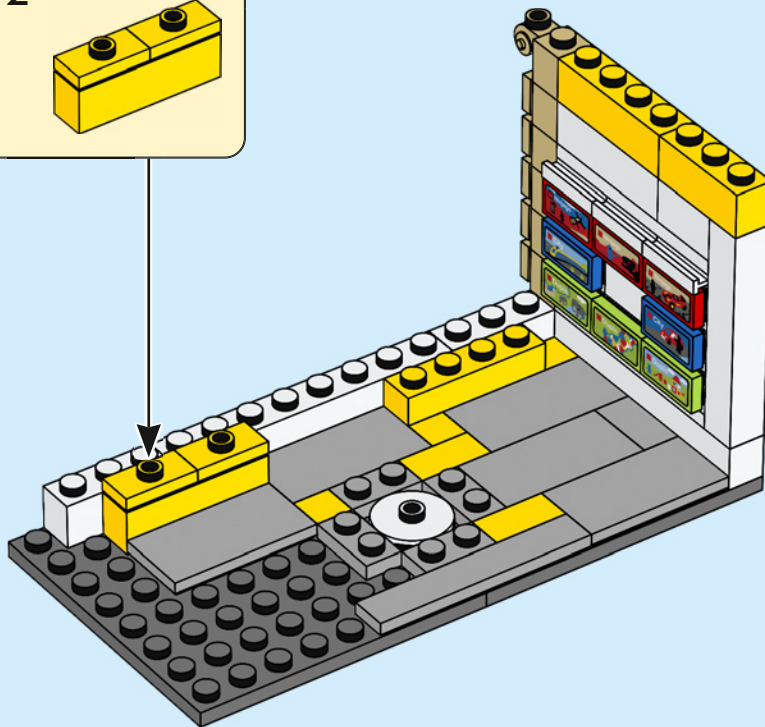
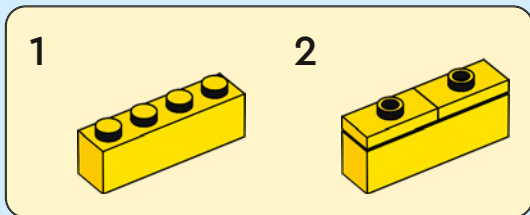

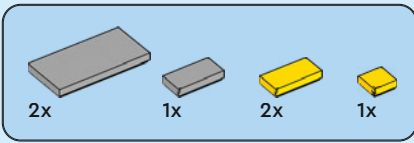

133

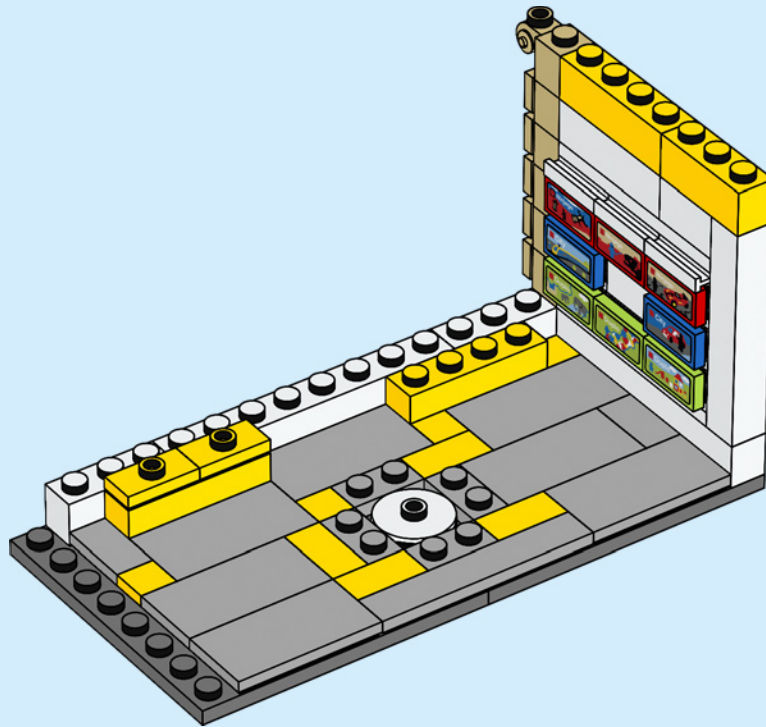

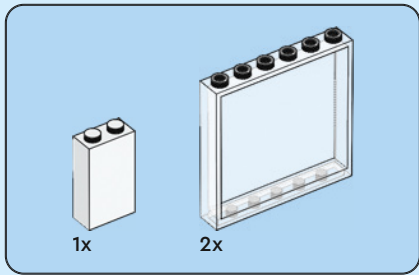

134

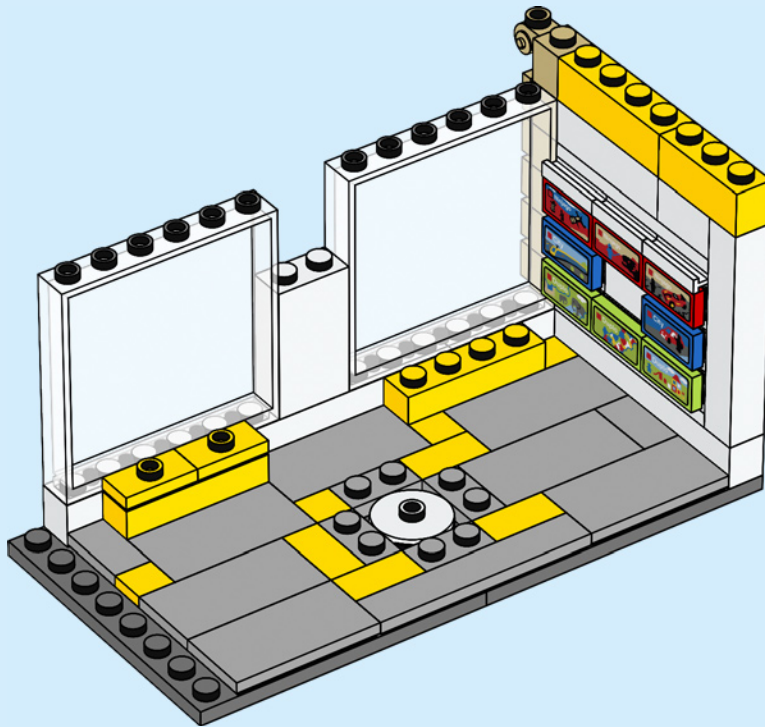

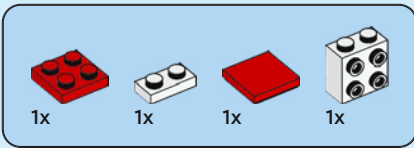

135

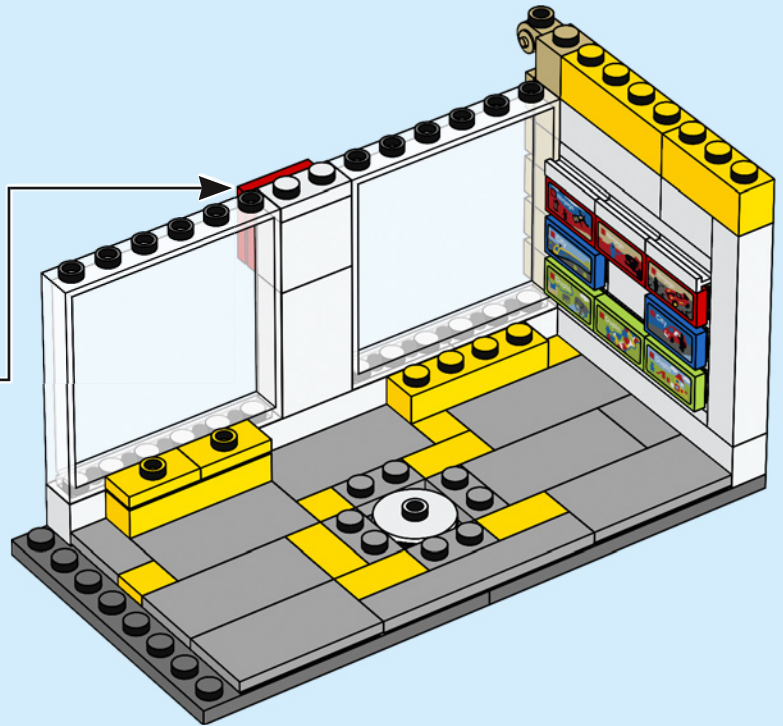
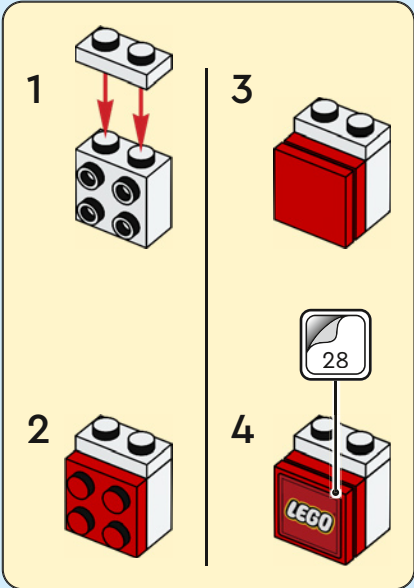

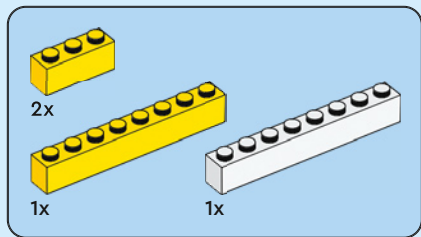

136

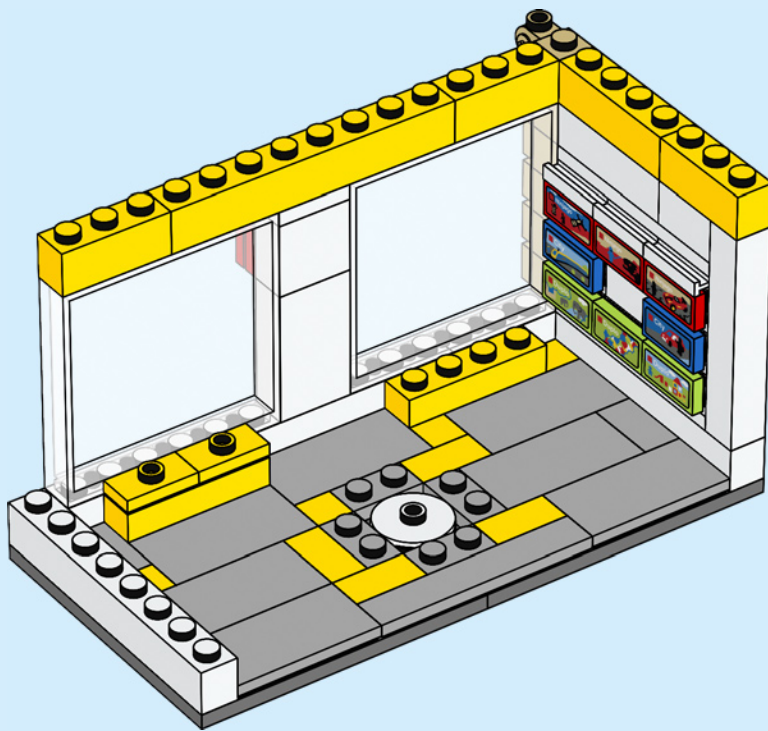



1x

137

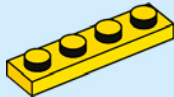

2x

138

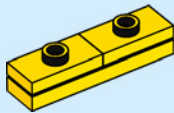

1x



1x



4x

139

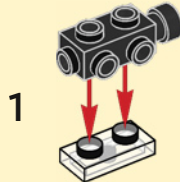

1

2



1x



1x



2x

140

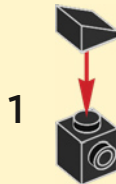

1

2

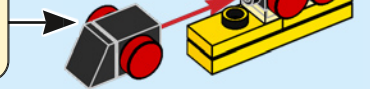



1x

141

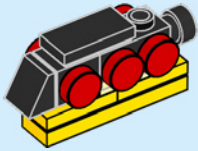

1x



1x



1x

142

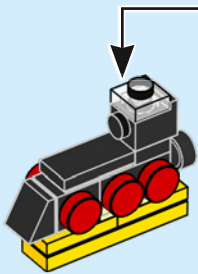

1

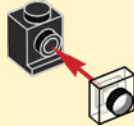

2

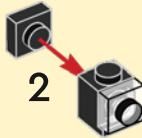

1x



1x

143

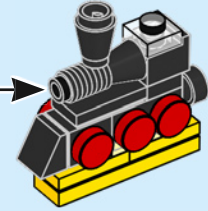
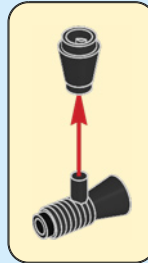

1x

144



145

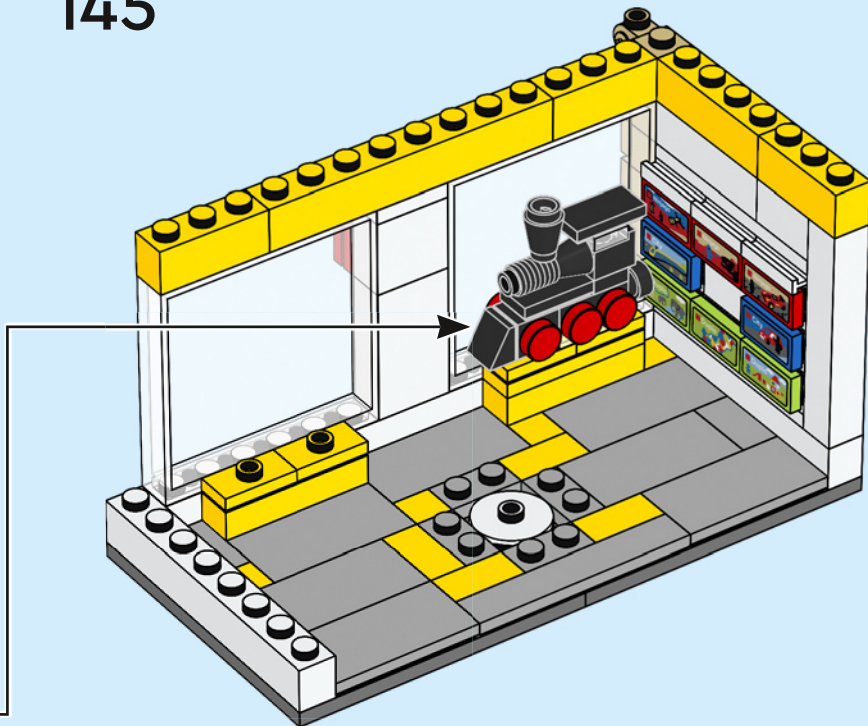

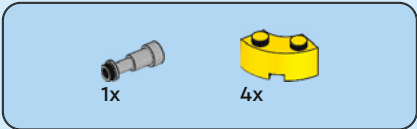

146

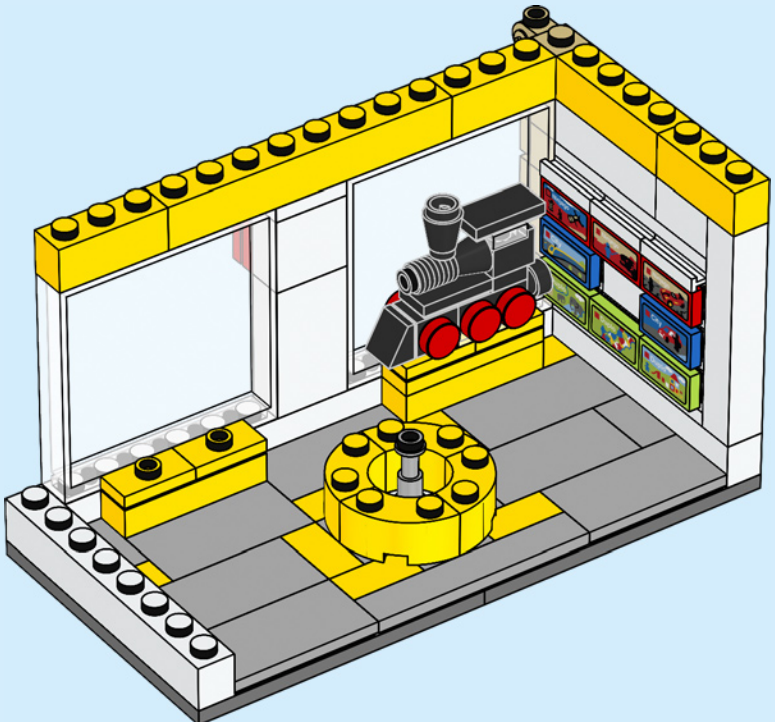



4x

147

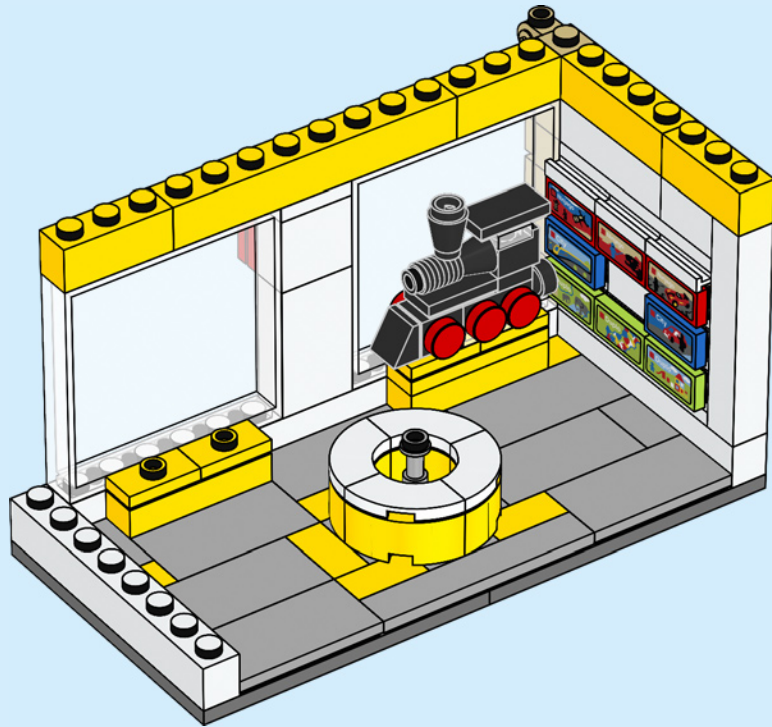

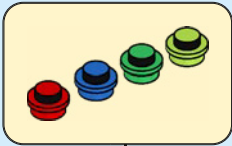

148

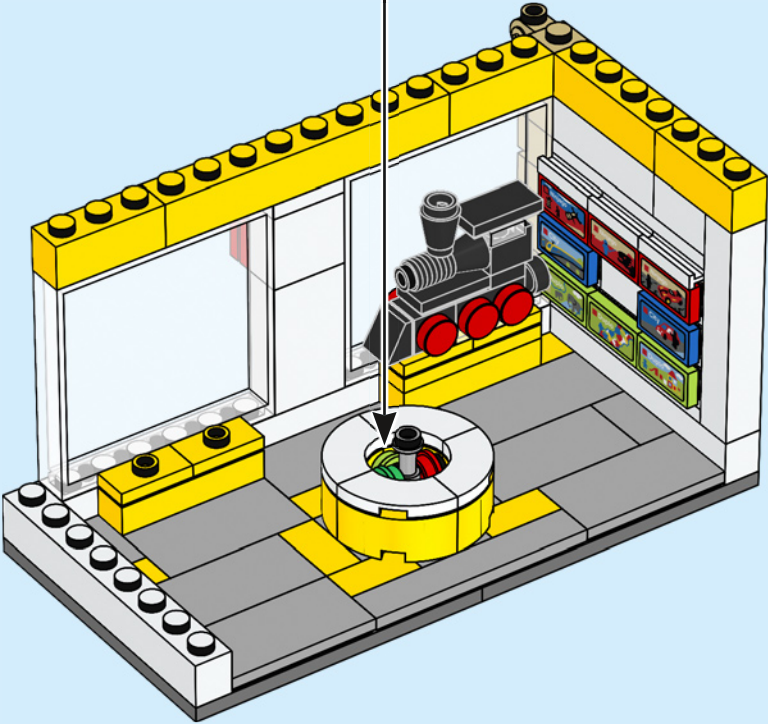

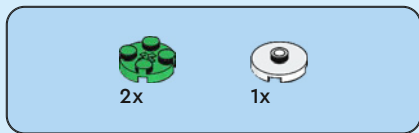

149

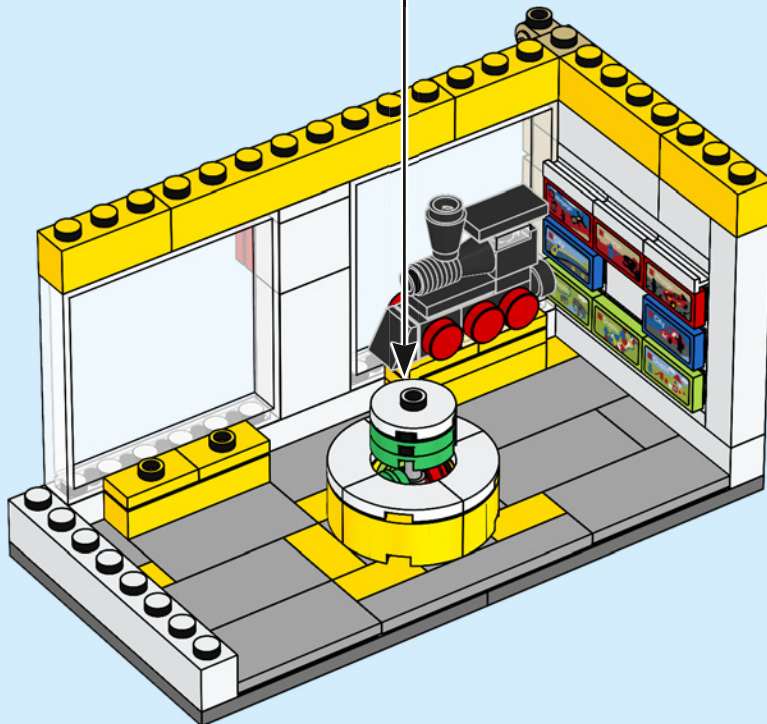
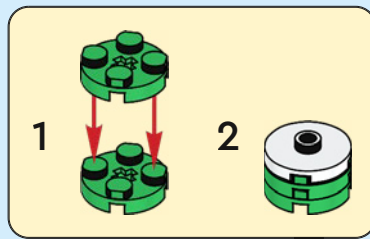



1x

150

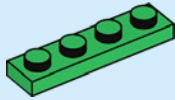

1x



1x



1x

151

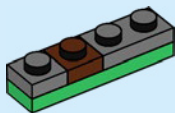

1x

152

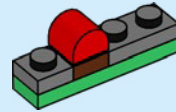

1x

153

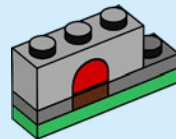



154

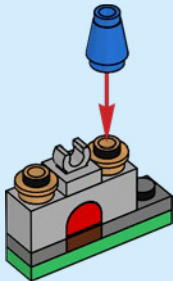

155

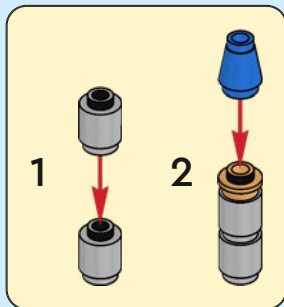
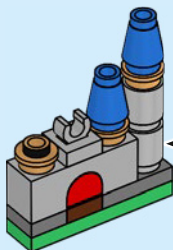

156

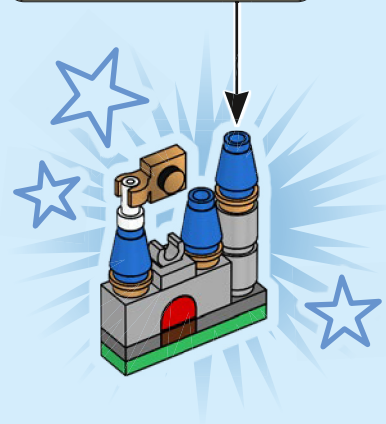
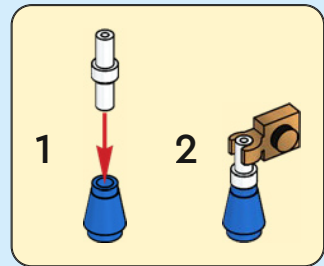

157



5x

5x

1x

158

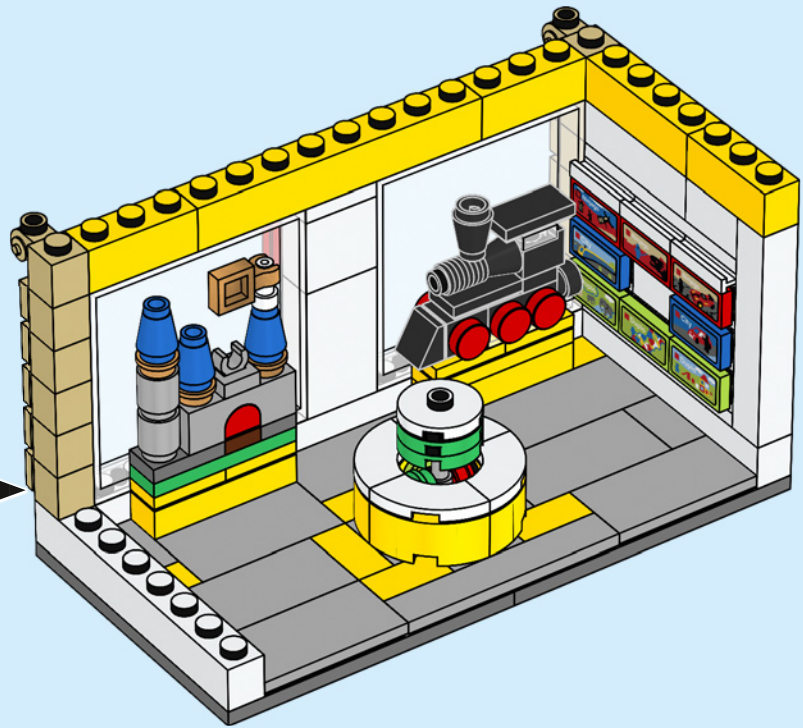
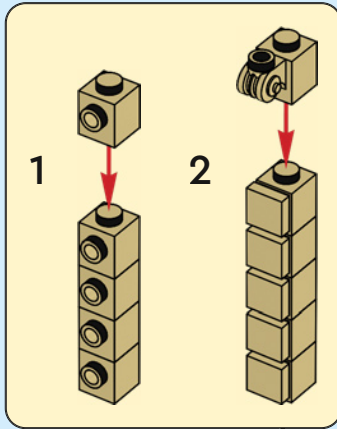

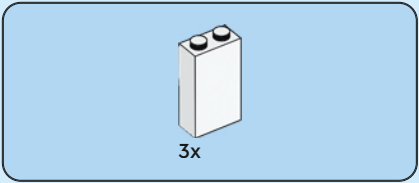

159

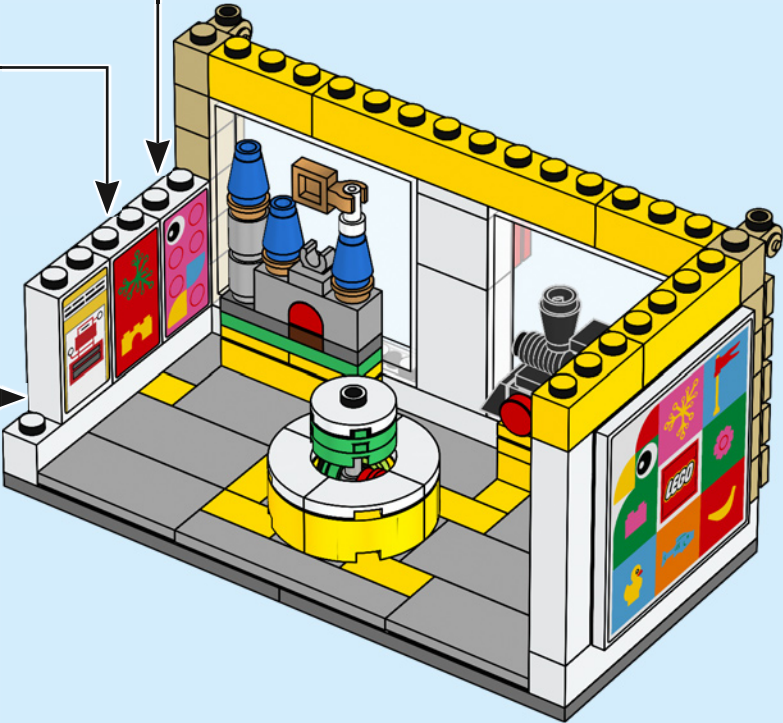
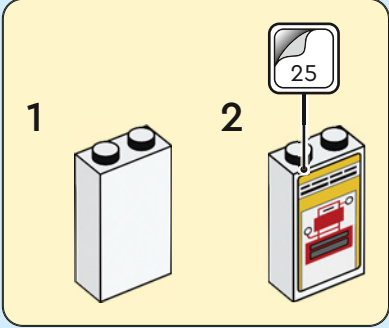
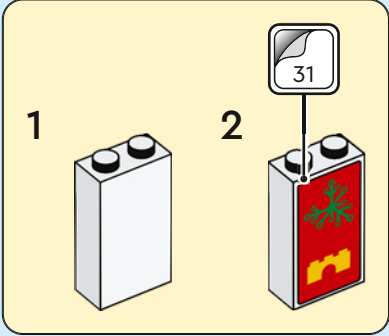
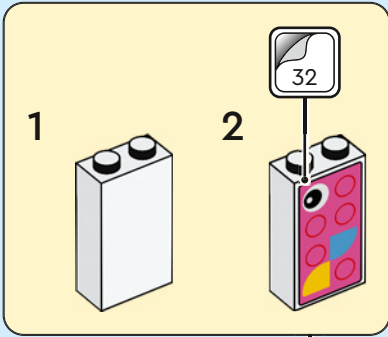

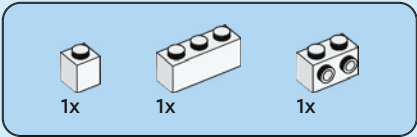

160

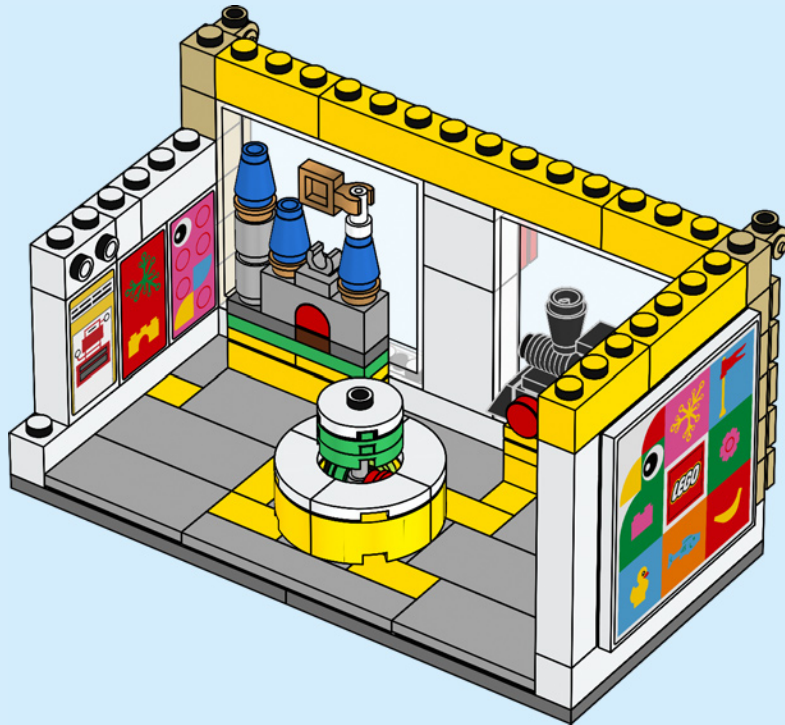

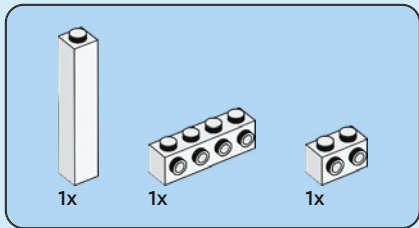

161

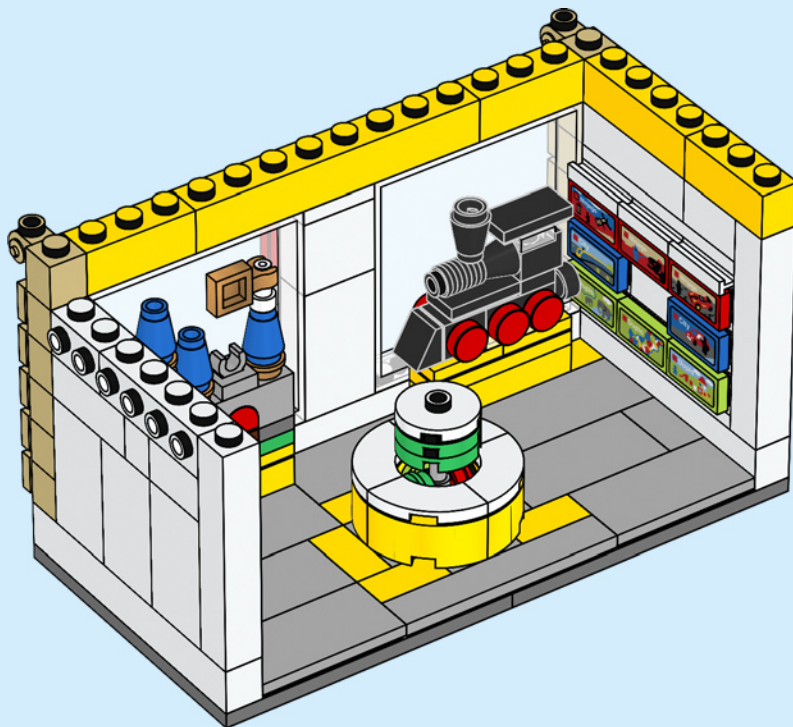

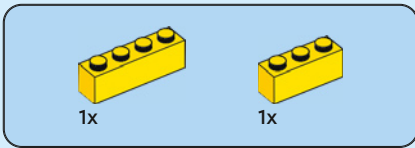

162



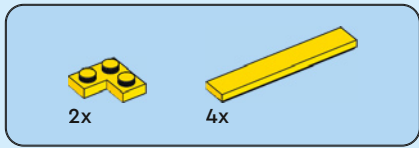

163

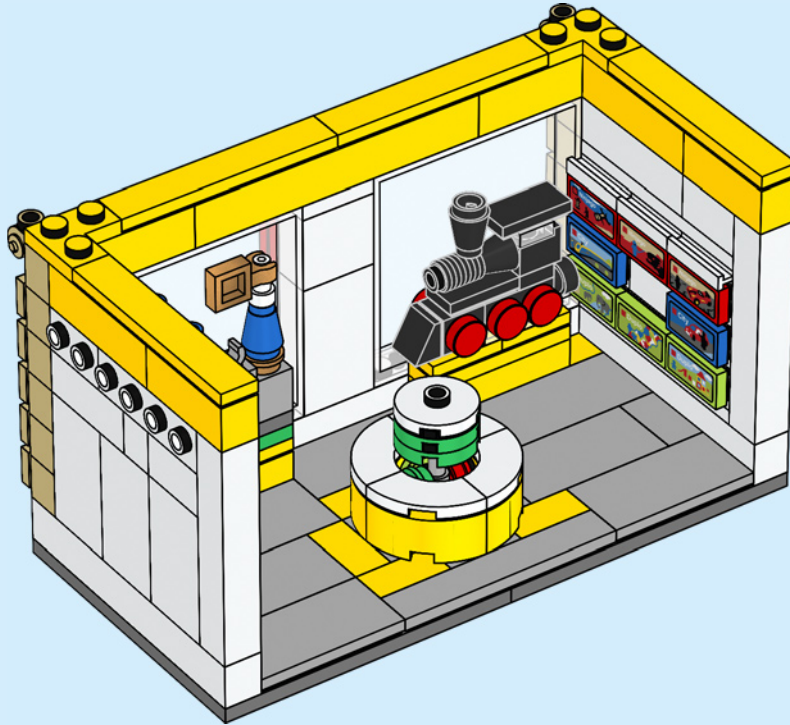

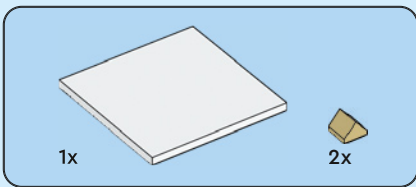

164

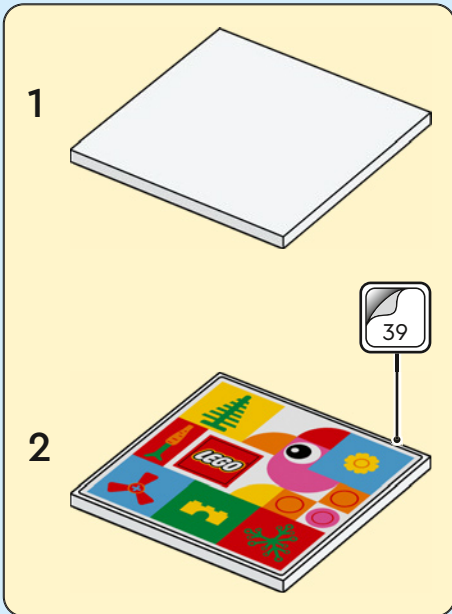

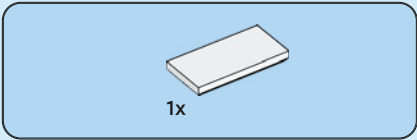

165

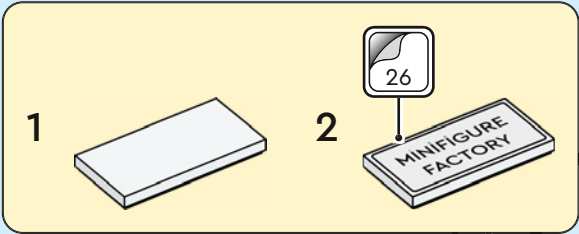

166

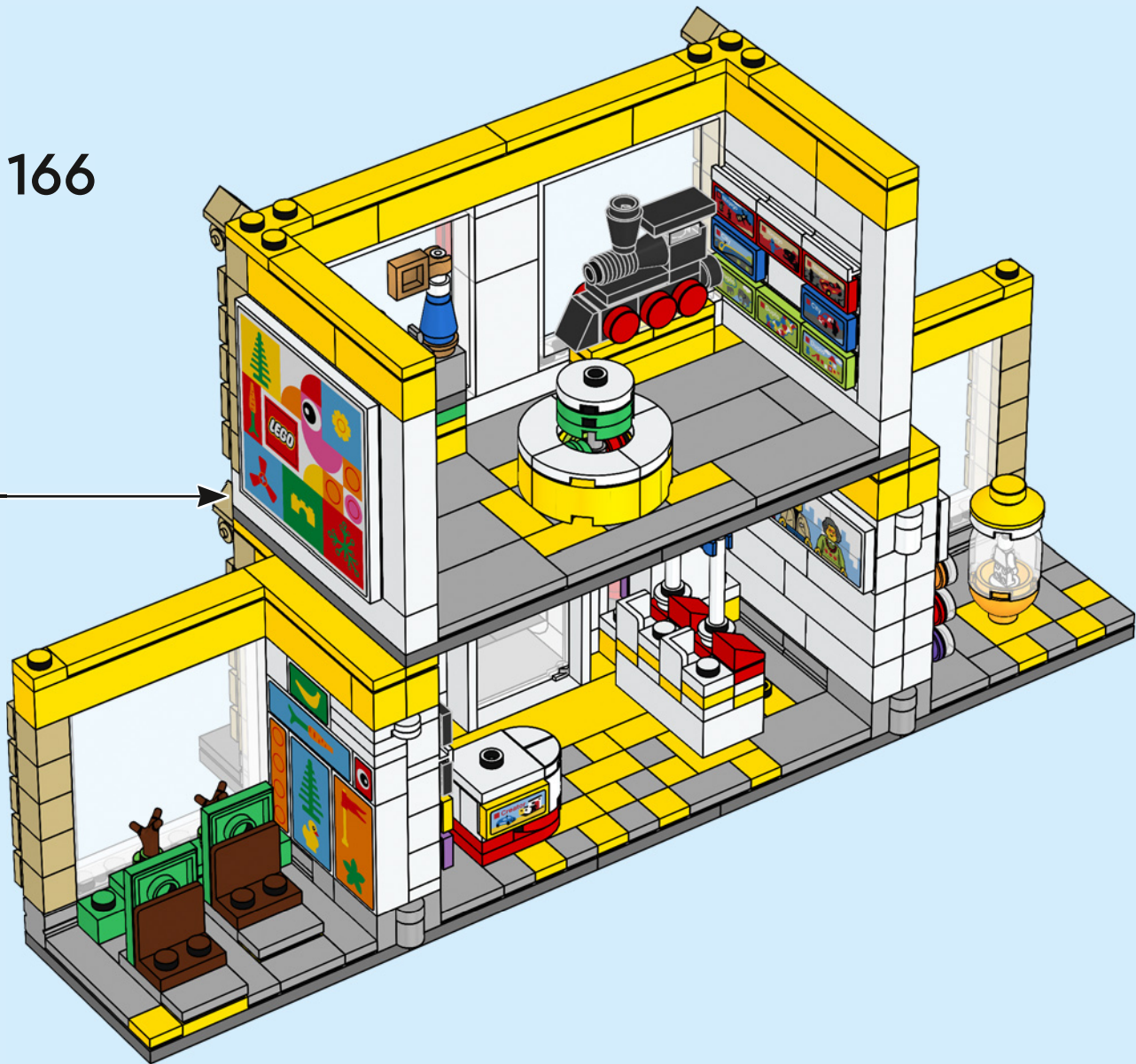

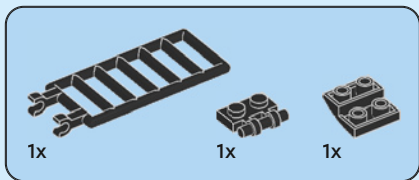

167

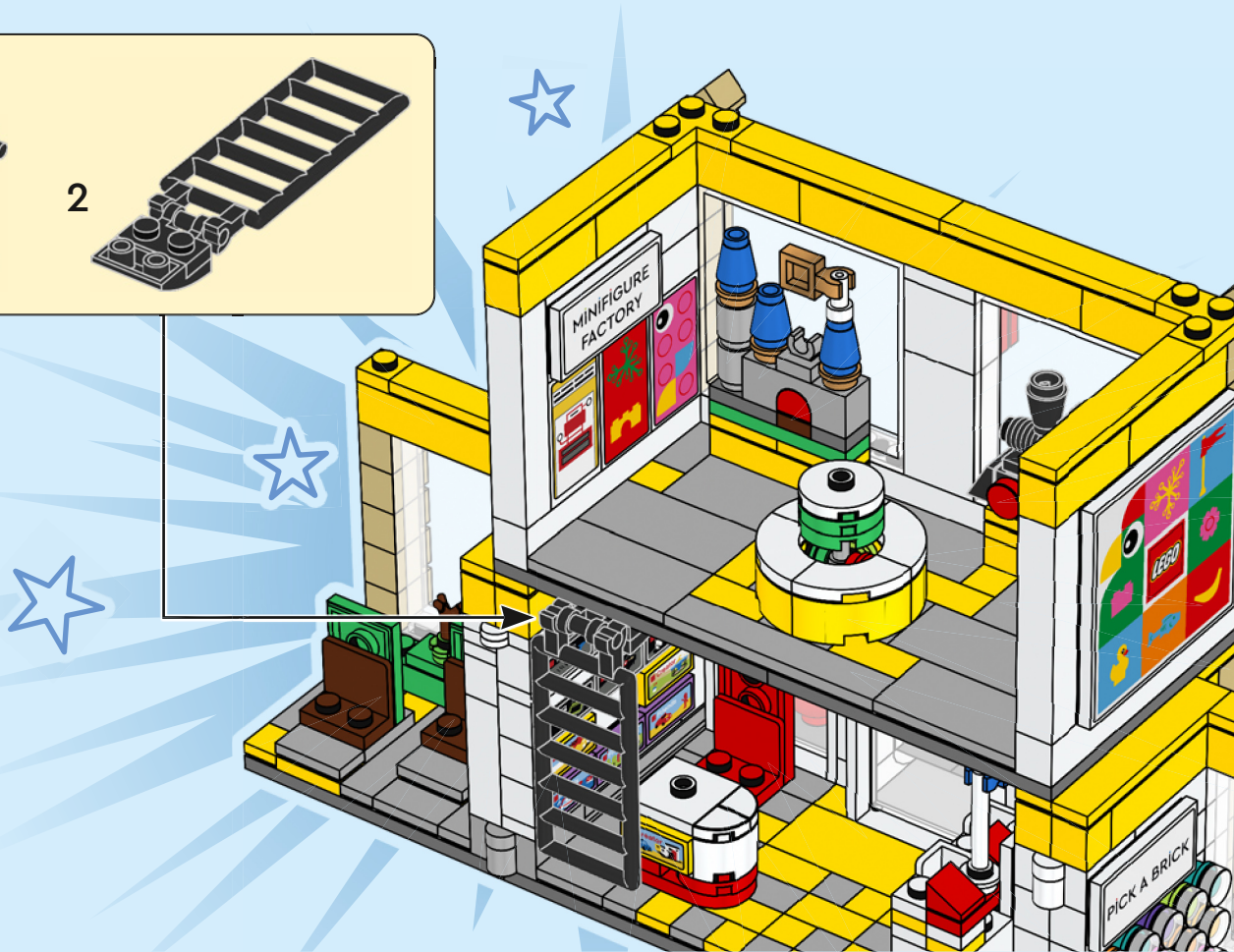
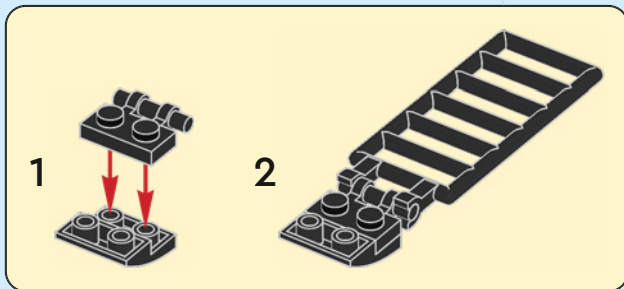







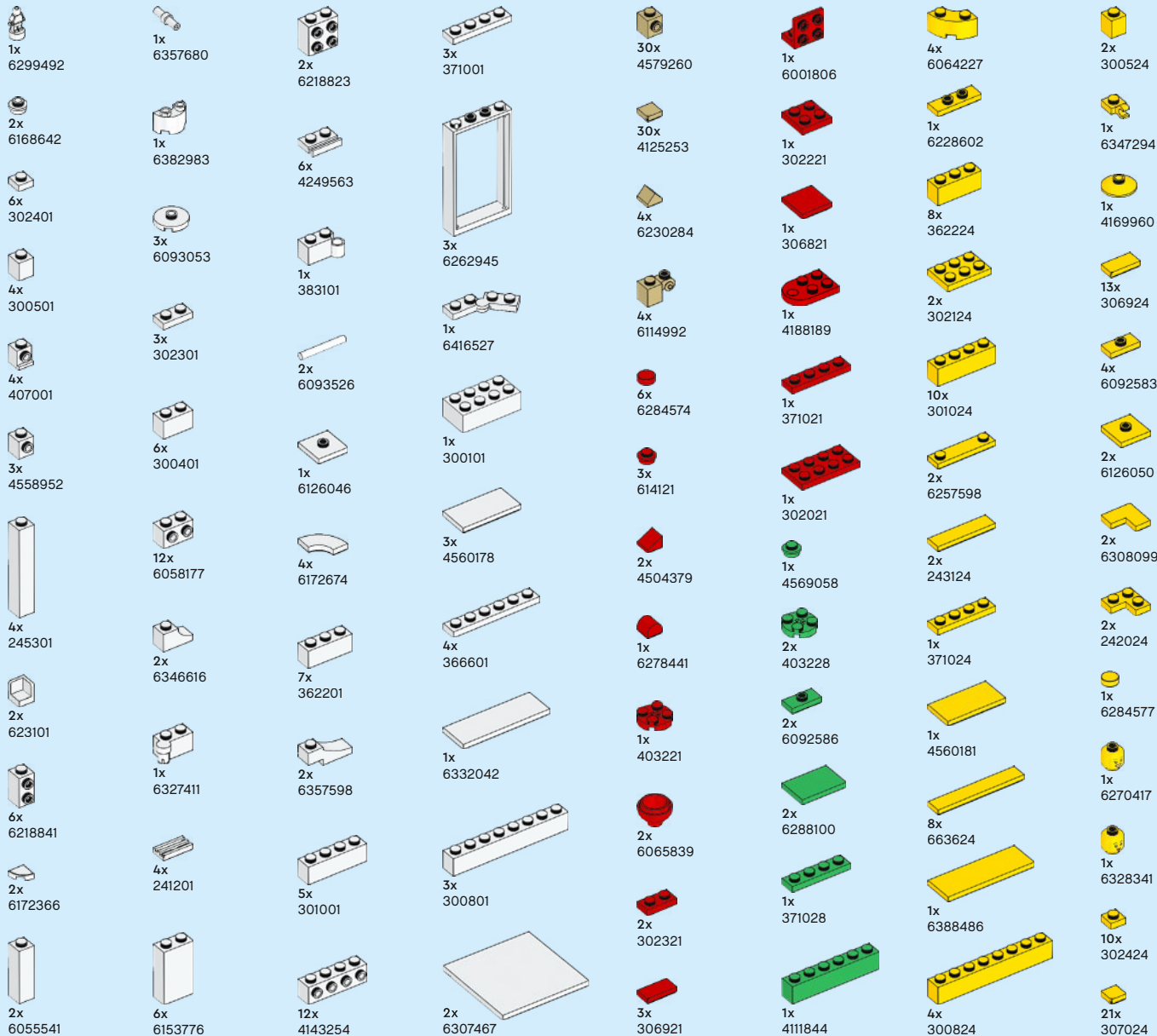

2x
6206150

1x
4529236

1x
602026

4x
4183133

1x
6308012

6x
6314891

1x
4211063

2x
4211055

2x
6235080

2x
302426

15x
6274738

2x
6286831

2x
6327412

11x
4560183

5x
4211052

2x
6126083

3x
4529235

1x
4504382

1x
6252041

3x
4500125

4x
6000066

1x
4211549

1x
4210719

1x
614123

1x
407026

1x
6286876

3x
6331261

14x
4211414

1x
6386209

2x
4210794

1x
6347291

1x
4214559

1x
6240204

1x
6378055

4x
4211398

2x
6195315

1x
4211122

4x
306923

1x
6365482

2x
6256058

2x
6345847

1x
4657366

2x
4566522

2x
4210802

1x
4529755

8x
306926

1x
6247362

2x
4211183

2x
4211461

3x
6190252

2x
4211114

2x
4157103

1x
434926

4x
6245253

1x
4221744

2x
6212077

1x
6284379

2x
6325978

1x
4140588

2x
6226436

1x
4645397

4x
6152645

1x
6294404

1x
6211476

2x
4211412

1x
6171894

1x
6400045

1x
6016059

1x
4523339

2x
4211389

6x
4211356

Customer Service
 Kundenservice
 Service Client
 Assistenza clienti
 Atención al cliente
 Serviço de Apoio ao Consumidor
 Ügyfélszolgálat
 Klientu apkalpošanas dienests
 Serviciul pentru clienț
 客户服务
 コンシューマーサービス
 고객 서비스
LEGO.com/service

WIN

Terms & Conditions apply

Scan this QR code or go to **LEGO.COM/PRODUCTFEEDBACK** and give us your short feedback about this LEGO® set for a chance to win a cool LEGO prize.



GEWINNE

Scanne diesen QR-Code oder geh auf LEGO.COM/PRODUCTFEEDBACK

und gib uns dein kurzes Feedback zu diesem LEGO® Set. Dann hast du die Chance, einen coolen LEGO Preis zu gewinnen.

Es gelten die Teilnahmebedingungen

GAGNE

Scannez ce code QR ou rendez-vous sur LEGO.COM/PRODUCTFEEDBACK

pour donner votre avis sur ce produit LEGO® et avoir une chance de gagner un prix LEGO.

Voir Conditions Générales

GANA

Escanea este código QR o visita LEGO.COM/PRODUCTFEEDBACK

y comparte con nosotros tu opinión sobre este set LEGO® para tener la oportunidad de ganar un fantástico premio LEGO.

Términos y Condiciones aplicables

获取奖品

只需扫描此二维码或访问 LEGO.COM/PRODUCTFEEDBACK,

就这款乐高®套装提供简短反馈, 就有机会赢得很酷的乐高奖品。

《条款及条件》适用