



BRICK HEADZ

40545



[LEGO.com/brickheadz](https://www.LEGO.com/brickheadz)



Stiamo passando dagli imballaggi di plastica a quelli basati su carta. Ecco perché potrete trovare un mix di carta e di plastica nelle nostre confezioni!

Estamos sustituyendo las bolsas de plástico por bolsas con base de papel. ¡Por eso, puede que encuentres una mezcla de papel y de plástico en nuestras cajas!

Estamos a substituir as nossas embalagens de plástico por embalagens à base de papel. Por isso poderá encontrar um misto de papel e plástico nas nossas caixas!

Átállunk a műanyagról a papír alapú csomagolásra. Ezért előfordulhat, hogy a dobozainkban papír és műanyag zacskót egyaránt találsz!

We're switching from plastic to paper-based packaging. That's why you might find a mix of paper and plastic in our boxes!

Wir stellen von Kunststoffverpackungen auf Verpackungen auf Papierbasis um. Möglicherweise findest du deshalb sowohl Papier als auch Kunststoff in unseren Boxen!

Nous abandonnons progressivement les emballages en plastique au profit d'emballages à base de papier. Il est donc possible que vous trouviez à la fois du papier et du plastique dans nos boîtes !

Mēs pārejam no plastmasas iepakojuma uz iepakojumu, kurā izmantots papīrs. Tāpēc mūsu kārbās var būt gan papīra, gan plastmasas daļas.

Trecem de la ambalajele din material plastic la ambalaje pe bază de hârtie. Iată de ce s-ar putea să găsești un amestec de hârtie și material plastic în cutiile noastre!

我们正在从塑料包装向纸基包装过渡。这就是为什么你可能会发现我们的包装盒中同时出现塑料和纸质材料！

LEGO.com/sustainable-packaging



PETS
HAUSTIERE
ANIMAUX DE COMPAGNIE
ANIMALI DOMESTICI
MASCOTAS
ANIMAIS DE ESTIMAÇÃO
HÁZI KEDVENCEK
MĀJZÍVNÍEKI
宠物

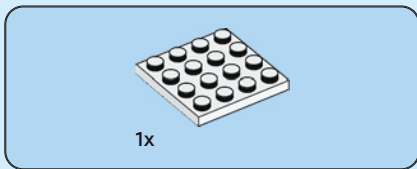
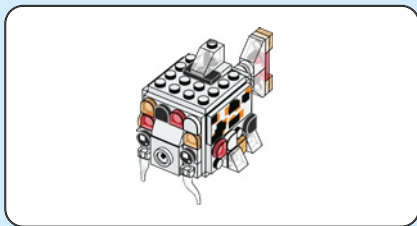

1

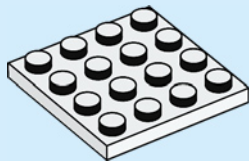



6x

2

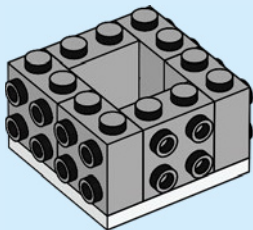

6x

3

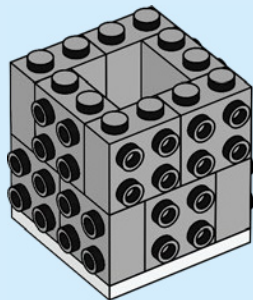



2x



1x



1x

4

1

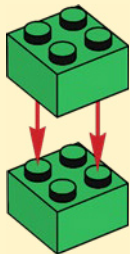

2

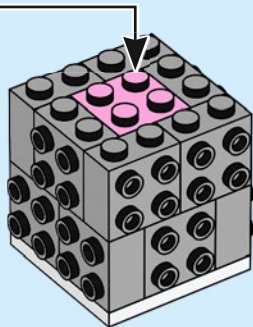
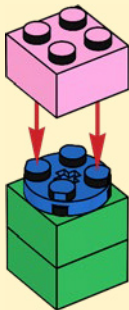

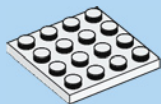

1x

5

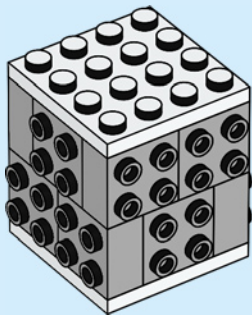

1x



1x



1x

6

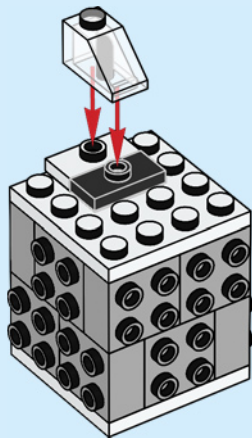

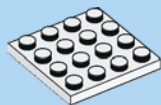

1x



1x

7

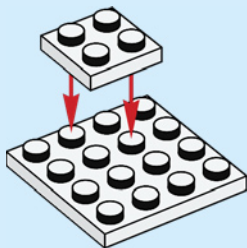

1x

8

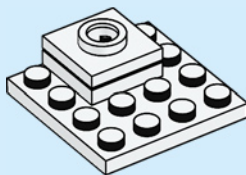



2x



2x

9

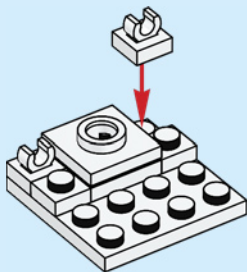

2x

10

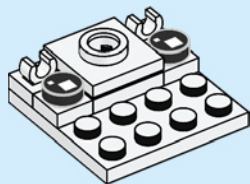



1x



1x



1x

11

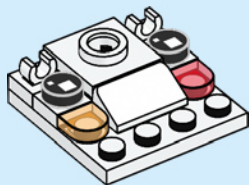

1x



1x



1x



1x

12

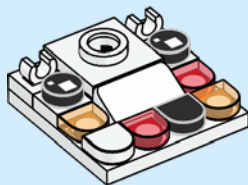

13

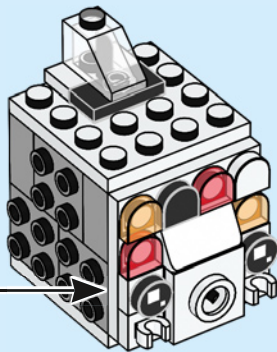

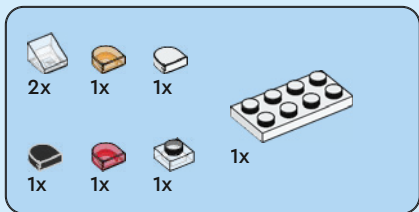

14

1

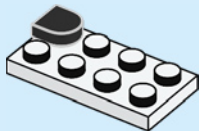

2



3

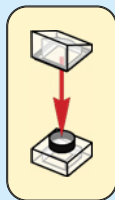
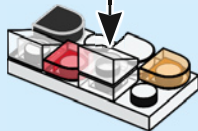

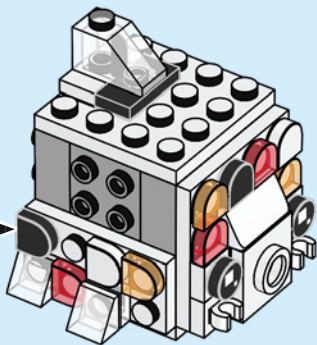

1x

15

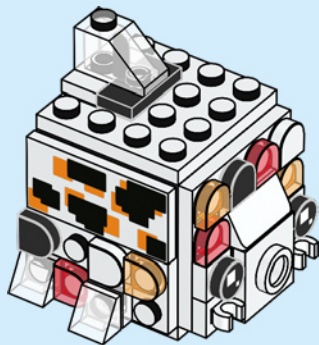

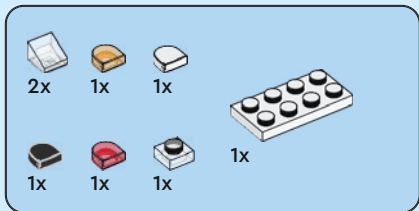

16

1

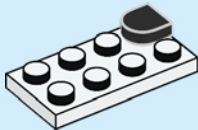

2

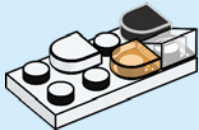

3

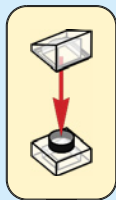
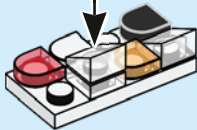

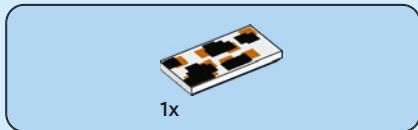
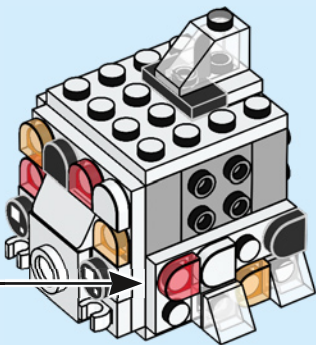

17

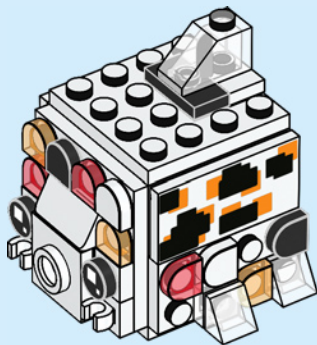

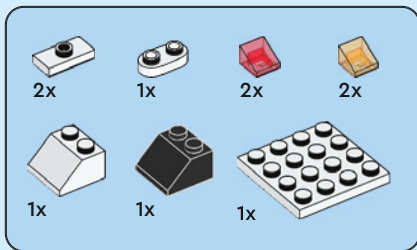

18

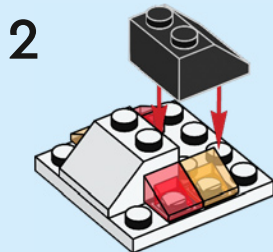
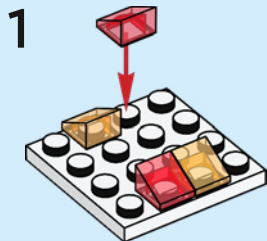

3

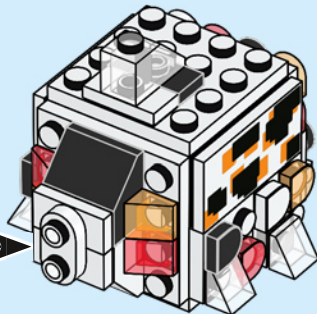
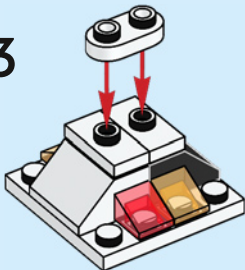



2x



1x



2x



2x



2x

19

1

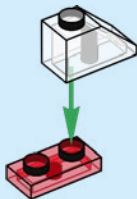

2

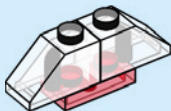

3

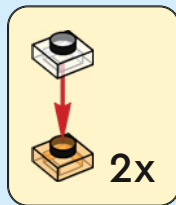
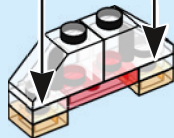

4

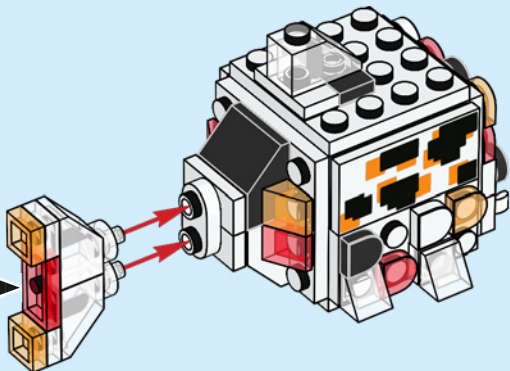
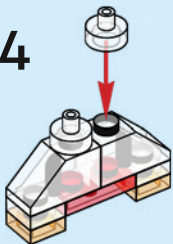

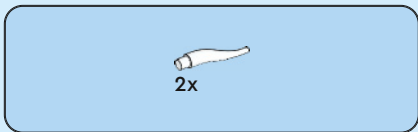

20

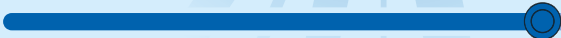
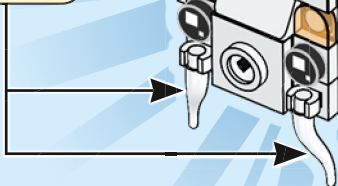
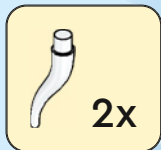

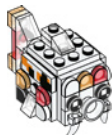

1x



1x

1

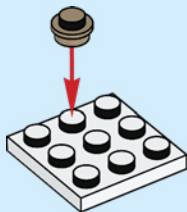

2x

2

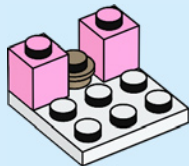

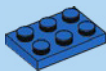

1x



1x

3

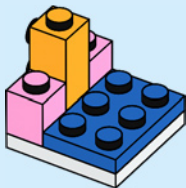

1x



2x



1x

4

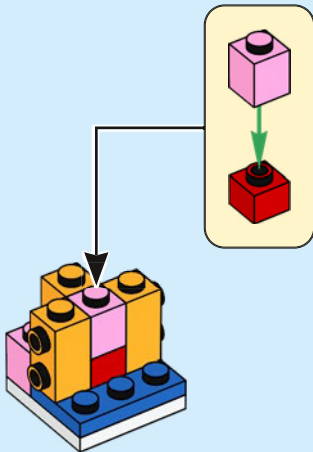



1x



2x

5

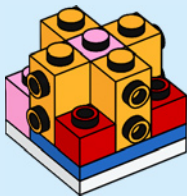

4x

6

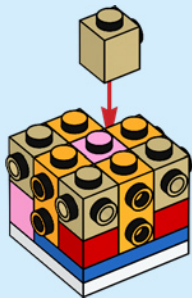



1x

7



1x



2x

8

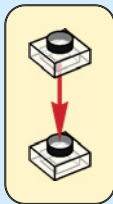



1x



1x

9

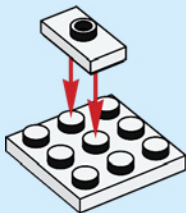

2x



2x

10

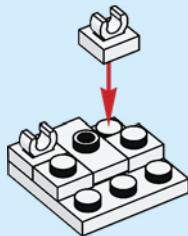



1x



1x



1x



2x

11

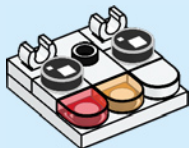

1x

12



13

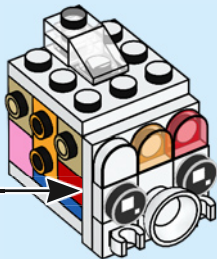

1x

14





1x



1x



1x



1x



1x



1x

15

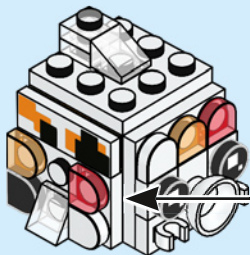

1

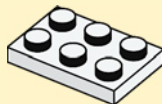

2



3





1x

16





1x



1x



1x



1x



1x



1x

17

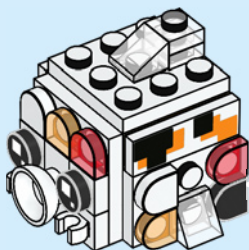

1



2



3





2x



1x

18

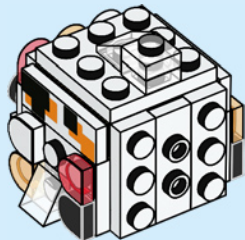

1x



1x



1x

19

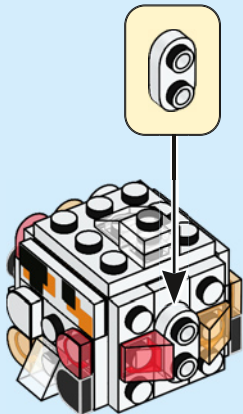

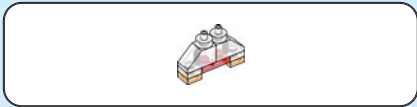

20

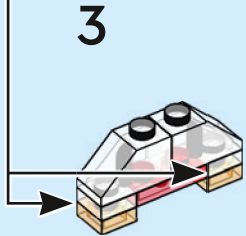
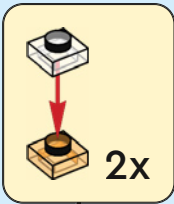
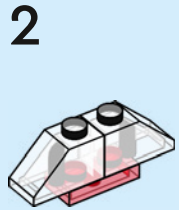
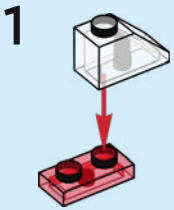

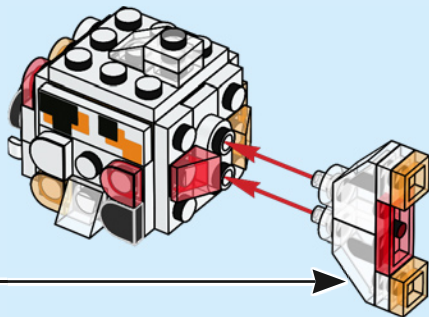
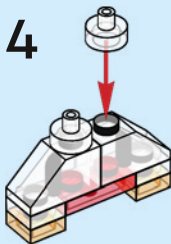



21

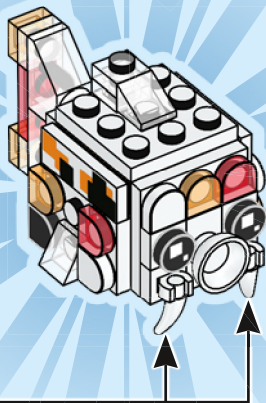

2x

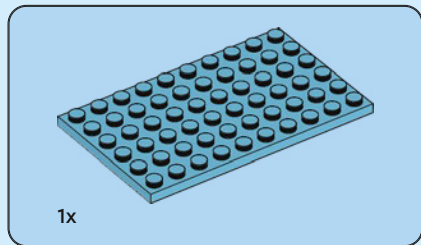
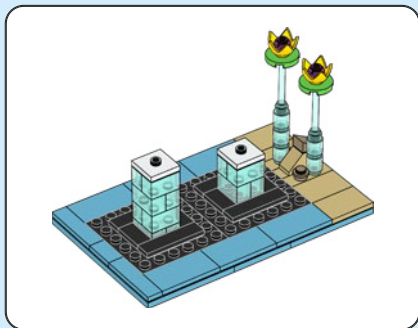

1

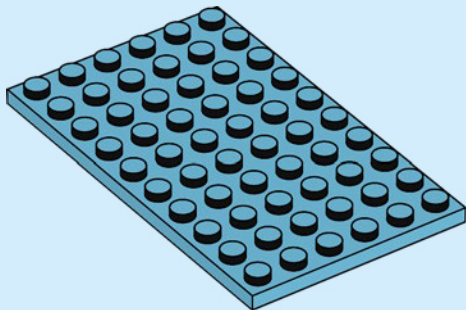

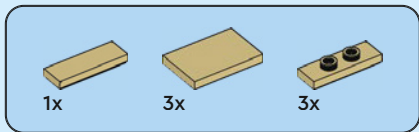

2

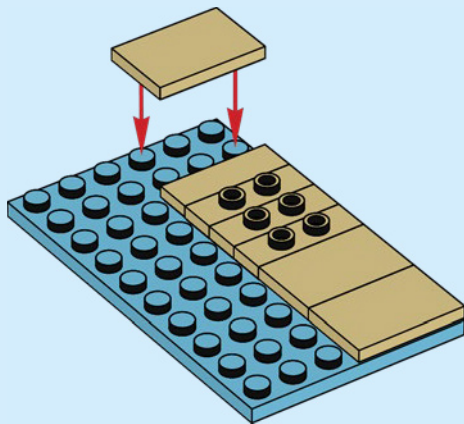

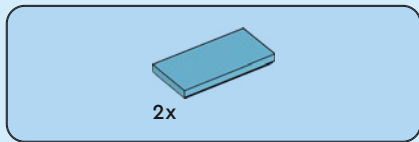

3

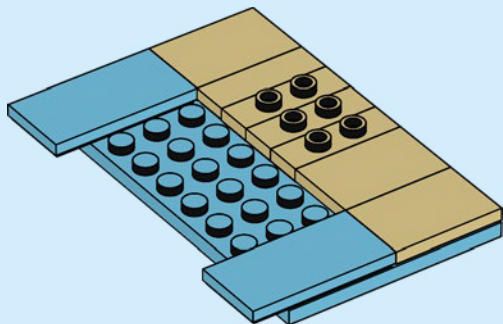

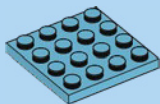

2x

4

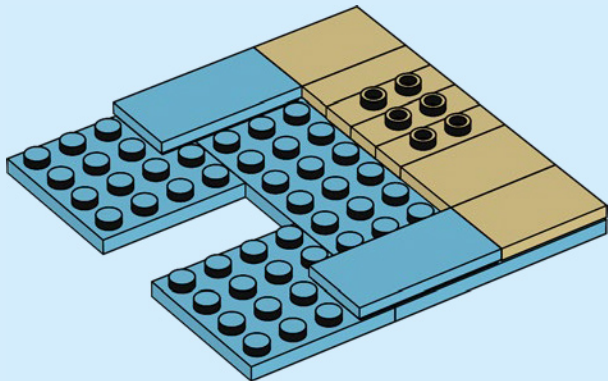

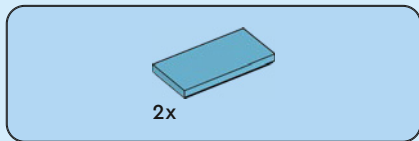

5

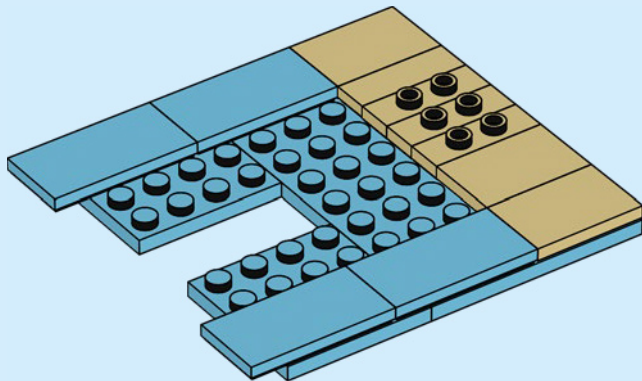

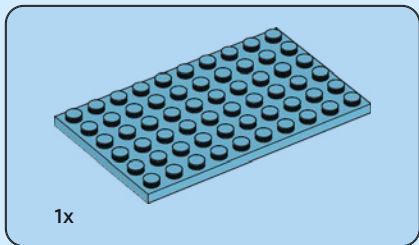

6

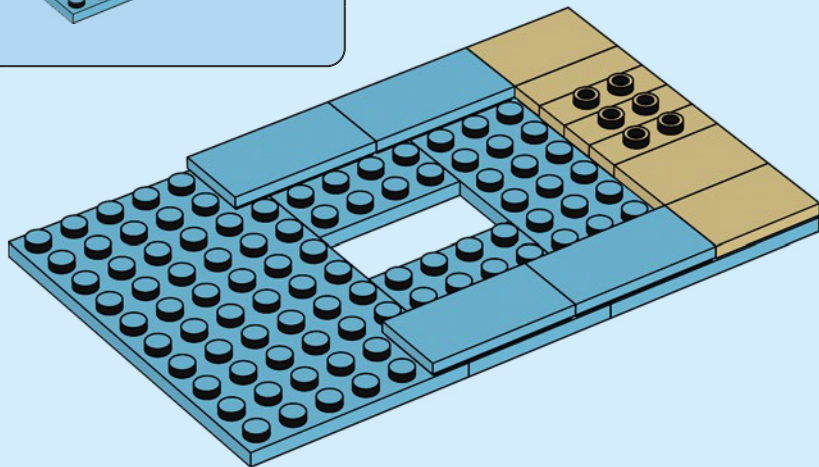

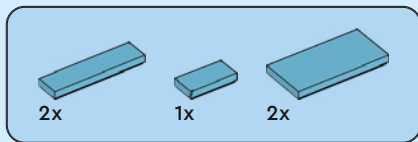

7

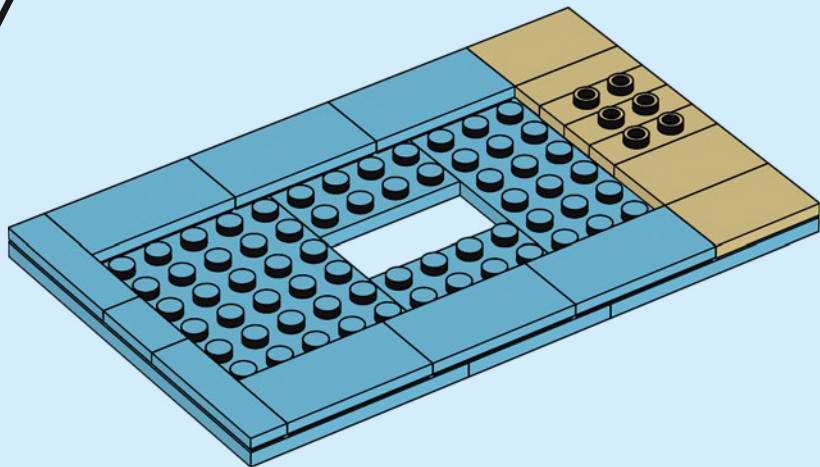



1x



1x

8

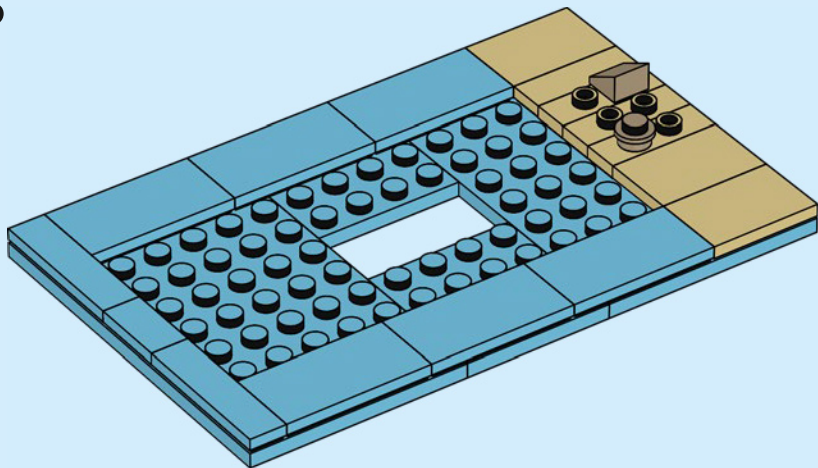

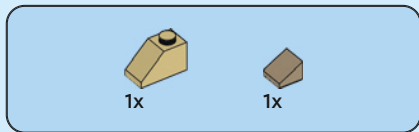

9

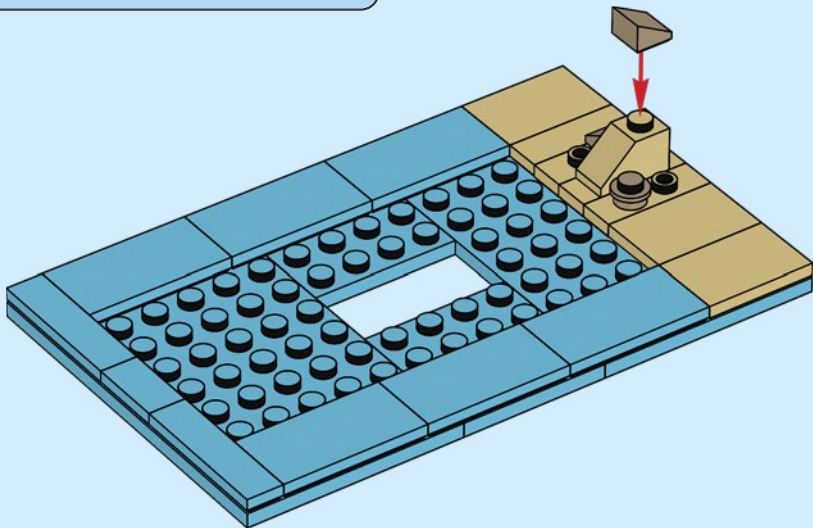

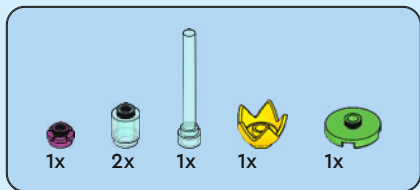

10

1



2



3

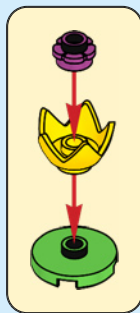
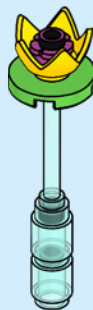

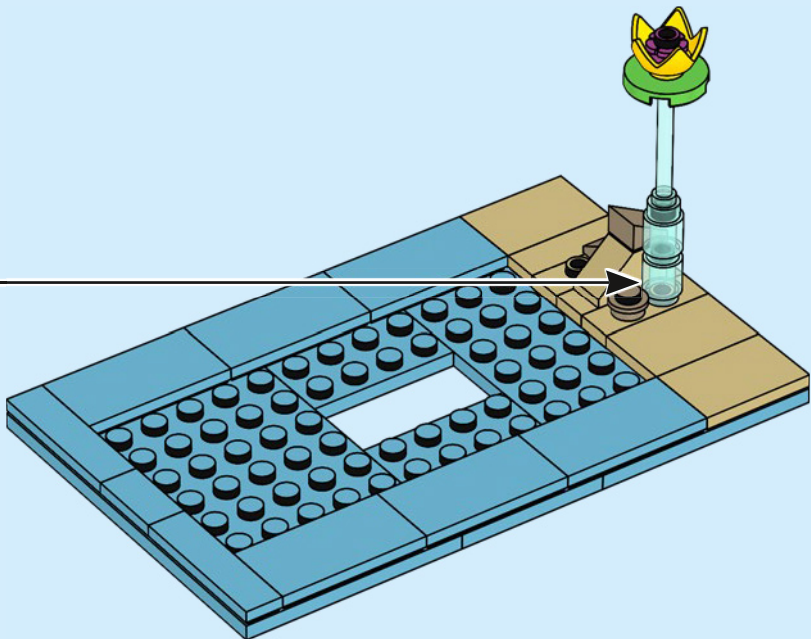

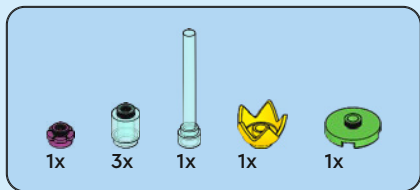

11

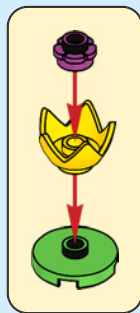
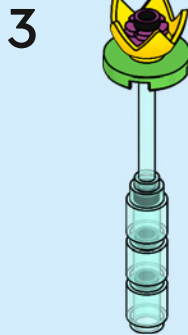
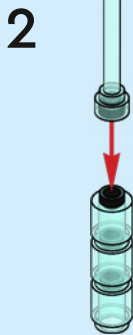

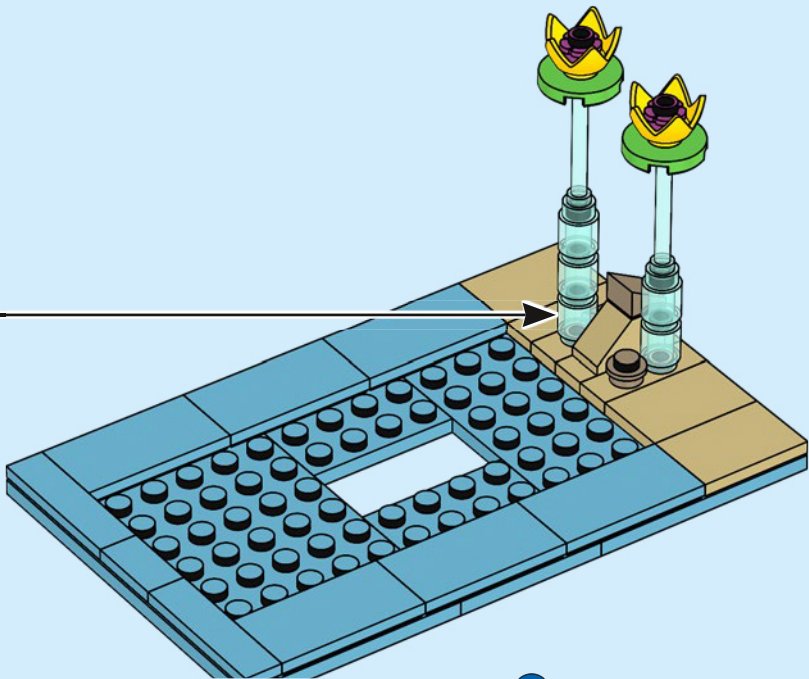

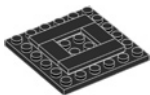

2x

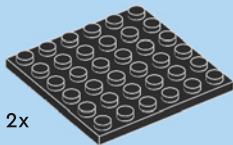

2x



4x



4x

12

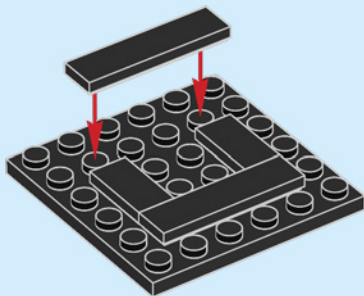

2x

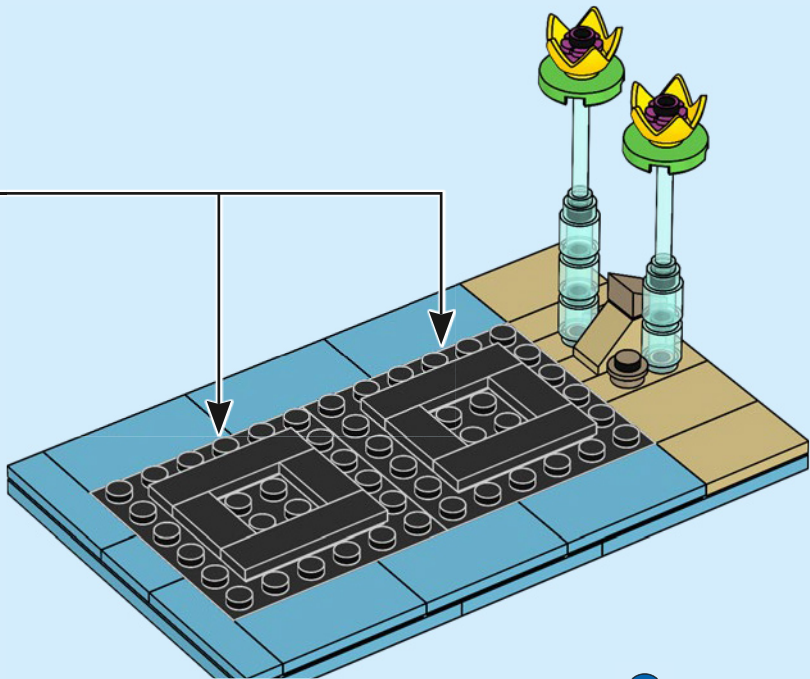



1x



1x



4x

13

1

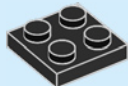

2

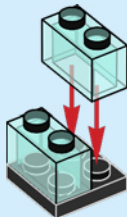

3

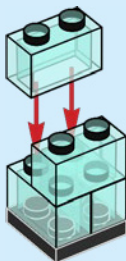

4



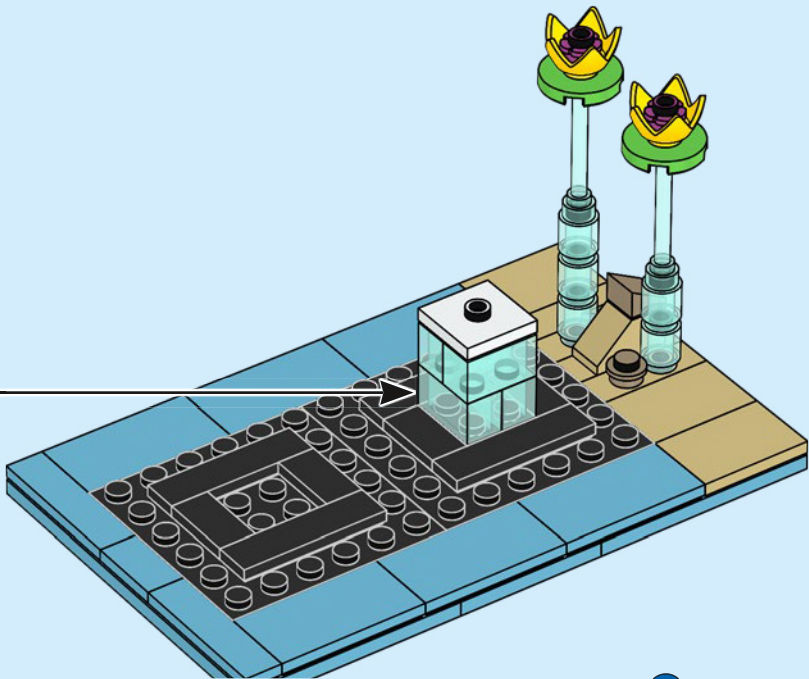

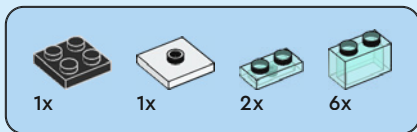

14

1

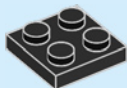

2

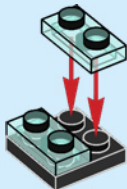

3

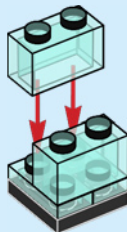

4

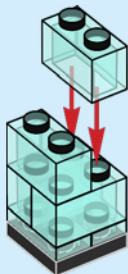

5

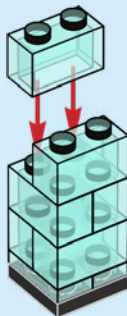

6



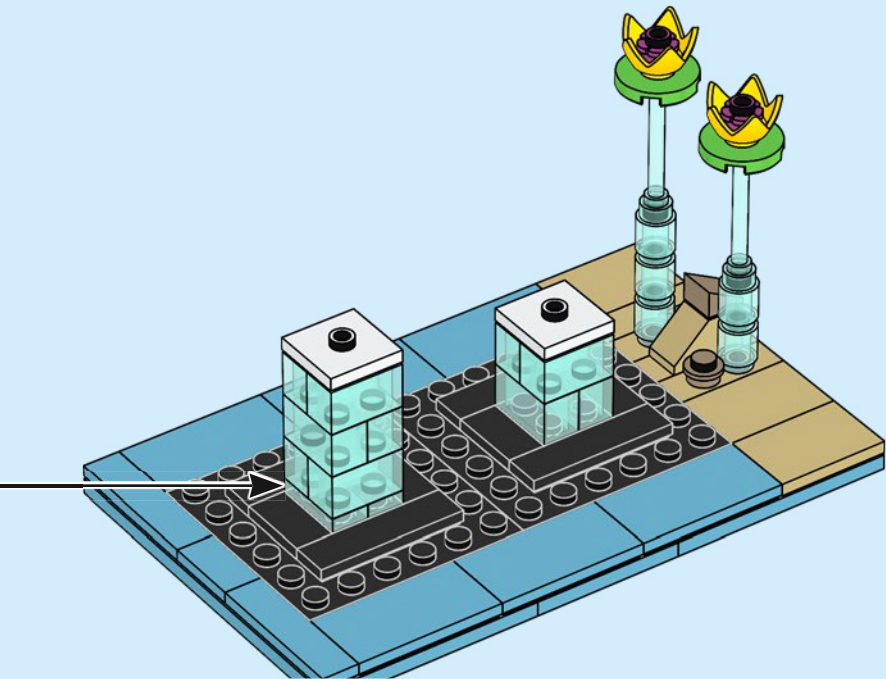

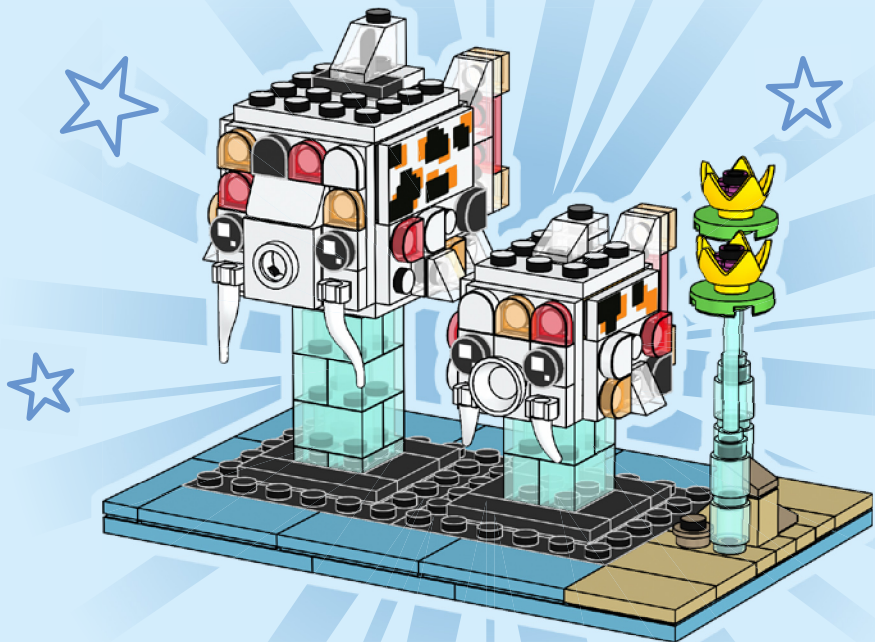



BRICK 'HEADZ

40546

Poodle
Pudel
Le caniche
Barboncino
Caniche
Uszár
Püdelis

Puppy
Welpé
Le chiot
Cucciolo
cachorro
Cãozinho
Kutyus
Kucéns



Pets

PUPPY

179

POODLE

178



6x
6250591



4x
302401



4x
6348055



1x
6198979



2x
6270106



2x
6210272



1x
4547489



4x
6051511



2x
6269074



2x
6126046



1x
302201



1x
6238334



1x
303901



2x
6404514



1x
6195371



2x
362301



2x
302101



3x
6104805



2x
6404841



2x
302001

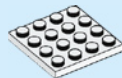

4x
4243812



4x
6175968



1x
4121972



1x
6131896



3x
6211966



3x
6175367



3x
6397571



5x
6256435



5x
6277460



7x
6264033



1x
403223



1x
6092585



8x
6252041



3x
6245252



1x
302123



4x
306926



7x
6245250



2x
6240212



2x
6365630



2x
302226



4x
6186867

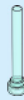

2x
6334272



4x
6284077



1x
303926



2x
6380676



5x
6238677

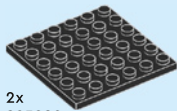

2x
395826



4x
243126



2x
300328



10x
6244910



2x
6240222



2x
6040126



2x
4624705

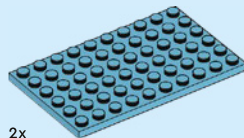

2x
6133692



2x
6209682



7x
6249116



6x
6097042



2x
6315781



3x
6245265

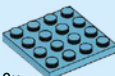

2x
6141594



4x
6252040



3x
4286050



4x
6328096



1x
4550359



12x
6123809



1x
4649741

Customer Service
Kundenservice
Service Client
Assistenza clienti
Atención al cliente
Serviço de Apoio ao Consumidor
Ügyfélszolgálat
Klientu apkalpošanas dienests
Serviciul pentru clienți
客户服务
コンシューマーサービス
고객 서비스

LEGO.com/service

WIN

Terms & Conditions apply

Scan this QR code or go to **LEGO.COM/PRODUCTFEEDBACK** and give us your short feedback about this LEGO® set for a chance to win a cool LEGO prize.



GEWINNE

Scanne diesen QR-Code oder geh auf LEGO.COM/PRODUCTFEEDBACK

und gib uns dein kurzes Feedback zu diesem LEGO® Set. Dann hast du die Chance, einen coolen LEGO Preis zu gewinnen.

Es gelten die Teilnahmebedingungen

GAGNE

Scannez ce code QR ou rendez-vous sur LEGO.COM/PRODUCTFEEDBACK

pour donner votre avis sur ce produit LEGO® et avoir une chance de gagner un prix LEGO.

Voir Conditions Générales

GANAN

Escanea este código QR o visita LEGO.COM/PRODUCTFEEDBACK

y comparte con nosotros tu opinión sobre este set LEGO® para tener la oportunidad de ganar un fantástico premio LEGO.

Términos y Condiciones aplicables

获取奖品

只需扫描此二维码或访问 LEGO.COM/PRODUCTFEEDBACK,

就这款乐高®套装提供简短反馈, 就有机会赢得很酷的乐高奖品。

《条款及条件》适用