

The background of the entire page is a detailed white line-art illustration of the Eiffel Tower's internal arch structure, showing various beams, bolts, and supports. In the center of the arch, there is a small icon of the tower's top section.

Eiffel tower

Book 2 · Livre 2 · Libro 2

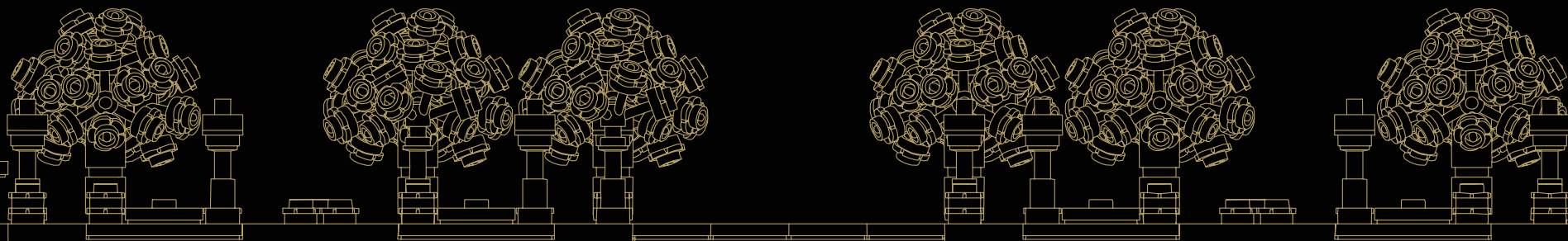

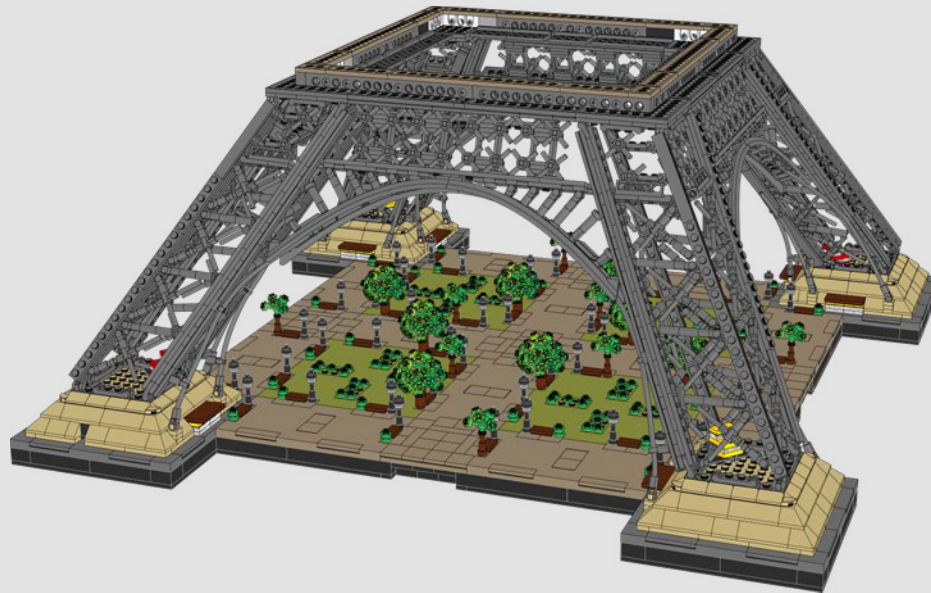
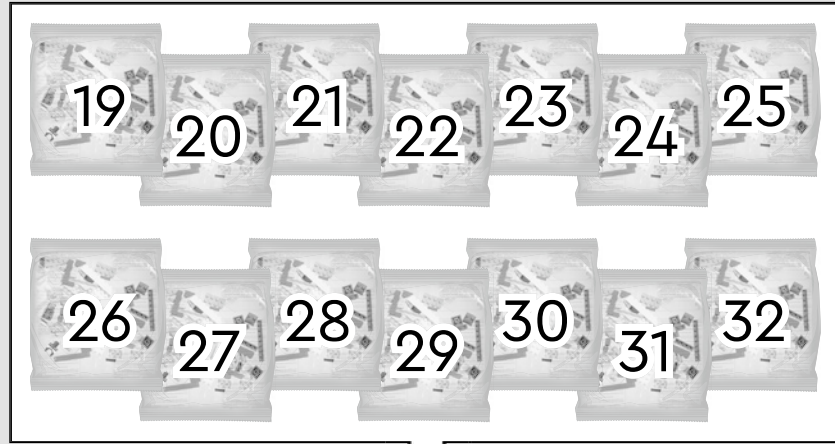

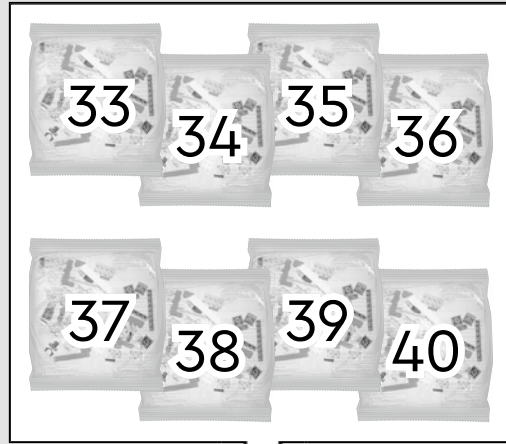

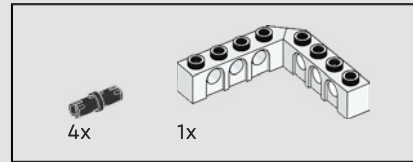
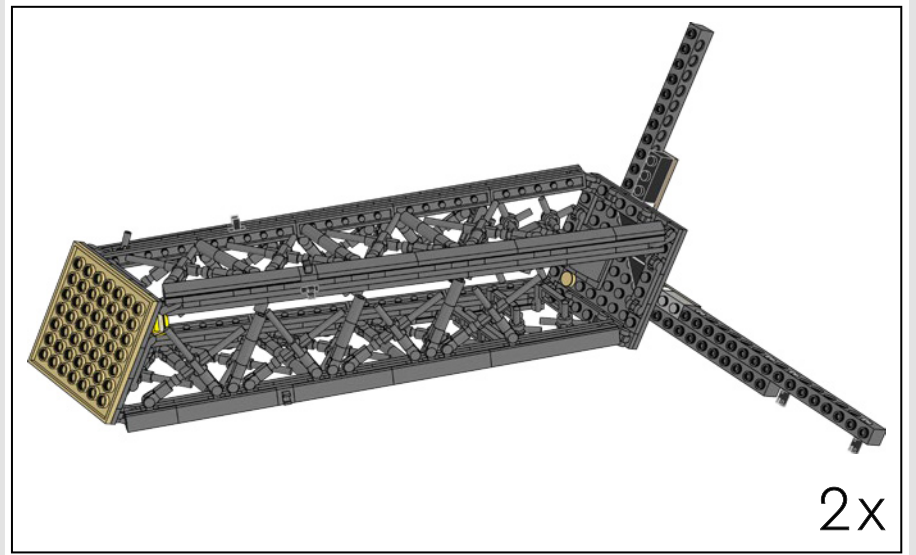

88

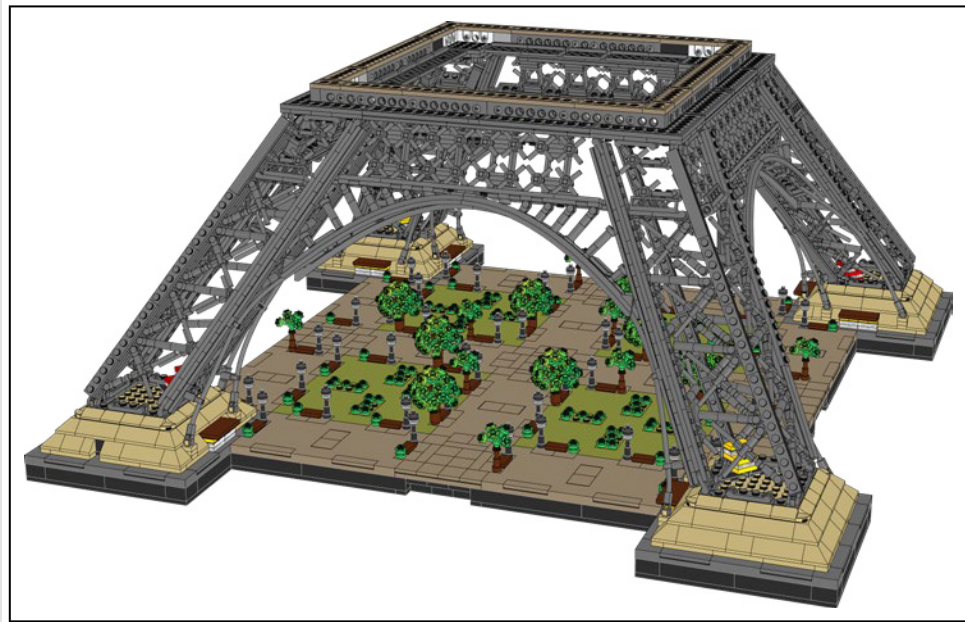
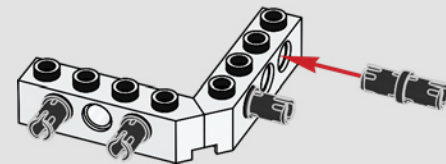

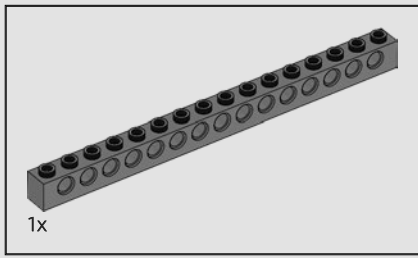

89

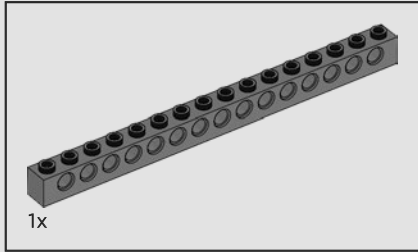
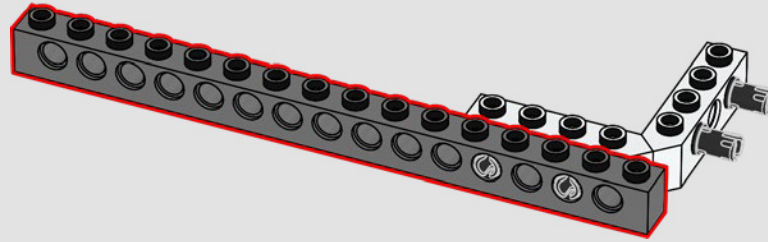

90

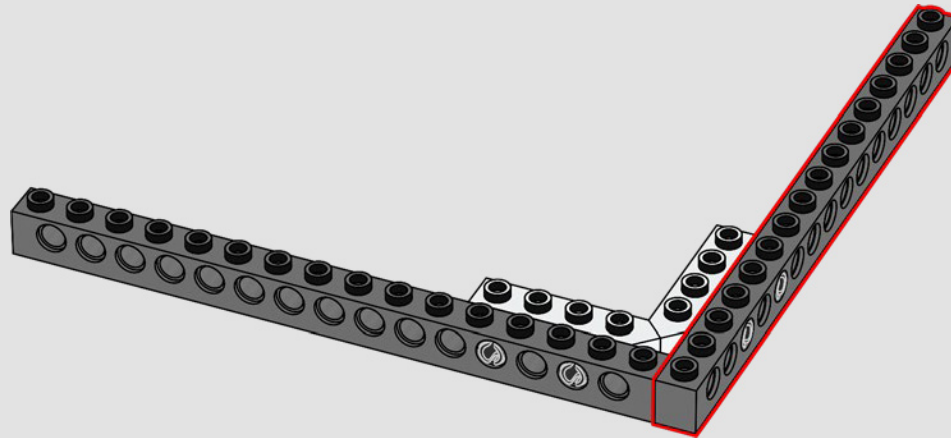

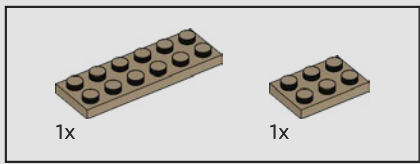

91

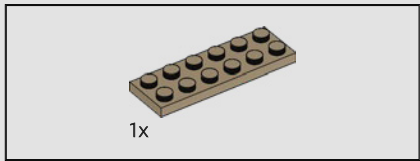
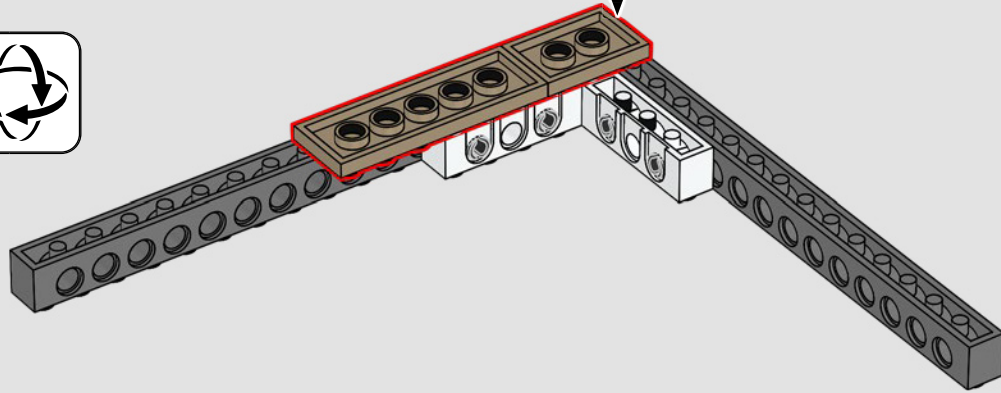
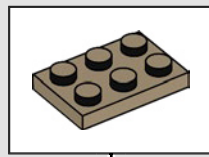

92

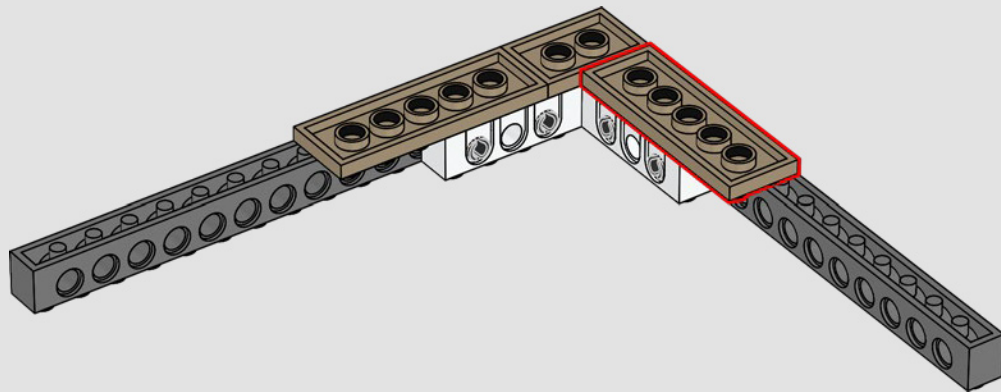

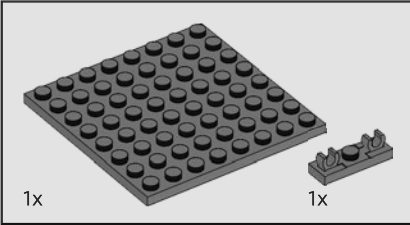
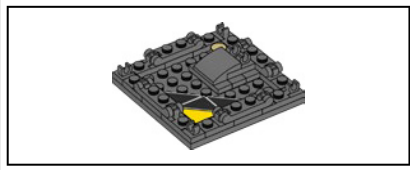

93

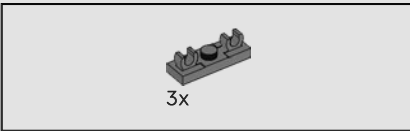
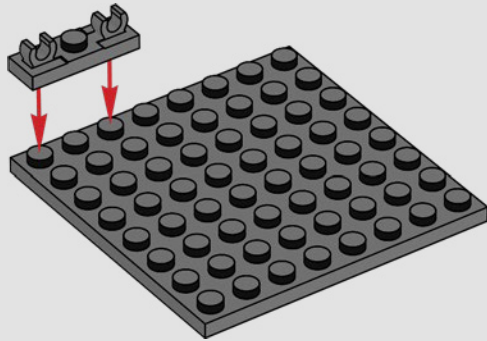

94

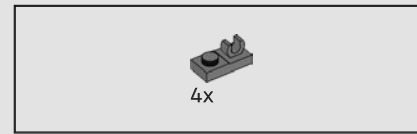
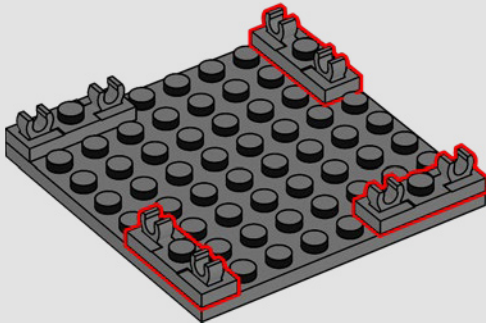

95

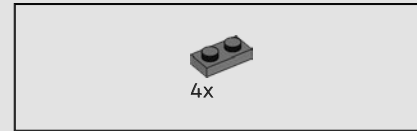
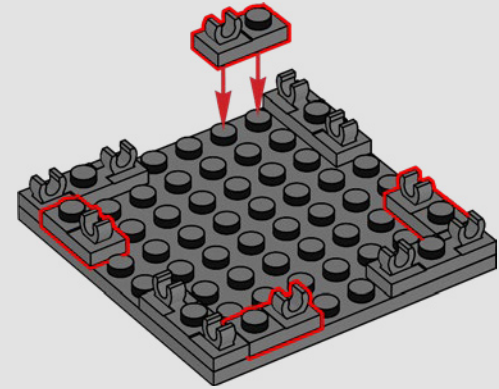

96

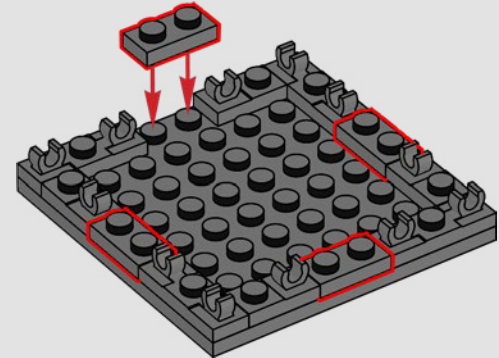

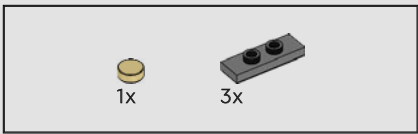

97

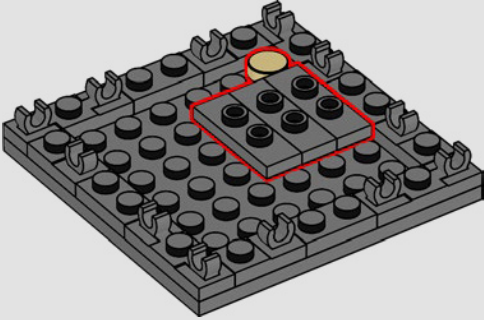

98

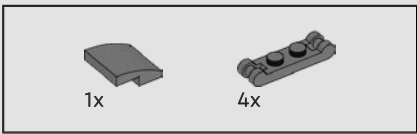
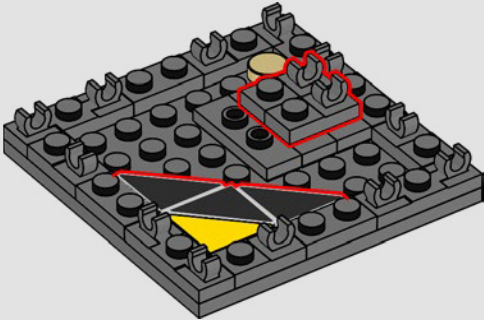

99

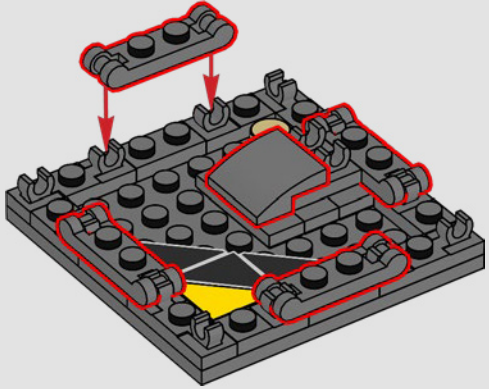

100

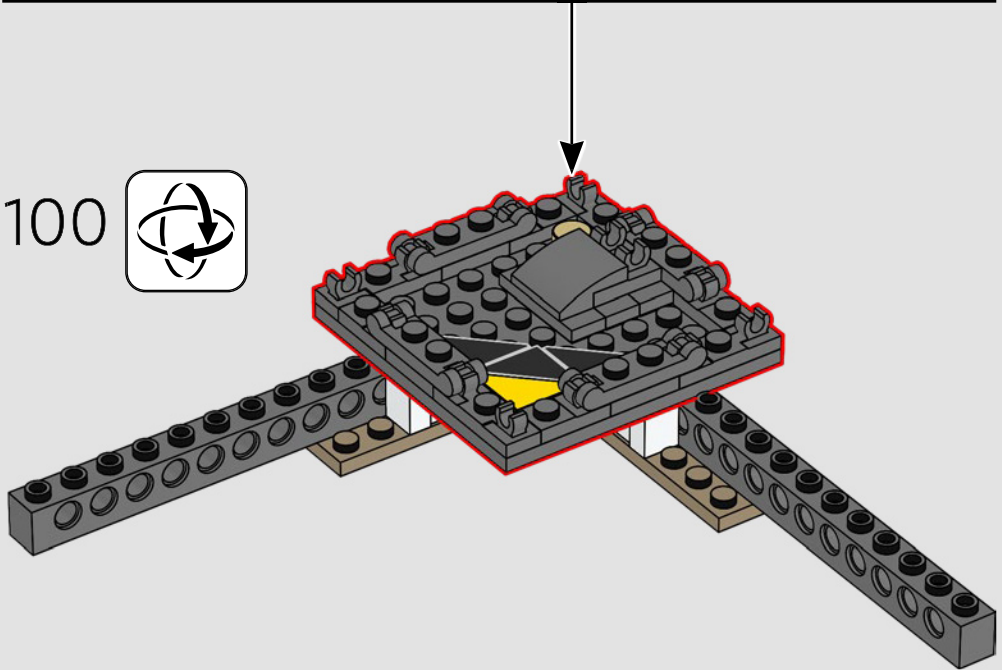

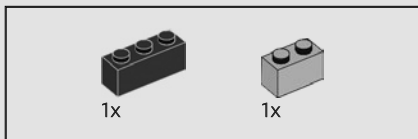

101

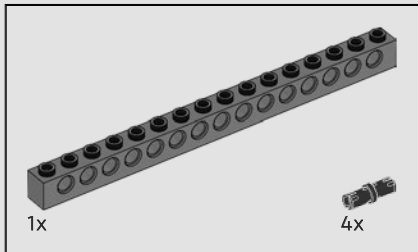
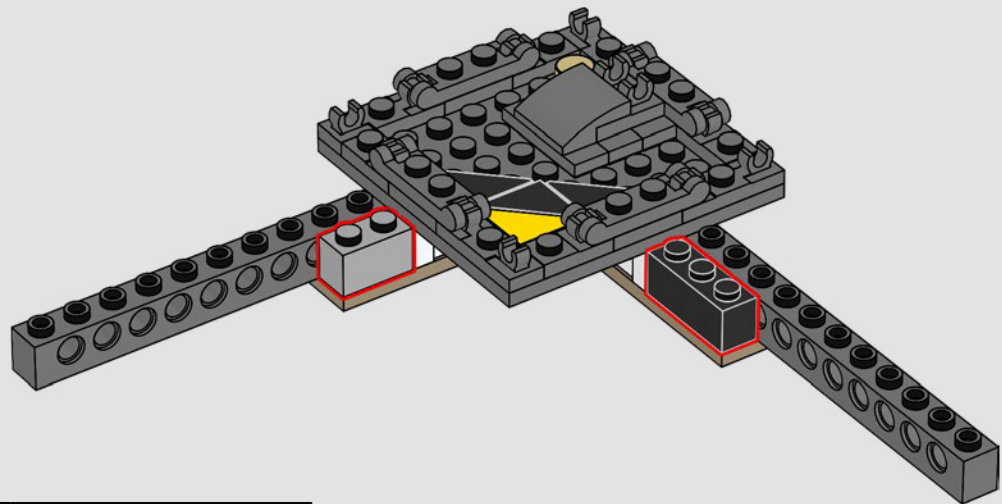

102

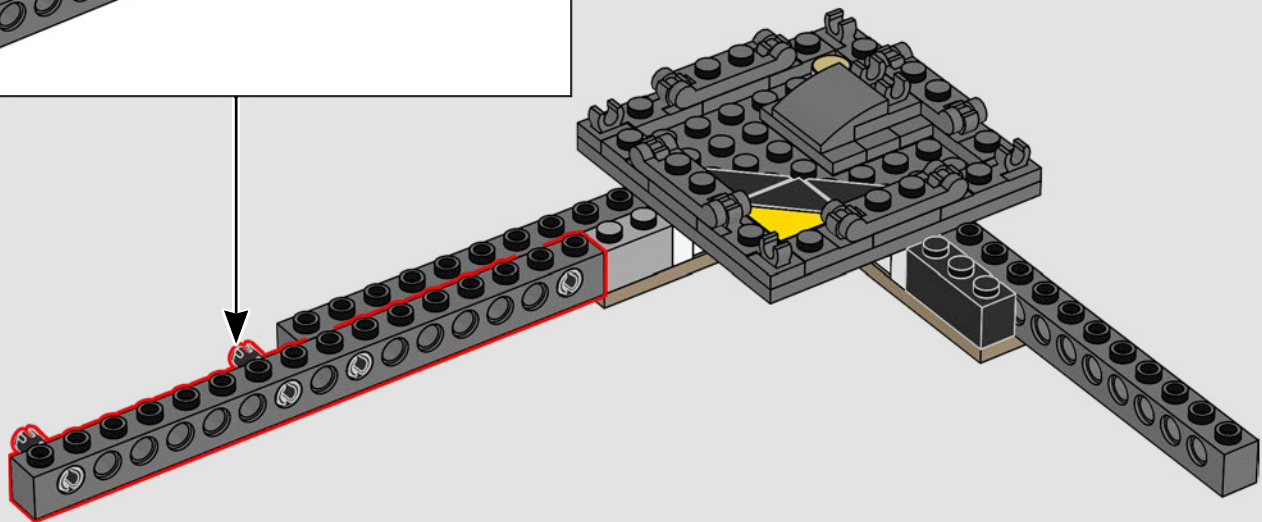
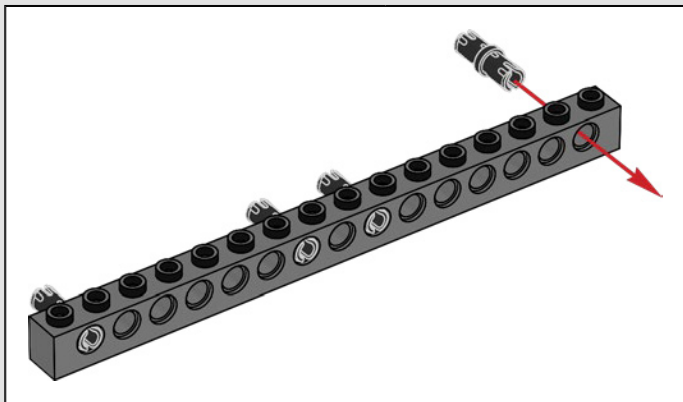

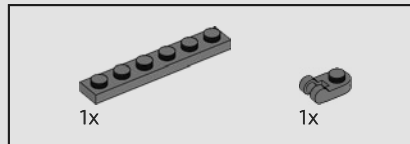
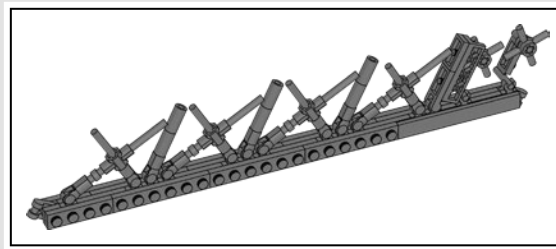

103

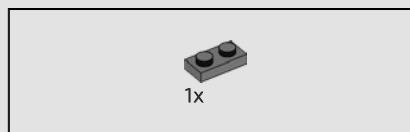
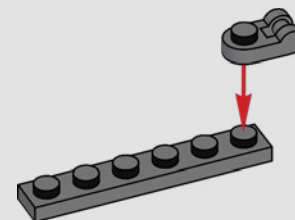

104

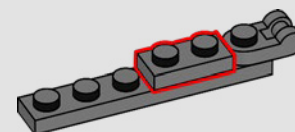

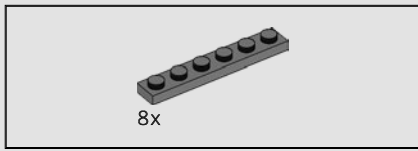

105

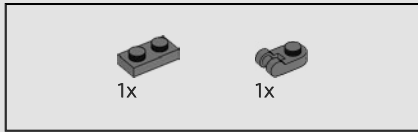
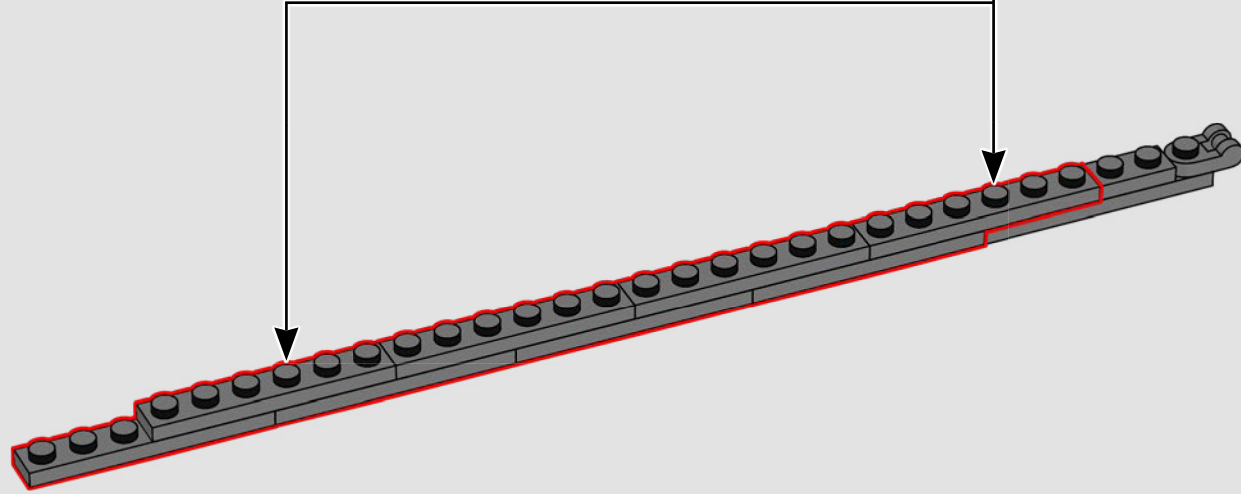
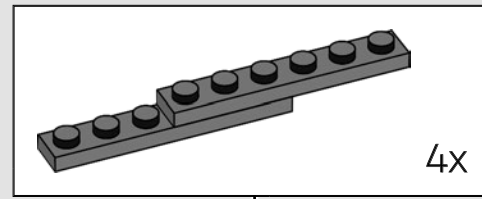

106

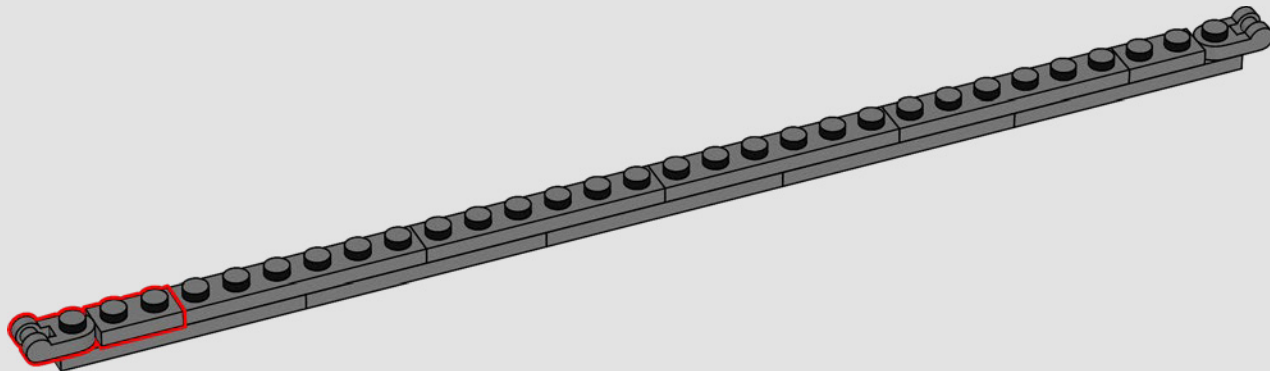

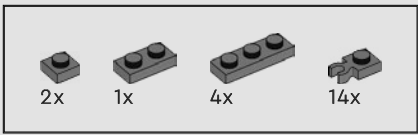

107

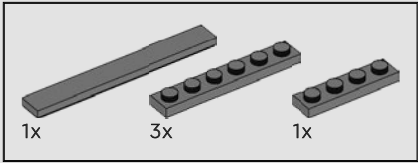
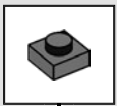
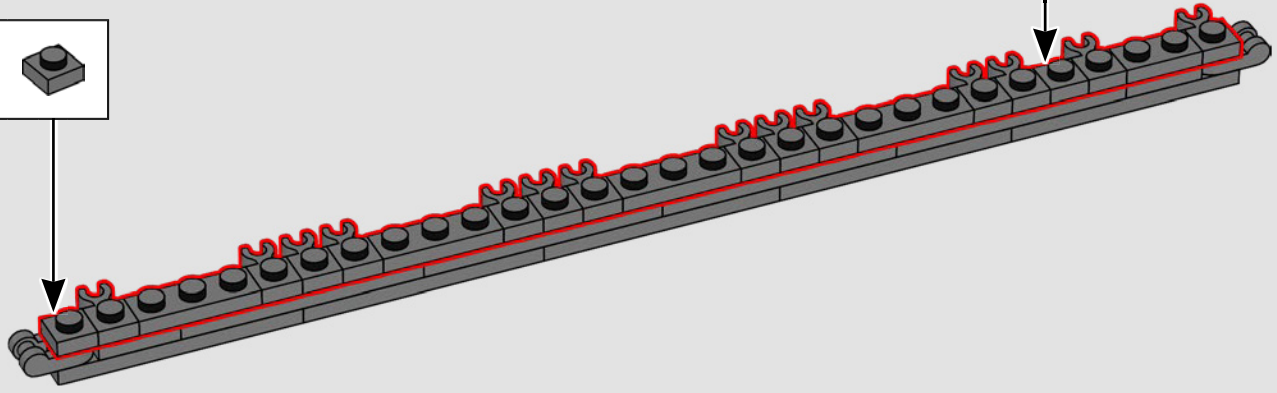
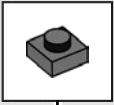

108

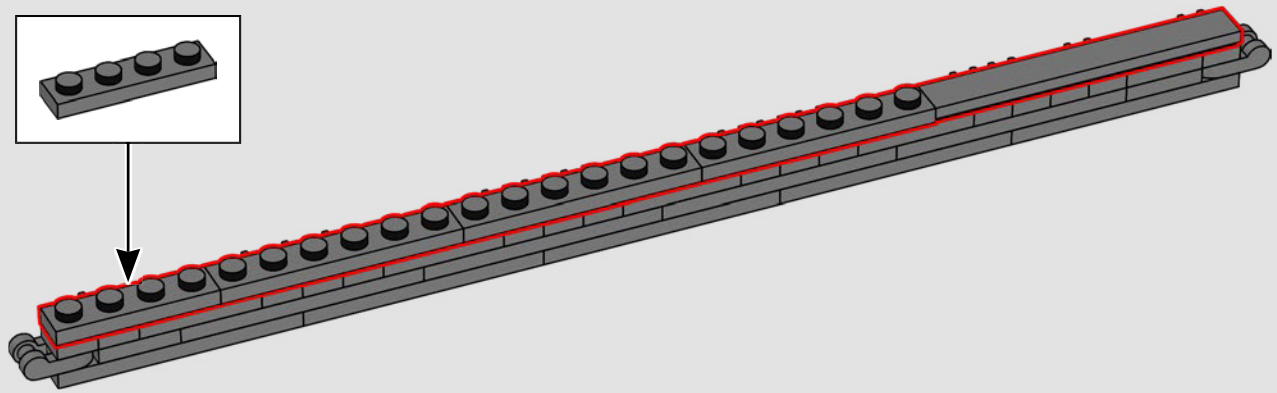
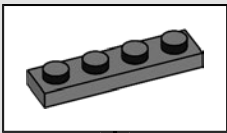

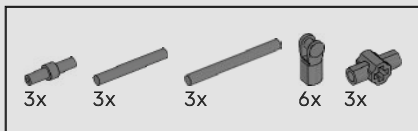

109

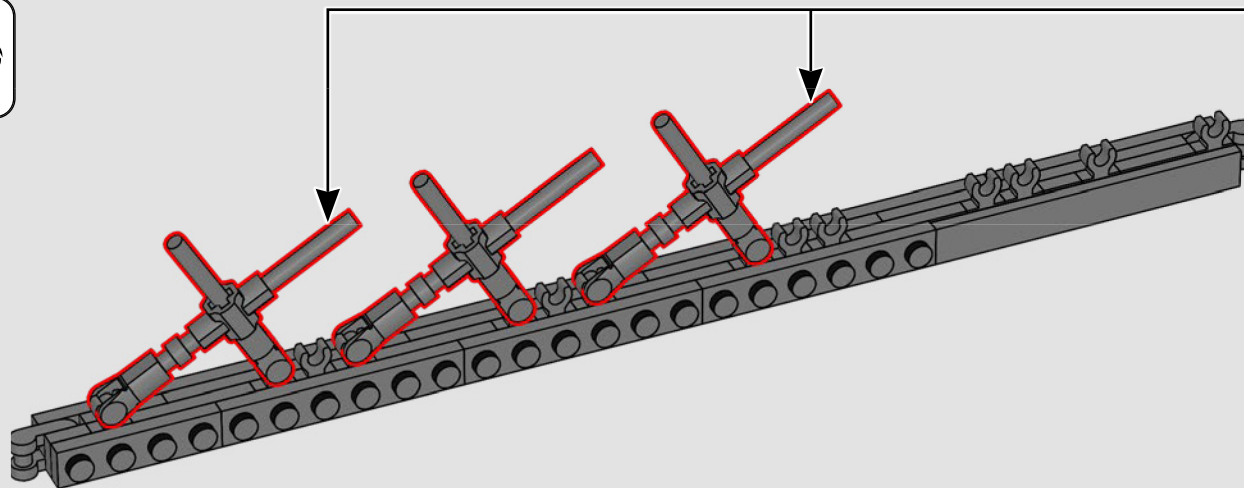
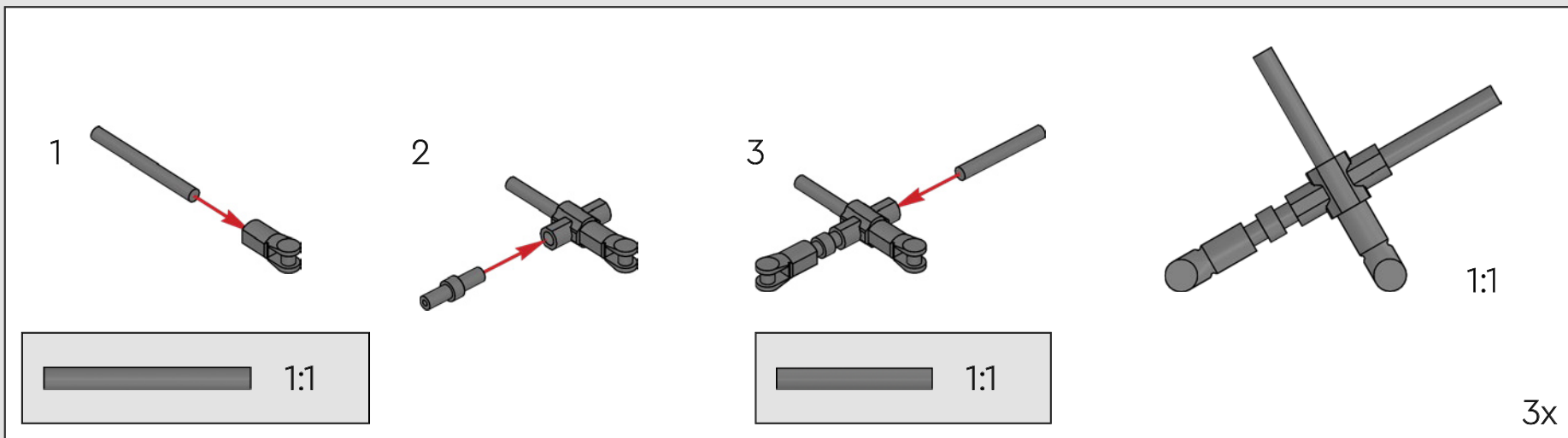

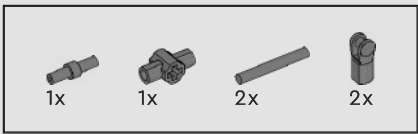

110

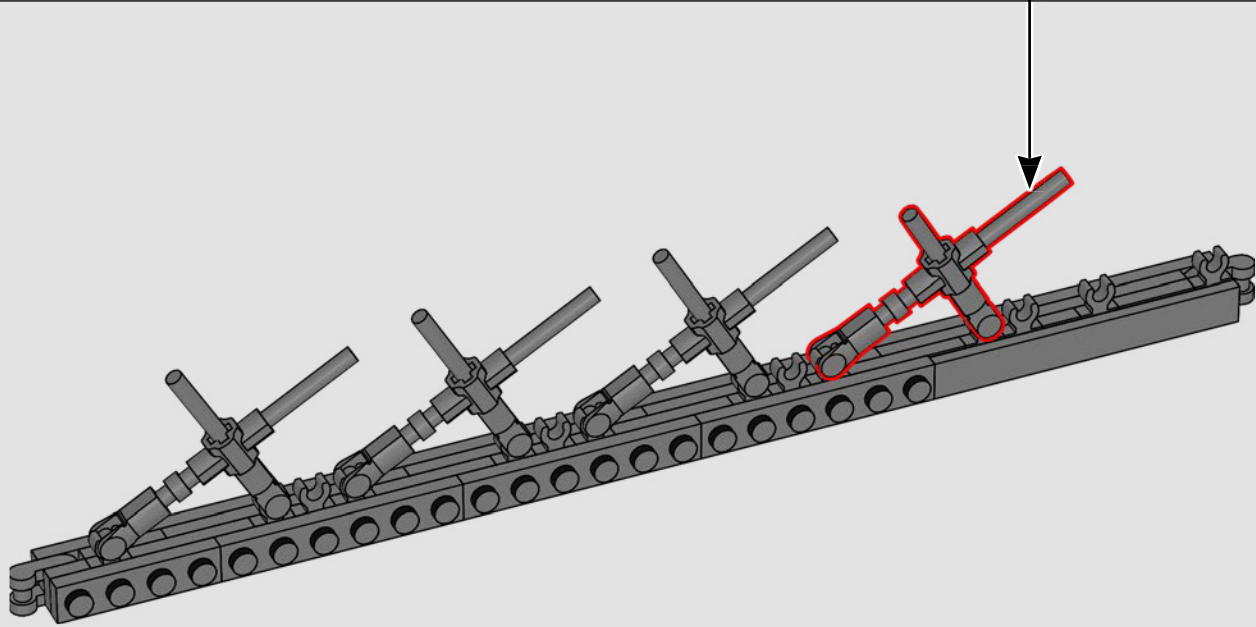
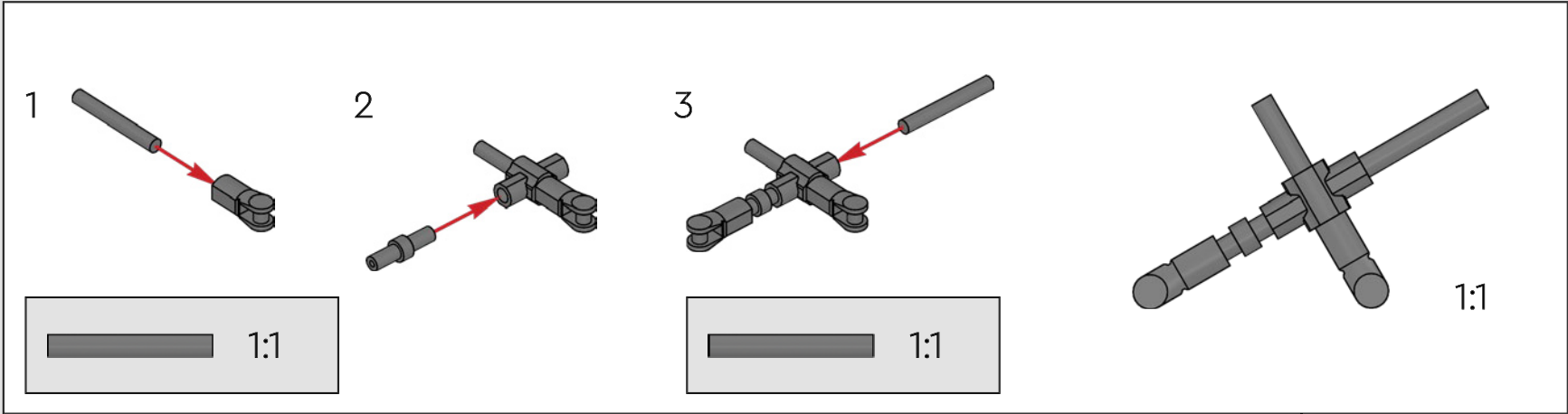

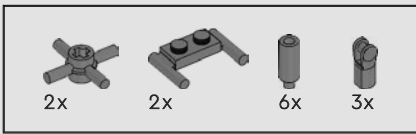

111

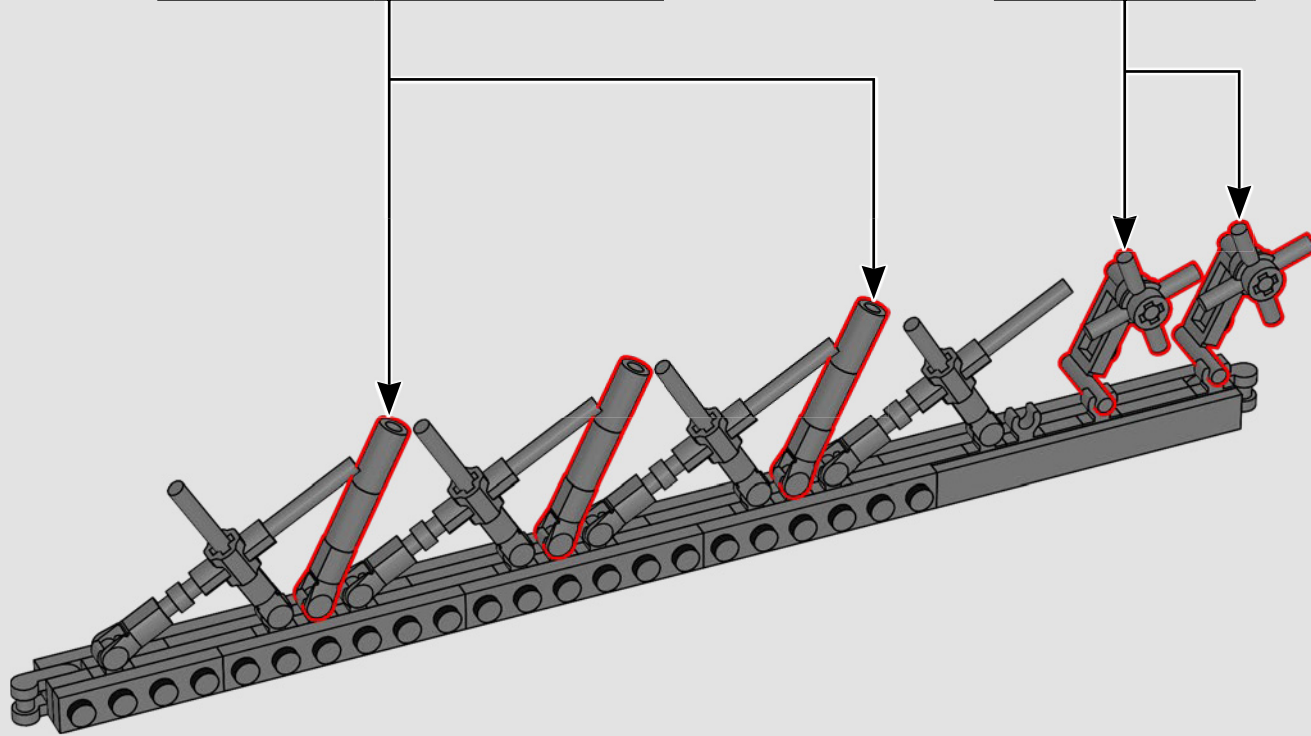
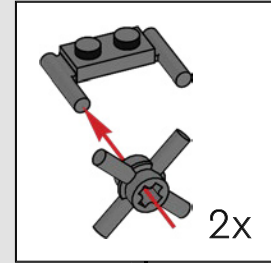
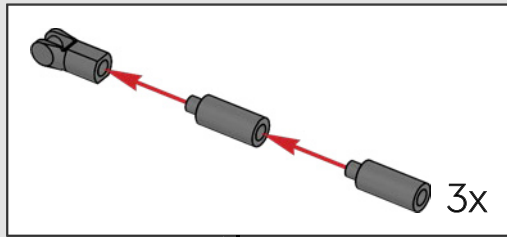

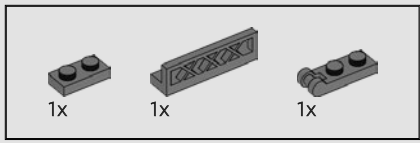

112

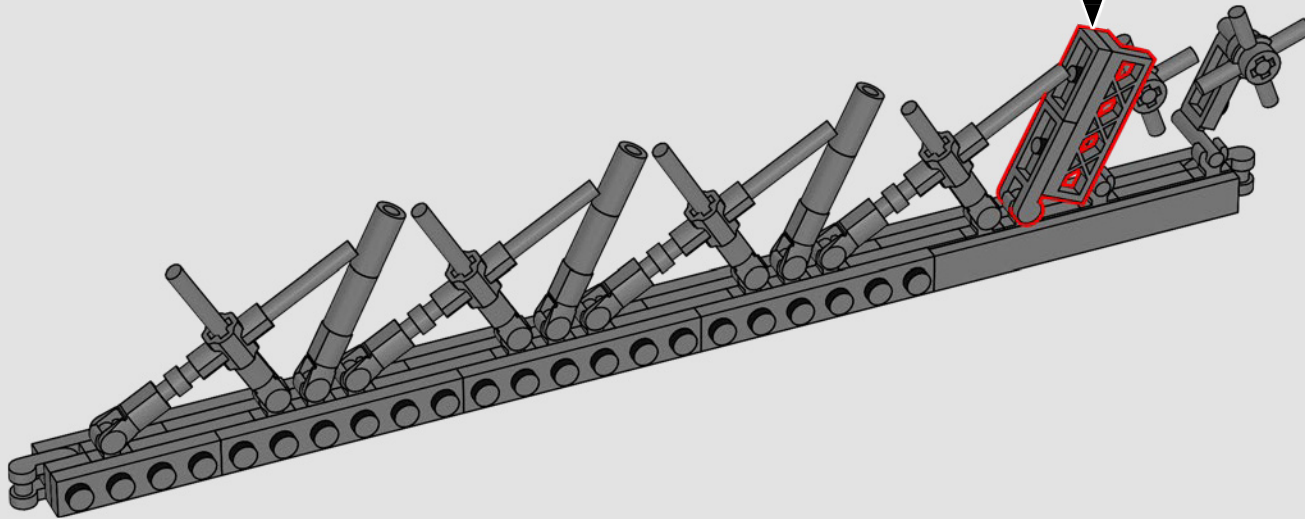
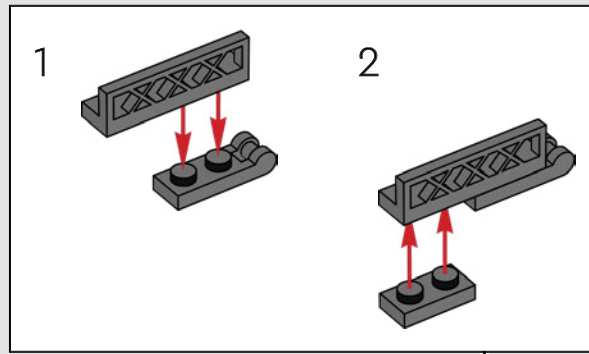

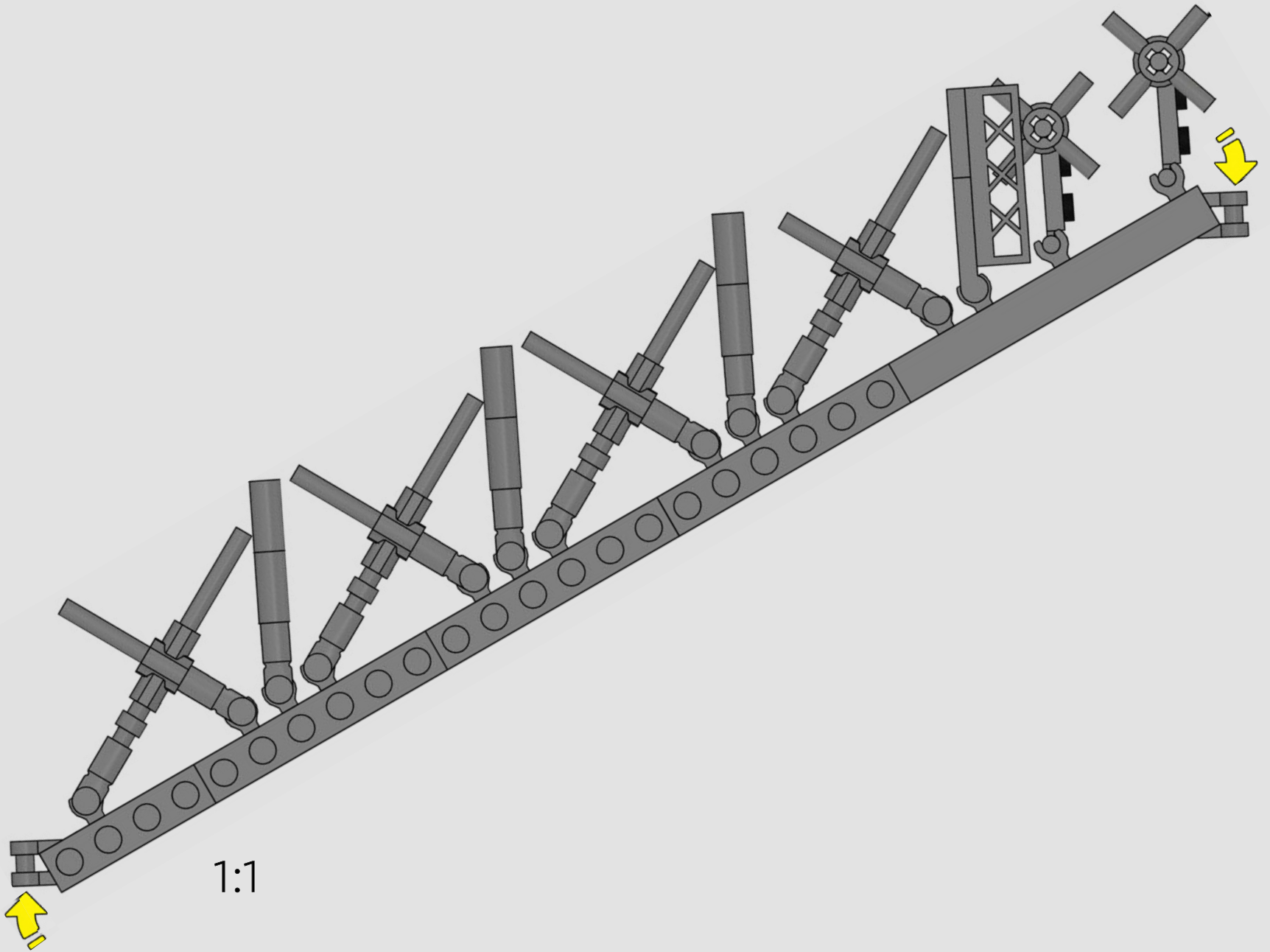

113

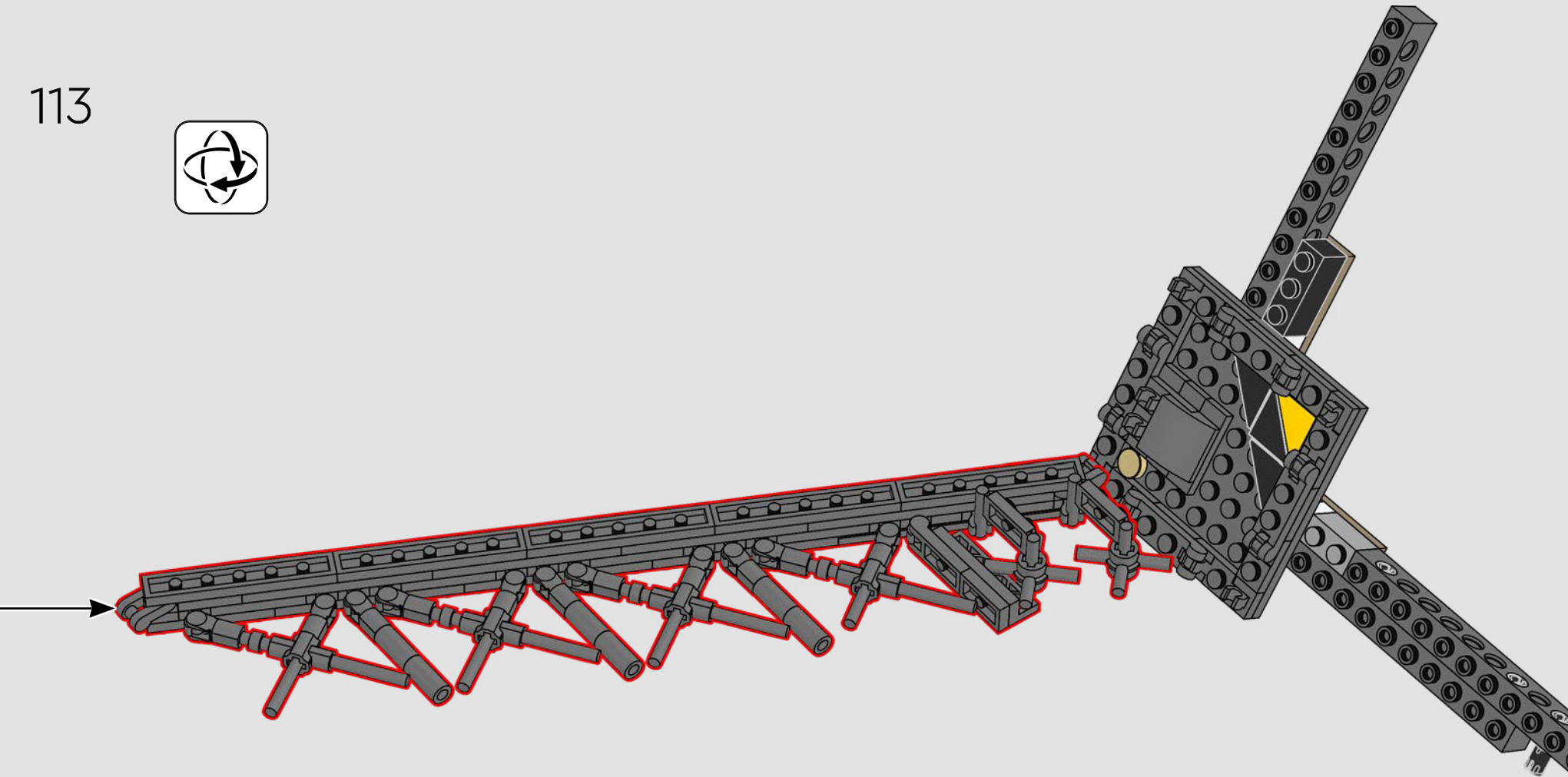

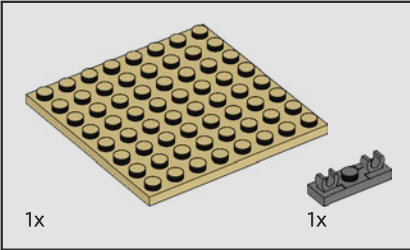
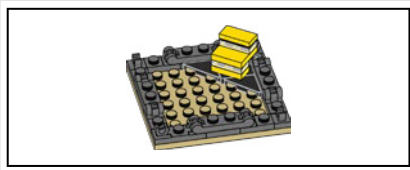

1x

1x

114

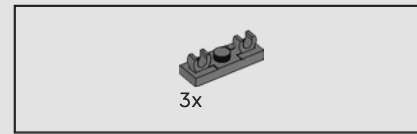
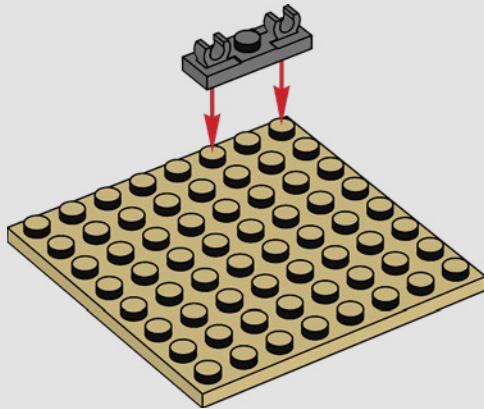

3x

115

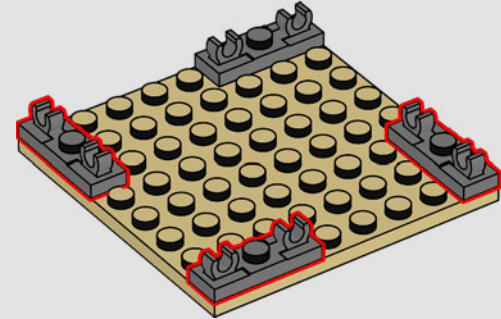

4x

116

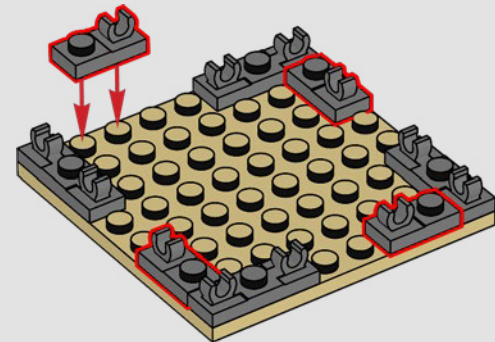



4x

117

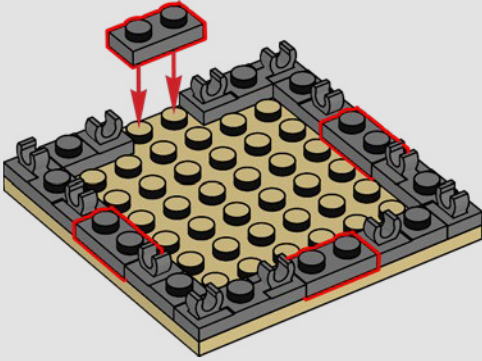

4x

118

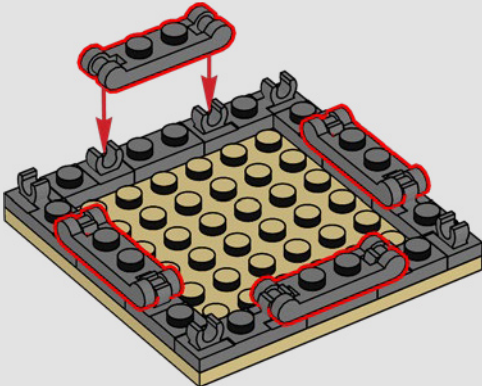

2x

1x

1x

119

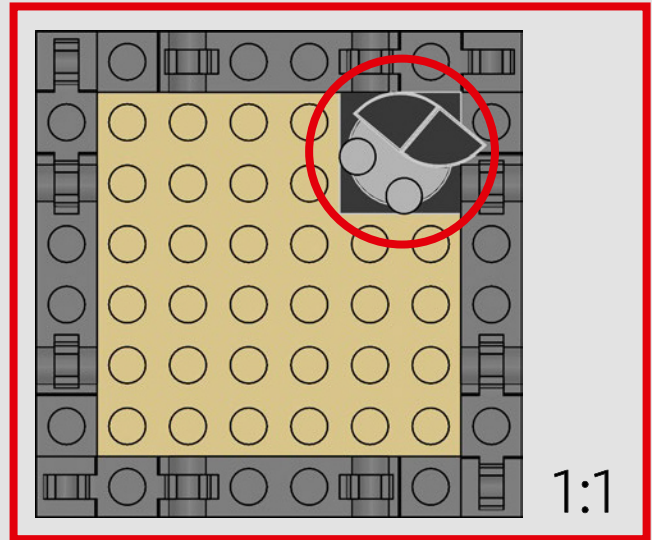
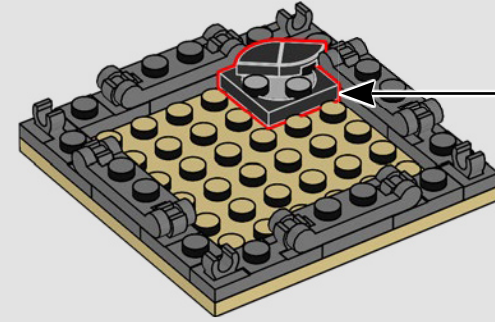
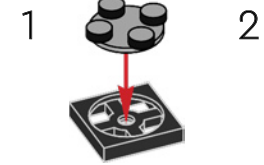



120

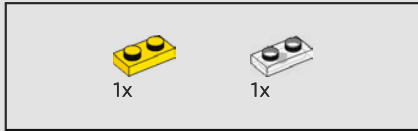
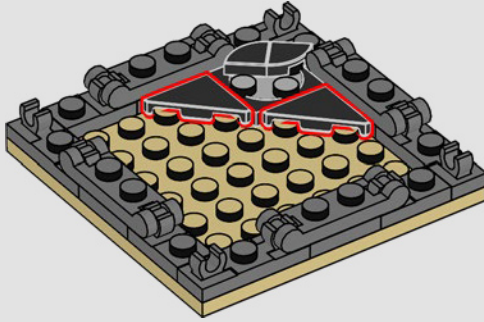

121

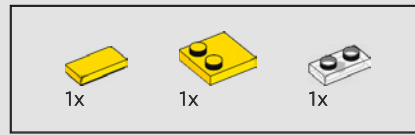
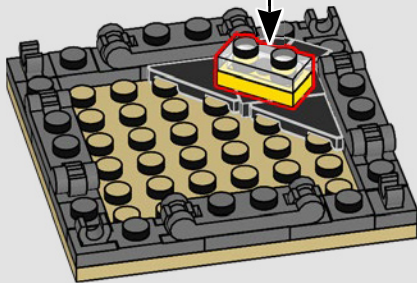
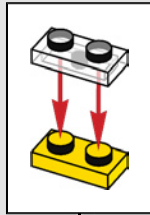

122

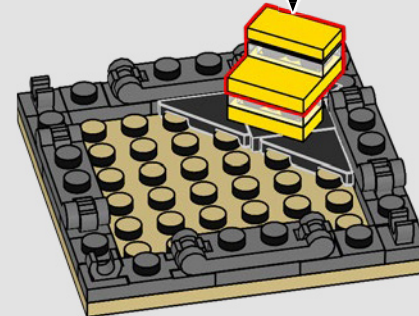
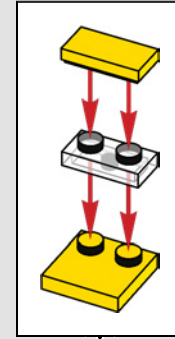

123

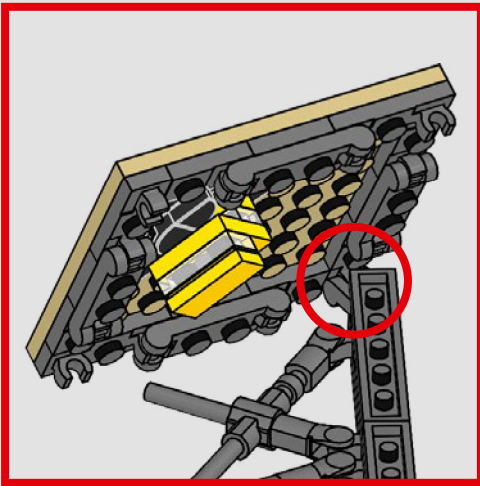

The two pairs of red and yellow double decker elevators in the model serve as color guides to distinguish the north/south and east/west pair of legs.

Les deux paires d'ascenseurs à deux étages rouges et jaunes du modèle servent de guides de couleur pour distinguer les paires de jambes nord/sud et est/ouest.

Los dos pares de elevadores rojos y amarillos de dos niveles del modelo sirven como guías de color para distinguir los pares de patas norte/sur y este/oeste.

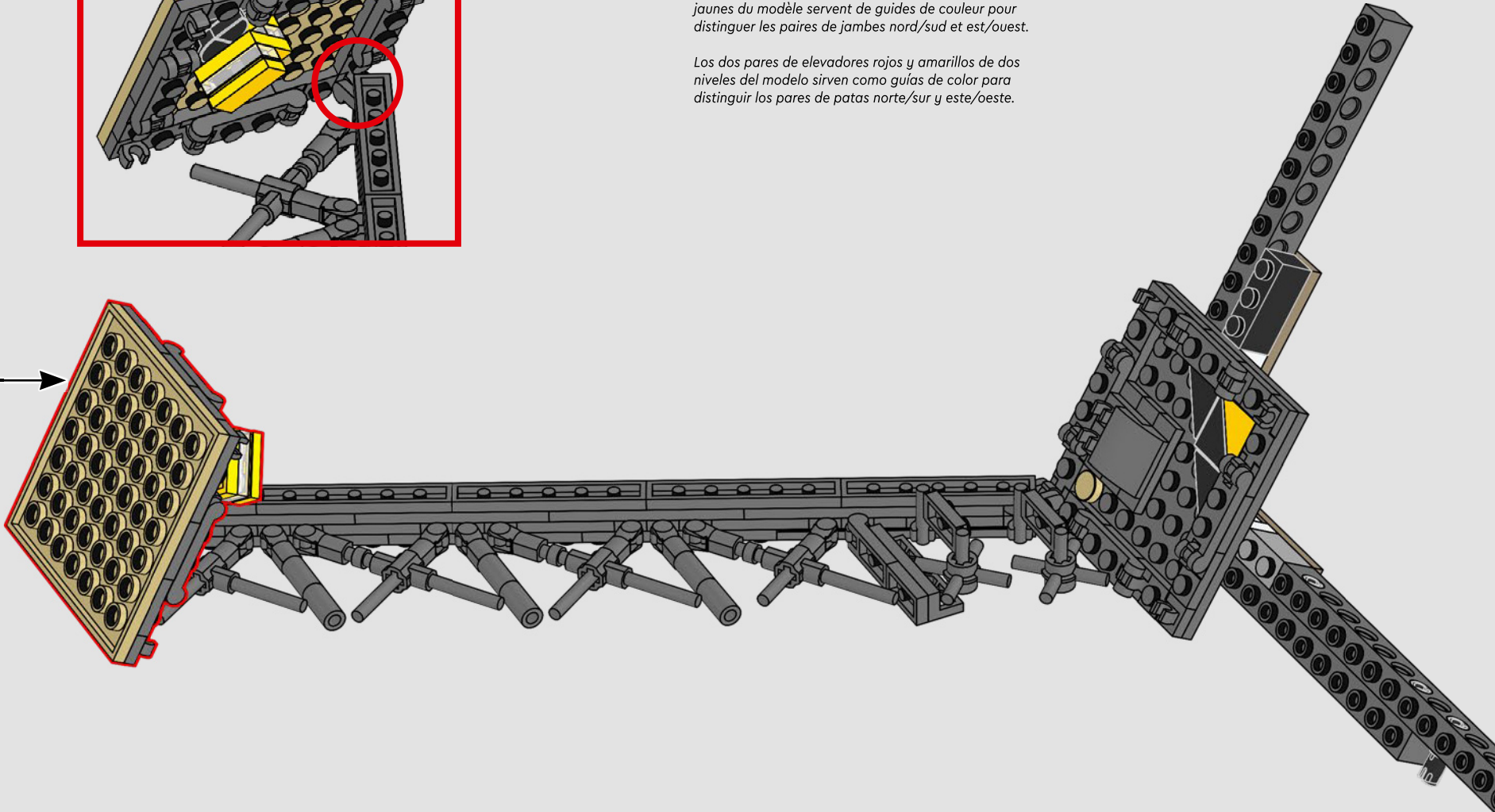

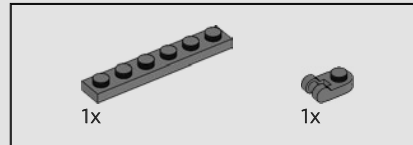
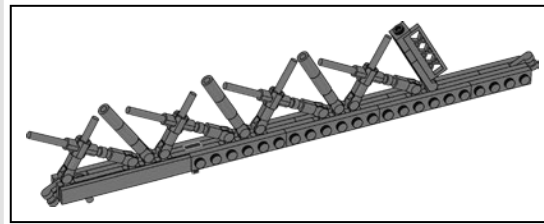

124

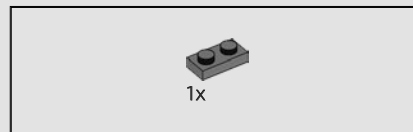
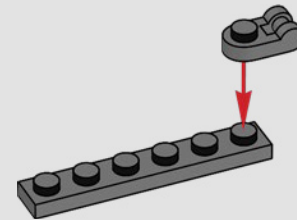

125

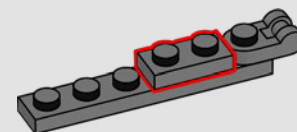

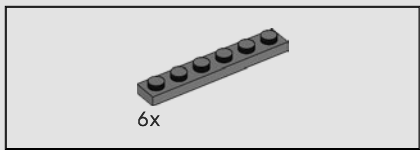

126

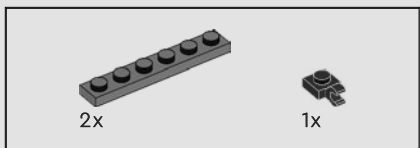
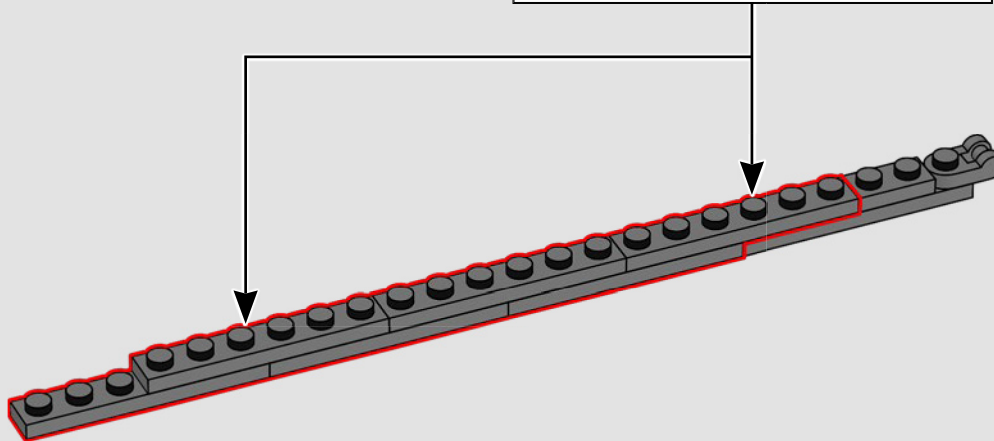
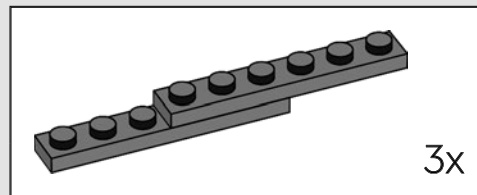

127

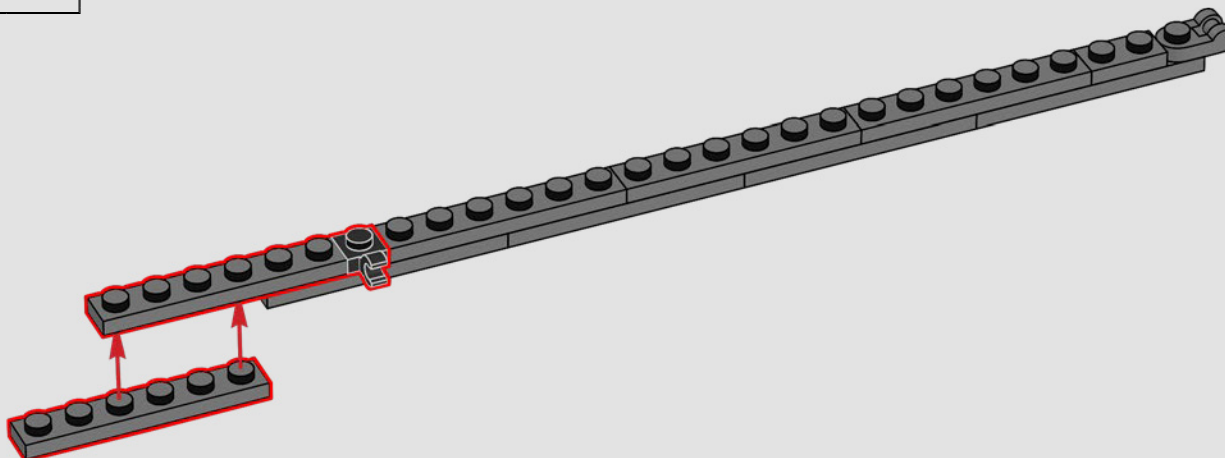

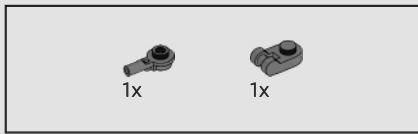

128

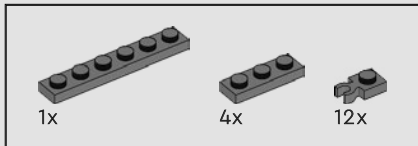
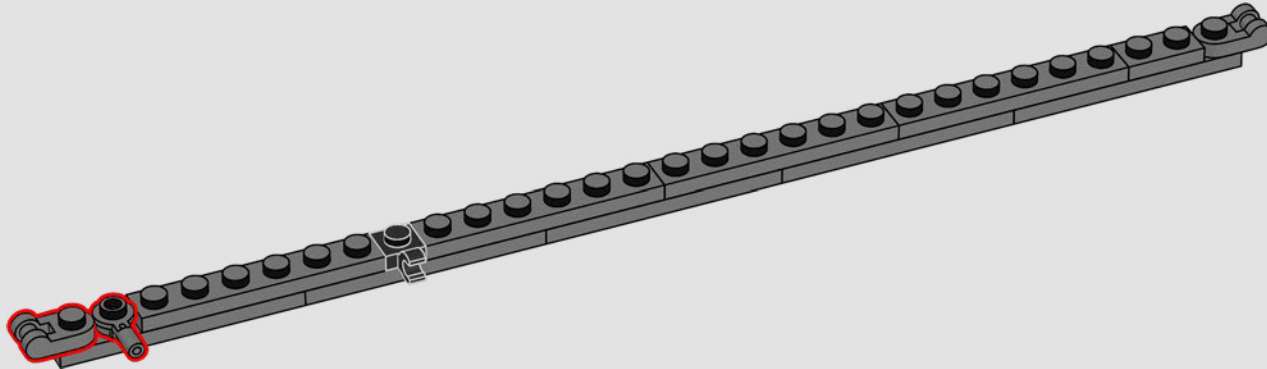

129

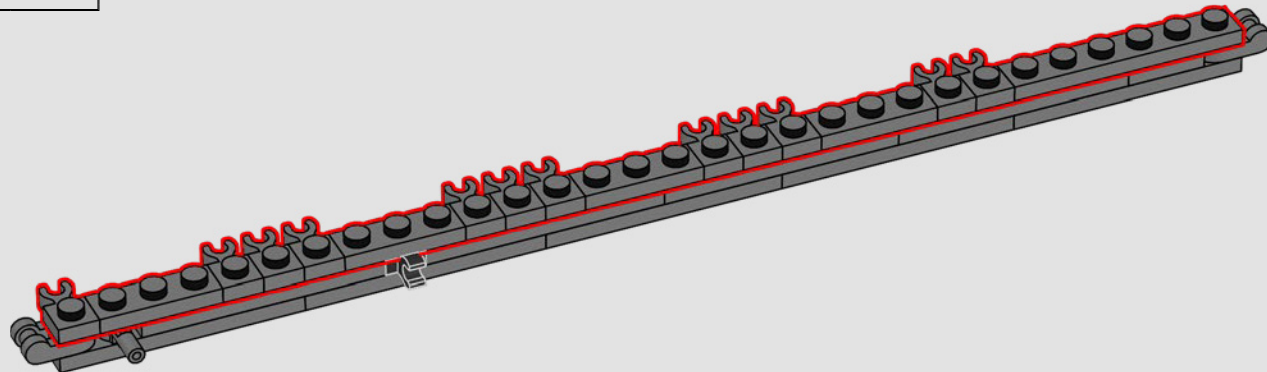

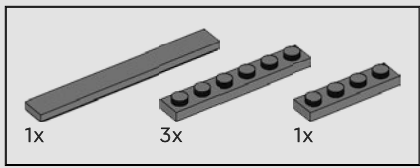

130

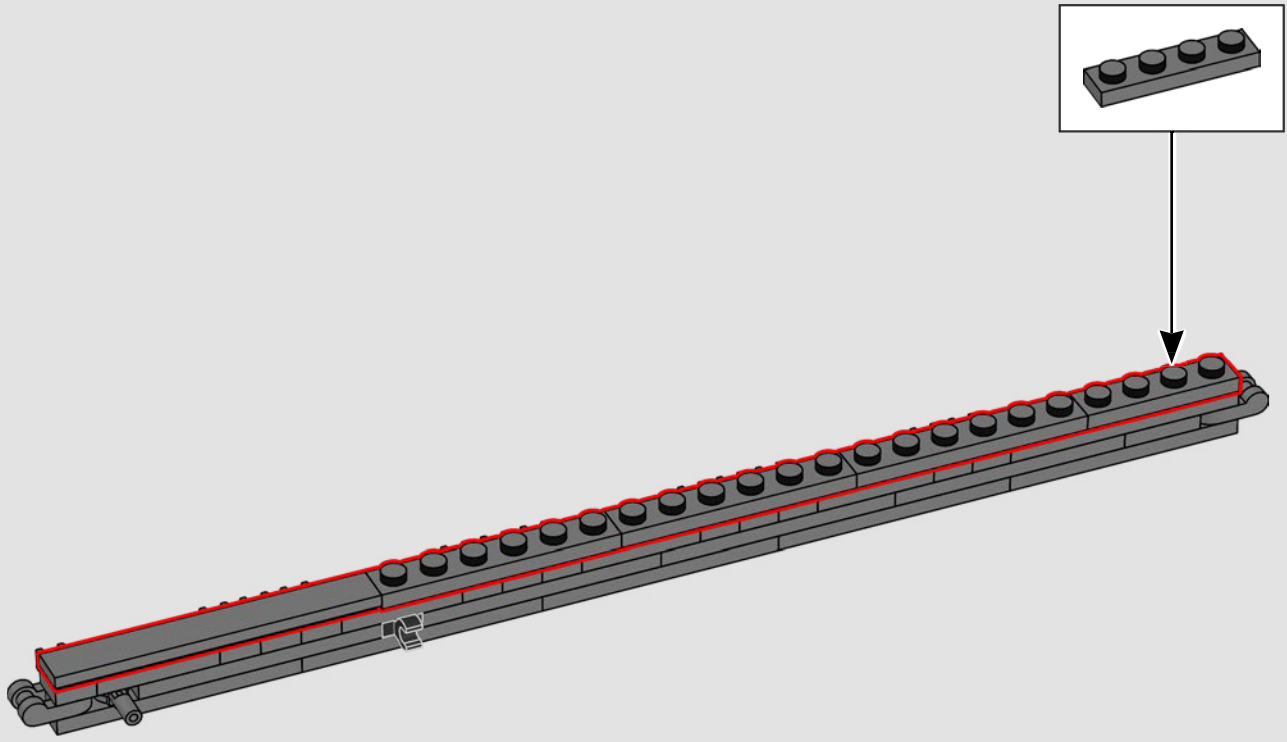

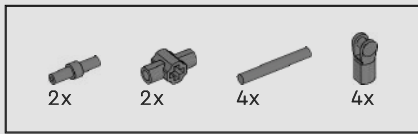

131

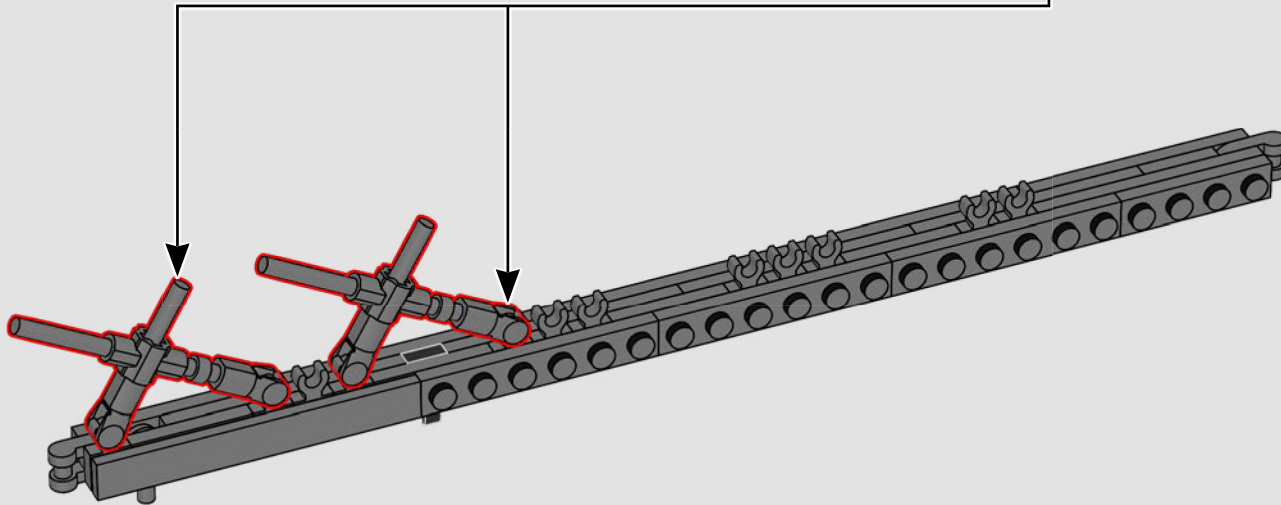
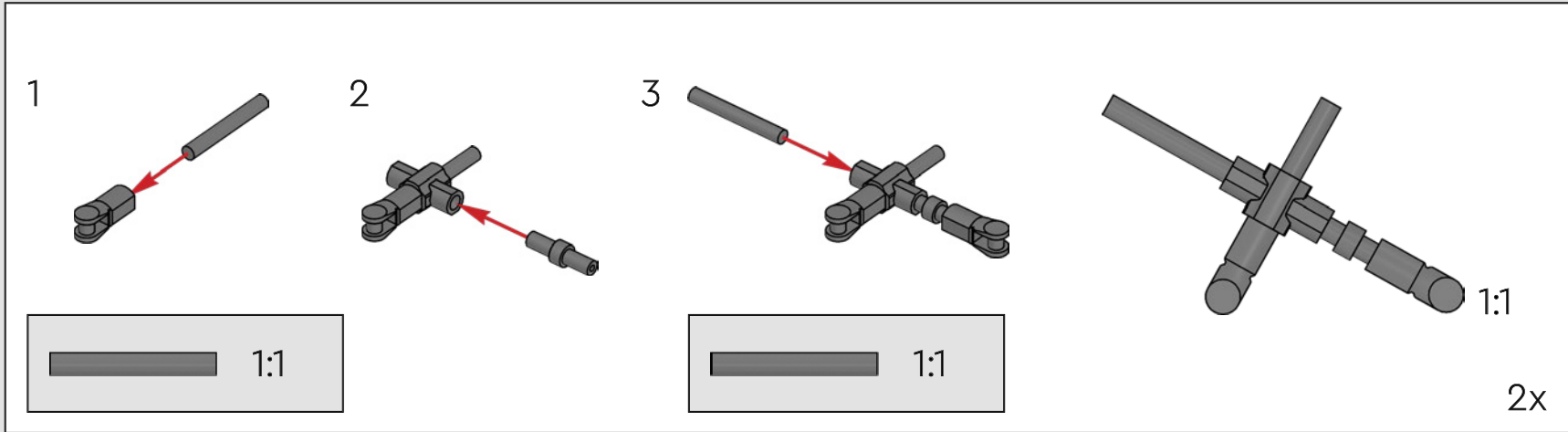

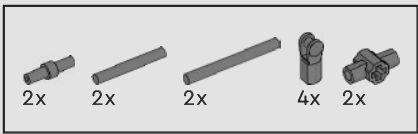

132

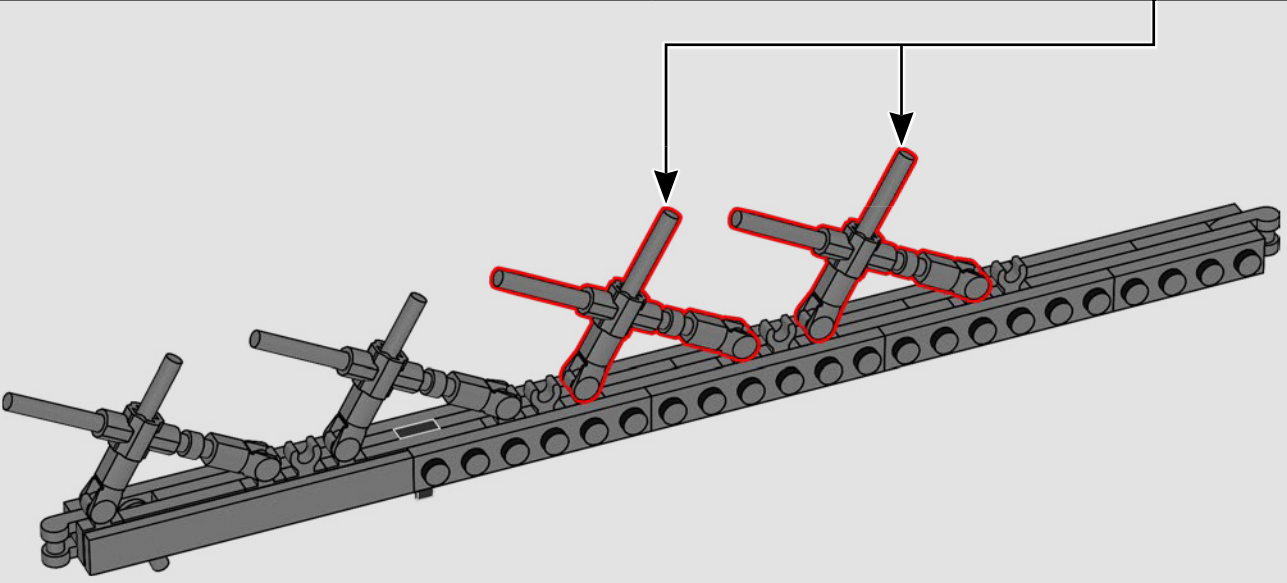
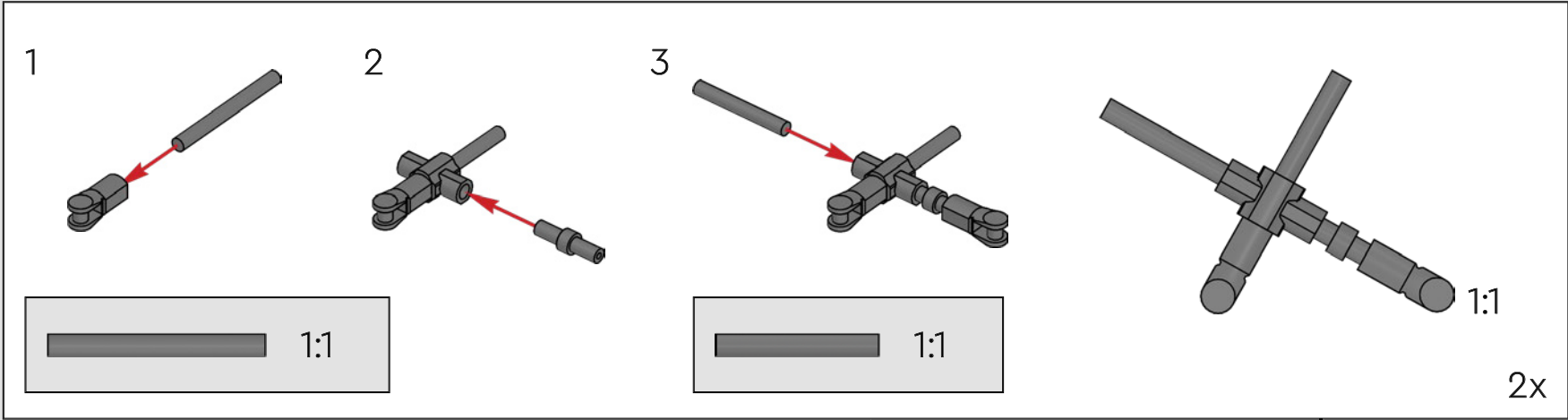

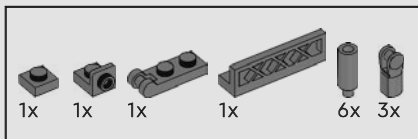

133

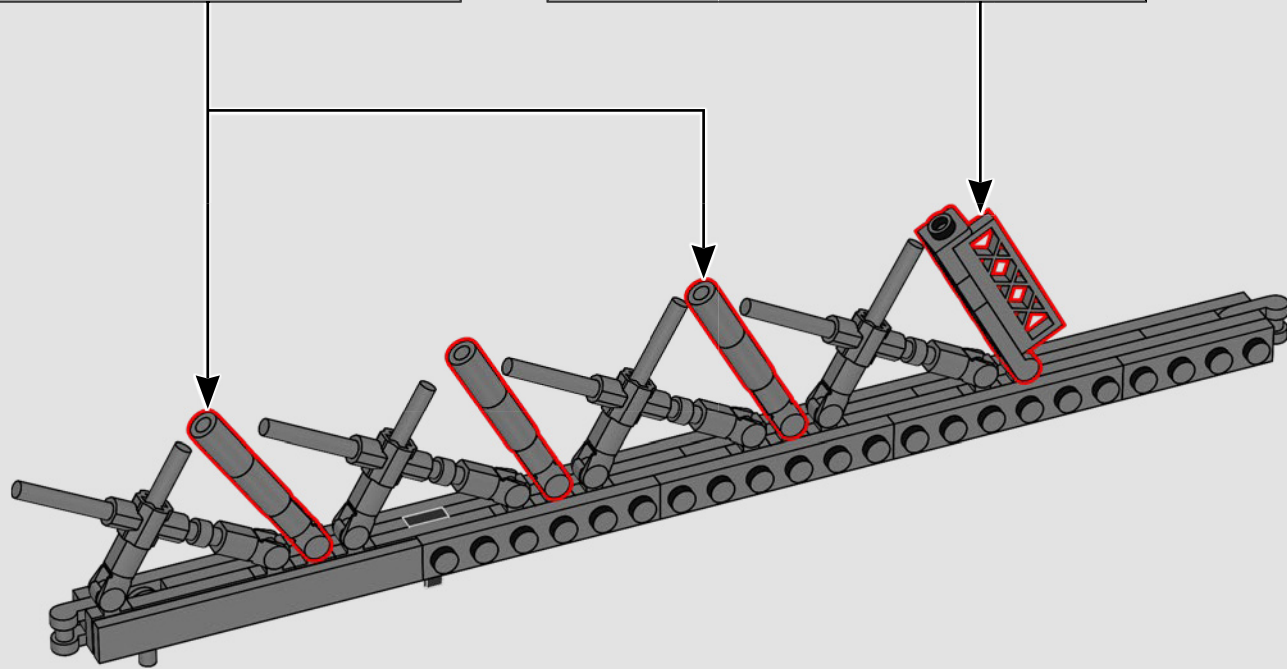
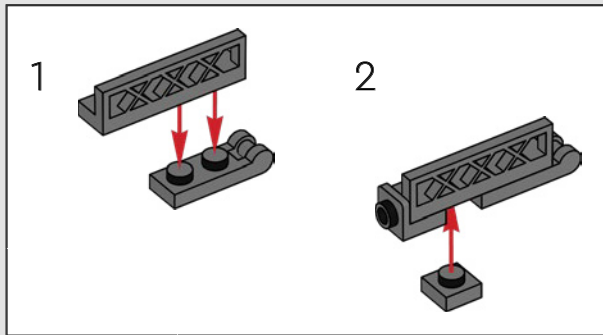
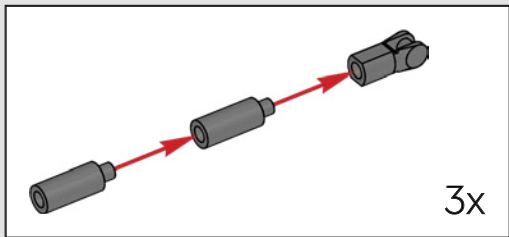

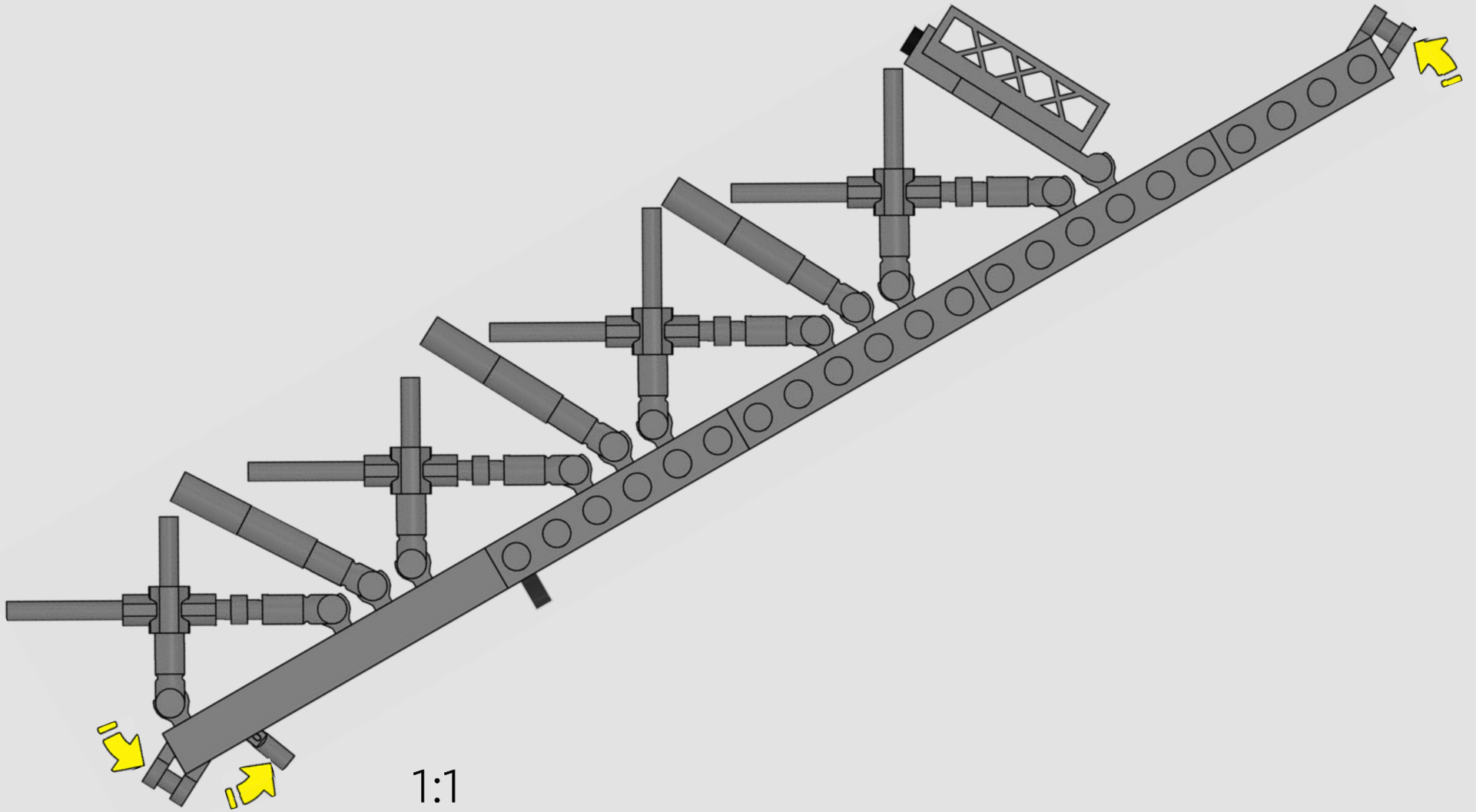

134

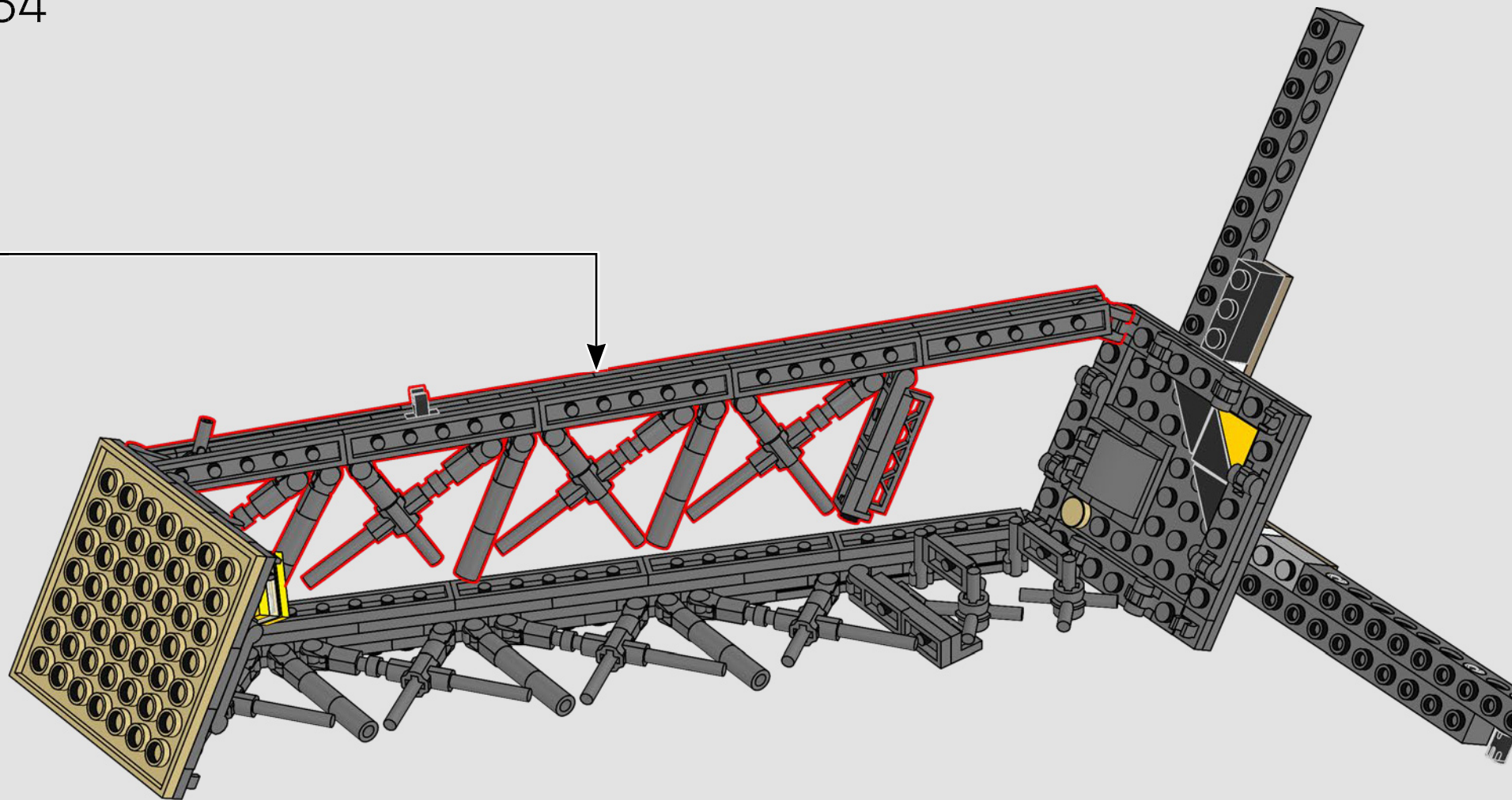

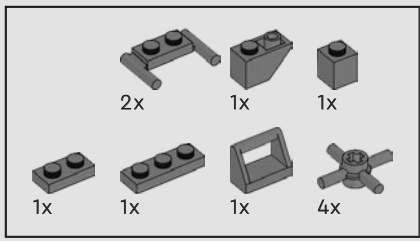

135

1

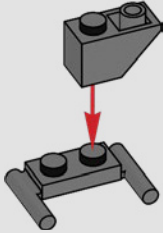

2

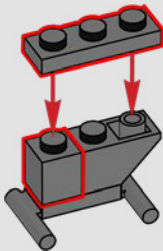

3

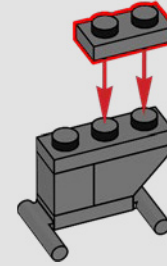

4

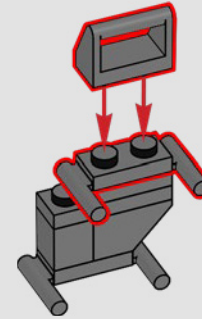

5

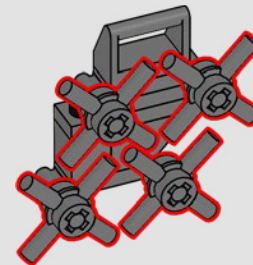

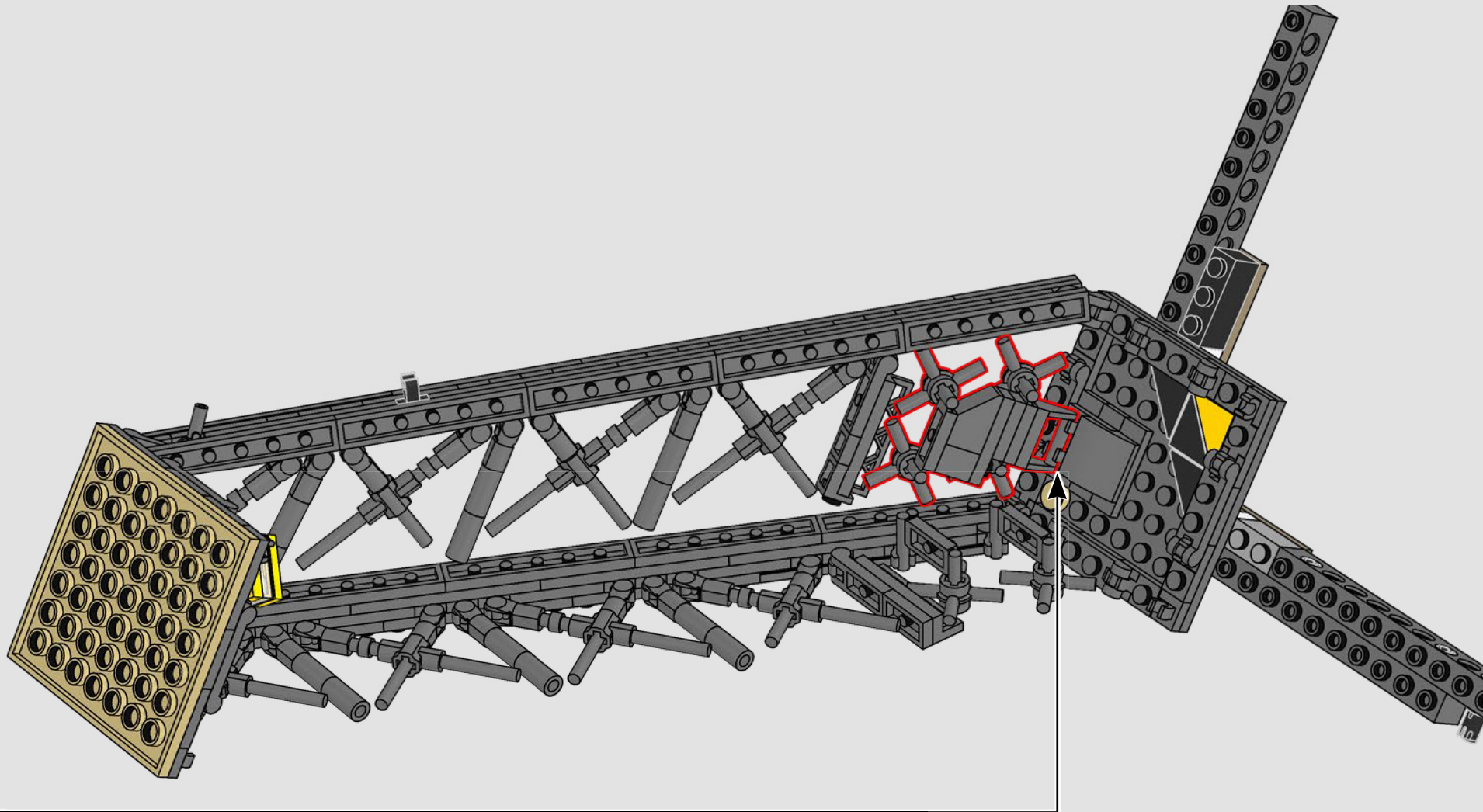

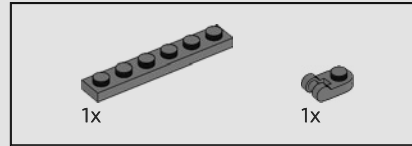
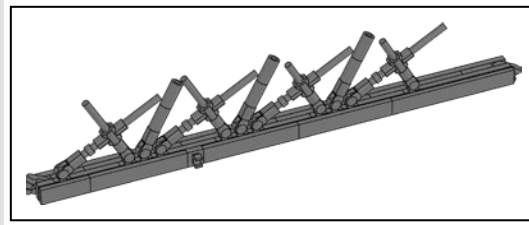

136

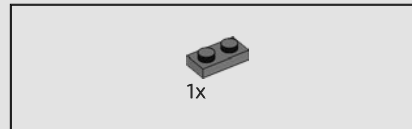
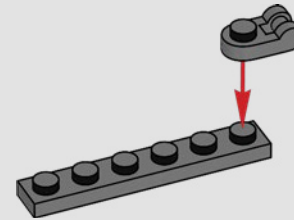

137

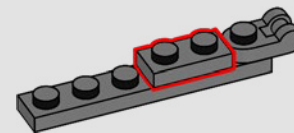

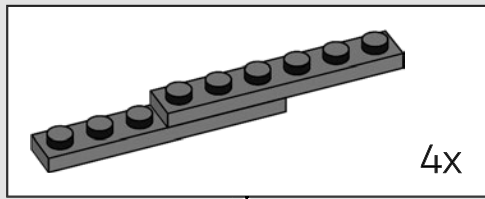
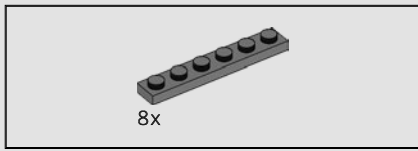

138

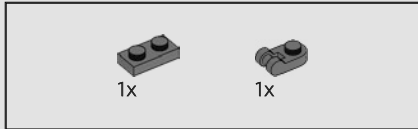
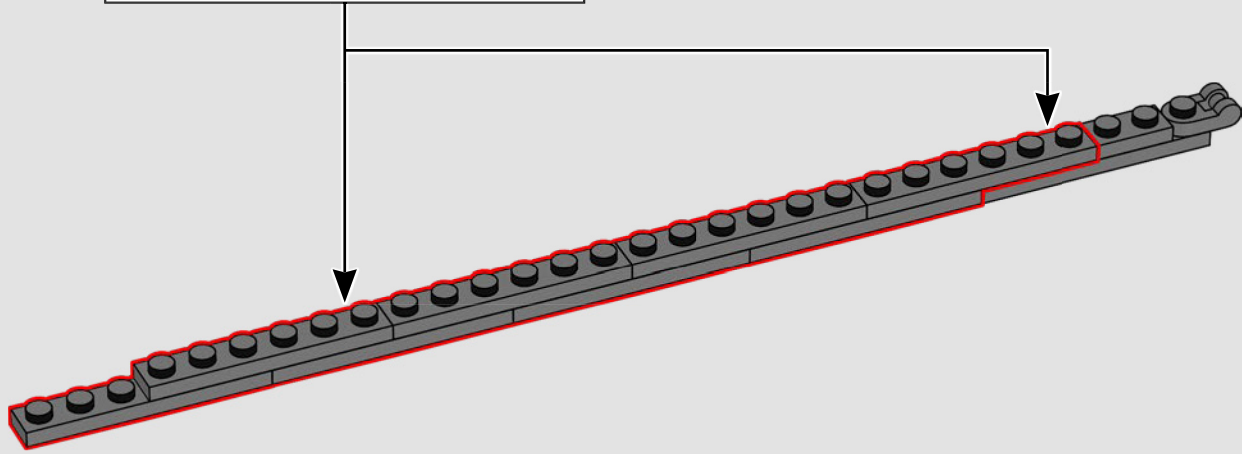

139

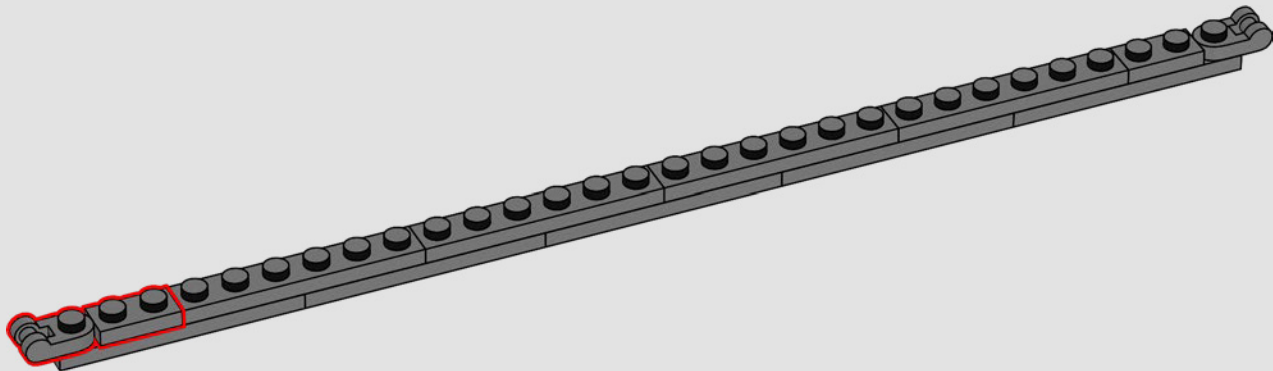

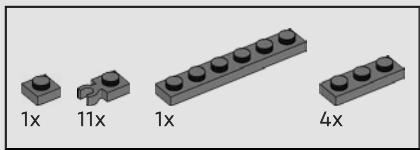

140

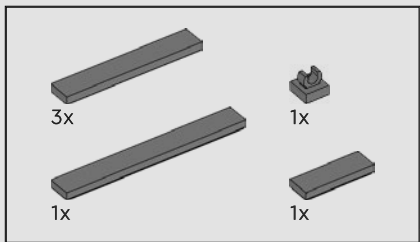
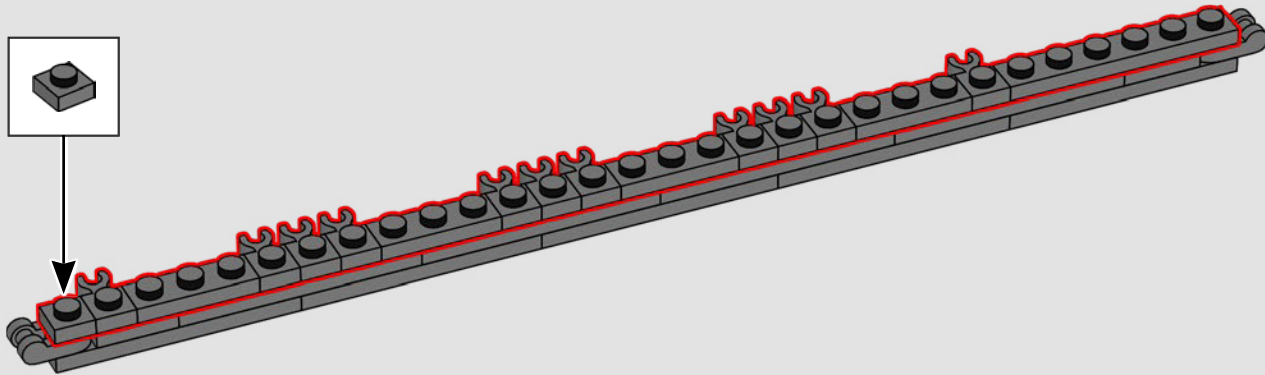

141

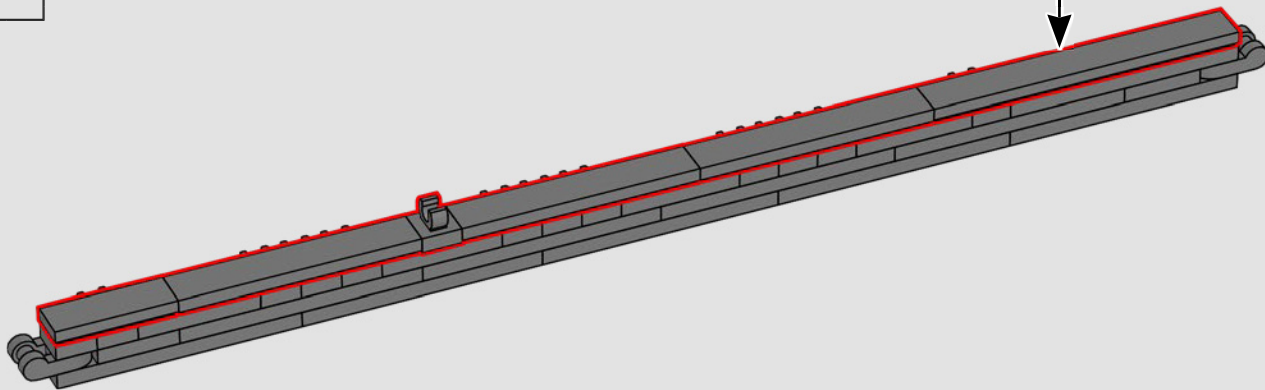
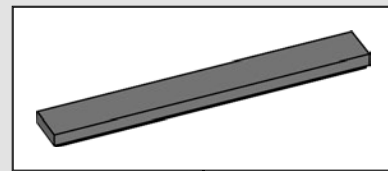

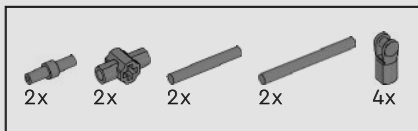

142

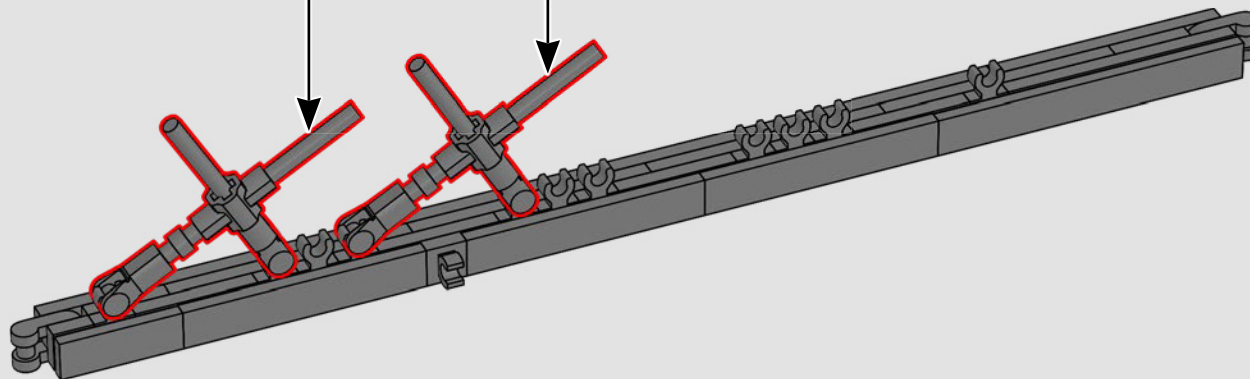
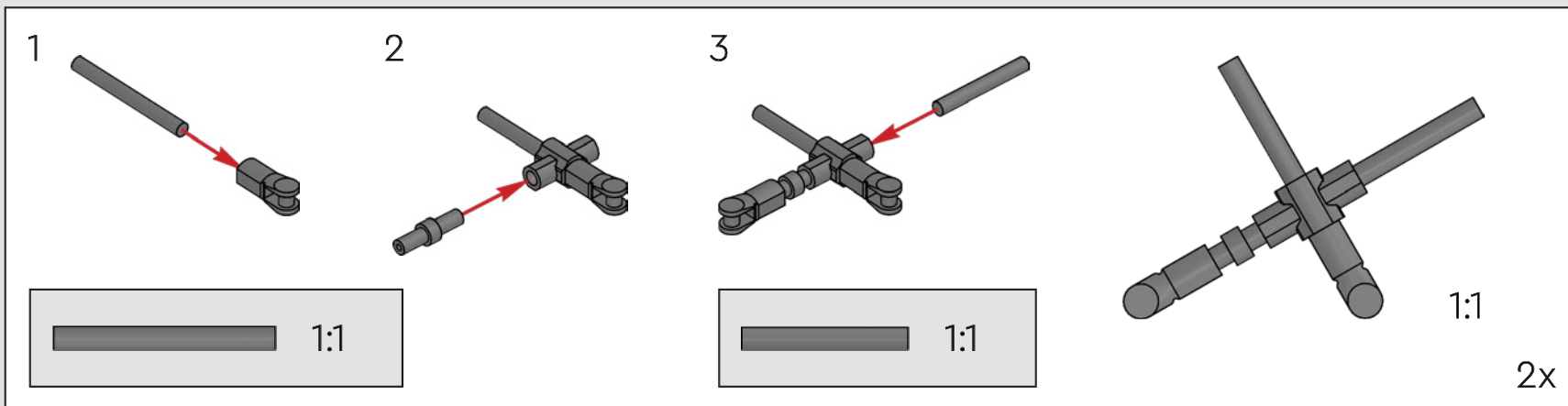

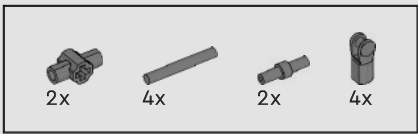

143

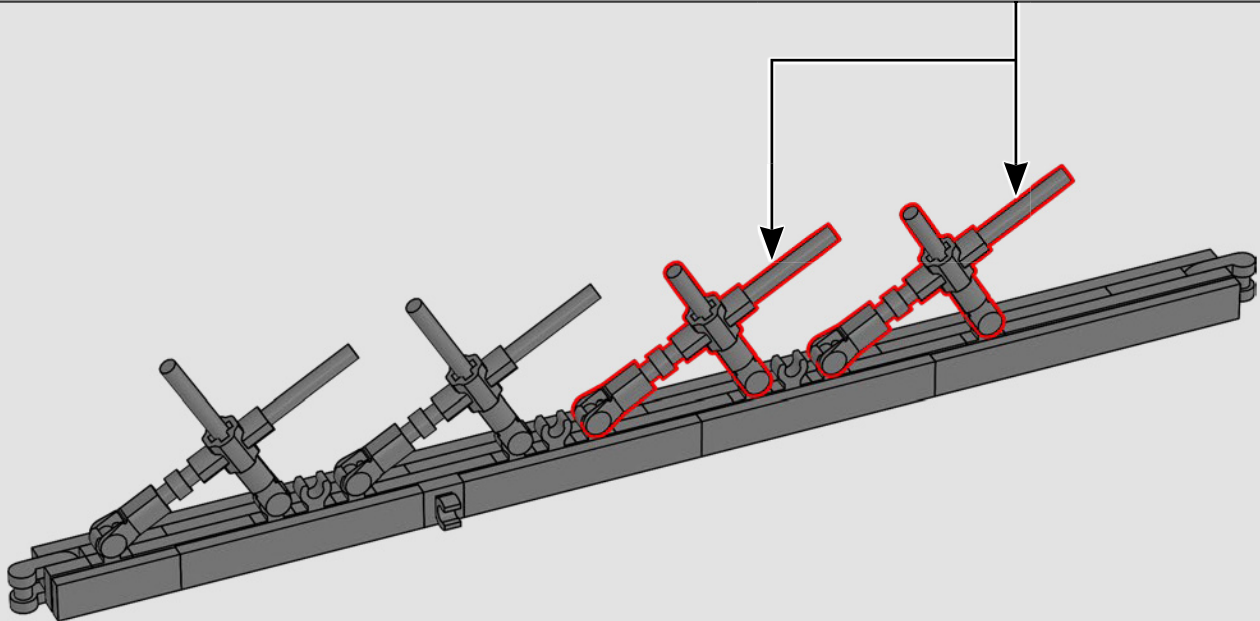
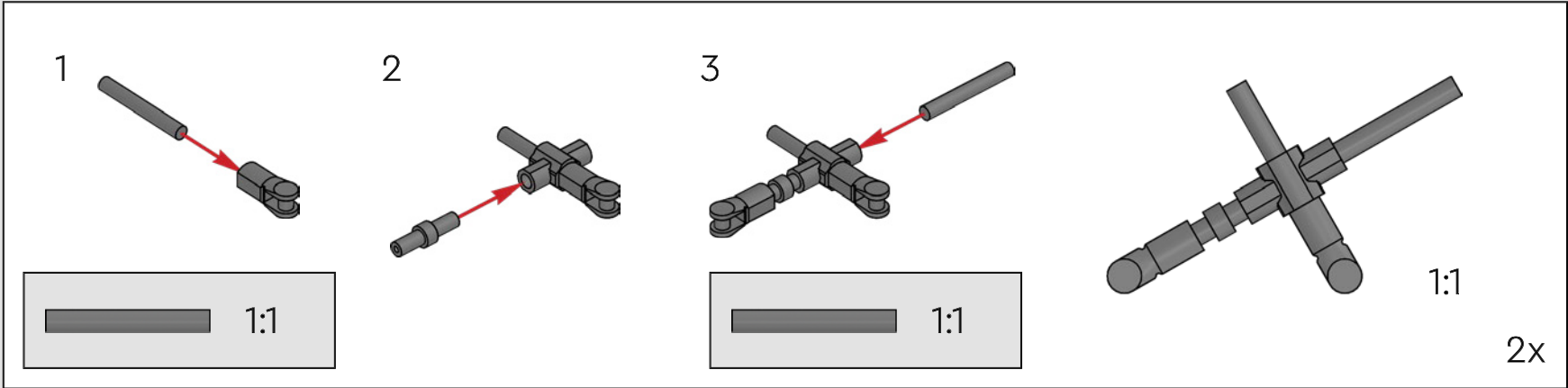

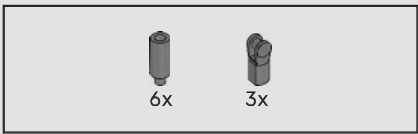

144

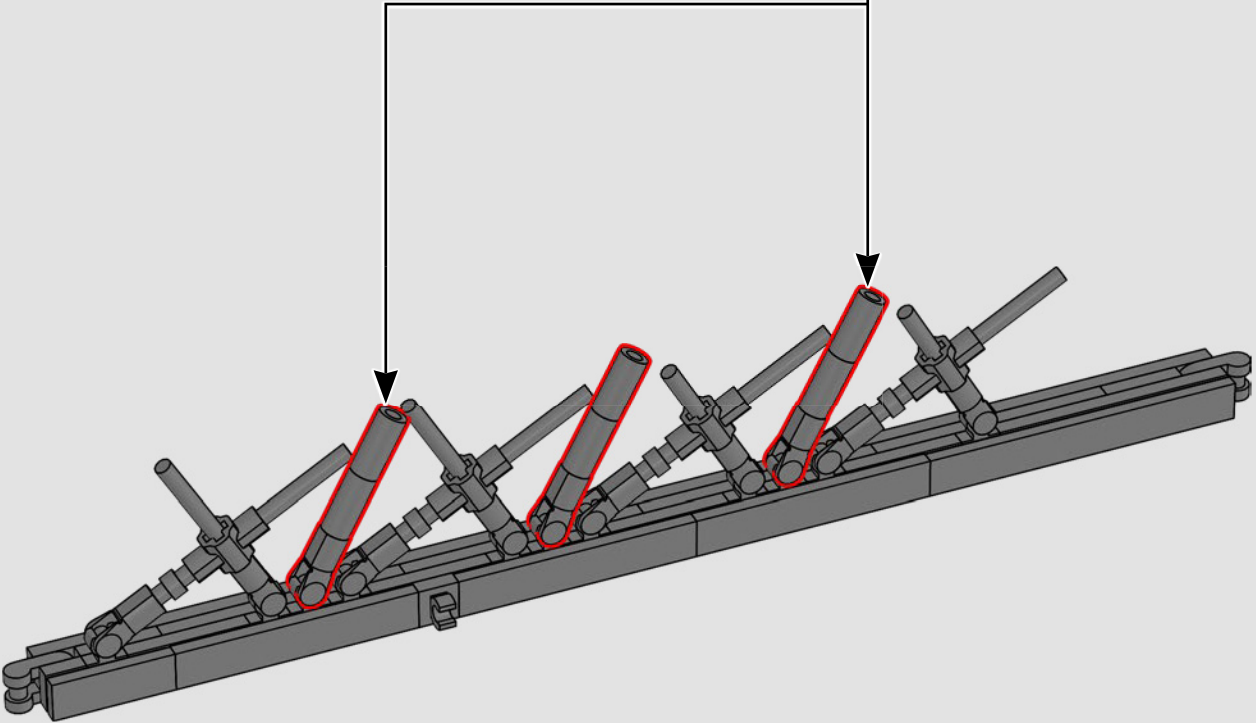
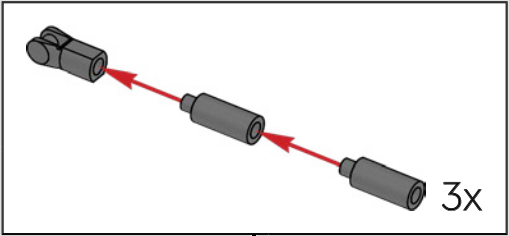

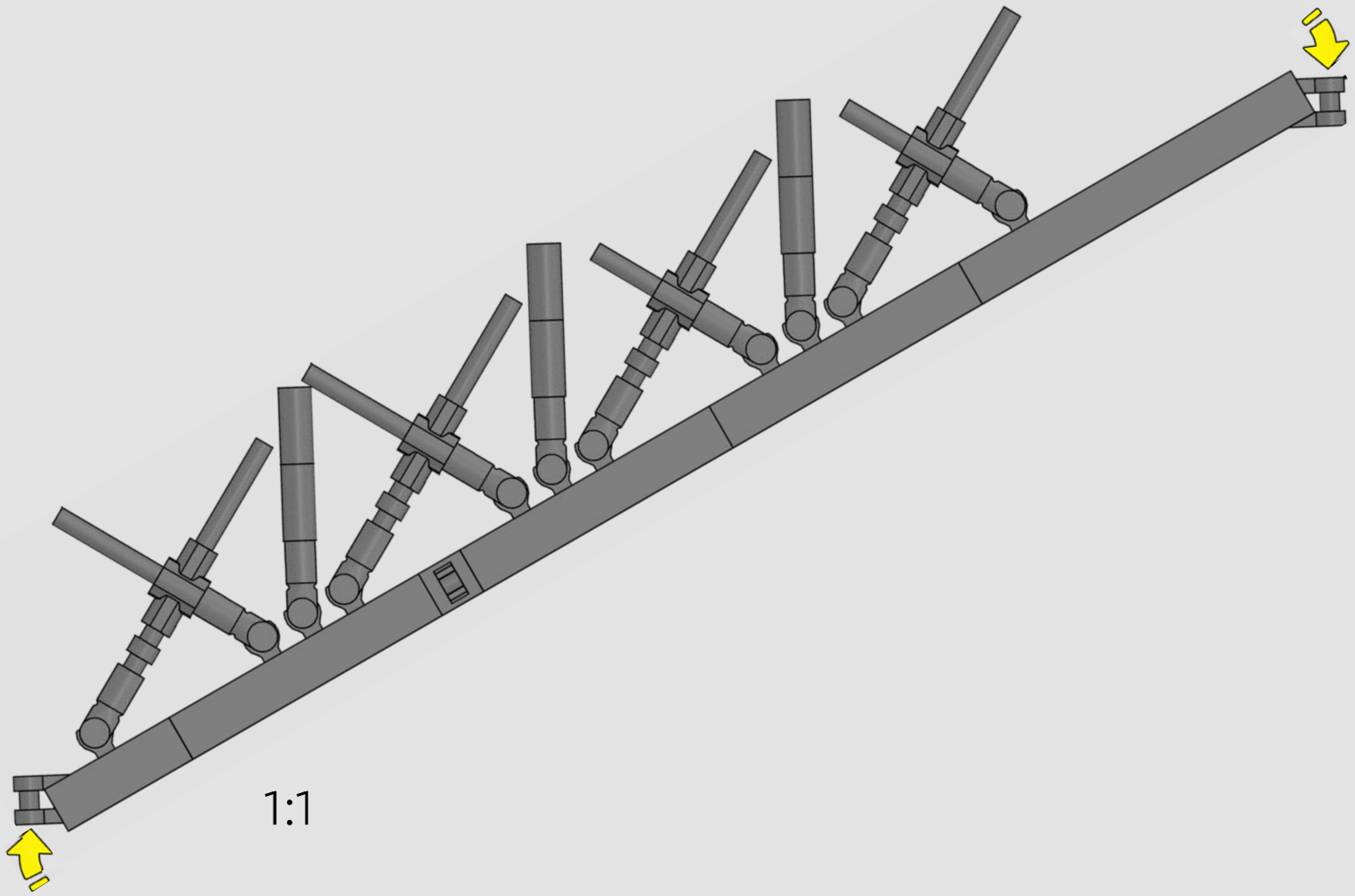

1:1

145

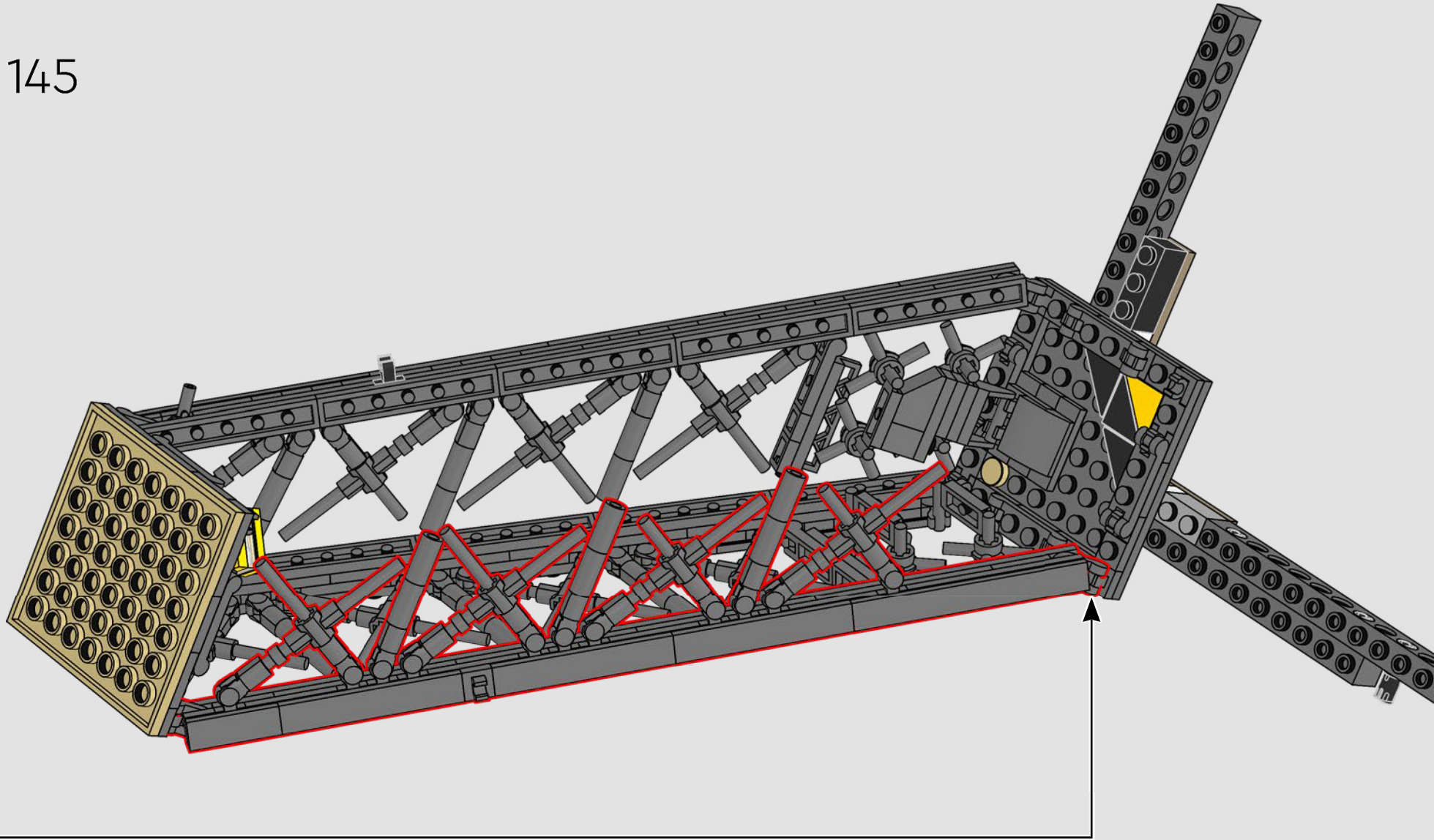

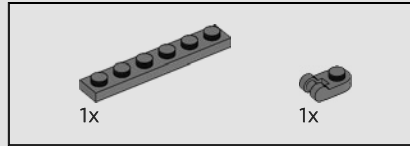
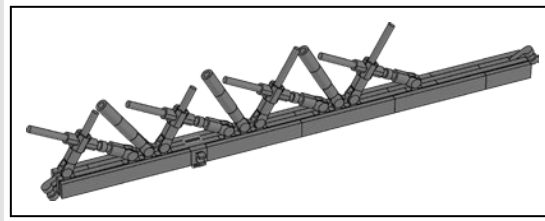

146

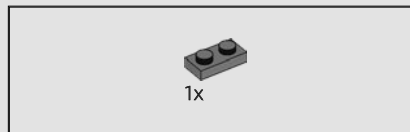
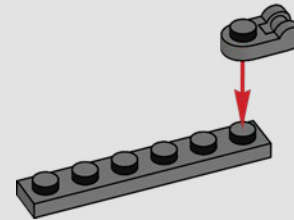

147

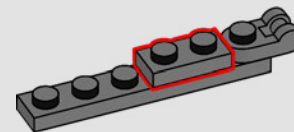

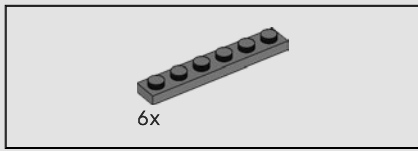

148

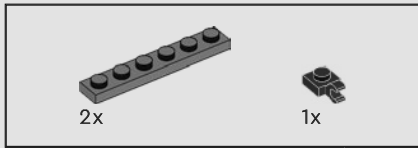
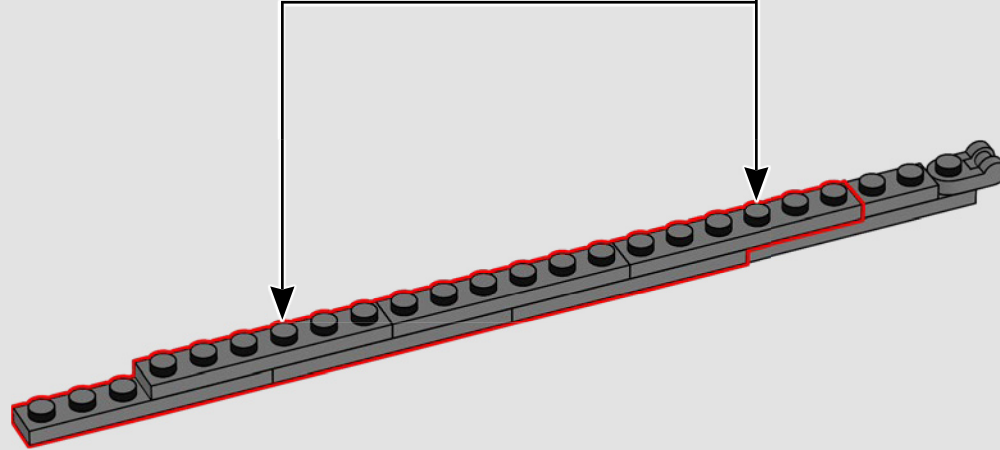
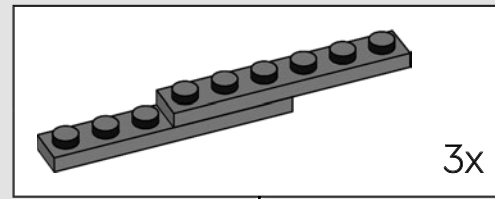

149

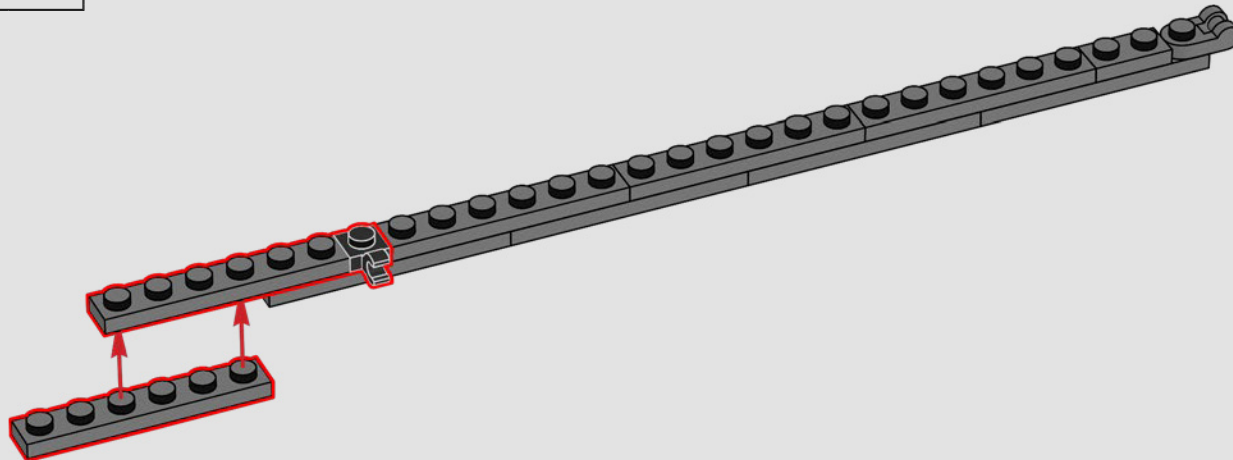

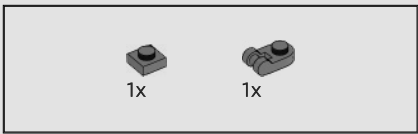

150

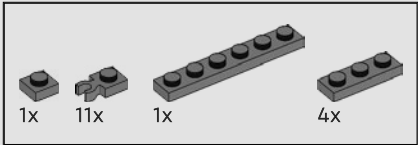
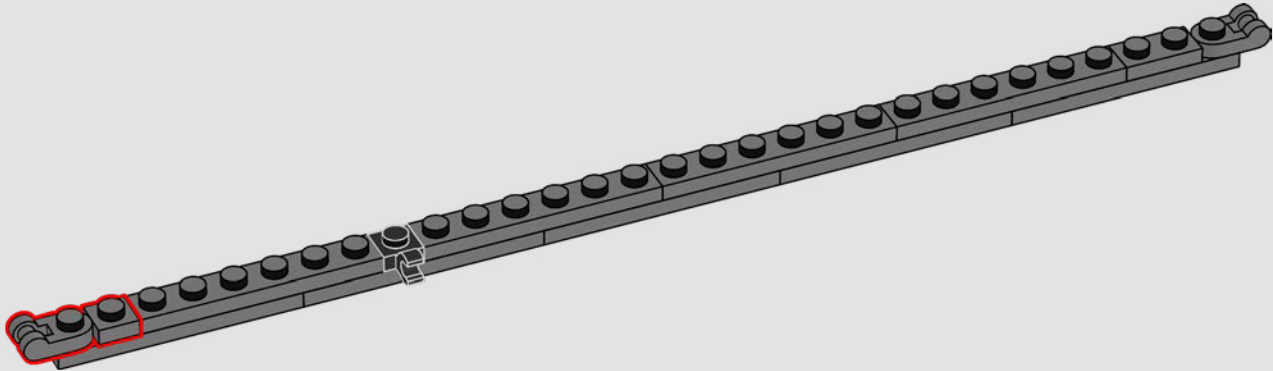

151

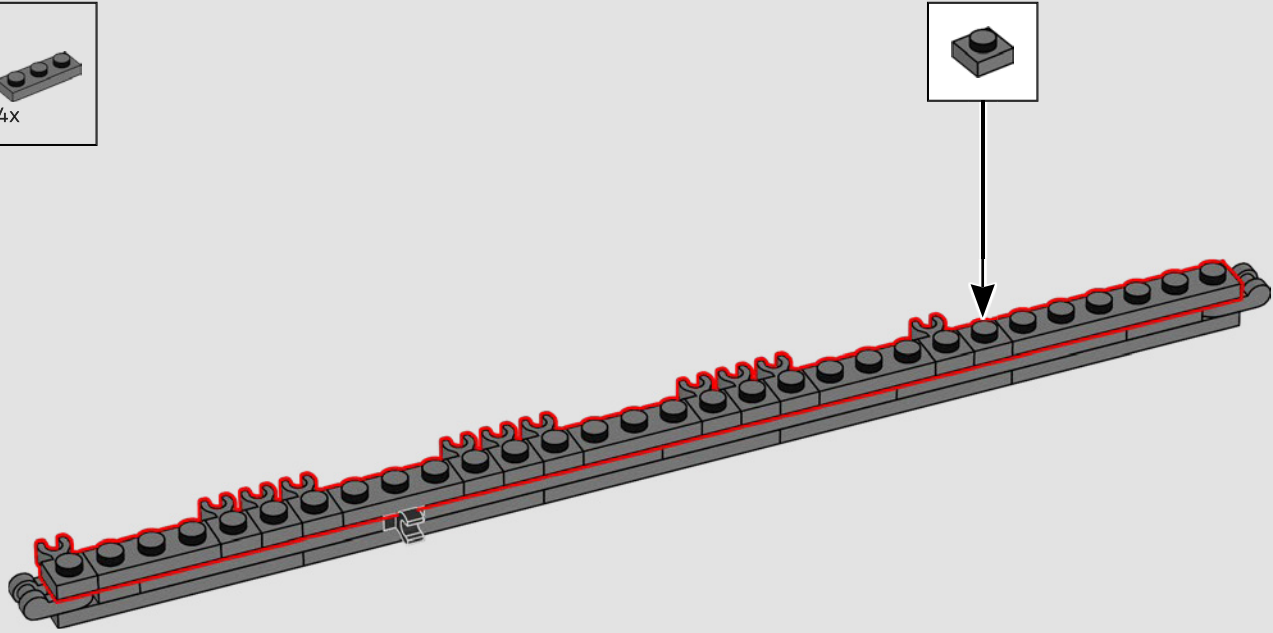

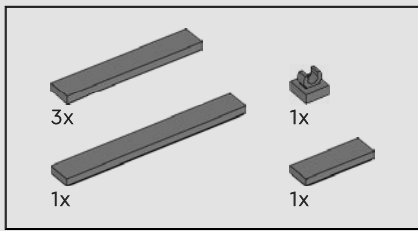

152

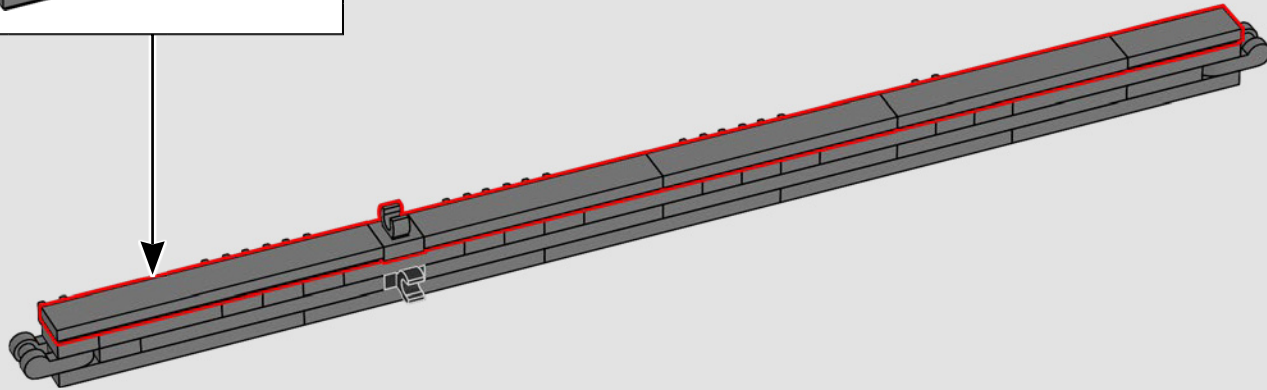
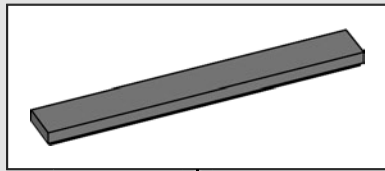

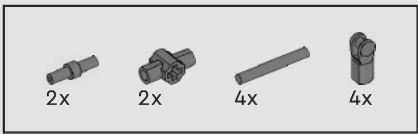

153

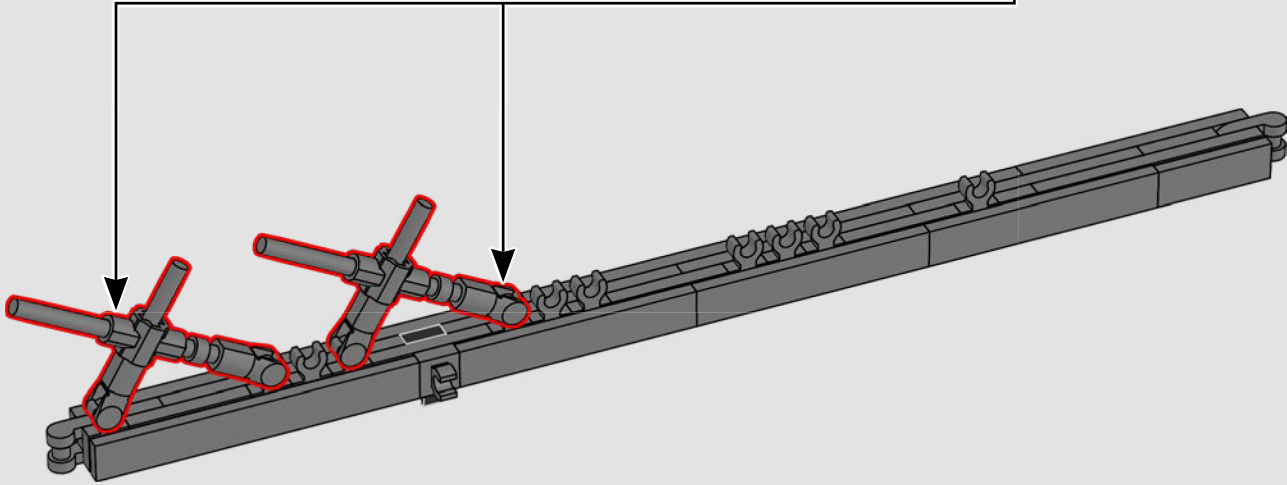
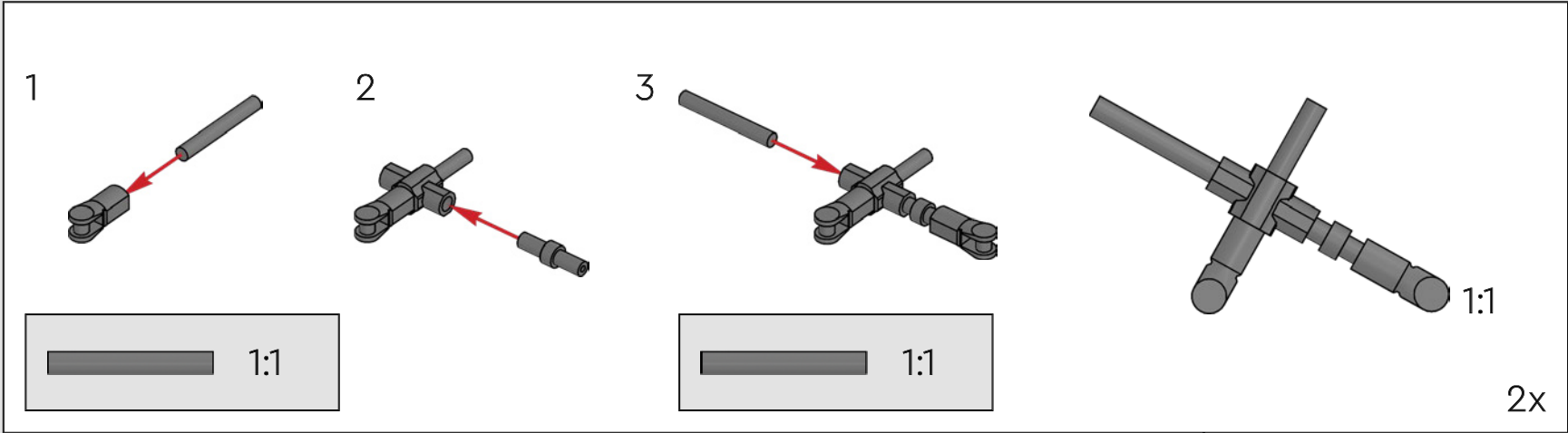

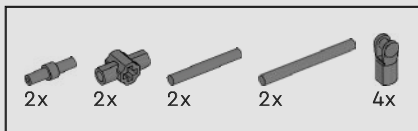

154

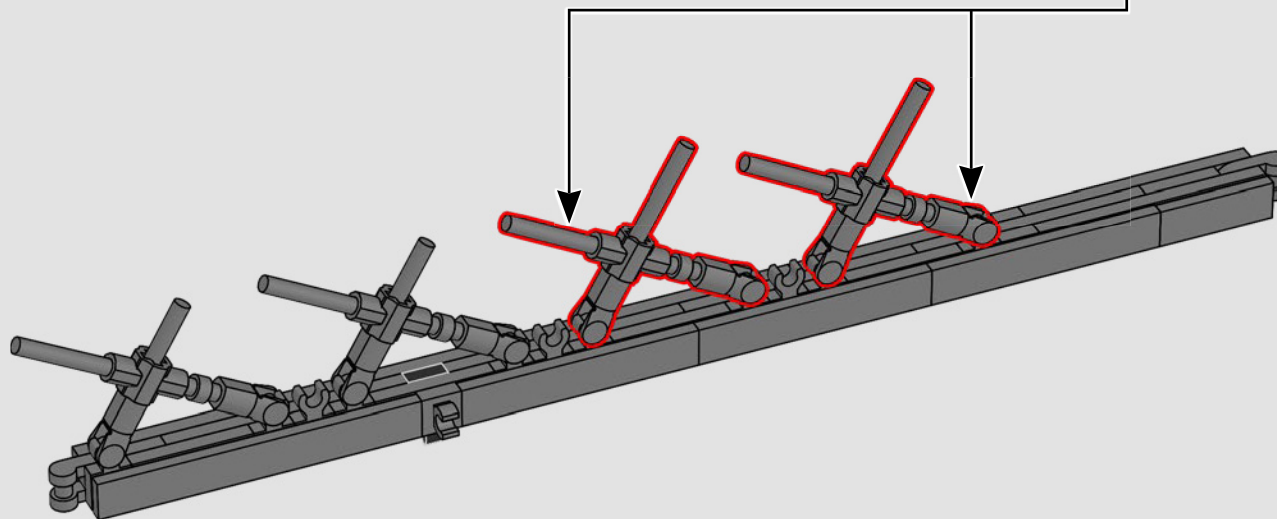
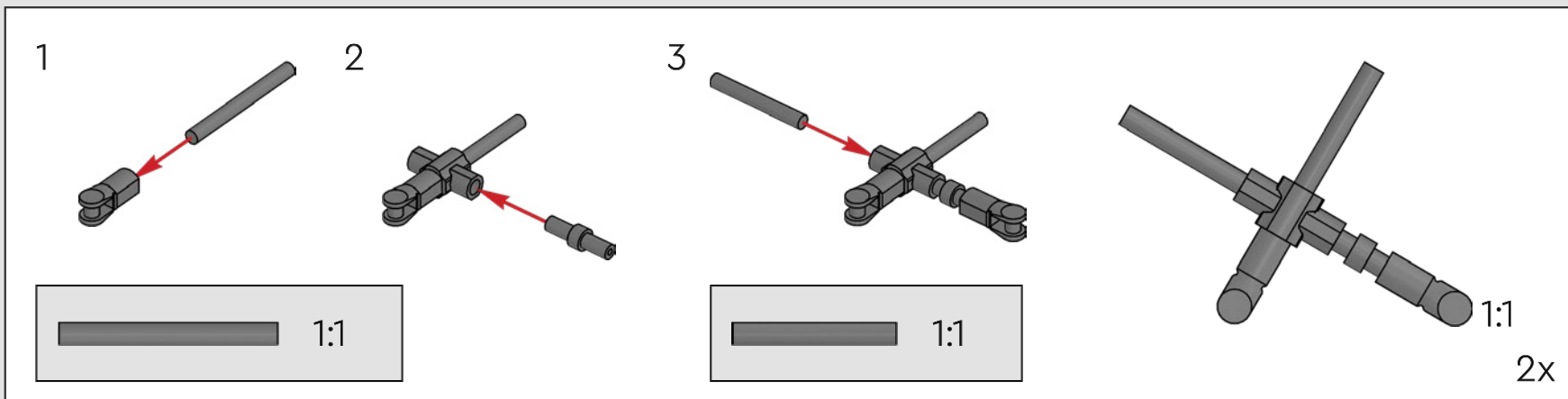

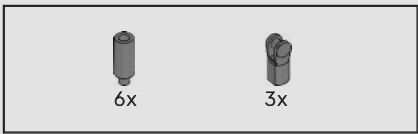

155

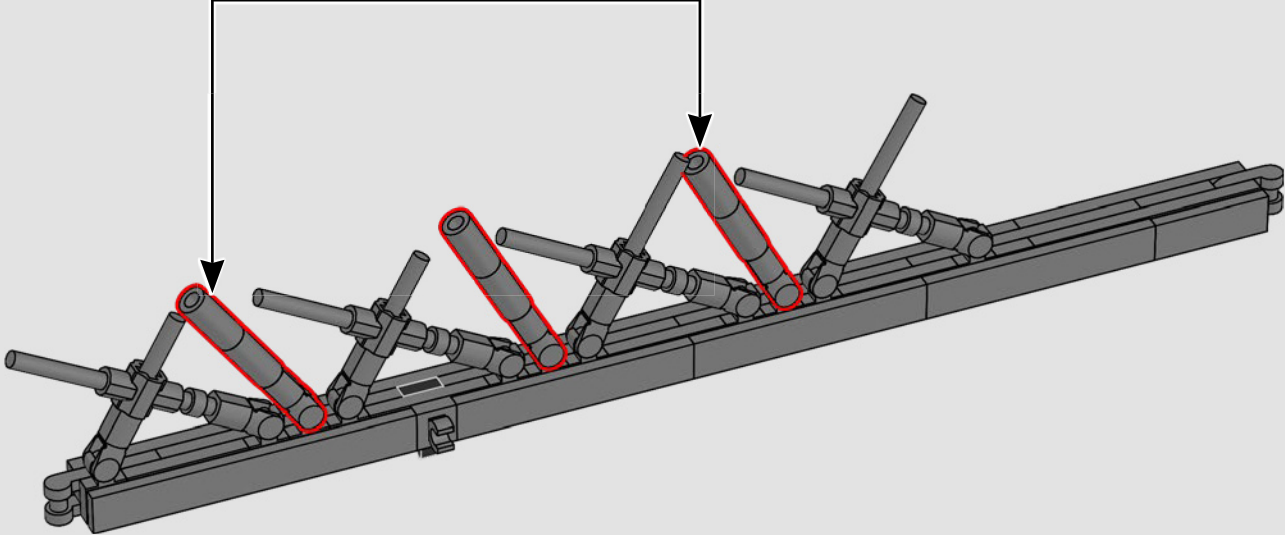
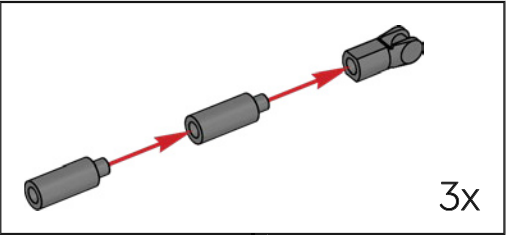

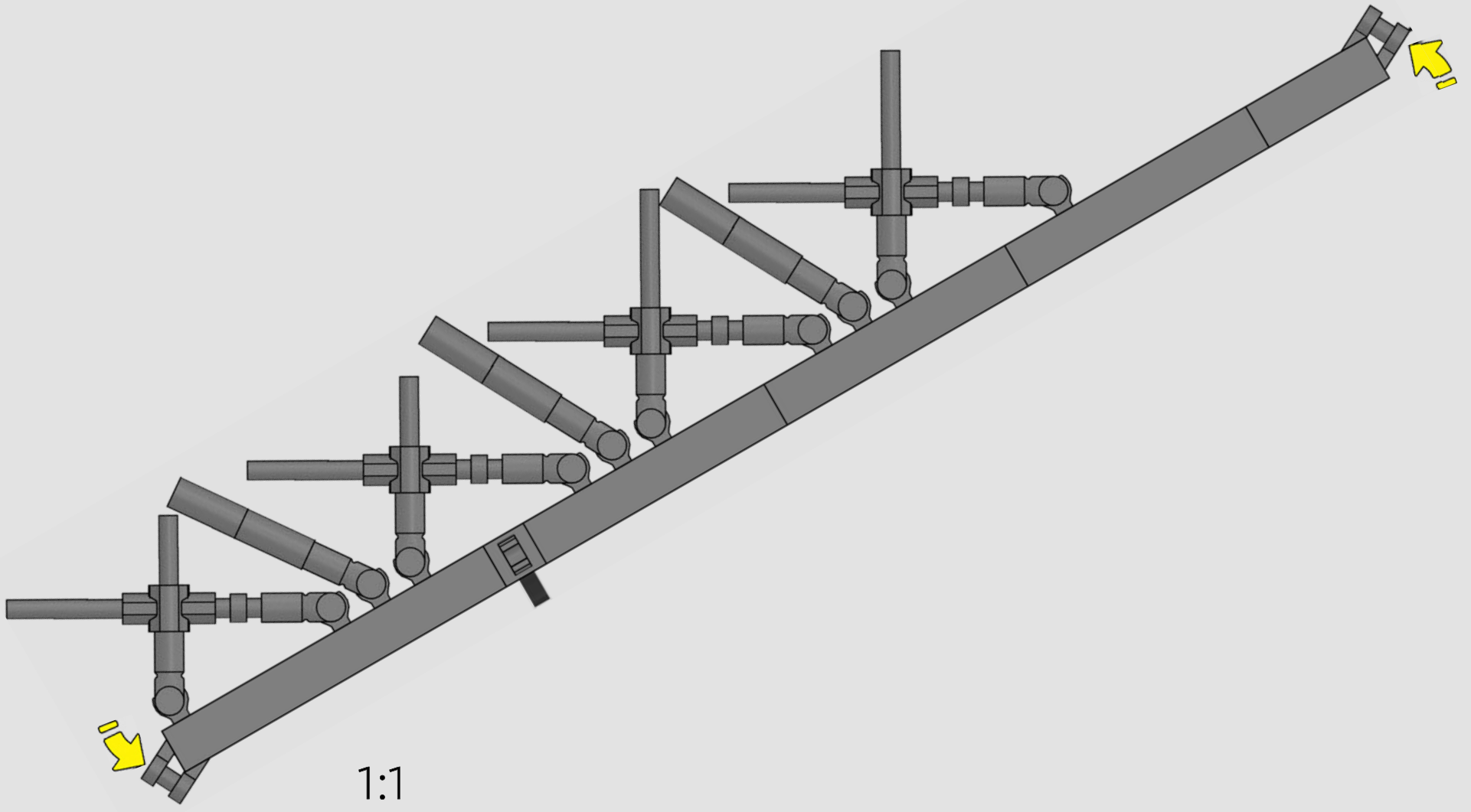

1:1

156

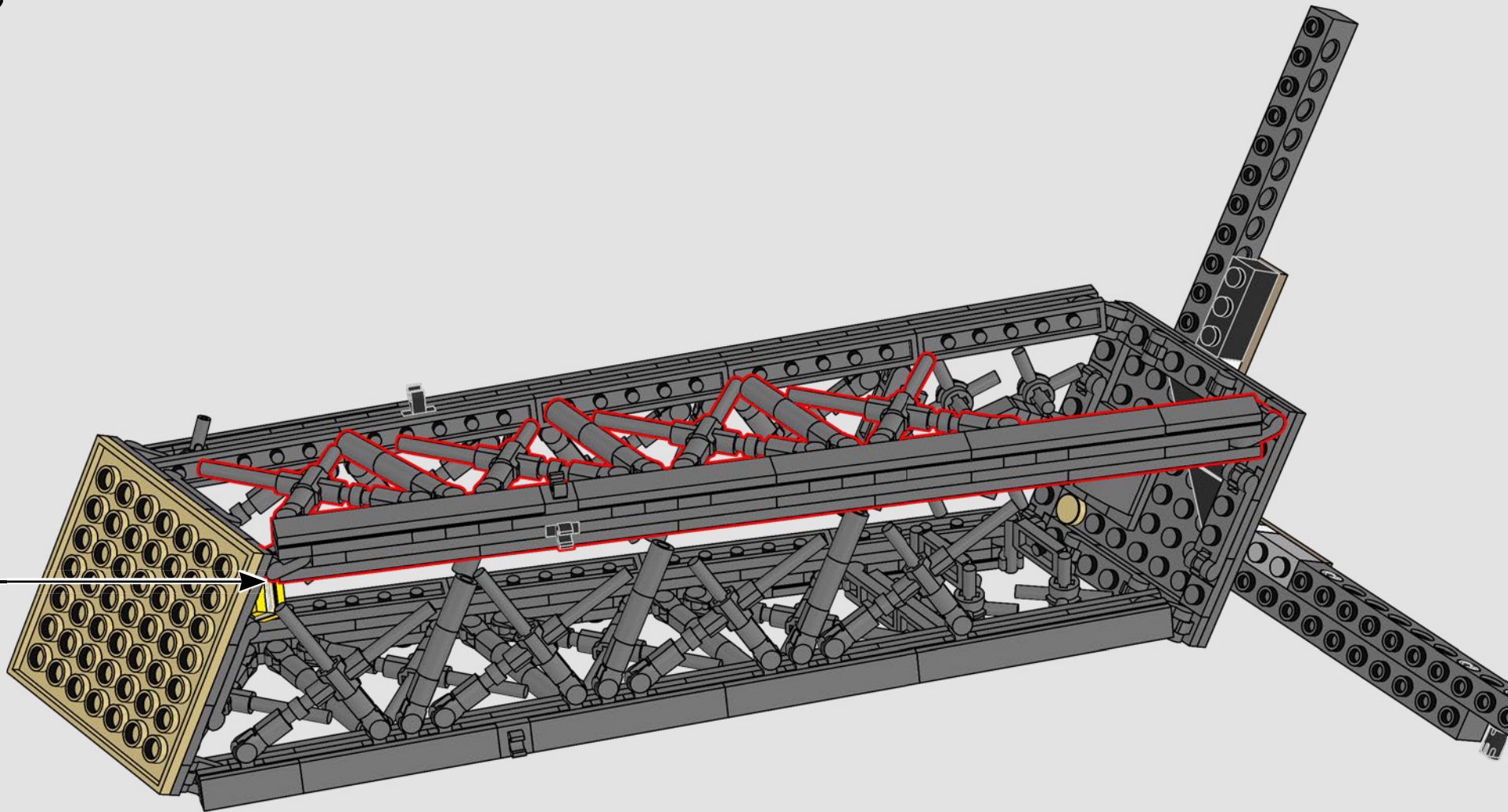

2x



157

The original tower is assembled from pre-made pieces, just like a giant LEGO® model! While the Eiffel tower contains 18,038 different pieces, this LEGO version has 10,000 individual LEGO elements.

La tour originale est assemblée à partir de pièces préfabriquées, tout comme un modèle LEGO® géant ! Alors que la Tour Eiffel contient 18 038 pièces différentes, cette version LEGO comporte 10 001 éléments LEGO individuels.

La torre original se ensambló a partir de piezas prefabricadas, ¡como si fuera un modelo LEGO® gigante! Mientras que la Torre Eiffel tiene 18.038 piezas, esta versión LEGO se compone de 10.001 elementos LEGO individuales.



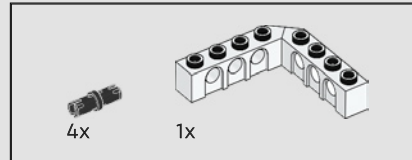
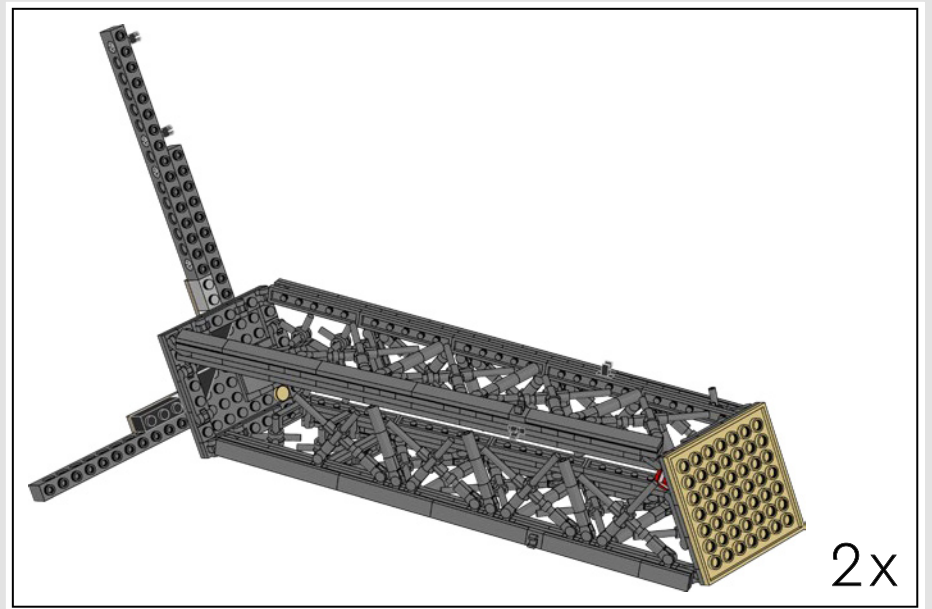

158

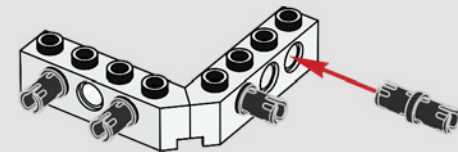

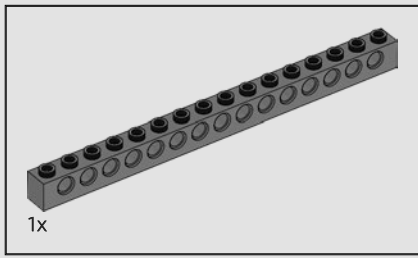

159

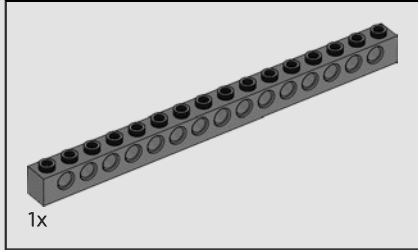
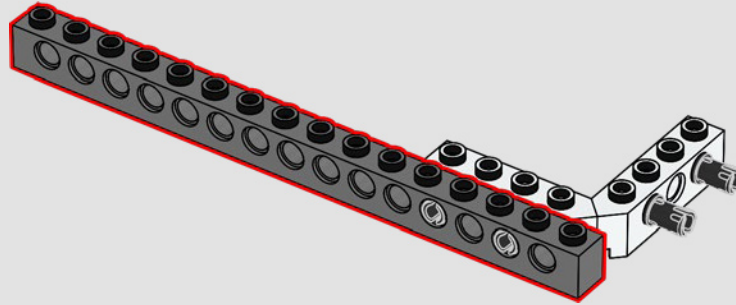

160

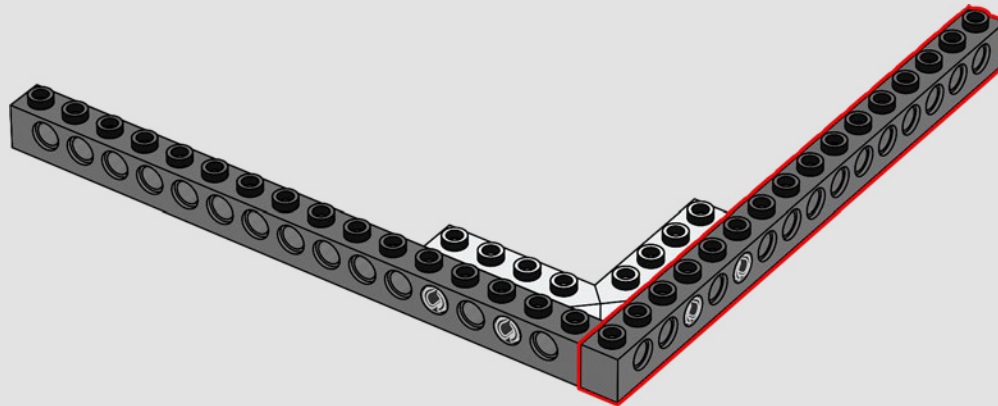

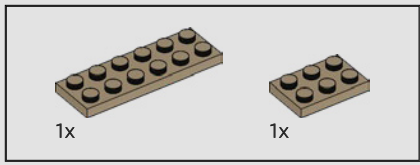

161

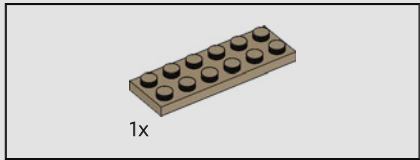
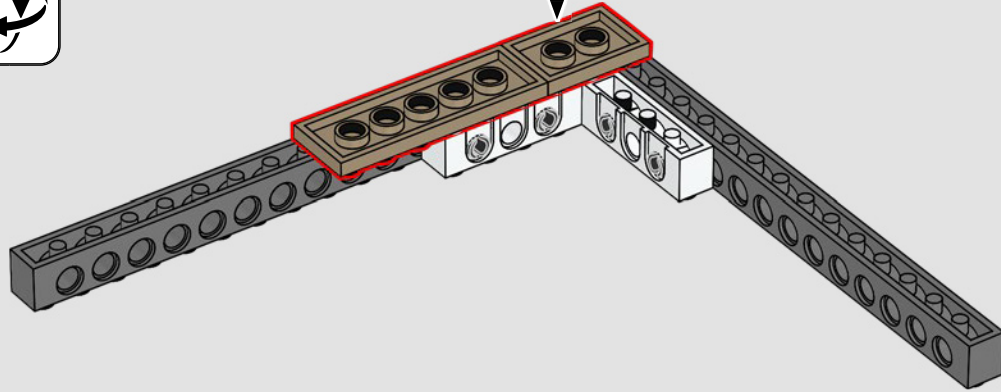
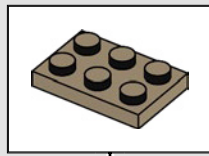

162

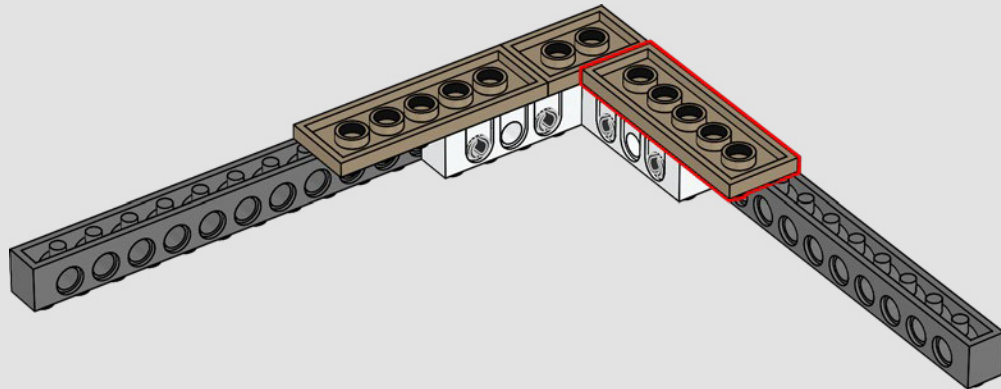

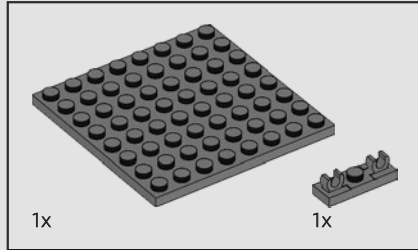
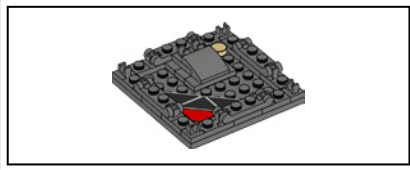

163

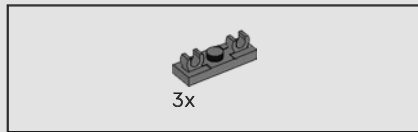
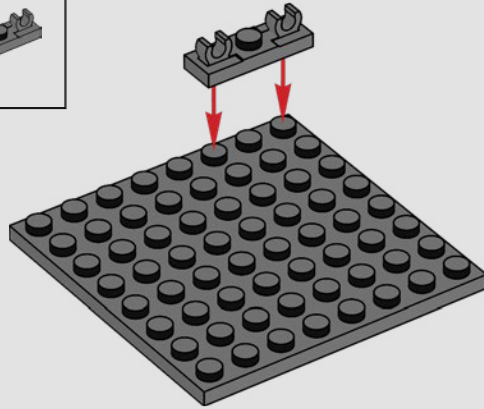

164

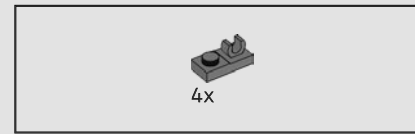
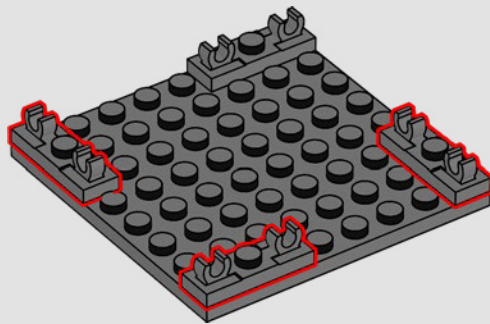

165

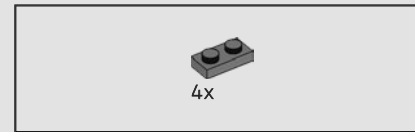
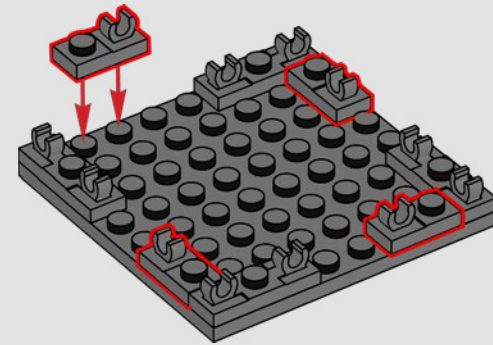

166

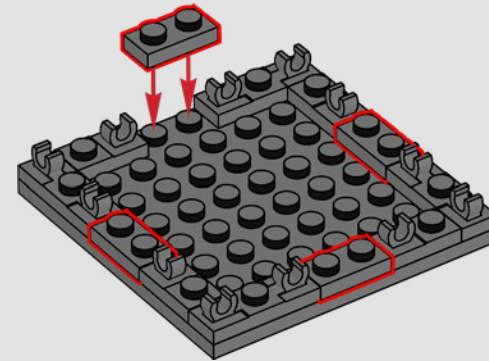

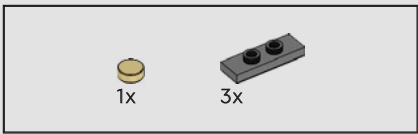

167

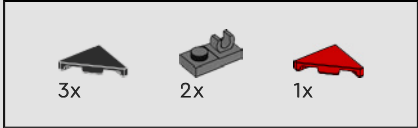
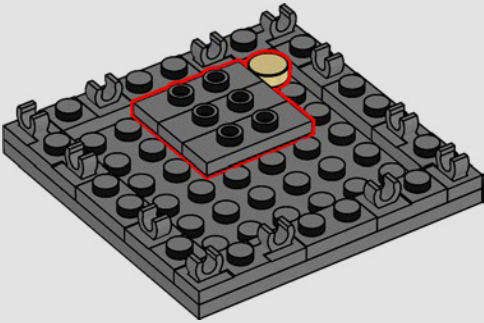

168

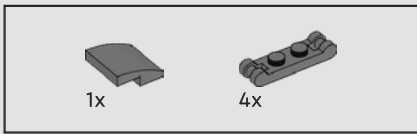
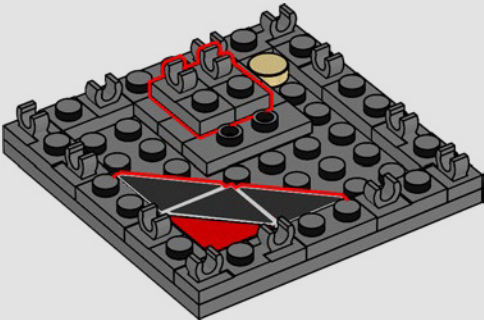

169

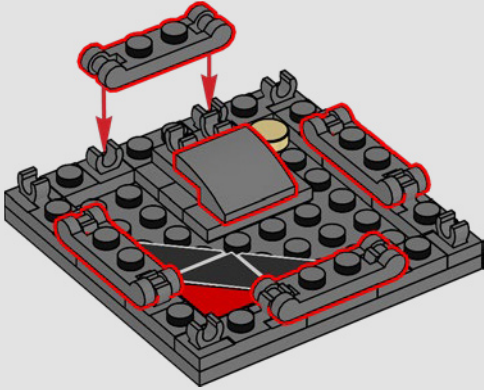

170

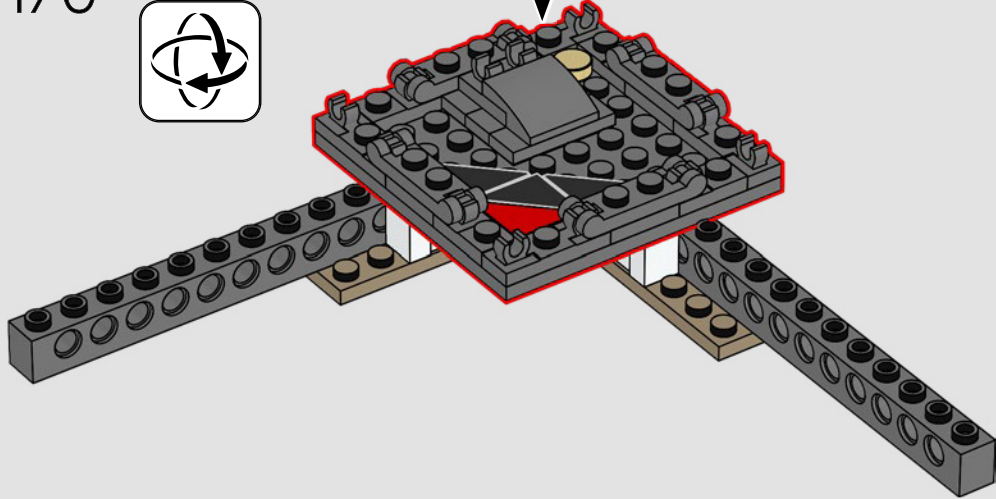

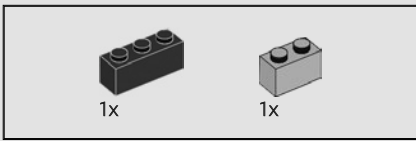

171

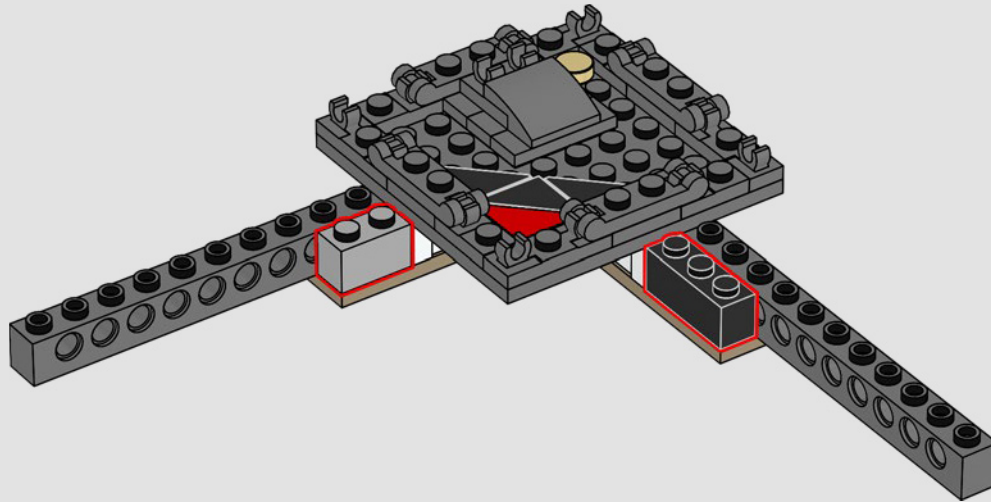

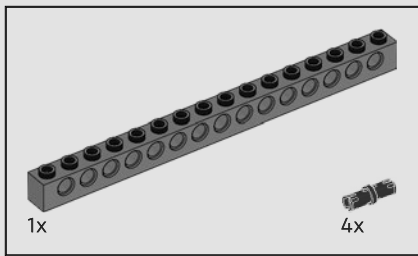

172

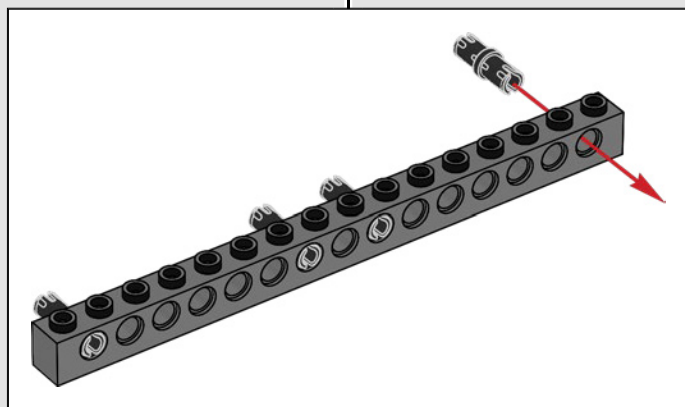
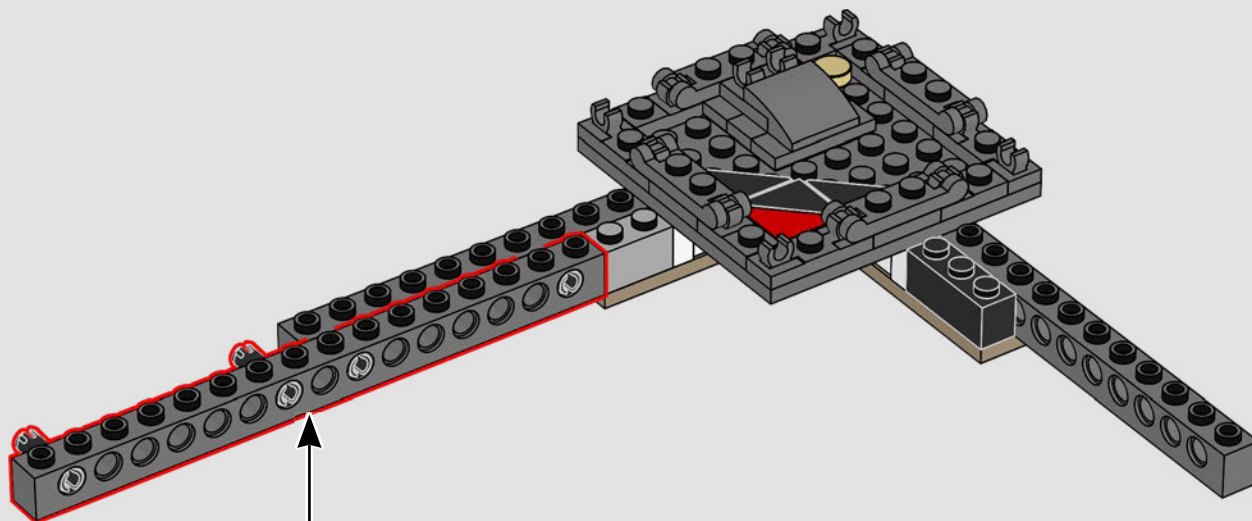

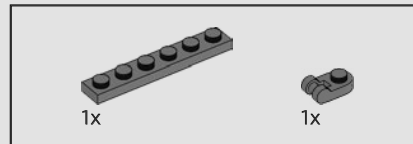
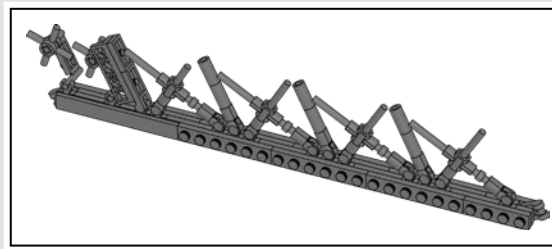

173

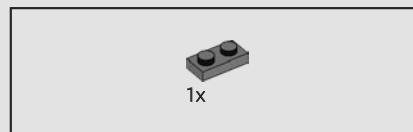
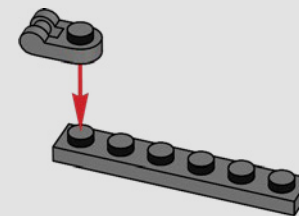

174

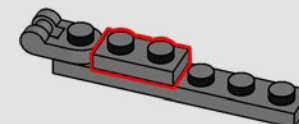

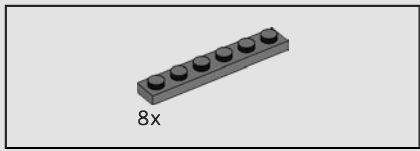

175

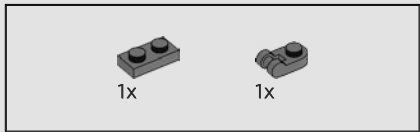
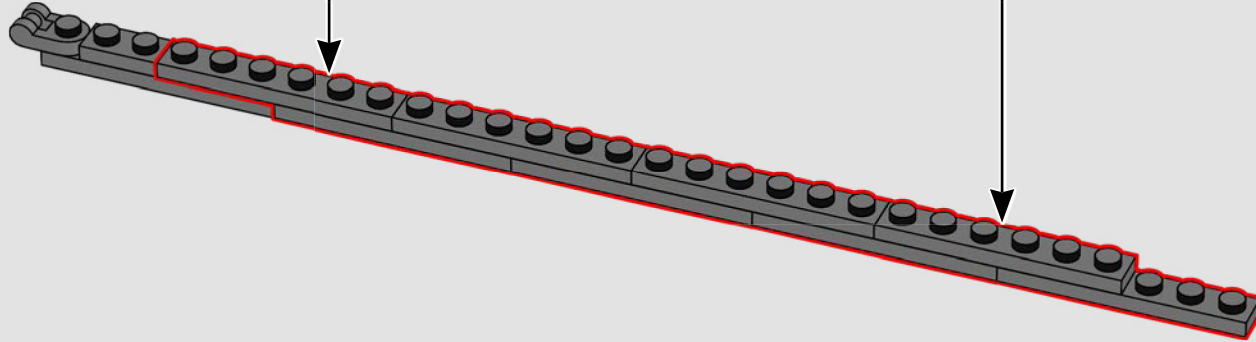
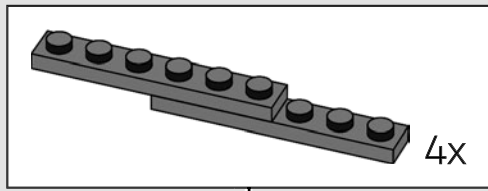

176

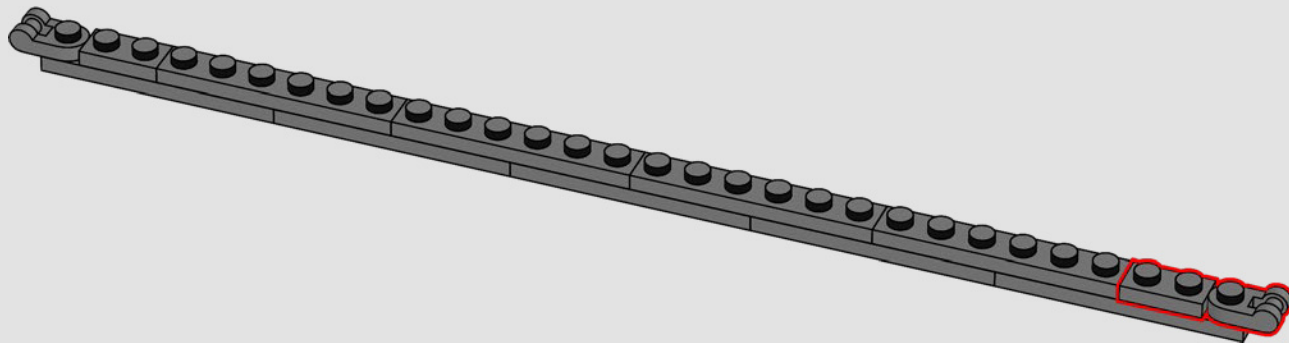

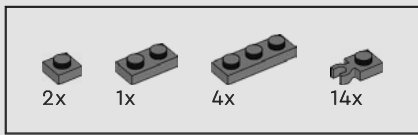

177

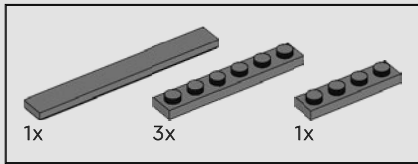
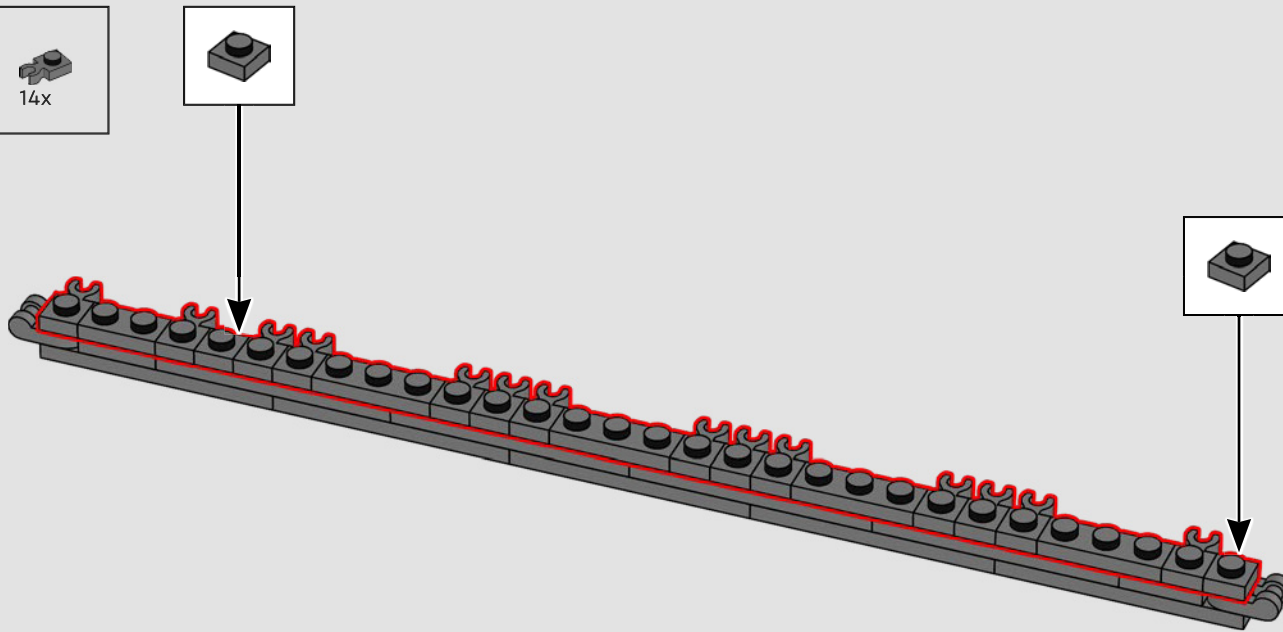

178

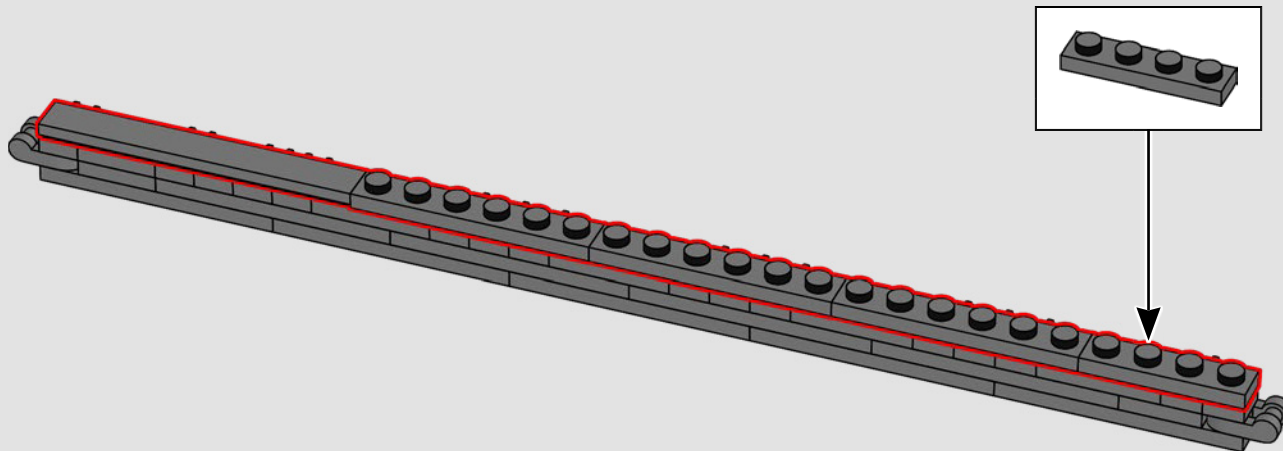

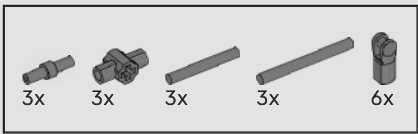

179

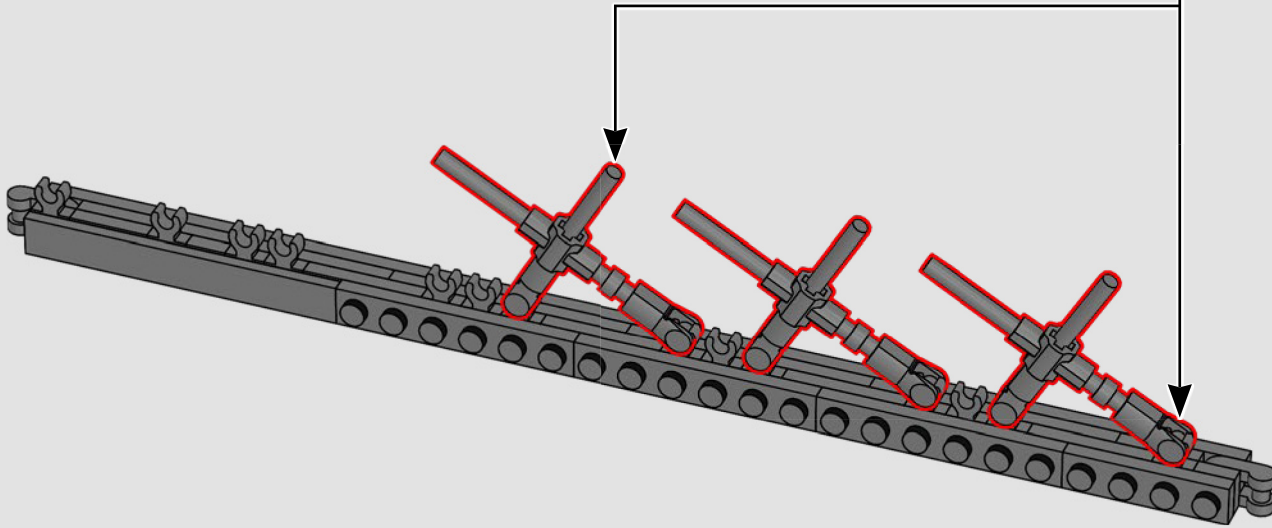
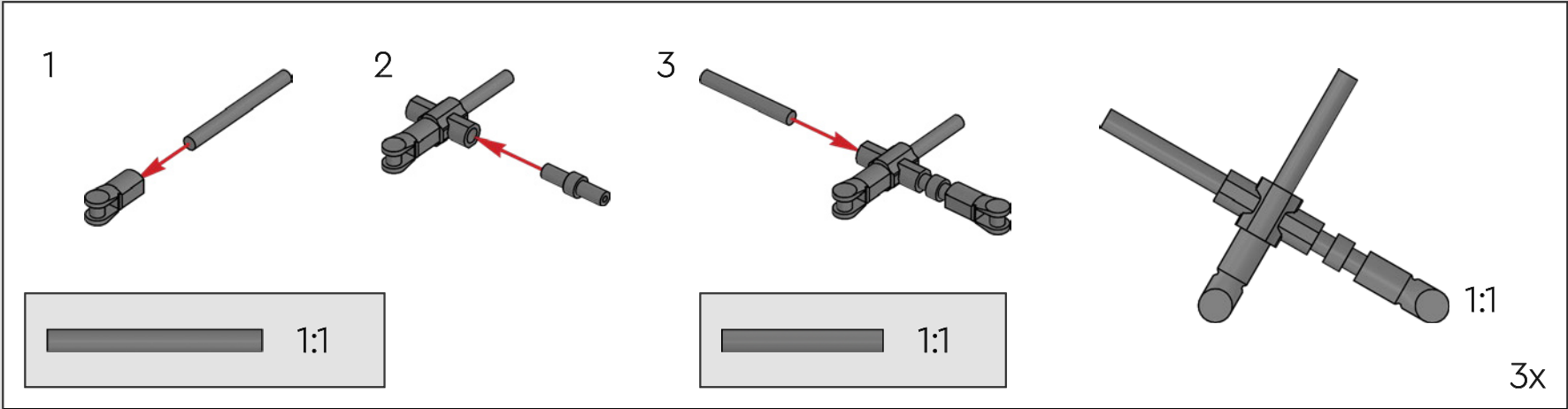

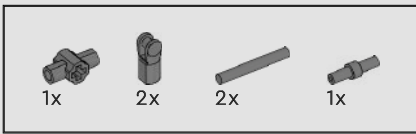

180

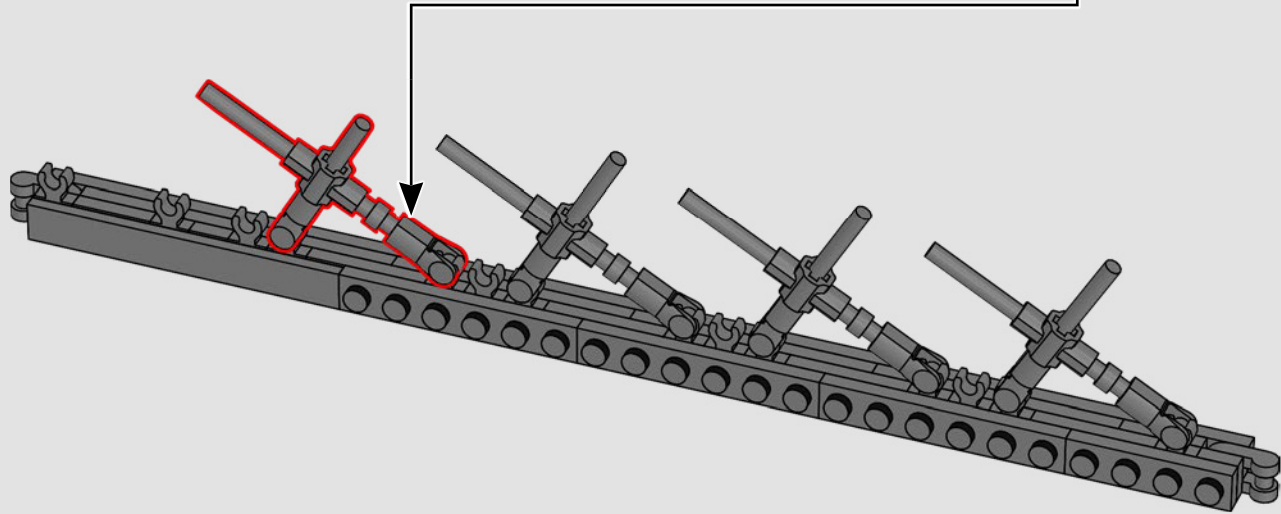
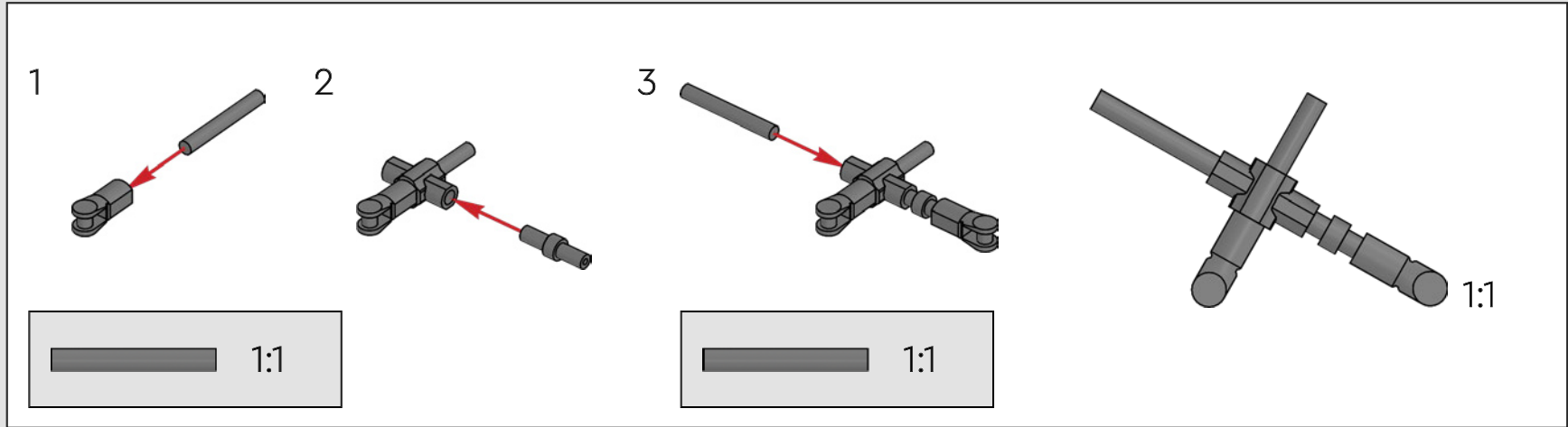

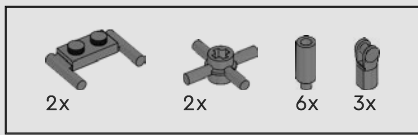

181

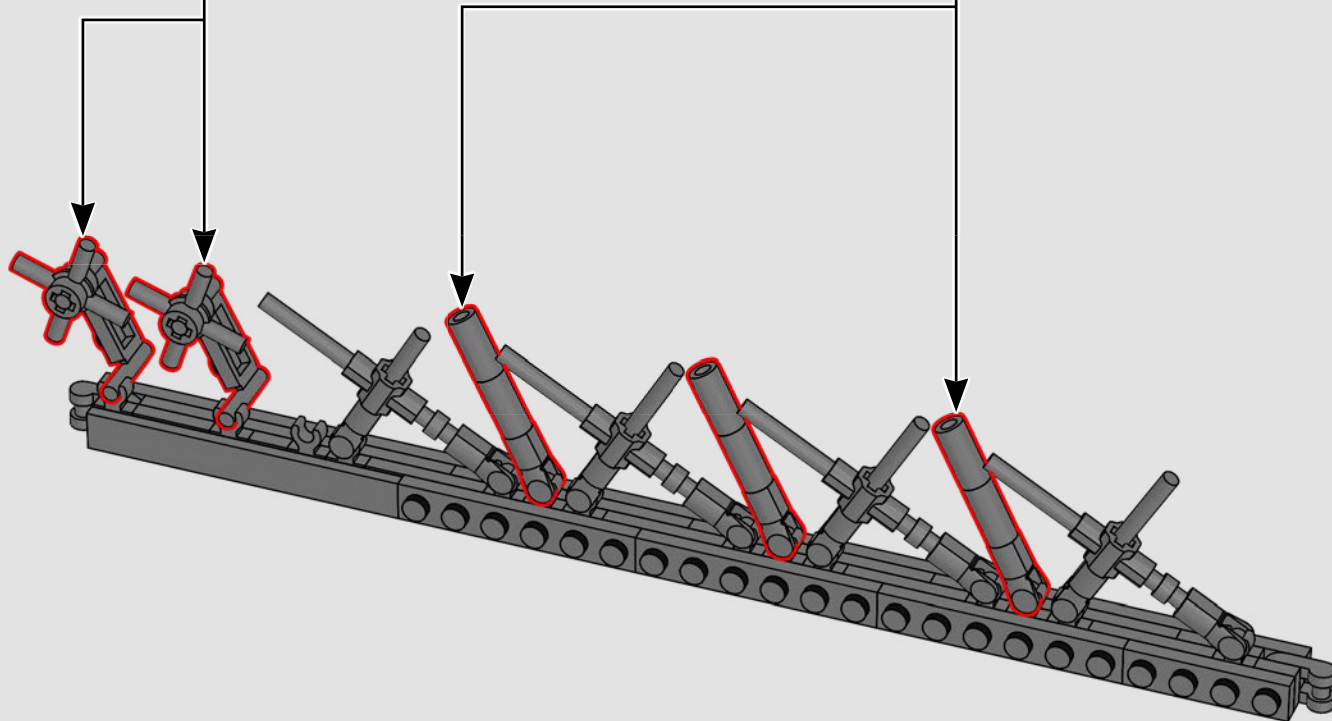
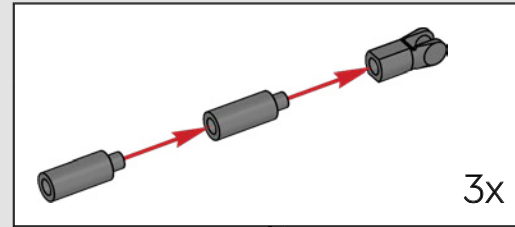
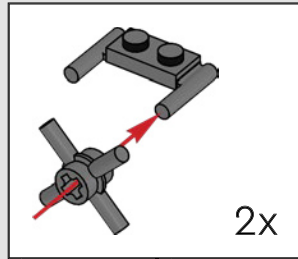

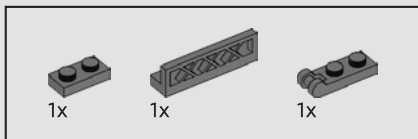

182

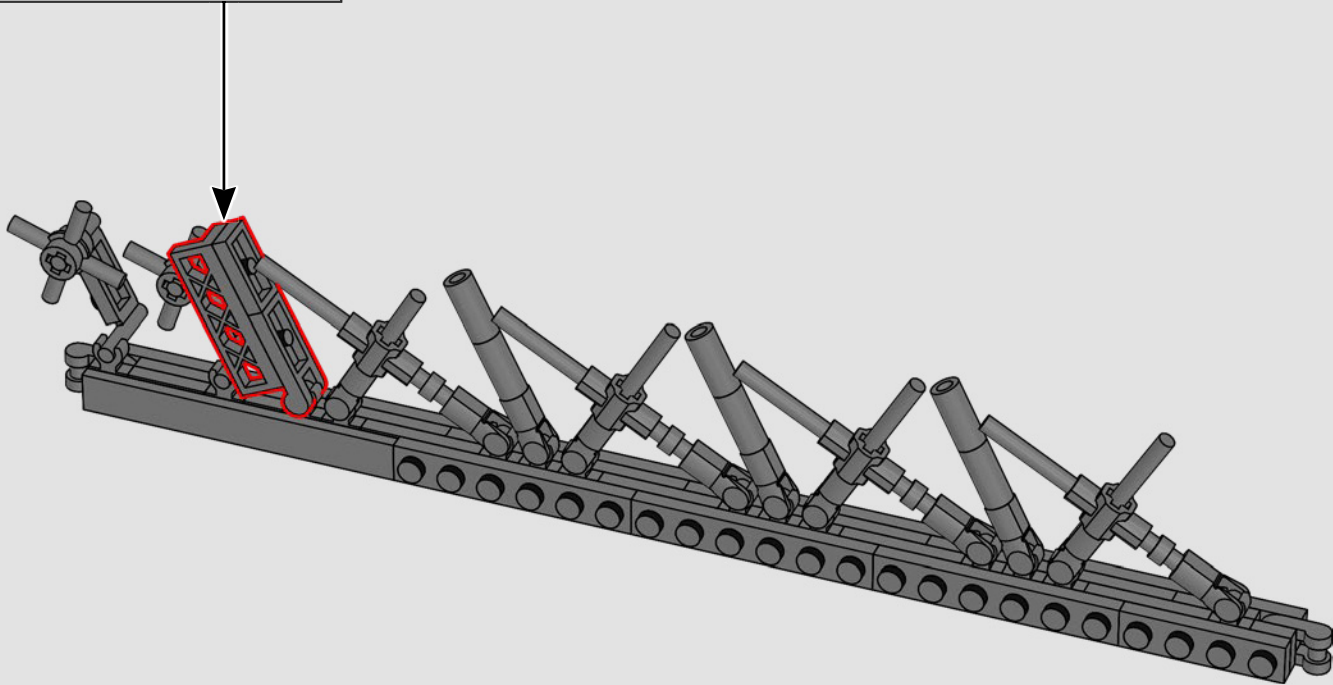
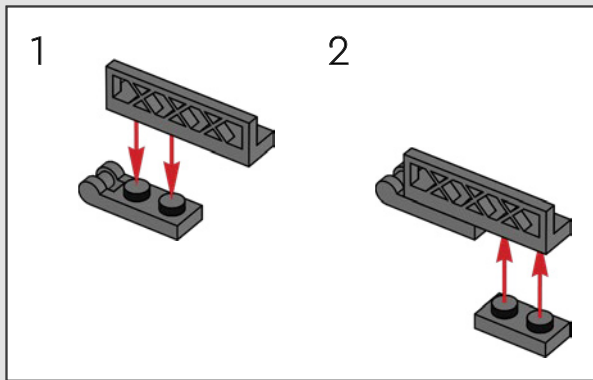

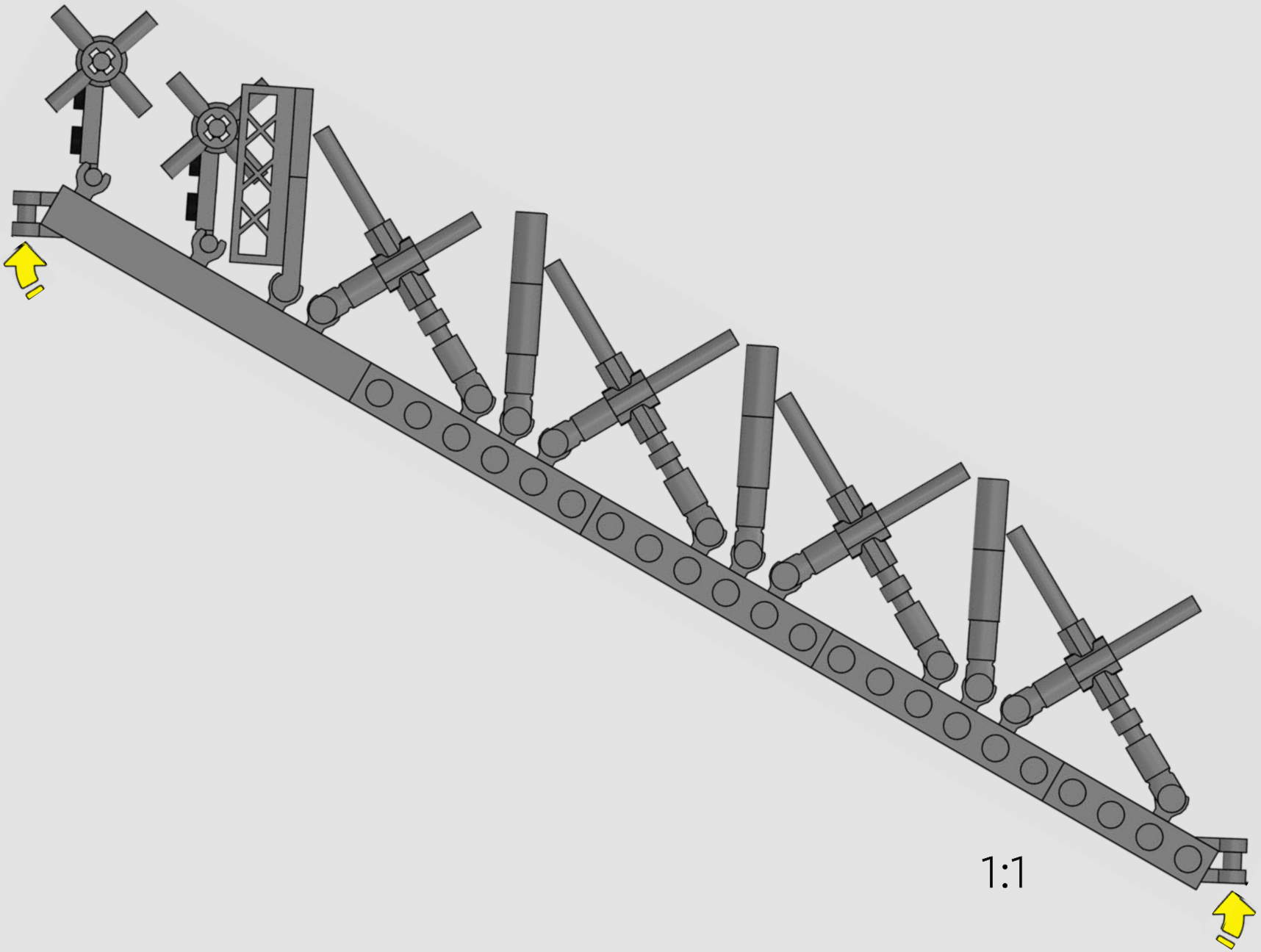

183

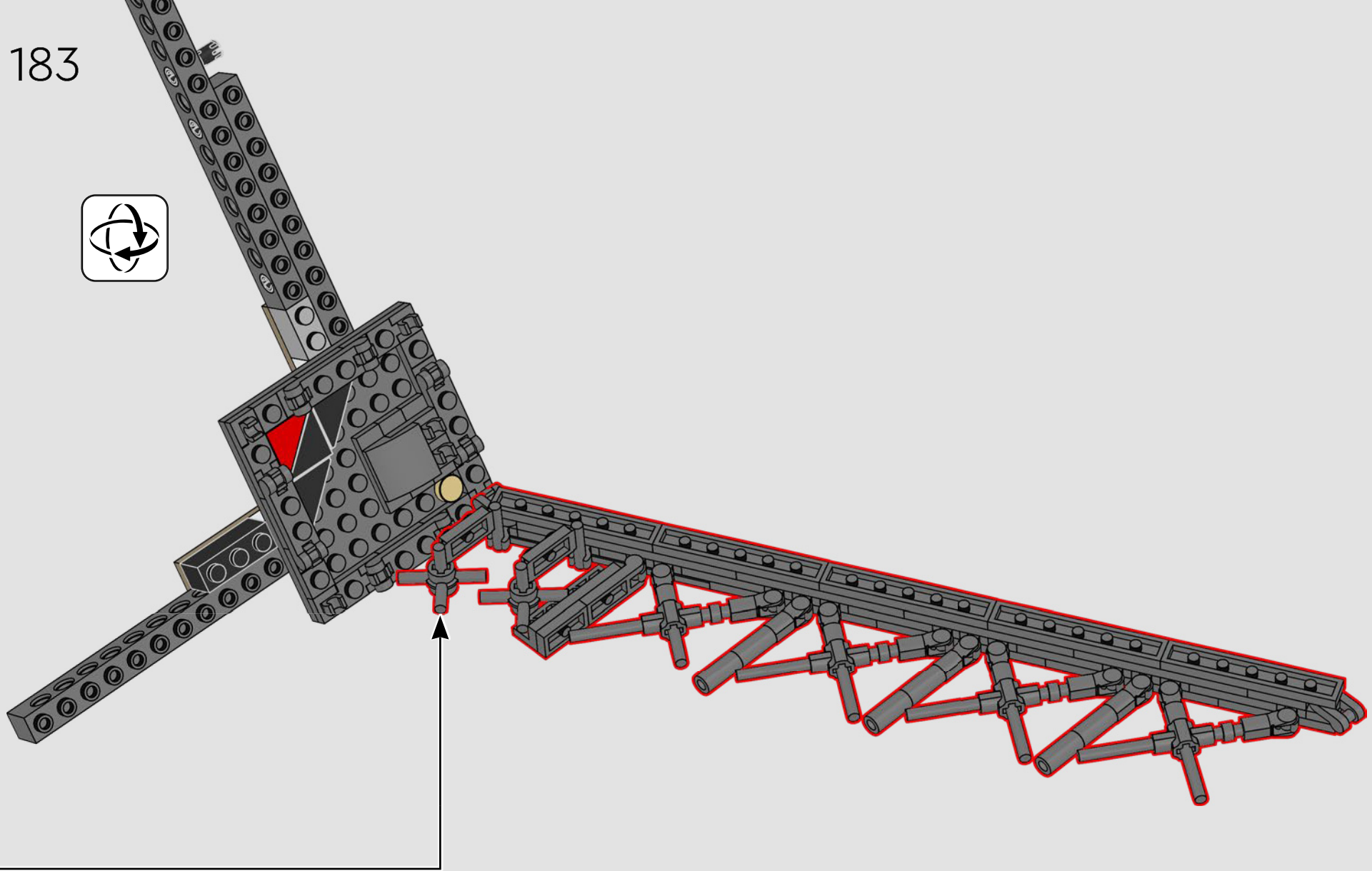

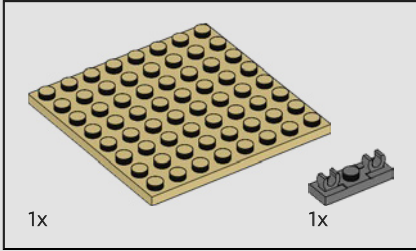
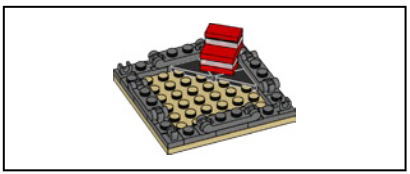

184

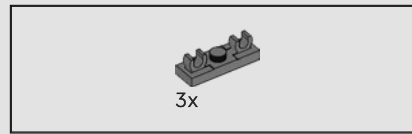
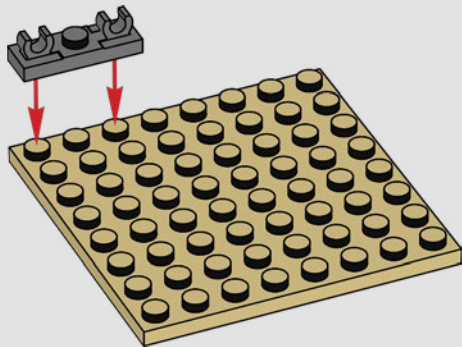

185

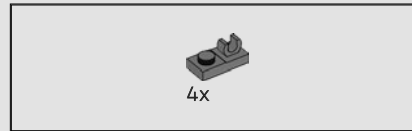
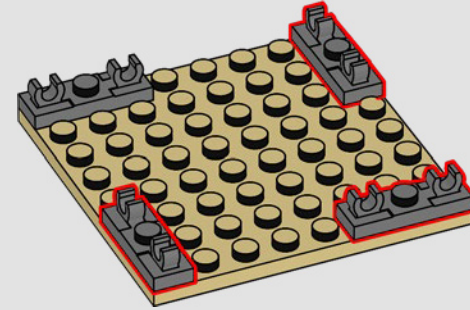

186

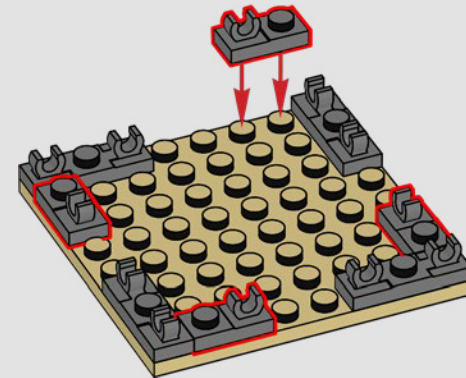

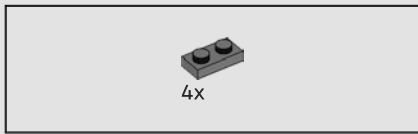

187

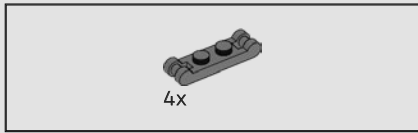
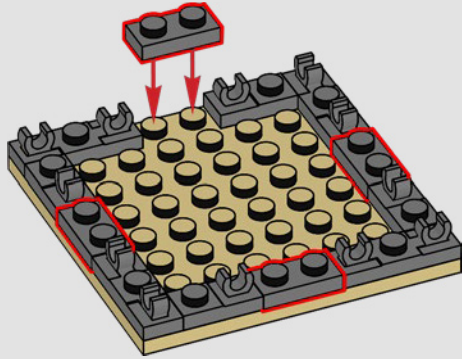

188

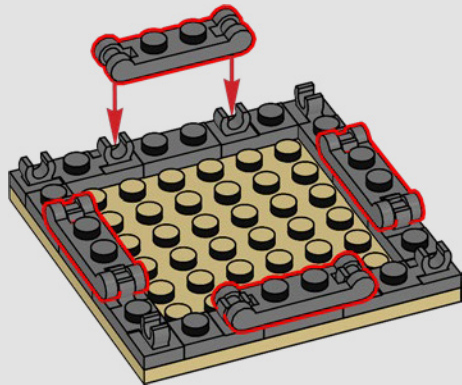

189

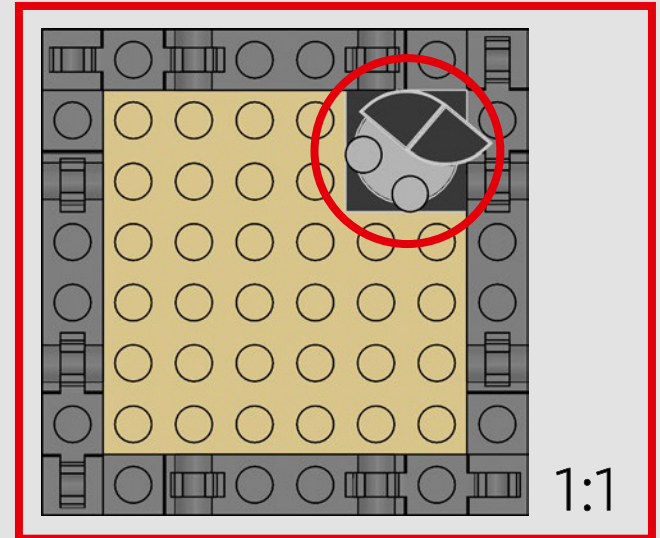
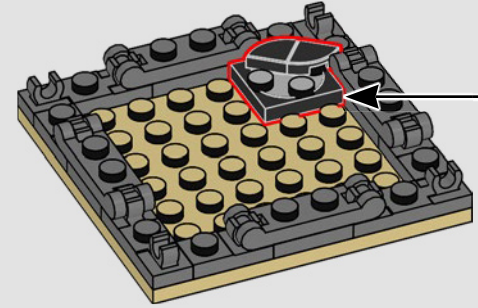
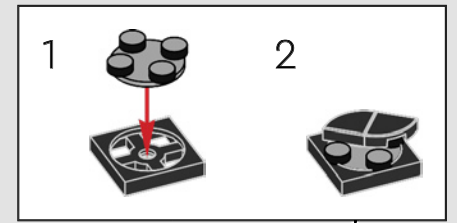



2x

190

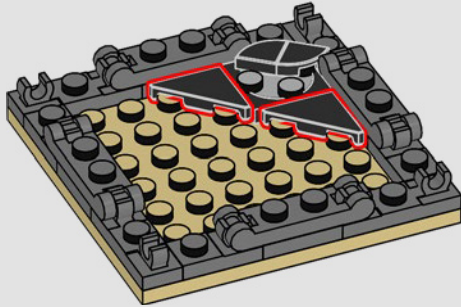

1x



1x

191

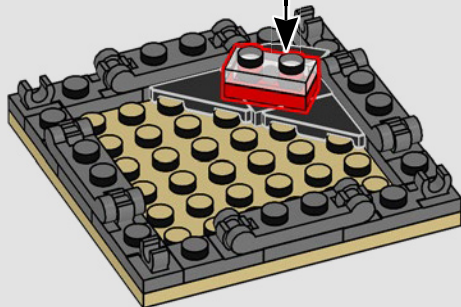
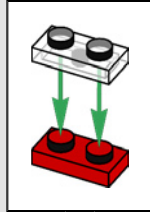

1x



1x



1x

192

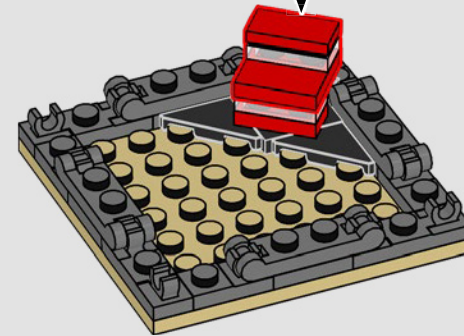
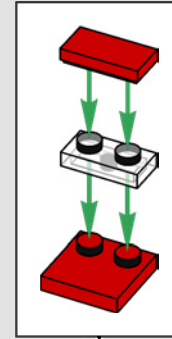

The elevators of the Eiffel tower are greased every day. With beef fat.

Les ascenseurs de la tour Eiffel sont graissés tous les jours. Avec de la graisse de bœuf.

Los elevadores de la Torre Eiffel se engrasan todos los días. Con sebo de res.

193

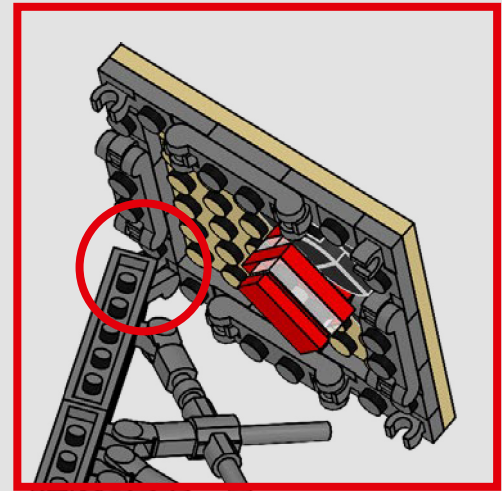
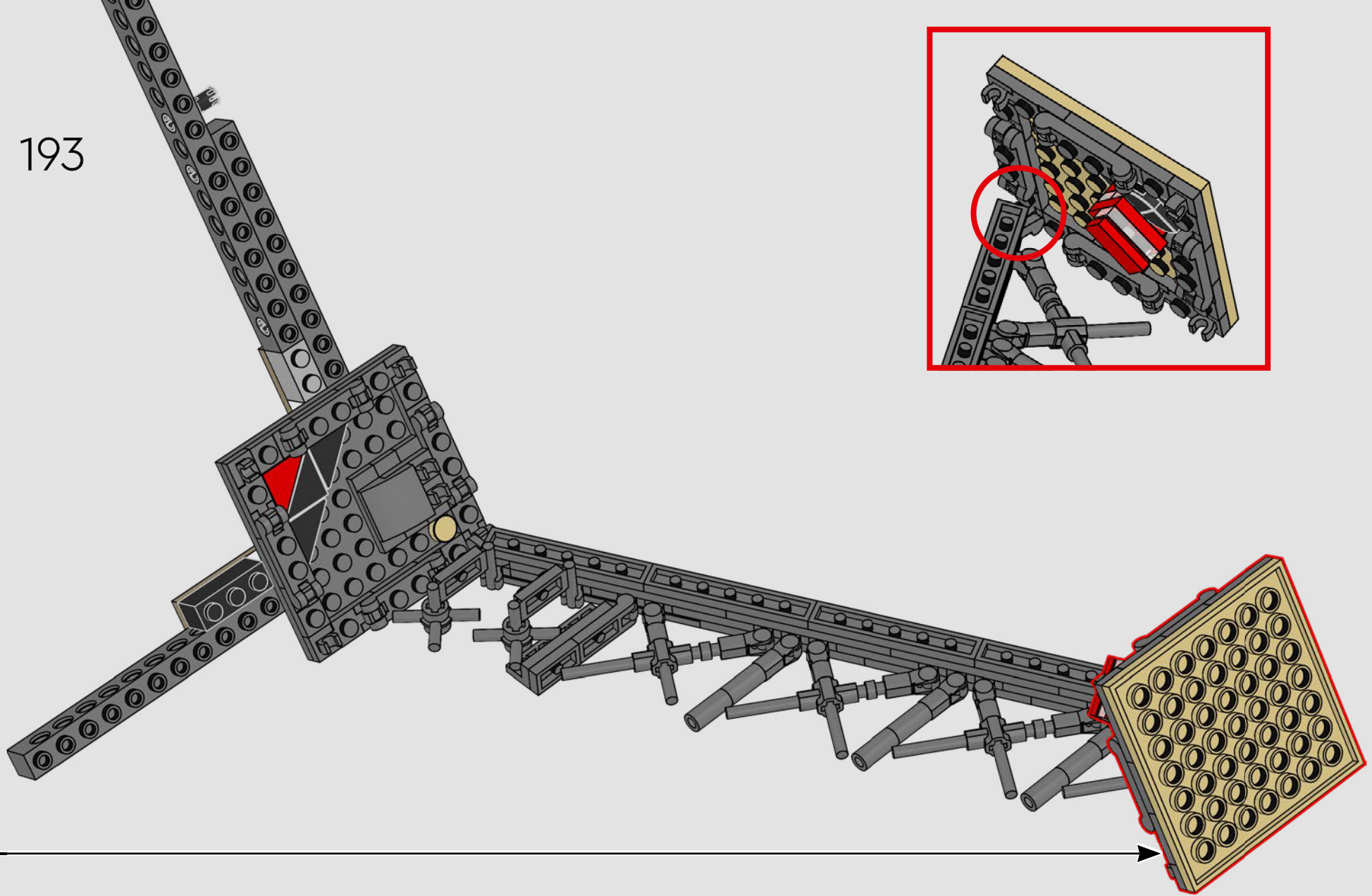

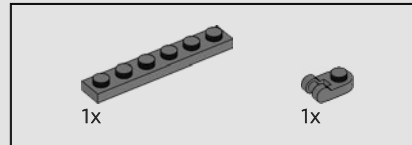
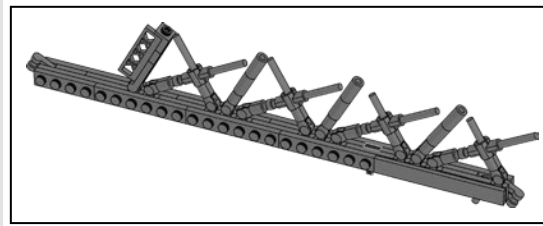

194

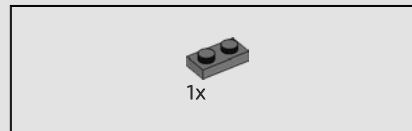
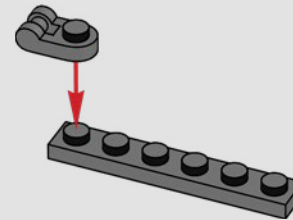

195

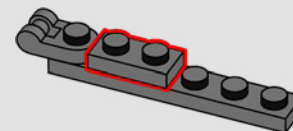

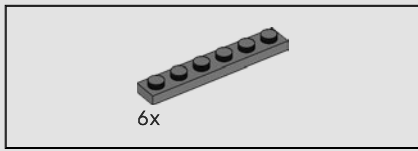

196

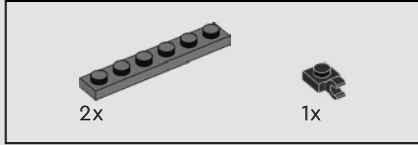
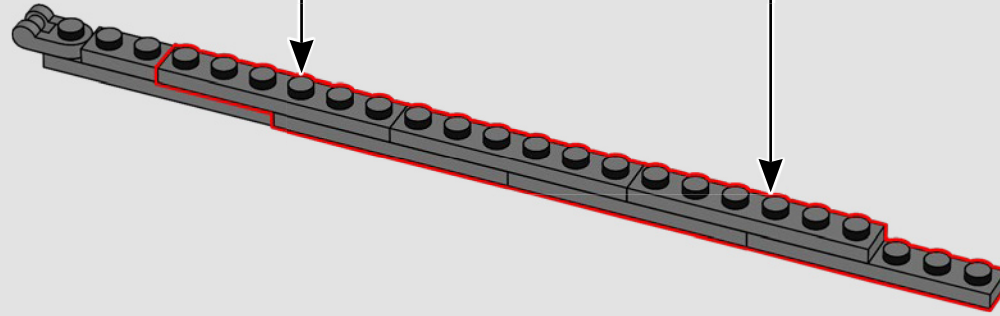
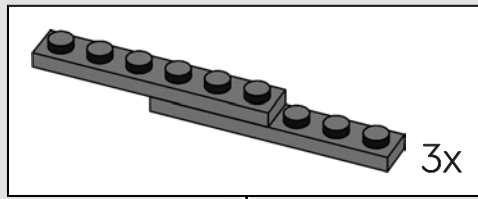

197

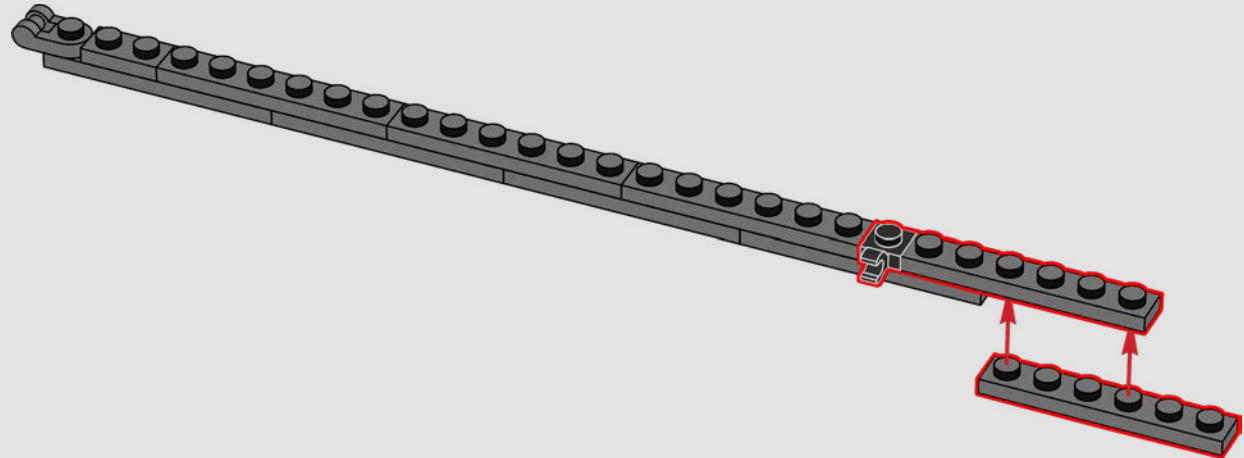

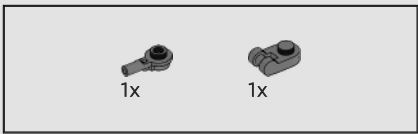

198

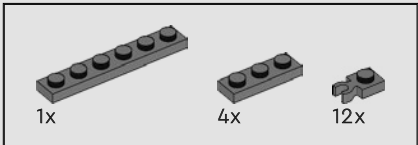
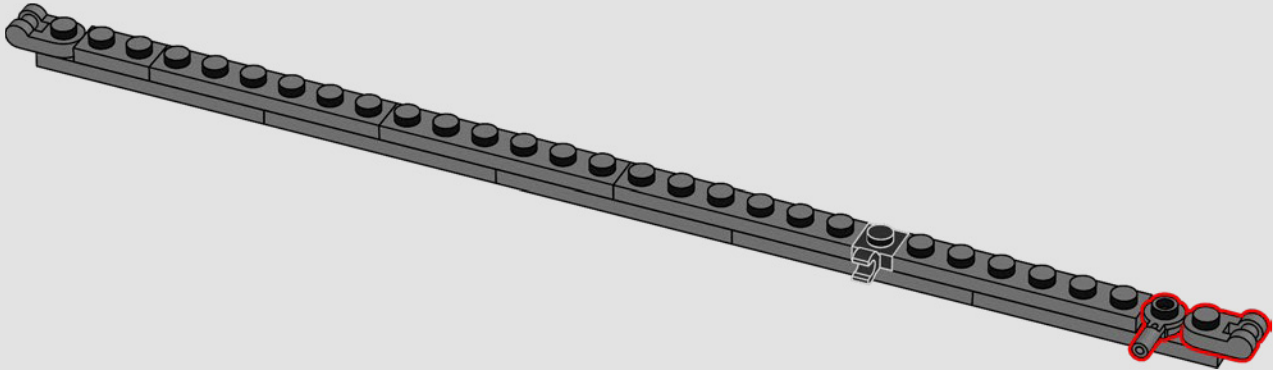

199

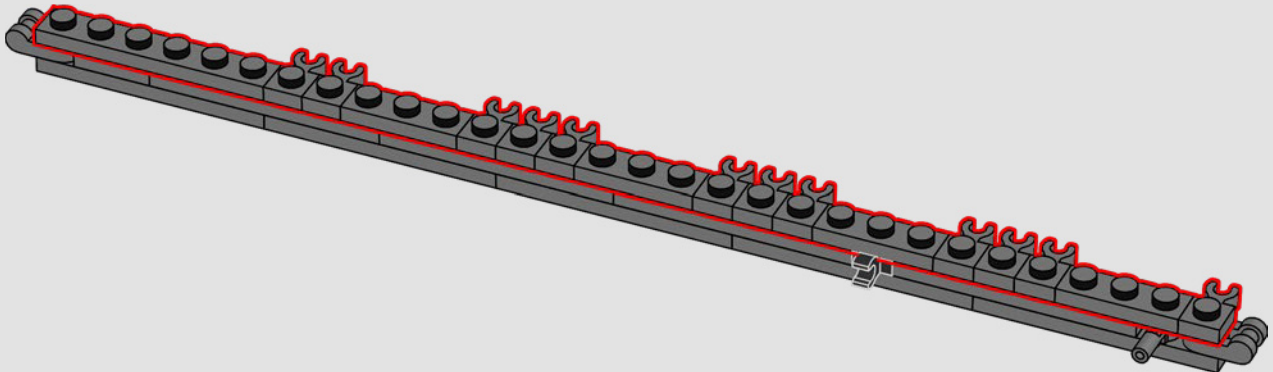

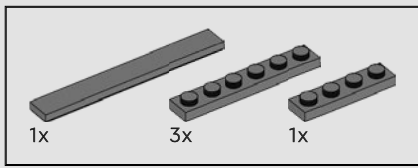

200

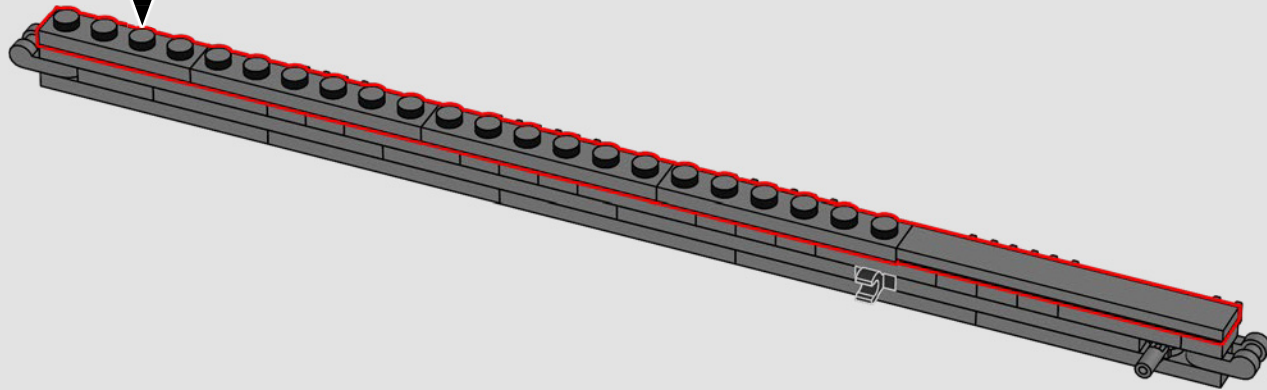
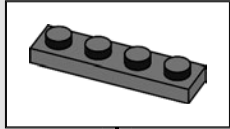

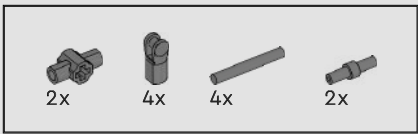

201

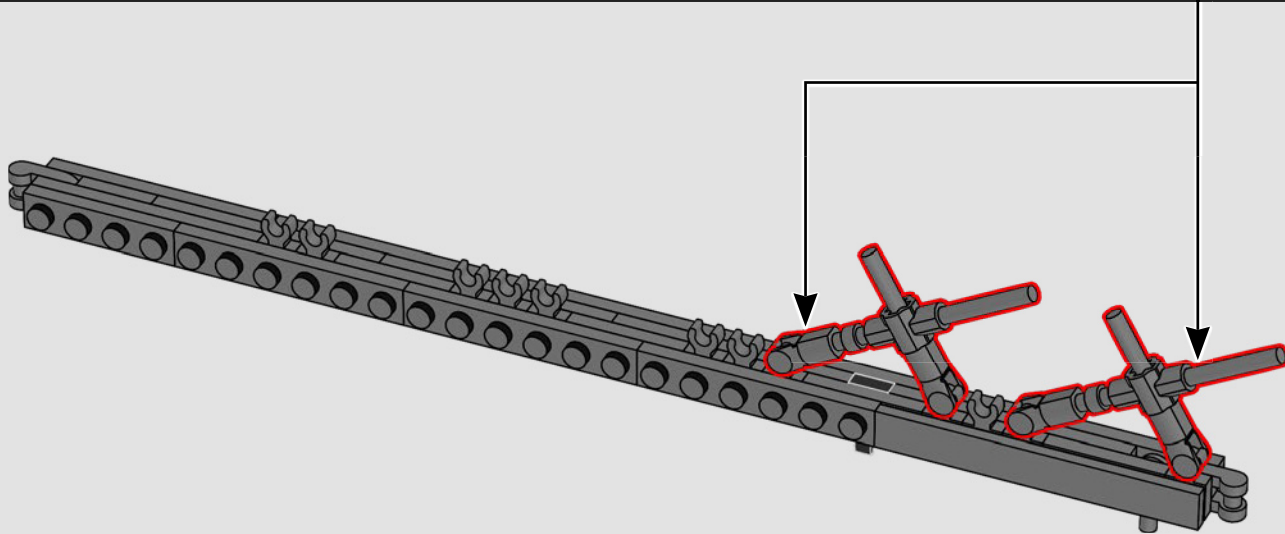
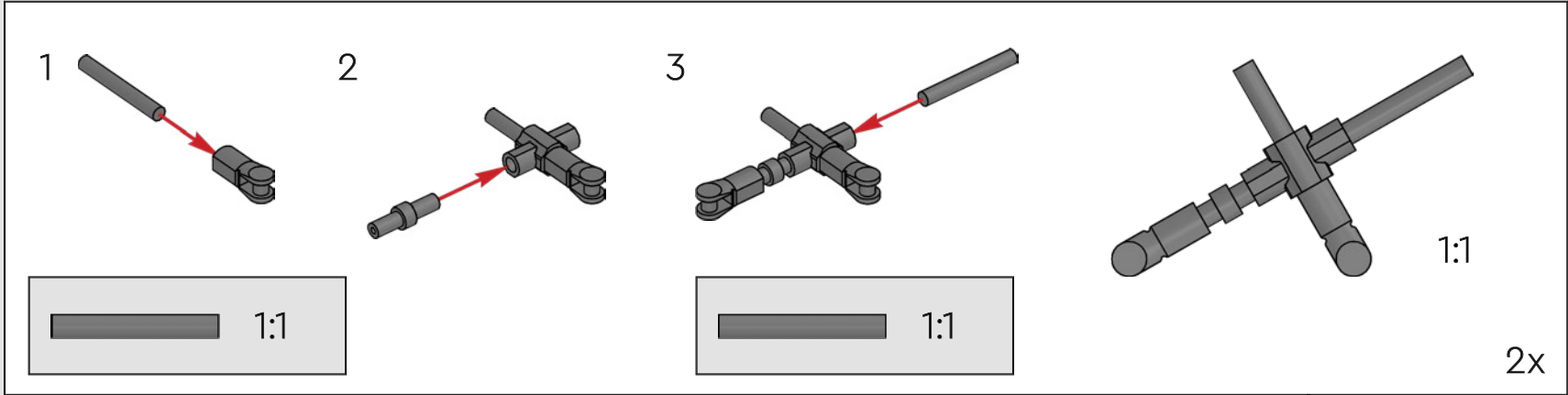

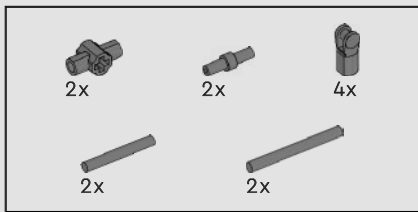

202

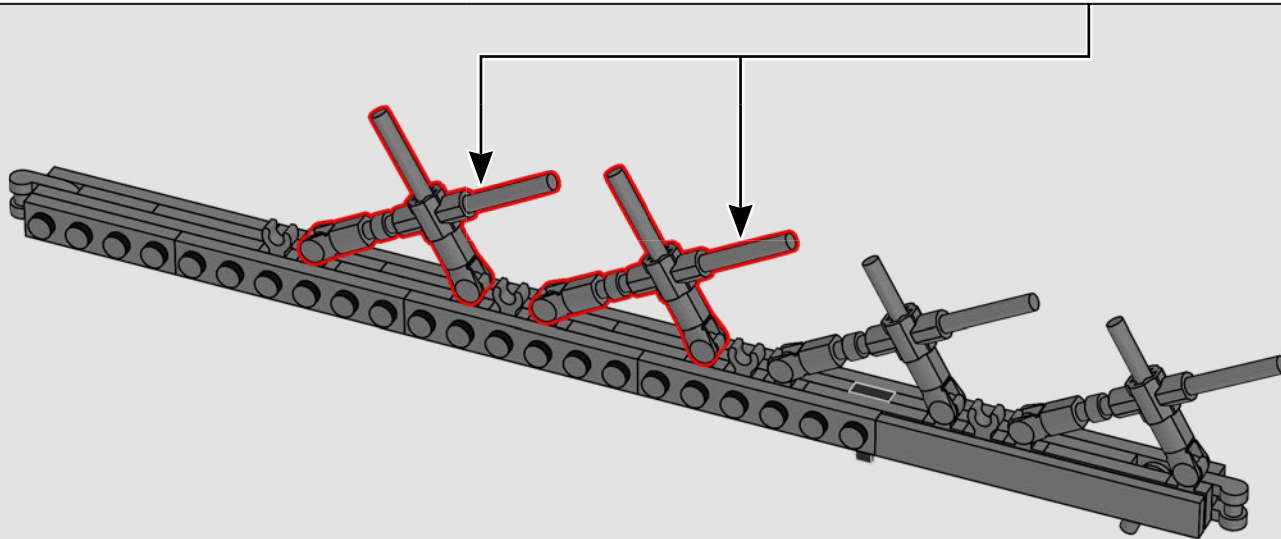
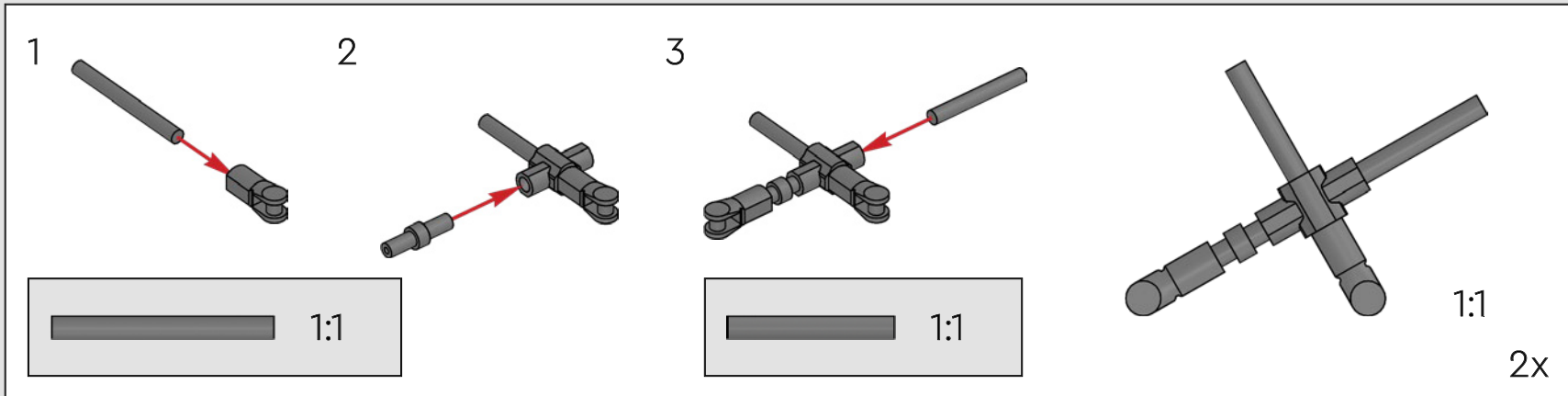

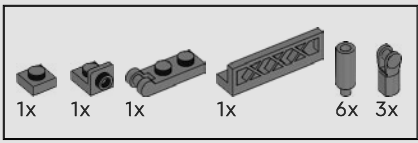

203

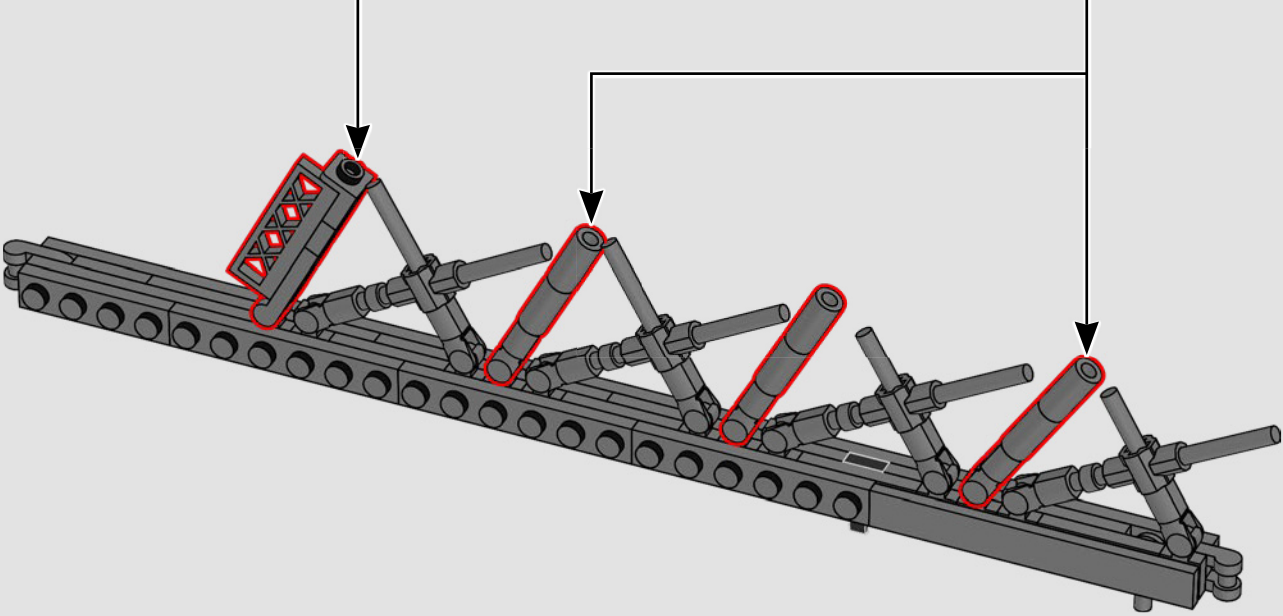
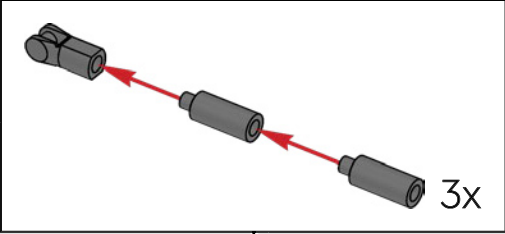
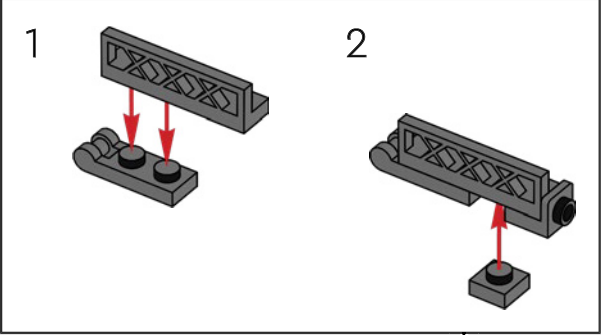

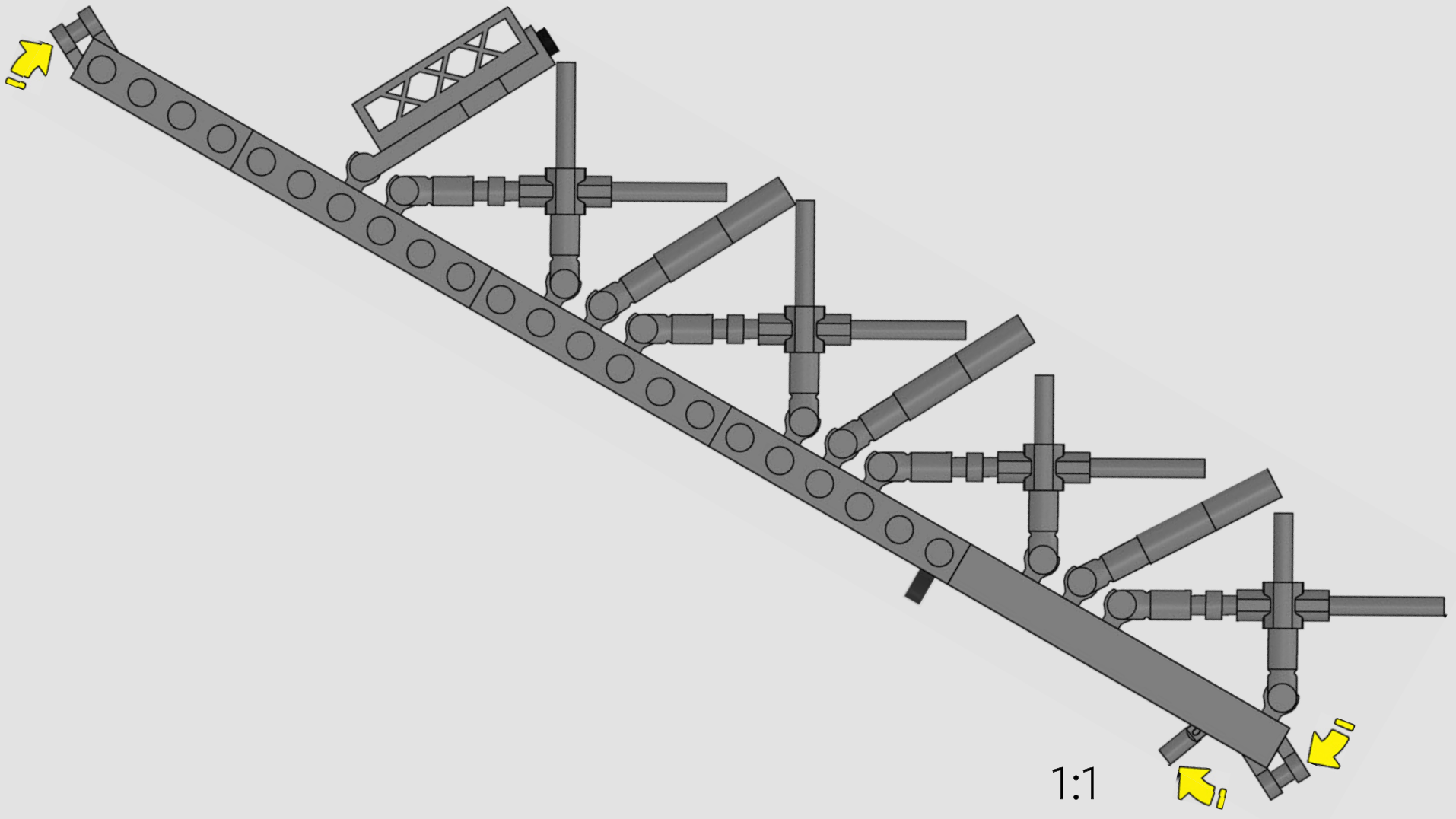

204

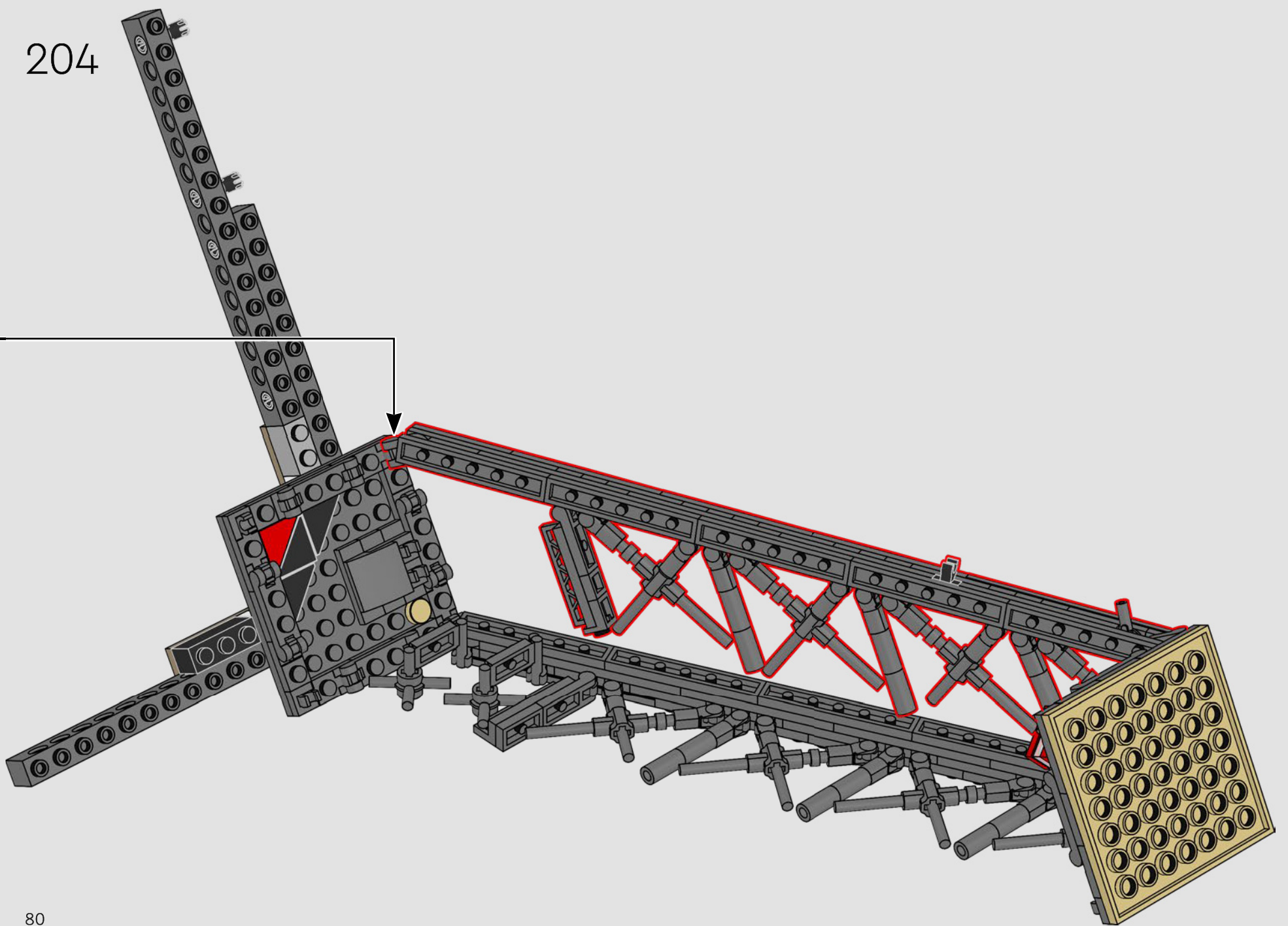

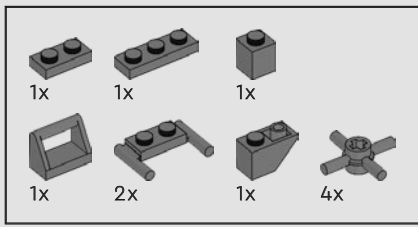

205

1

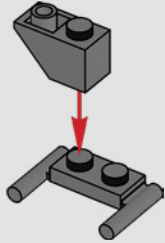

2

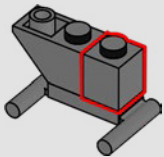

3

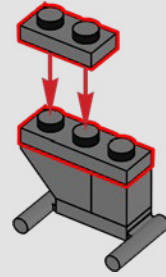

4

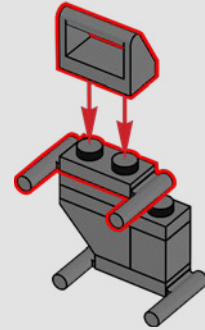

5

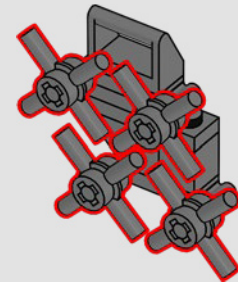

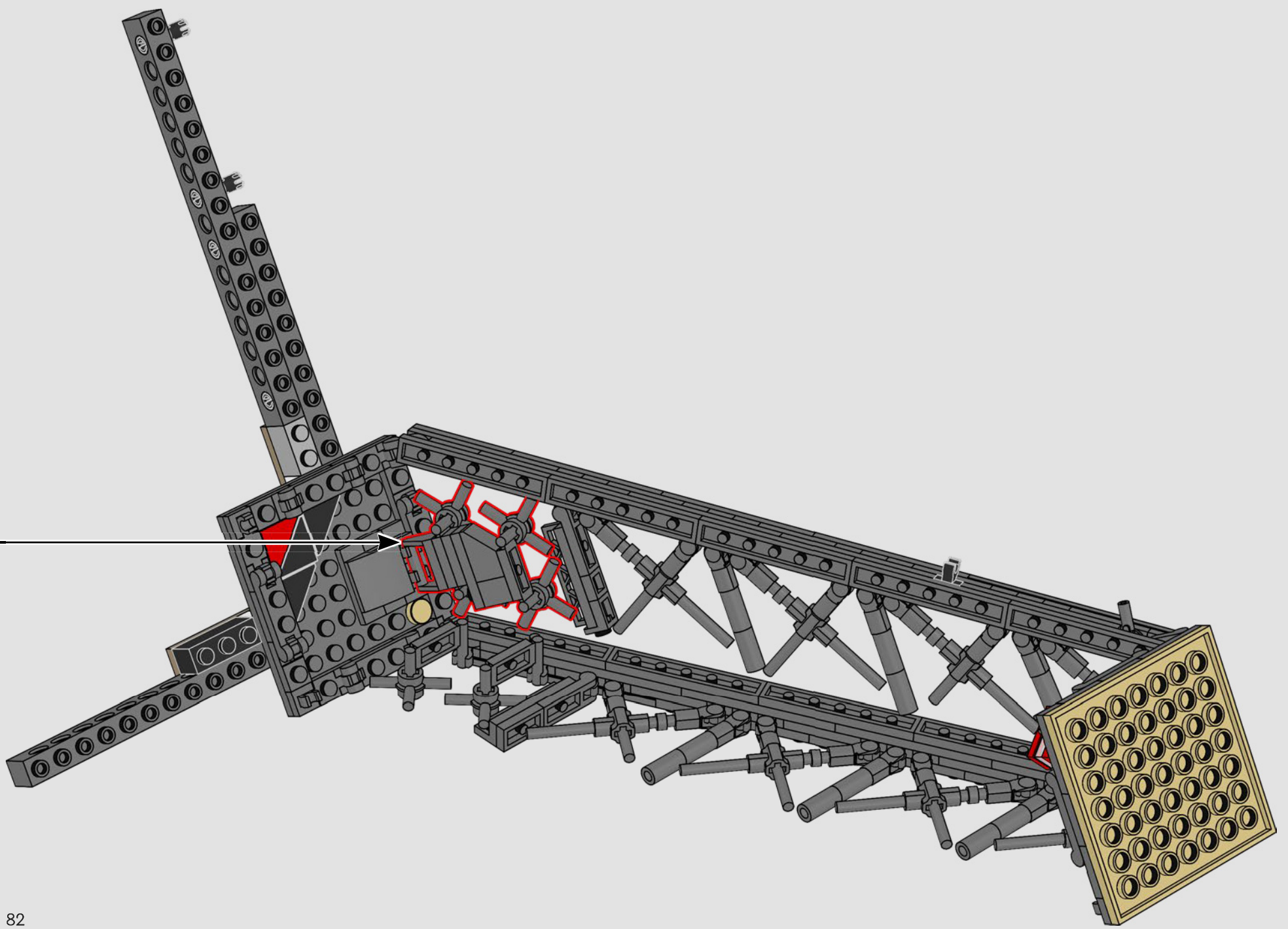

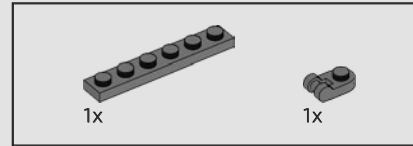
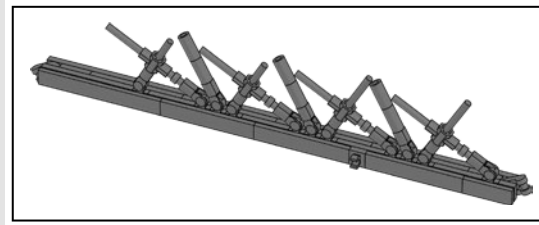

206

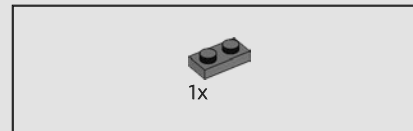
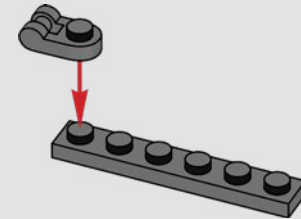

207

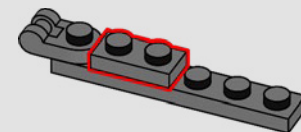

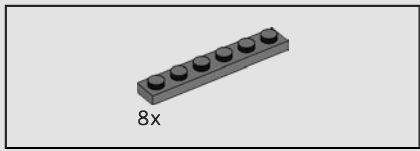

208

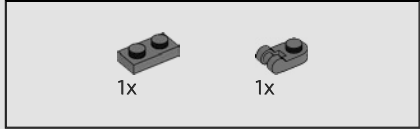
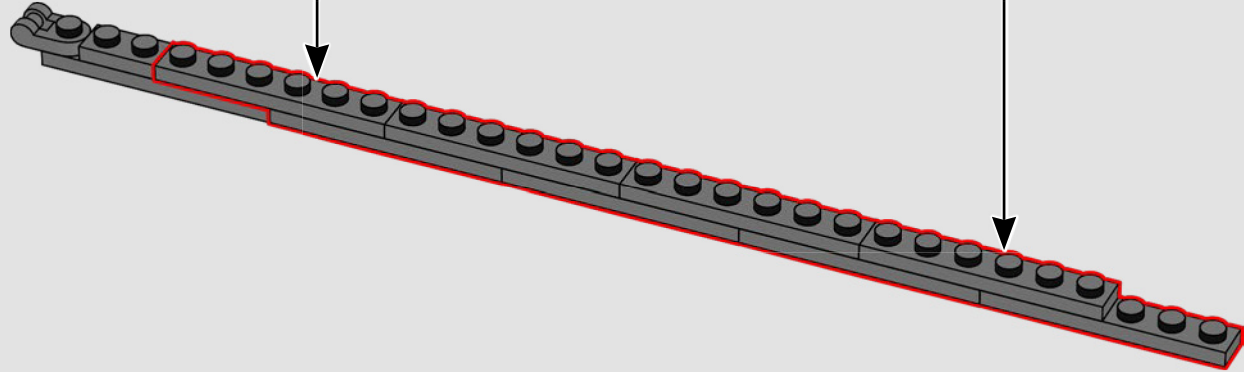
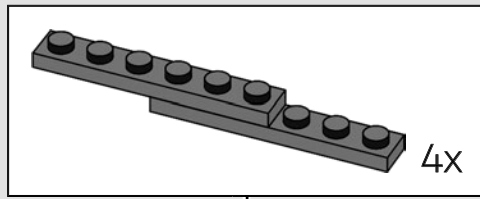

209

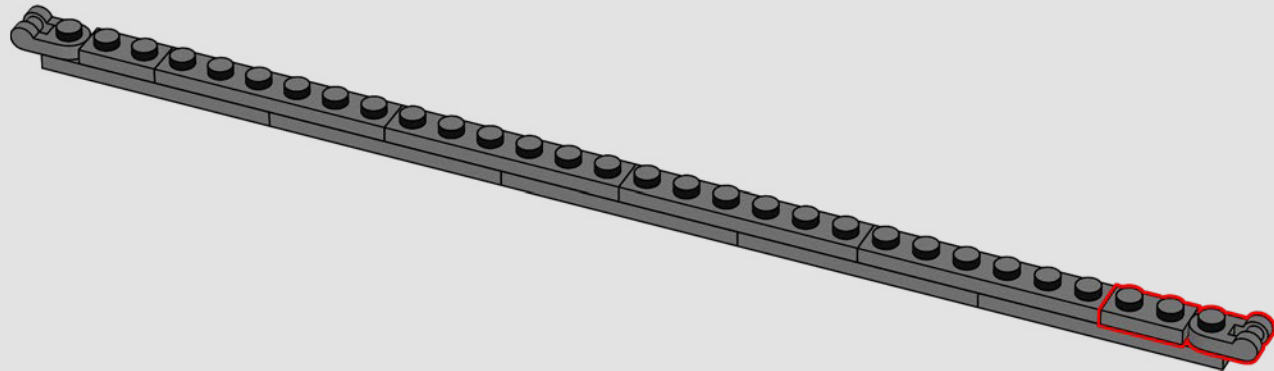

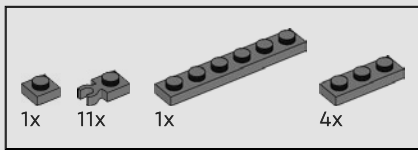

210

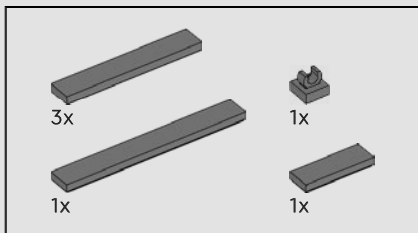
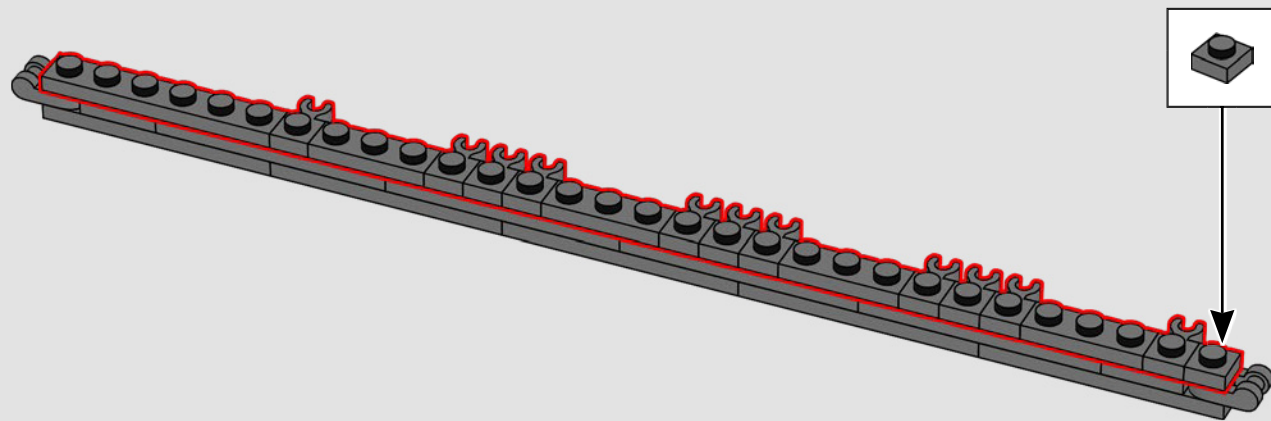

211

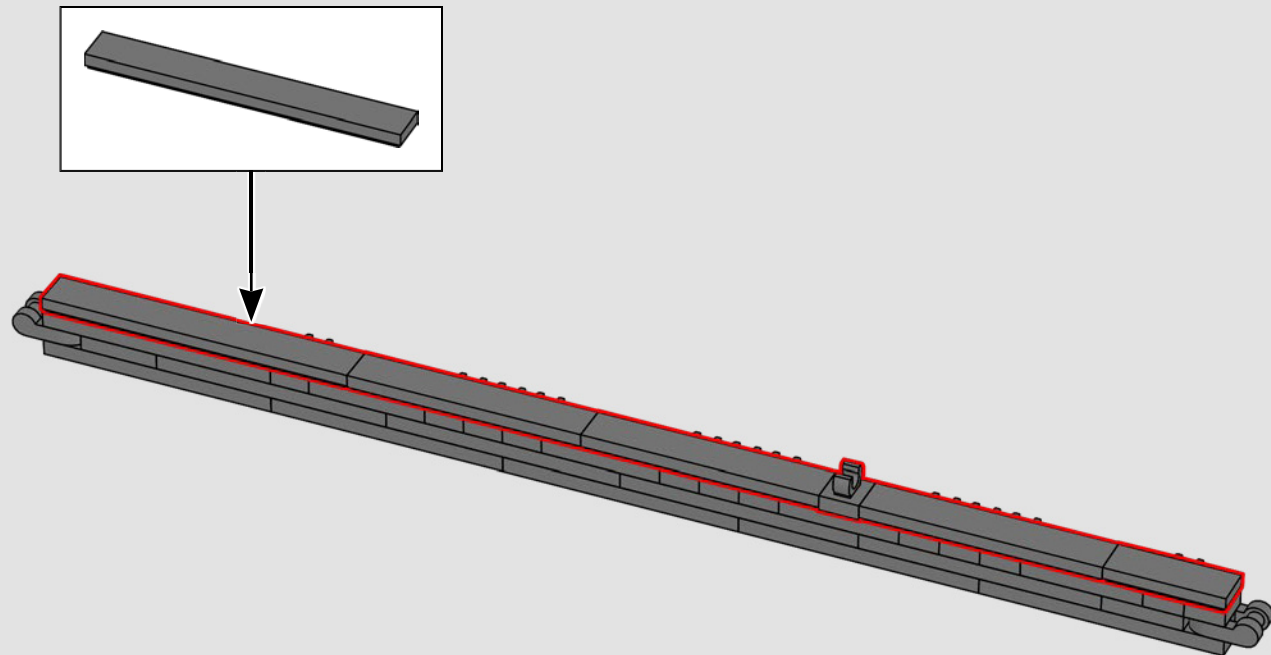

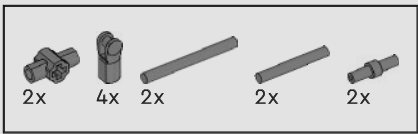

212

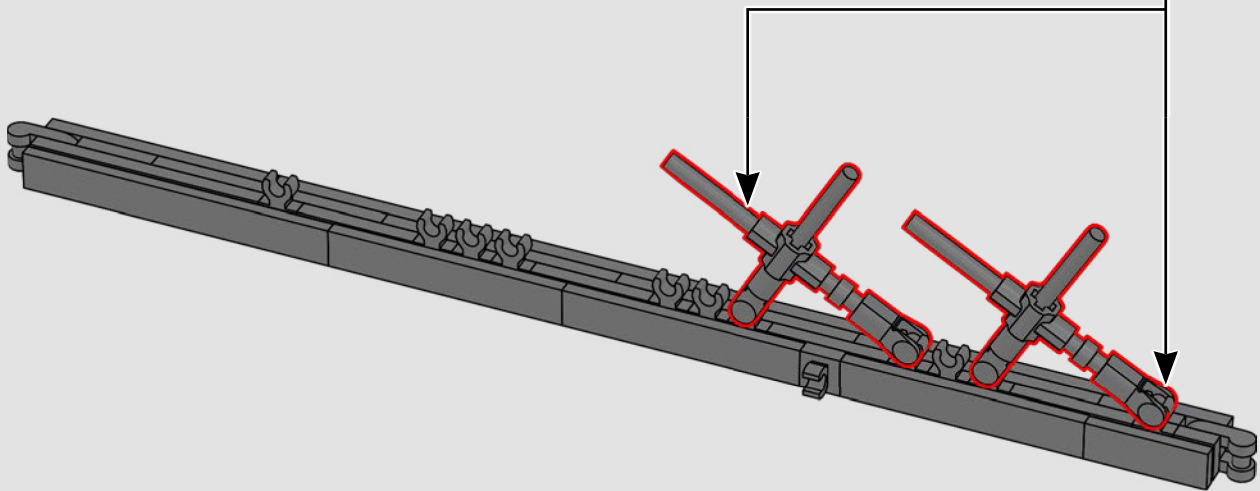
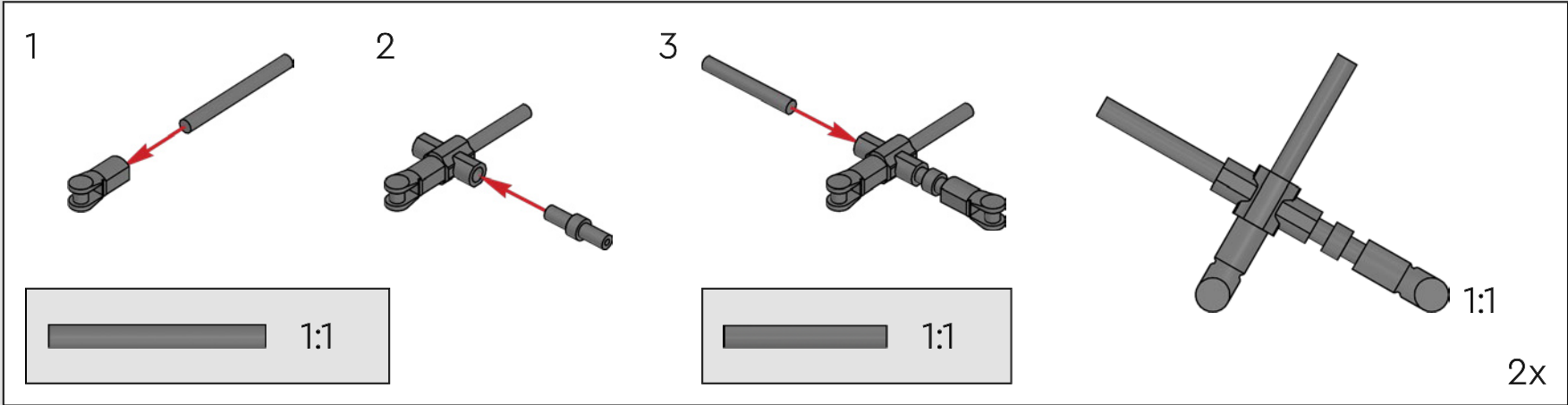

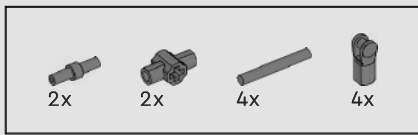

213

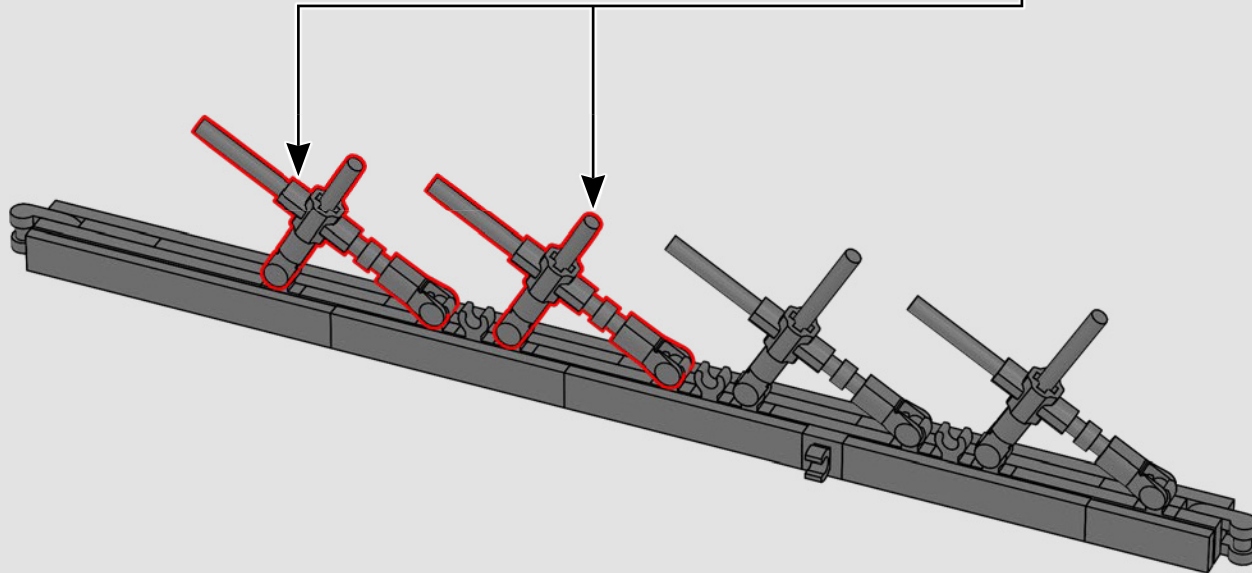
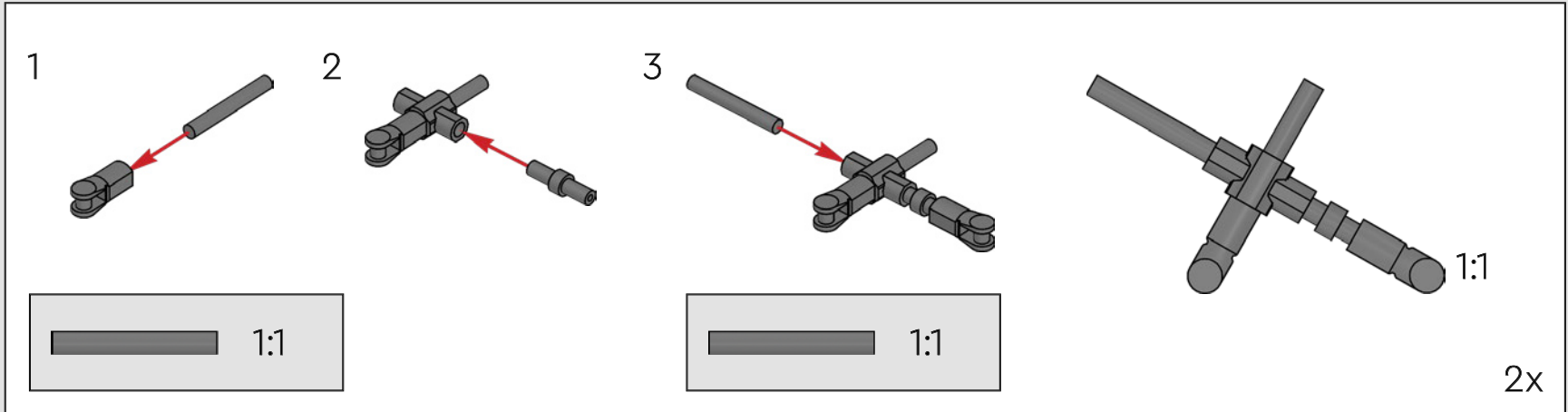



214

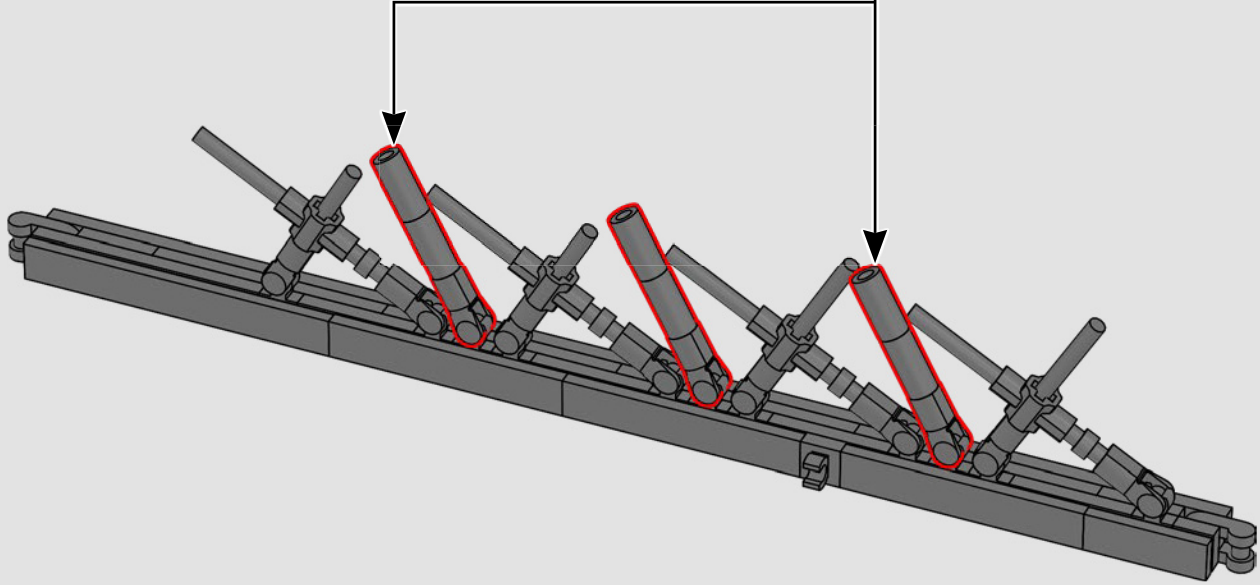
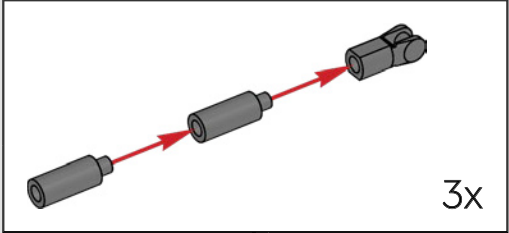

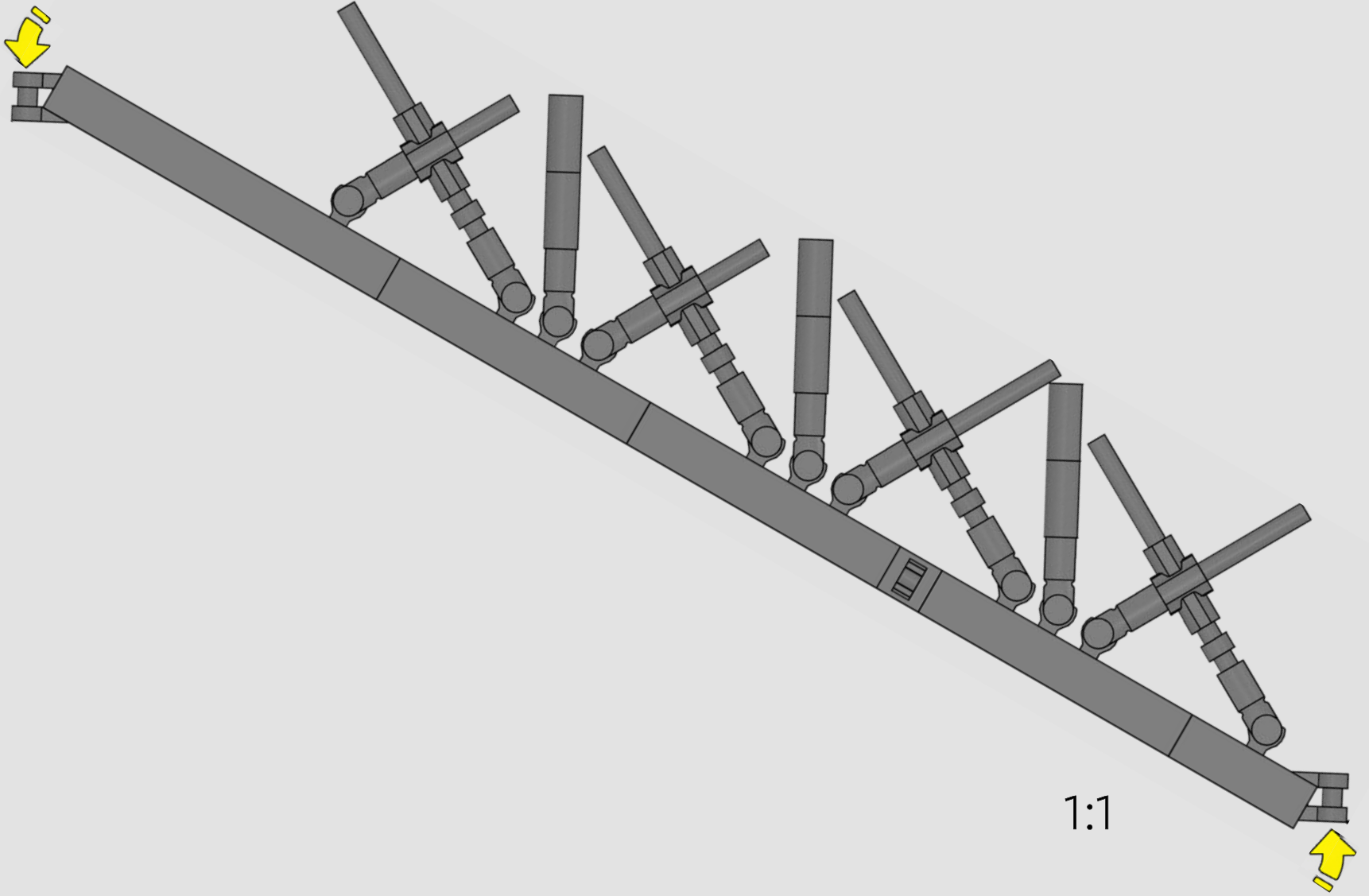

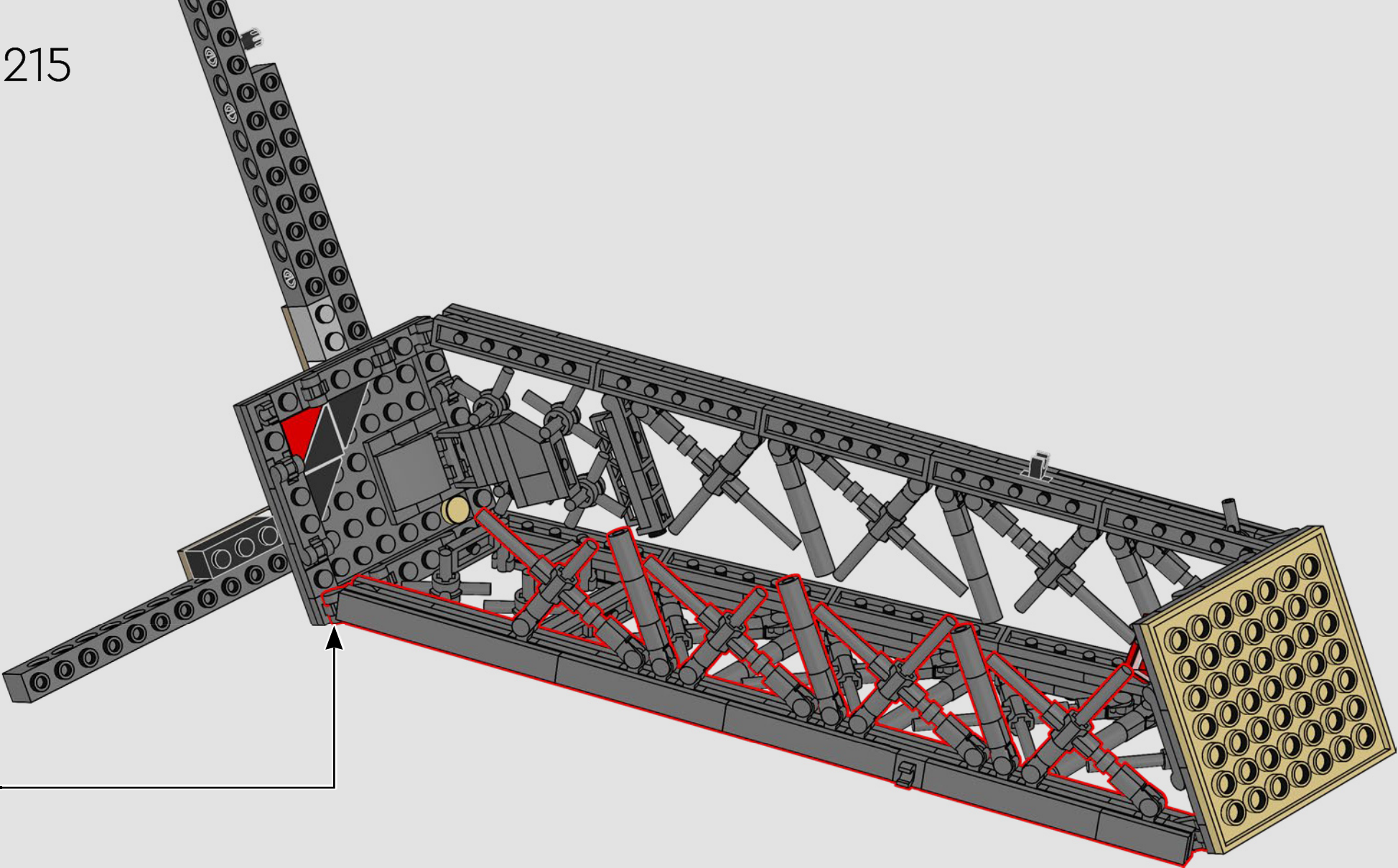

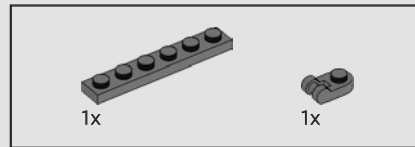
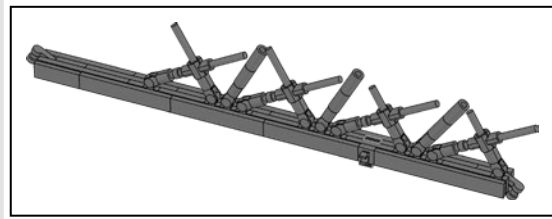

216

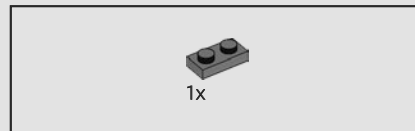
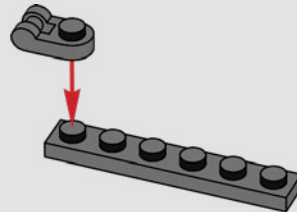

217

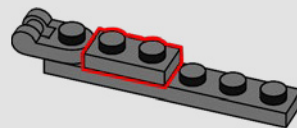

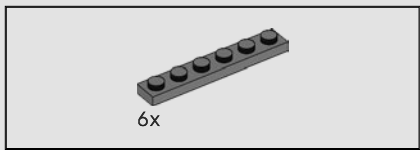

218

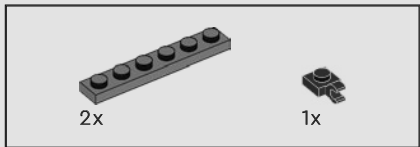
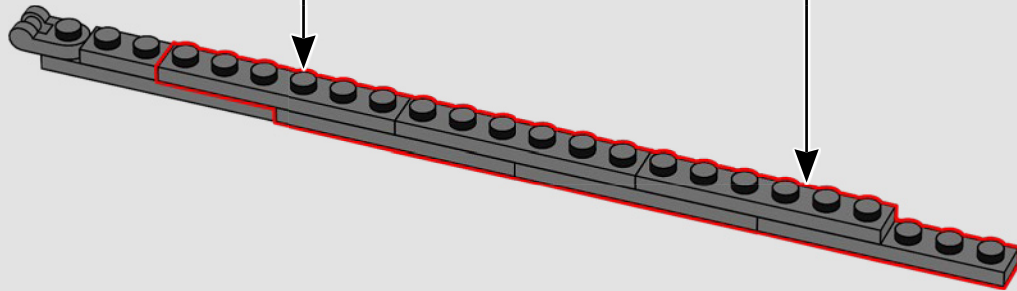
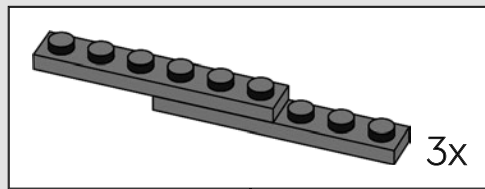

219

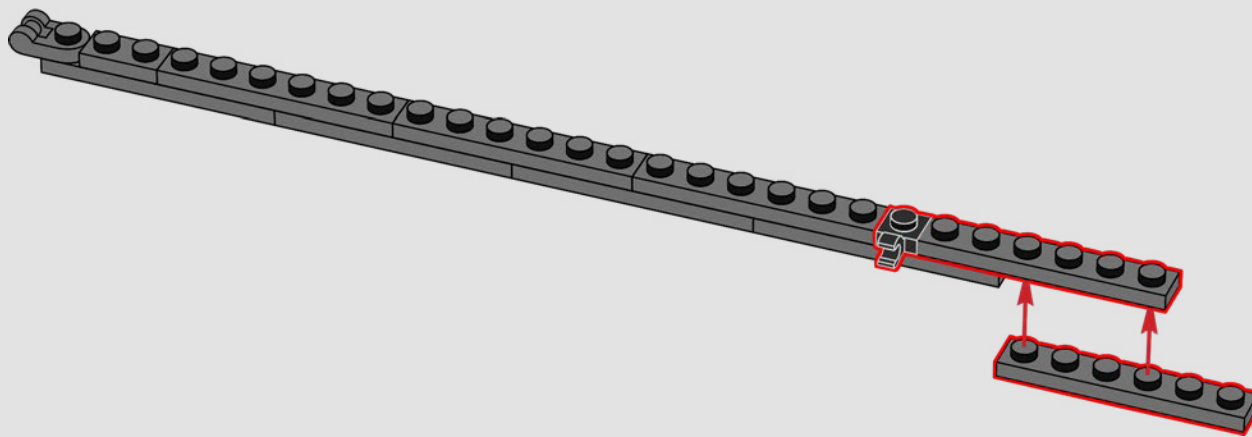

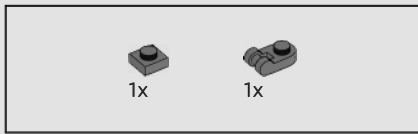

220

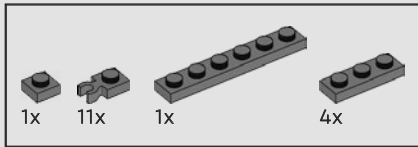
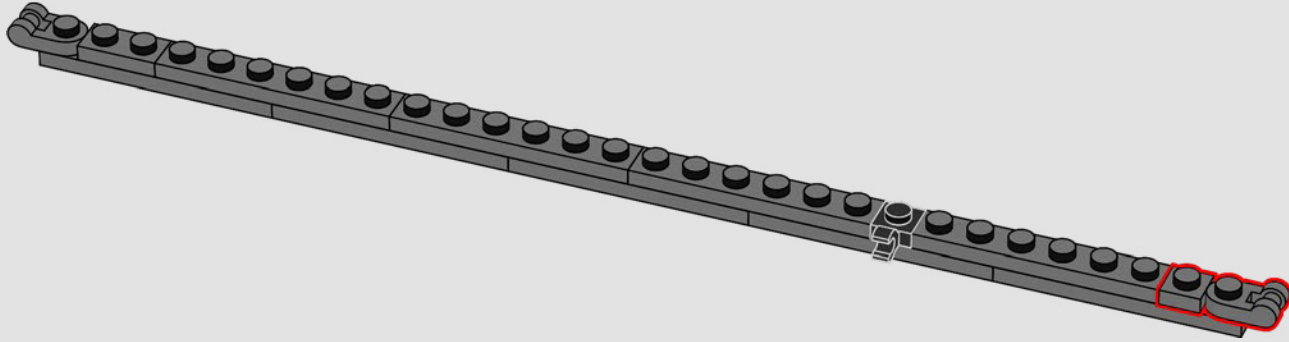

221

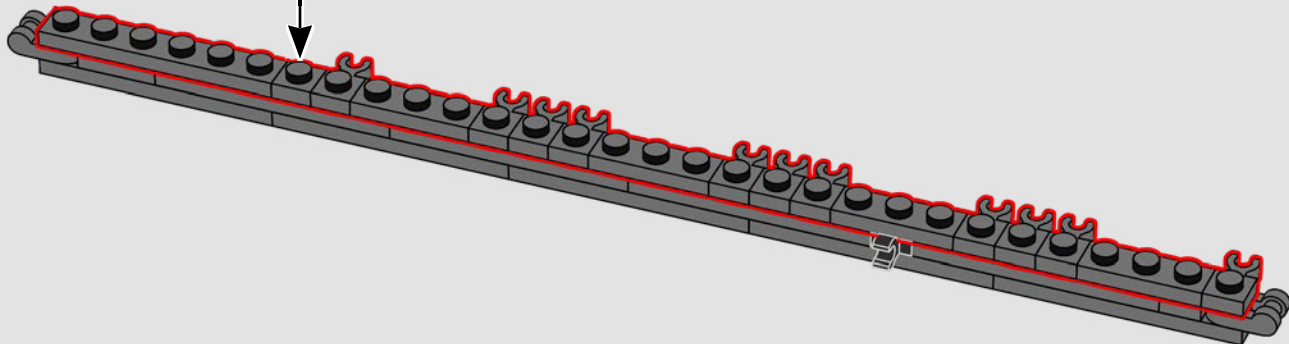
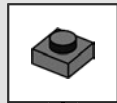

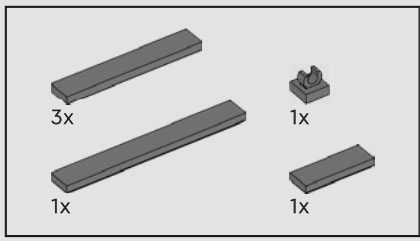

222

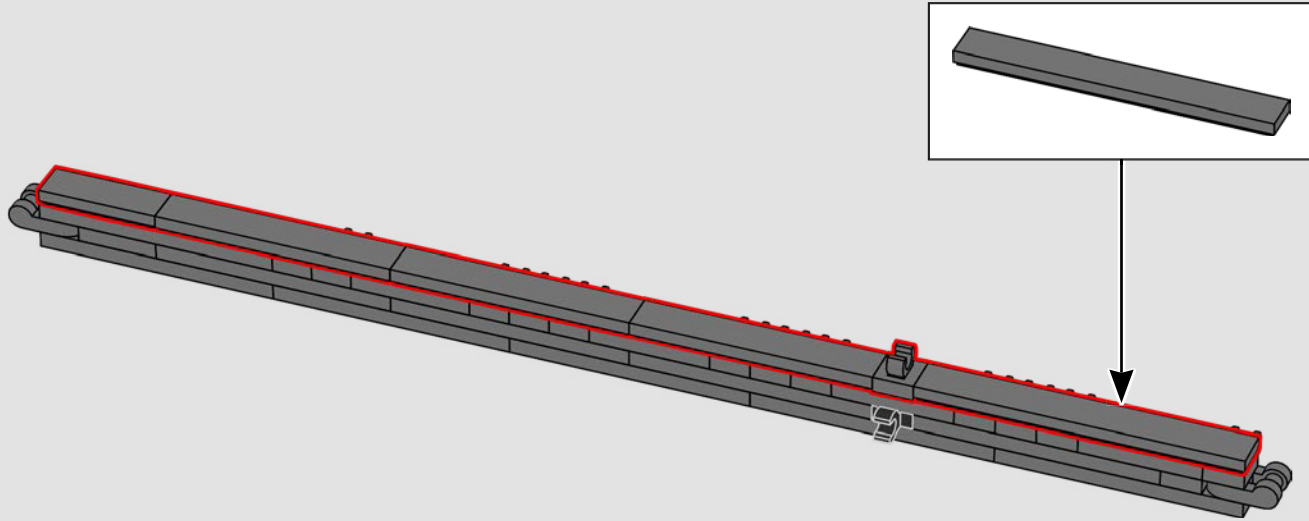

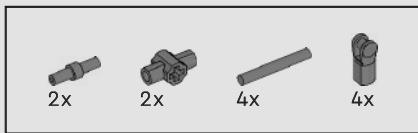

223

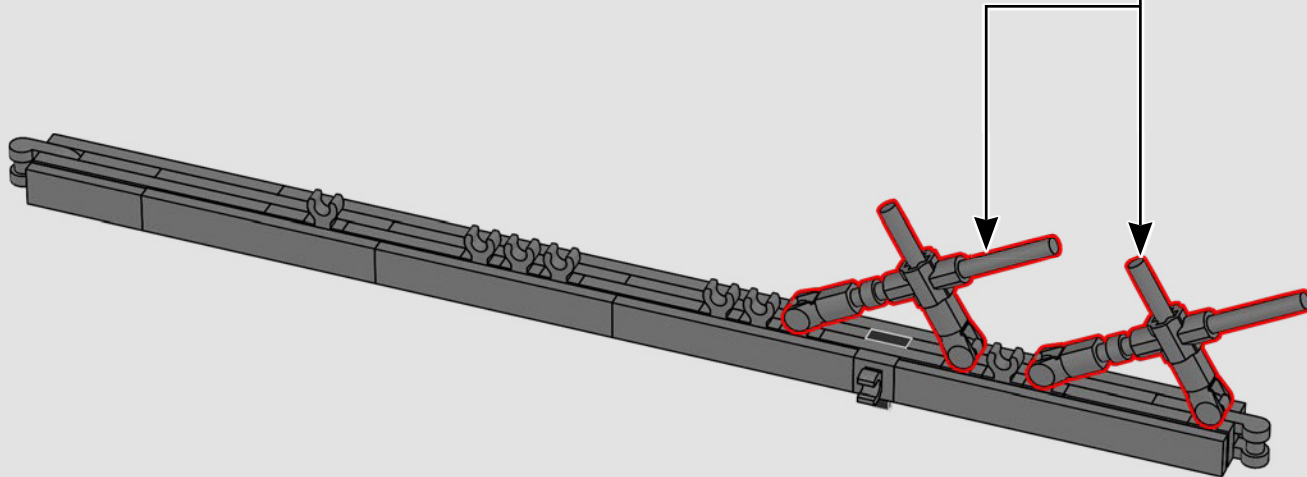
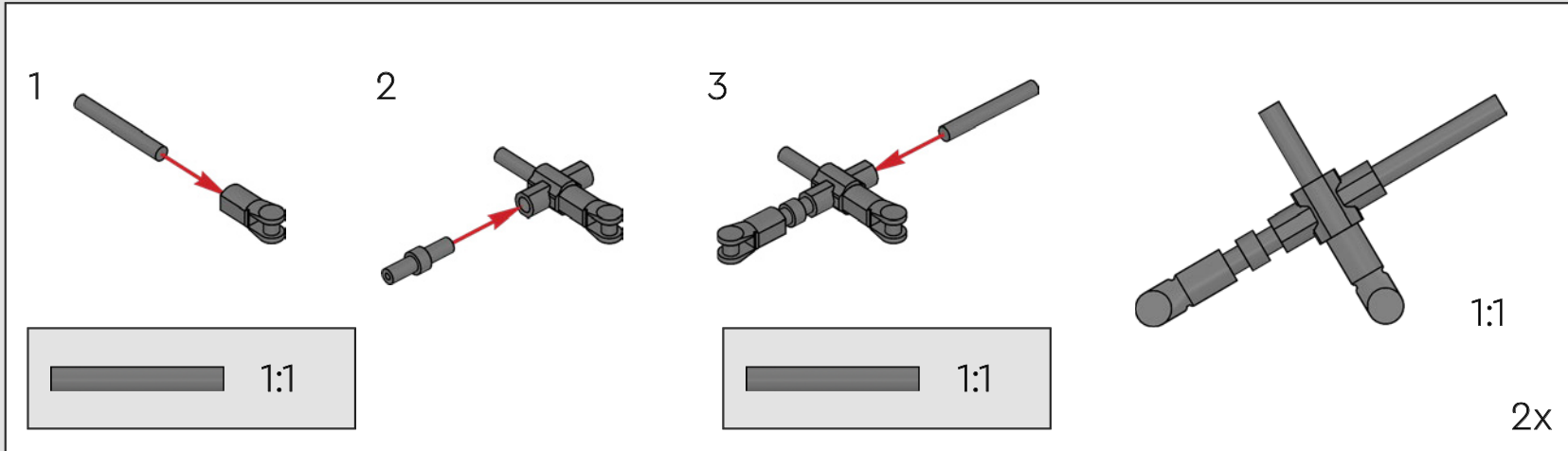

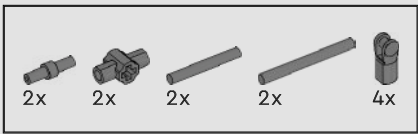

224

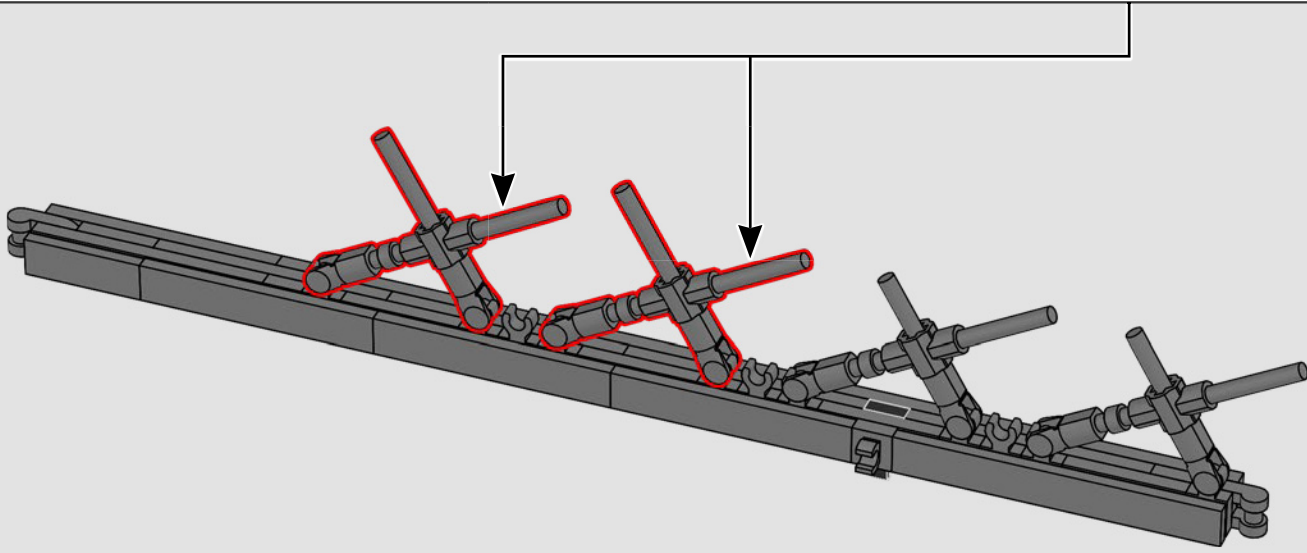
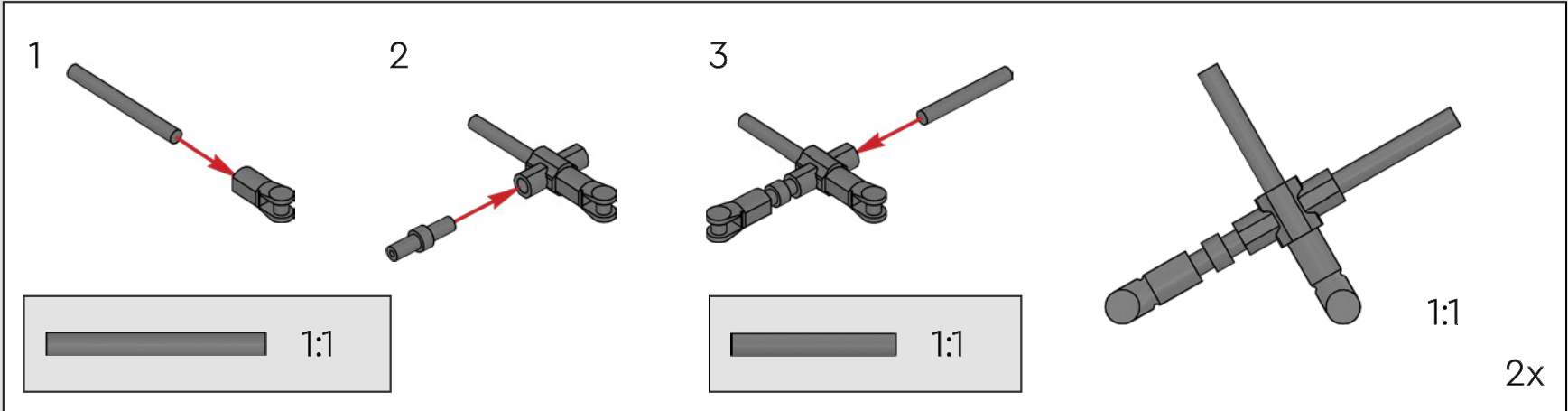

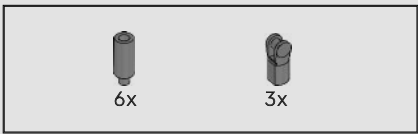

225

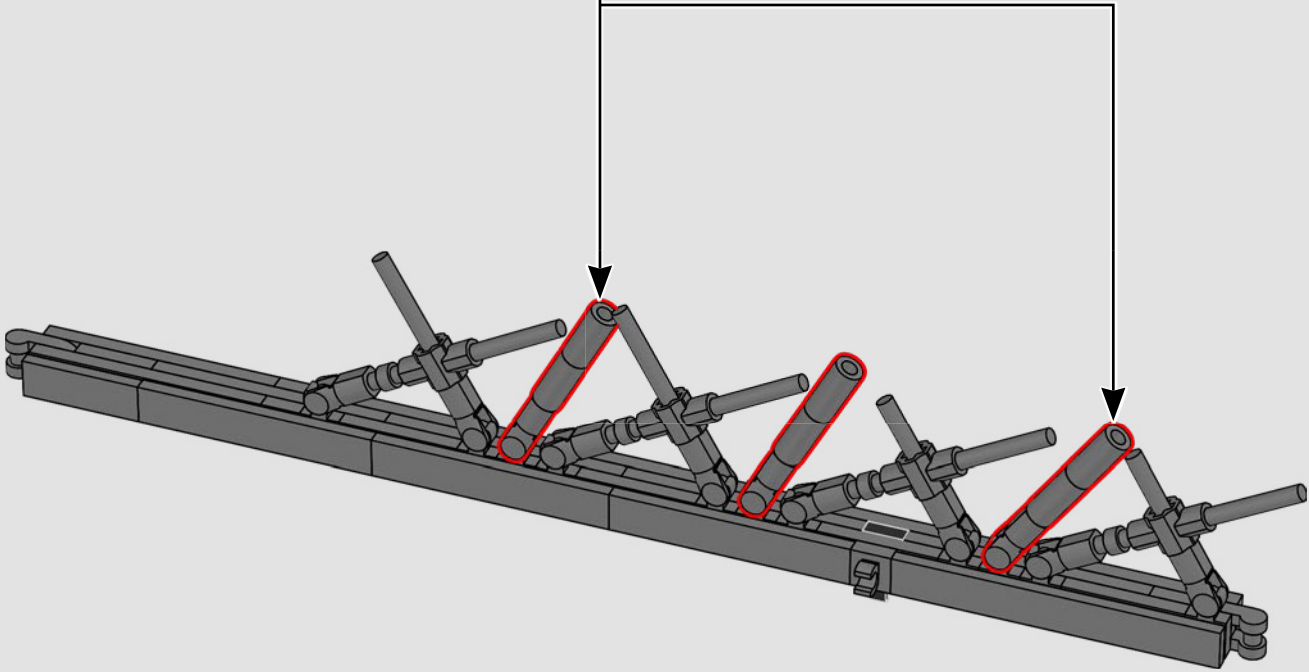
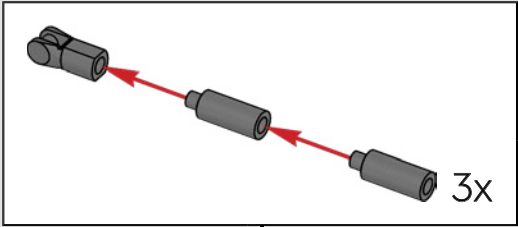

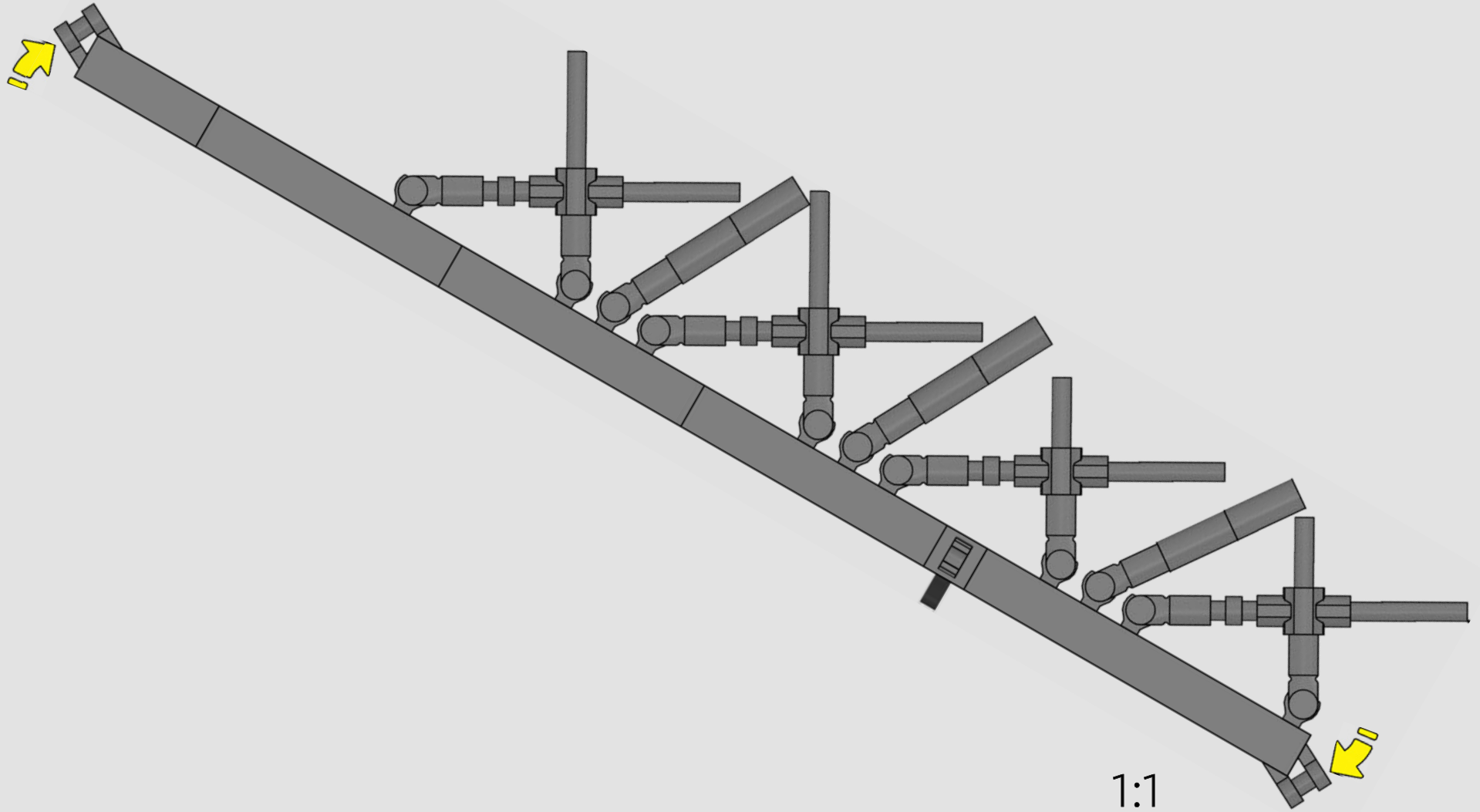

1:1

226

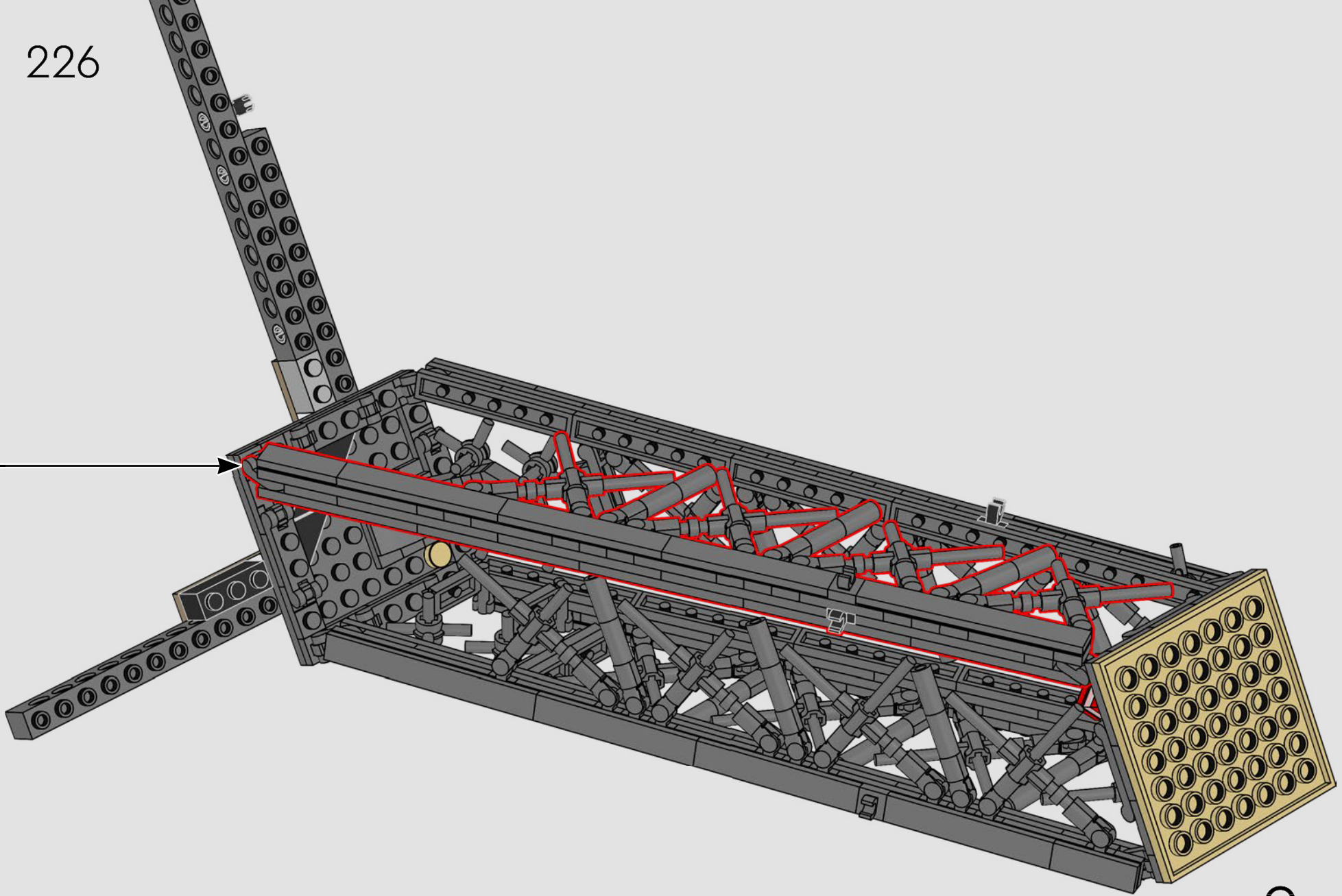

2x



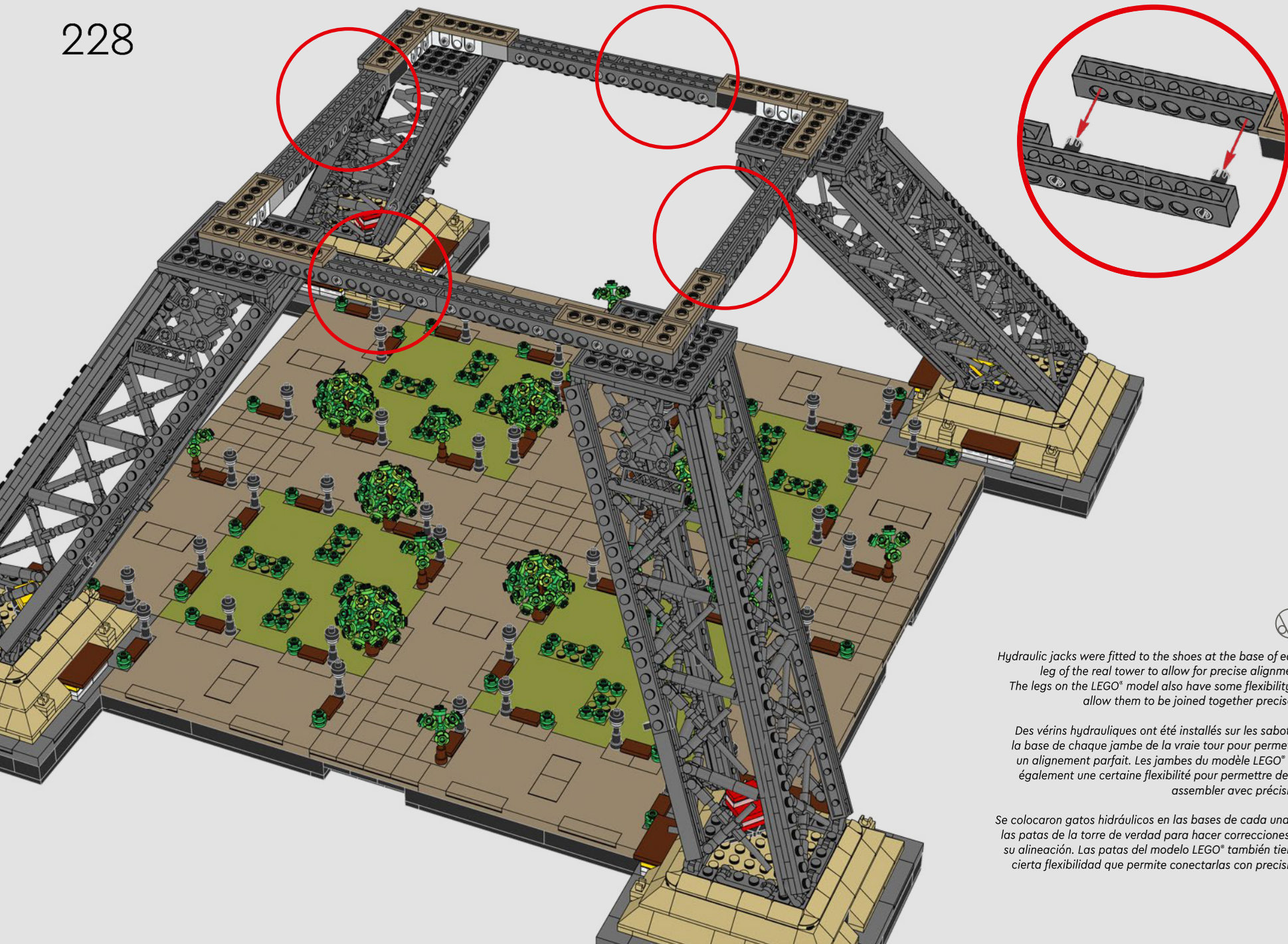

Hydraulic jacks were fitted to the shoes at the base of each leg of the real tower to allow for precise alignment. The legs on the LEGO® model also have some flexibility to allow them to be joined together precisely.

Des vérins hydrauliques ont été installés sur les sabots à la base de chaque jambe de la vraie tour pour permettre un alignement parfait. Les jambes du modèle LEGO® ont également une certaine flexibilité pour permettre de les assembler avec précision.

Se colocaron gatos hidráulicos en las bases de cada una de las patas de la torre de verdad para hacer correcciones en su alineación. Las patas del modelo LEGO® también tienen cierta flexibilidad que permite conectarlas con precisión.

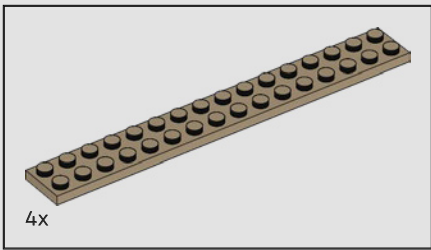

229



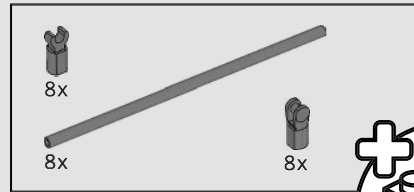
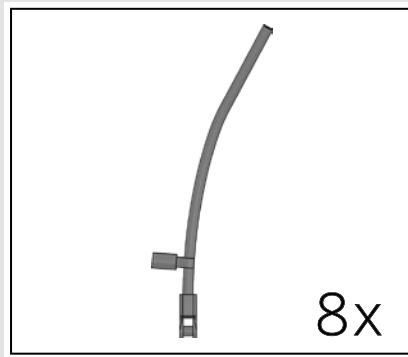
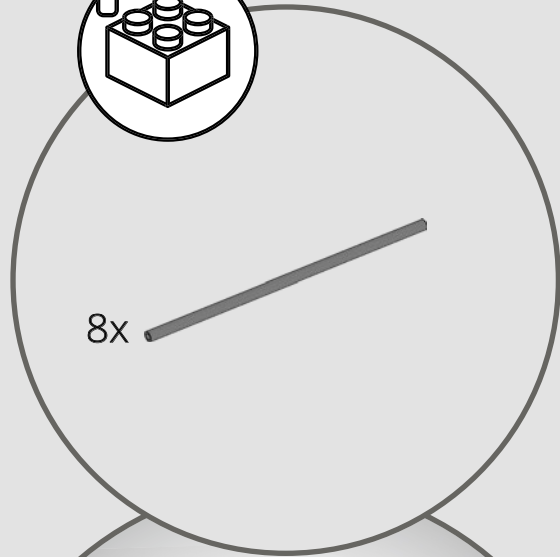
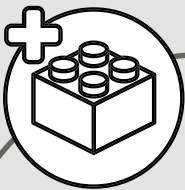

230

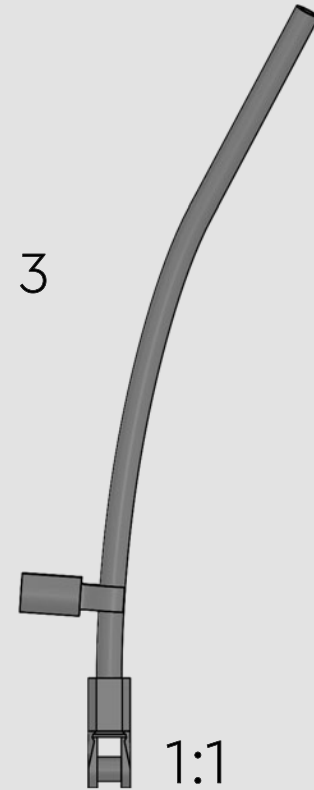
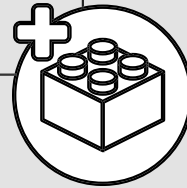

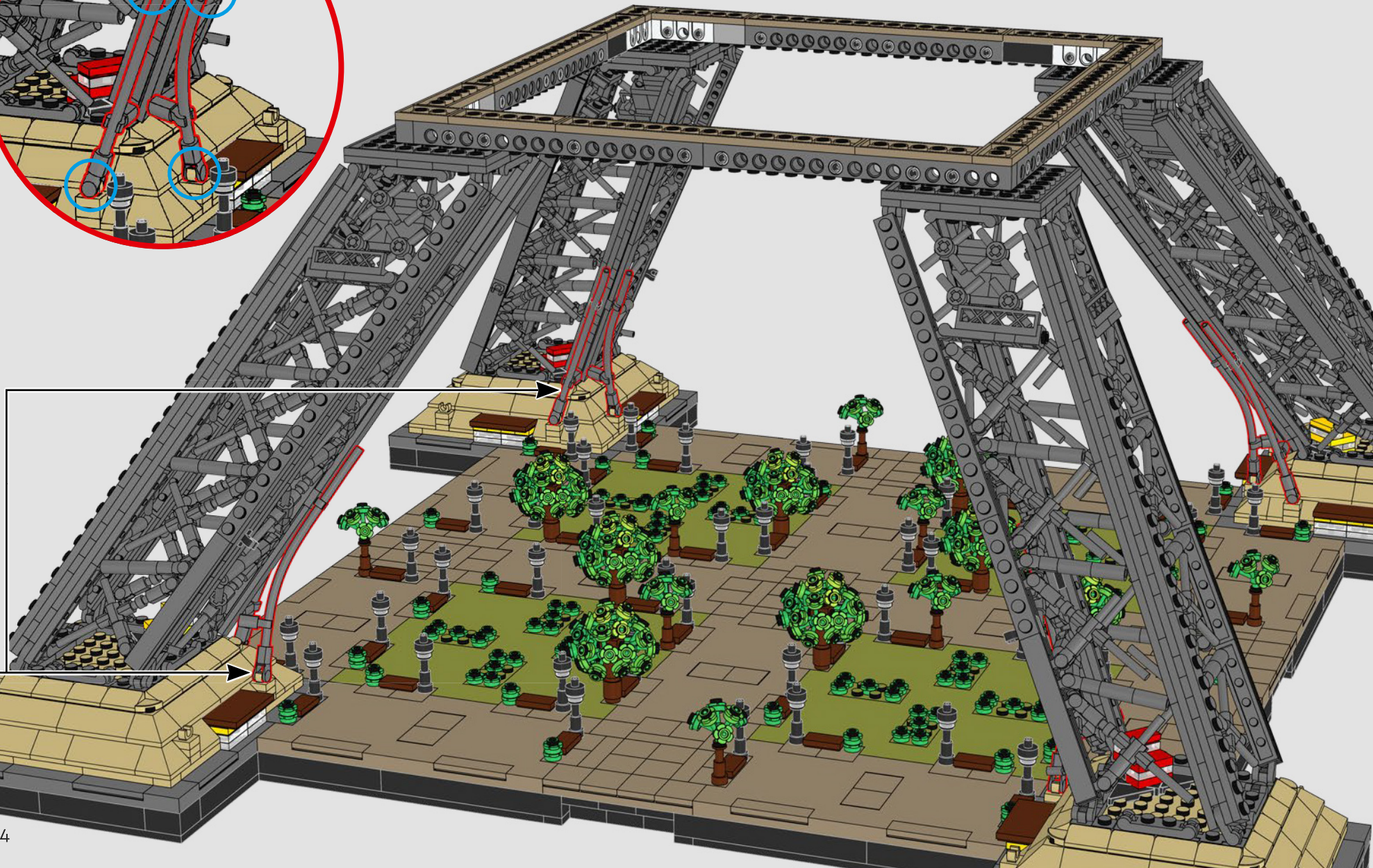
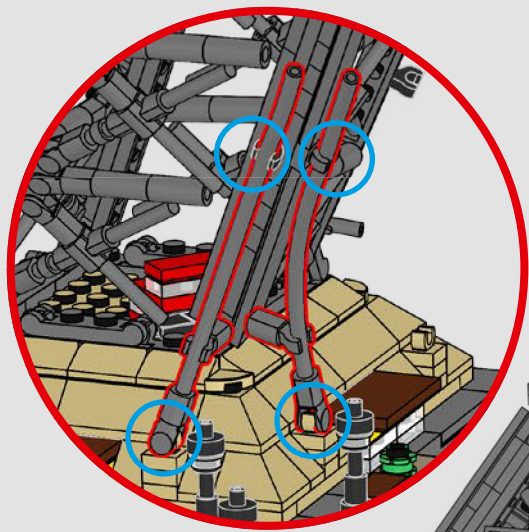

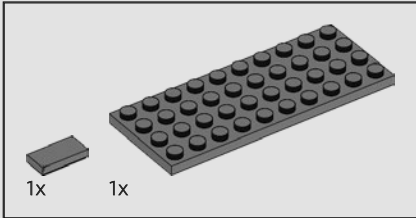
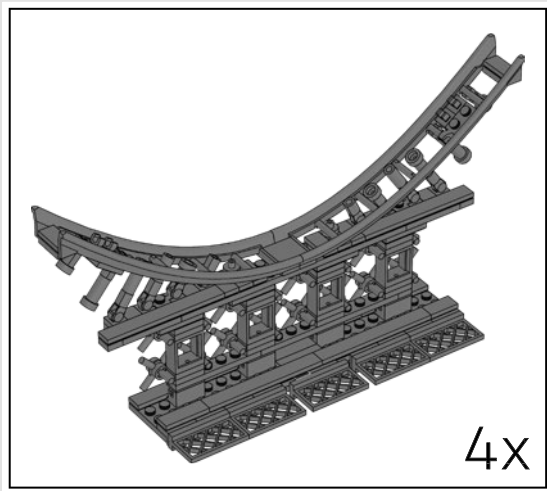

231

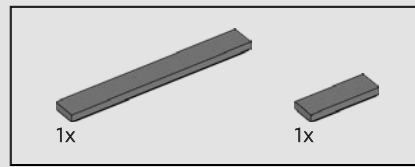
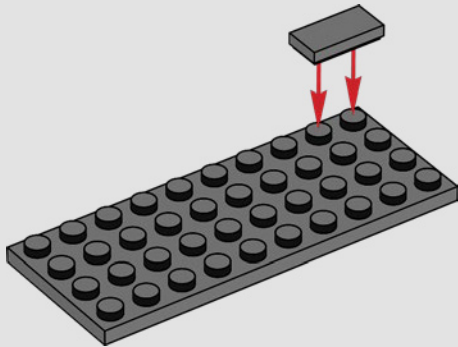

232

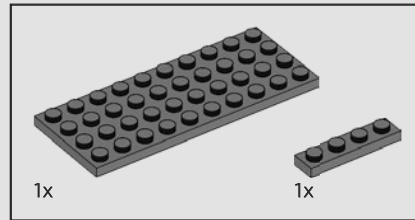
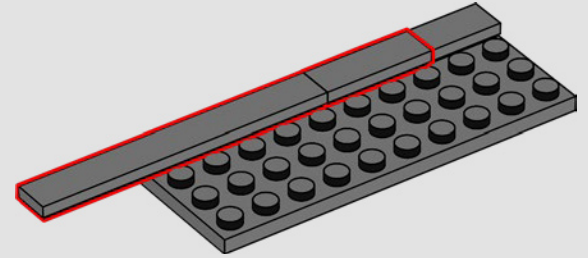

233

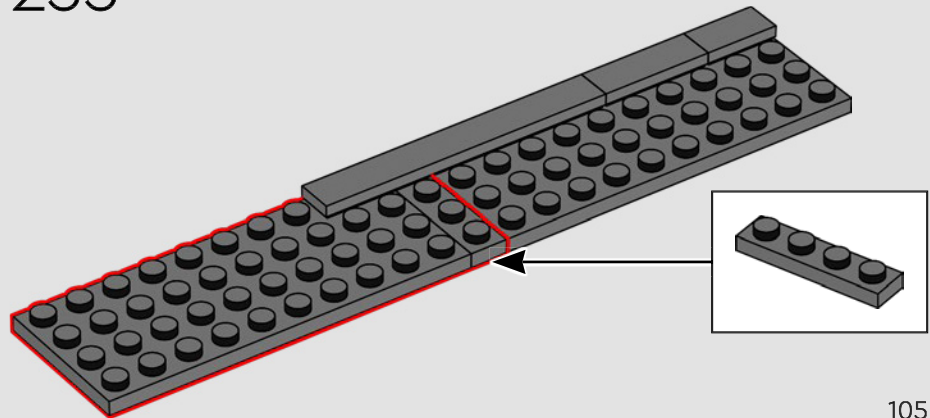

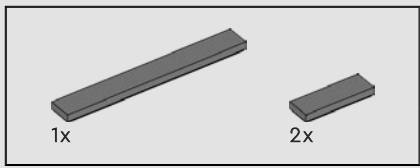

234

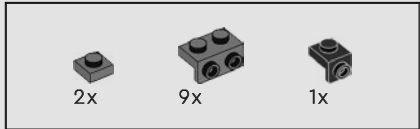
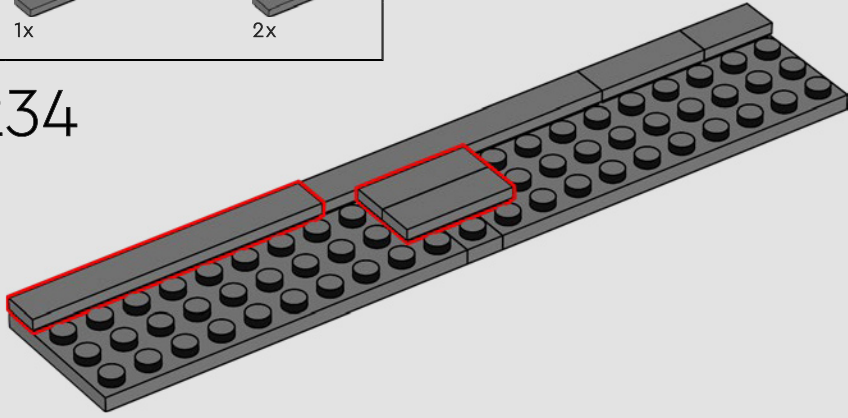

235

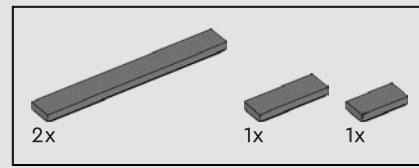
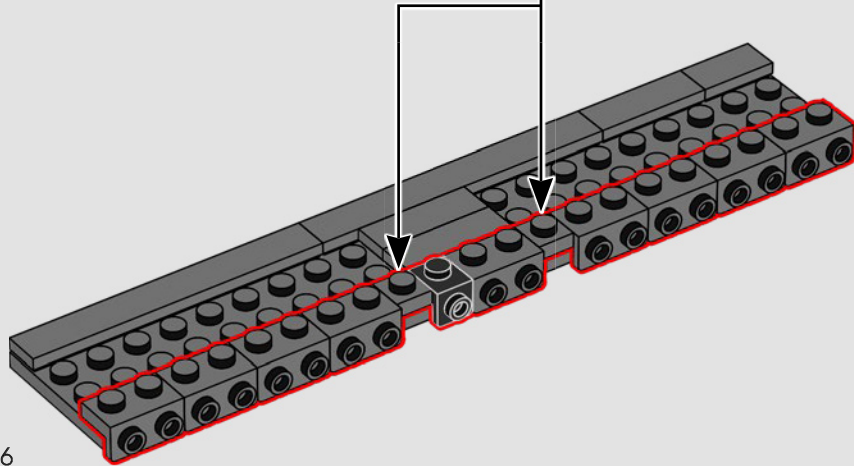
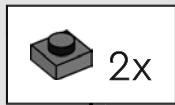

236

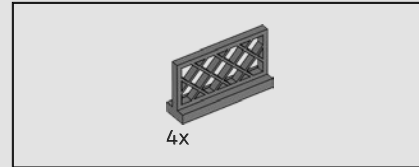
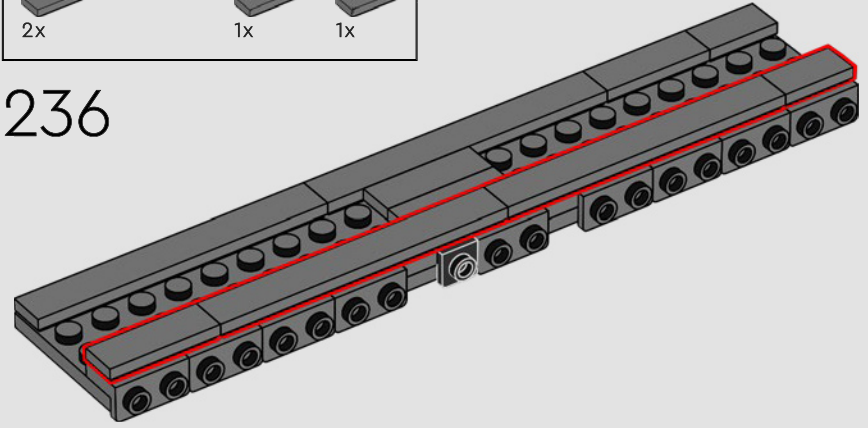

237

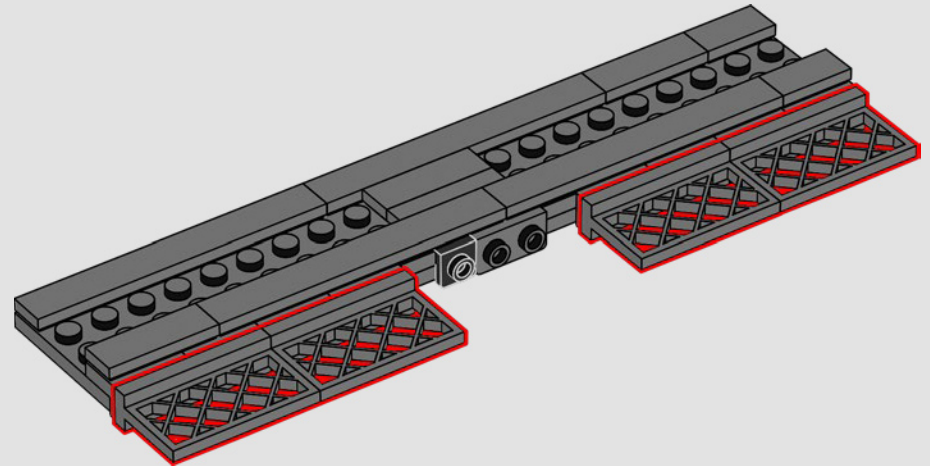

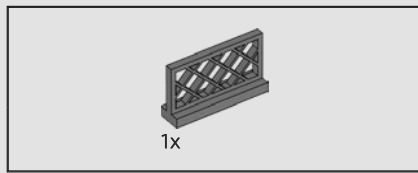

238

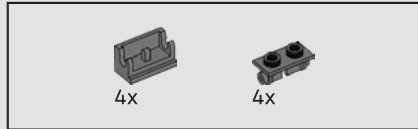
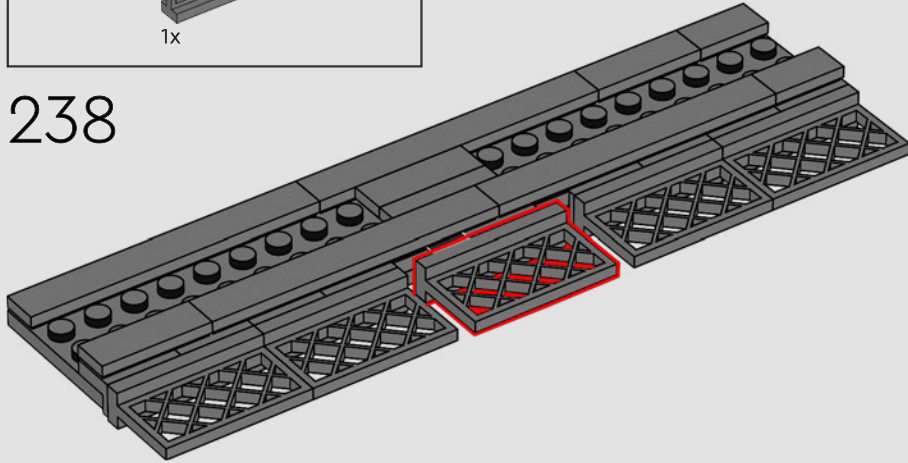

239

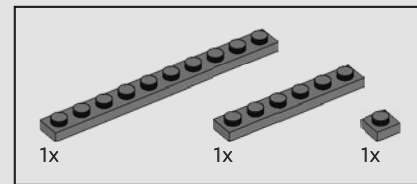
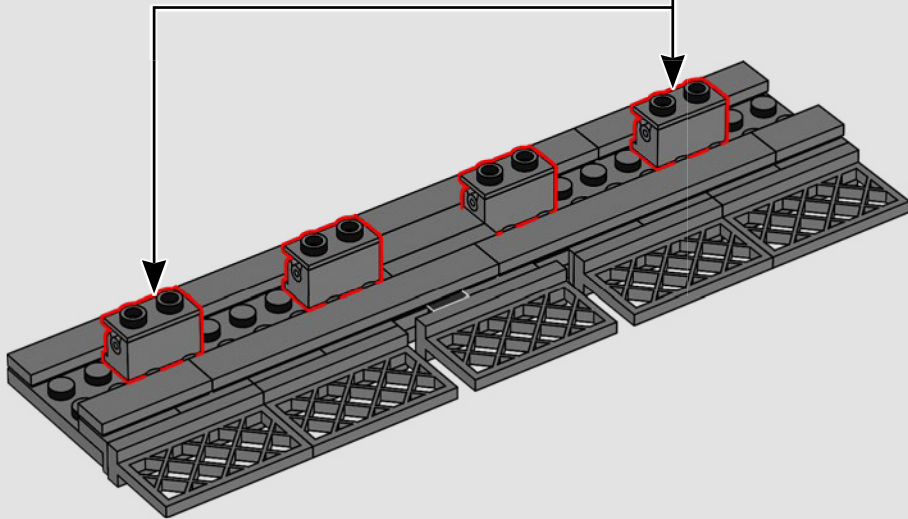
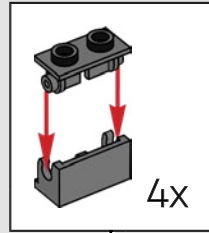

240

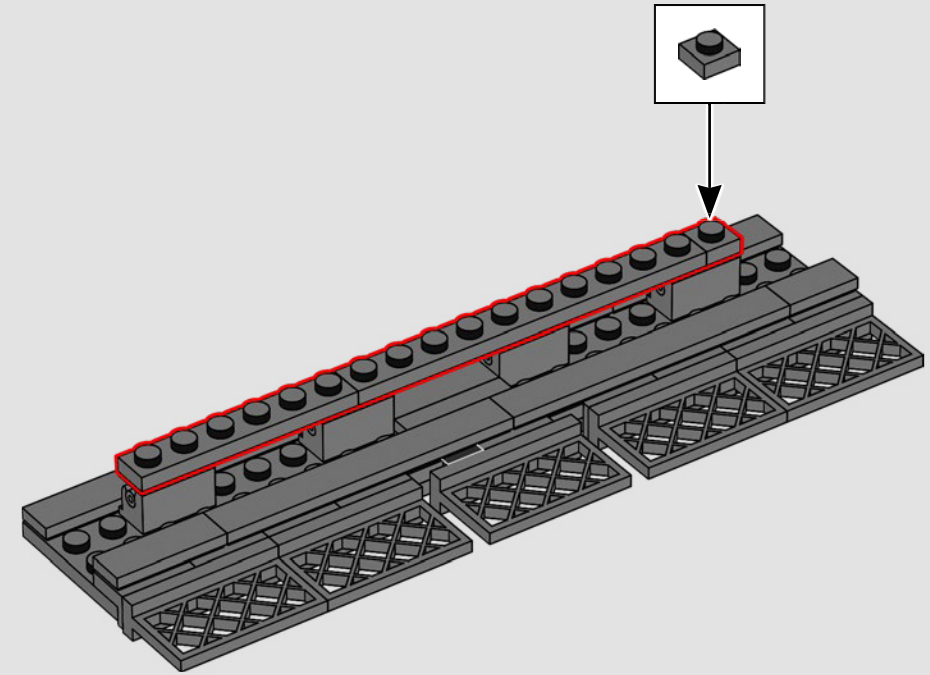



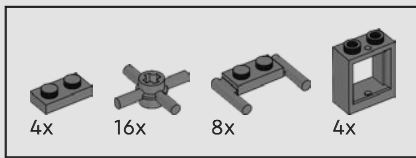

241

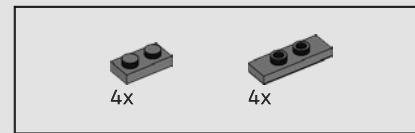
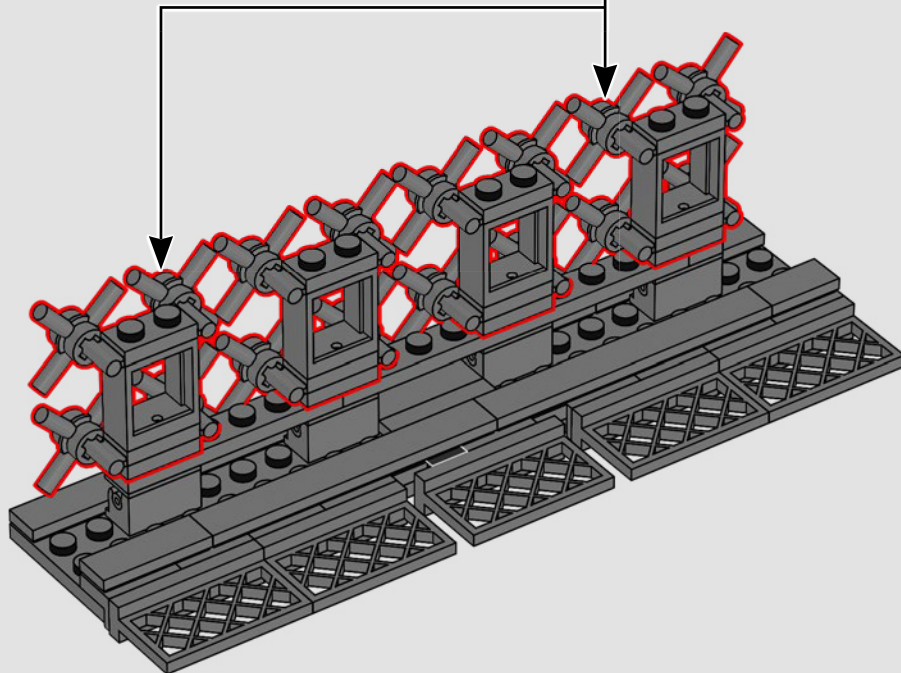
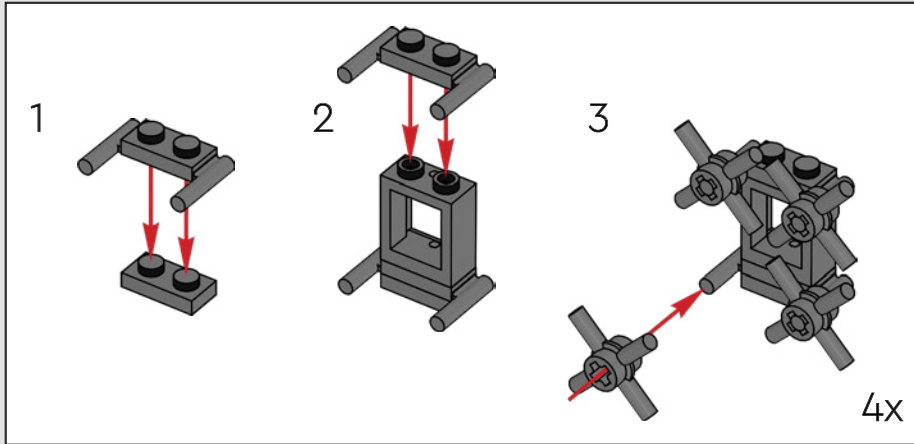

242

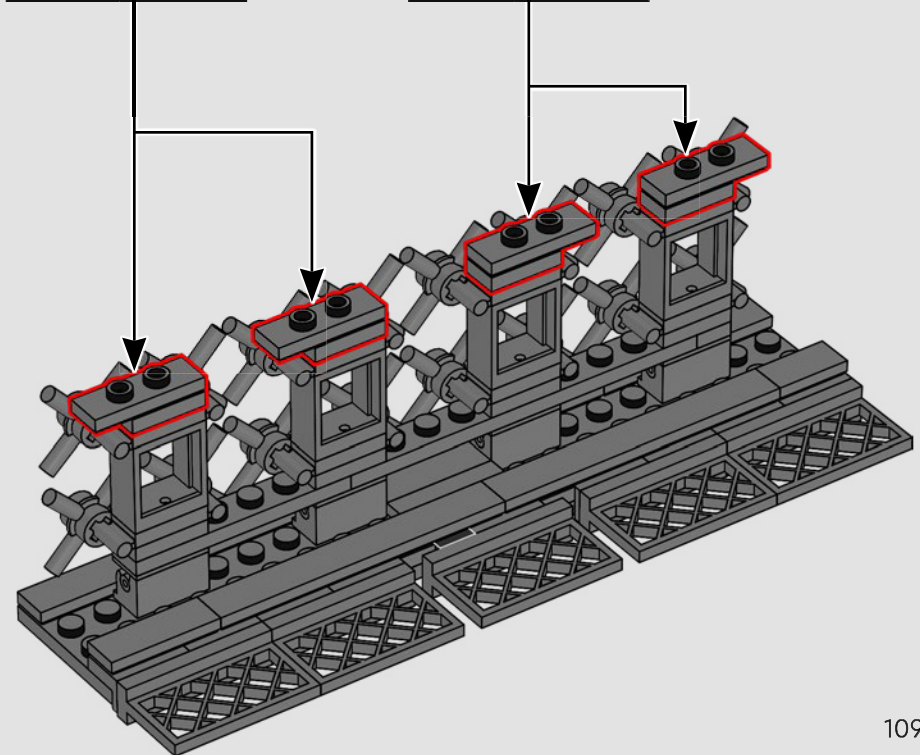
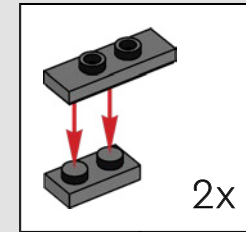
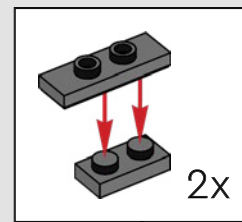

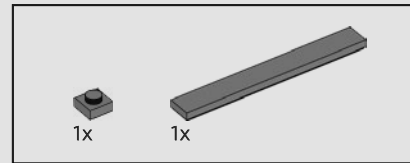
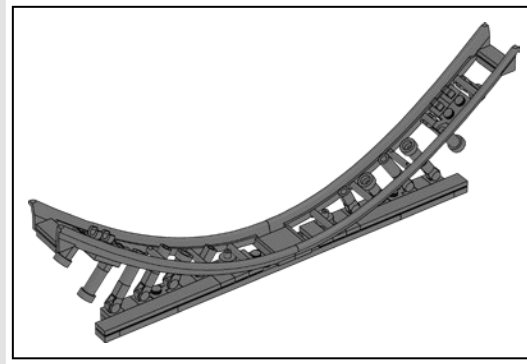
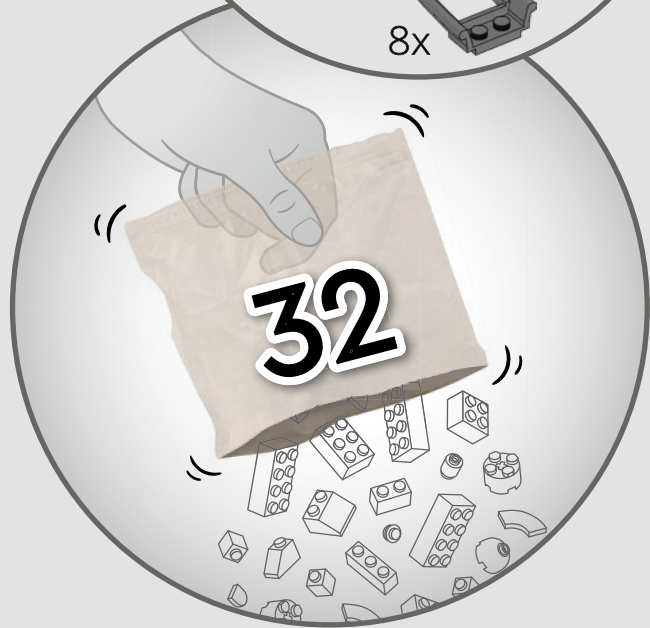
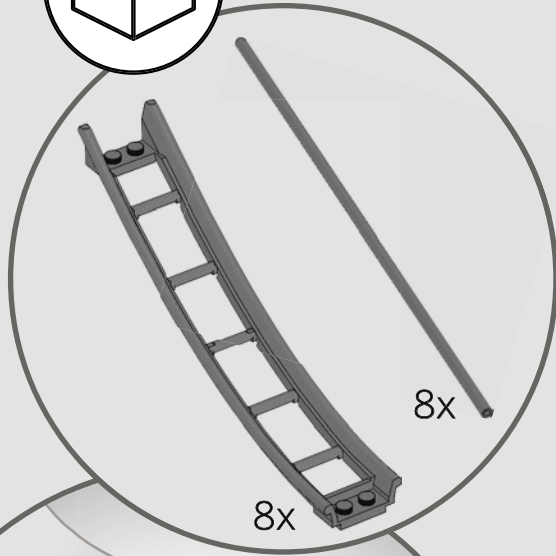
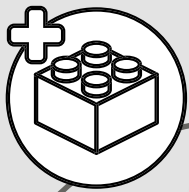

243

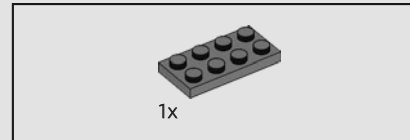
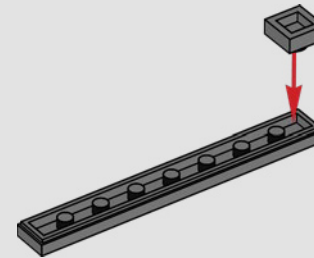

244

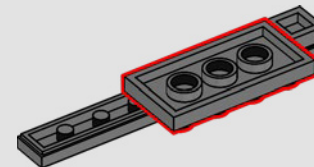

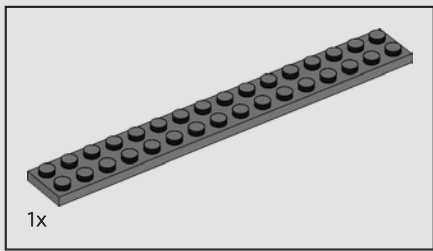

245

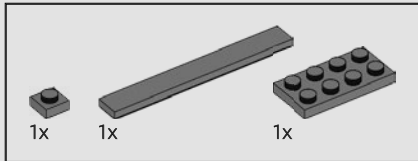
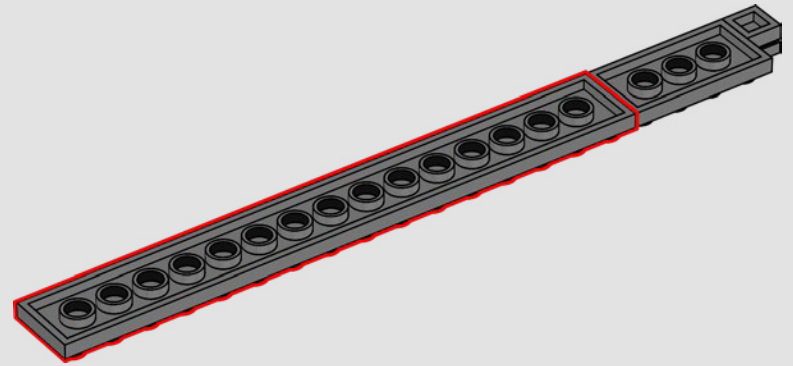

246

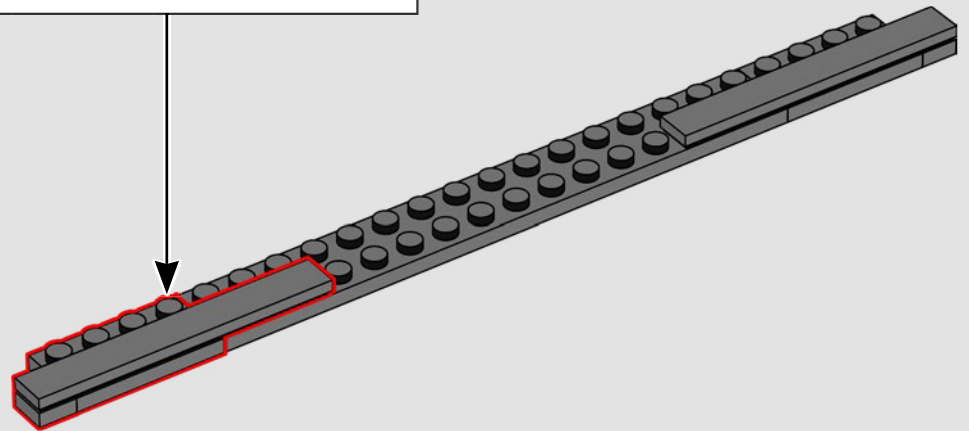
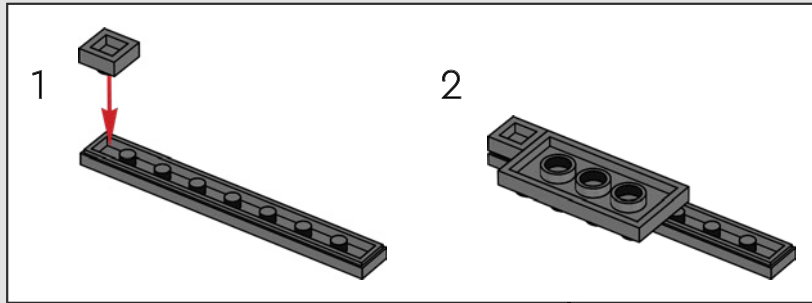

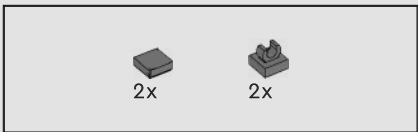

247

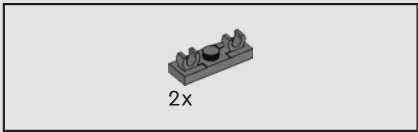
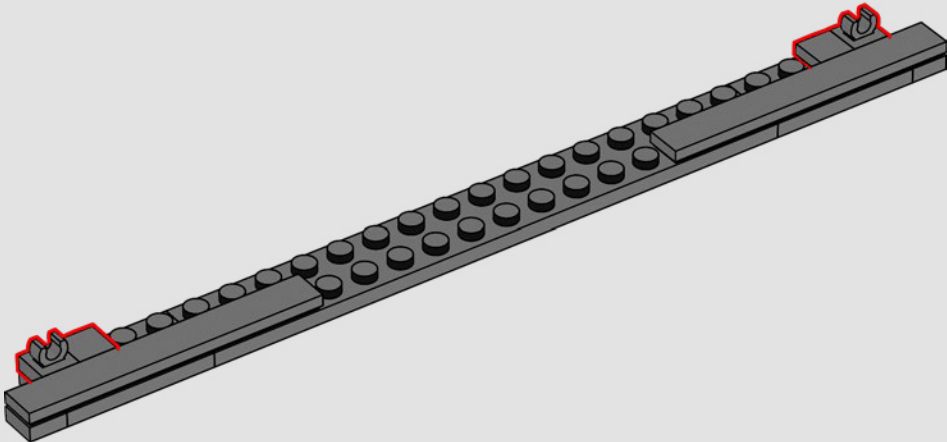

248

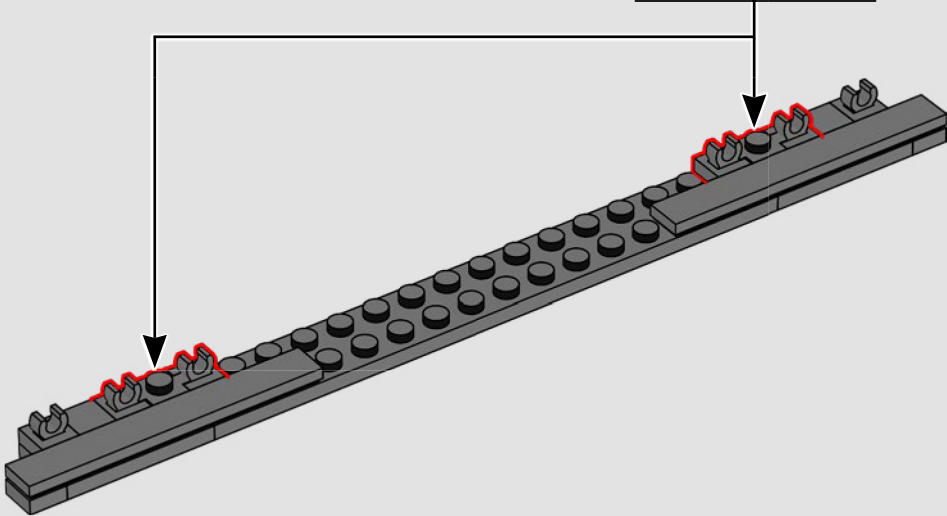
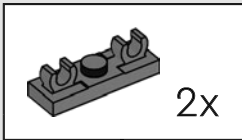

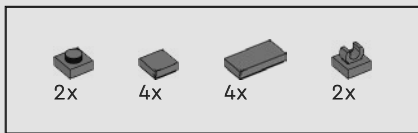

249

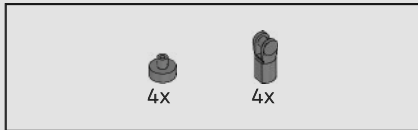
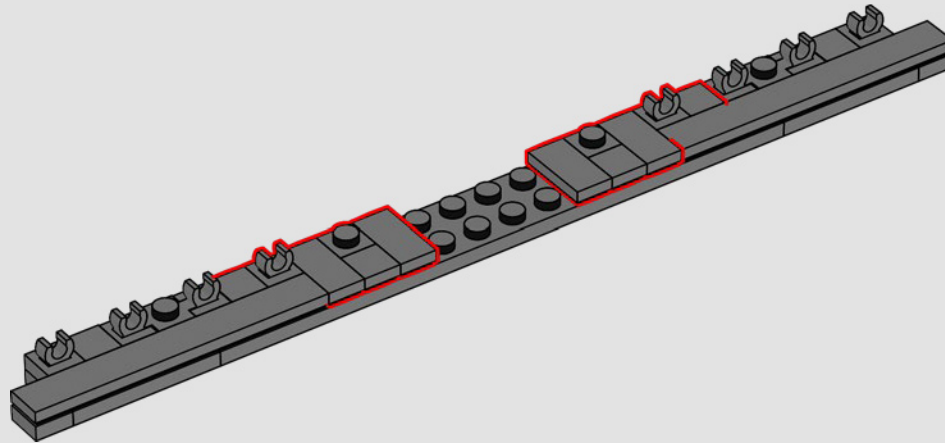

250

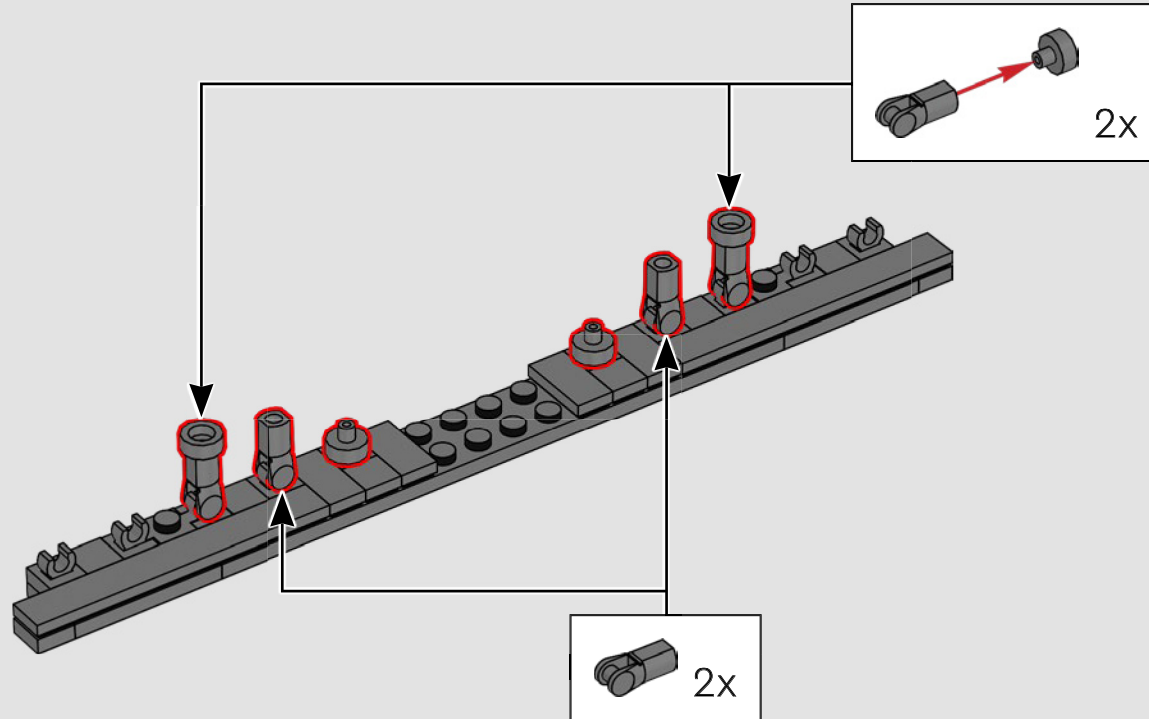

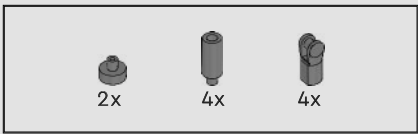

251

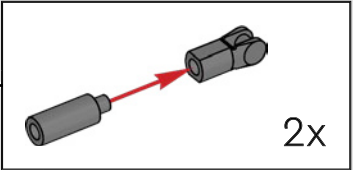
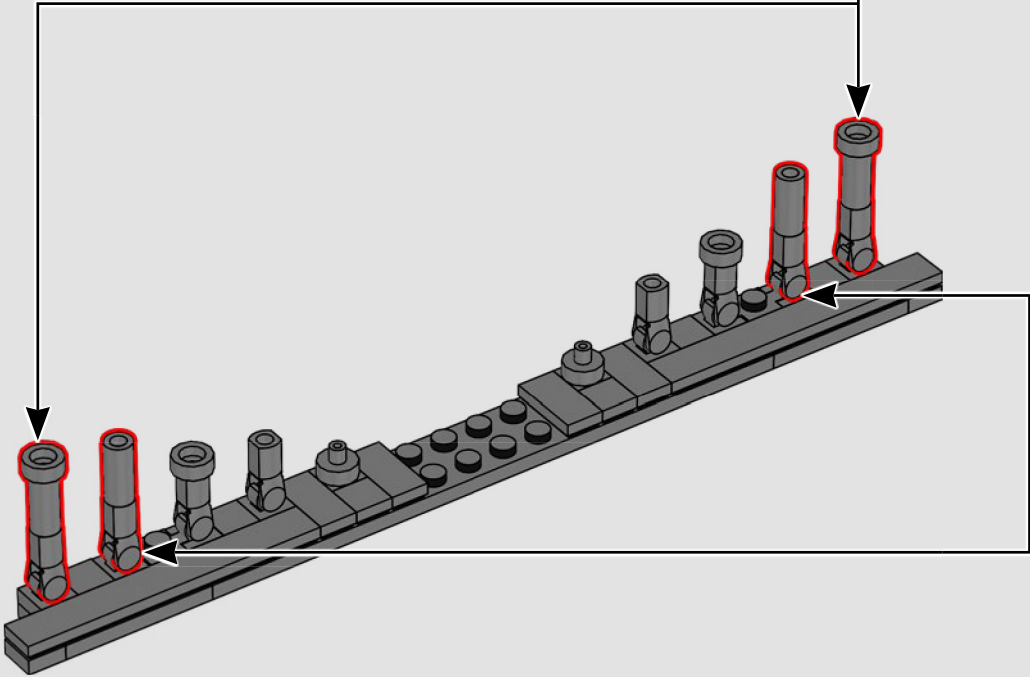
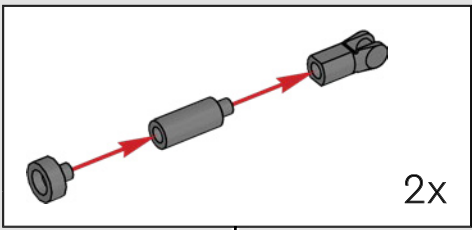

252

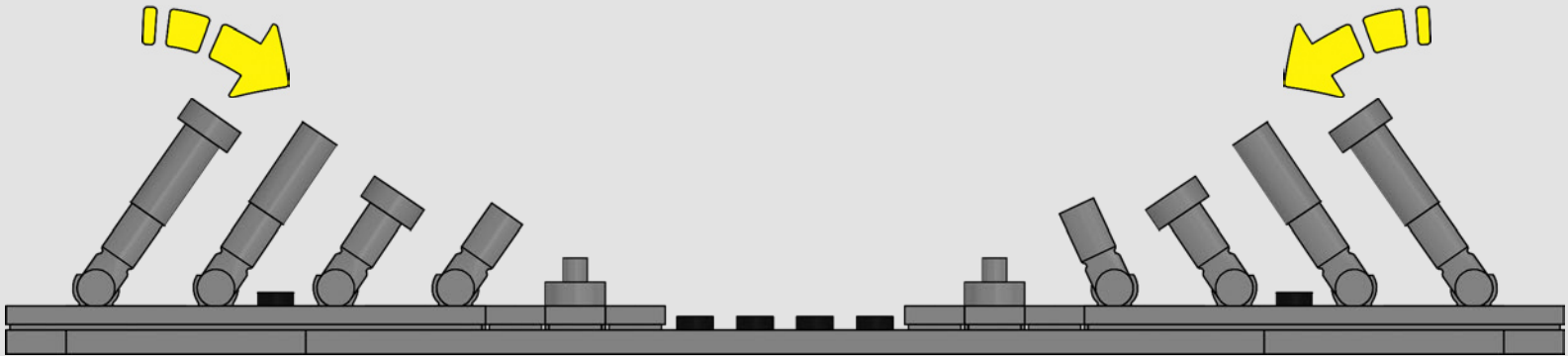

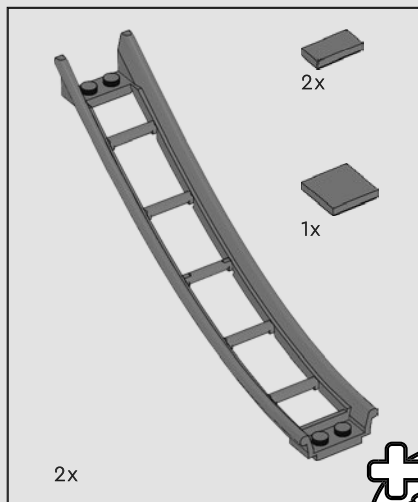

253

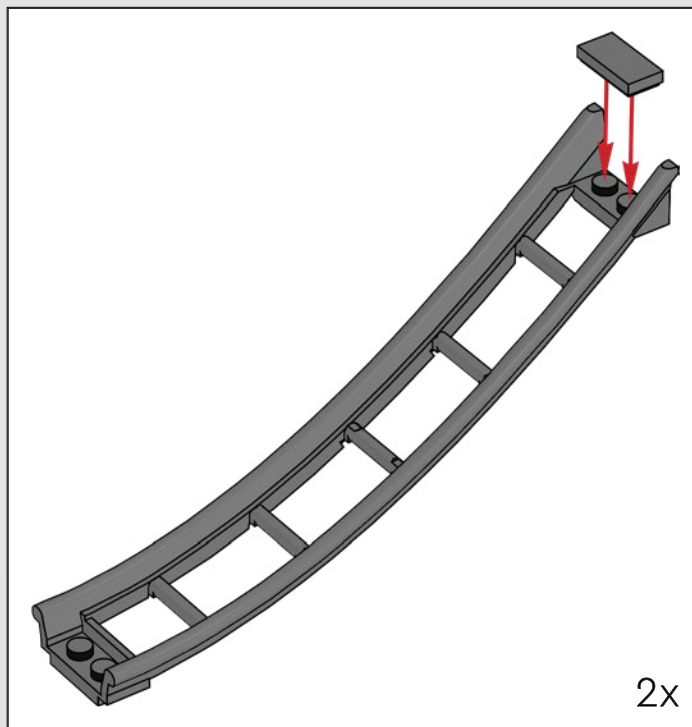
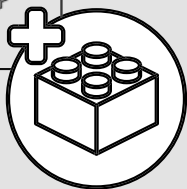

The arches in between the tower's legs are recreated using LEGO® rollercoaster tracks, and the curves are completed using LEGO outer cables.

Les arcs entre les jambes de la tour sont reproduits à l'aide de rails de montagnes russes LEGO®, et les courbes sont complétées par des câbles extérieurs LEGO.

Los arcos que hay entre las patas de la torre se recrean mediante vías de montaña rusa LEGO®, y las curvas se completan utilizando partes exteriores de cables LEGO.

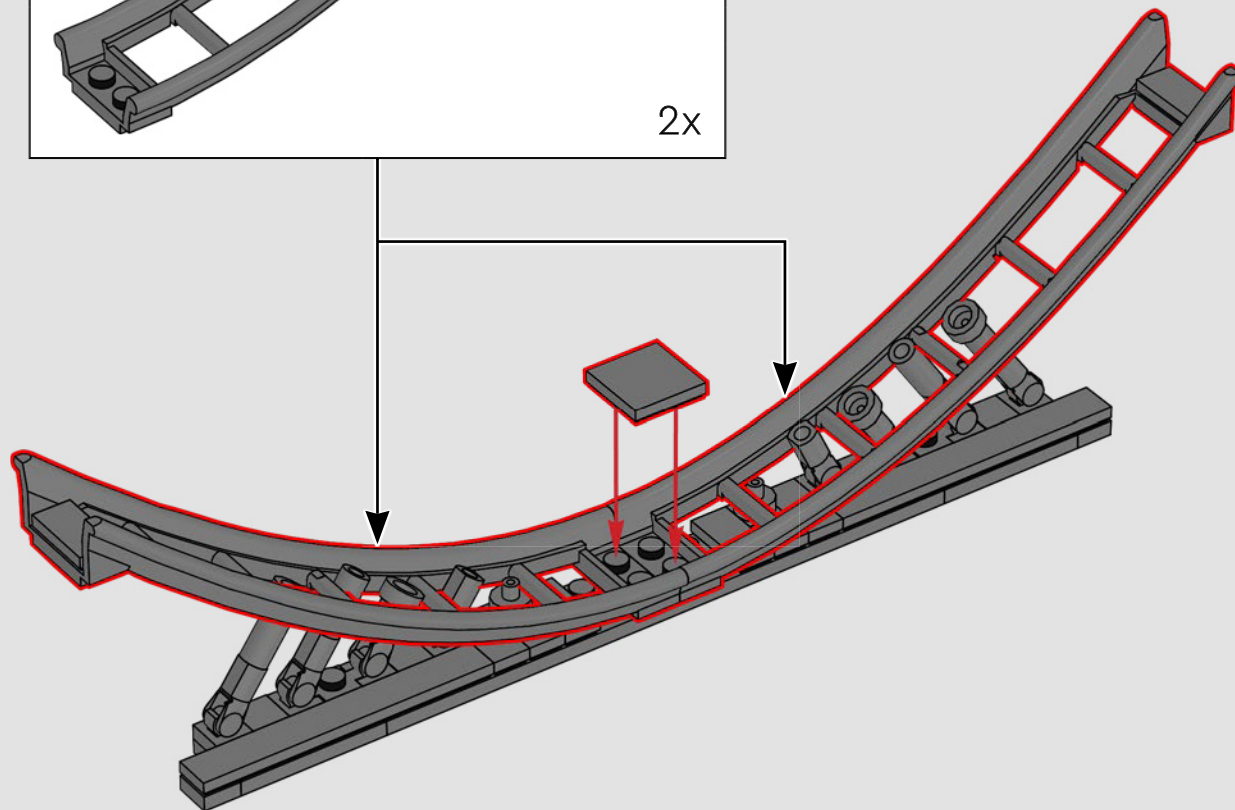



254

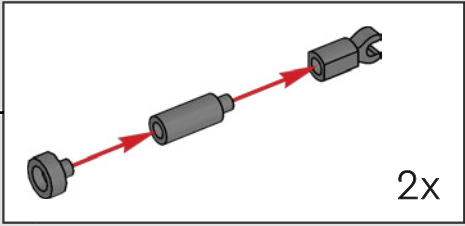
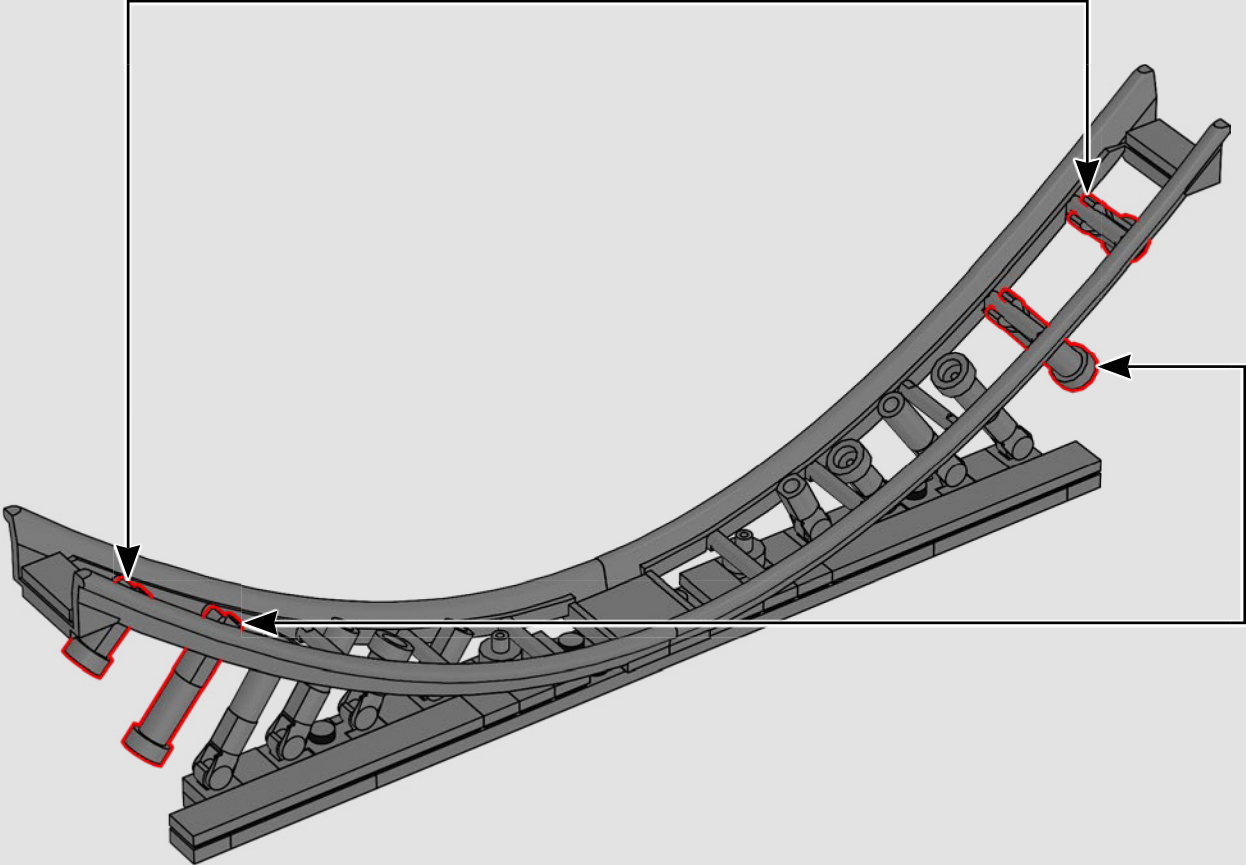
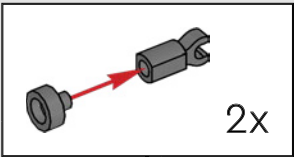

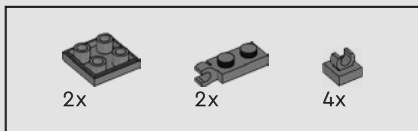

255

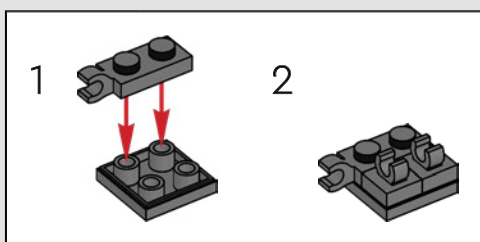

2

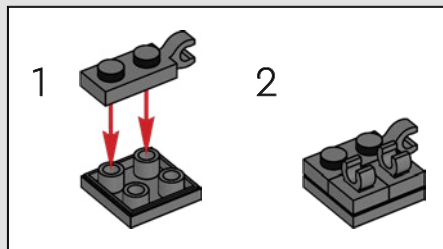
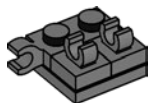

2

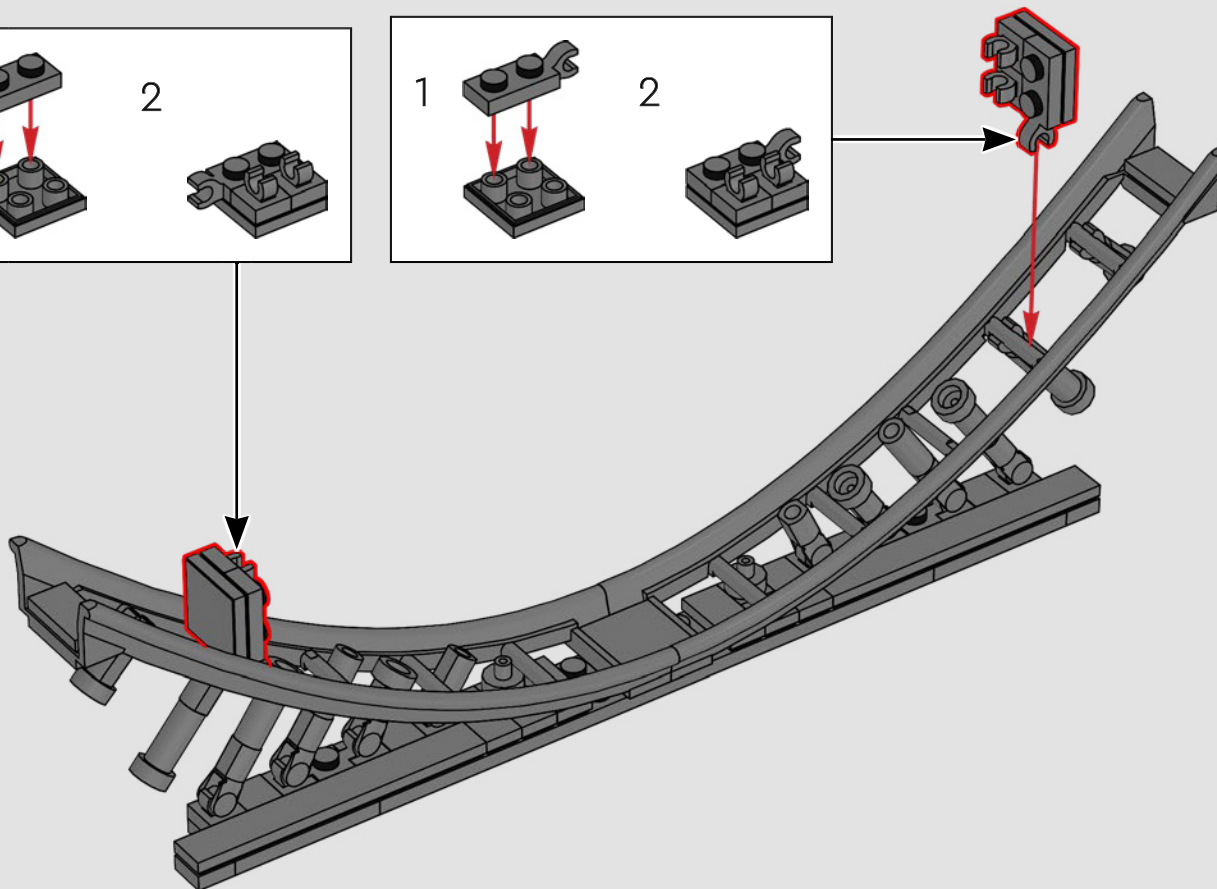
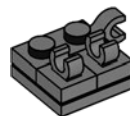

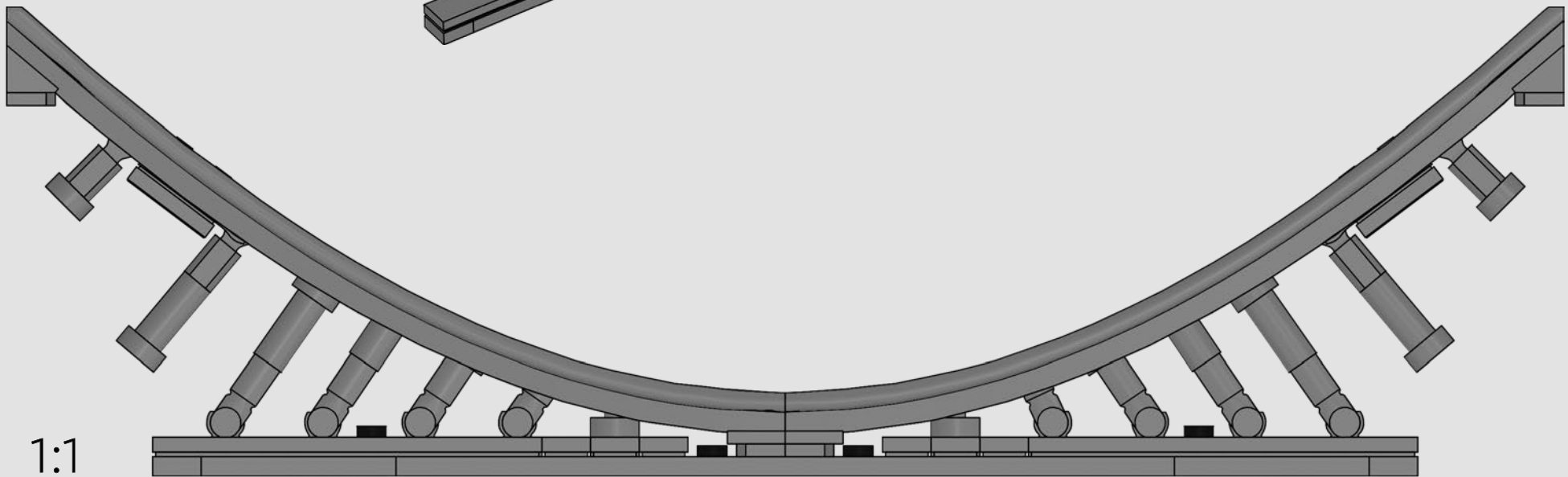
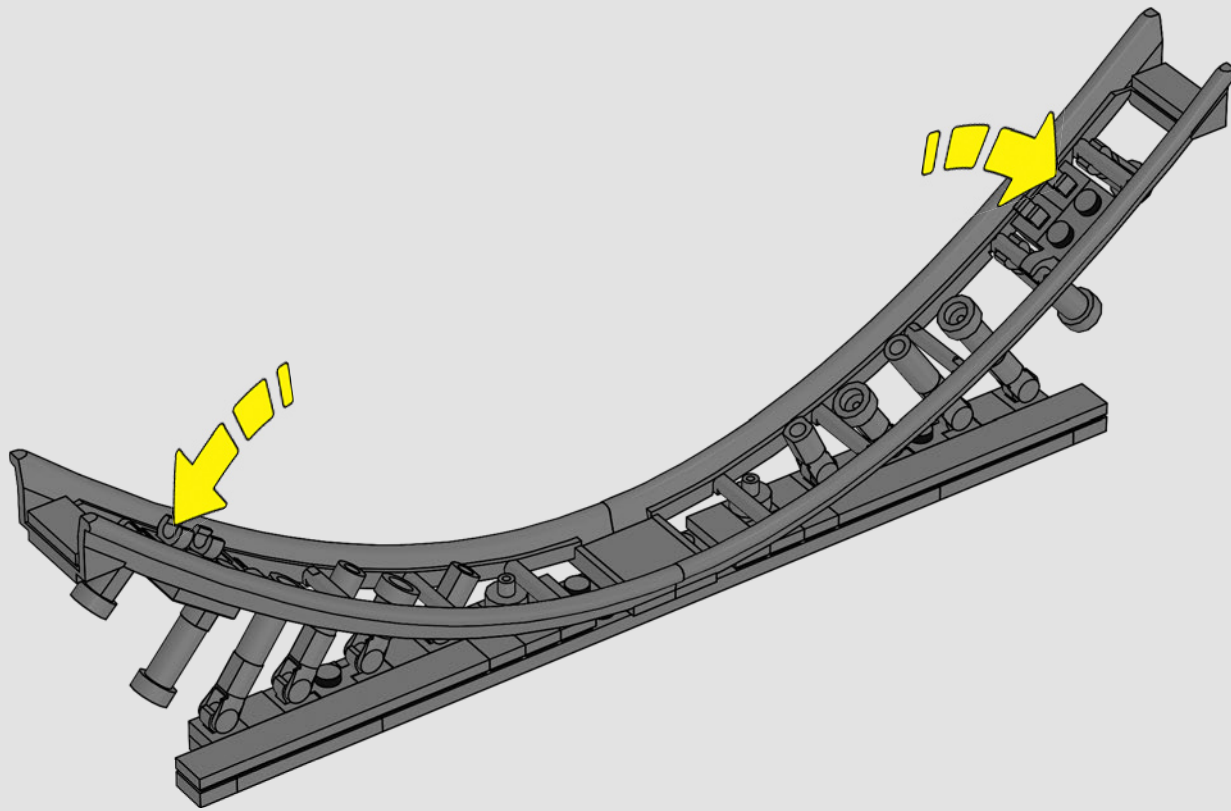

1:1

257

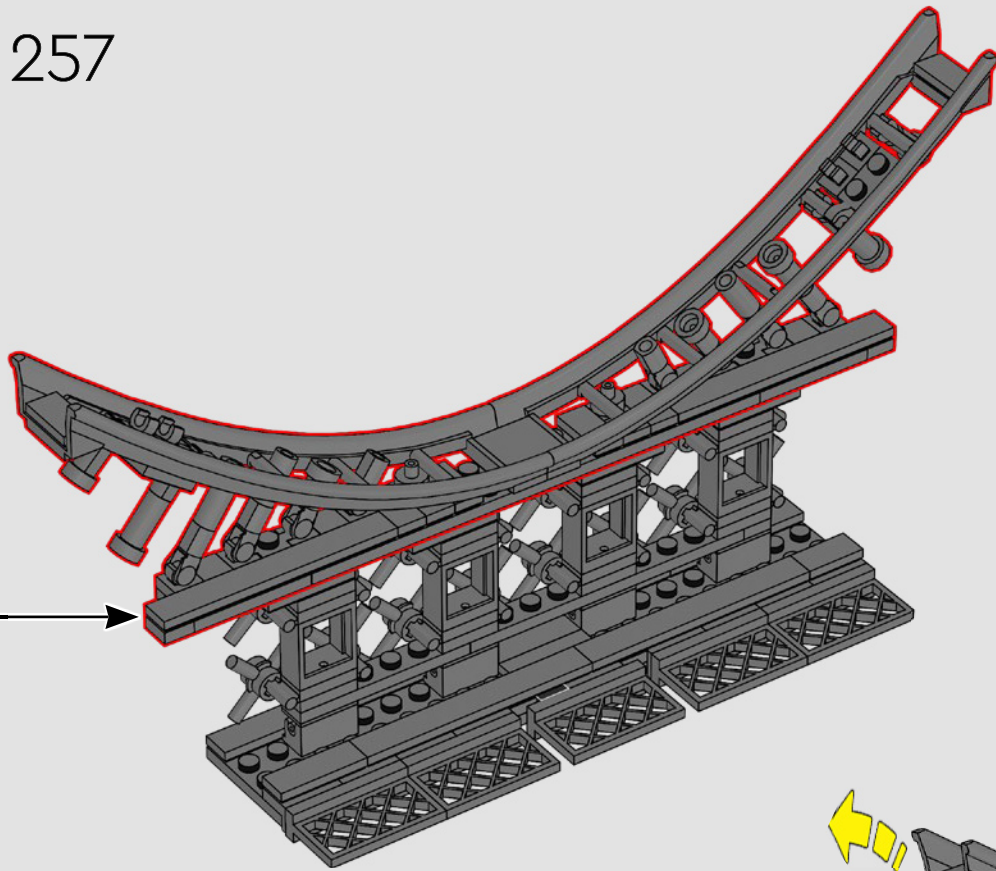

258

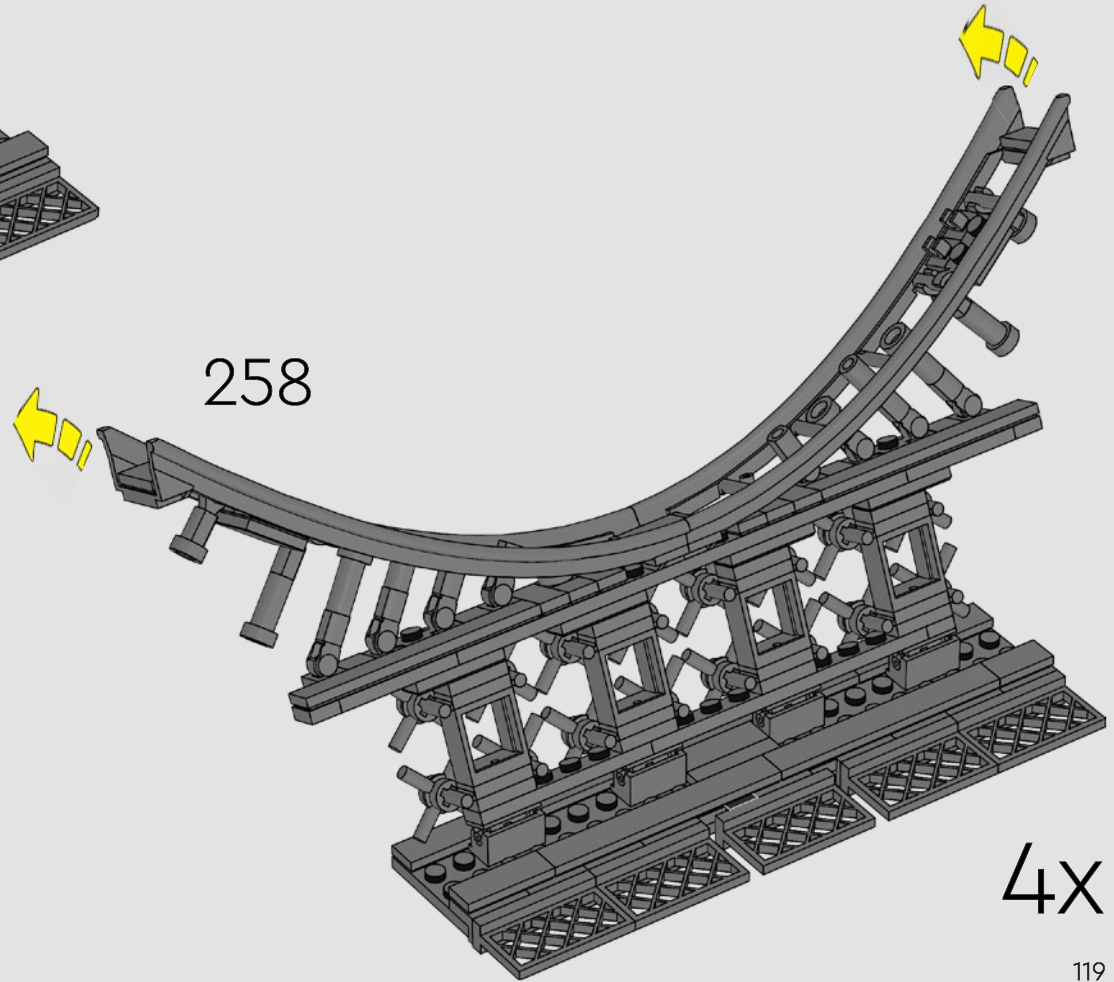

4X



The arches between the legs on the Eiffel tower are not load bearing, they are purely decorative - this is also true of the LEGO® model, where the arches are also for decorative purposes only.

Les arches entre les jambes de la tour Eiffel ne sont pas porteuses, mais strictement décoratives. Ceci est également vrai pour le modèle LEGO®, dont les arches sont uniquement décoratives.

Los arcos que hay entre las patas de la Torre Eiffel no soportan ninguna carga: su función es meramente decorativa. Puede decirse lo mismo del modelo LEGO®, donde los arcos son solo para decoración.

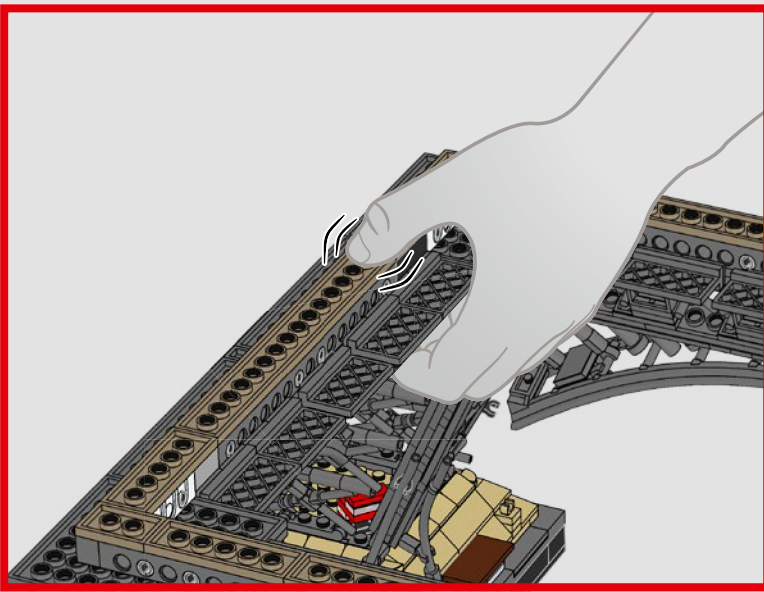

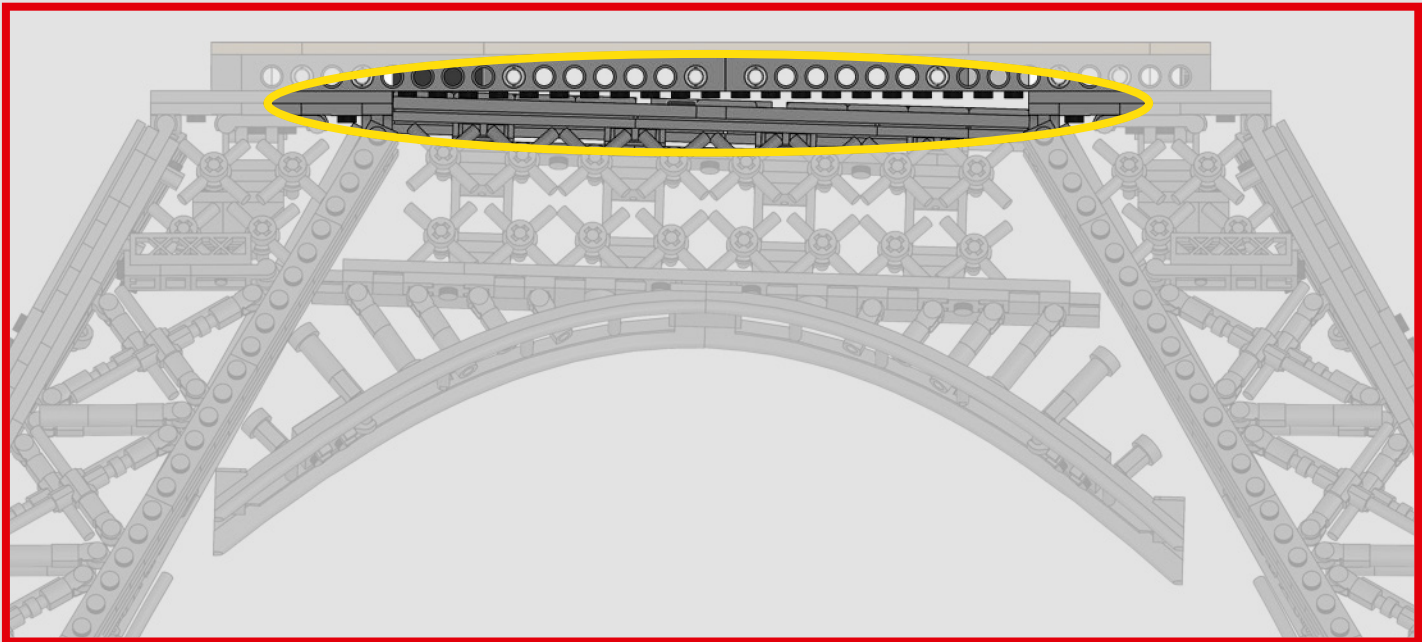
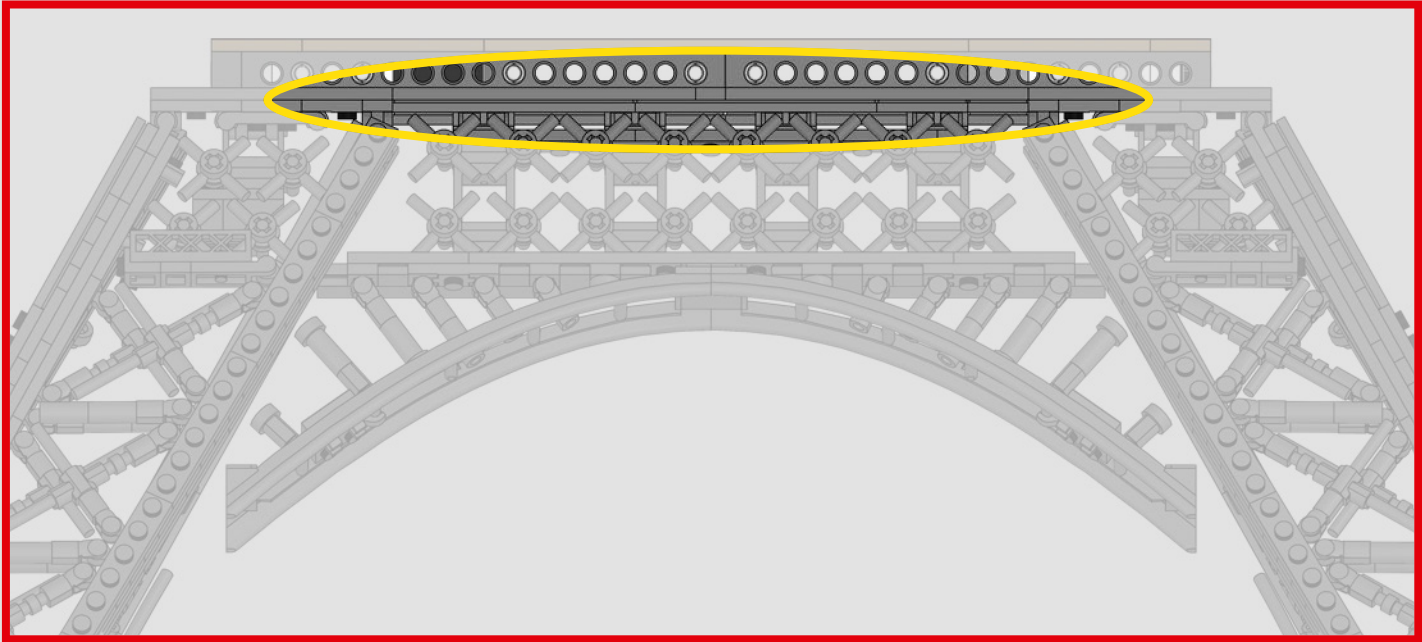

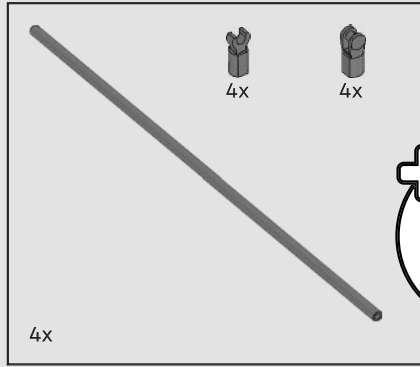
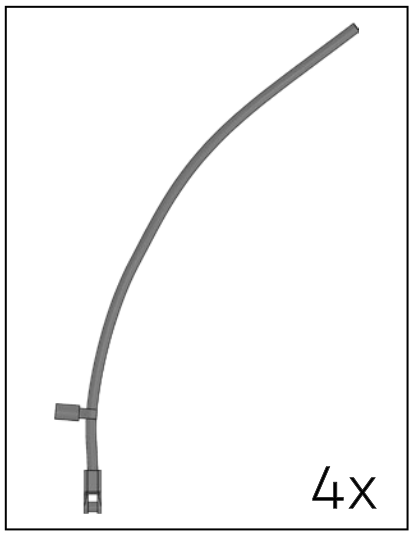

260

1



2



3

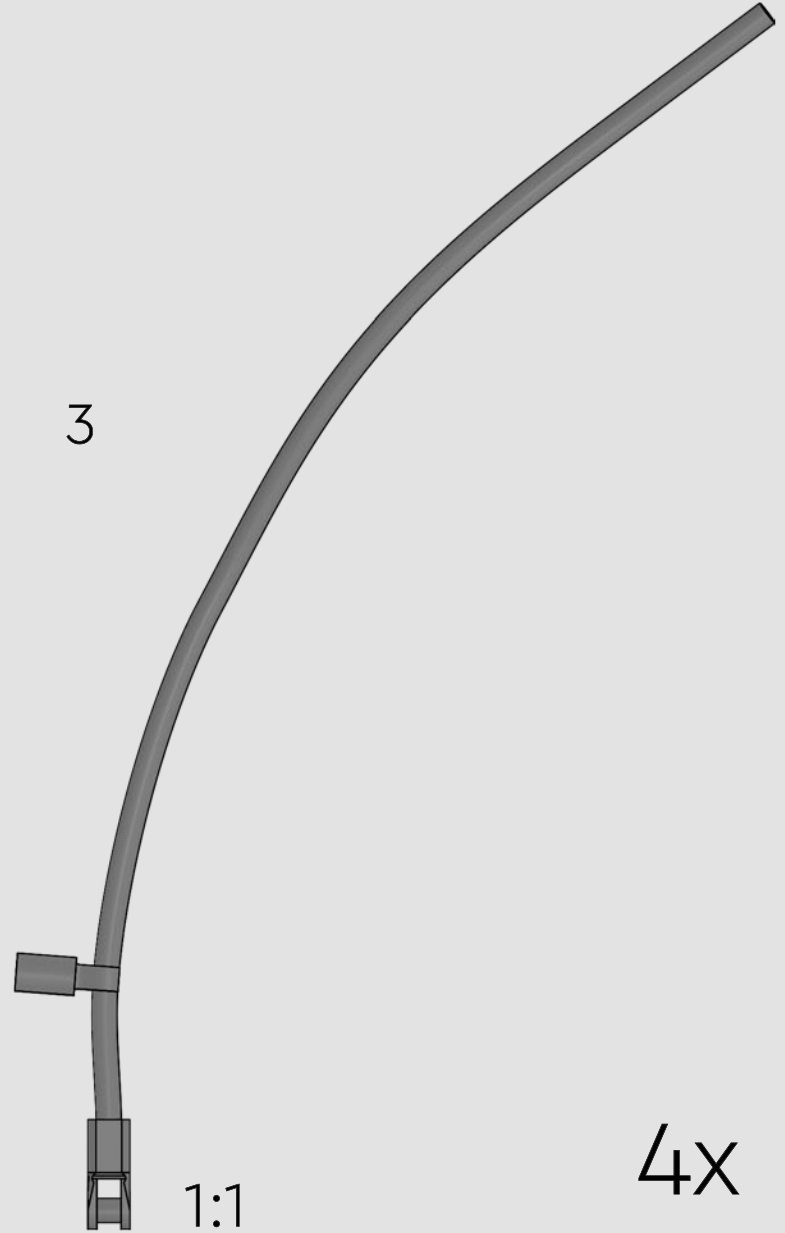

4x

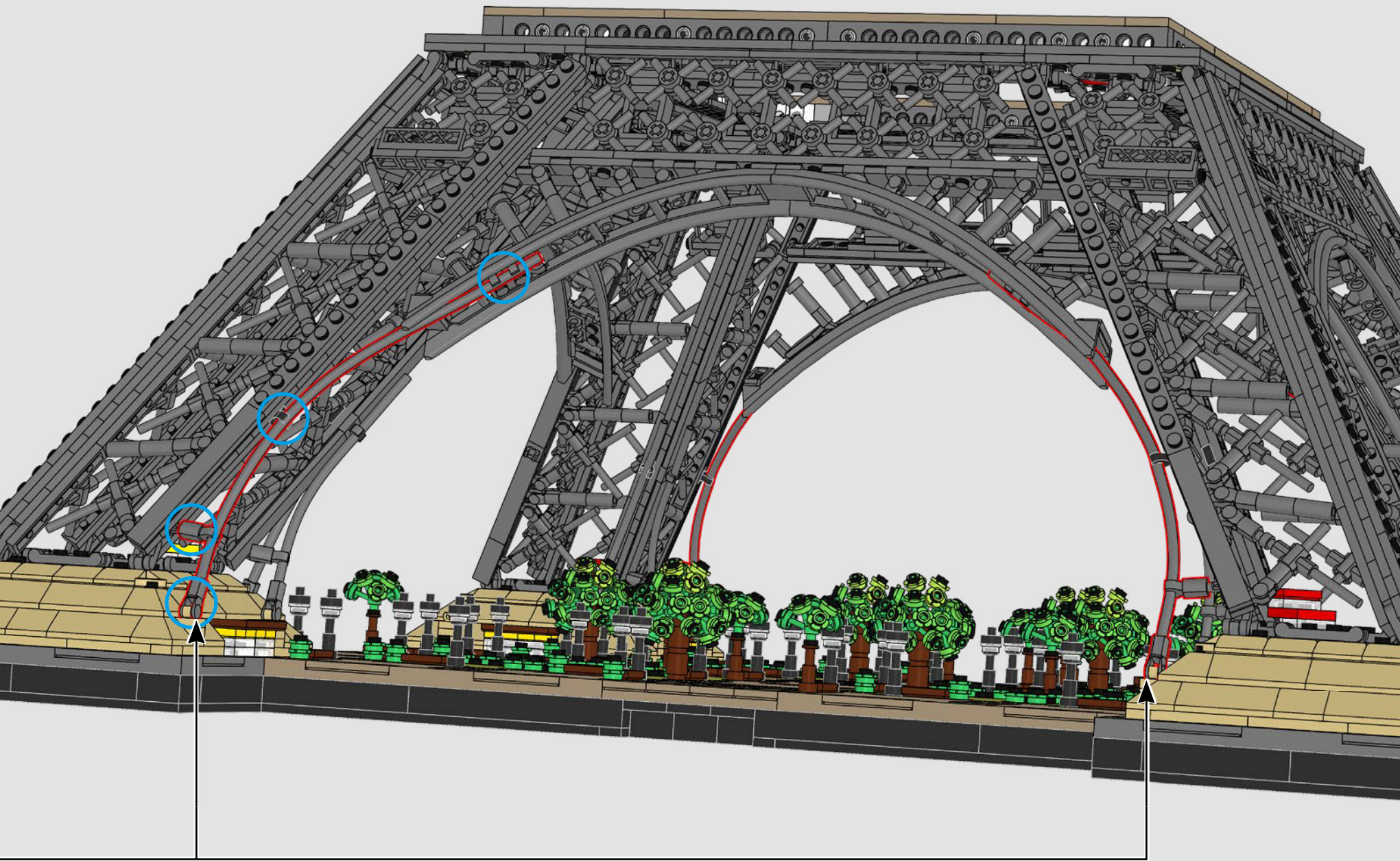

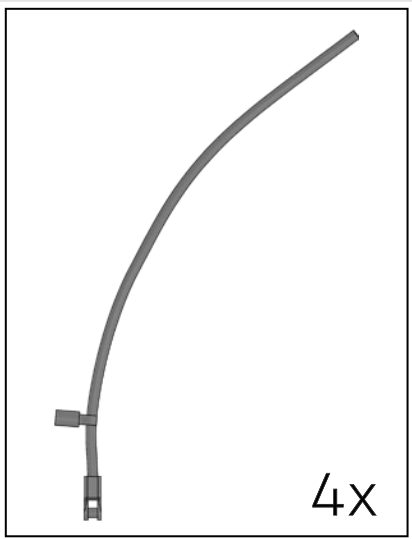

1



2



3

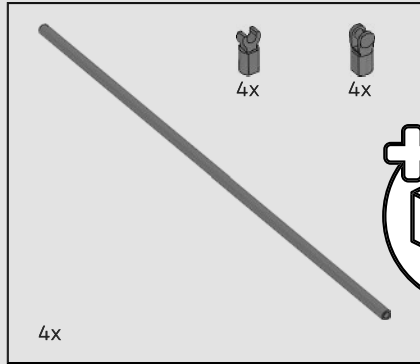
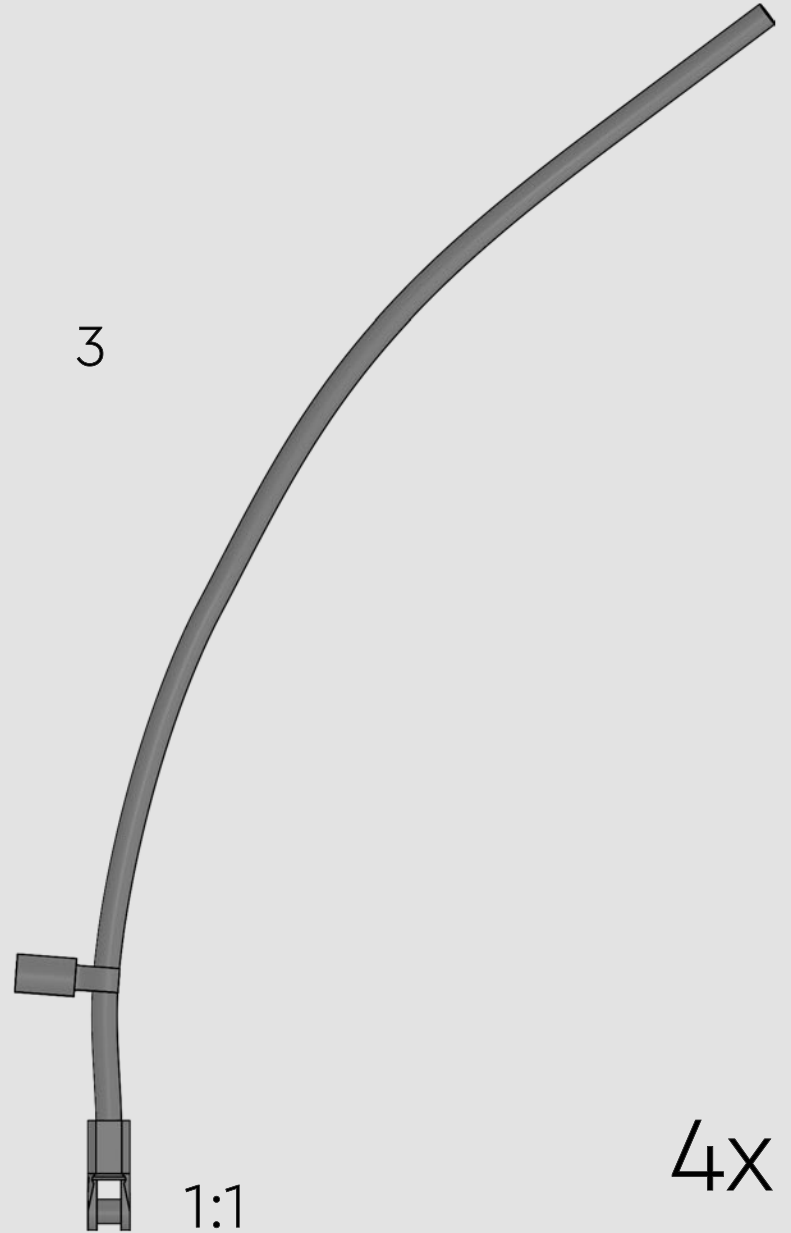

261

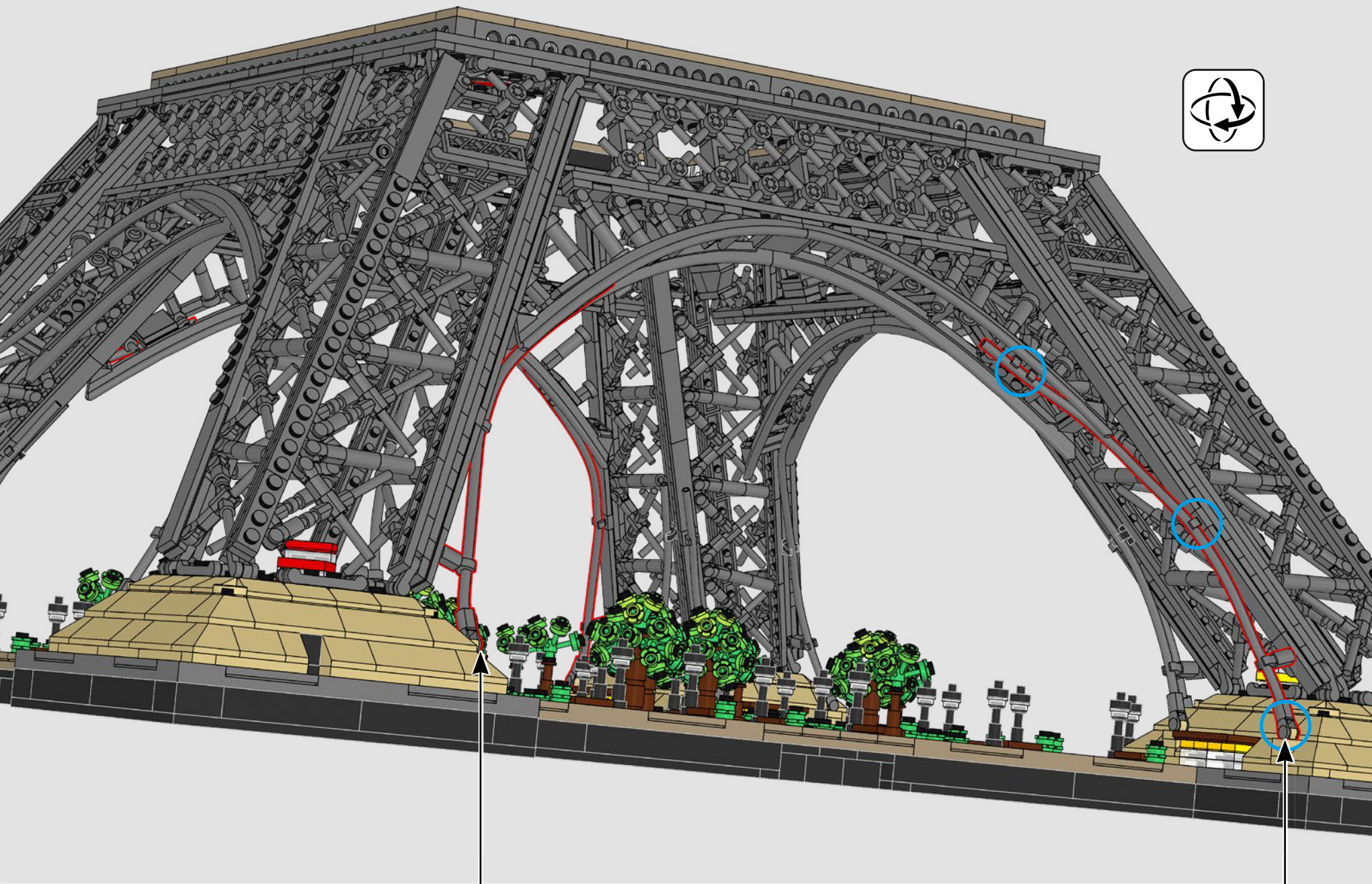
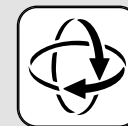

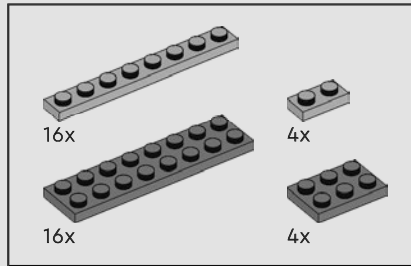
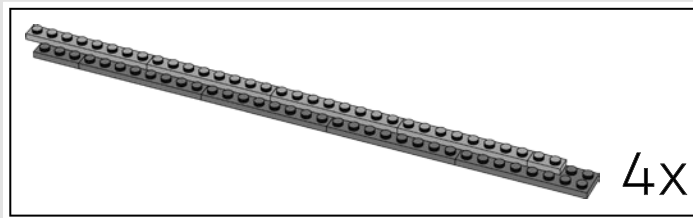

262

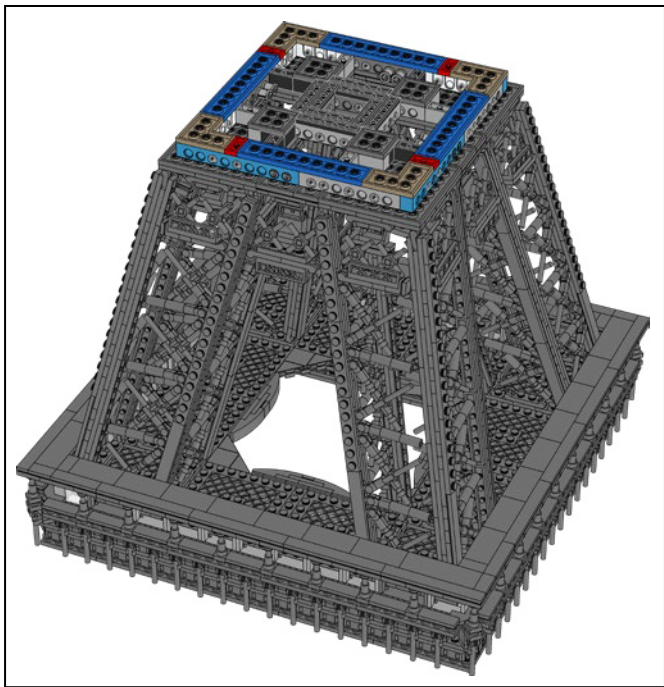
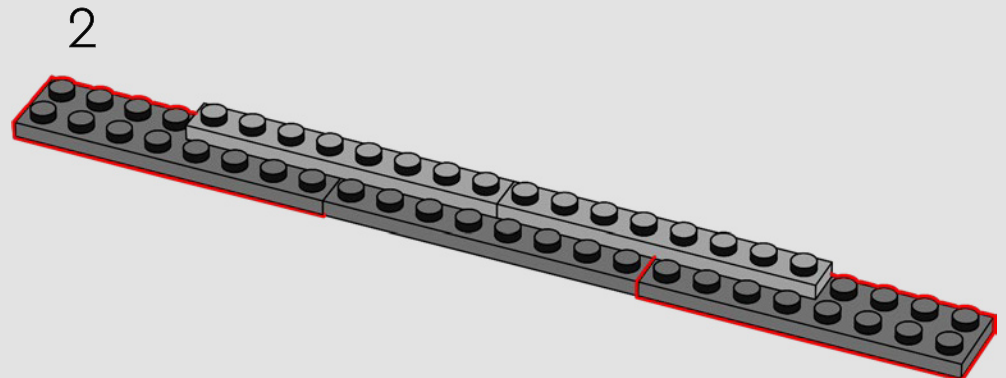
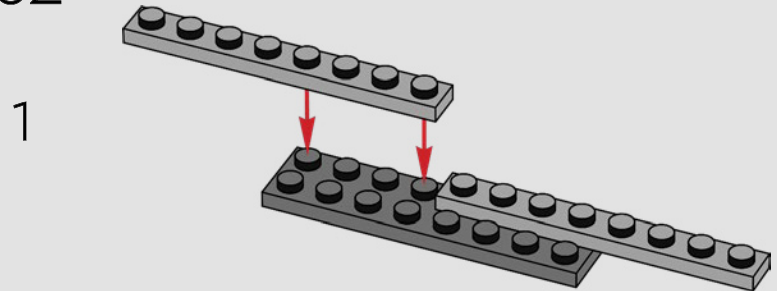

3

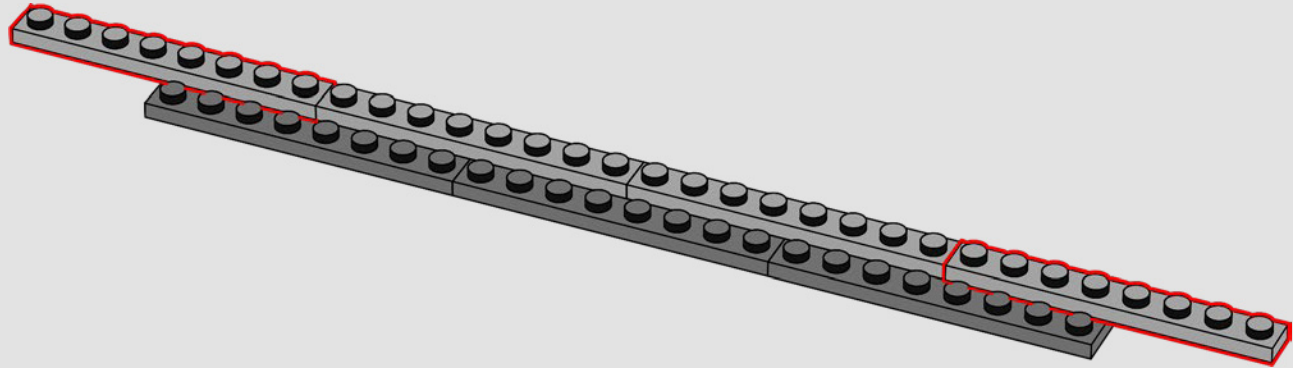

4

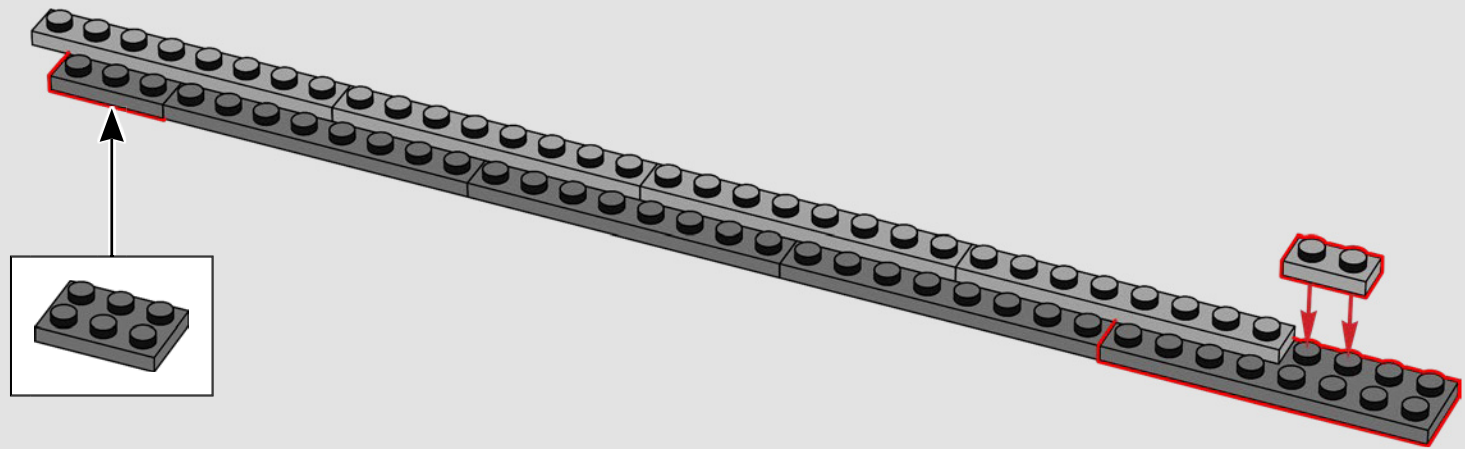

4X

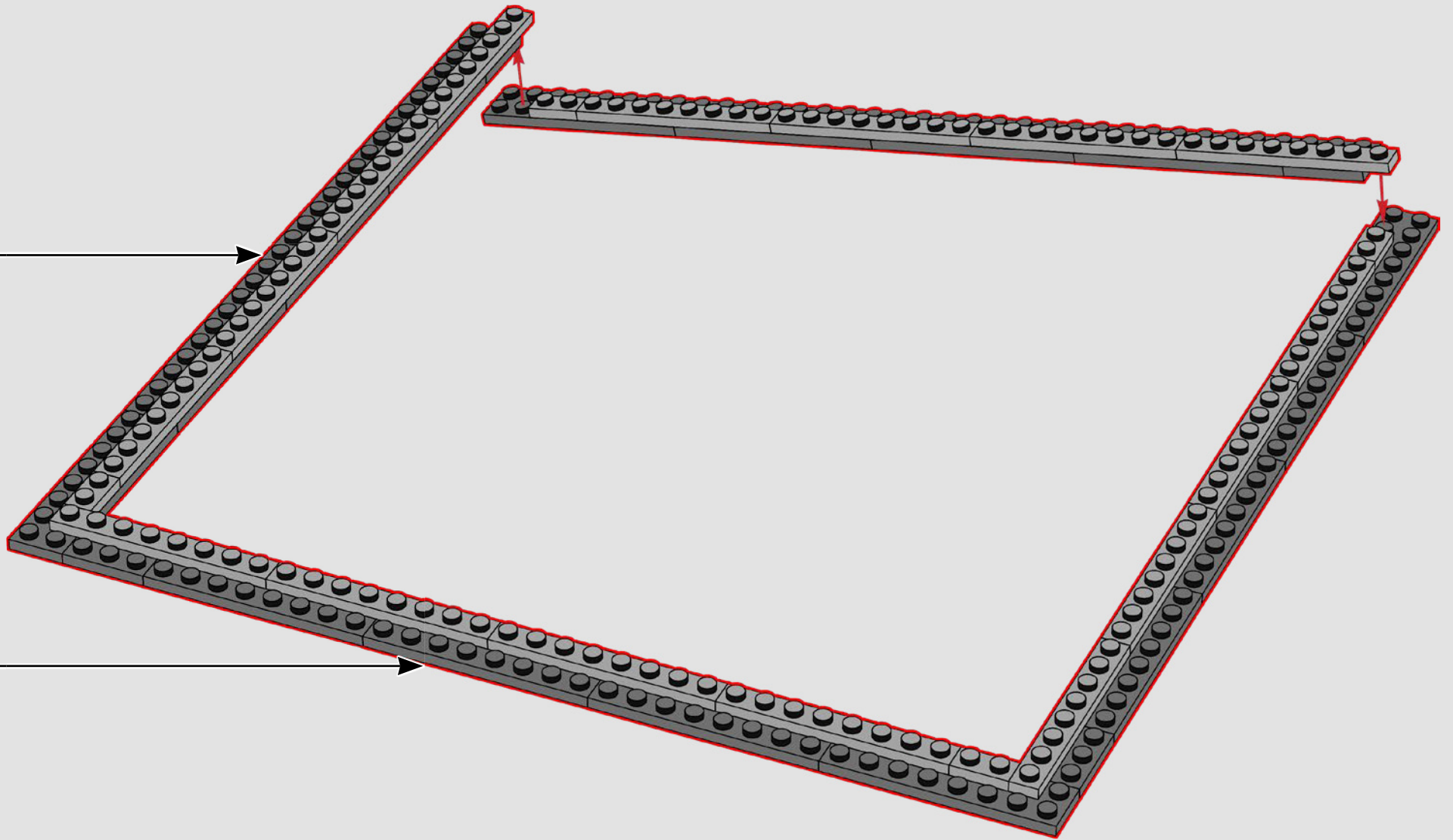



263

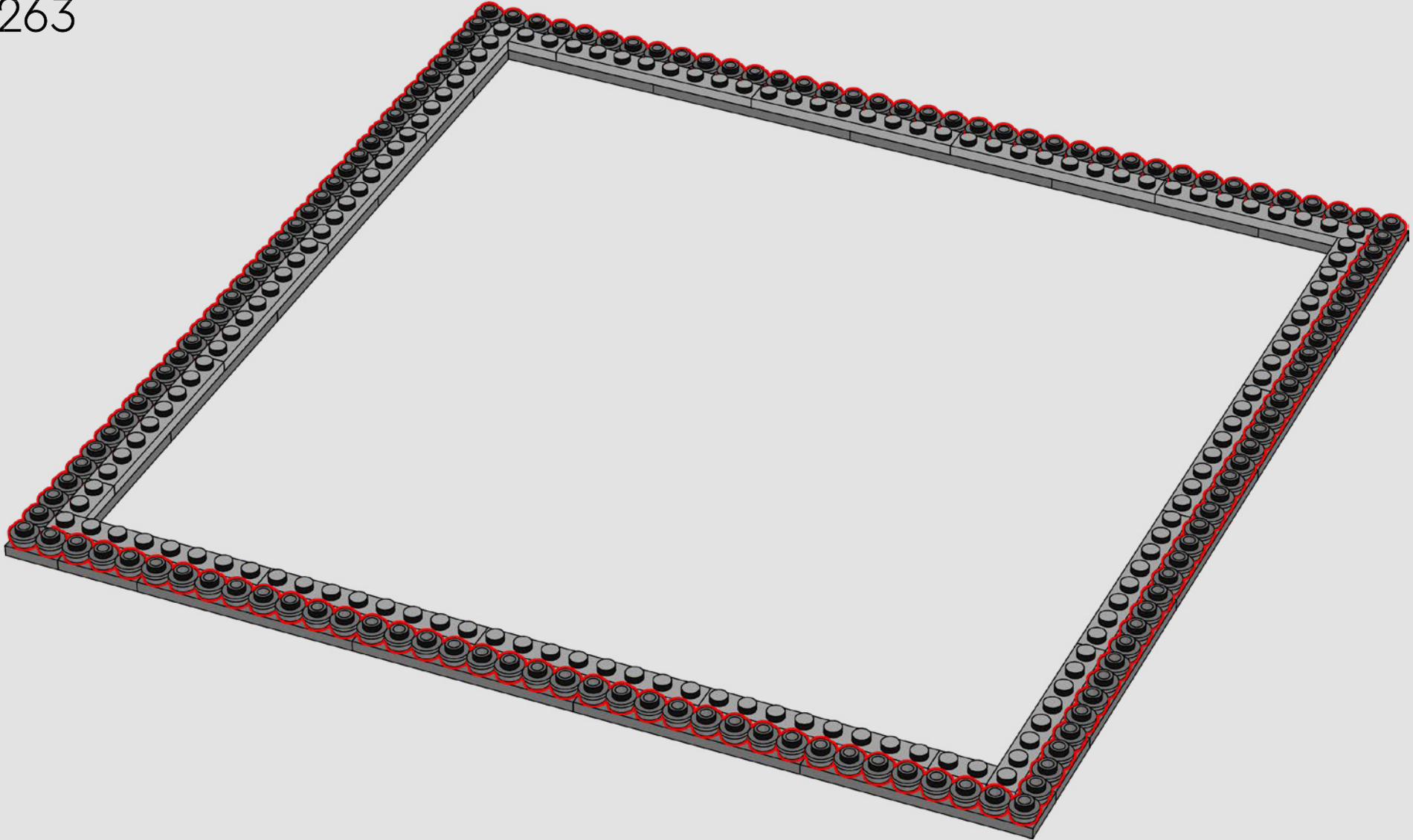



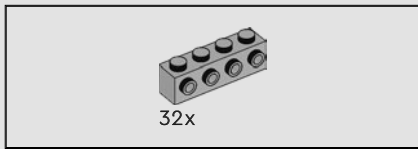

264

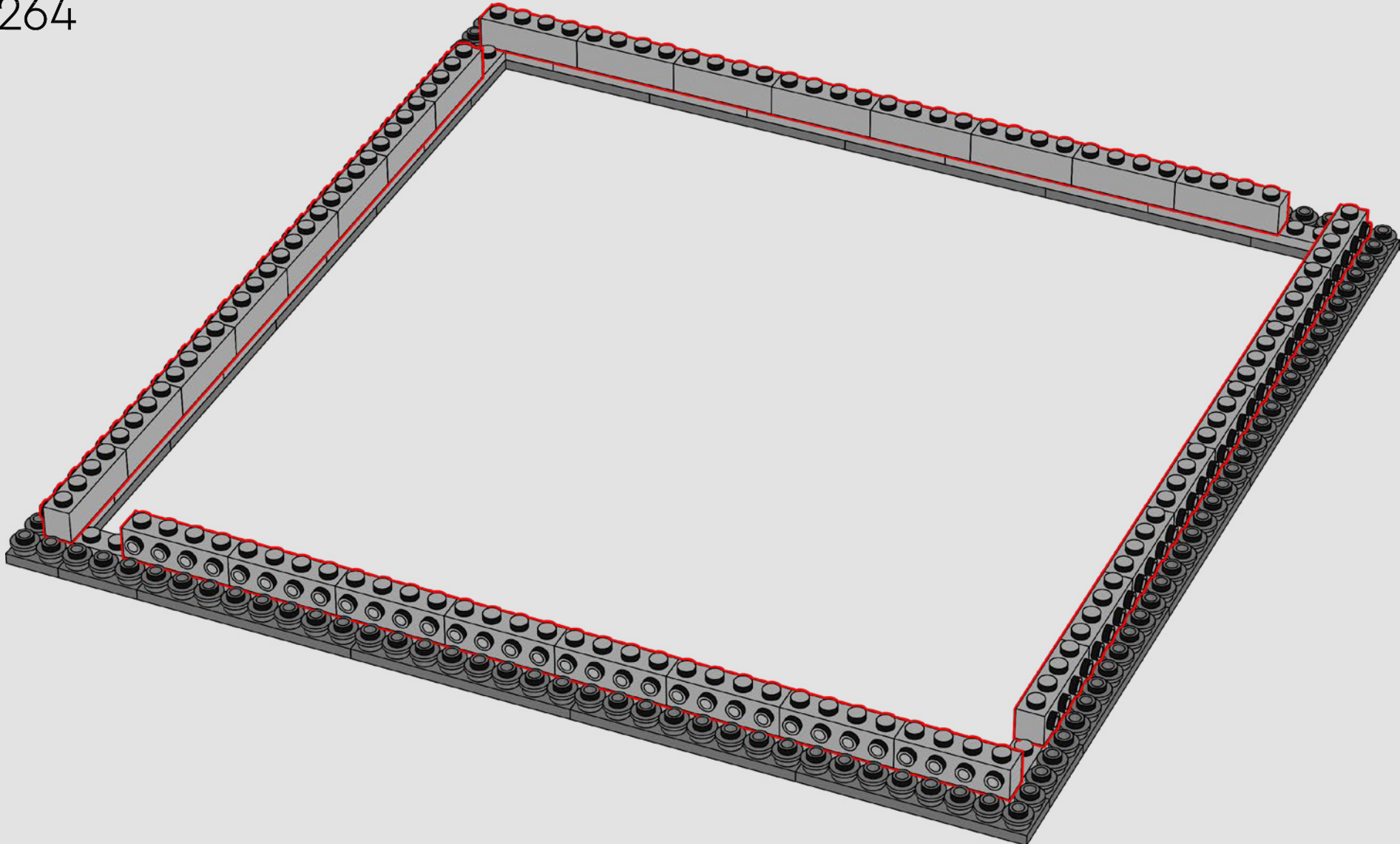



4x

265

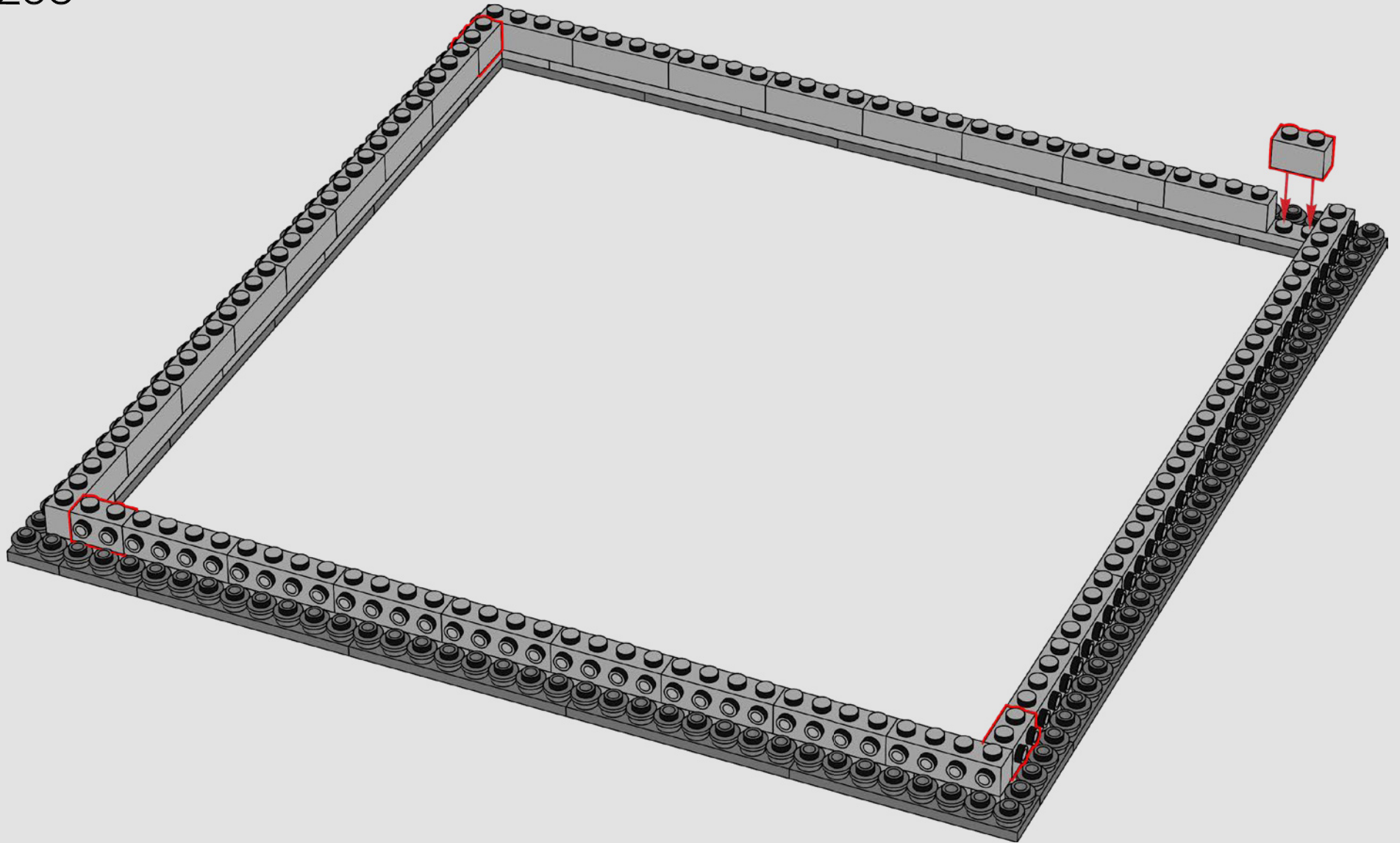

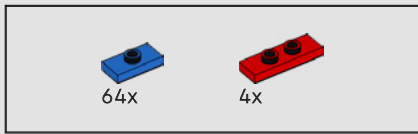

266

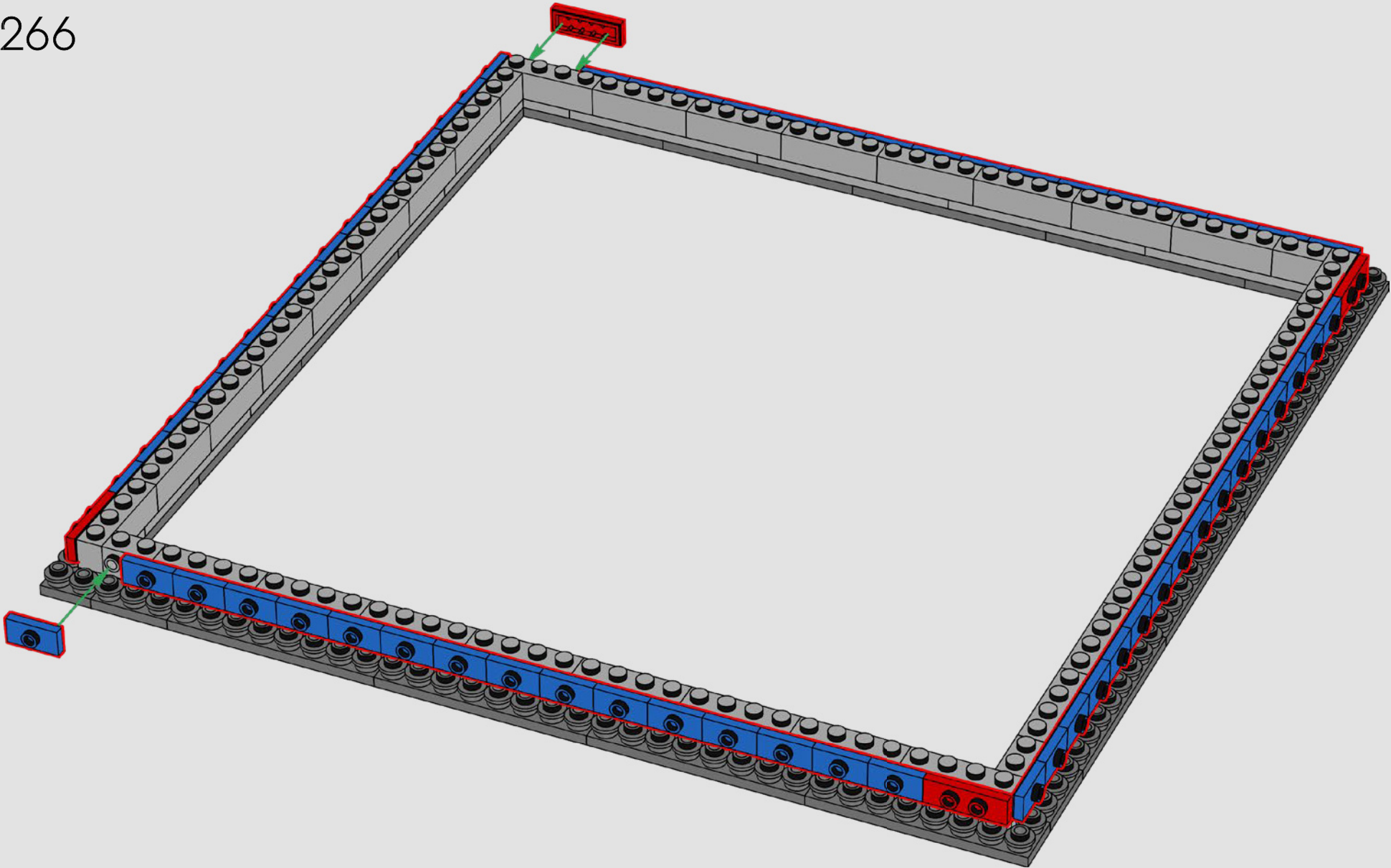

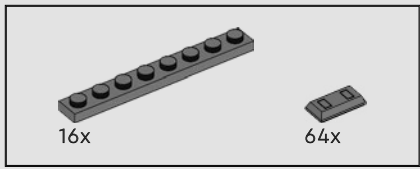

267

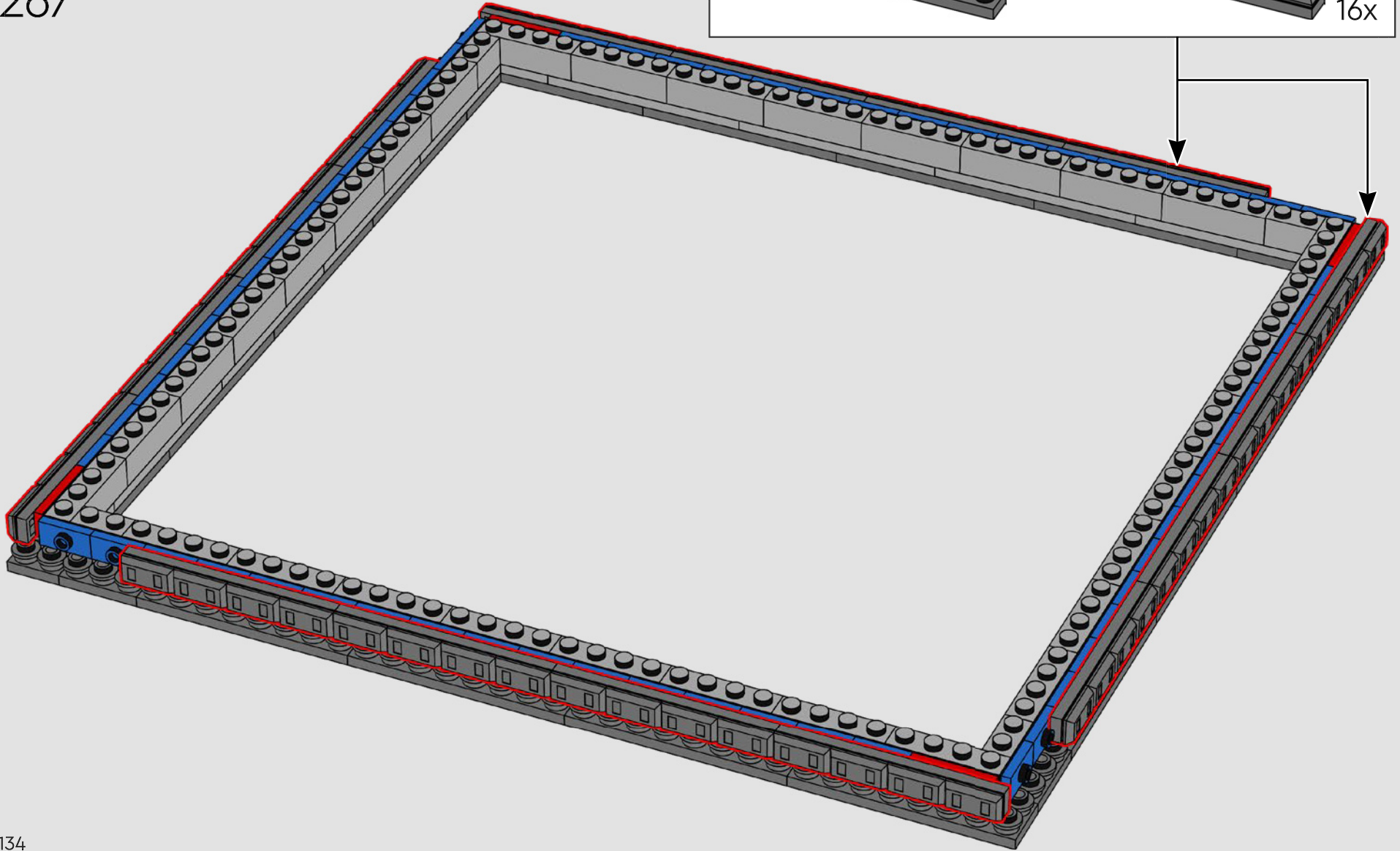
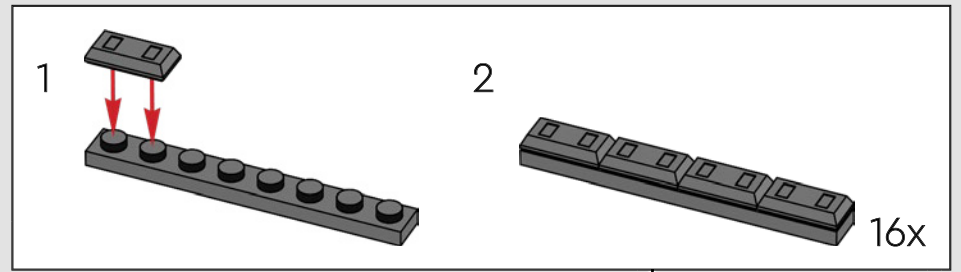

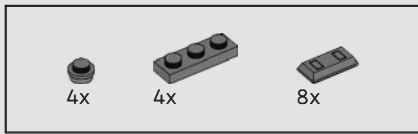

268

Gustave Eiffel engraved the names of 72 French scientists, engineers and mathematicians into the tower. On the LEGO® model the names are represented by 72 LEGO Ingot pieces.

Gustave Eiffel a gravé dans la tour les noms de 72 scientifiques, ingénieurs et mathématiciens français. Sur le modèle LEGO®, les noms sont représentés par 72 pièces de lingot LEGO.

Gustave Eiffel grabó los nombres de 72 científicos, ingenieros y matemáticos franceses en la torre. En el modelo LEGO®, los nombres se representan usando 72 lingotes LEGO.

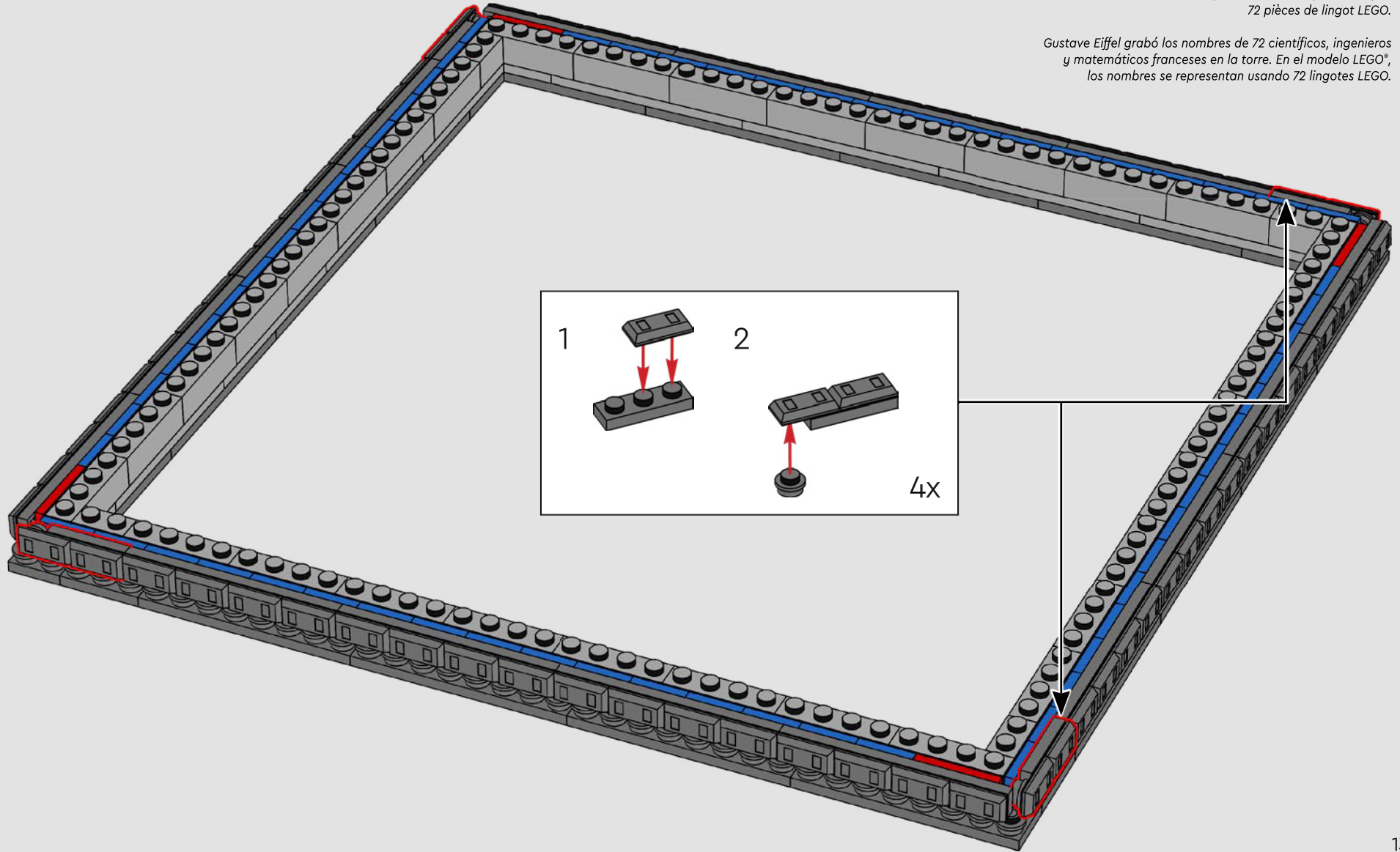

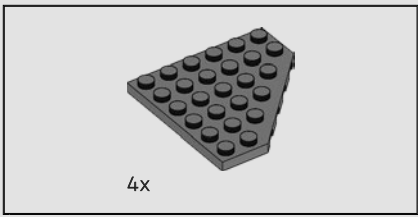

269

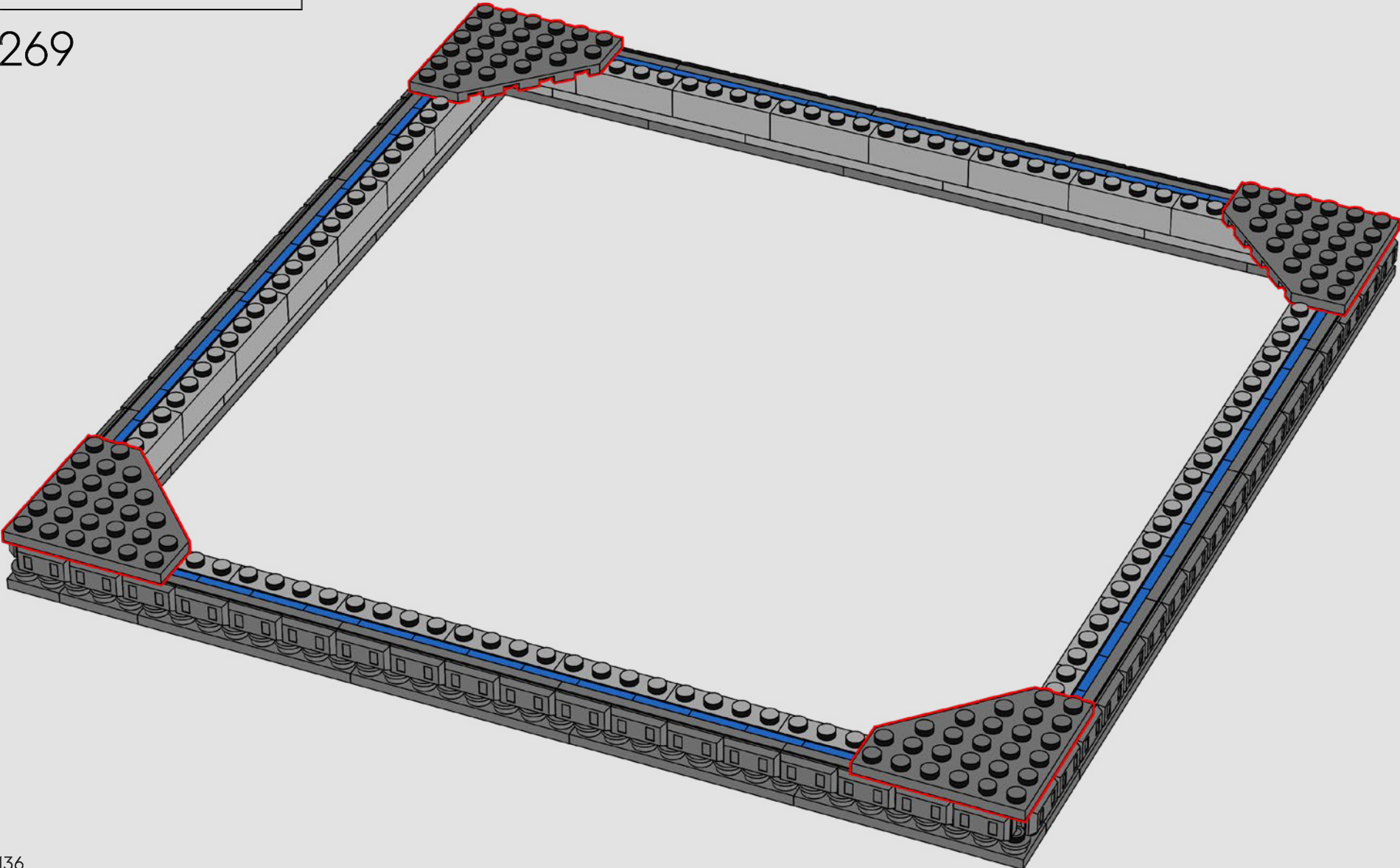

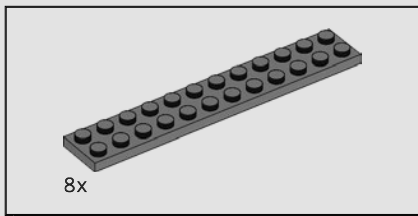

270

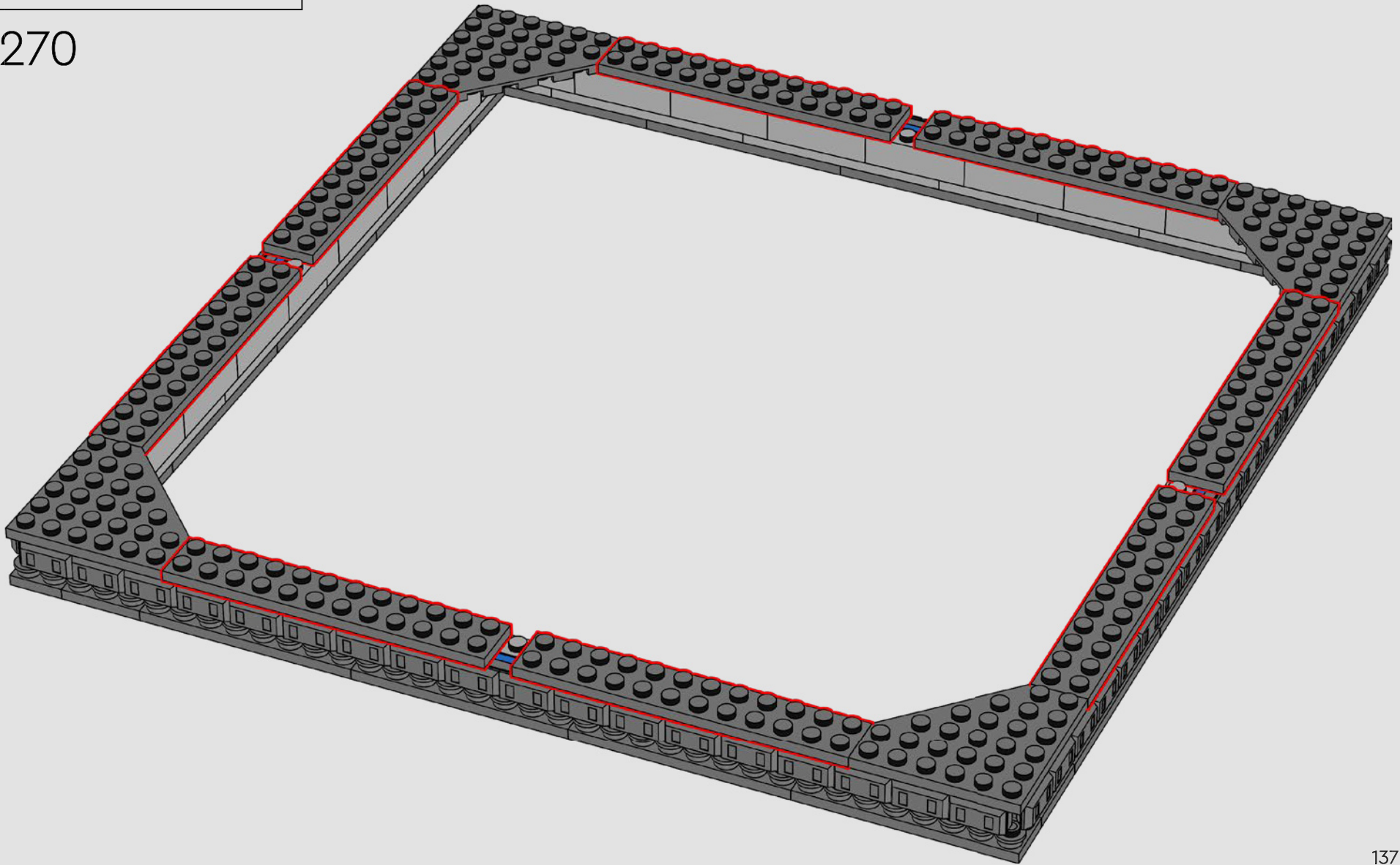



4x

271

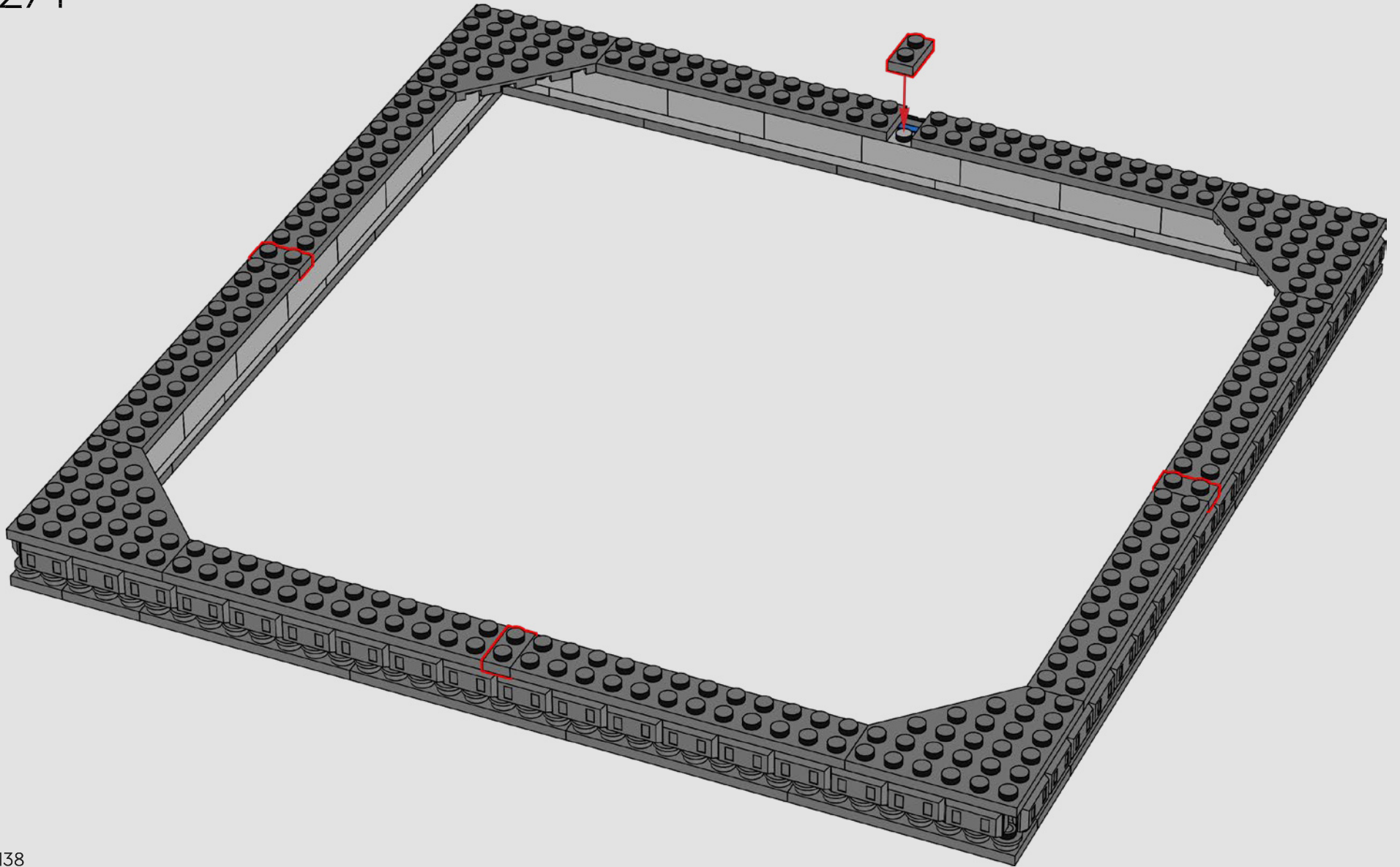

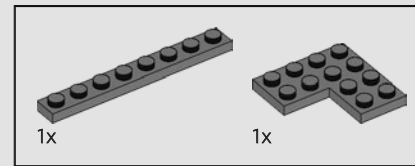
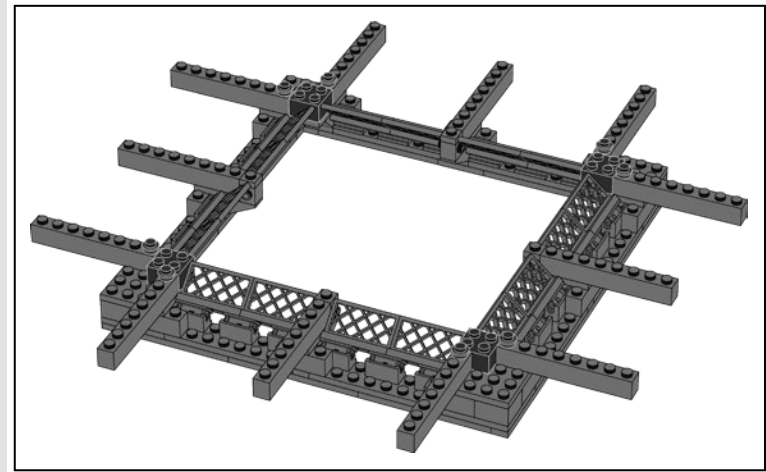

272

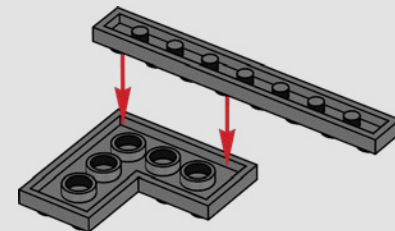

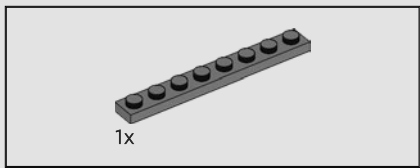

273

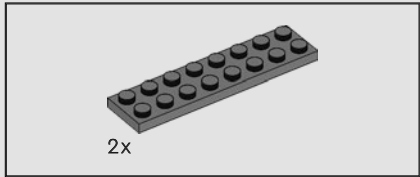
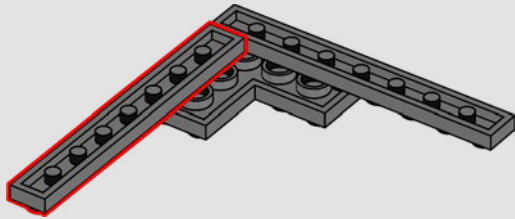

274

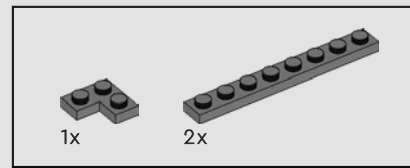
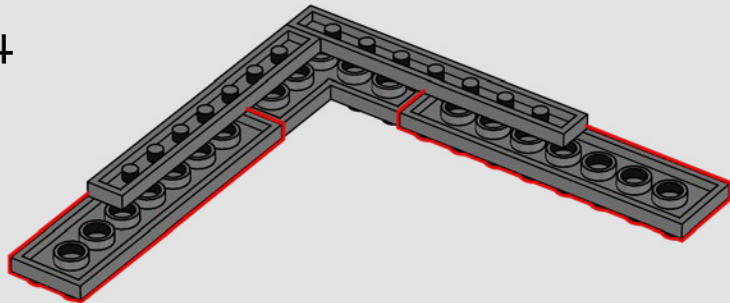

275

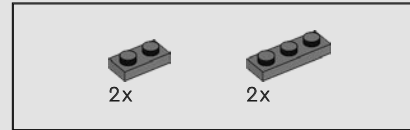
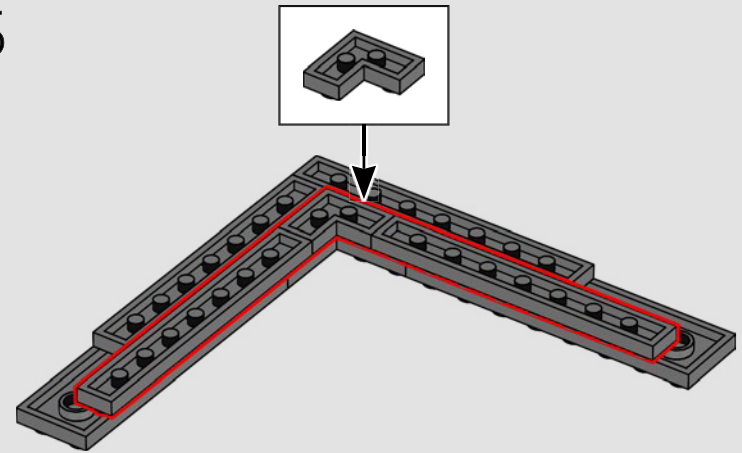

276

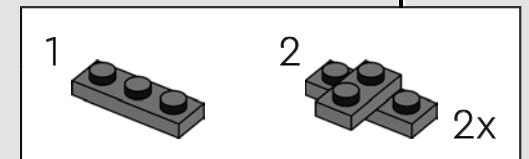
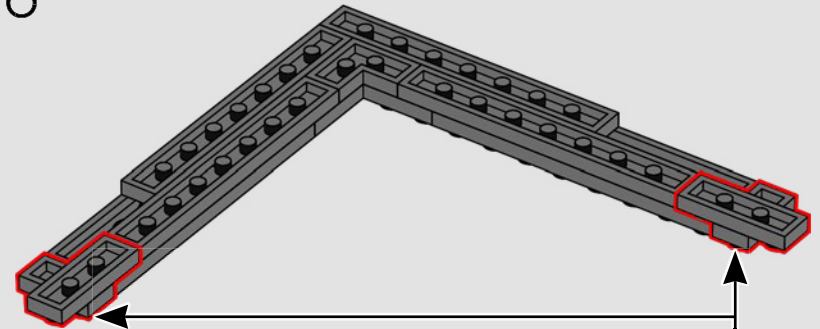

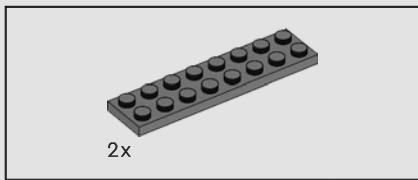

277

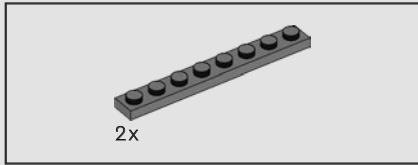
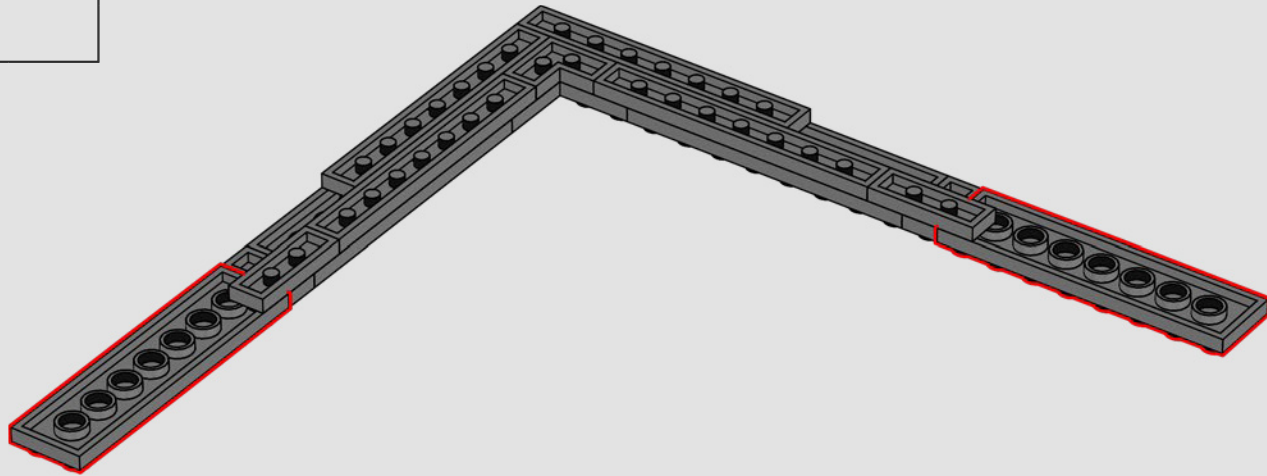

278

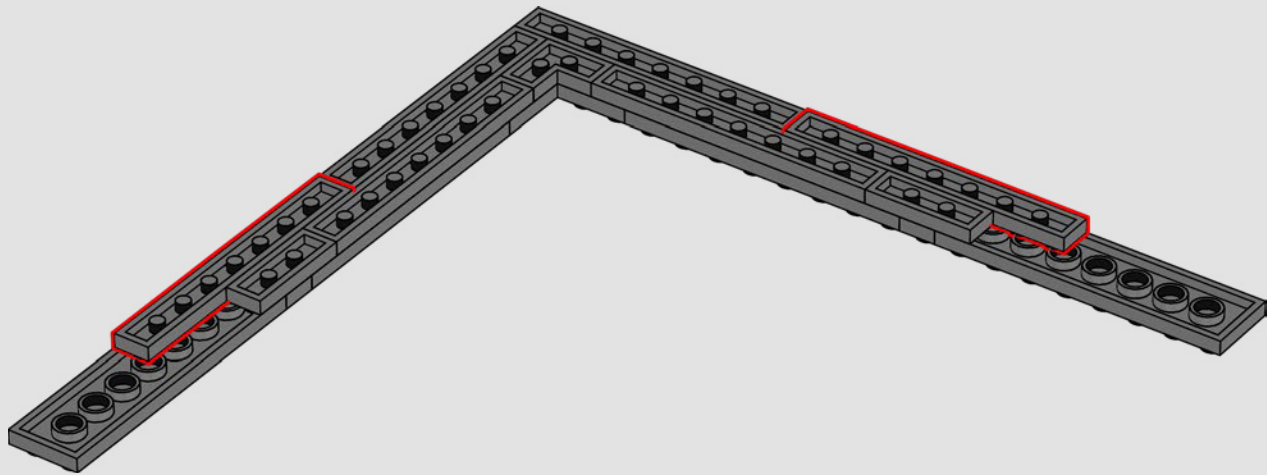

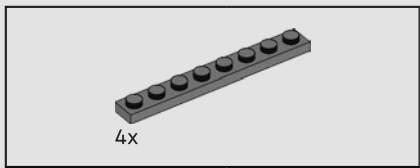

279

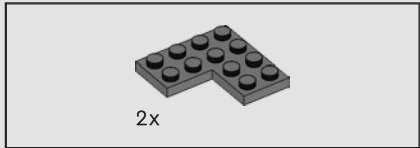
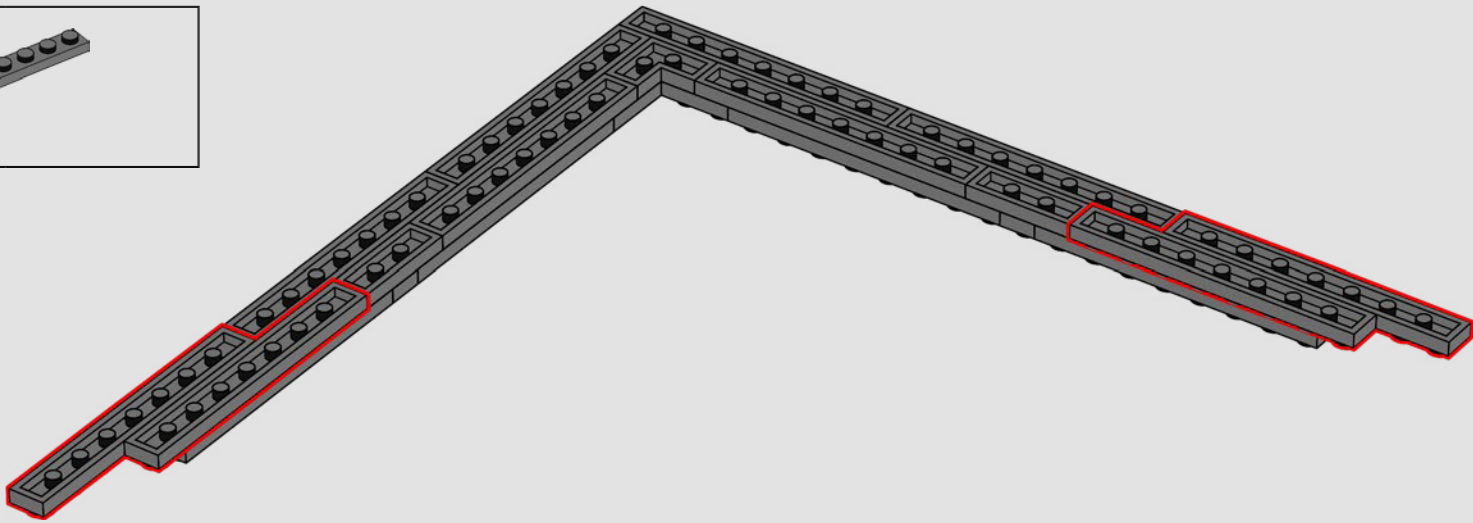

280

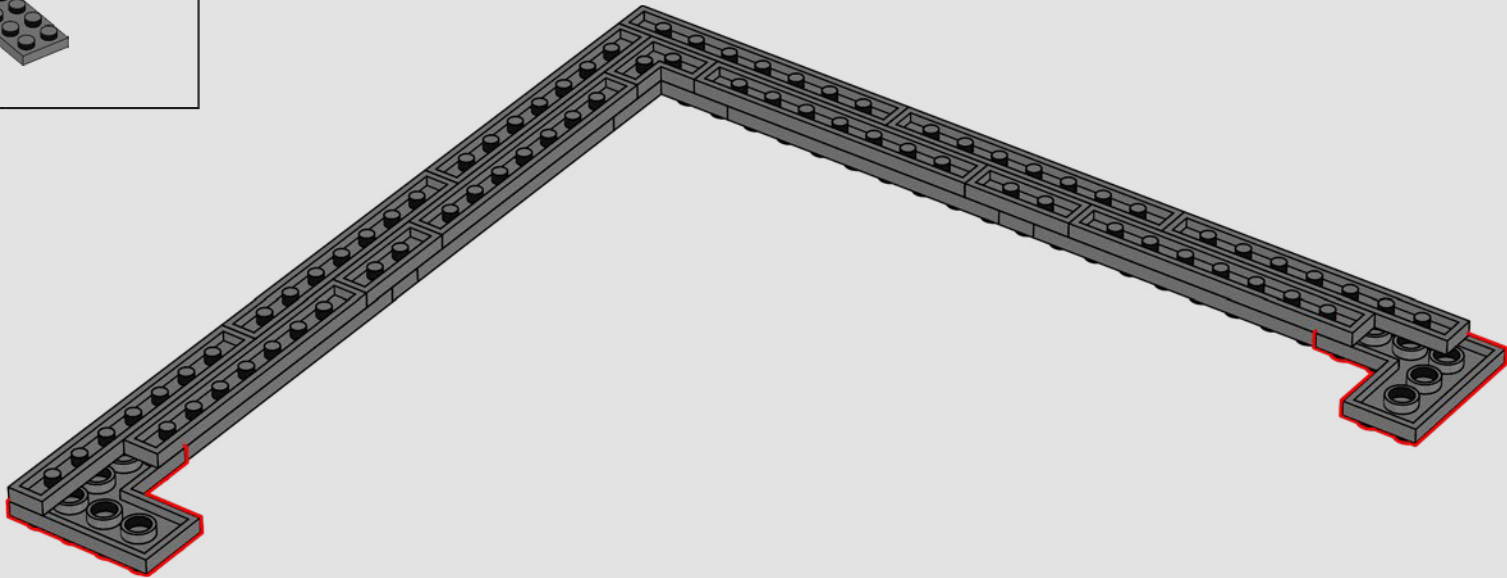

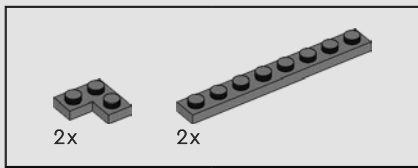

281

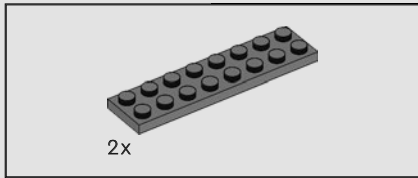
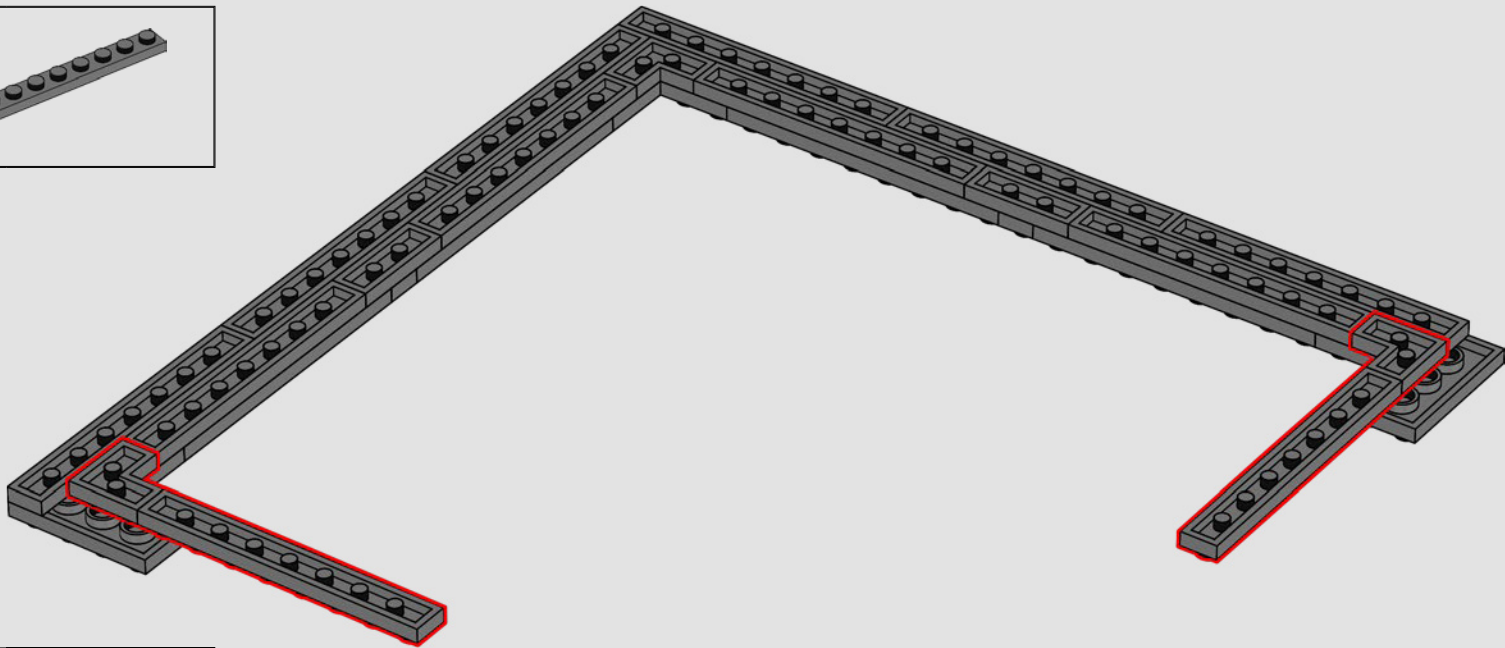

282

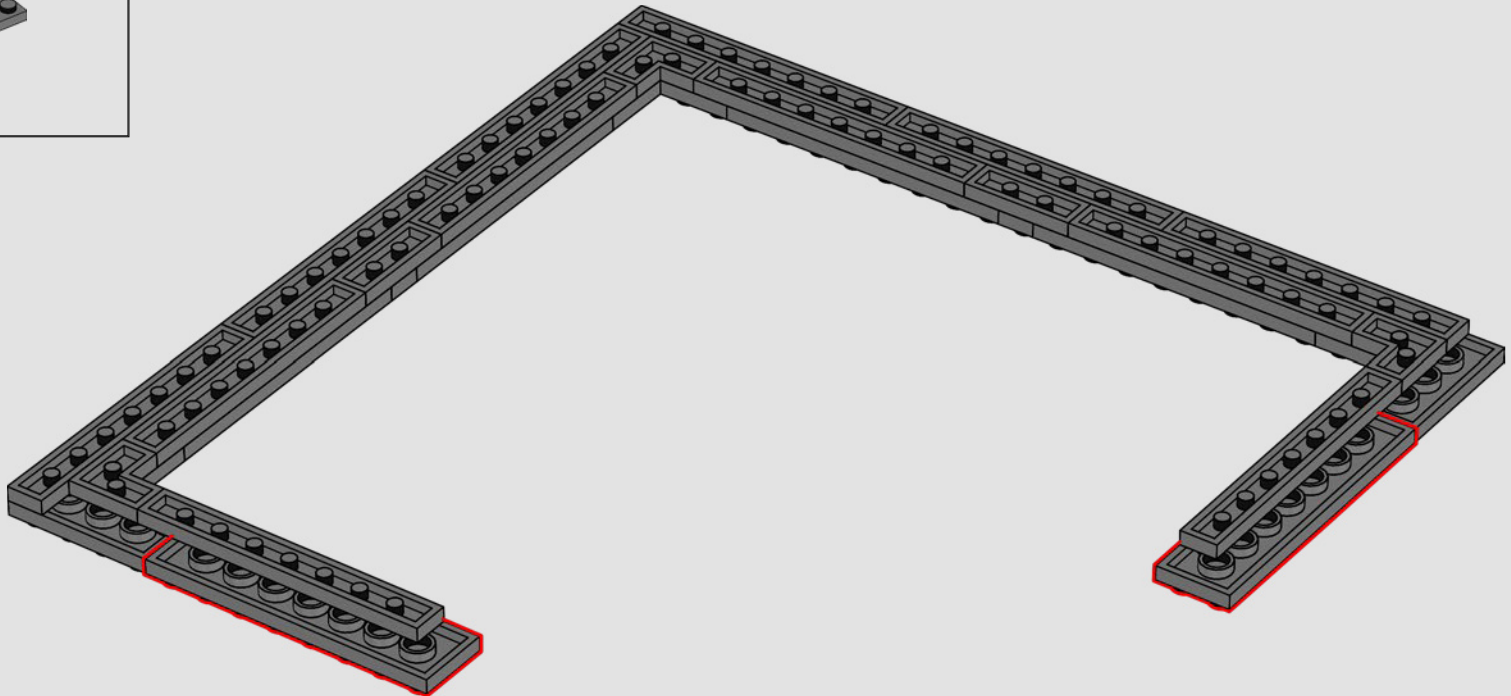

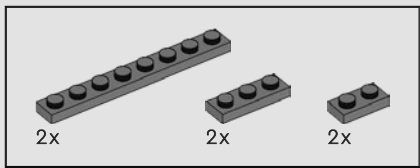

283

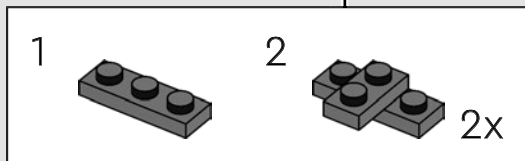
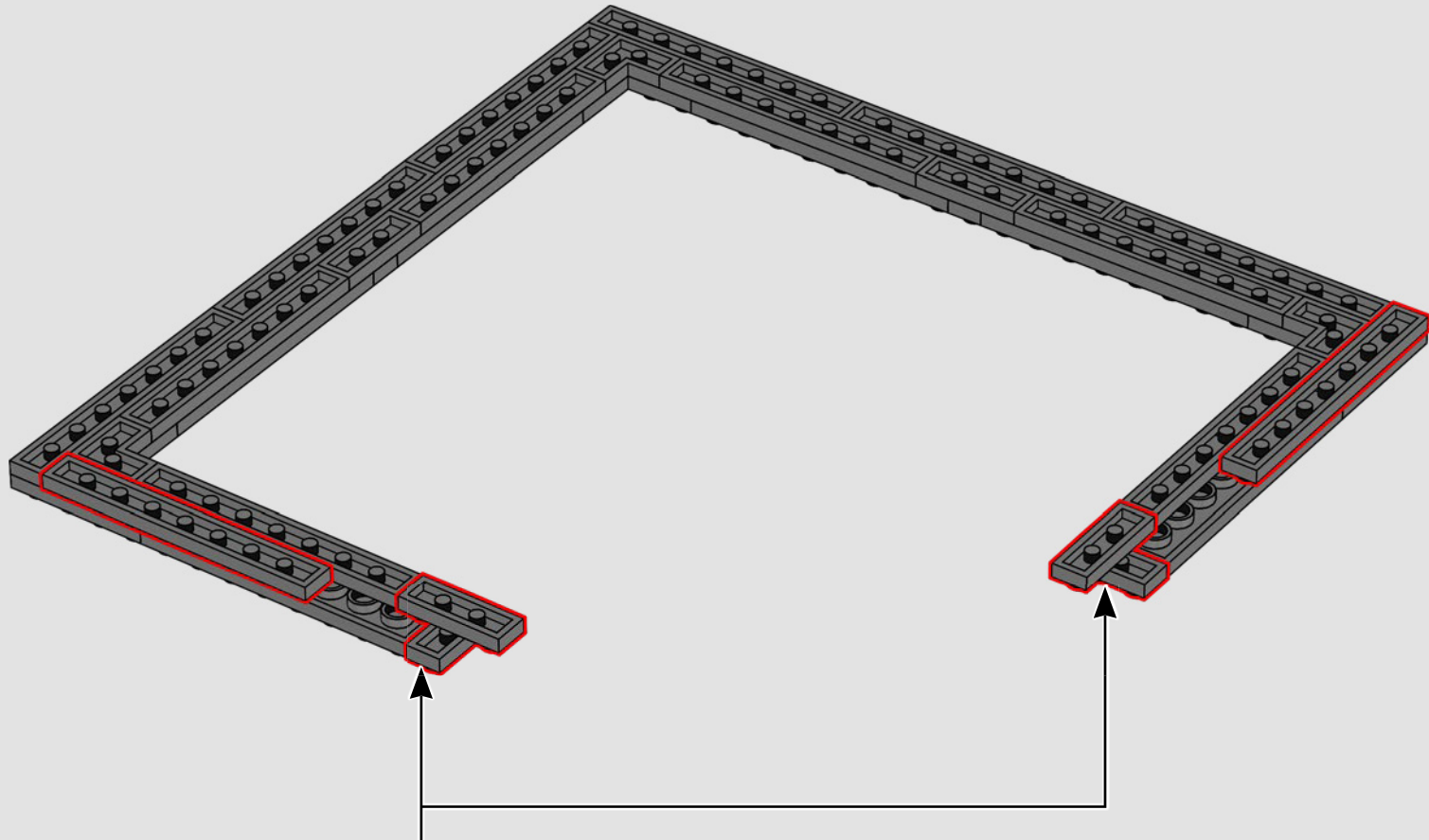

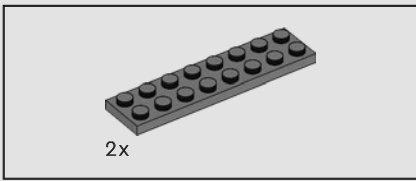

284

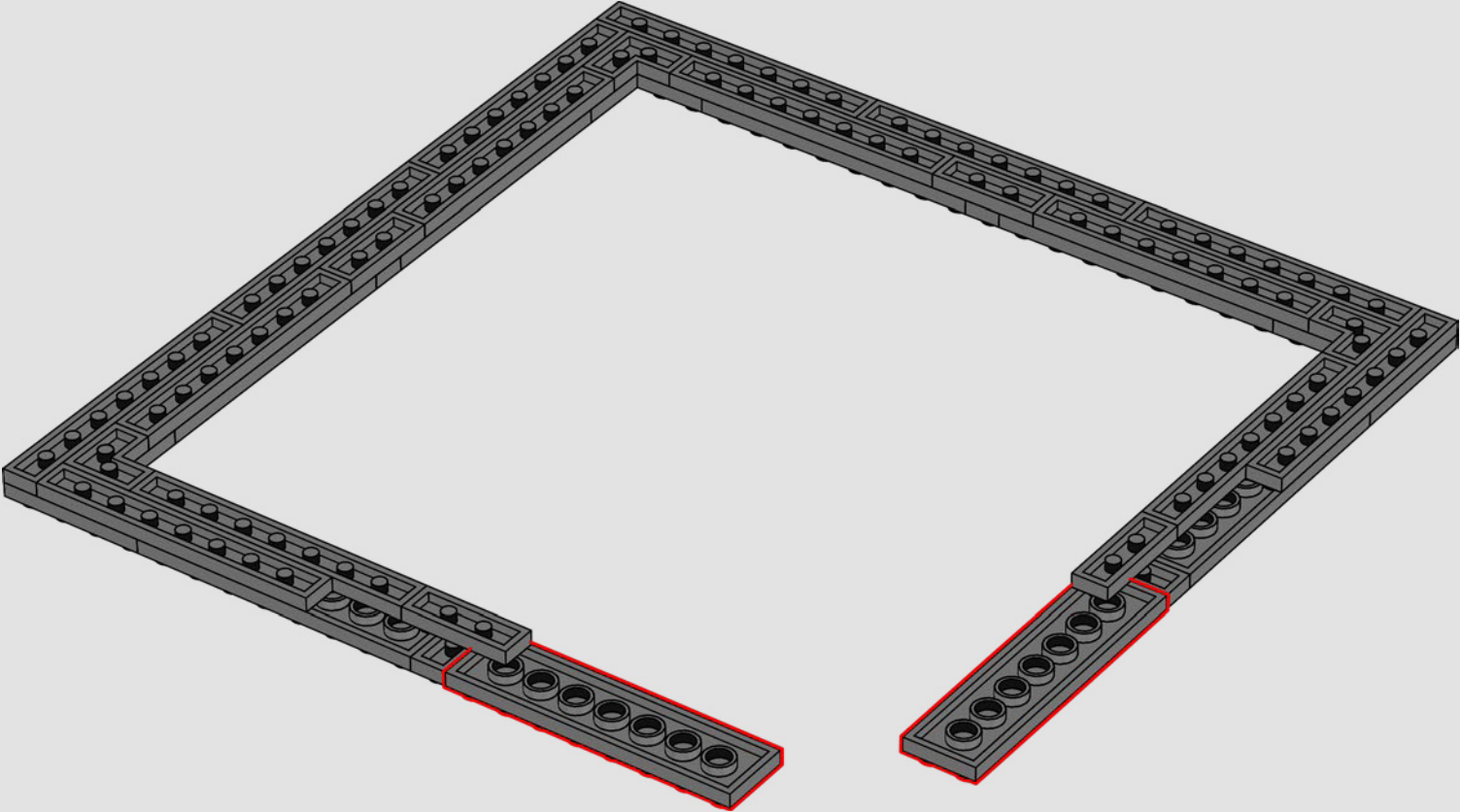

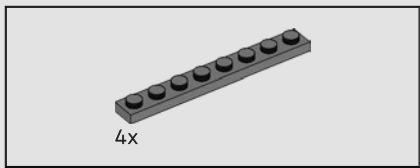

285

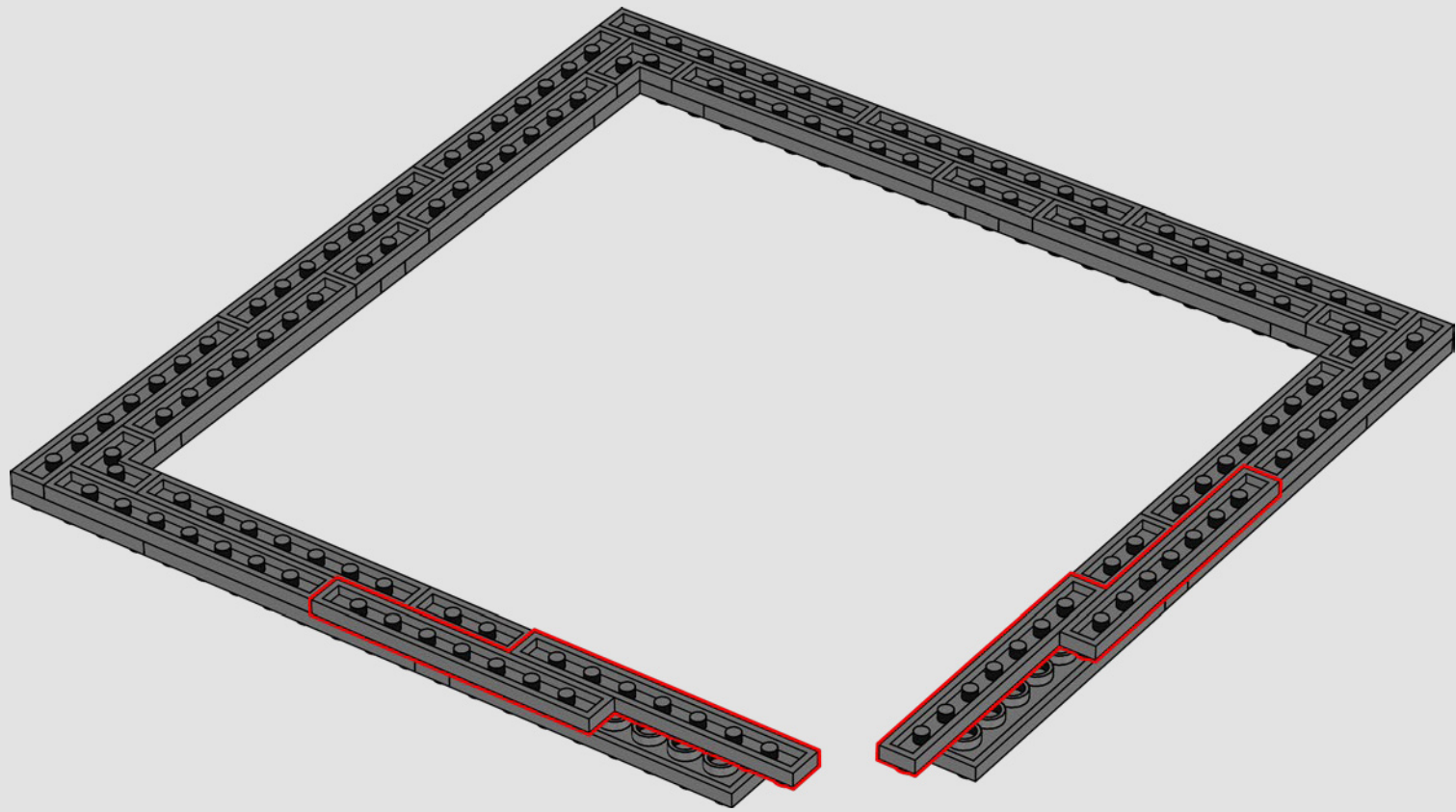

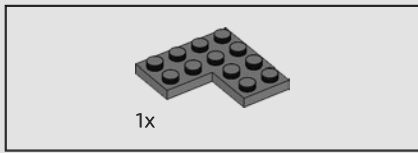

286

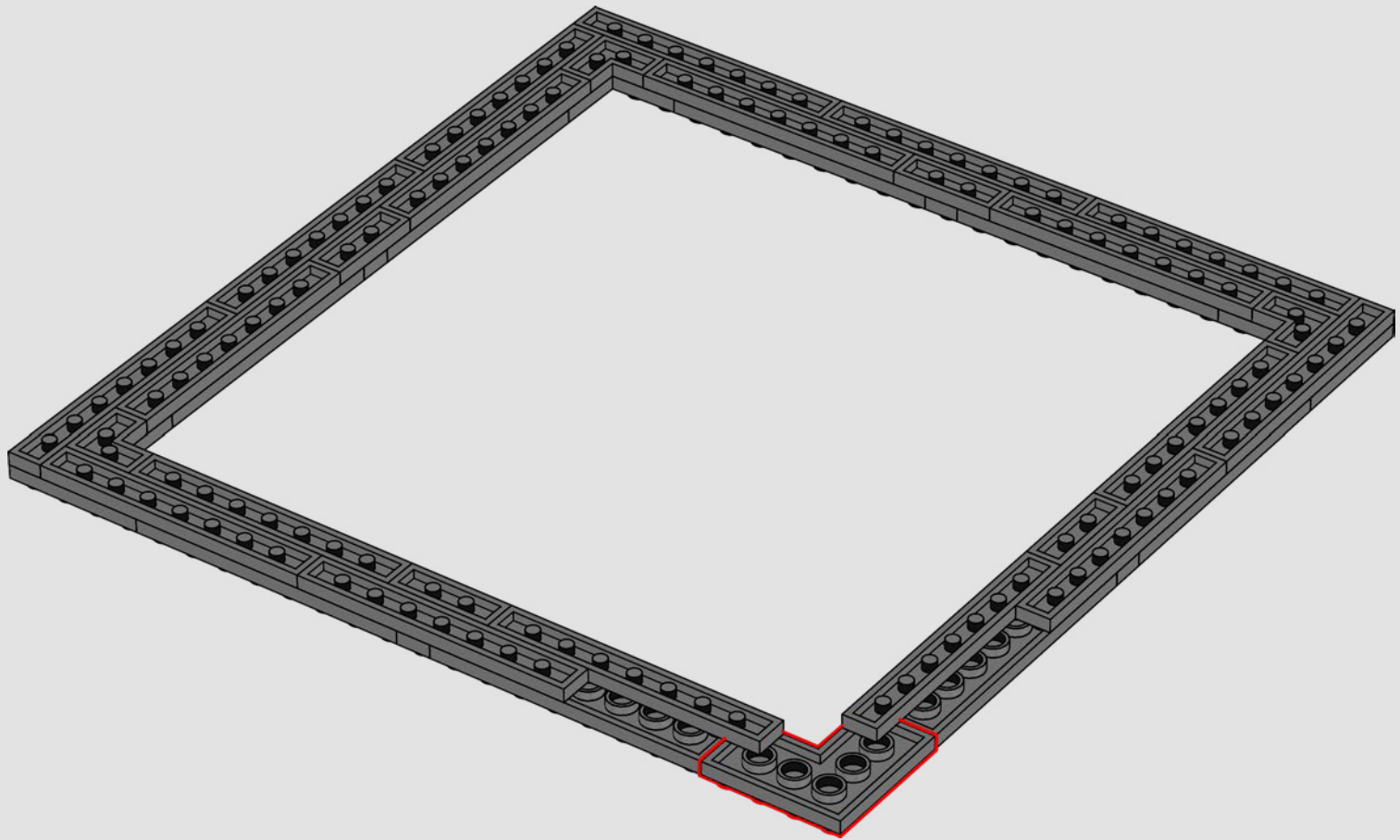

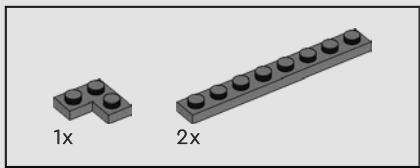

287

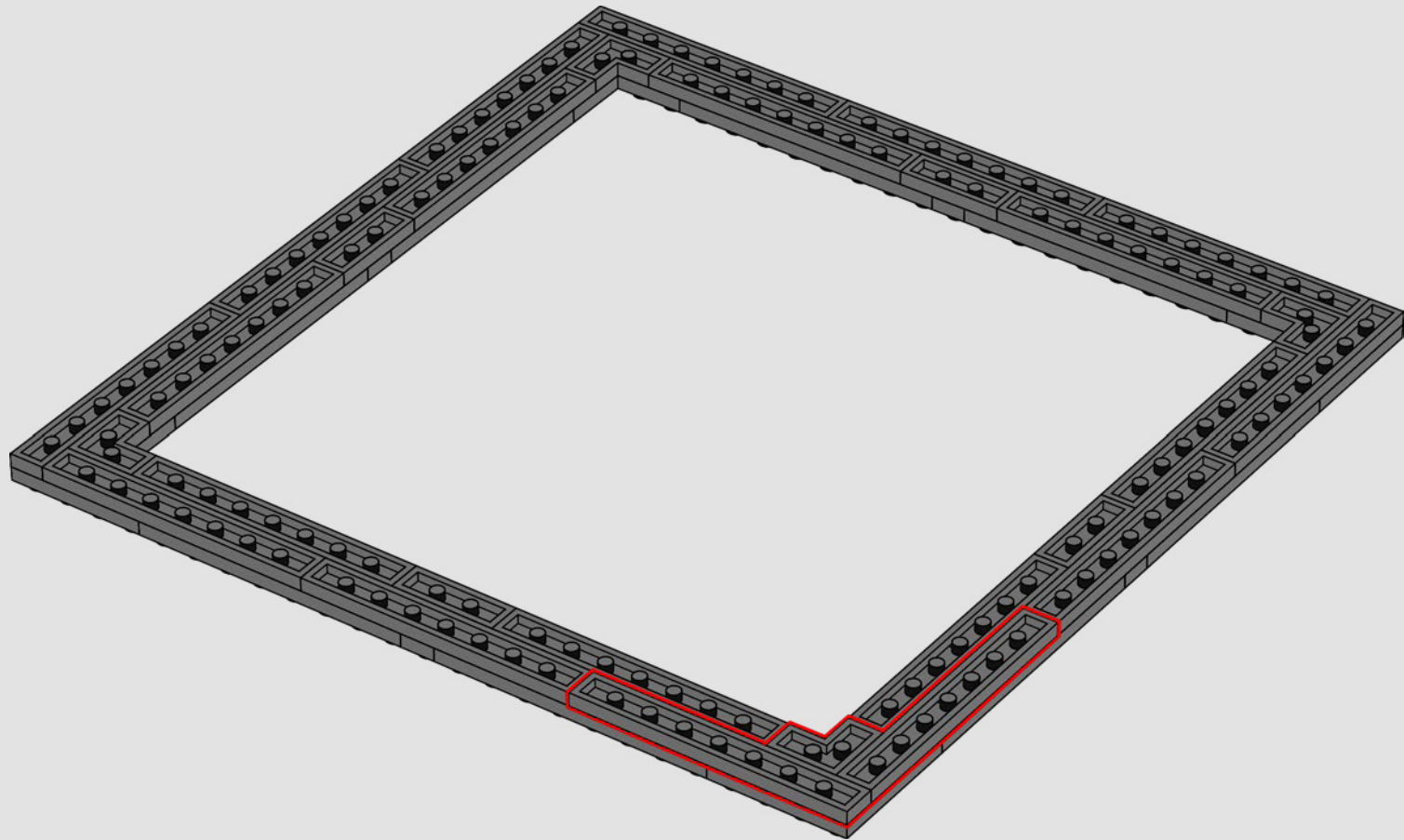

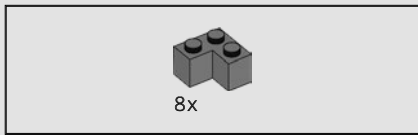

288

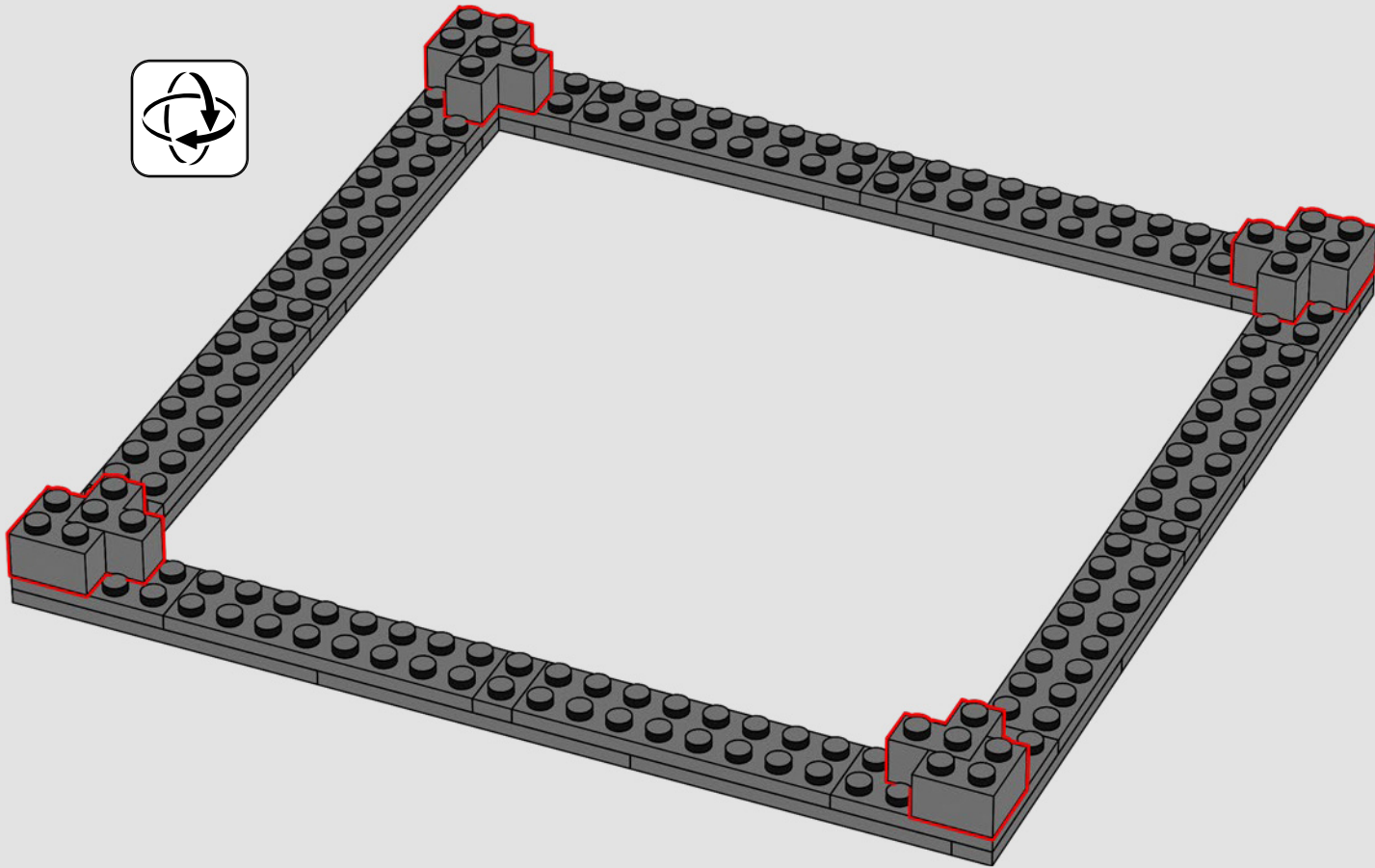



8x

289

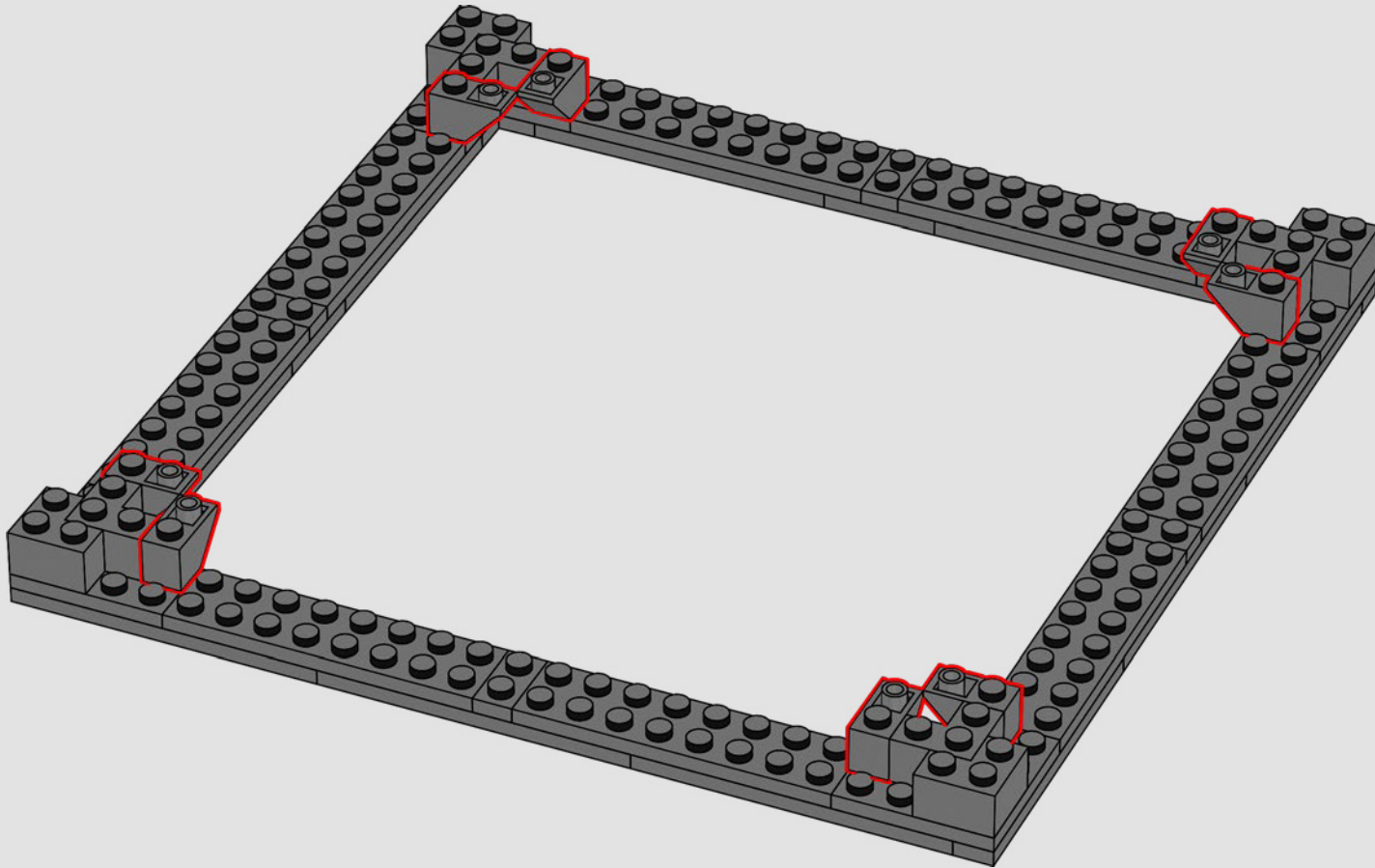

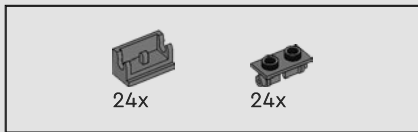

290

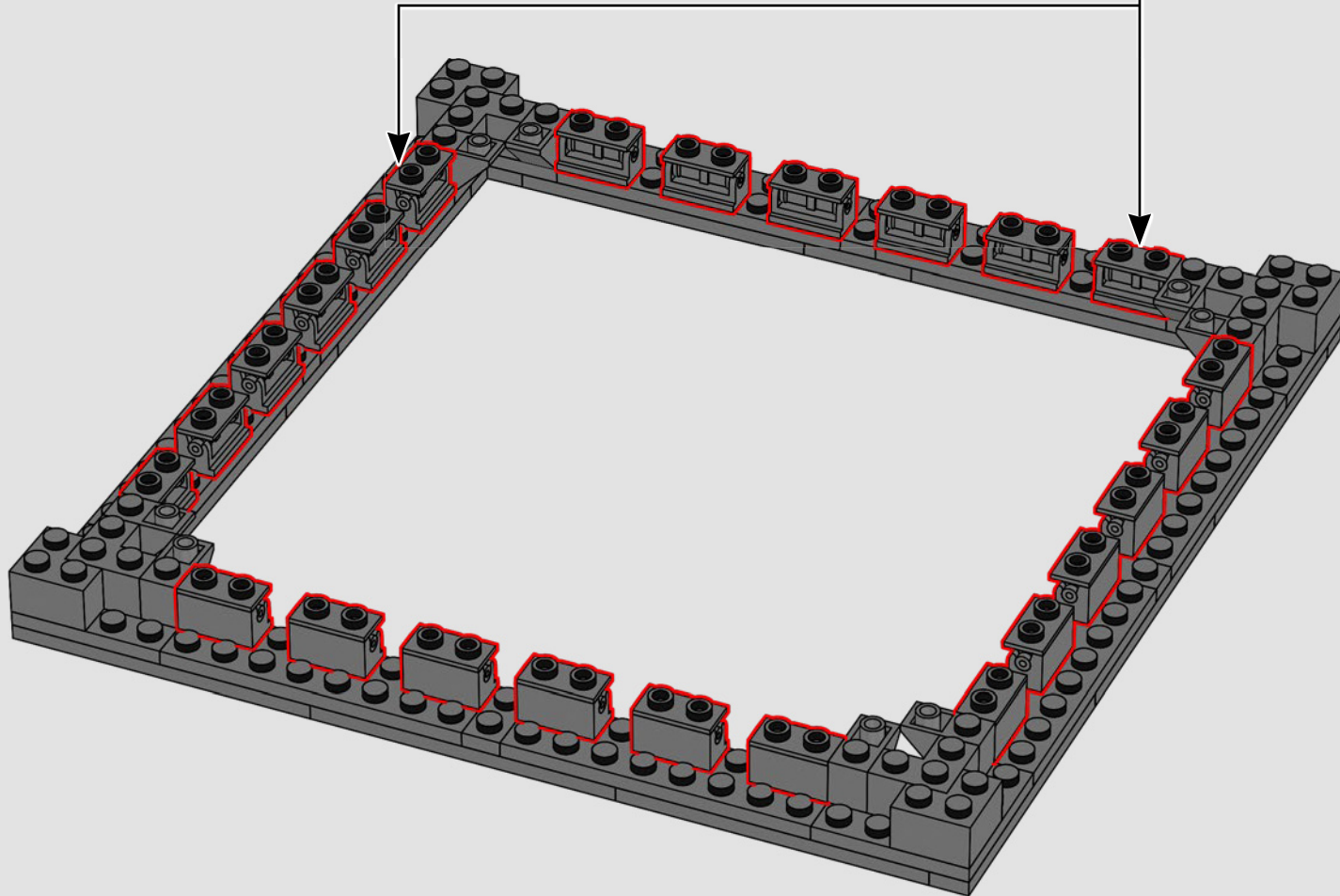
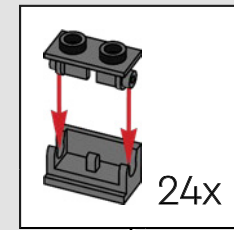

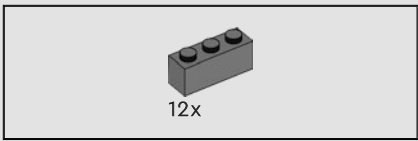

291

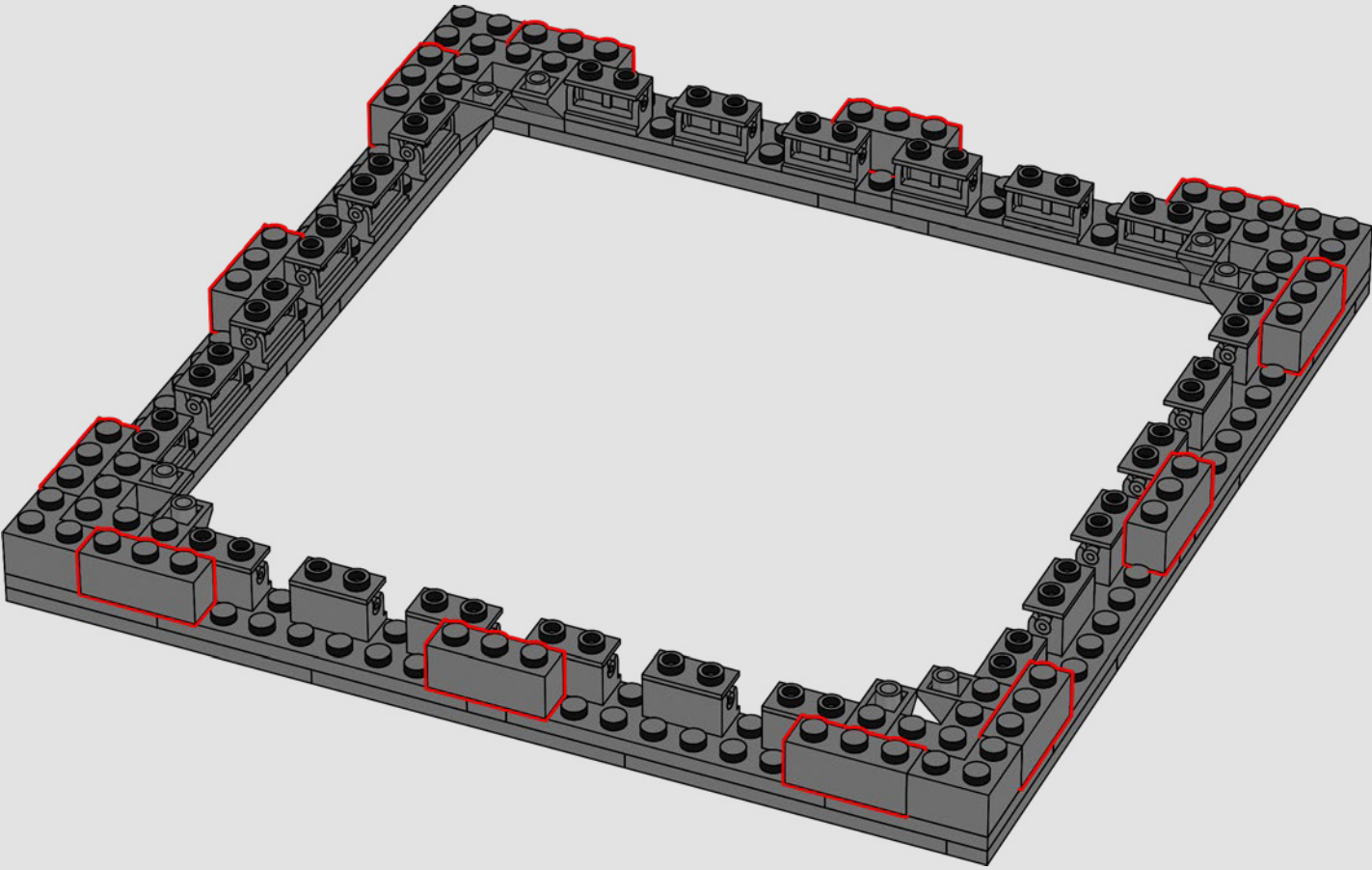

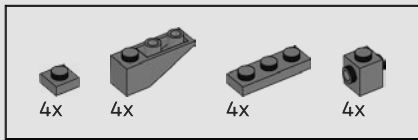

292

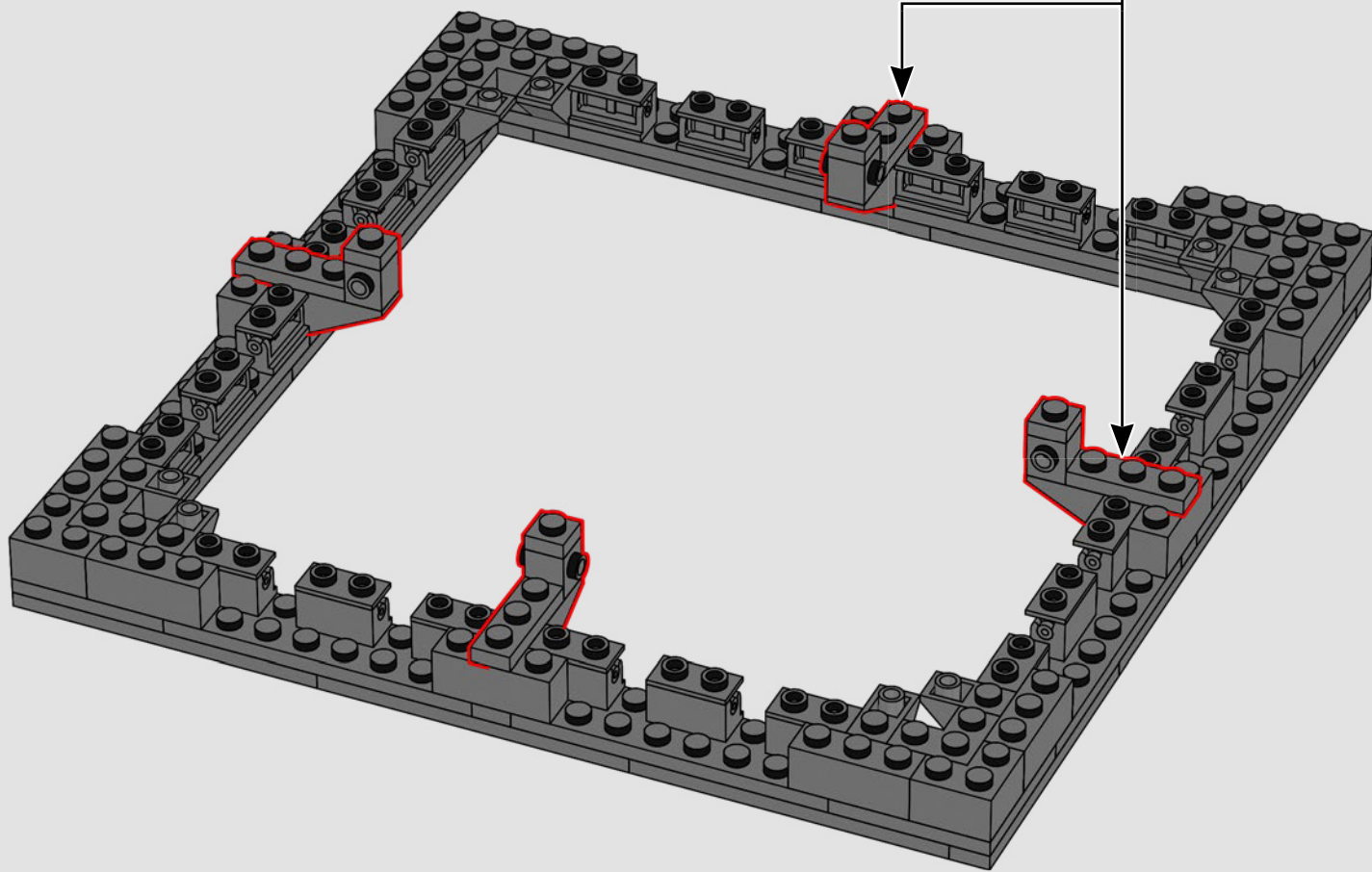
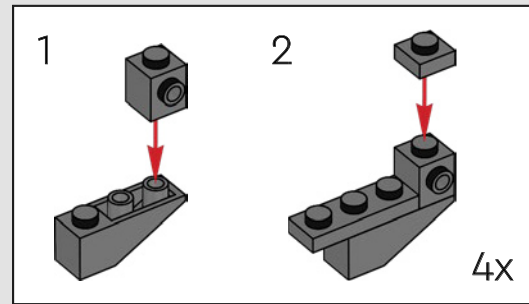

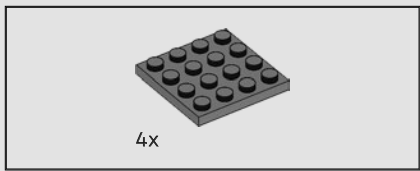

293

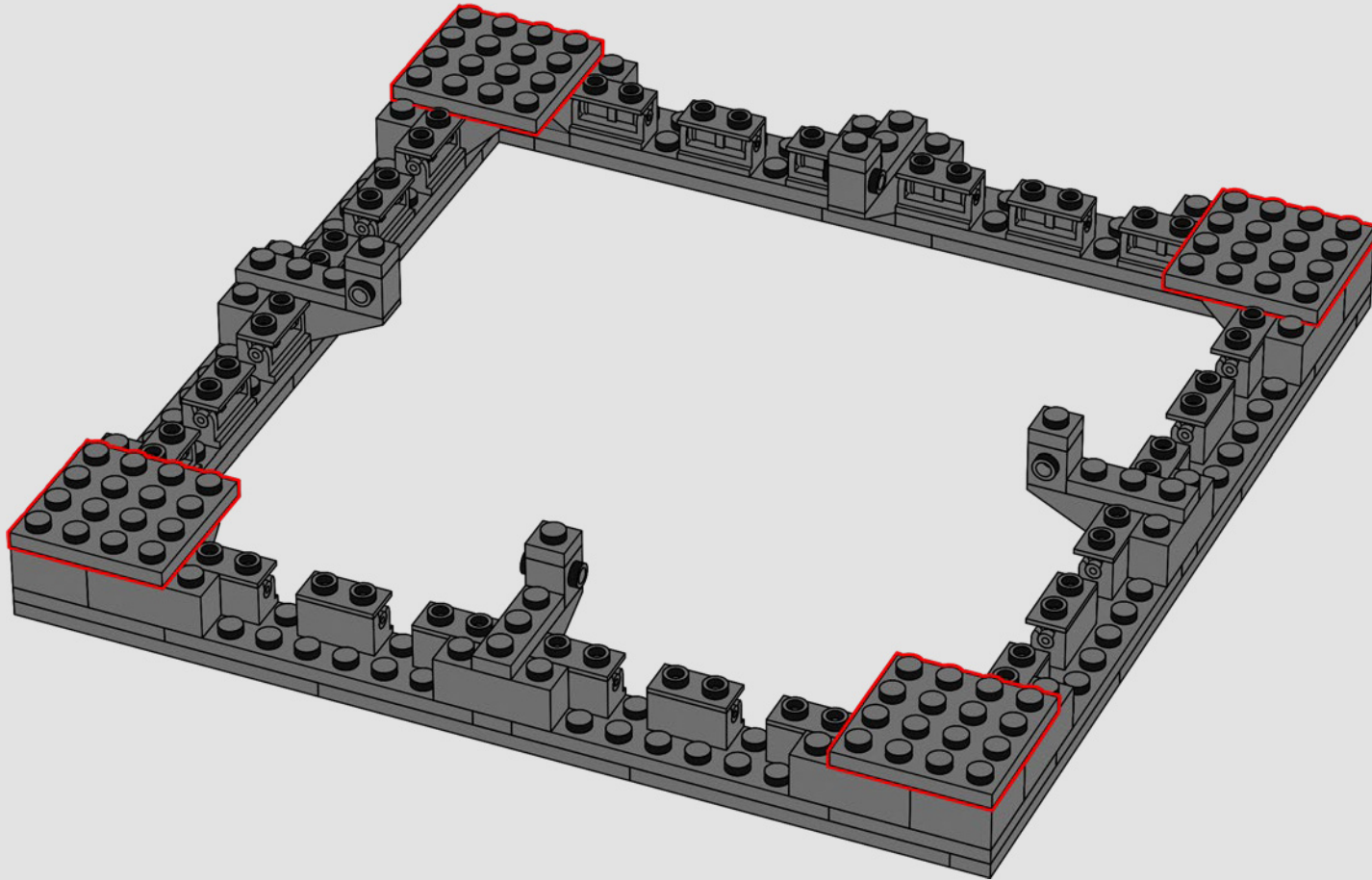

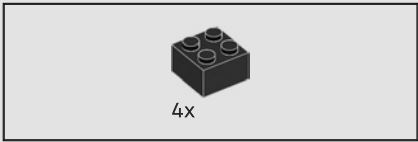

294

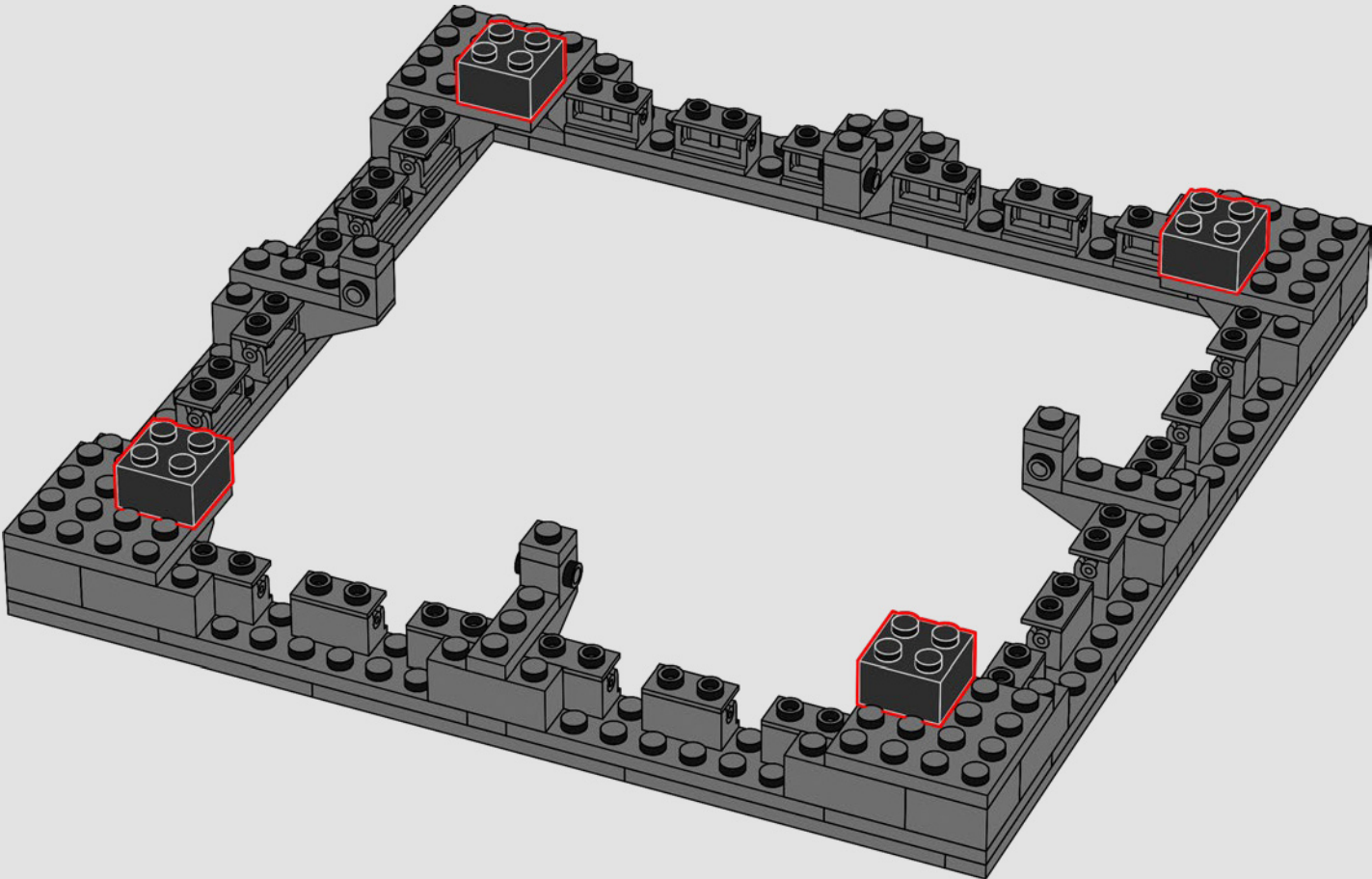

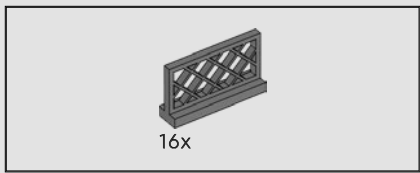

295

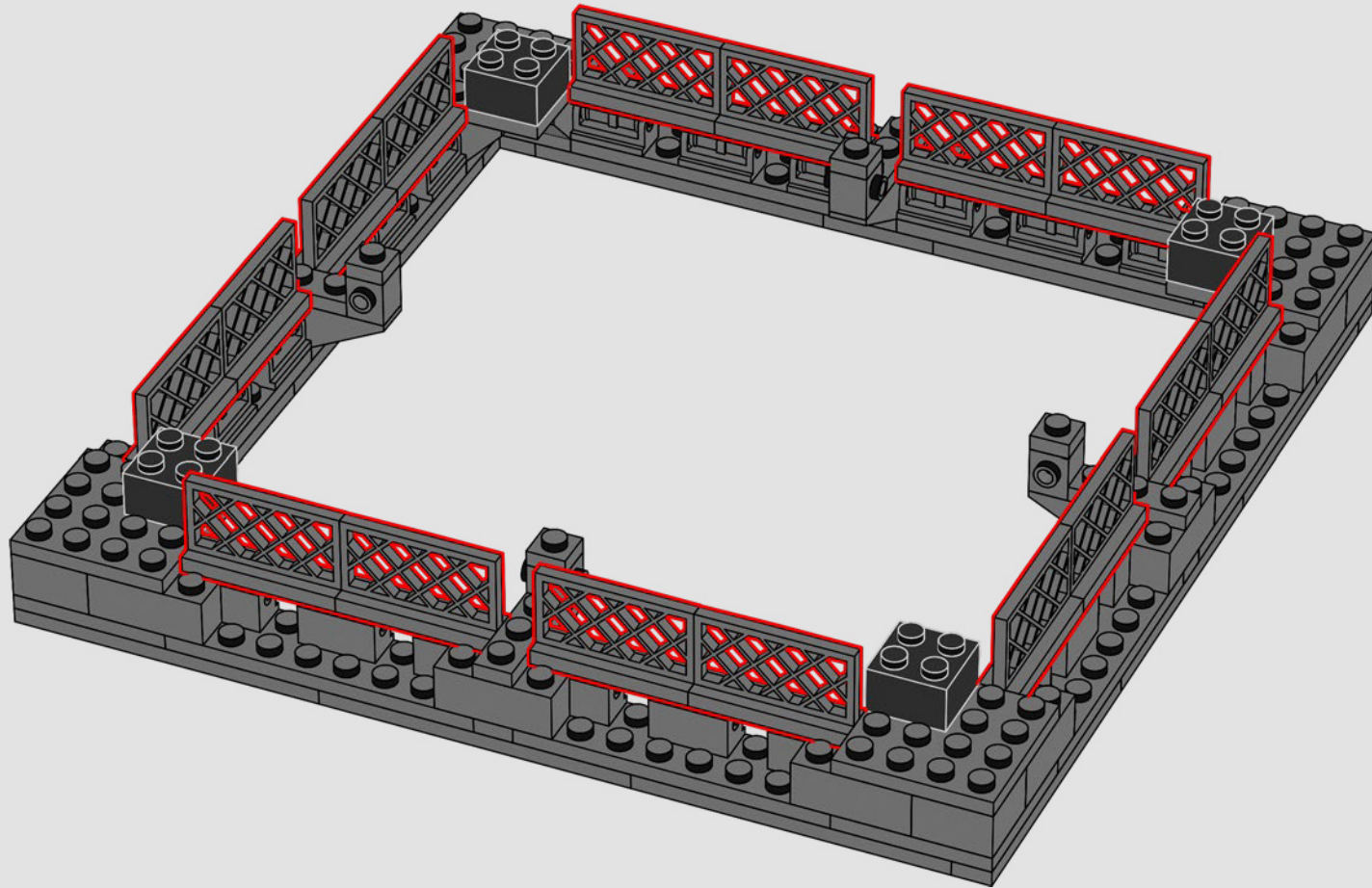

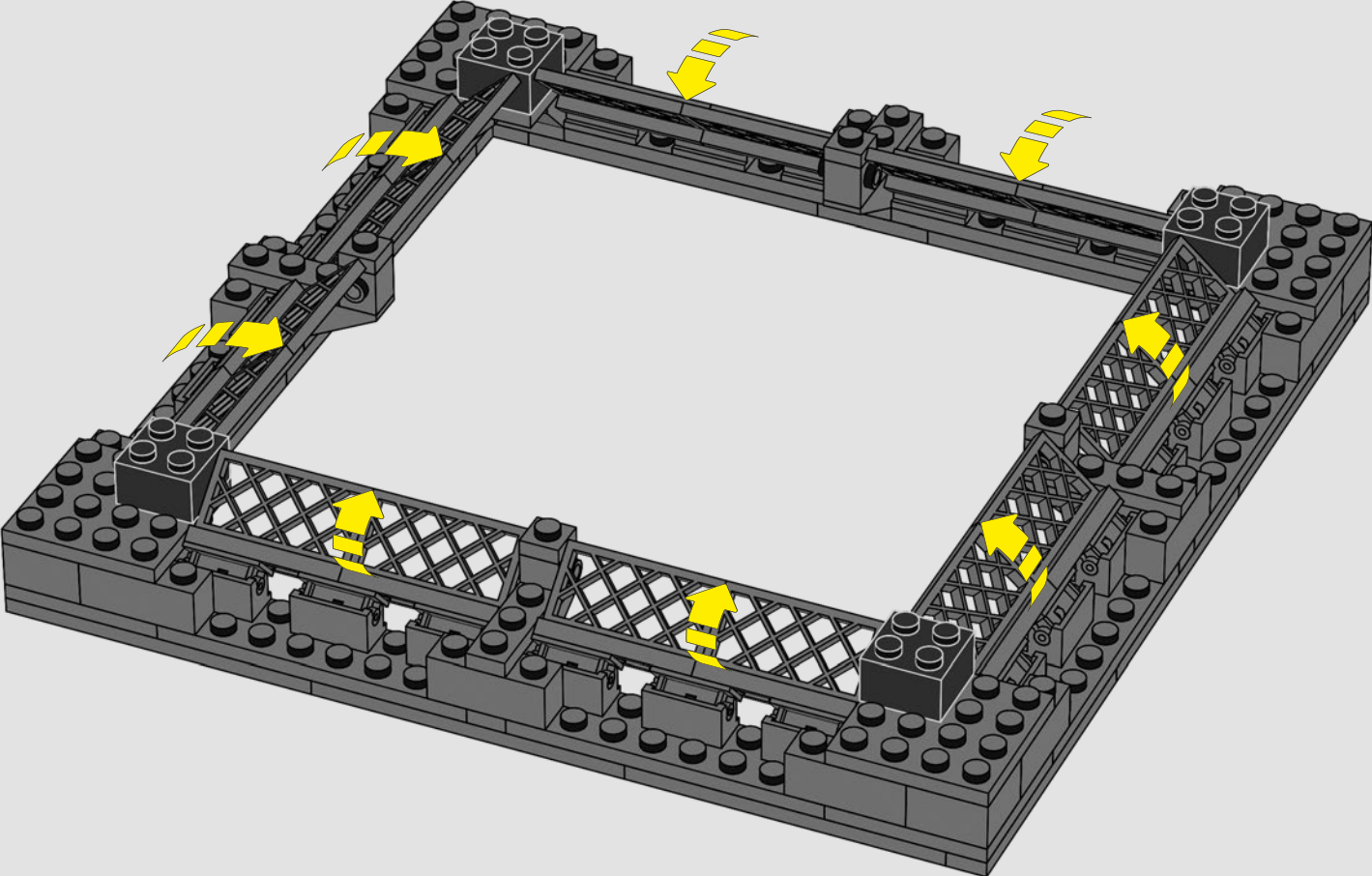

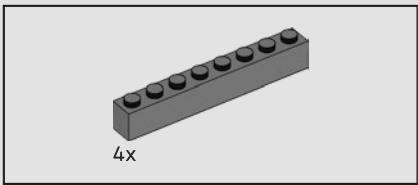

297

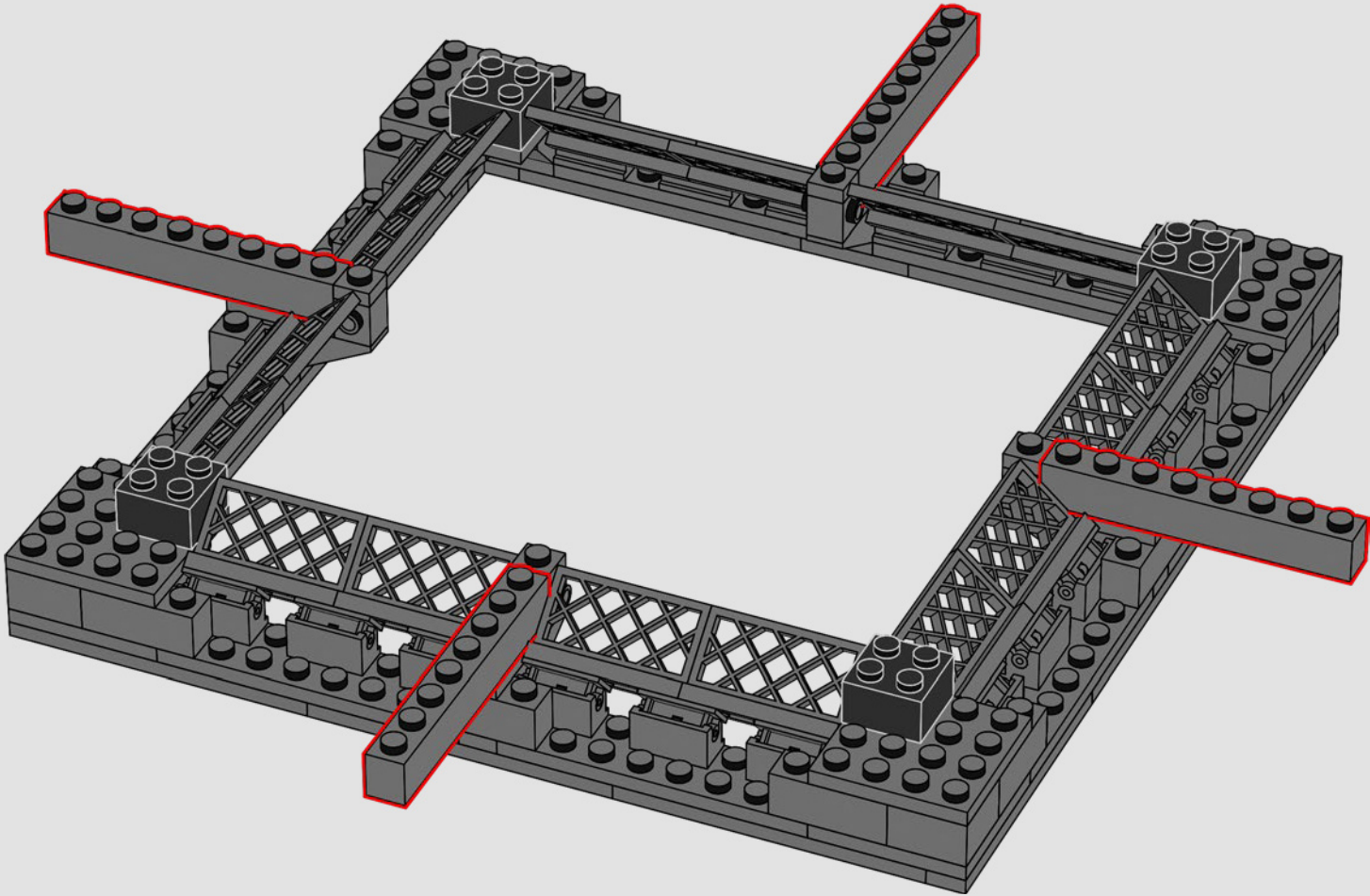

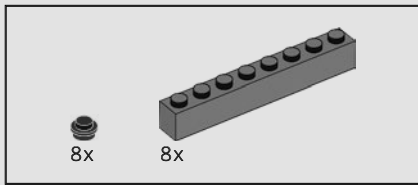

298

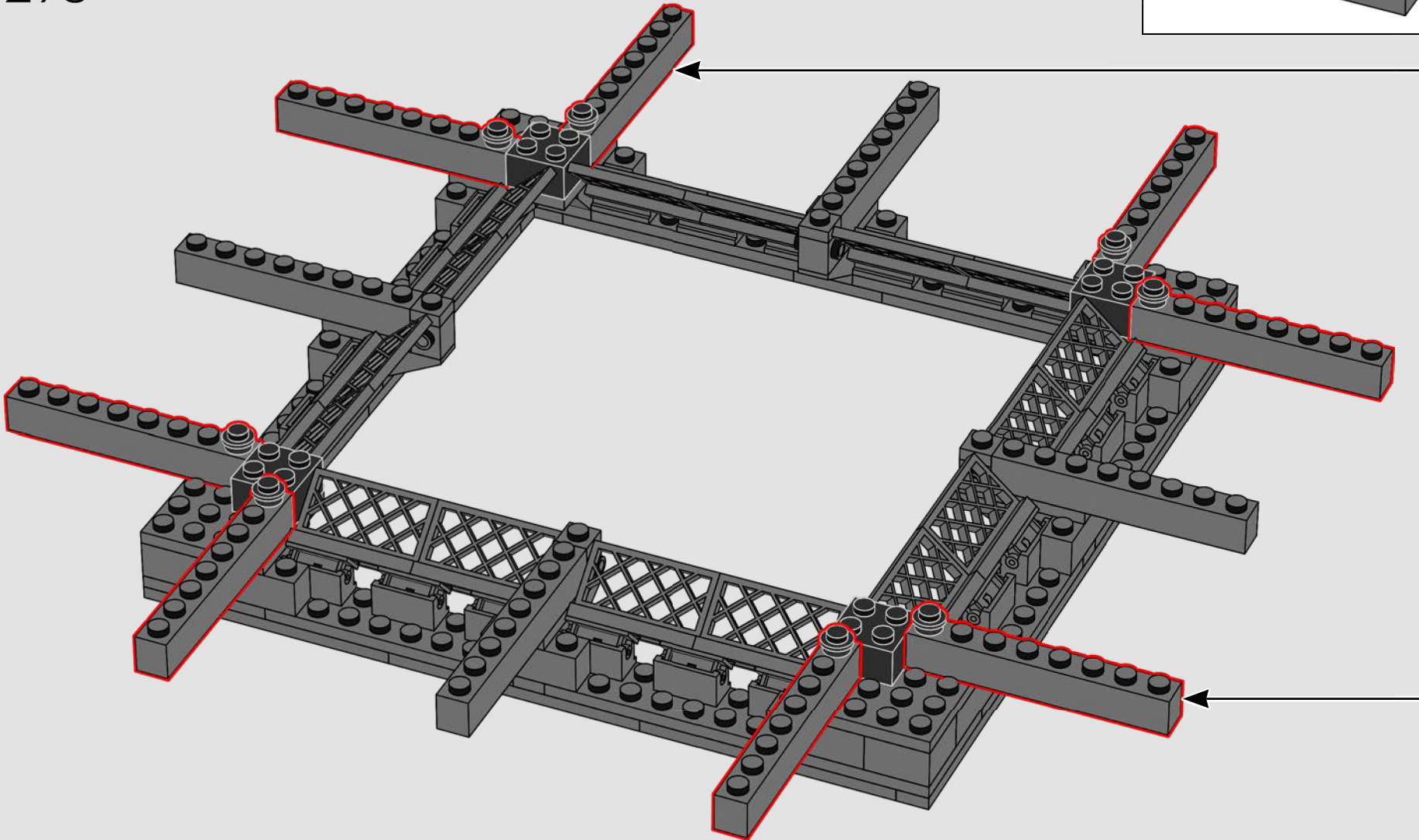
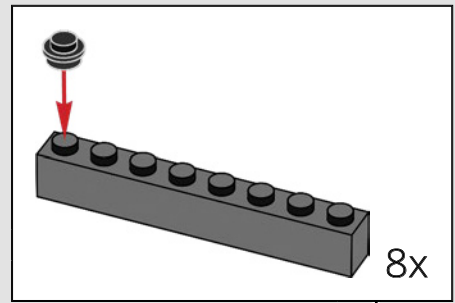

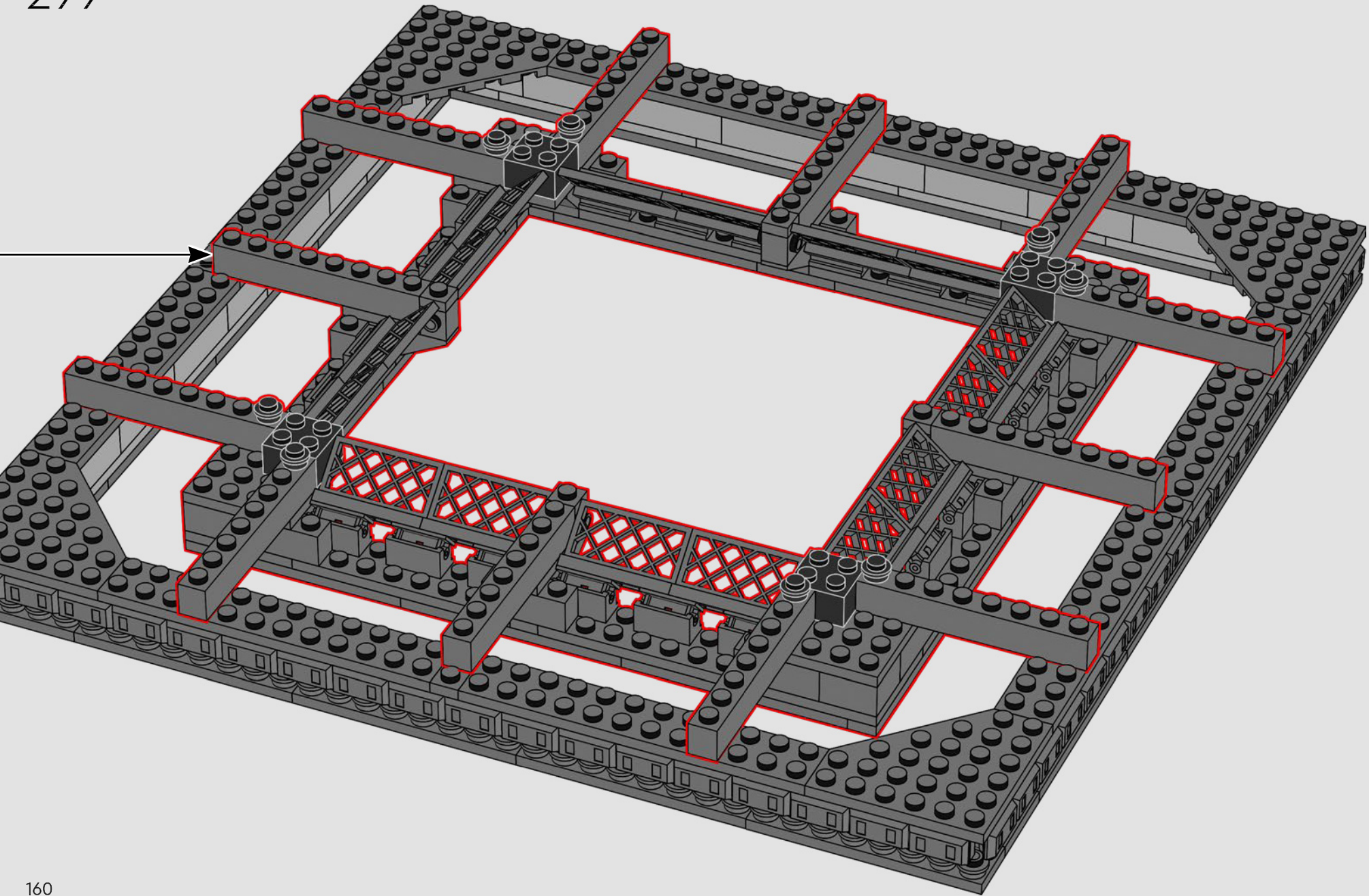

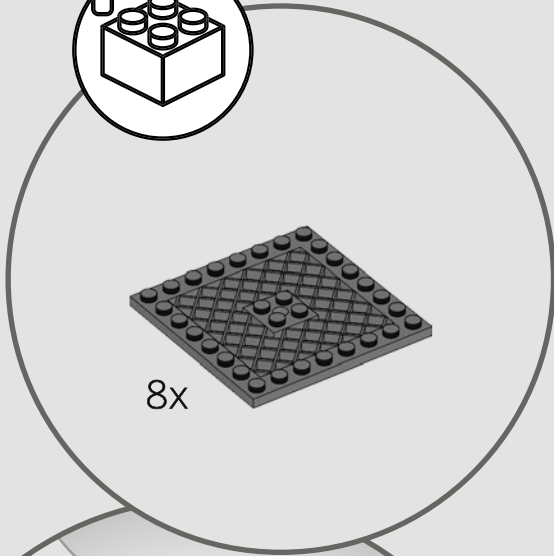
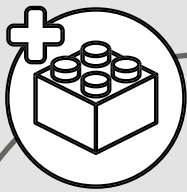

8x



36

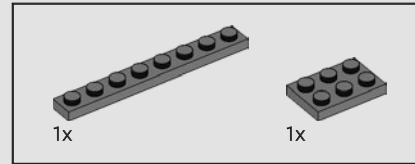
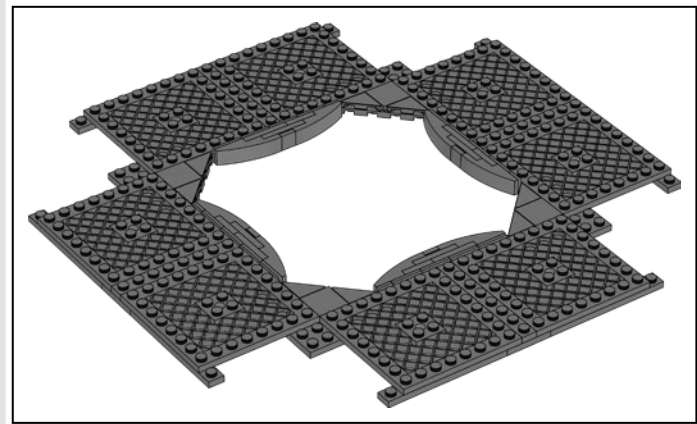

1x

1x

300

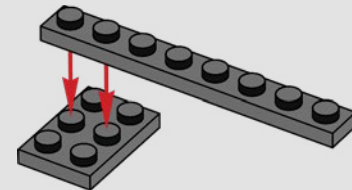

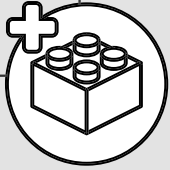
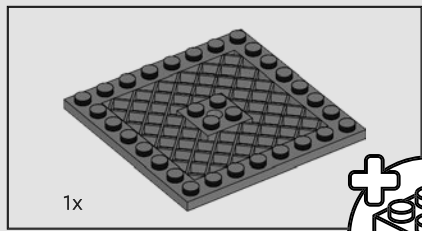

301

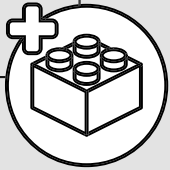
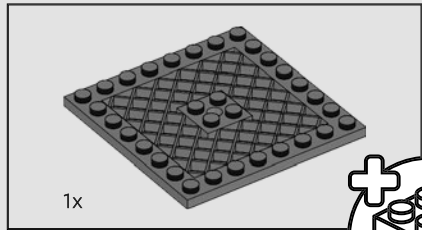
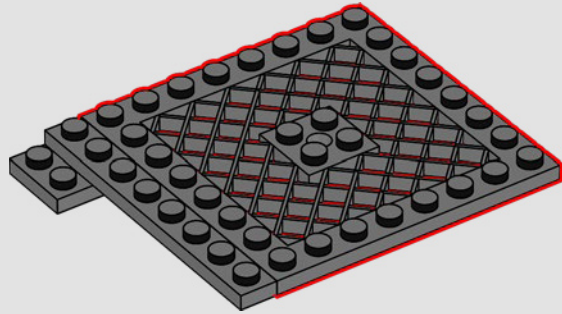

302

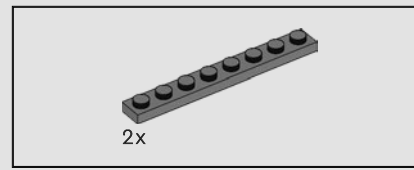
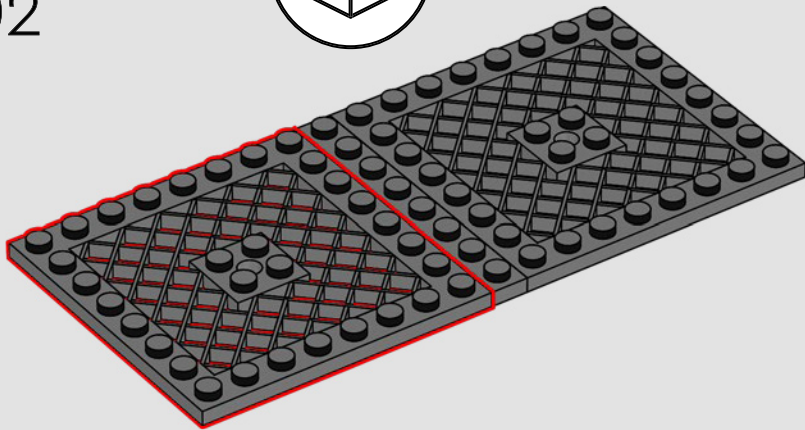

303

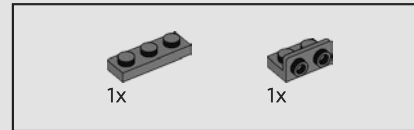
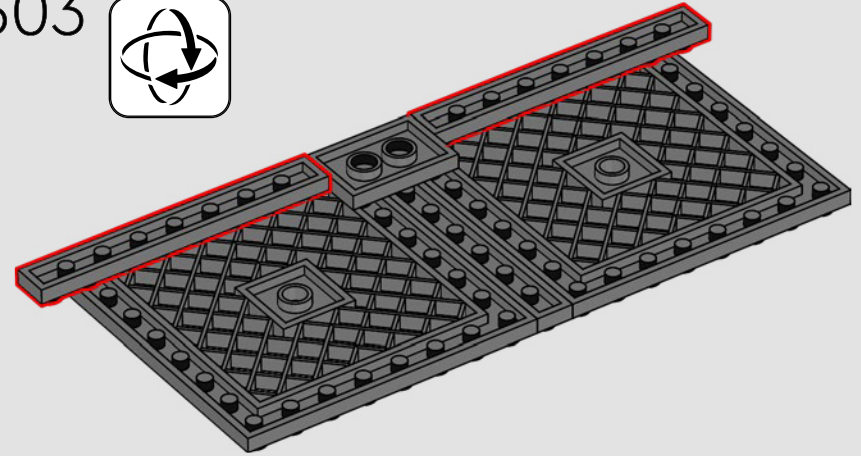

304

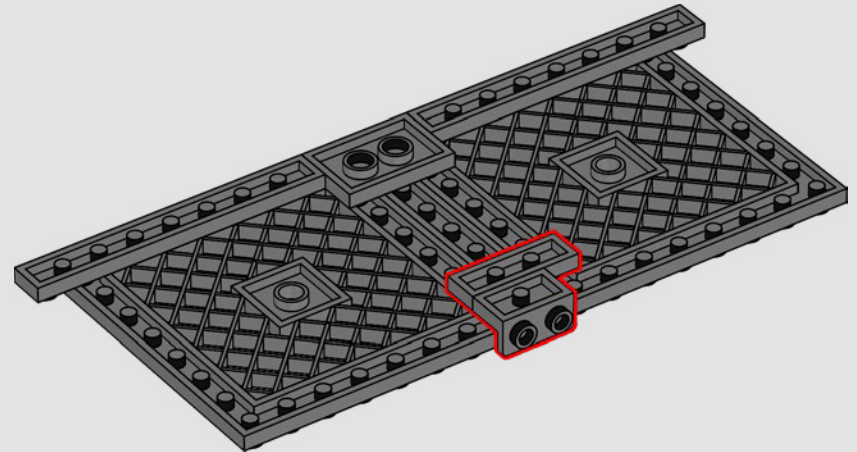

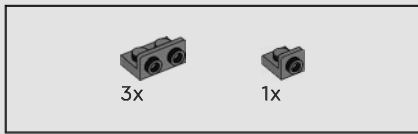

305

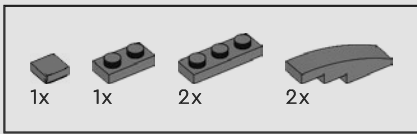
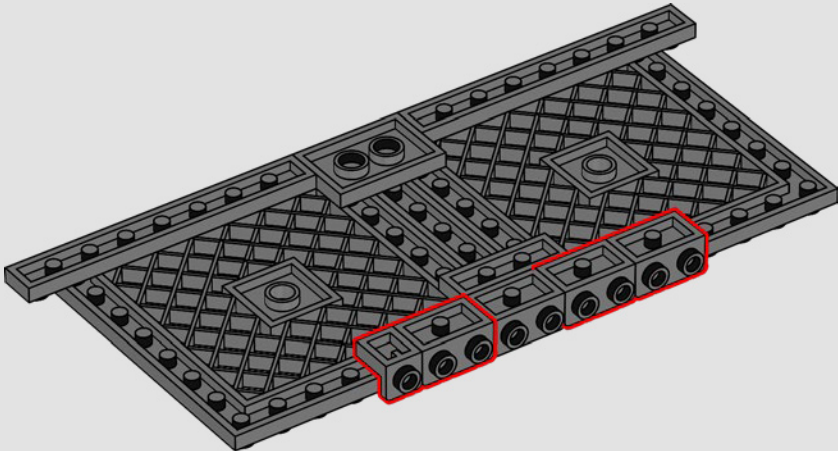

306

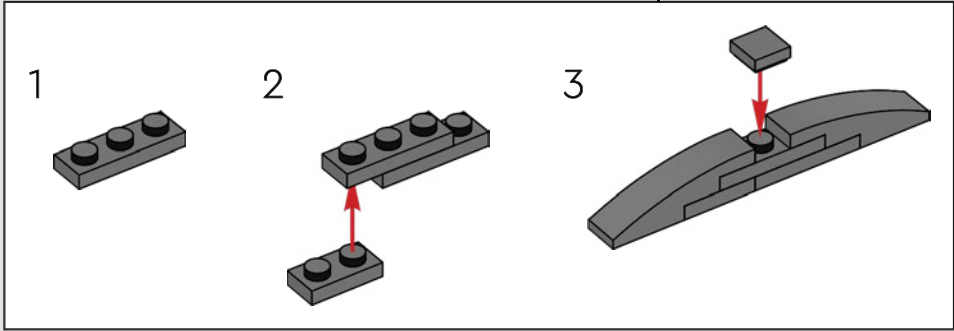
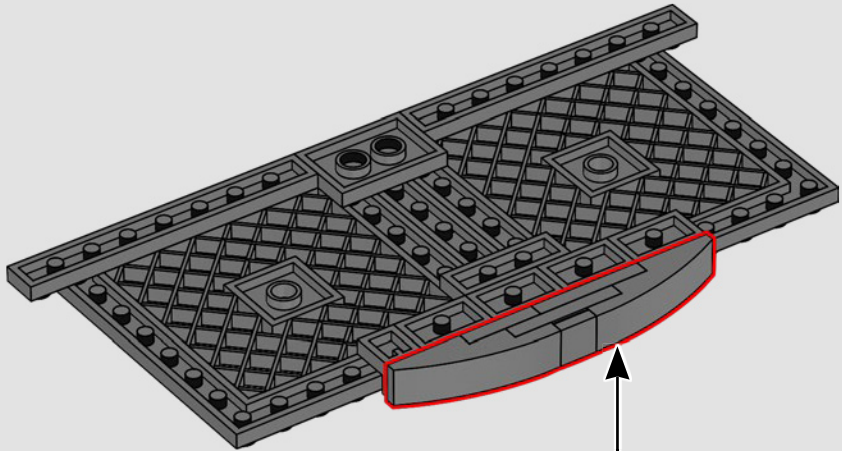

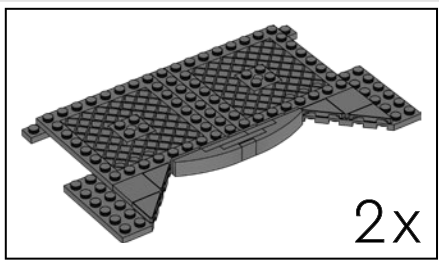

2x

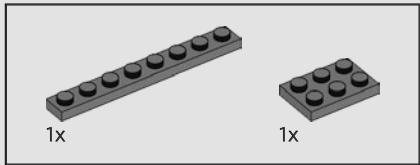

1x

1x

307

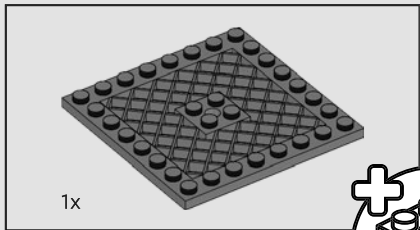
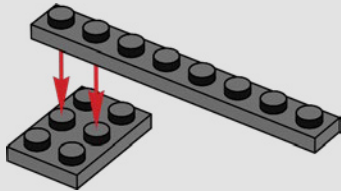

1x

308

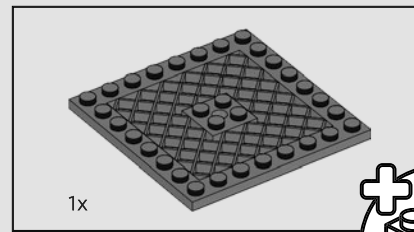
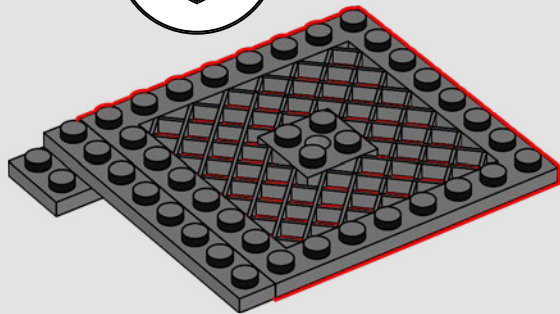
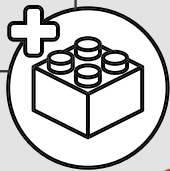

1x

309

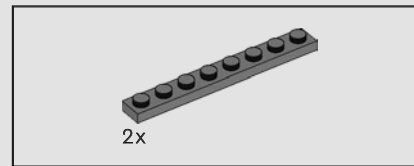
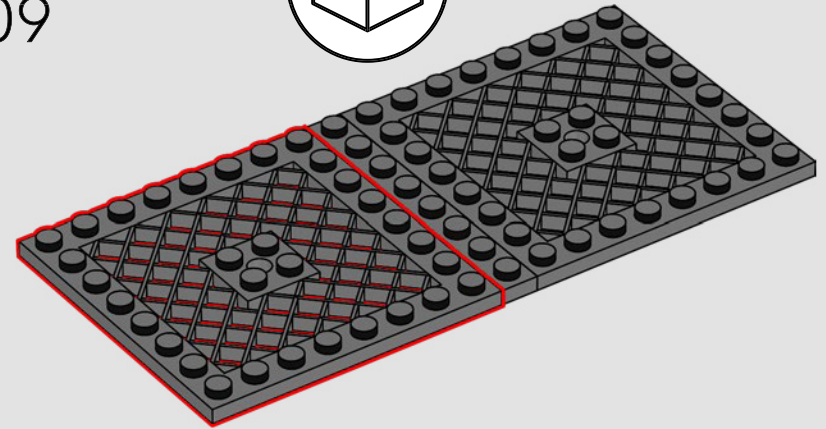
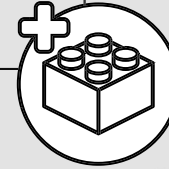

2x

310

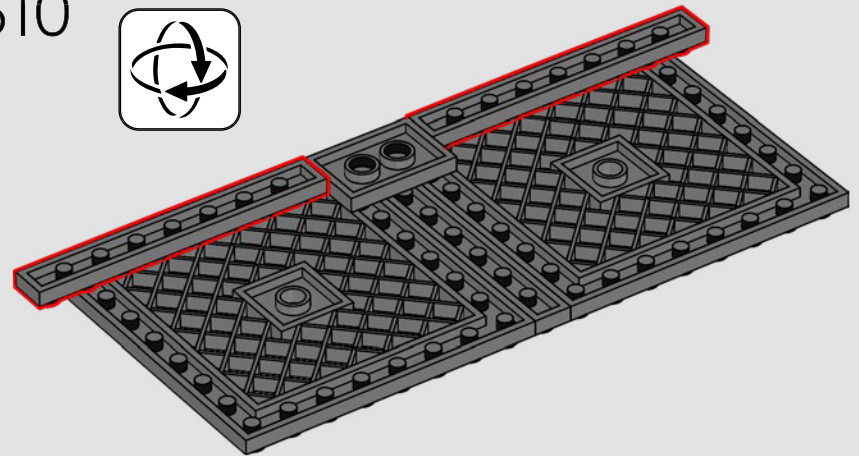
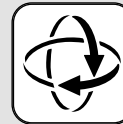

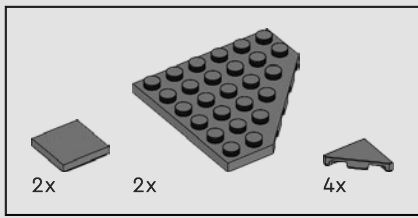

314

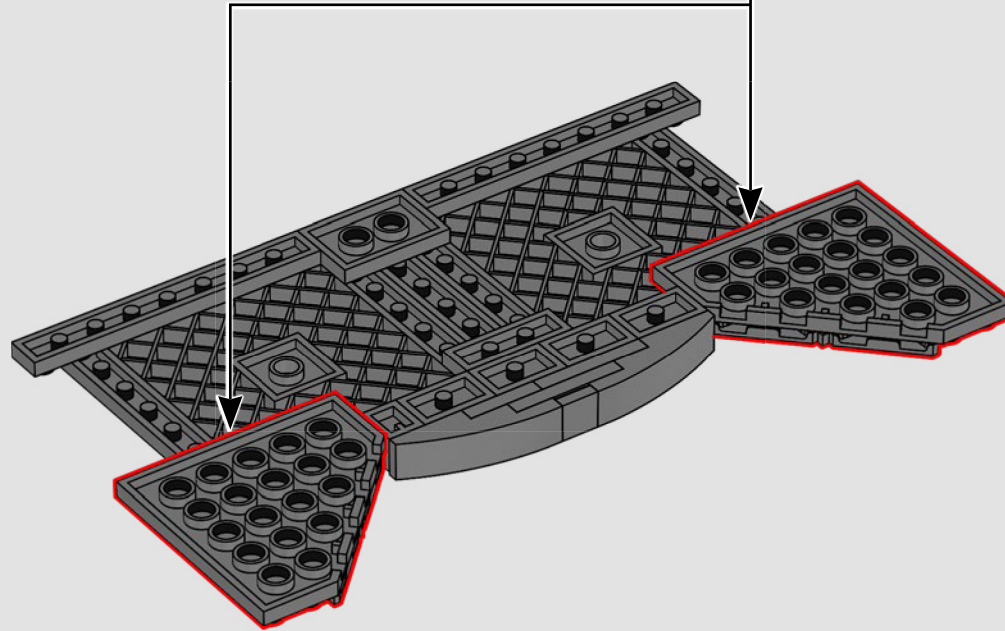
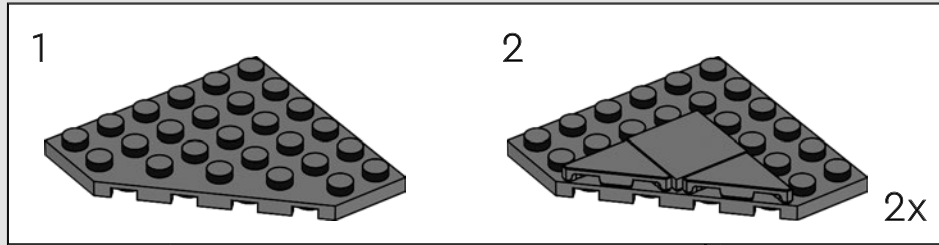

315

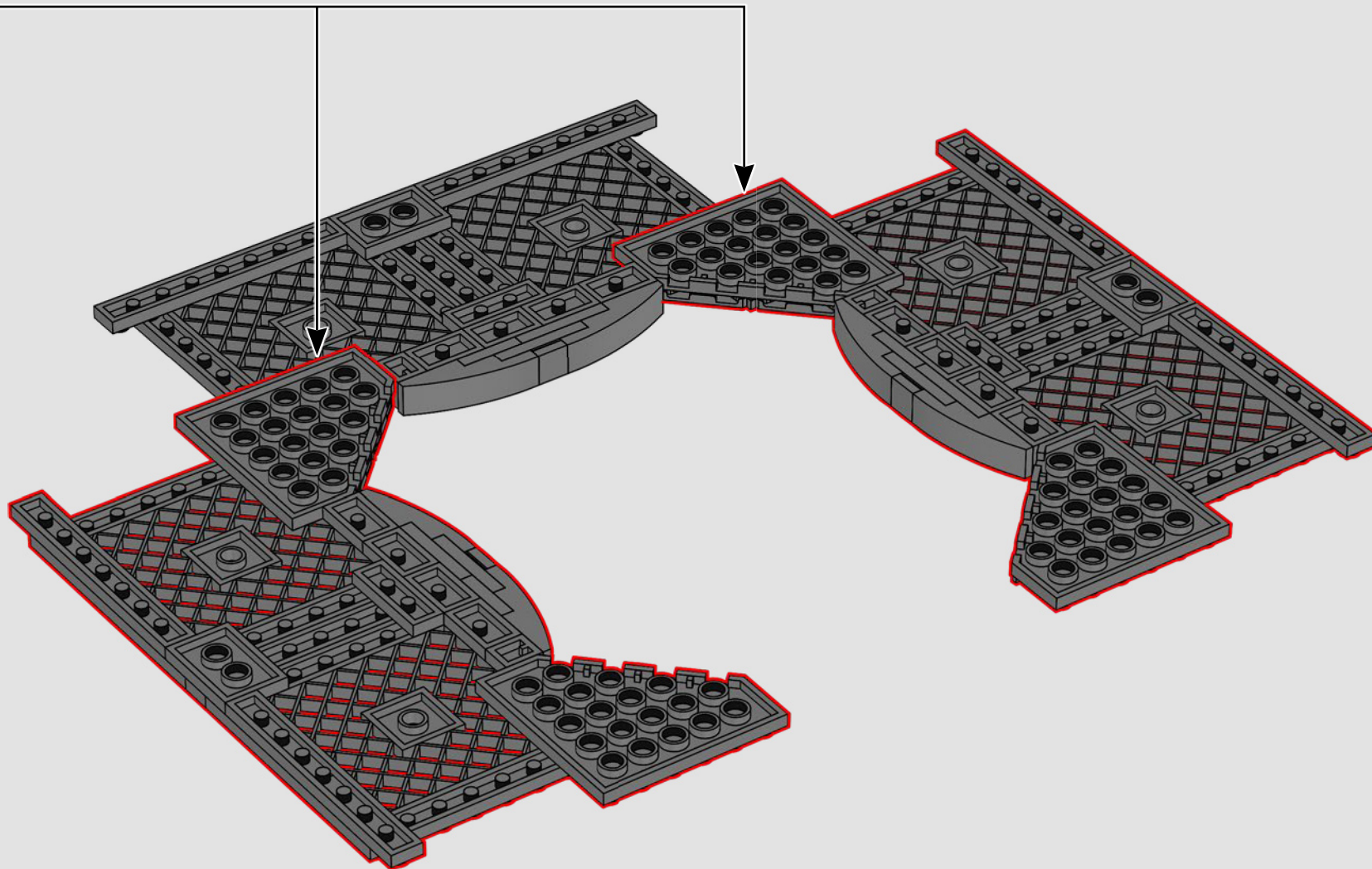

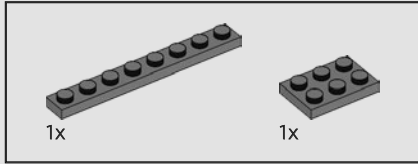
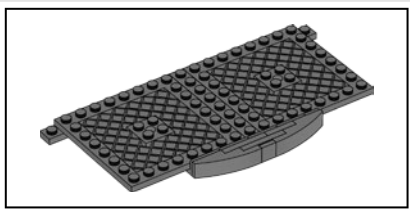

316

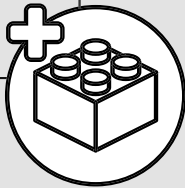
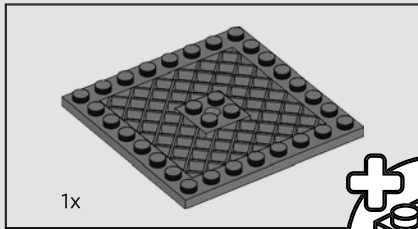
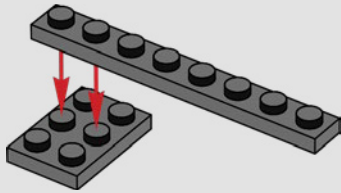

317

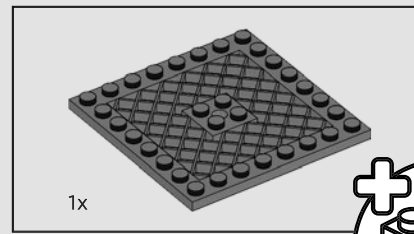
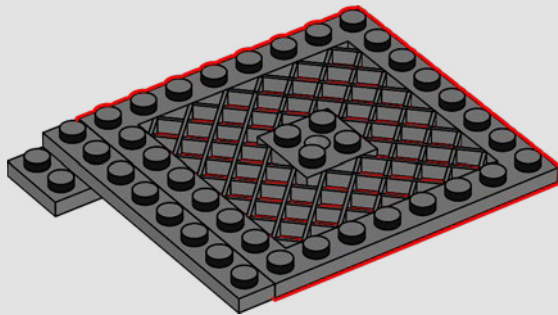

1x

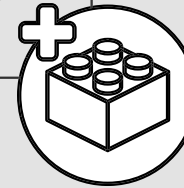

318

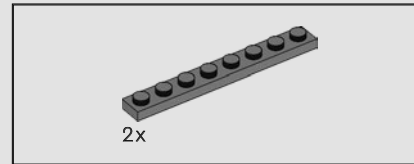
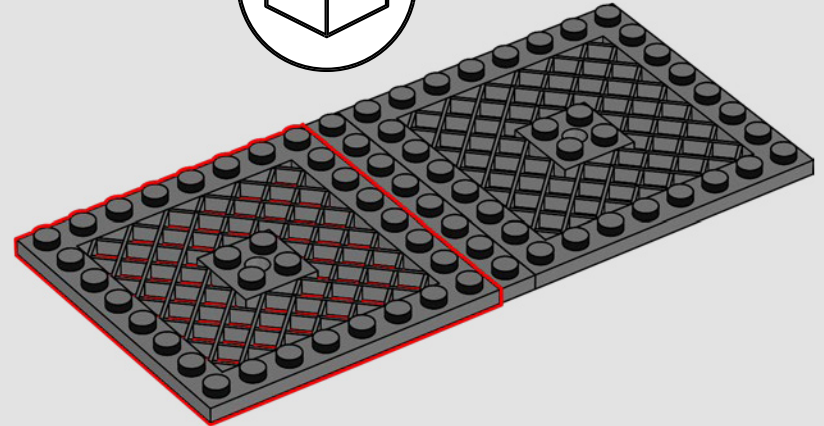

2x



319

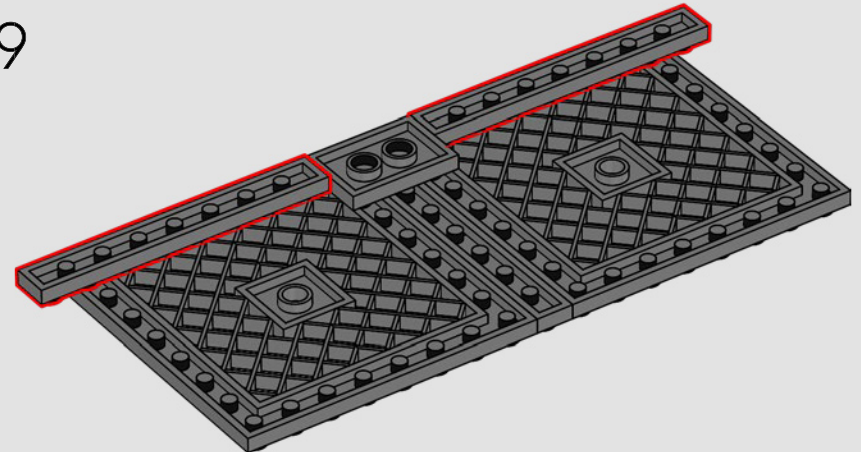

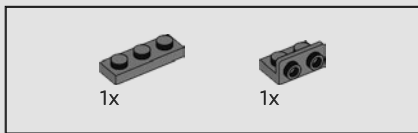

320

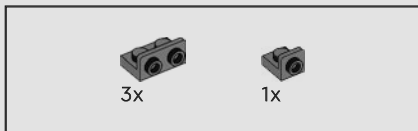
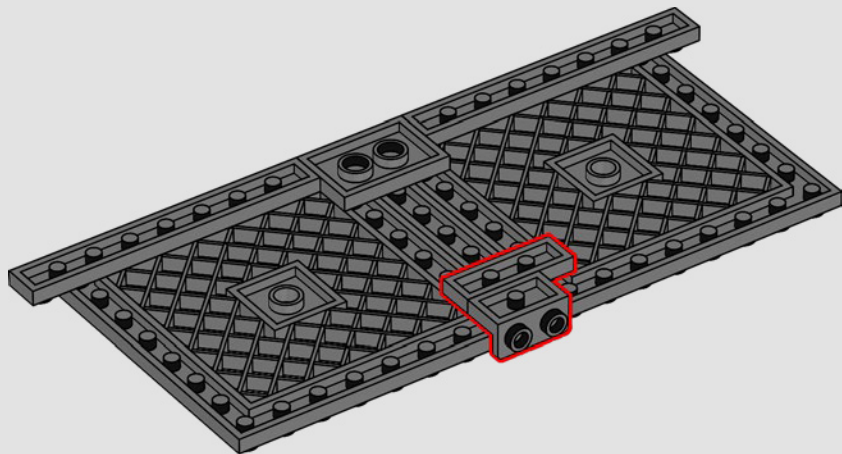

321

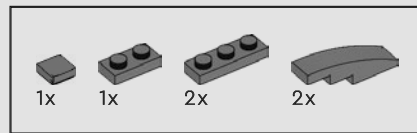
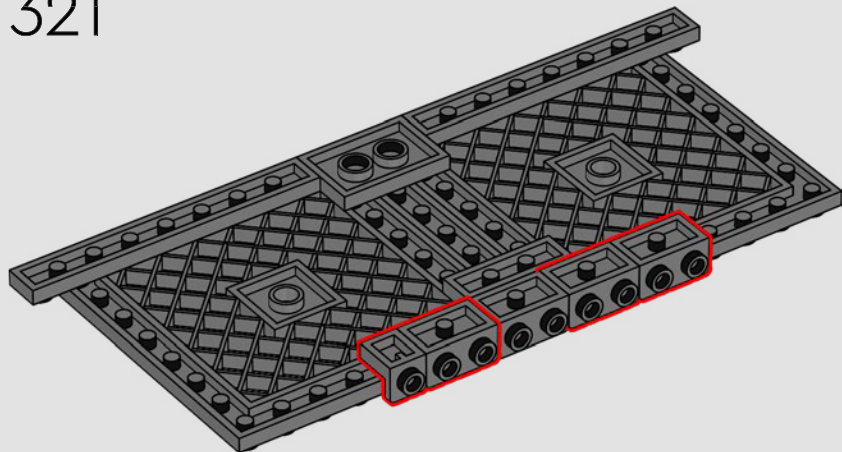

322

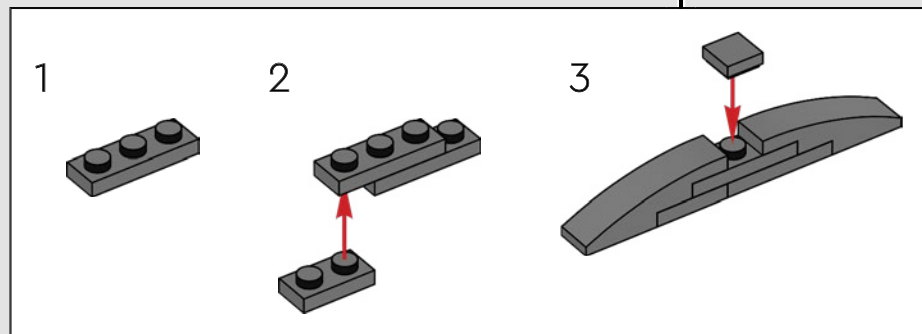
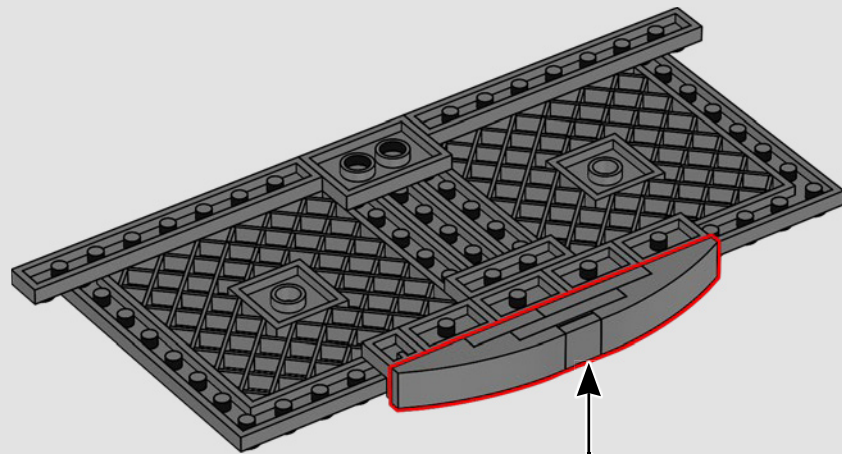

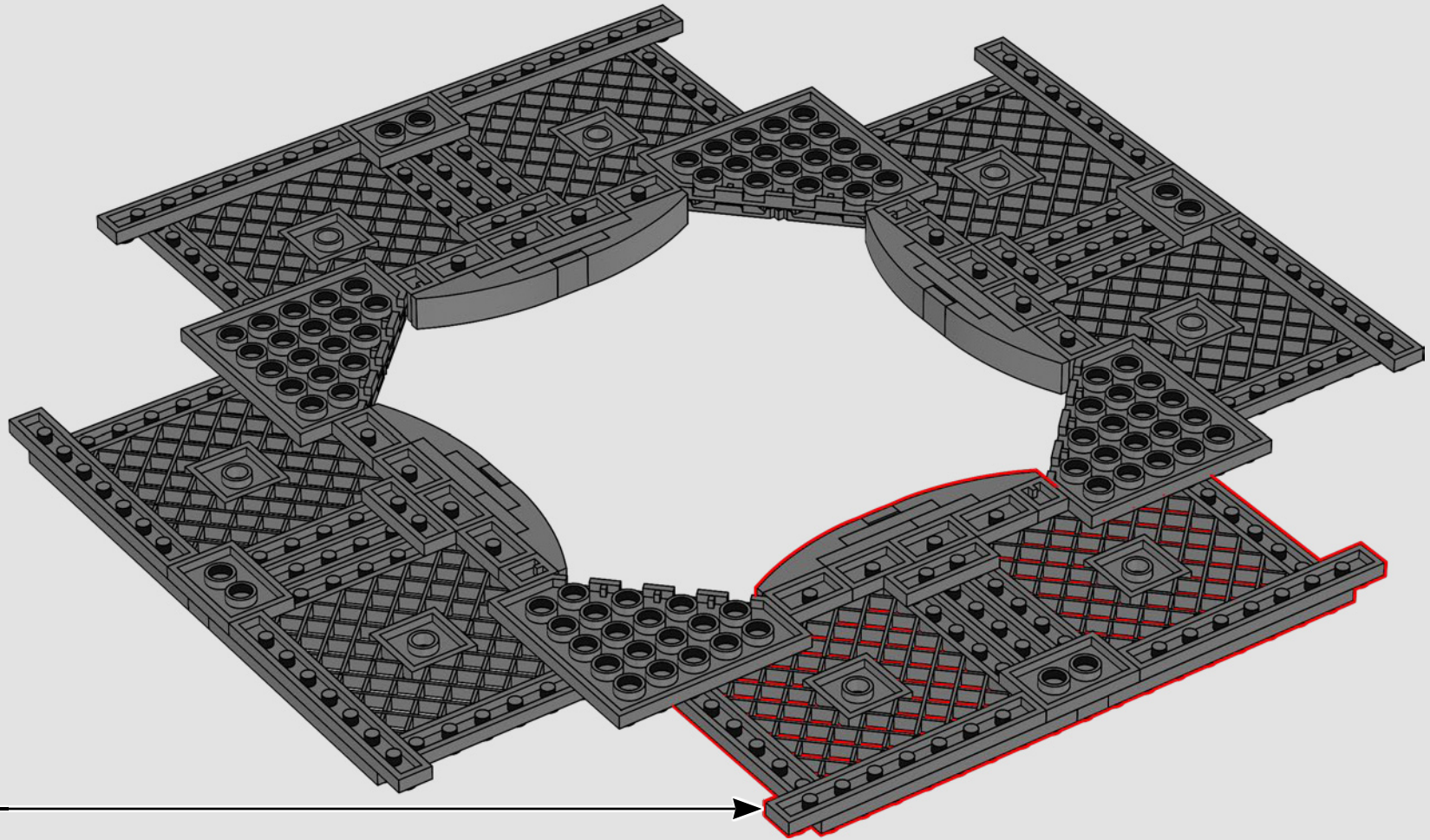

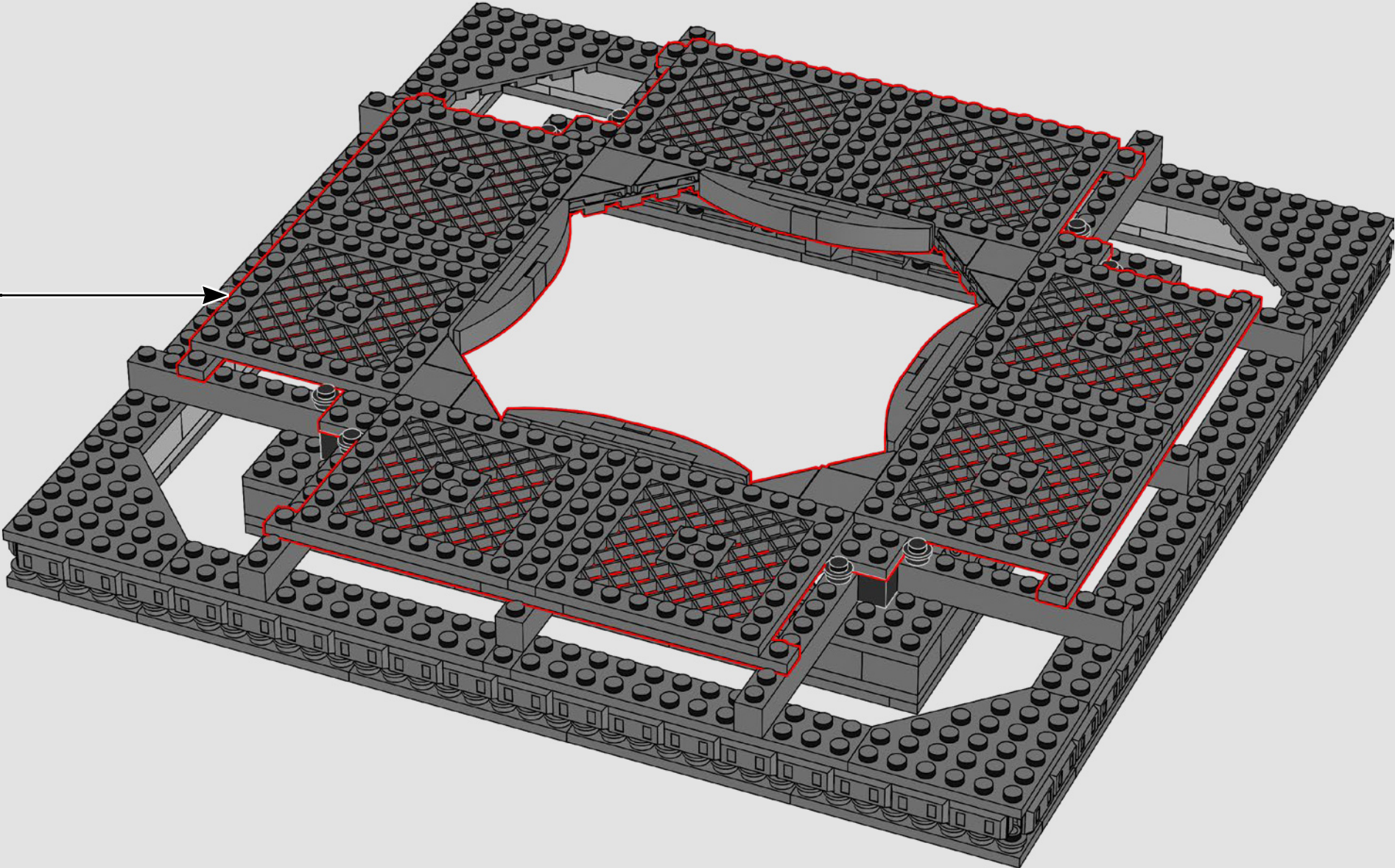



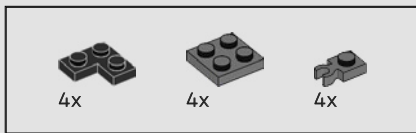

325

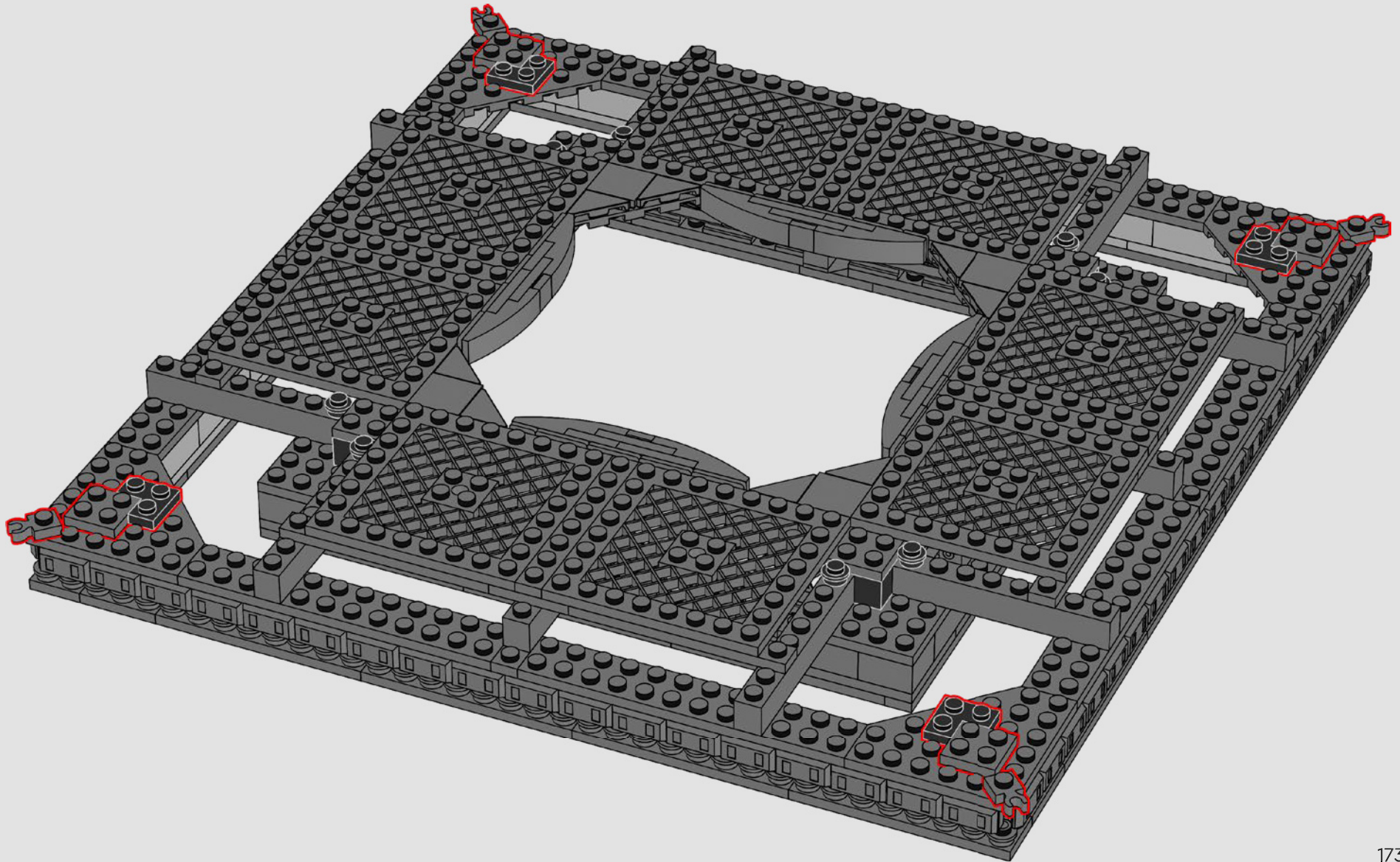

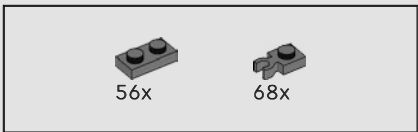

326

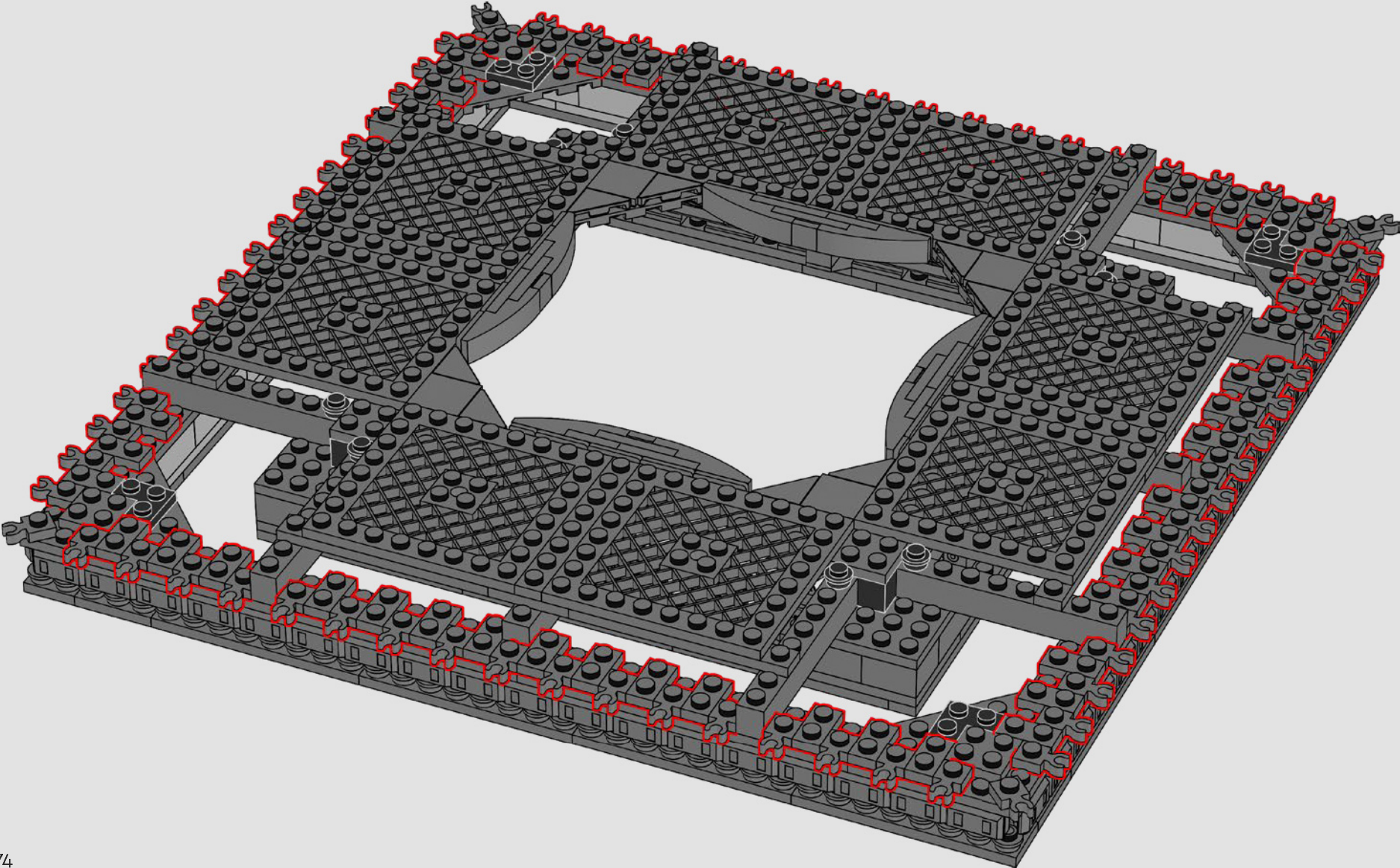

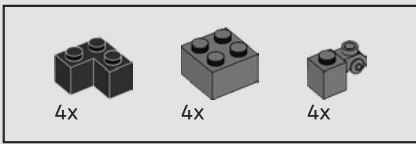

327

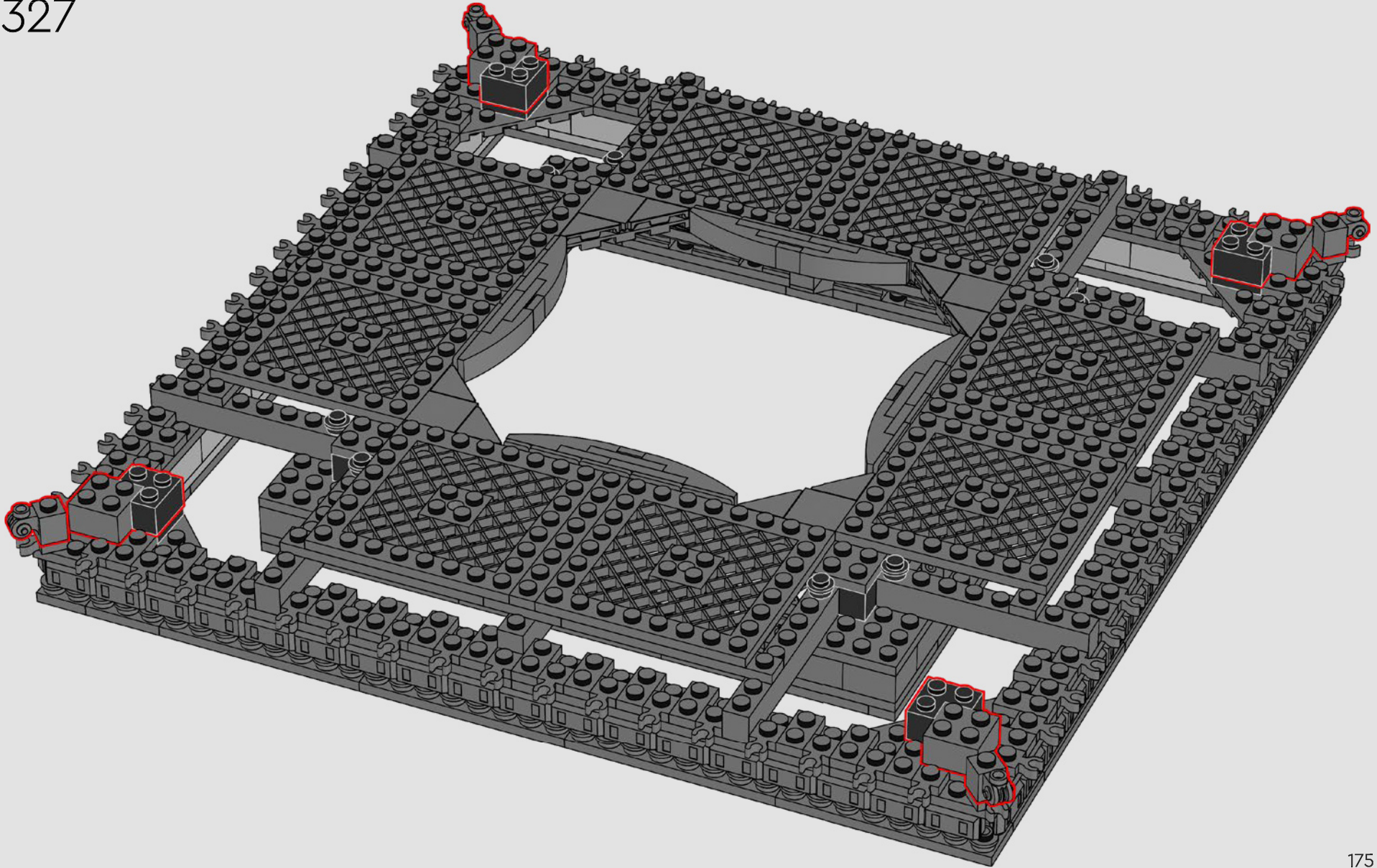



56x

328

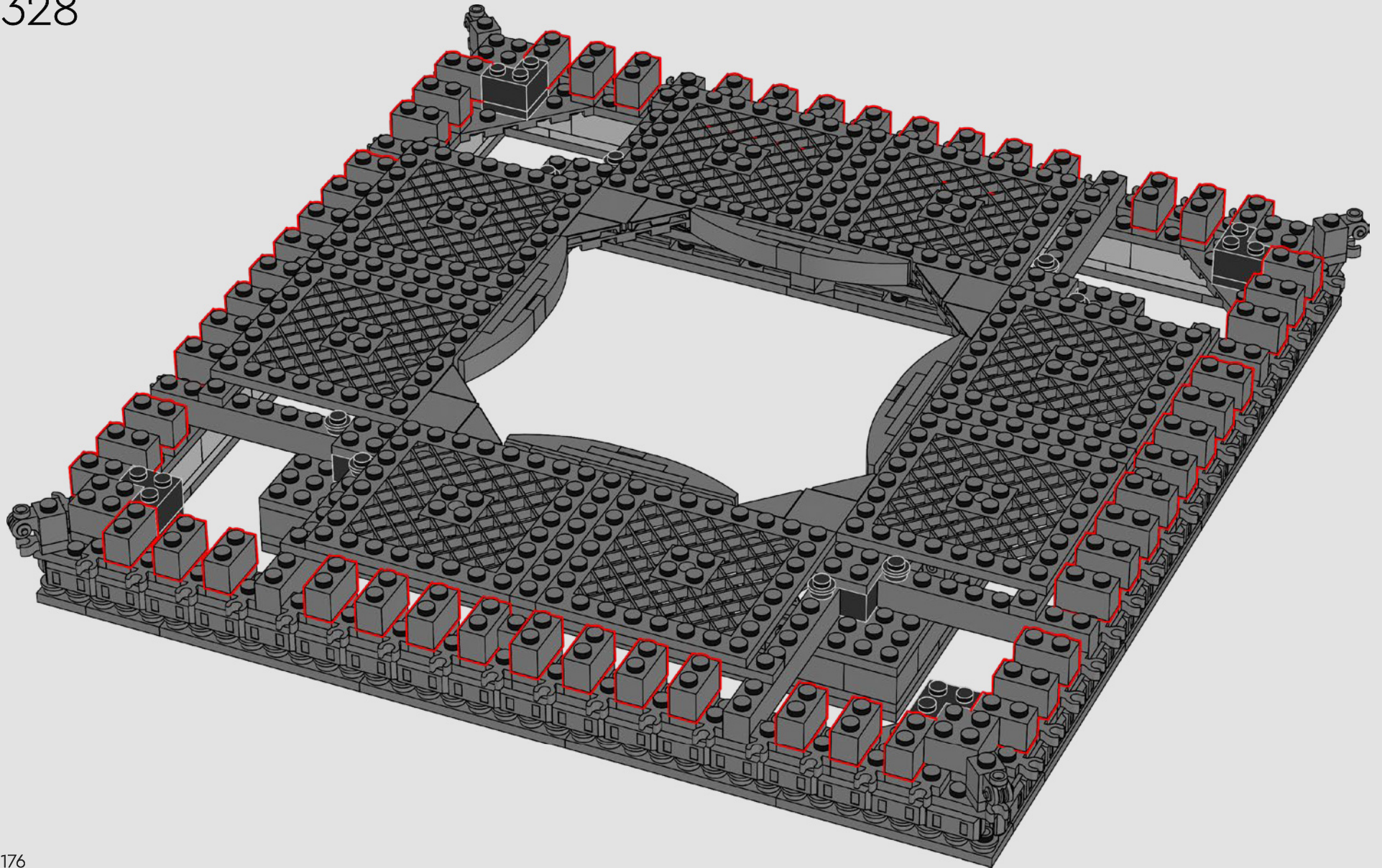



329

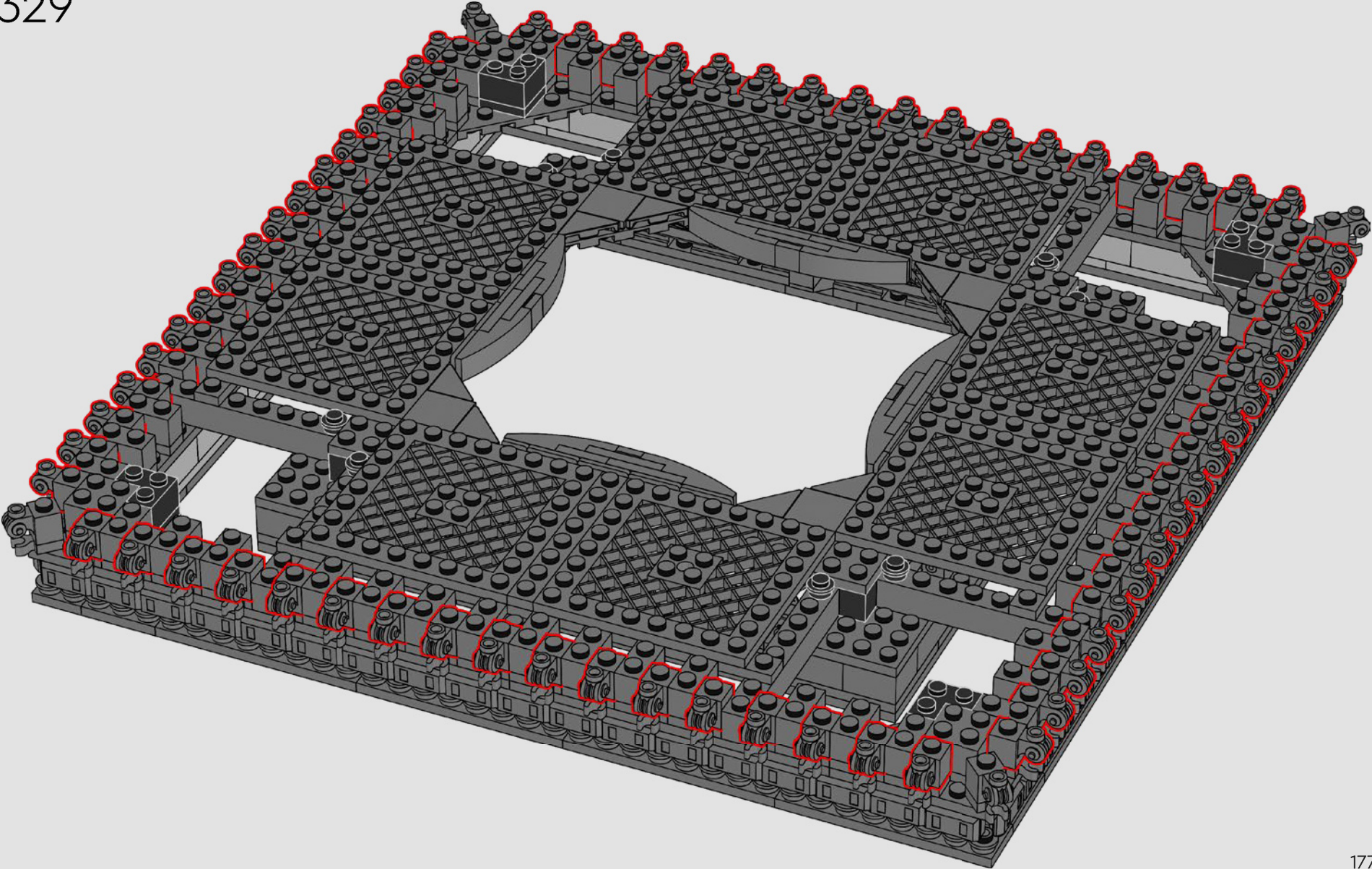



8x

330

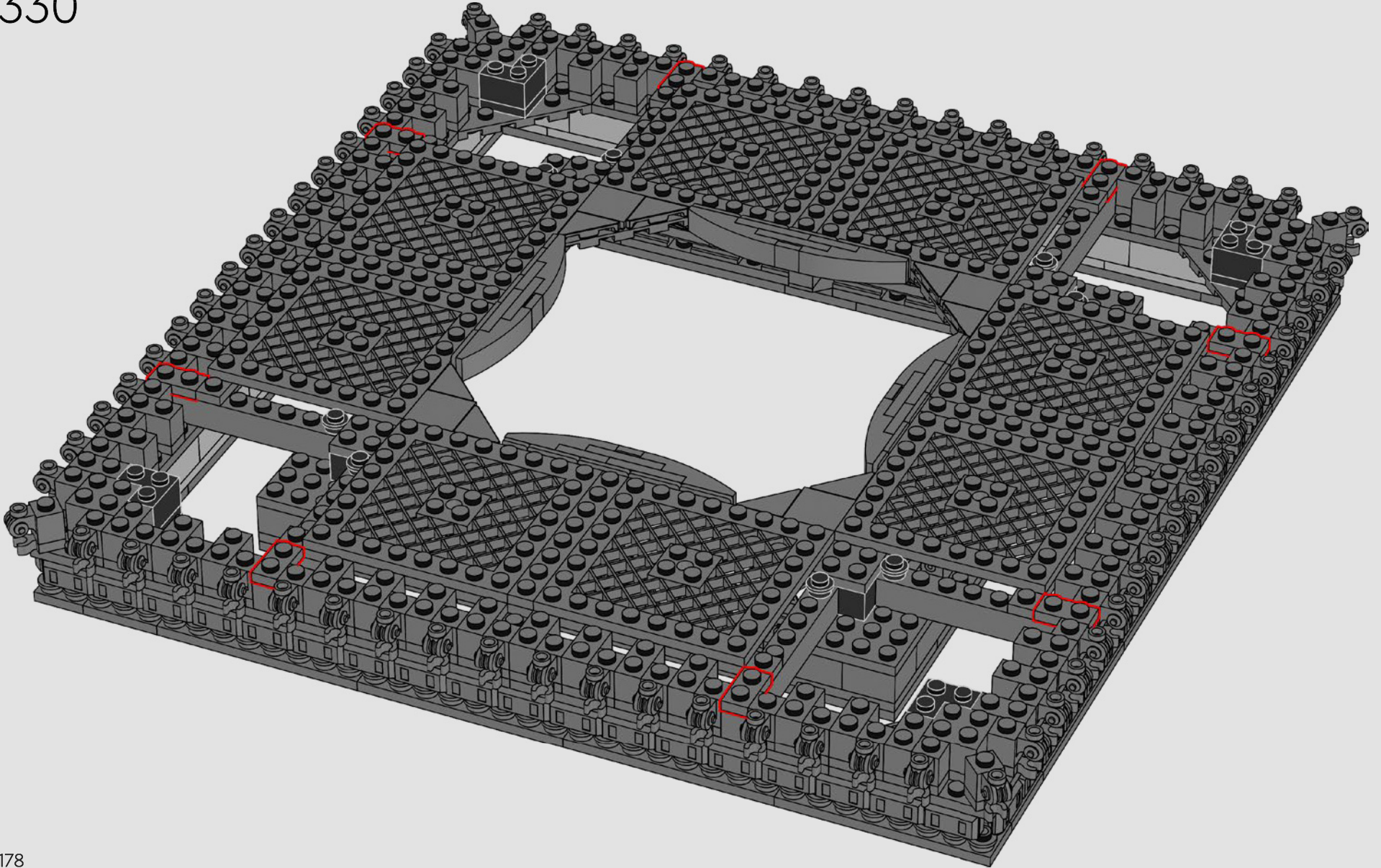





4x

331

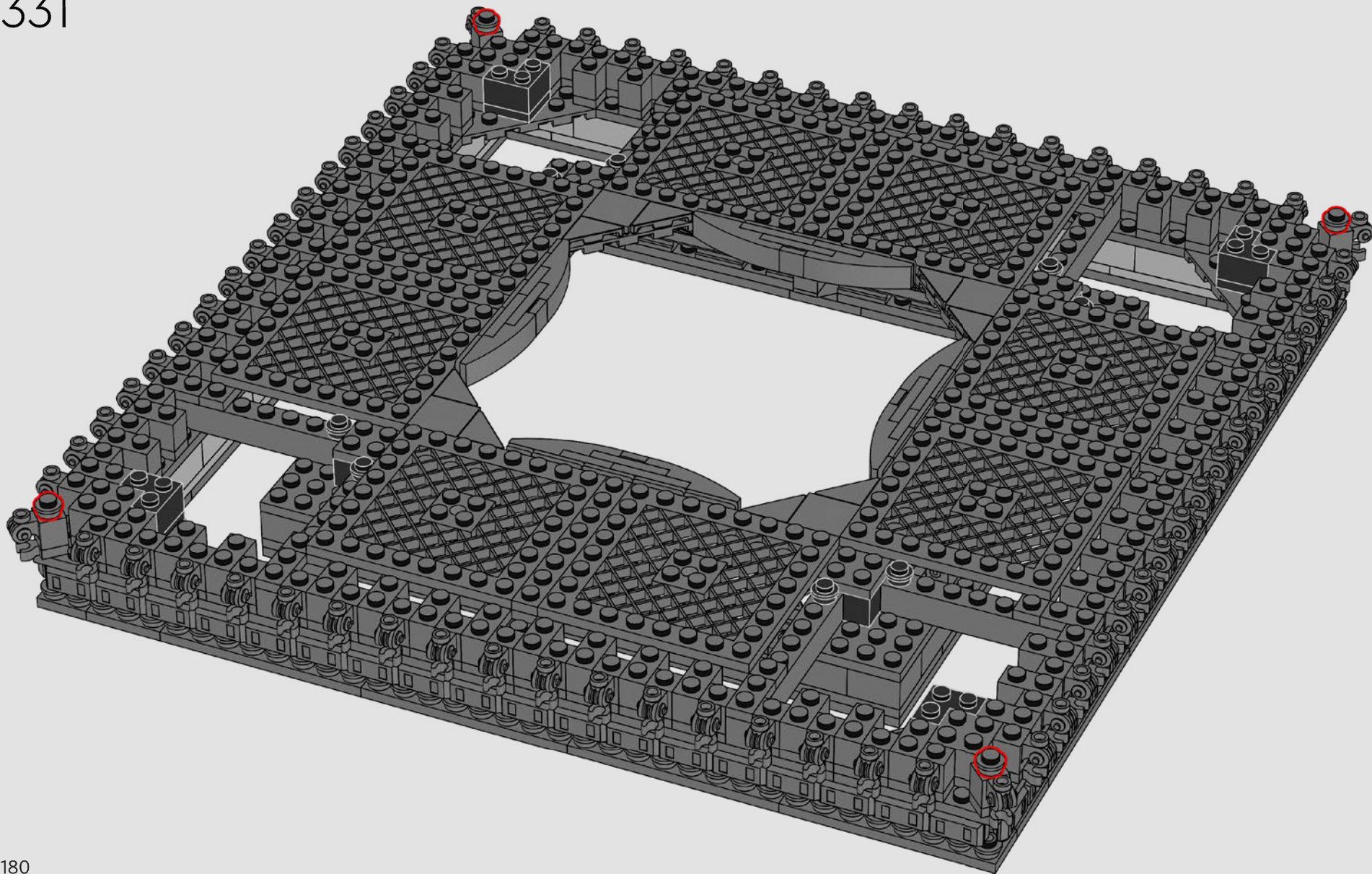



332

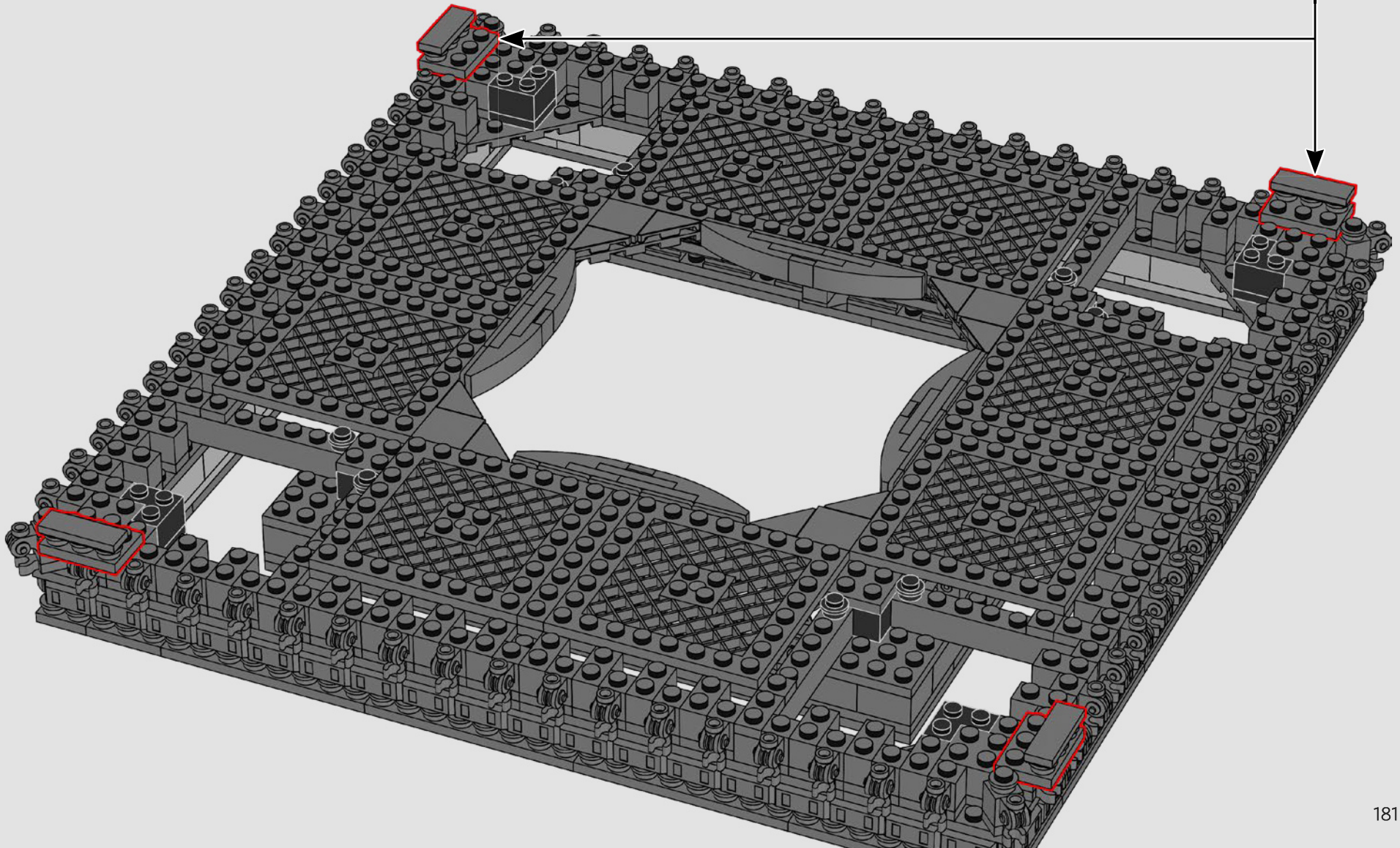
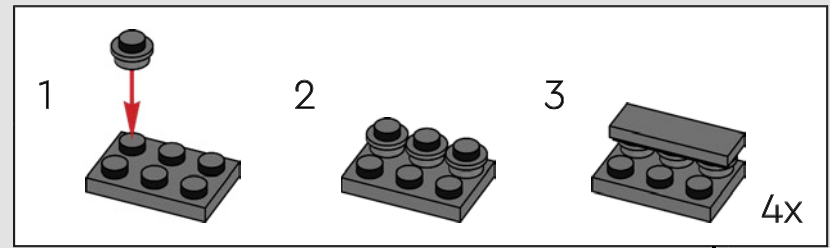

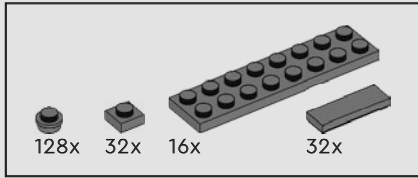
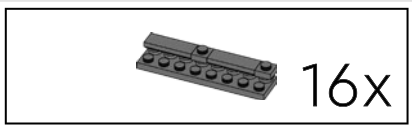

333

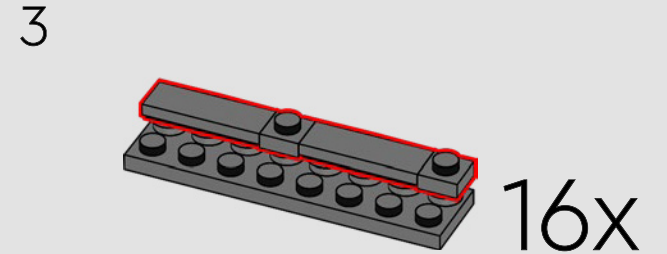
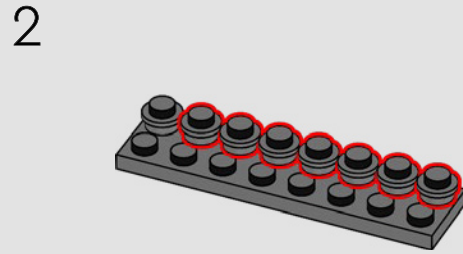
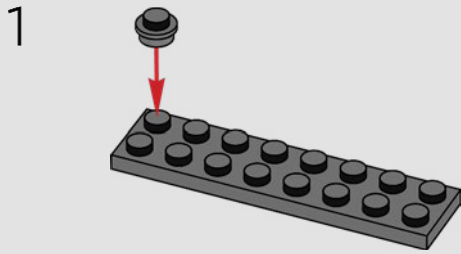

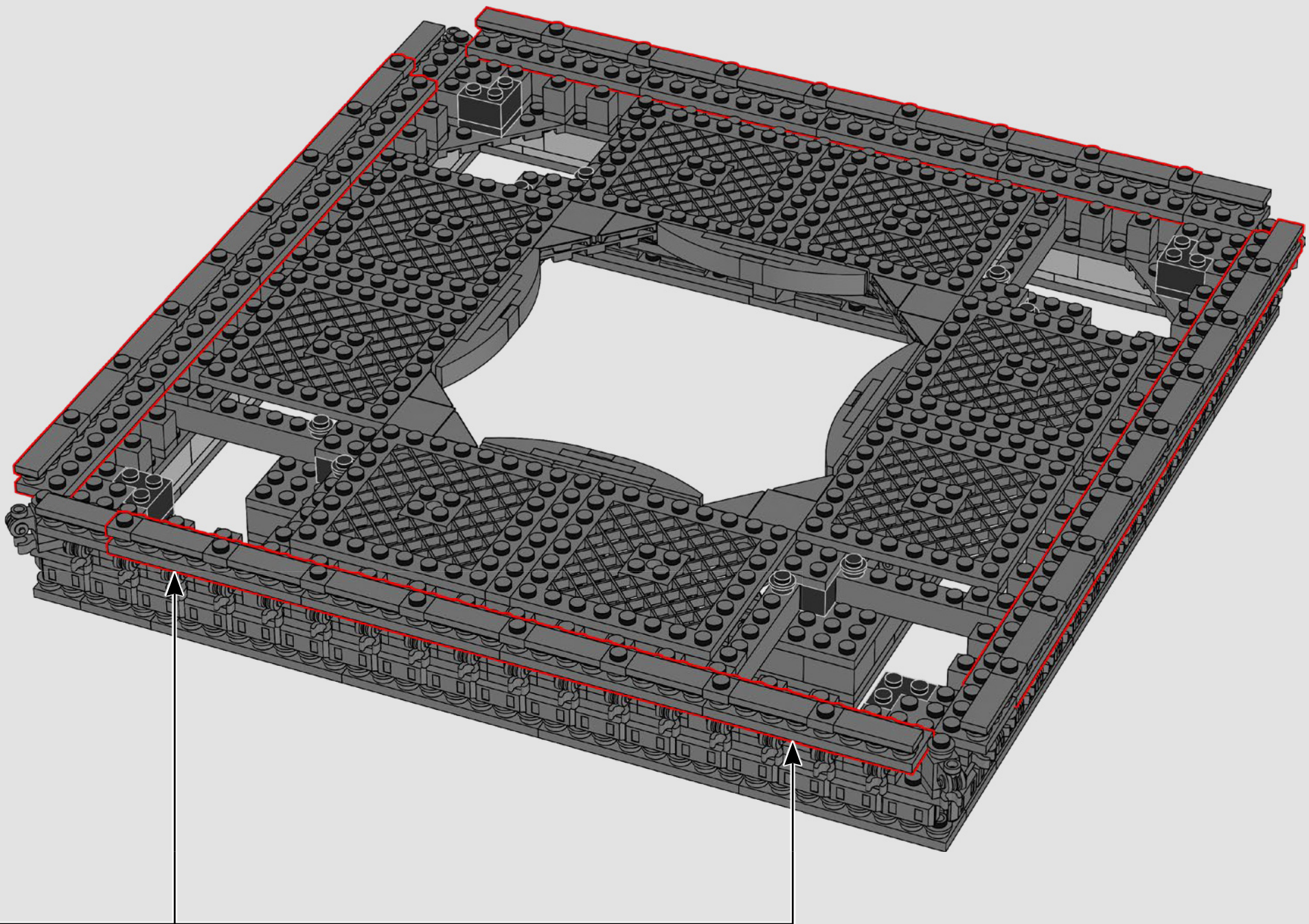

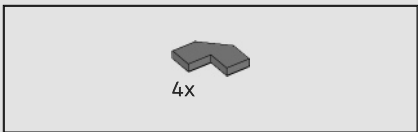

334

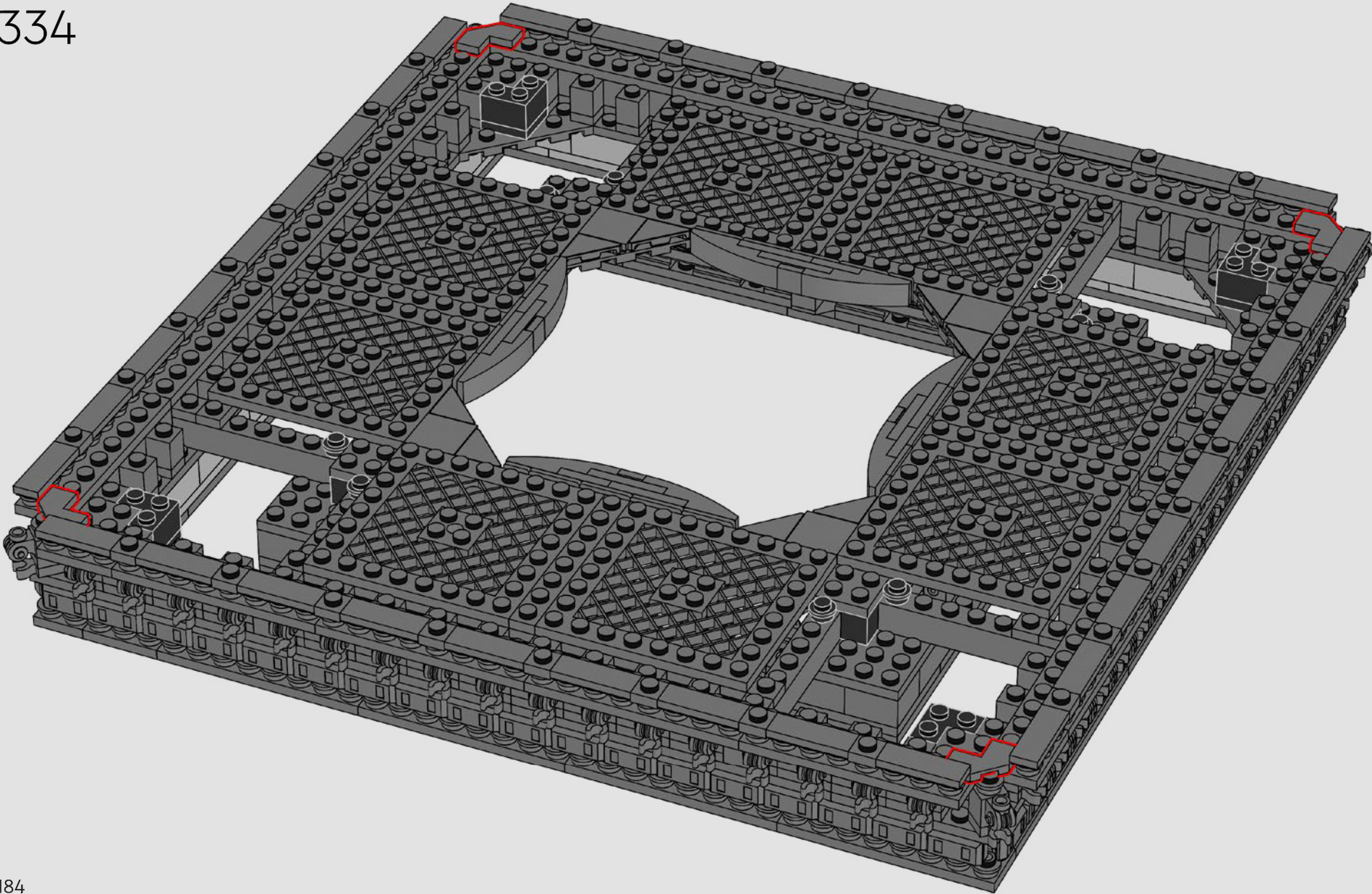

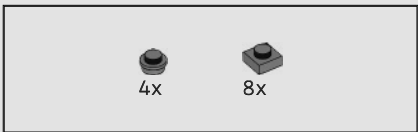

335

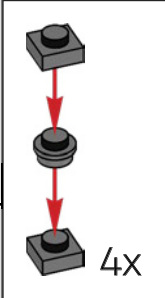
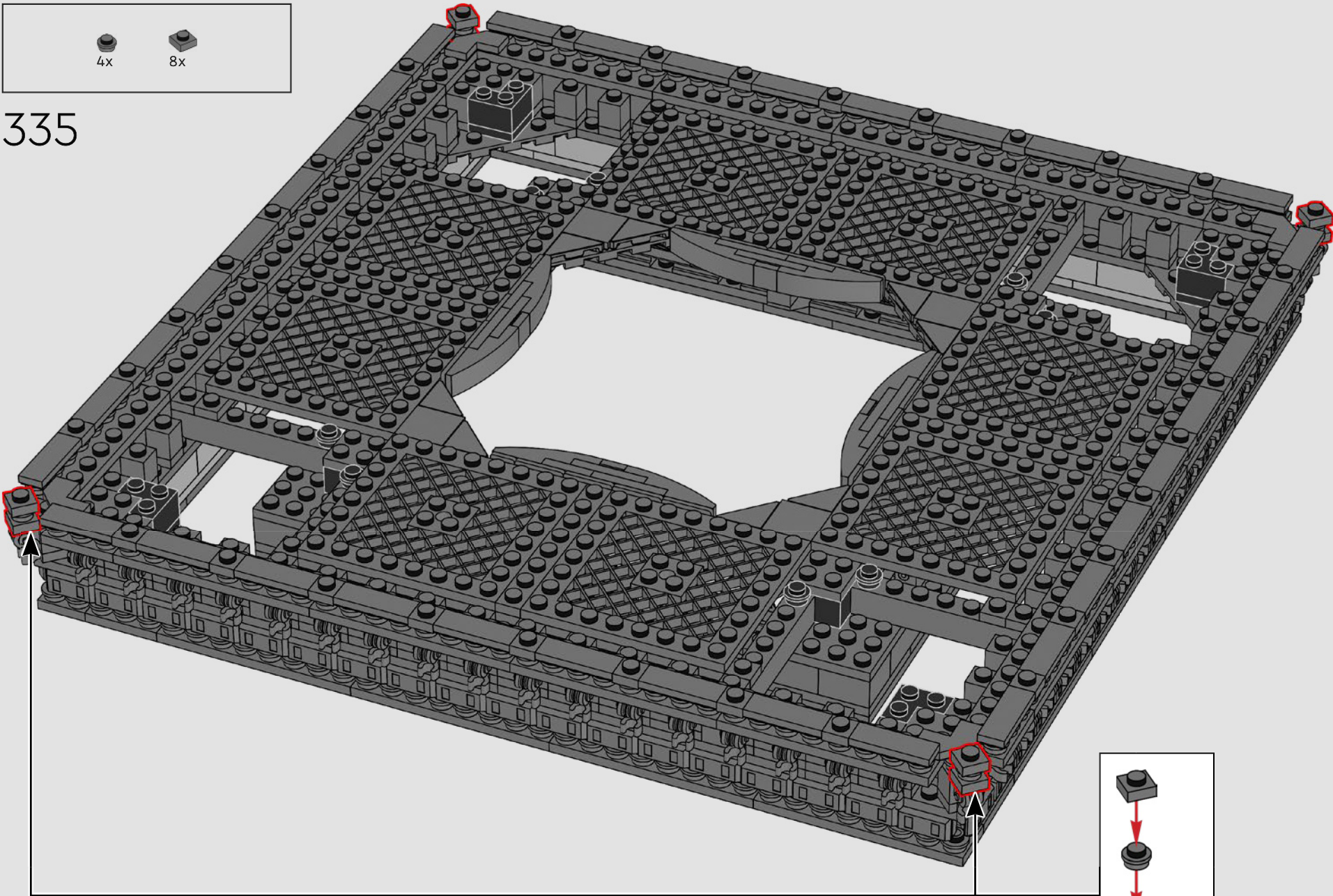



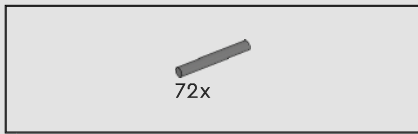

336

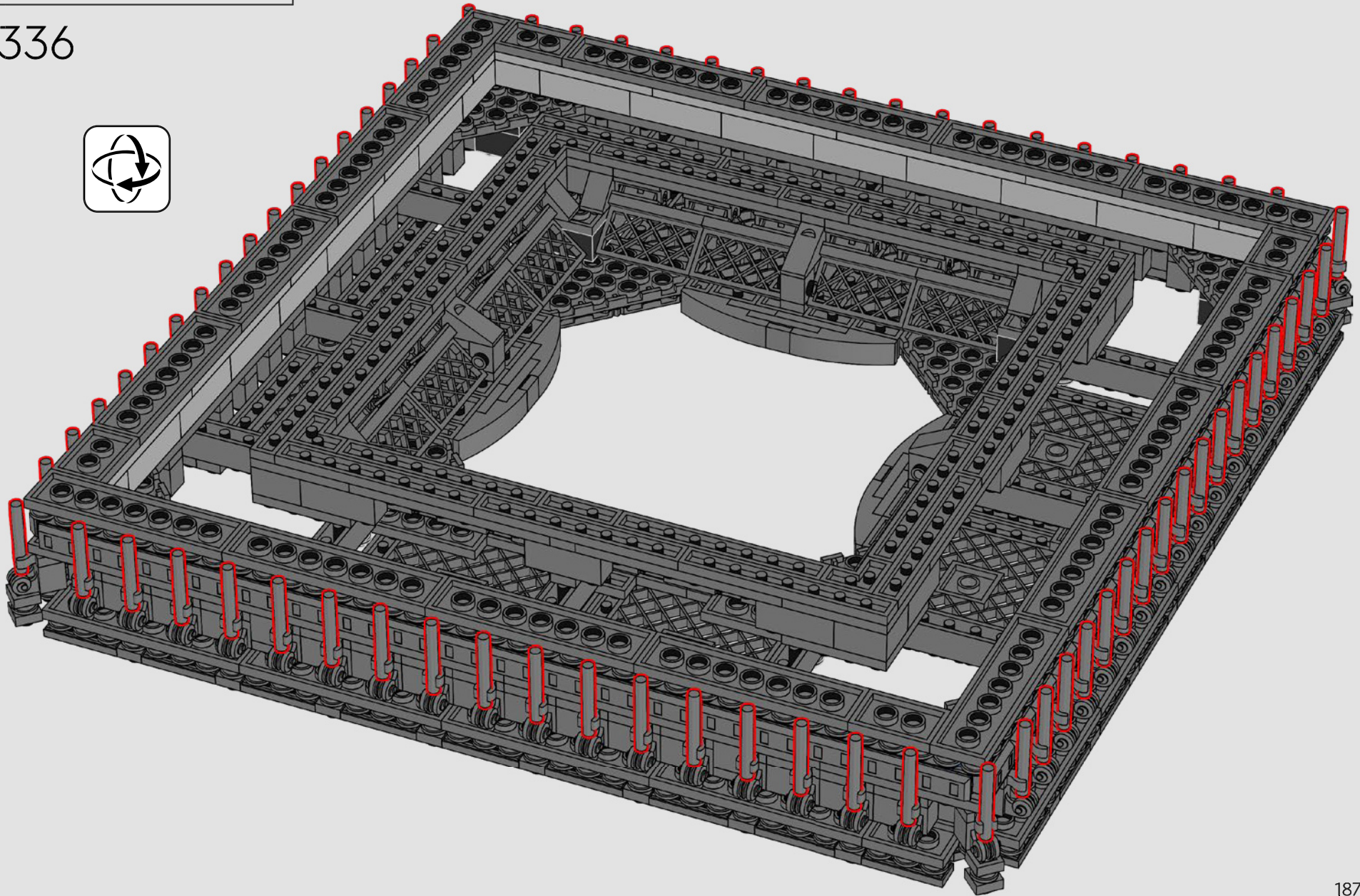

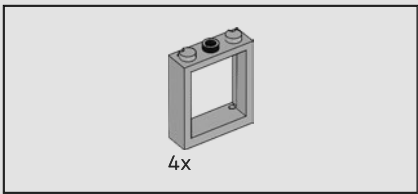

337

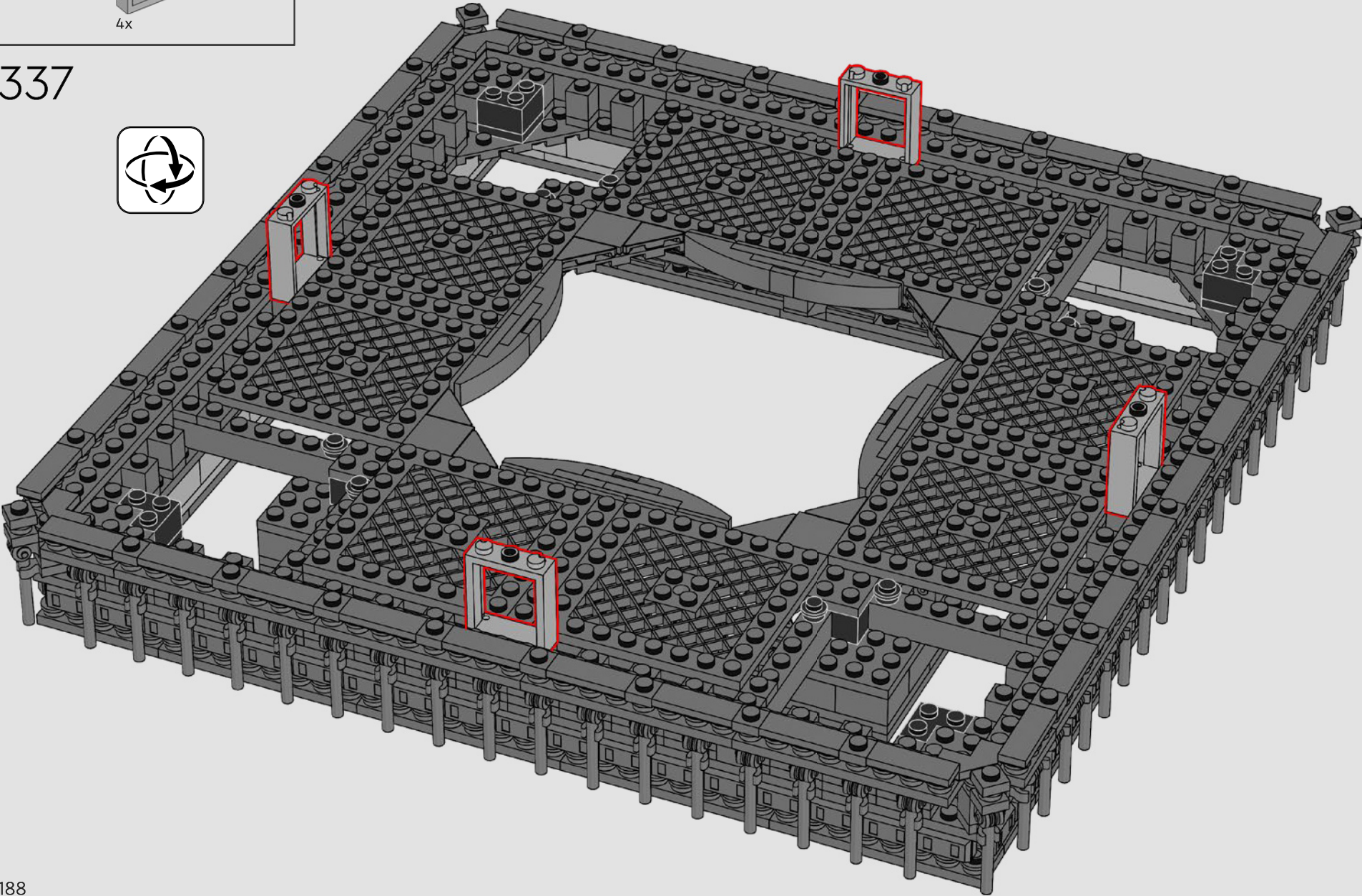

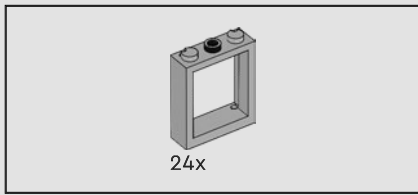

338

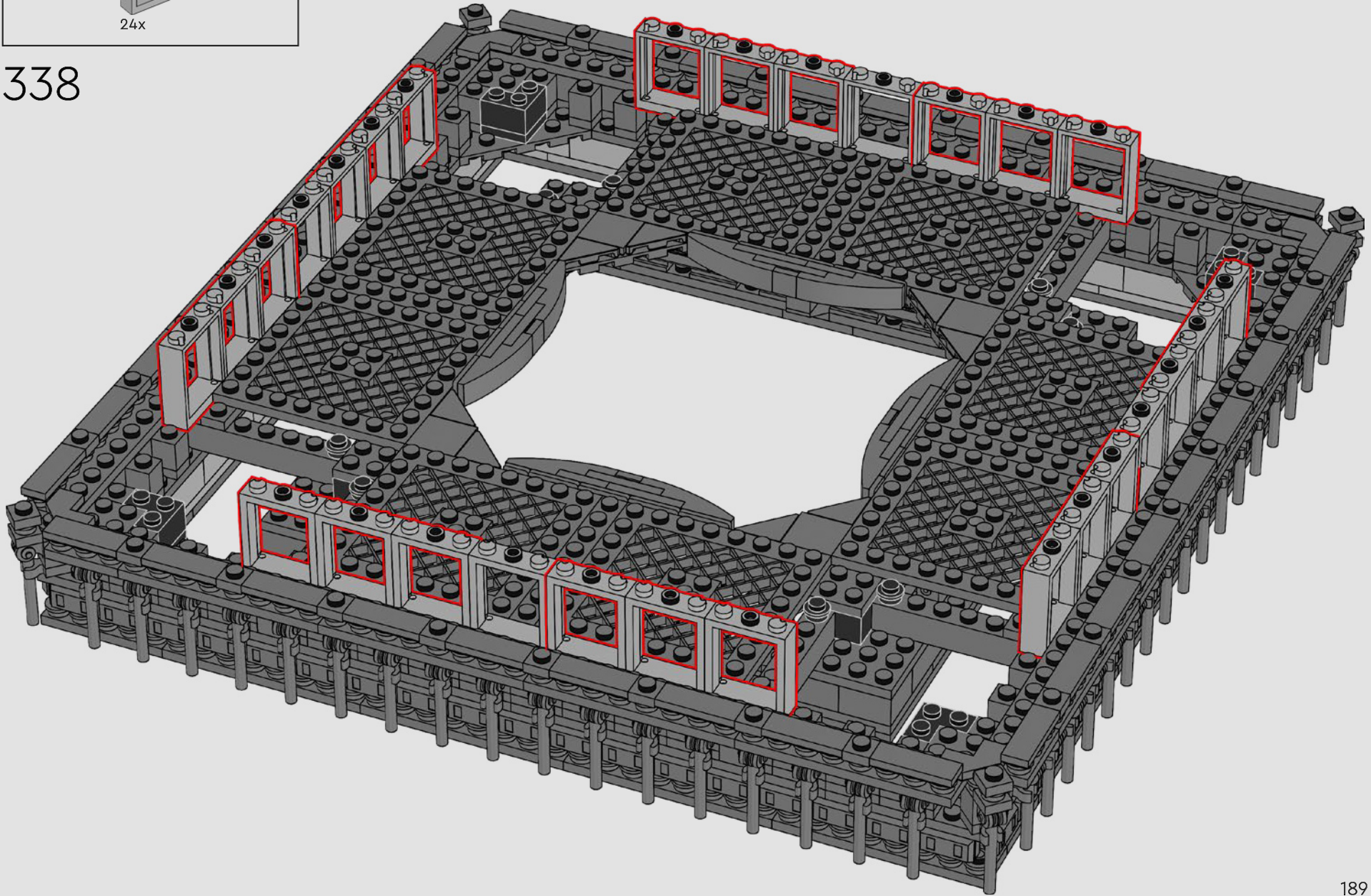

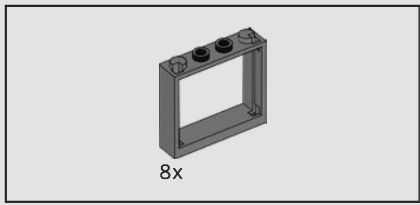

339

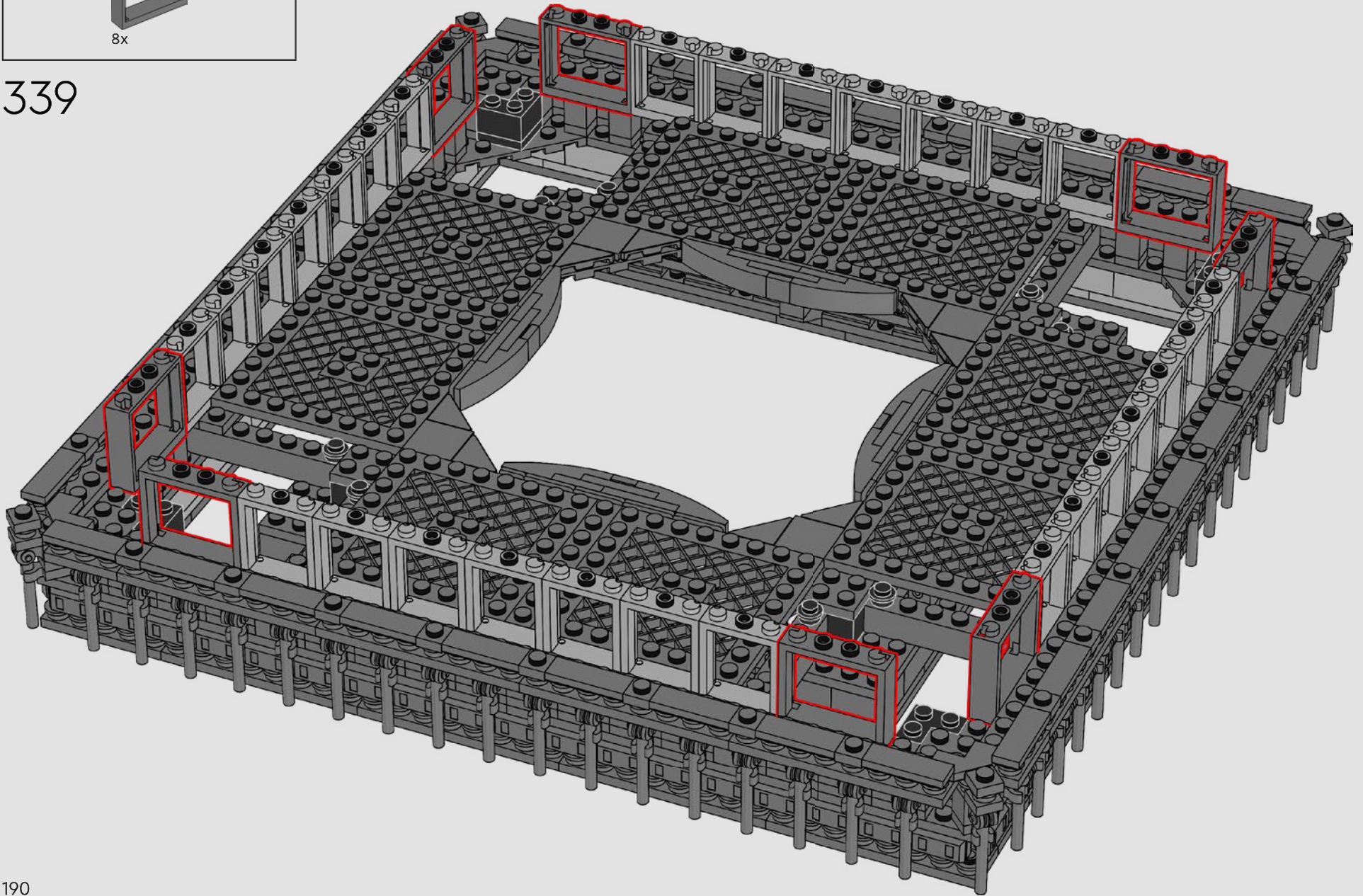

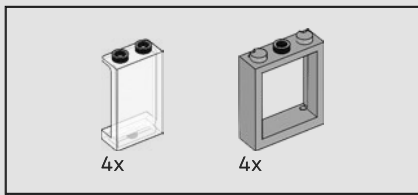

340

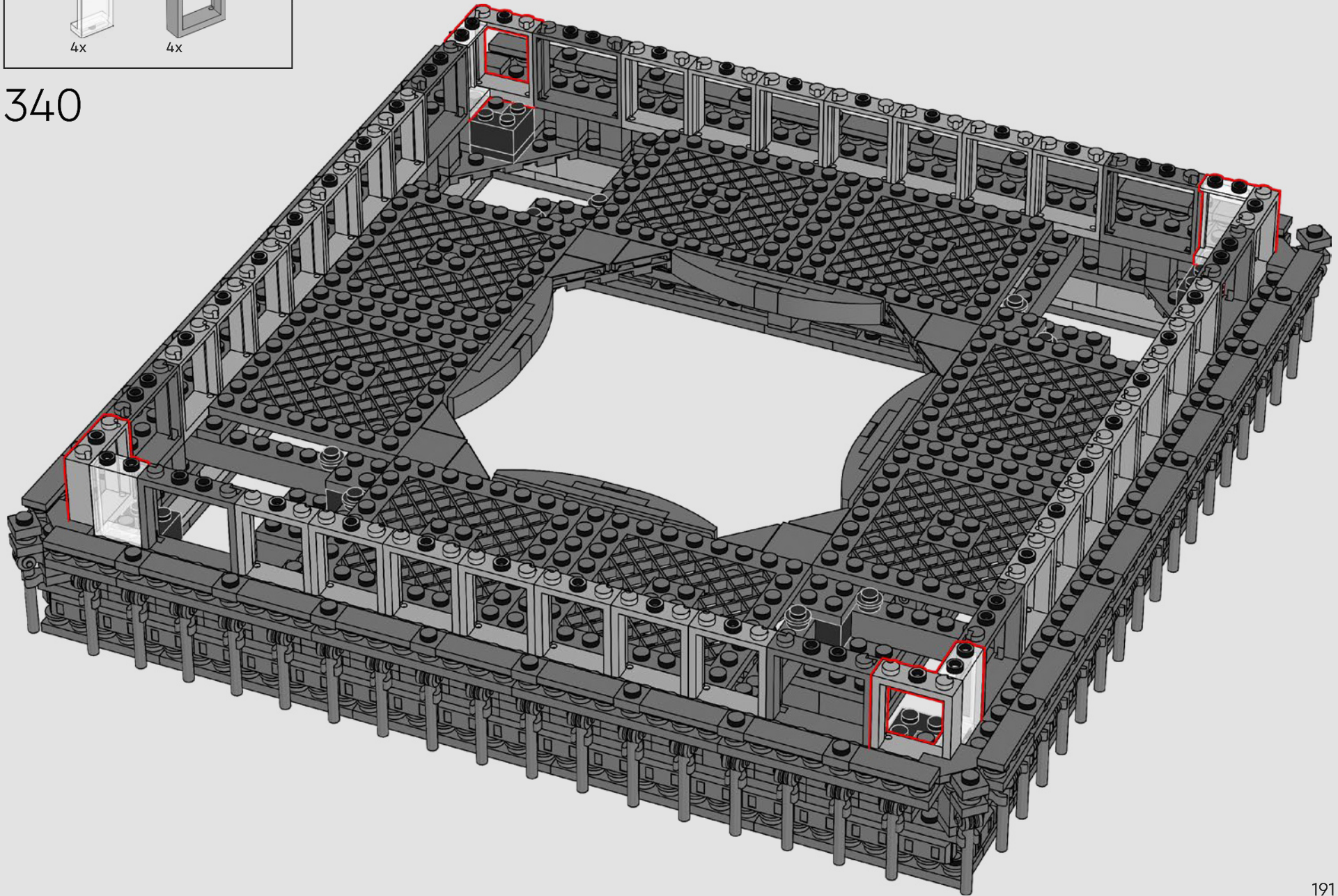

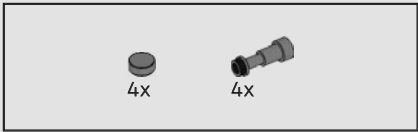

341

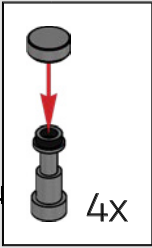
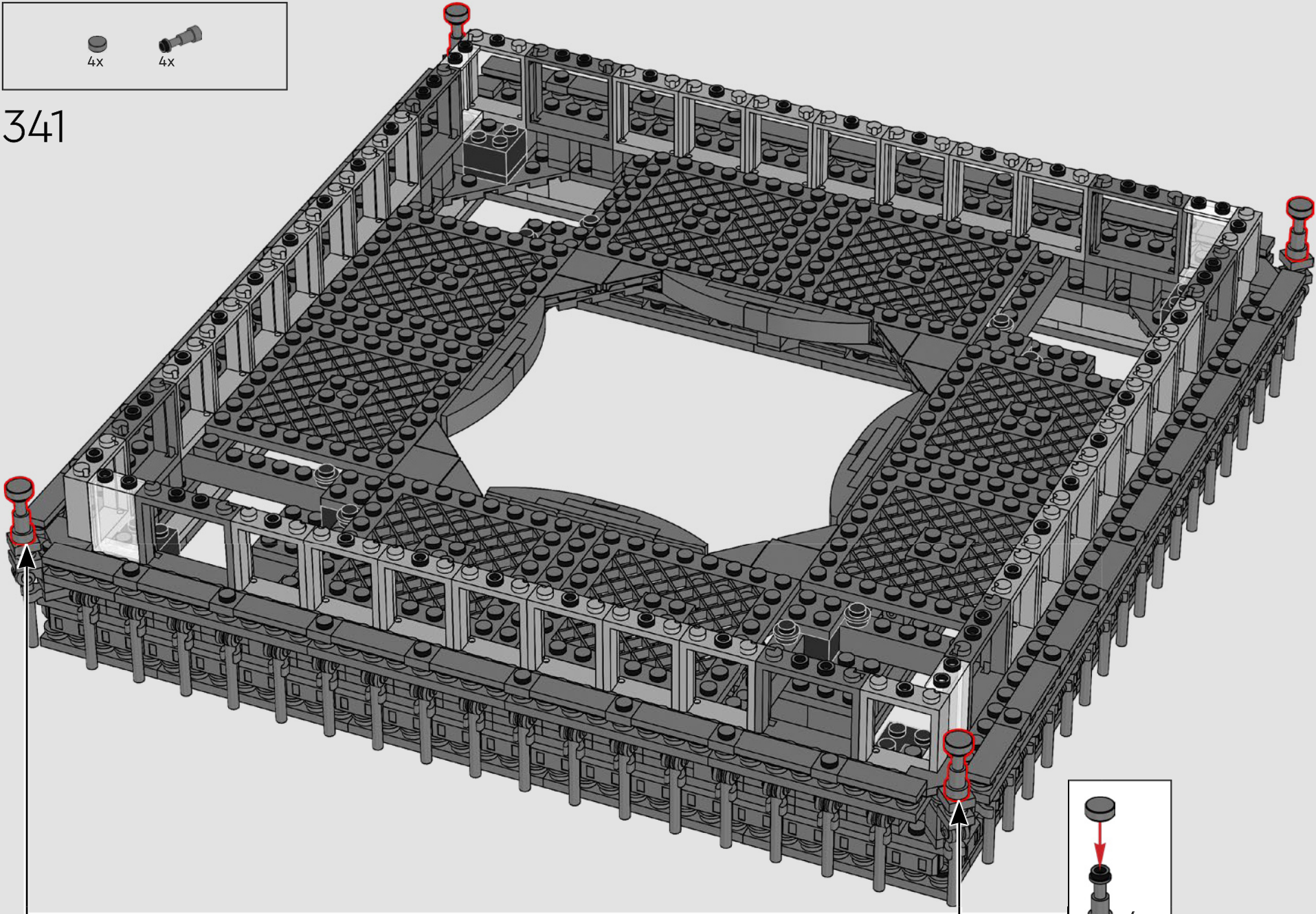



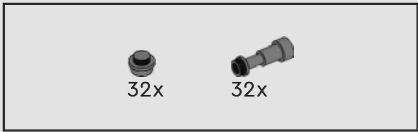

342

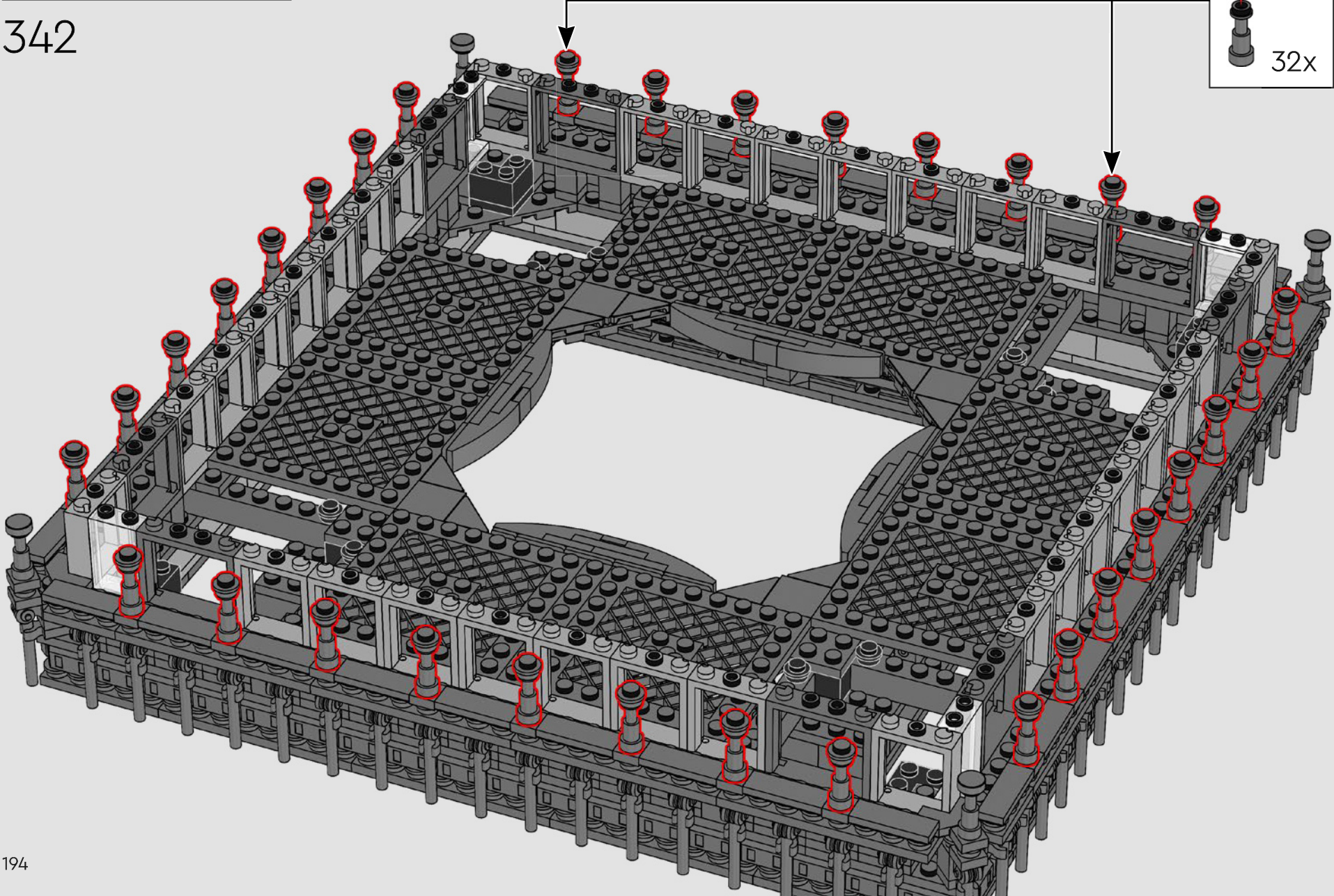
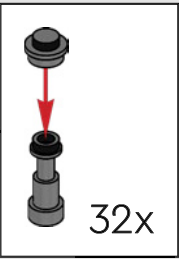

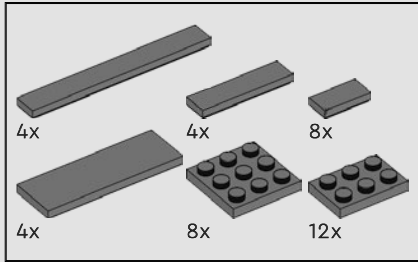
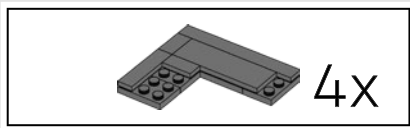

343

1

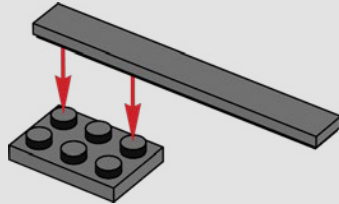

2

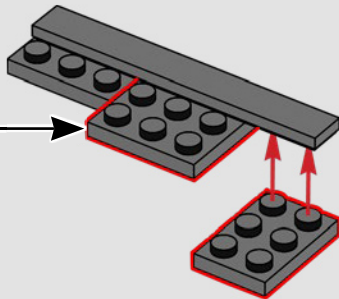
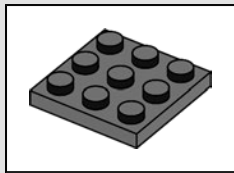

3

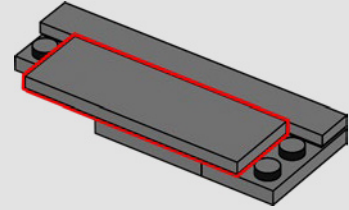

4

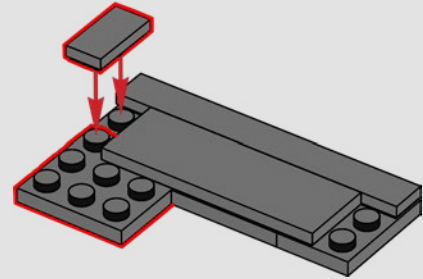

5

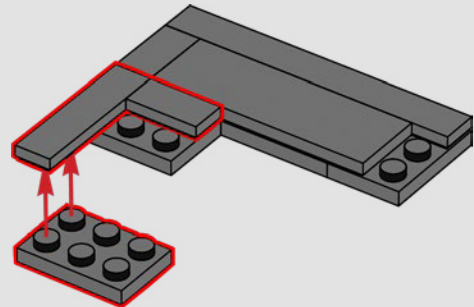

4X

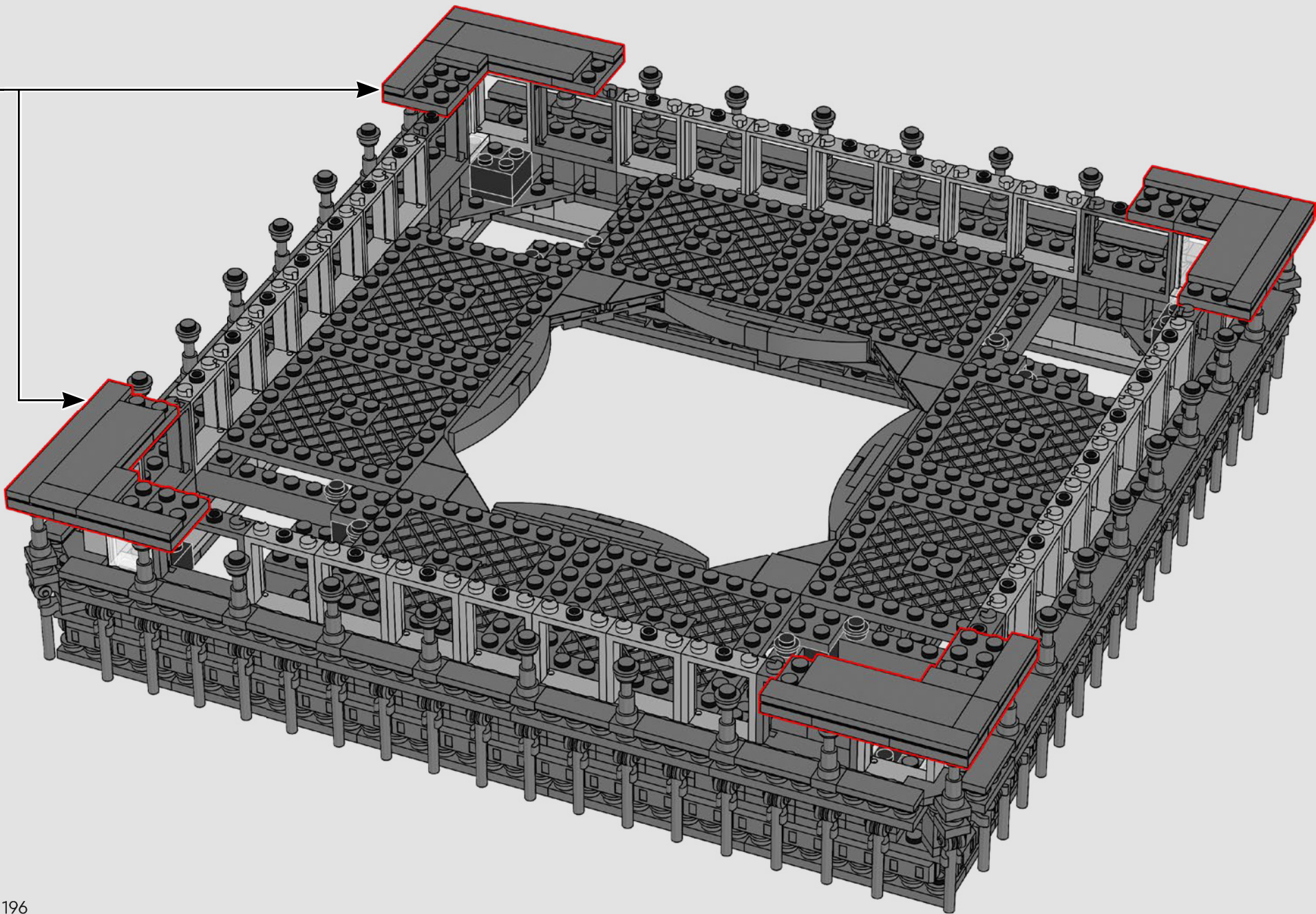

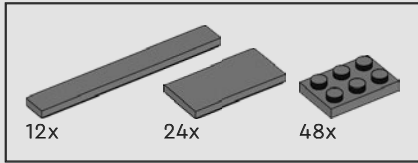
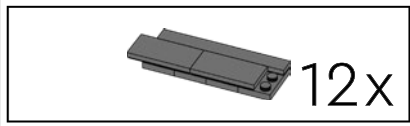

344

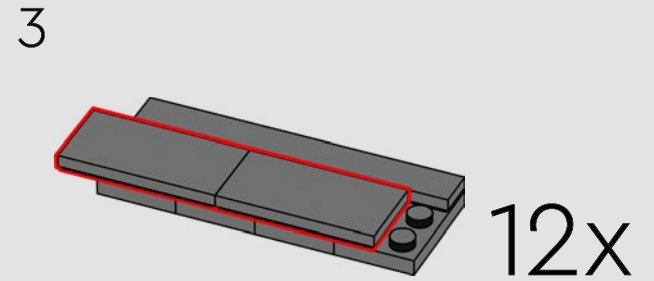
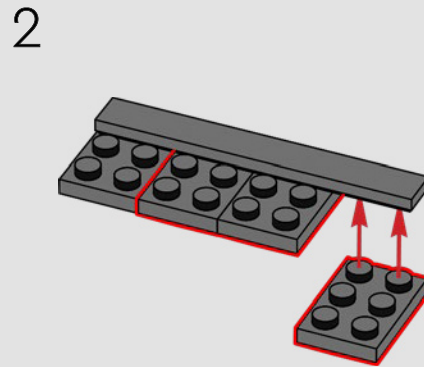
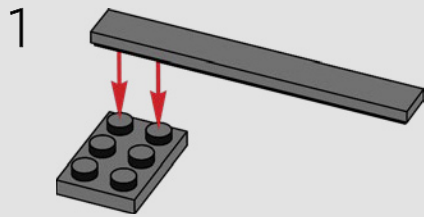

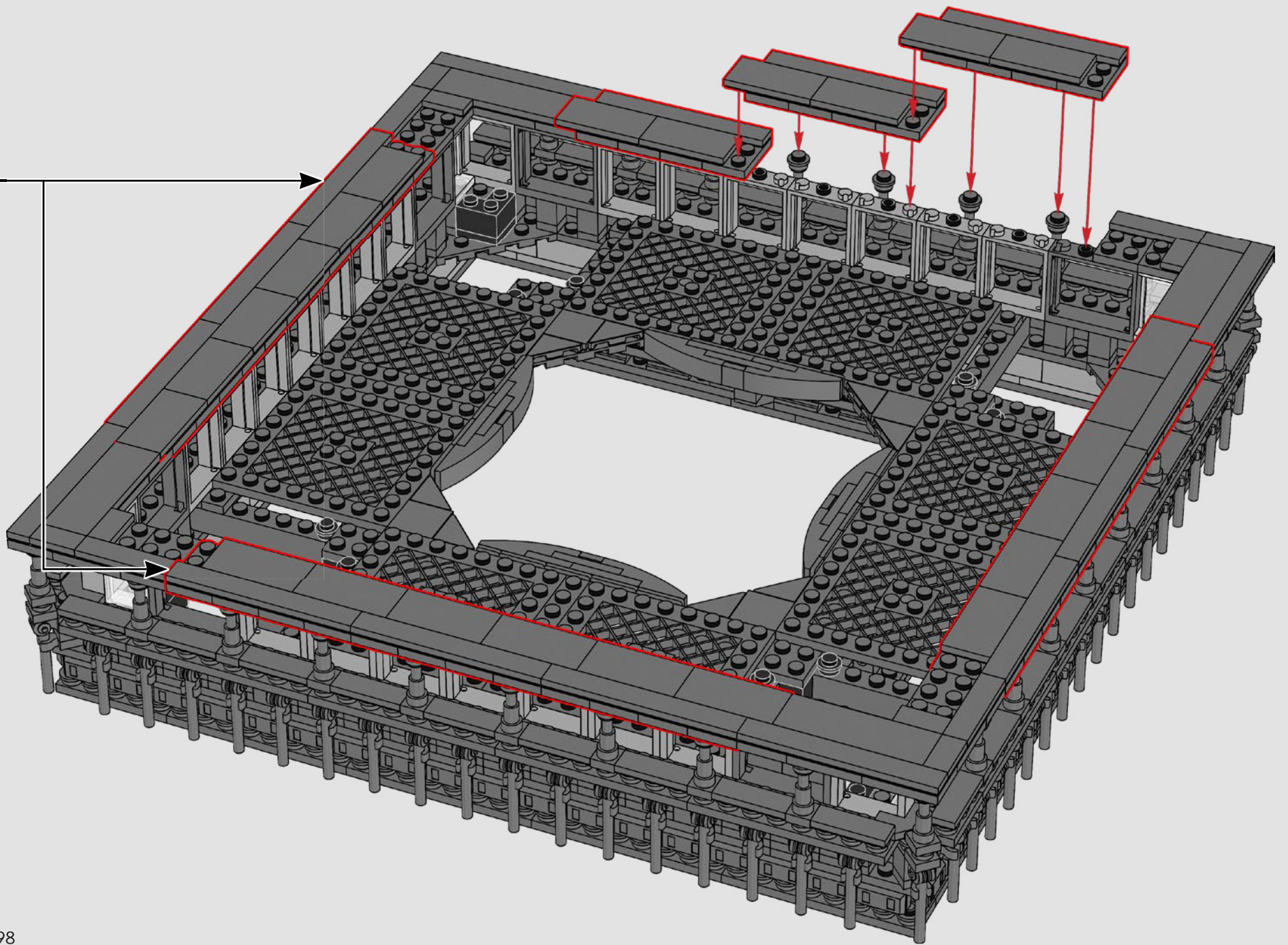

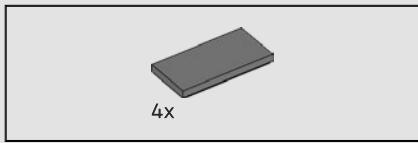

345

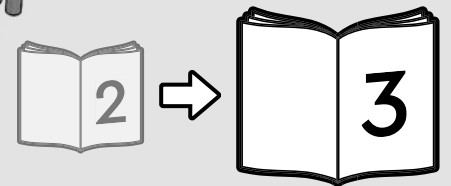
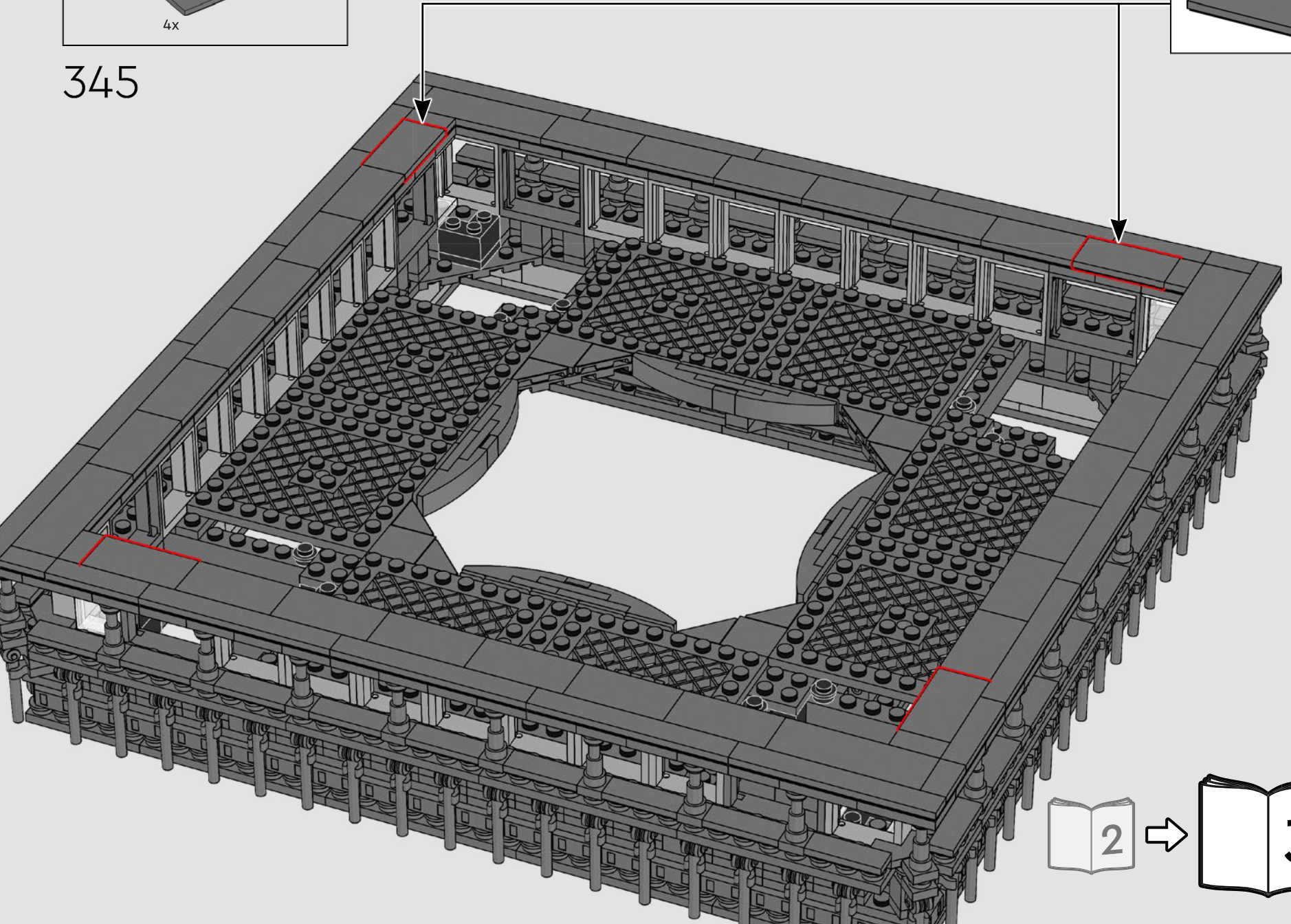
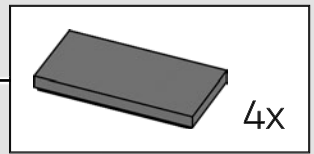

La tour
Eiffel

Torre
Eiffel

