

4000007

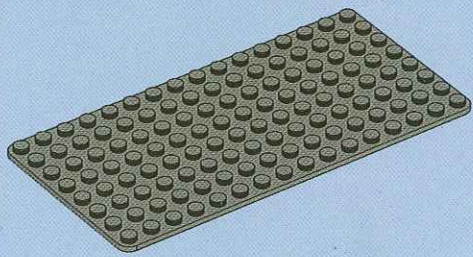

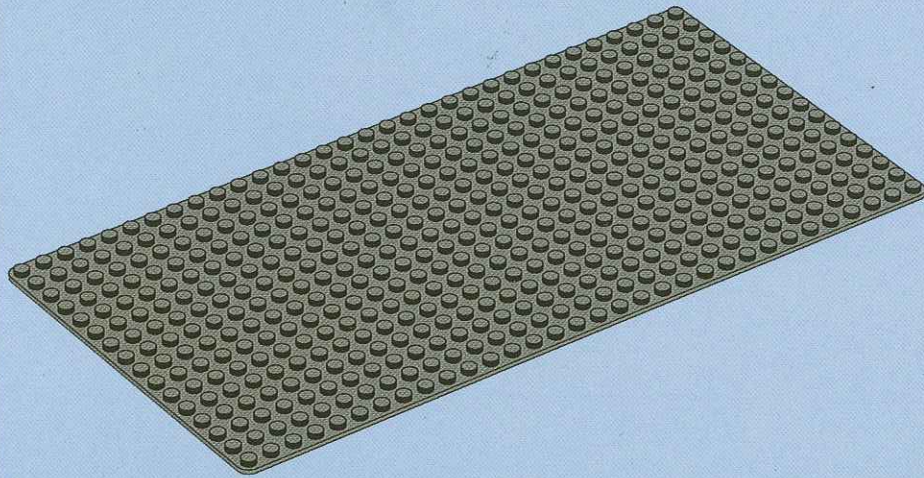

2x



1x

1

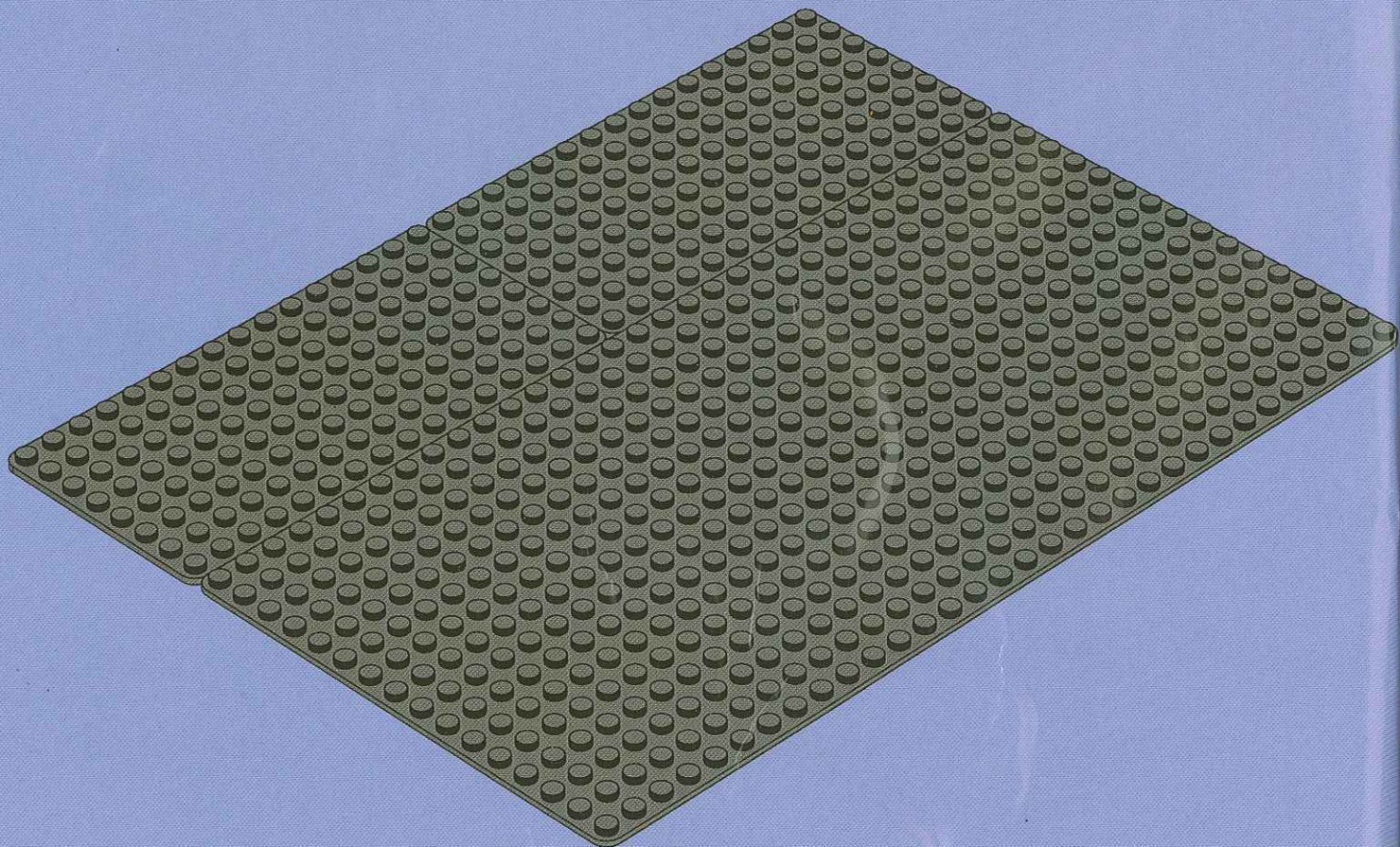

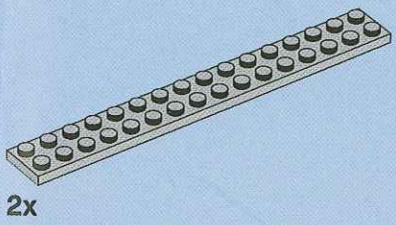
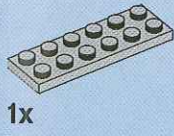
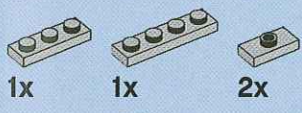
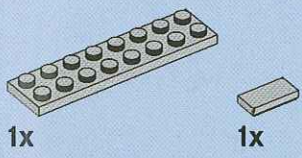
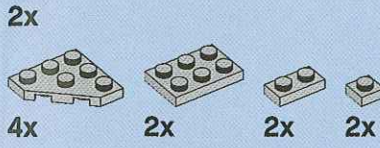
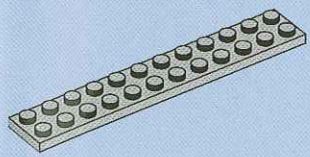
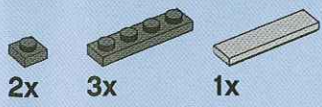

2

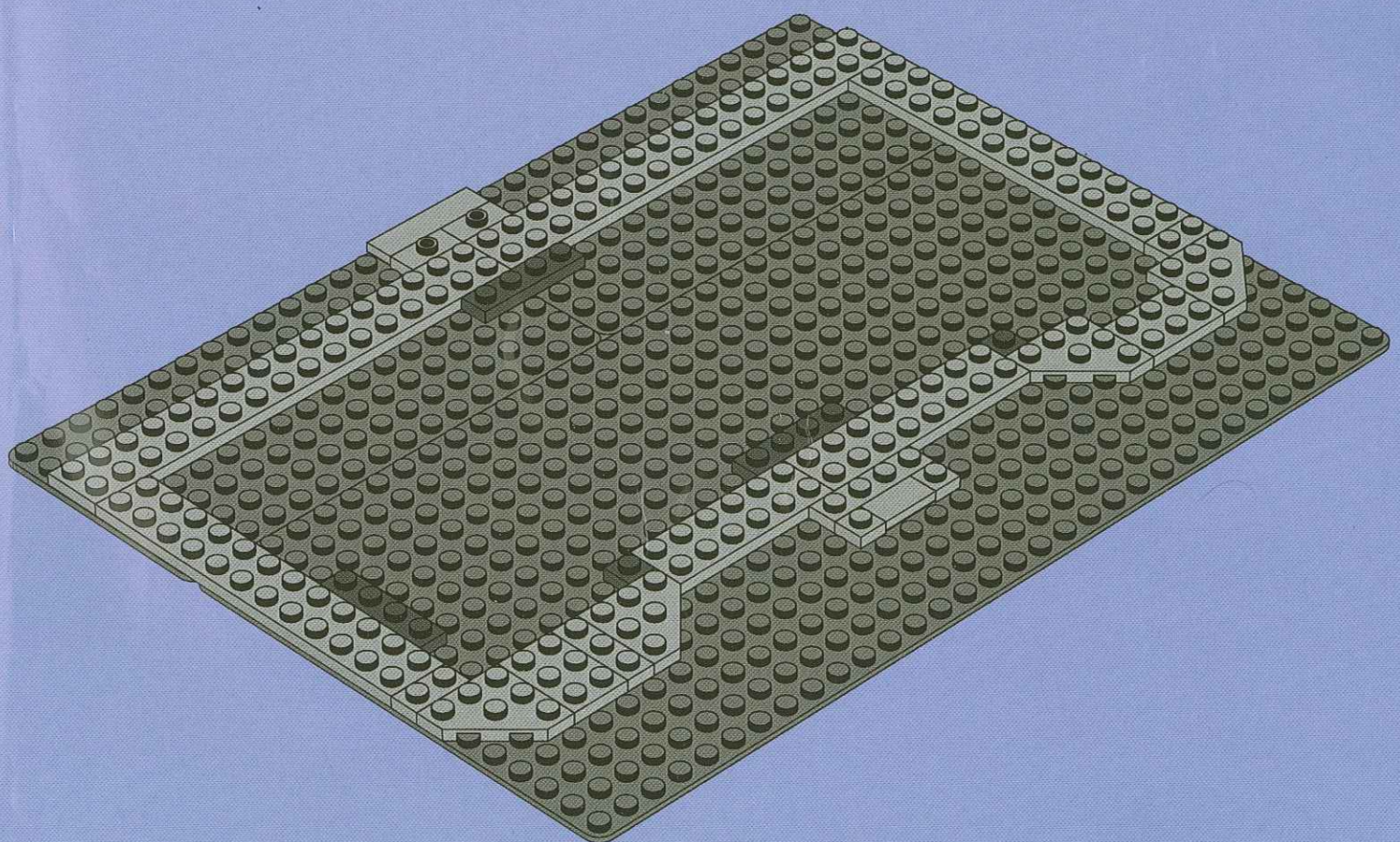

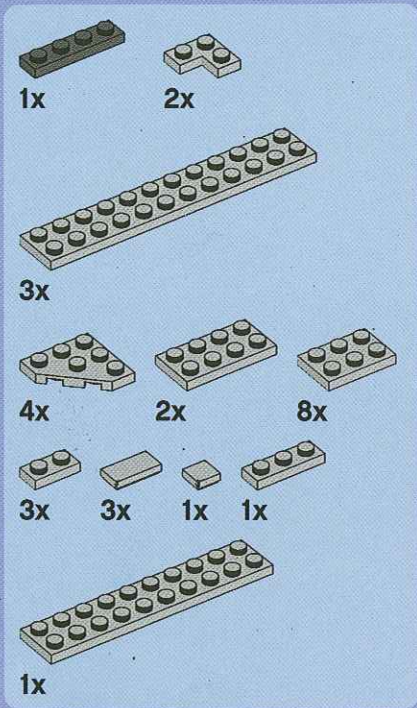

3

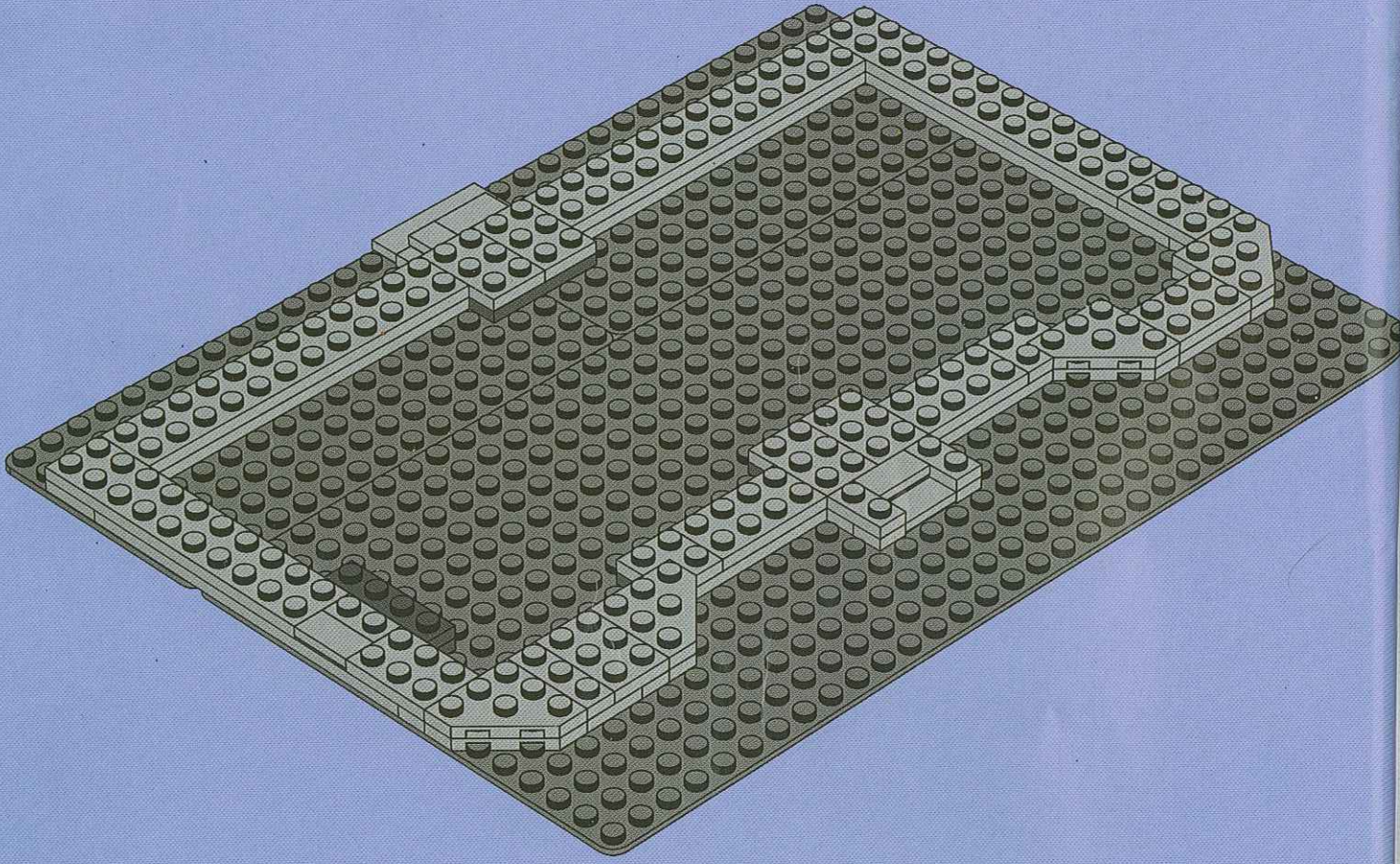

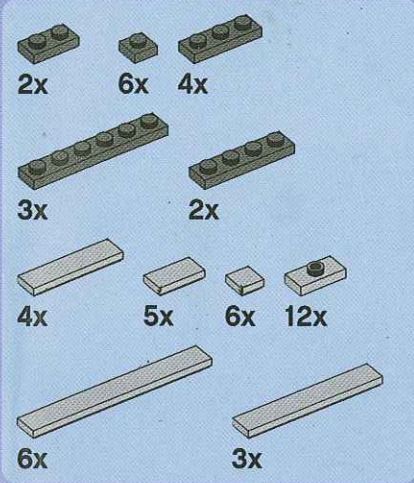

4

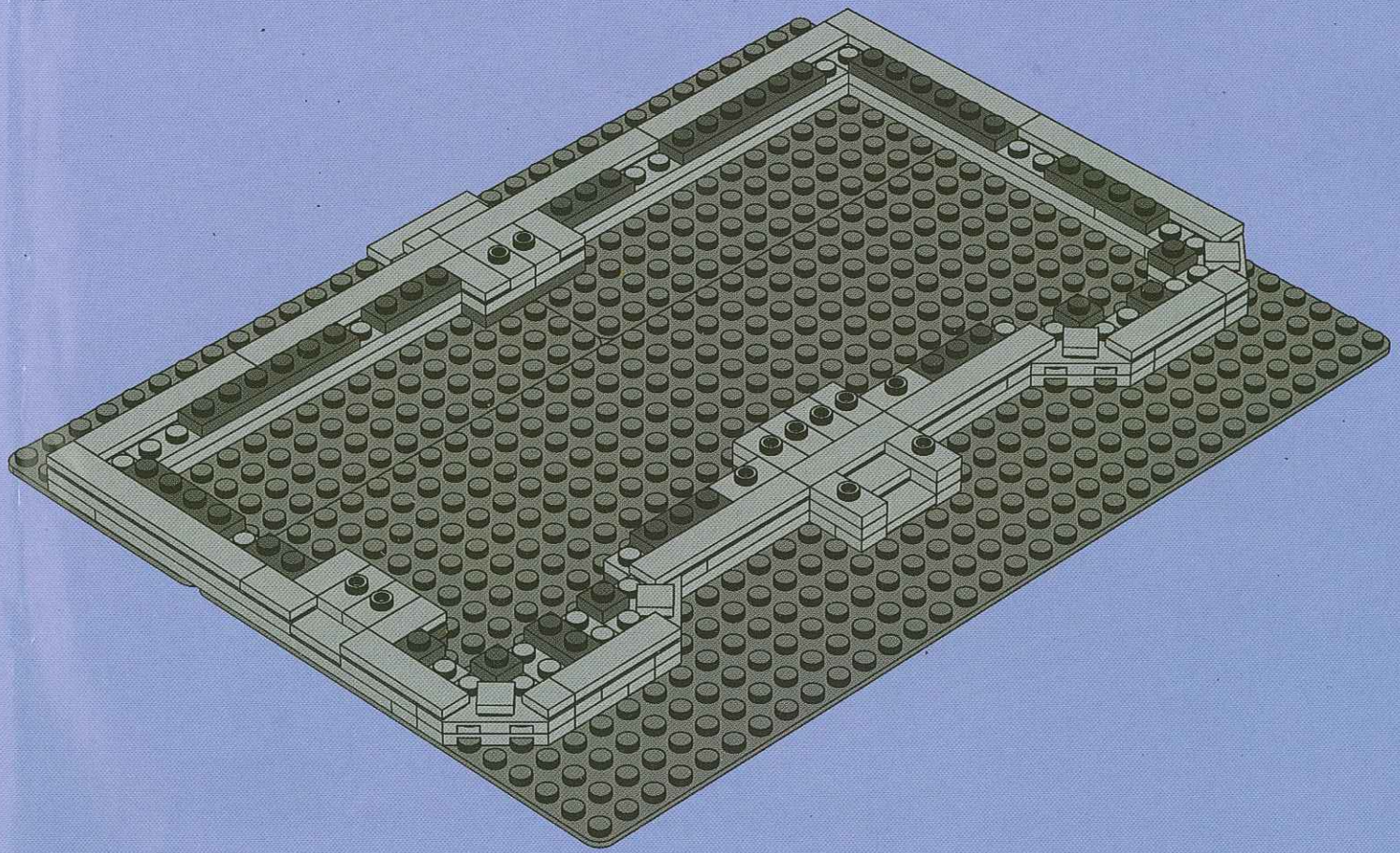

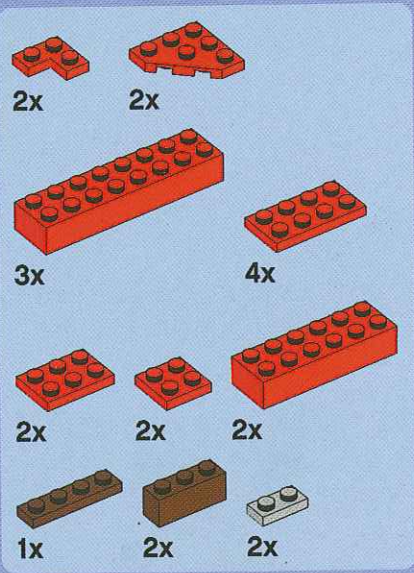

5

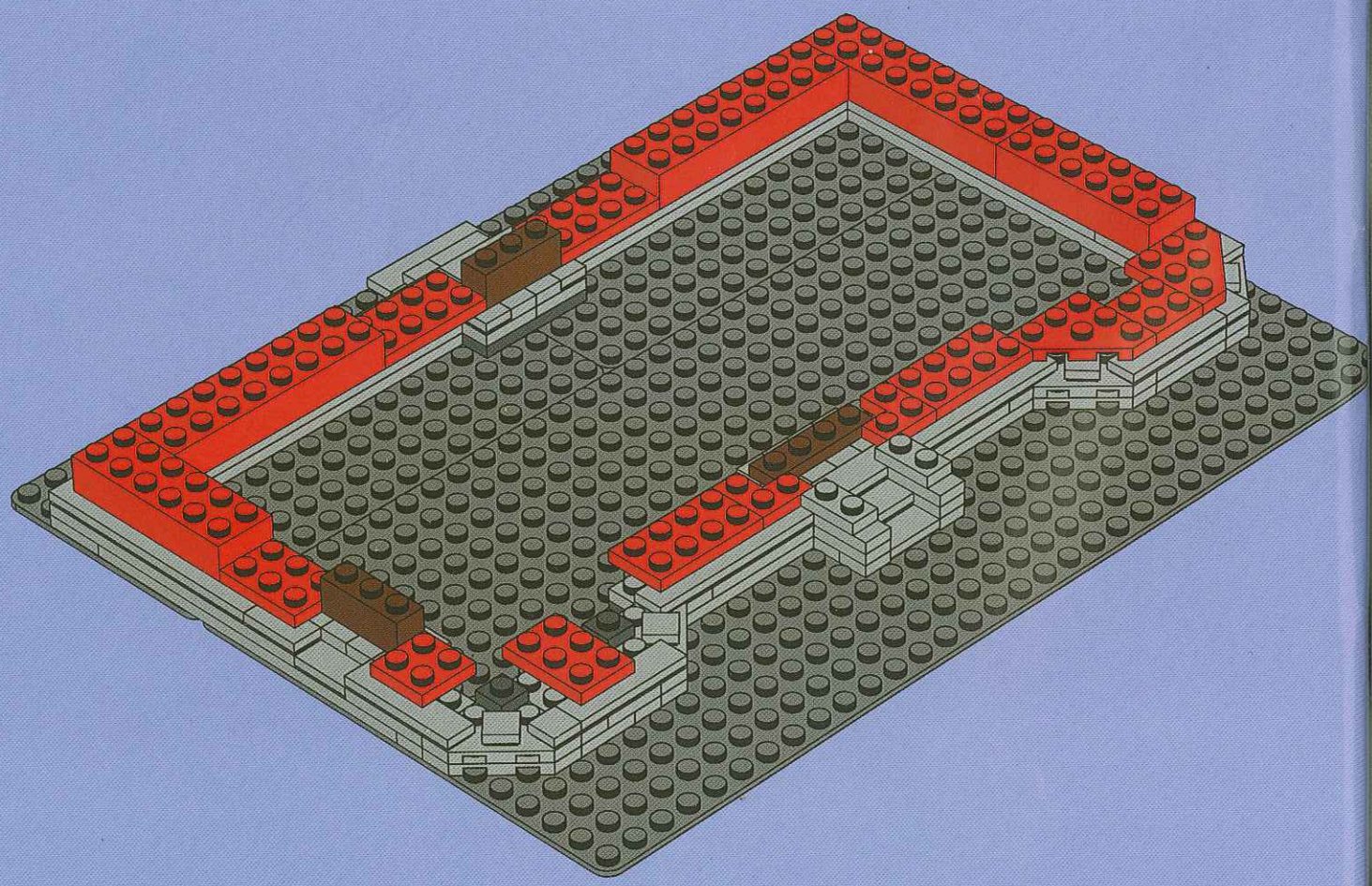

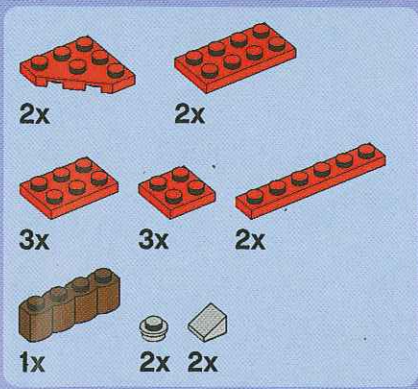

6

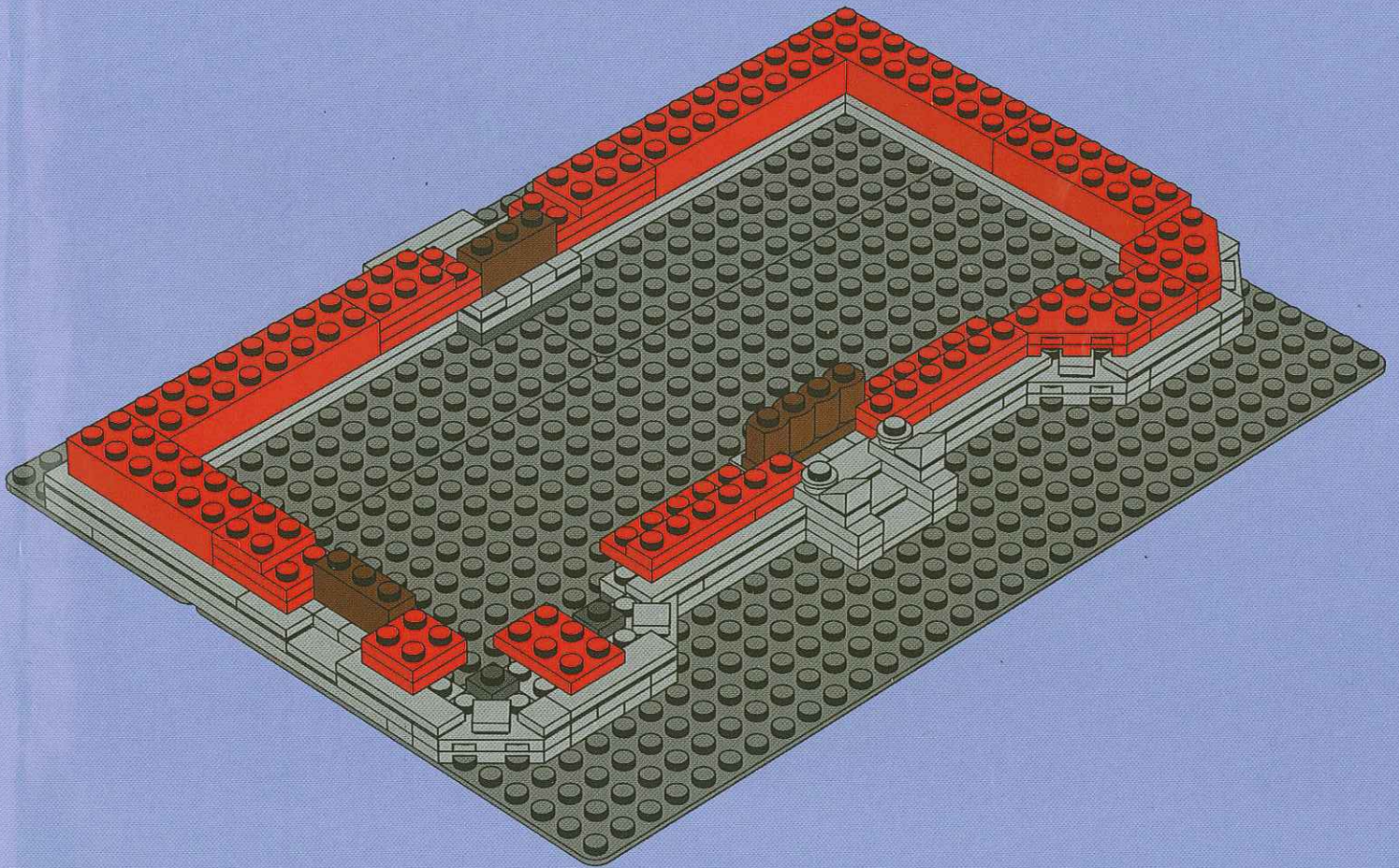



1x



1x



2x



4x



2x



2x



2x

7

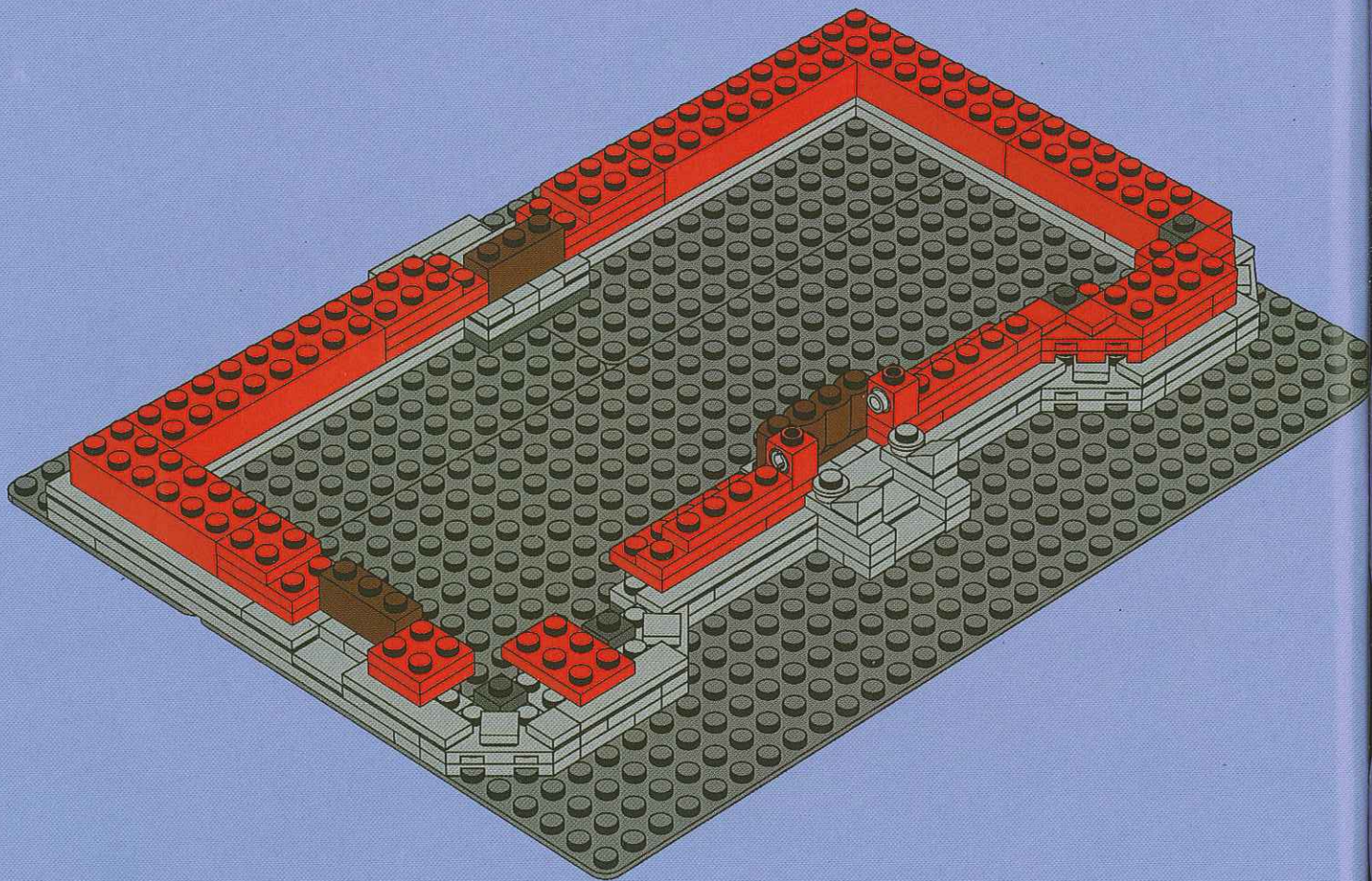



1x



1x



1x



4x

8

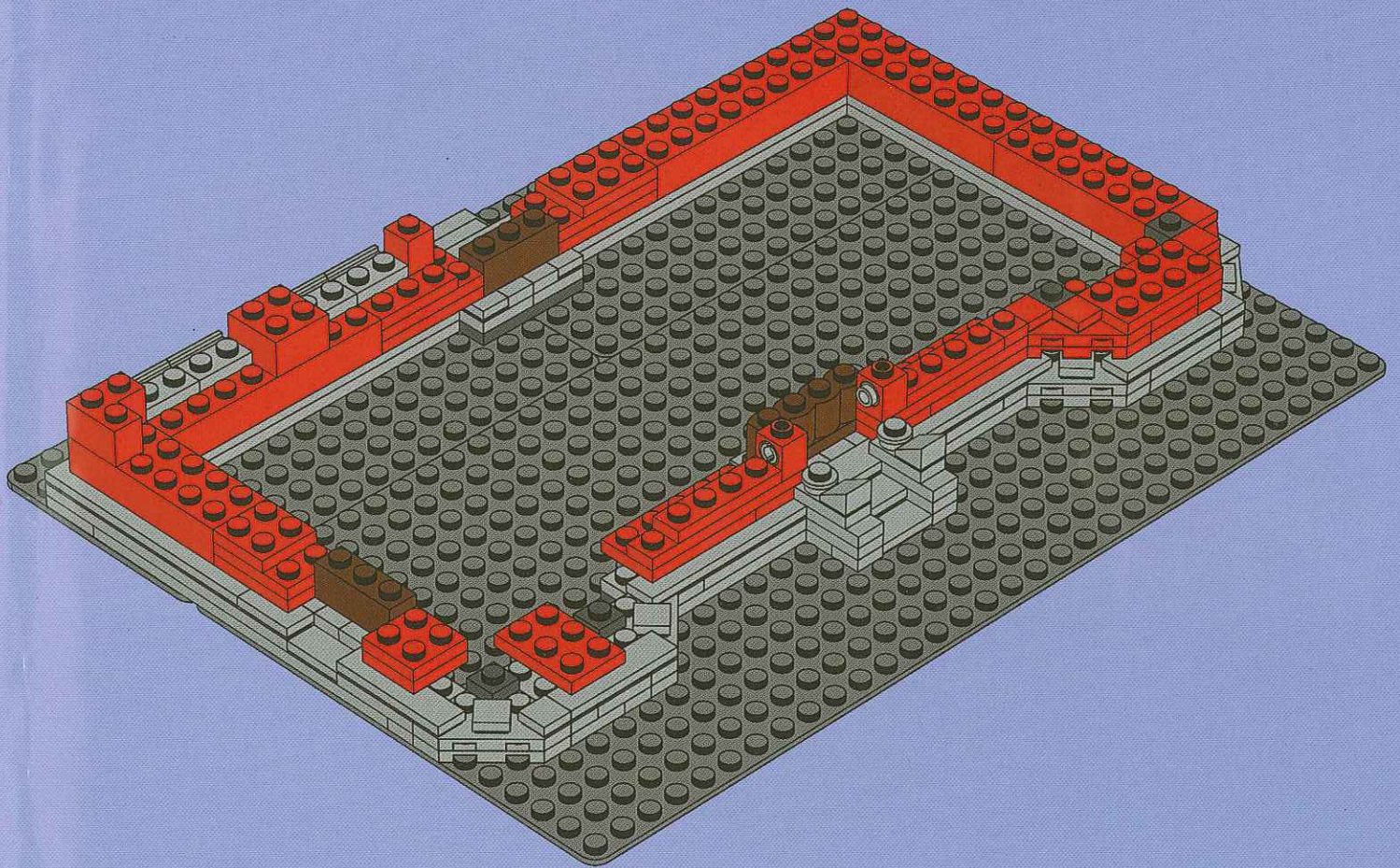



1x



1x



9

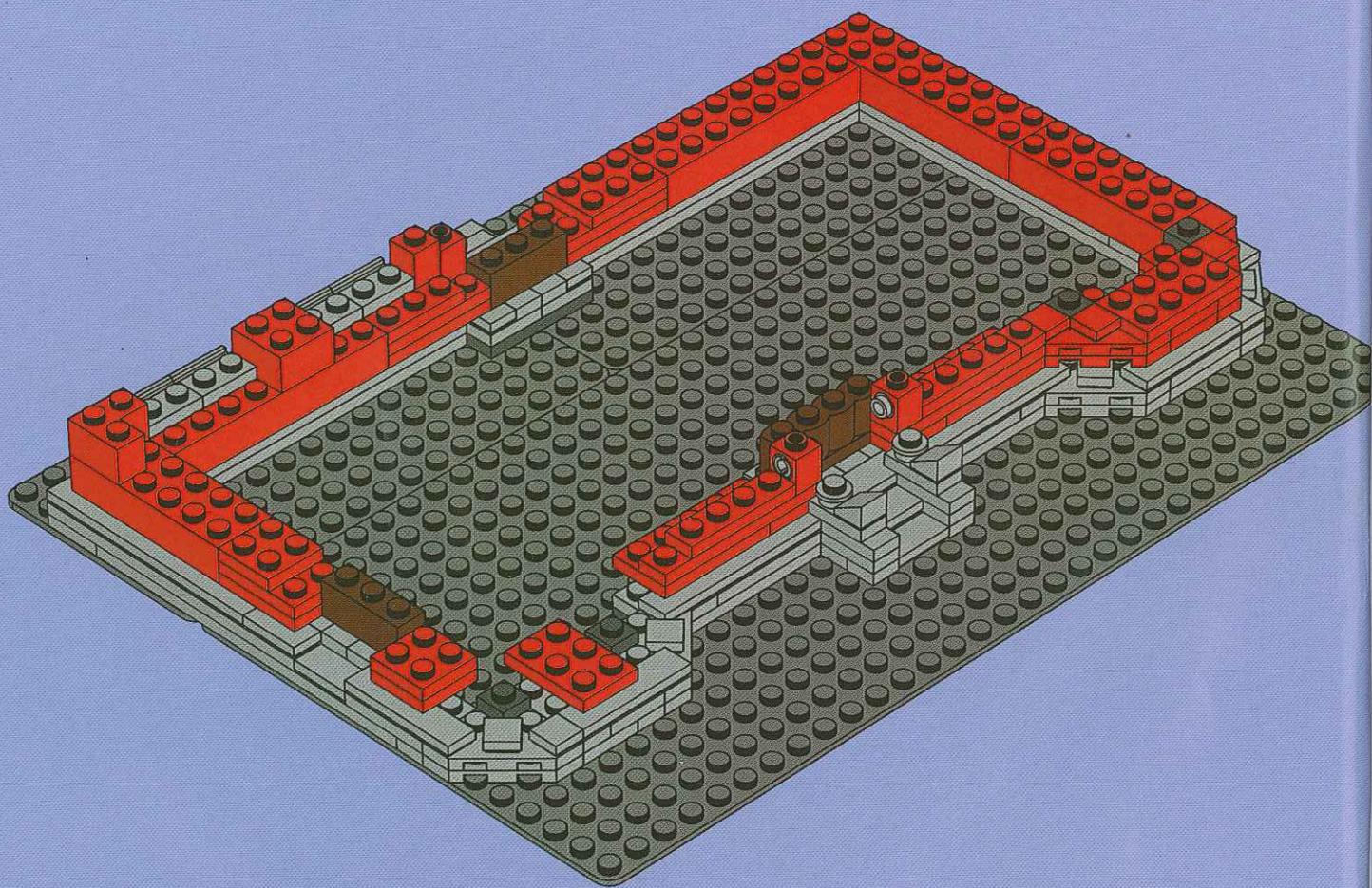



1x



1x



10

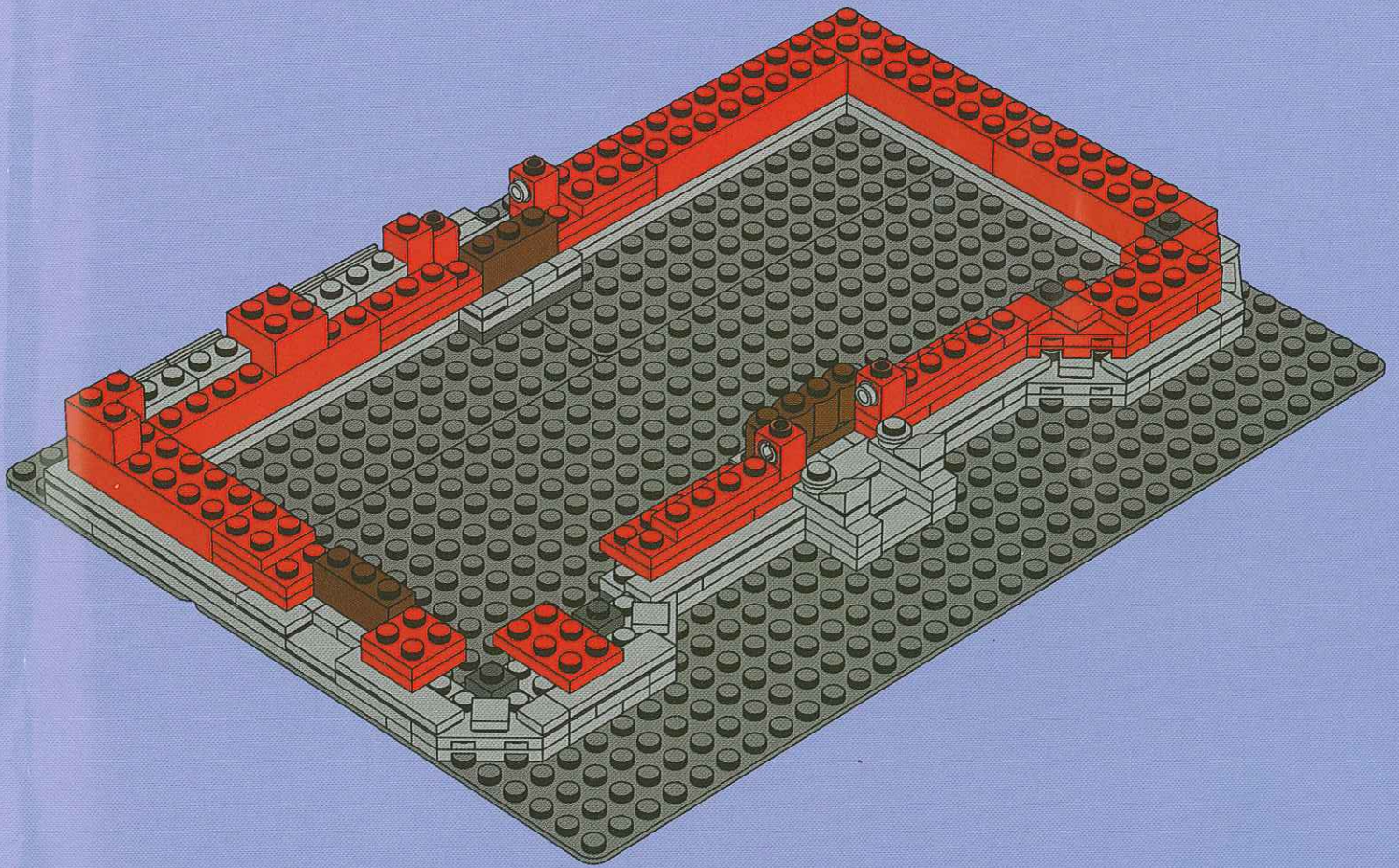

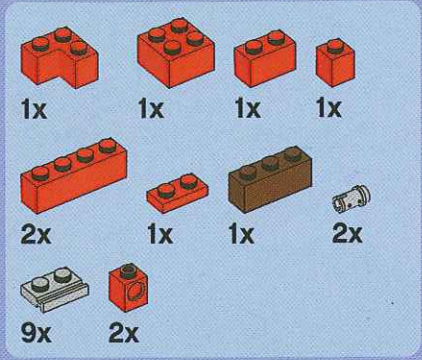

11

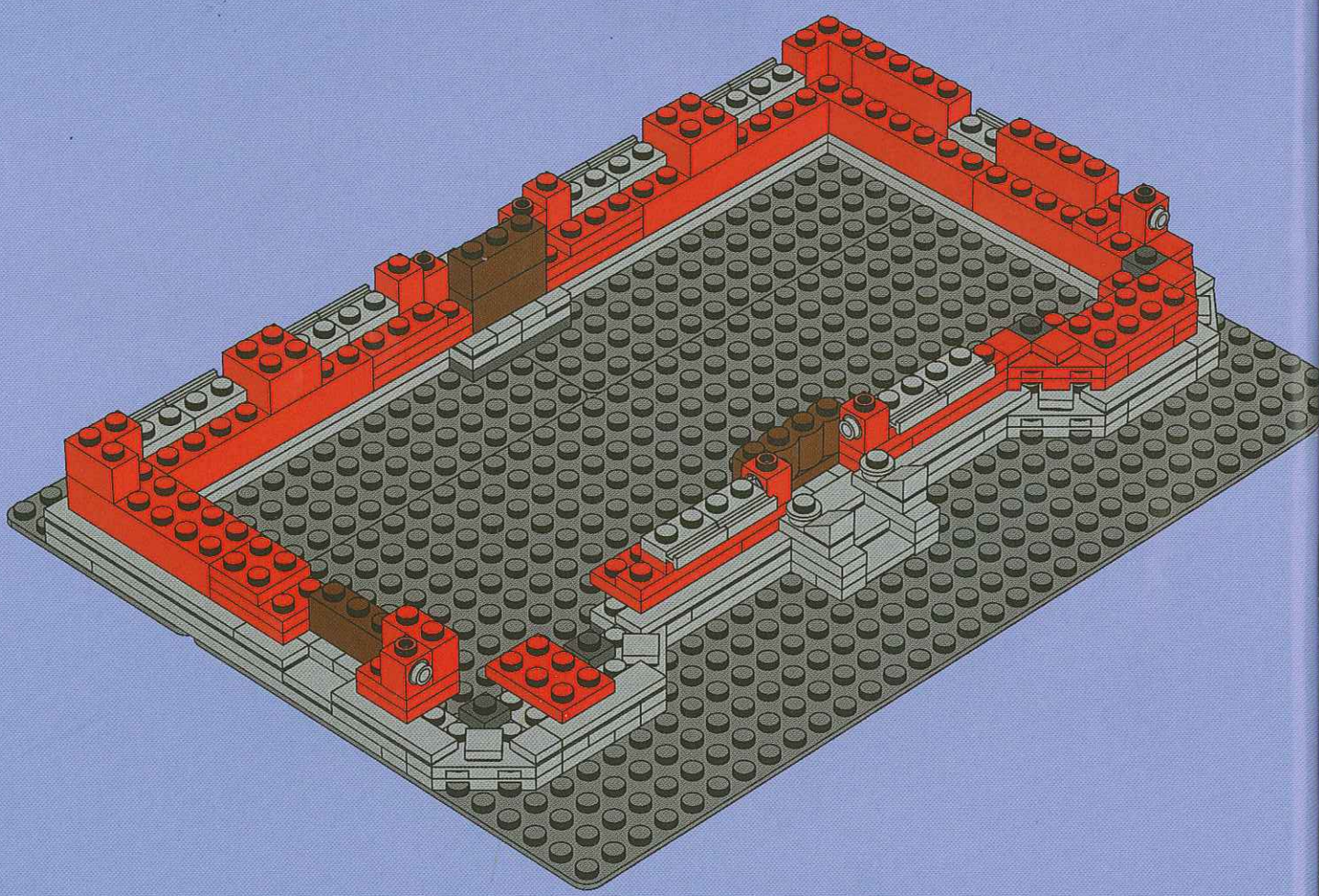



1x



1x



12

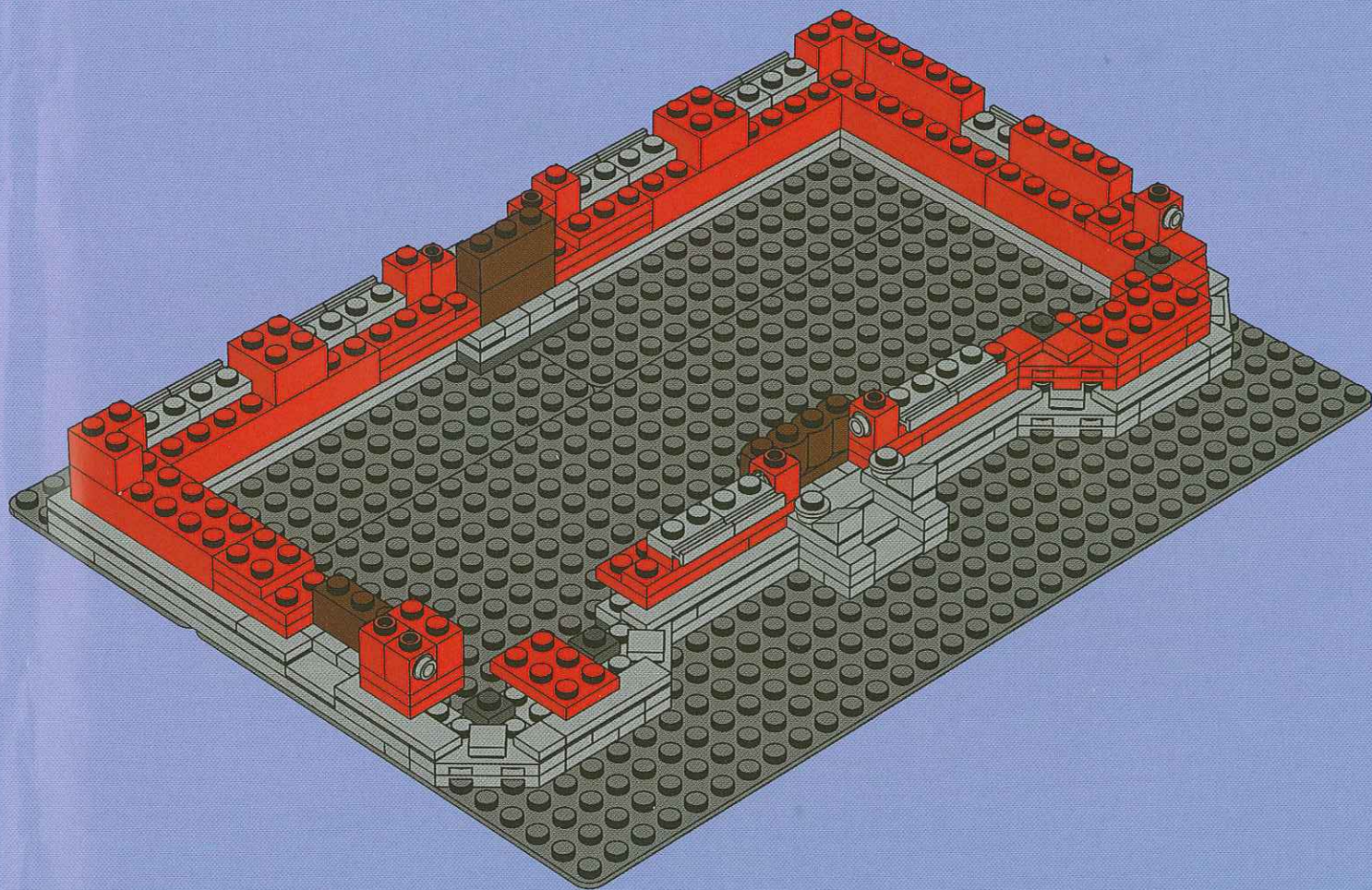

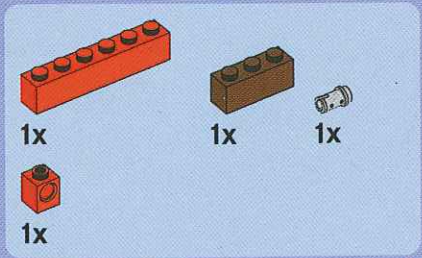

13

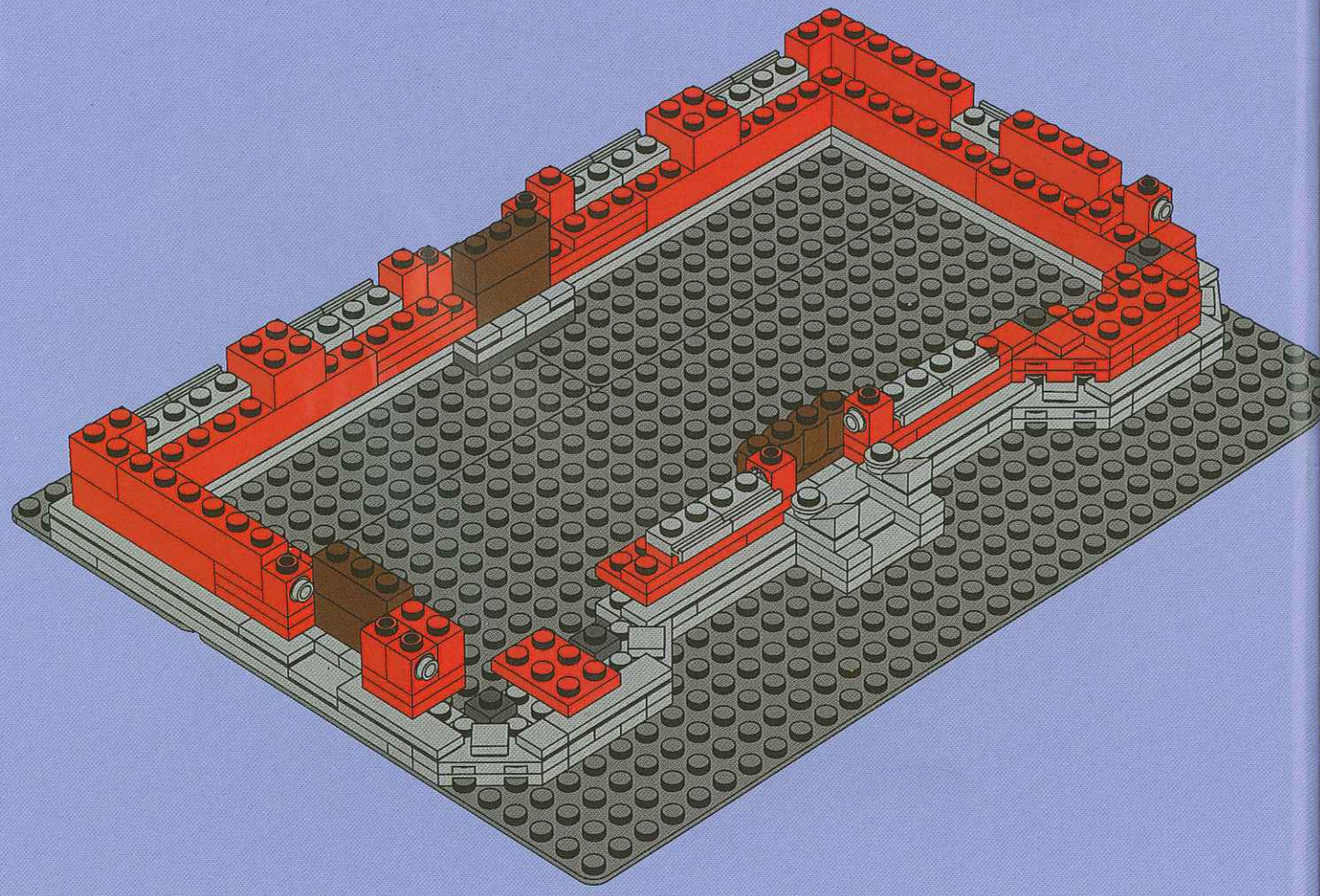

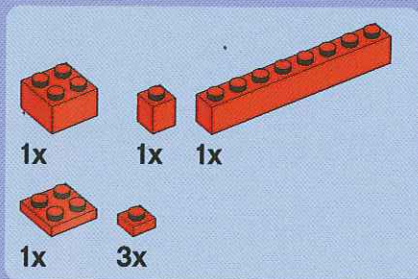

14

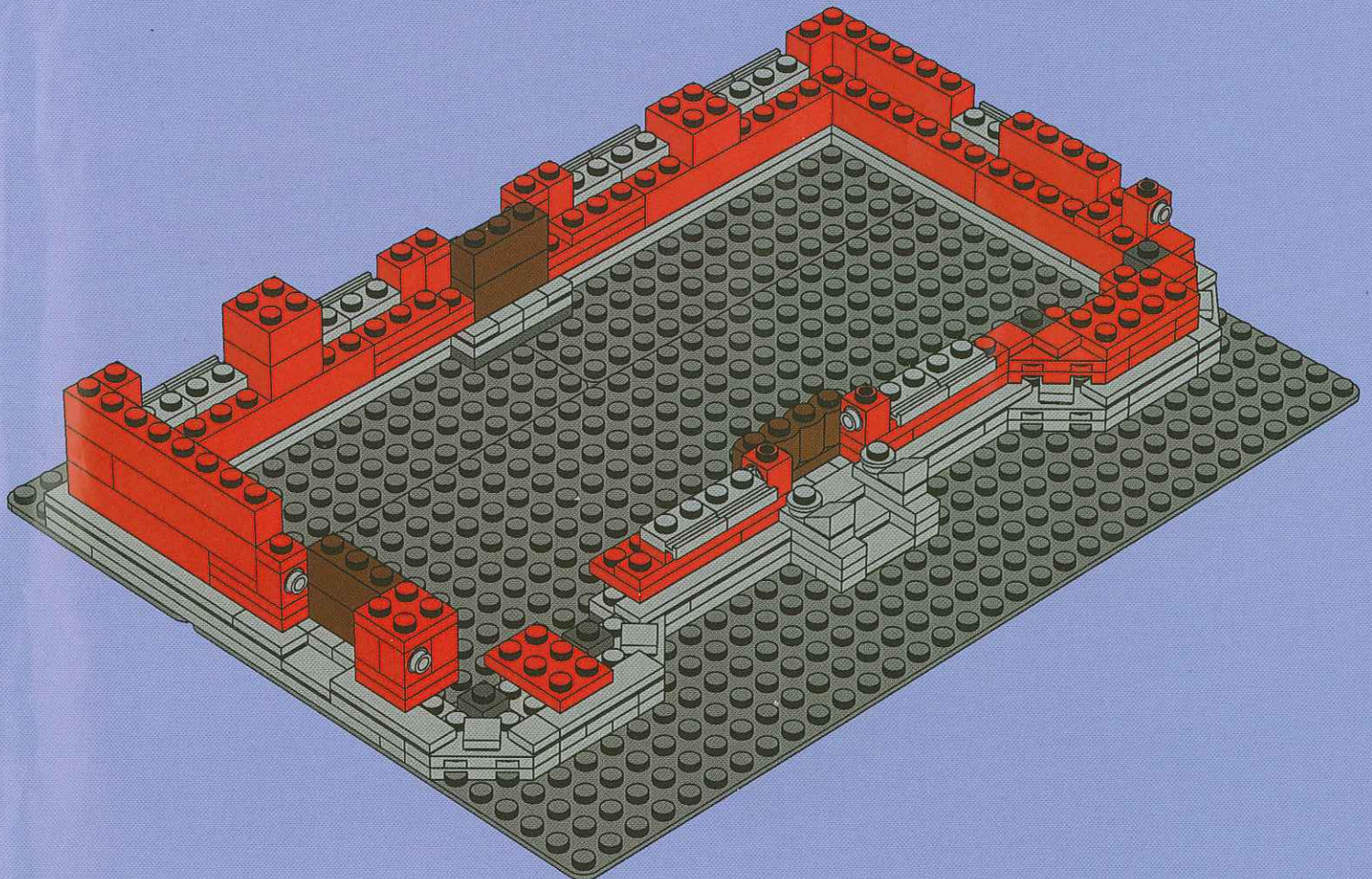



1x



1x



1x



1x



15

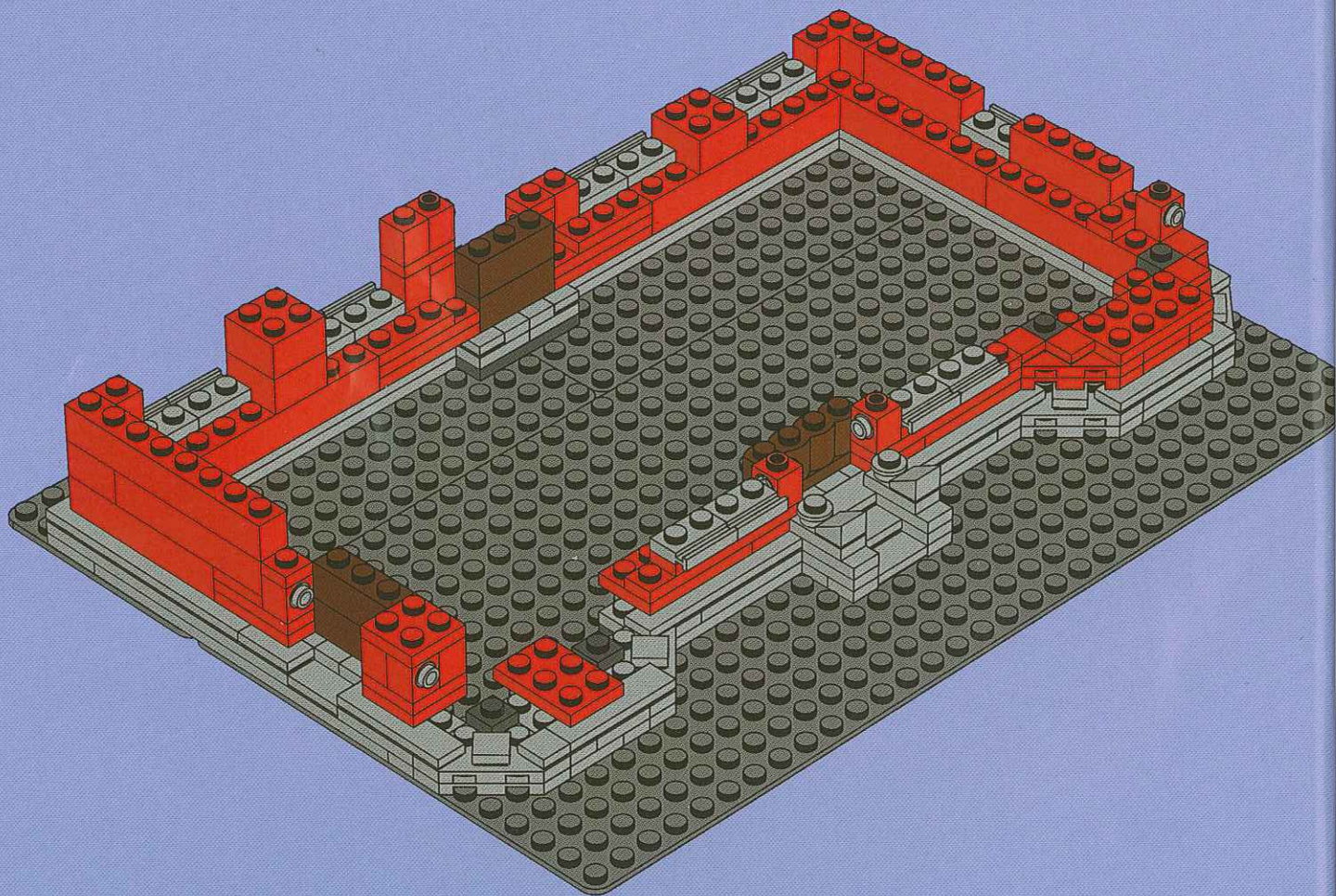



1x



1x



1x



1x



16

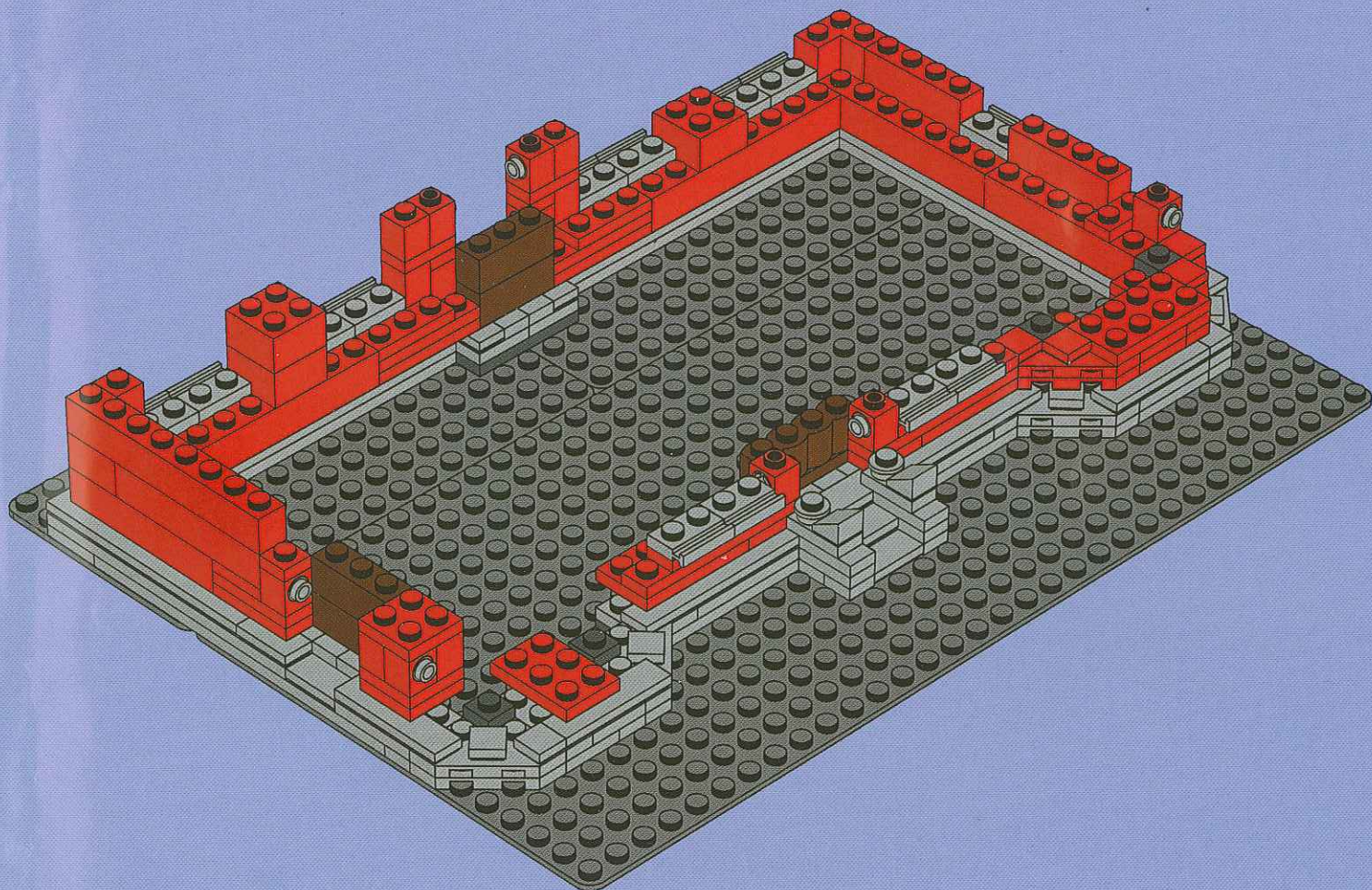

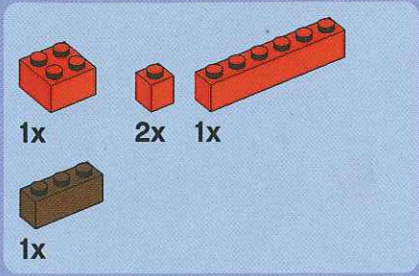

17

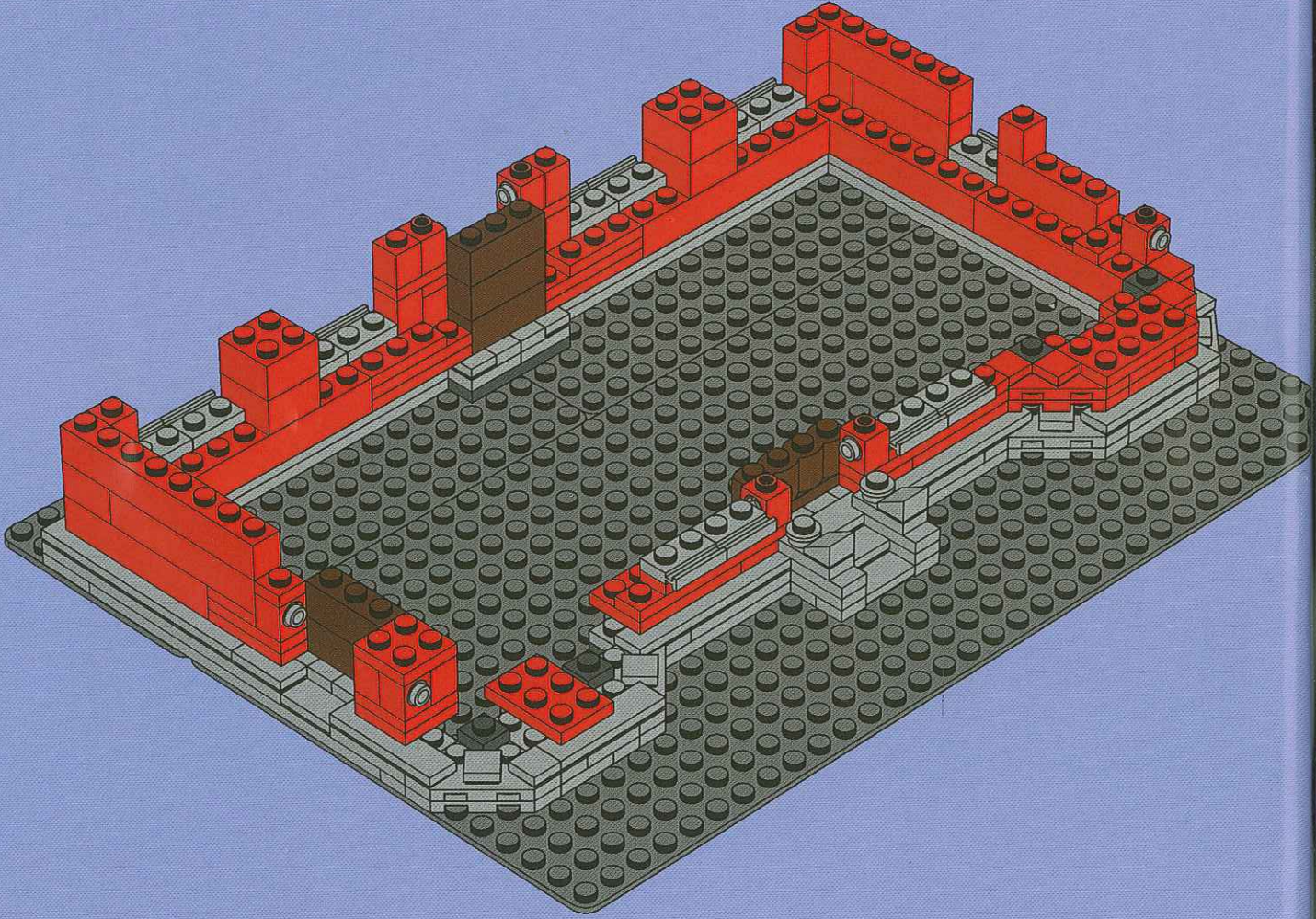

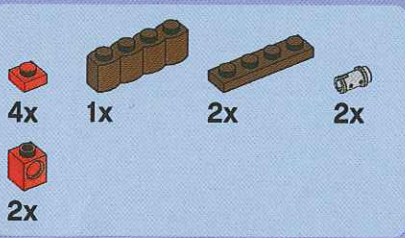

18

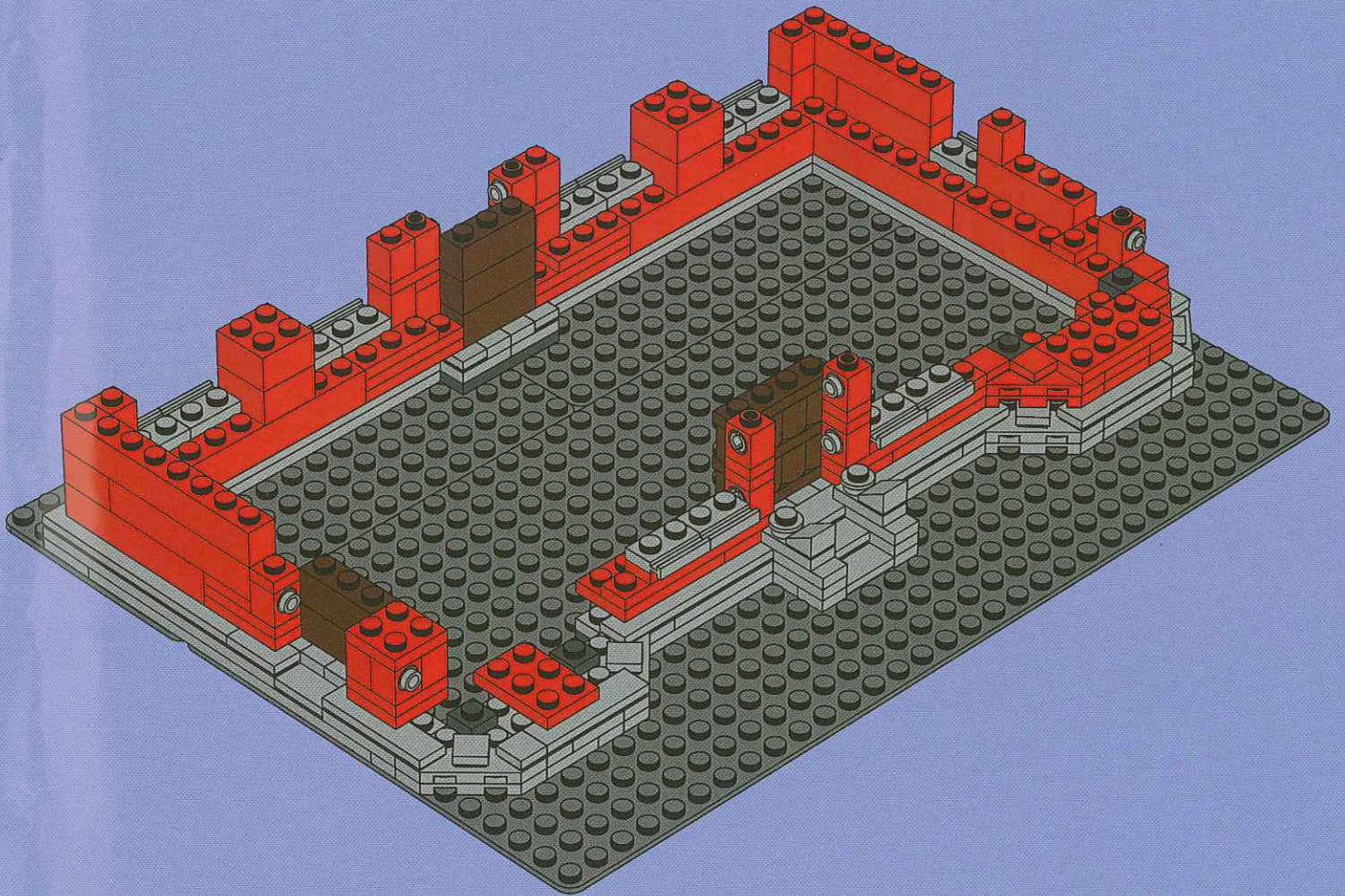

4x 4x

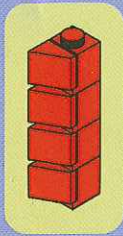

19

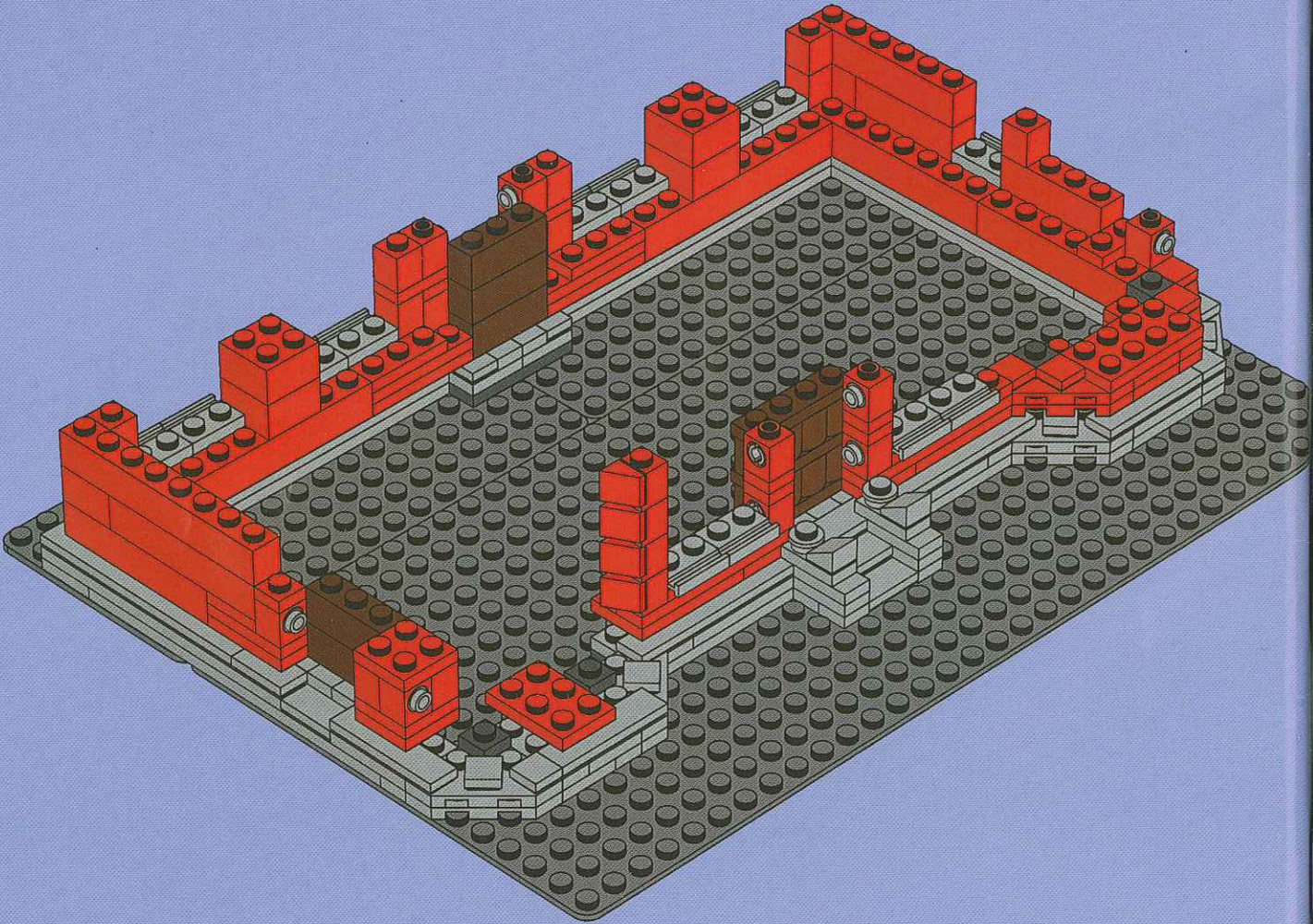



1x



3x



3x

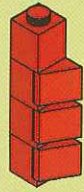

20

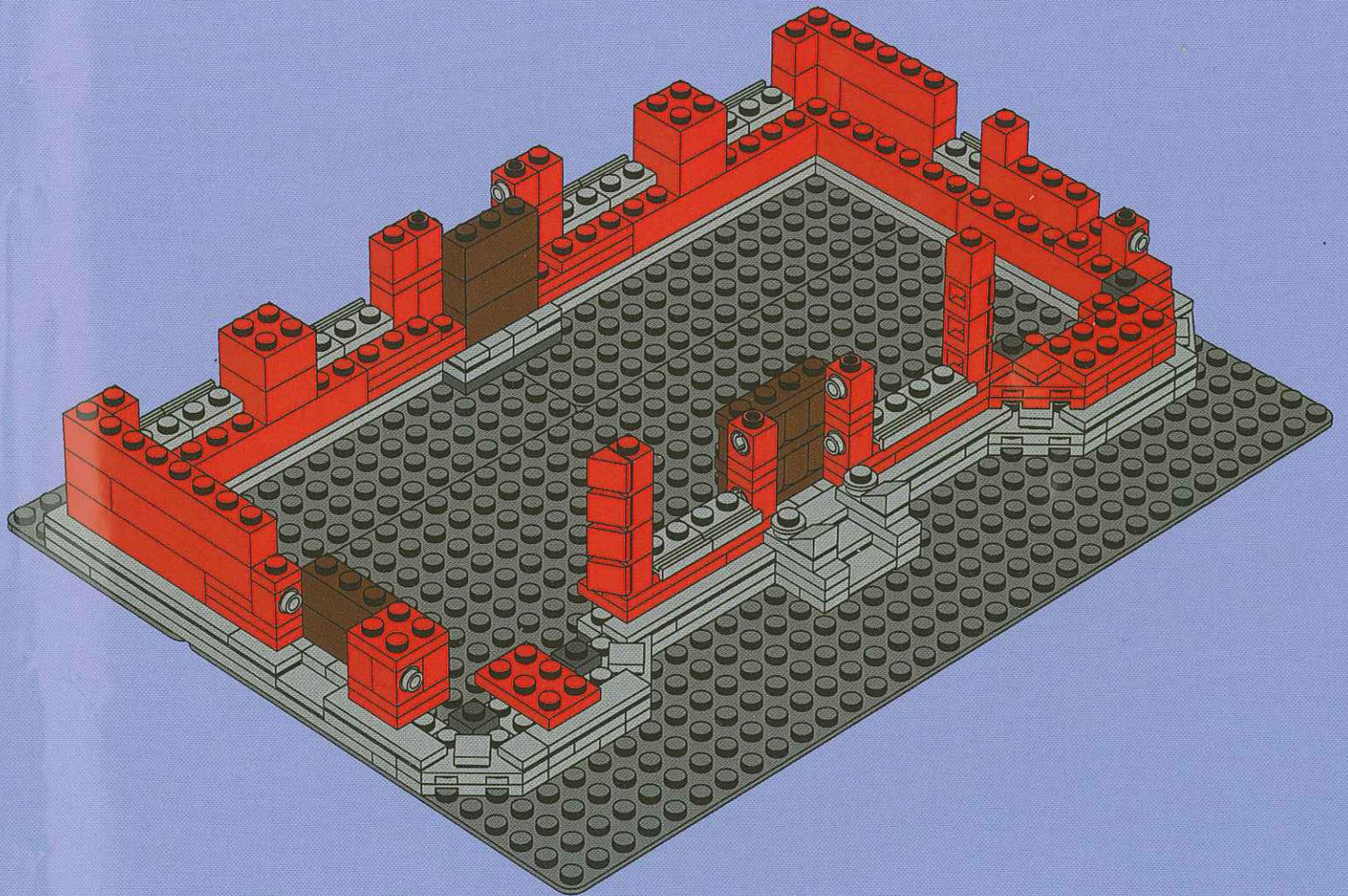

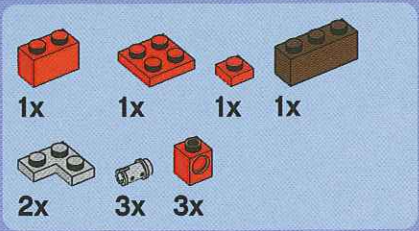

21

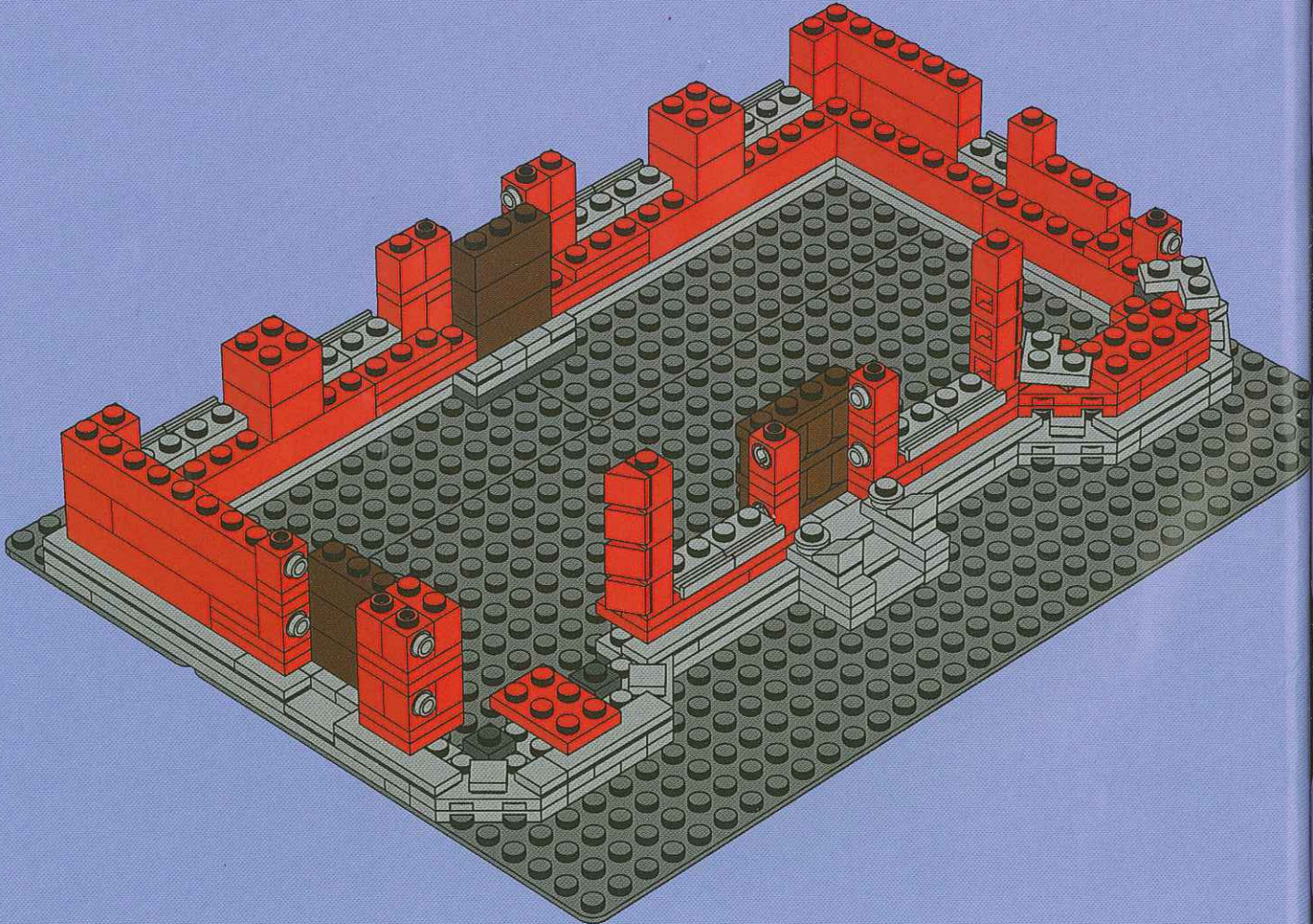



2x



2x

22

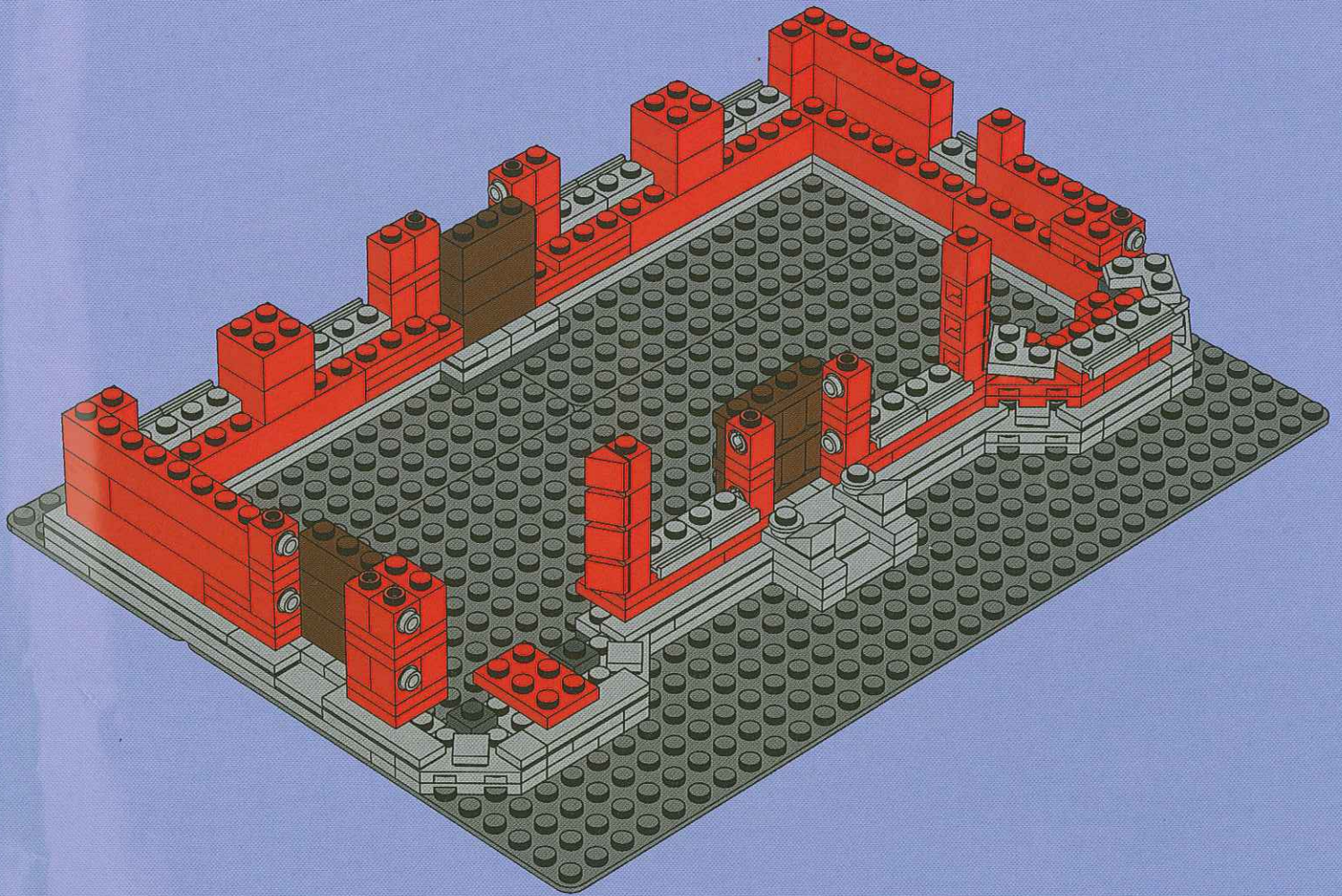

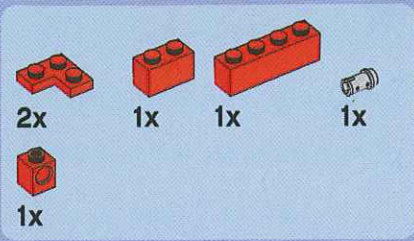



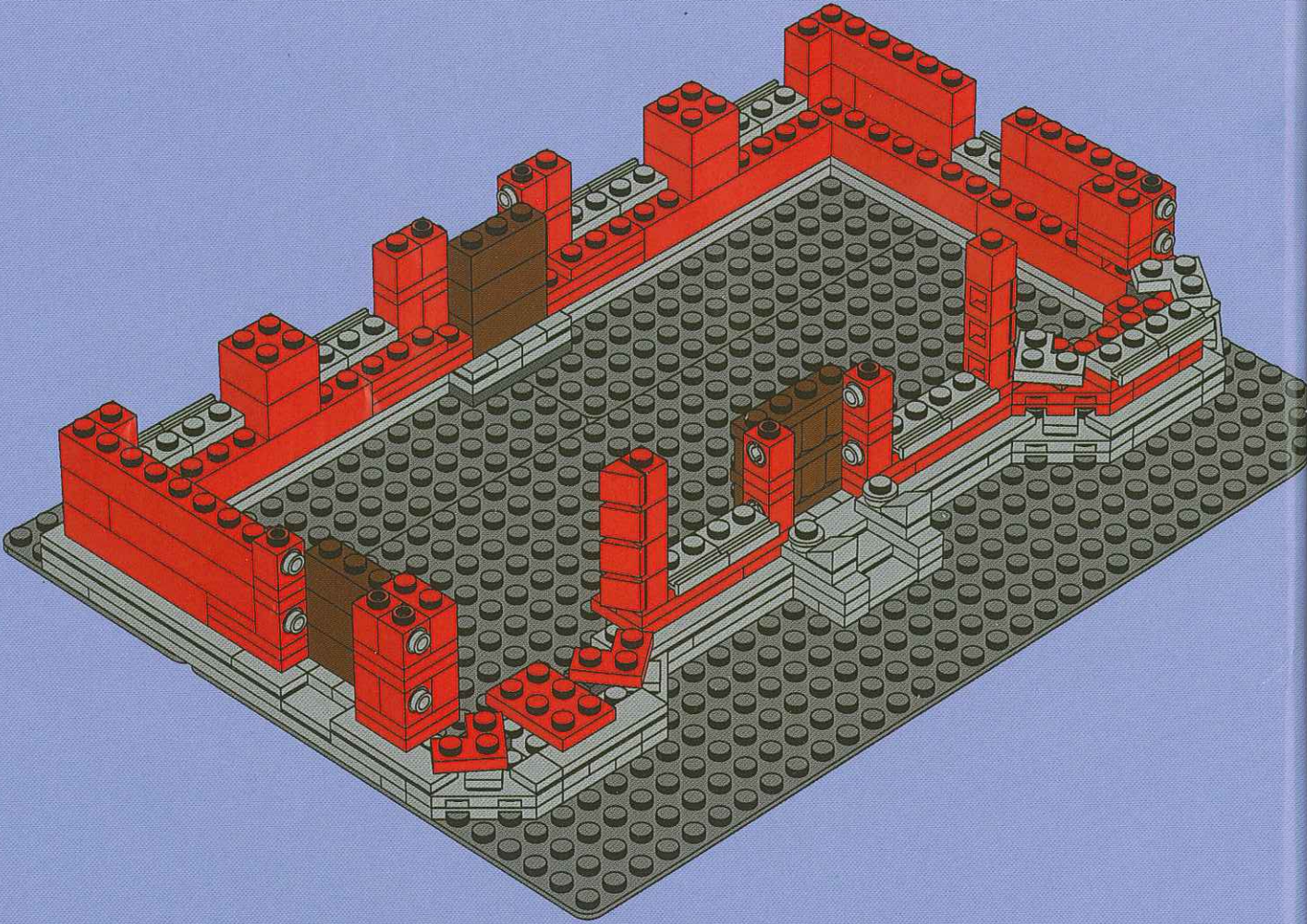

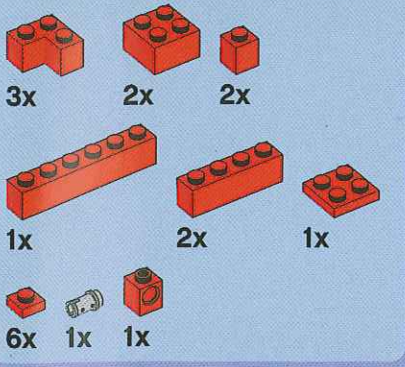

23

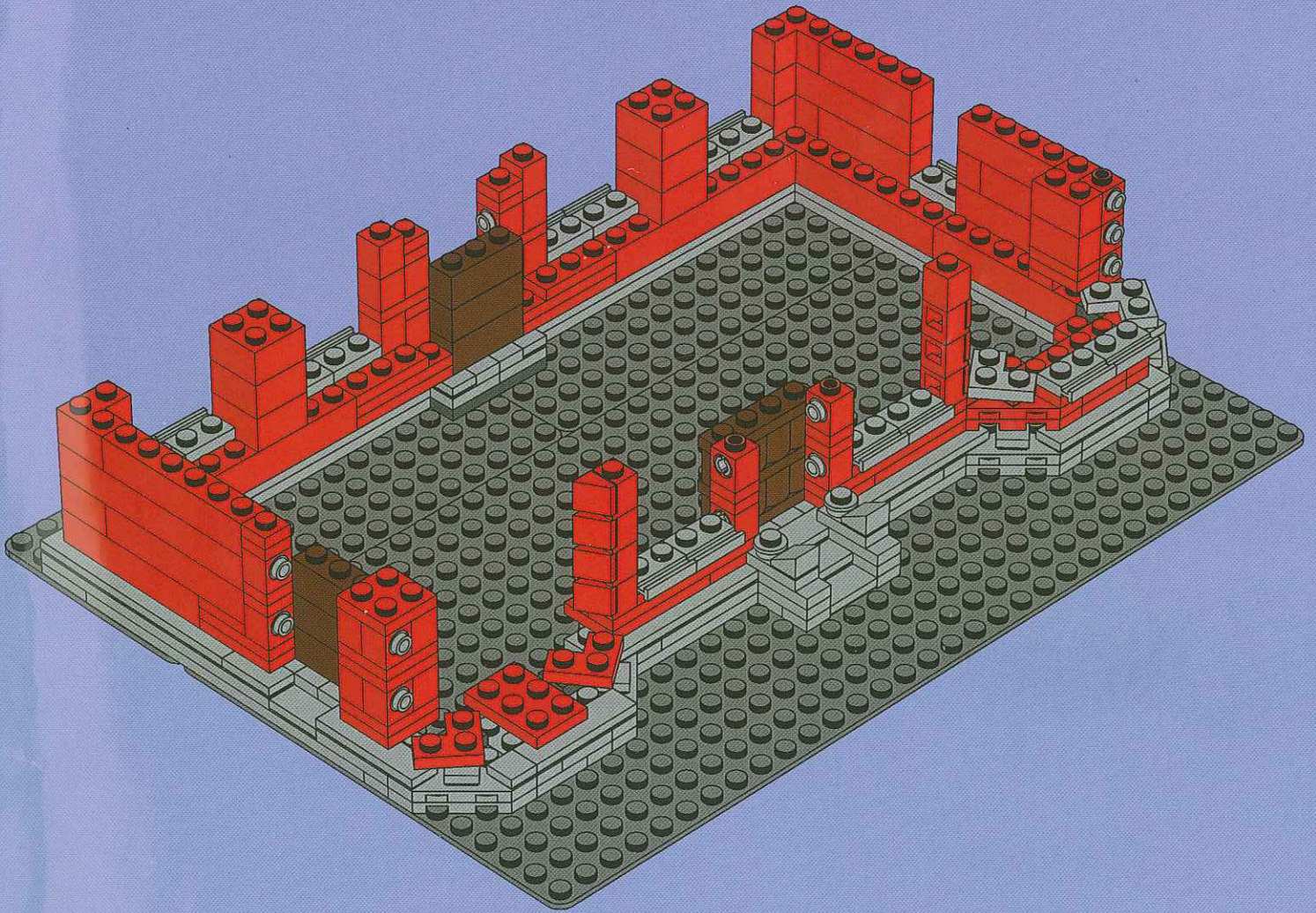



24



- 6x 
- 1x 
- 1x 
- 3x 
- 6x 

25

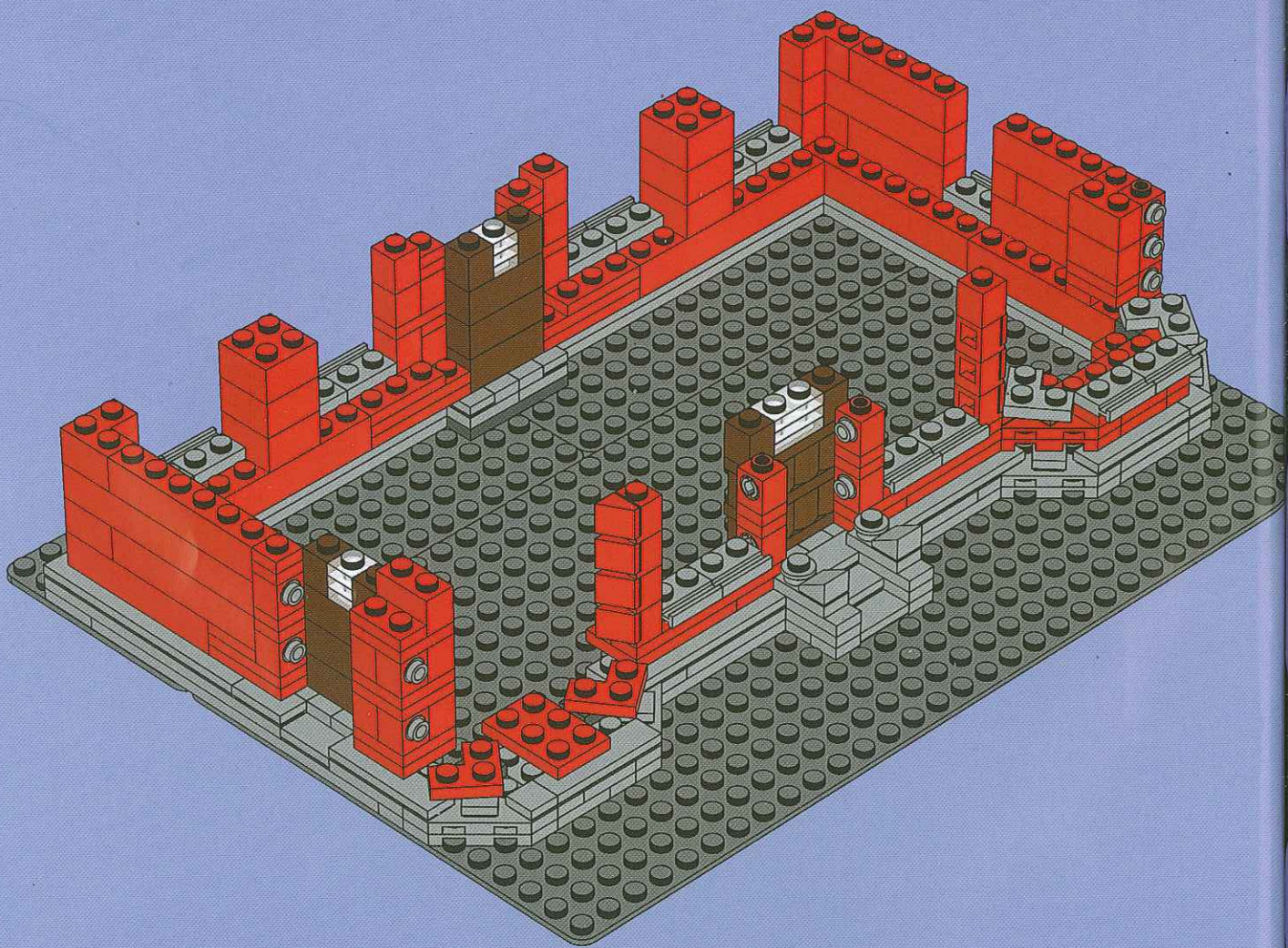



4x



2x



2x

26

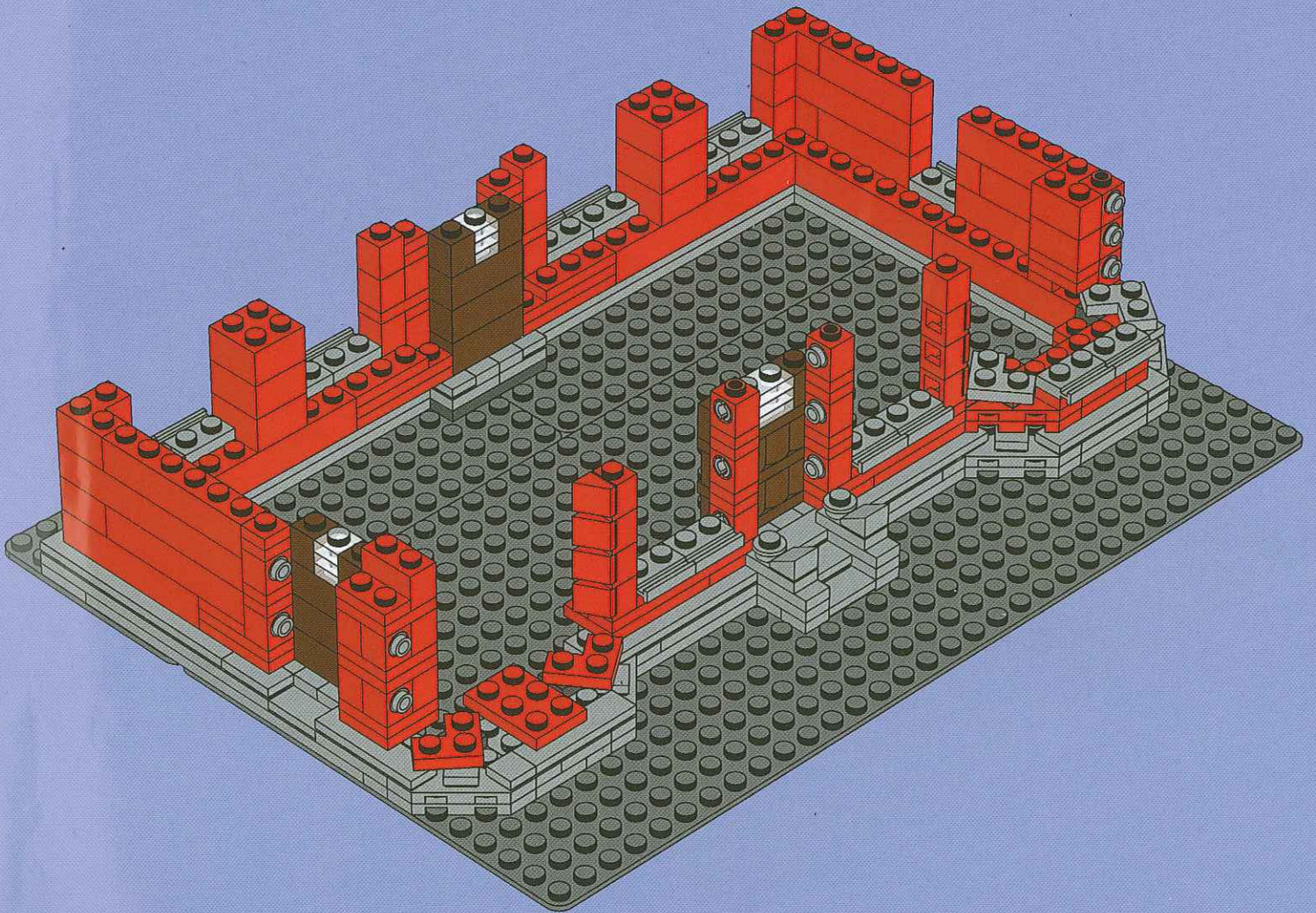



4x



2x

27

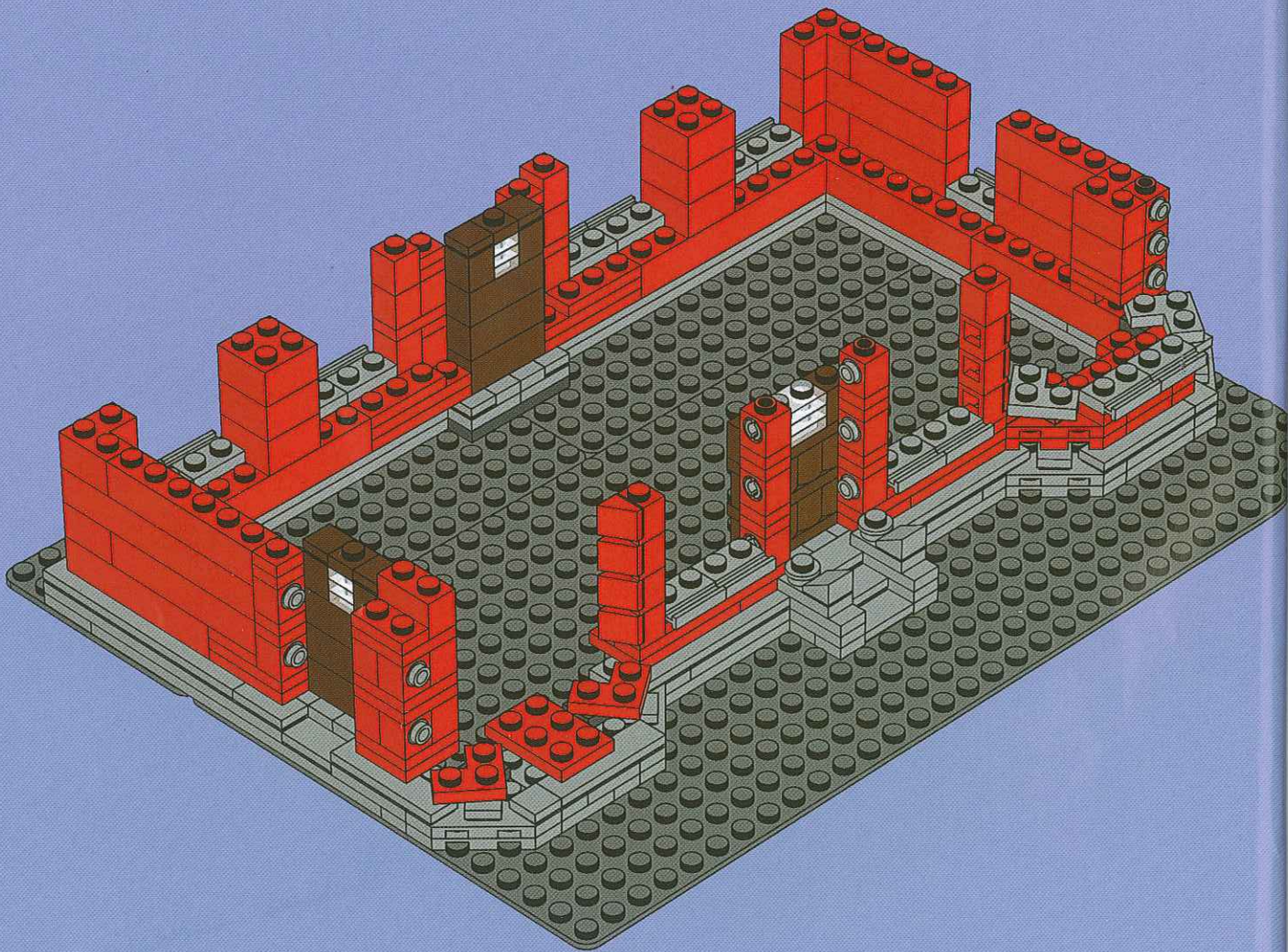



5x



5x

28

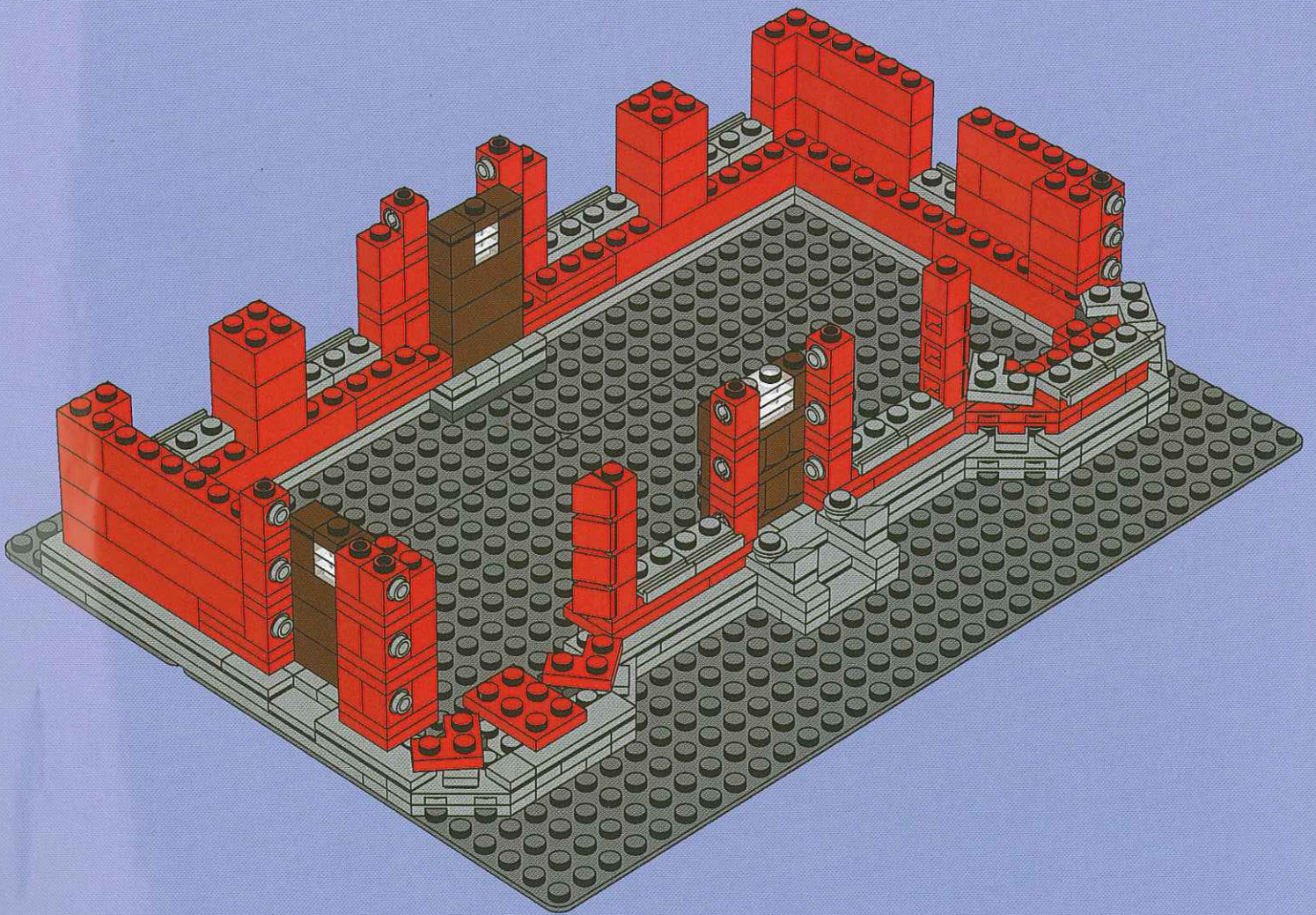

1x 2x 2x 4x
1x

29

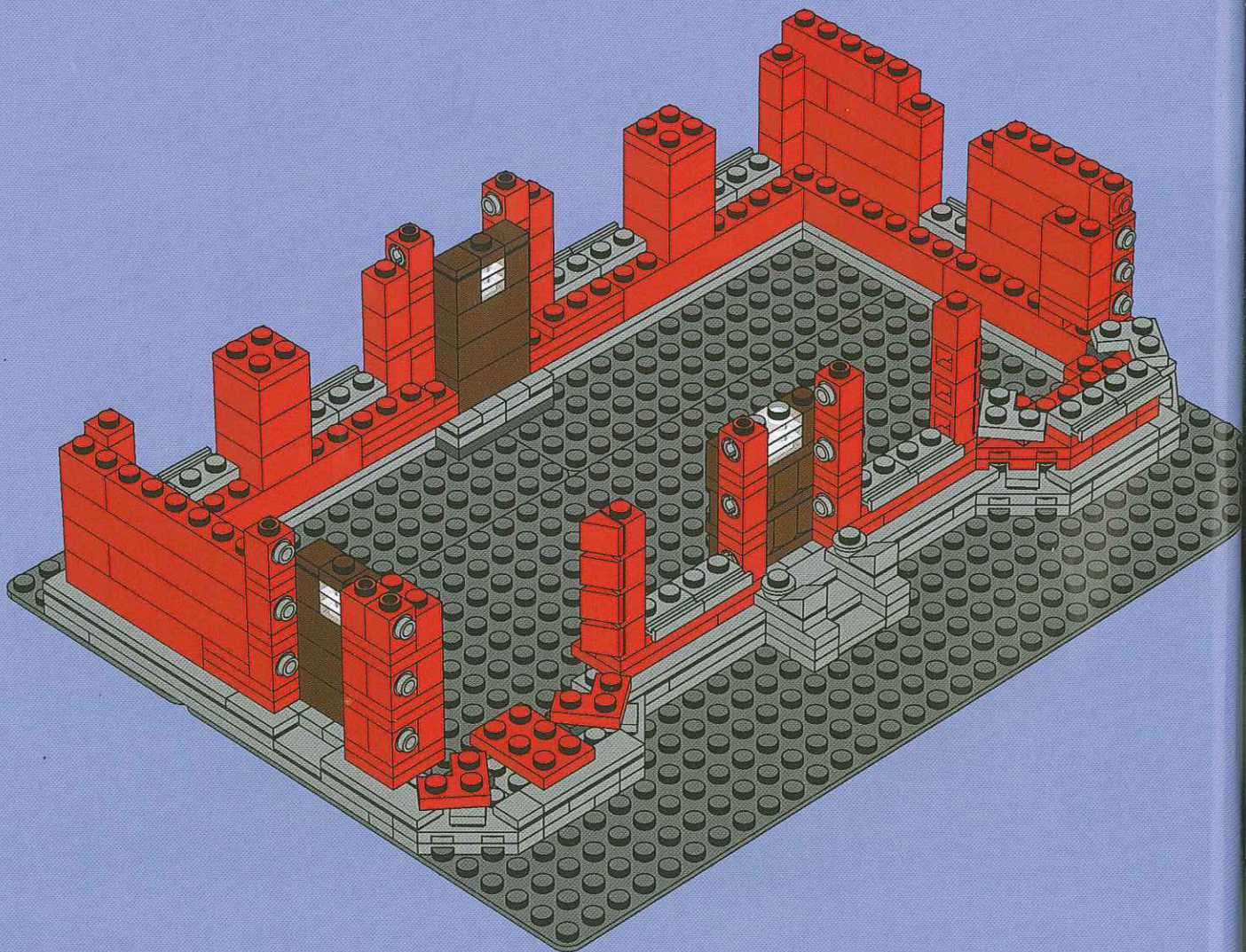

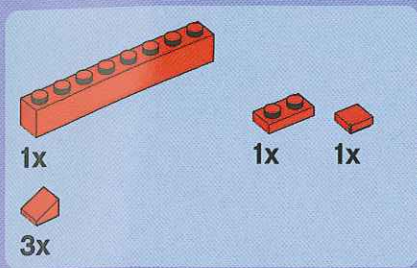

30

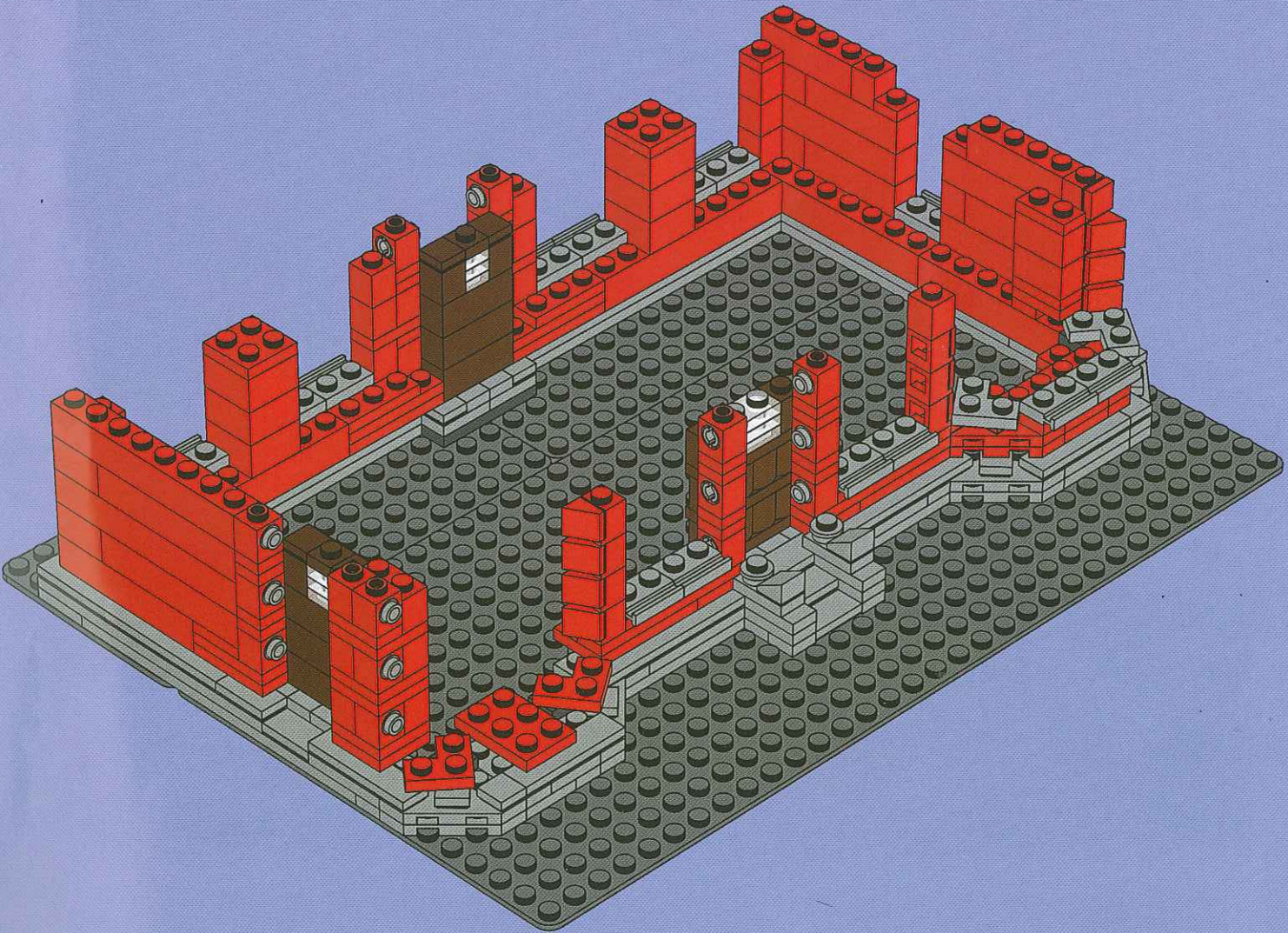



9x



9x

31

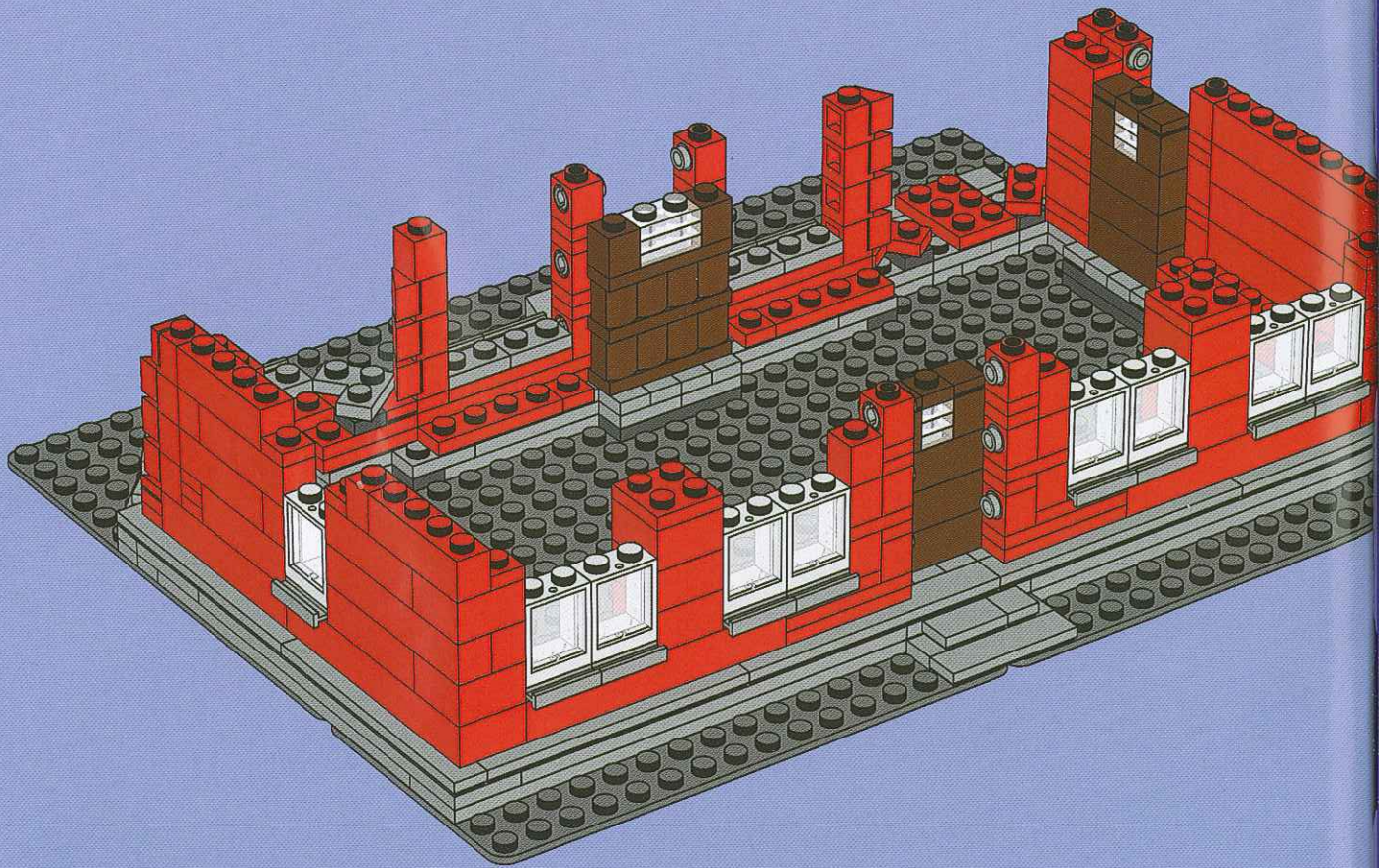



18x

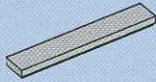

2x

32

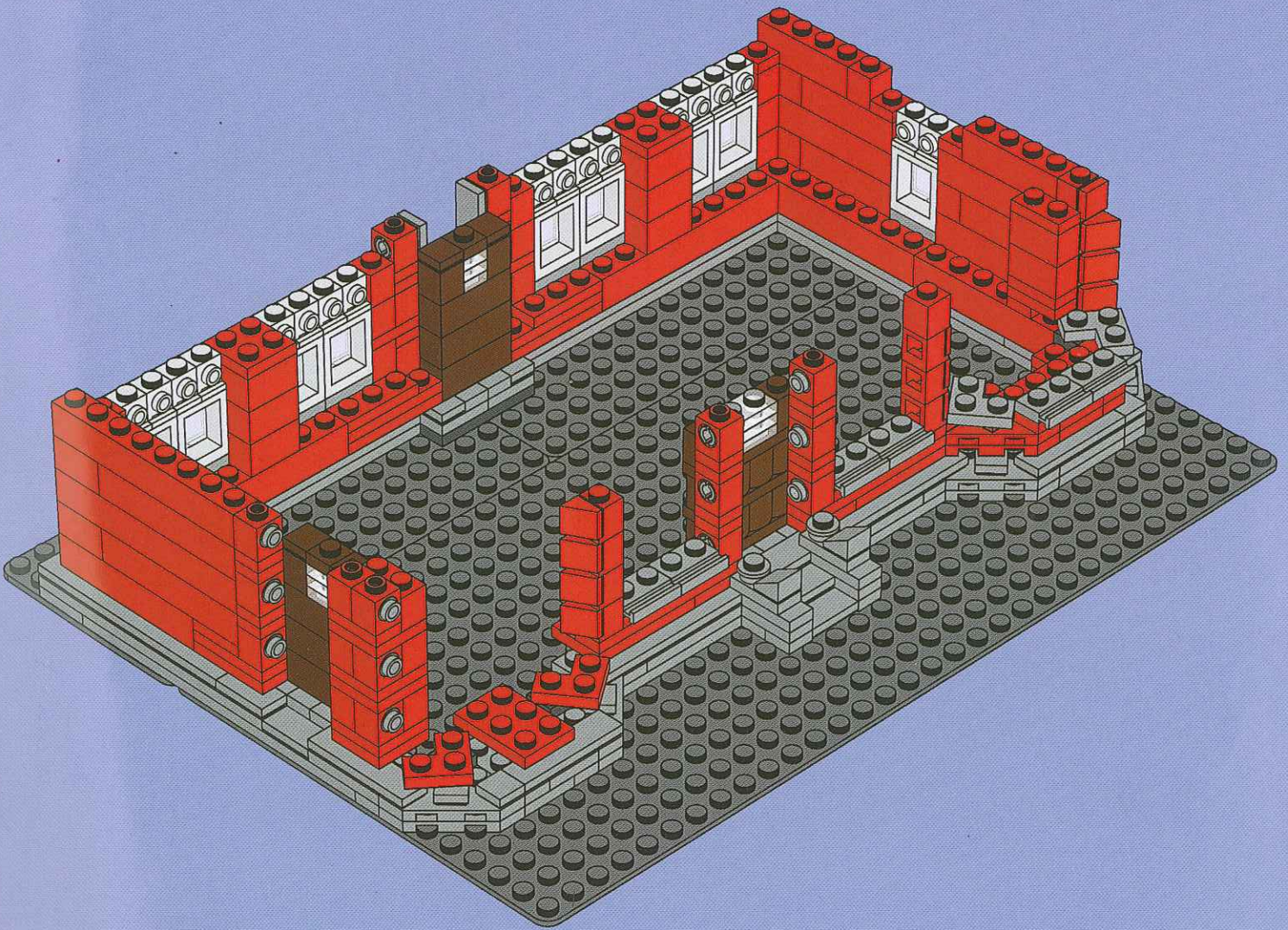

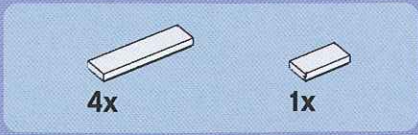

33

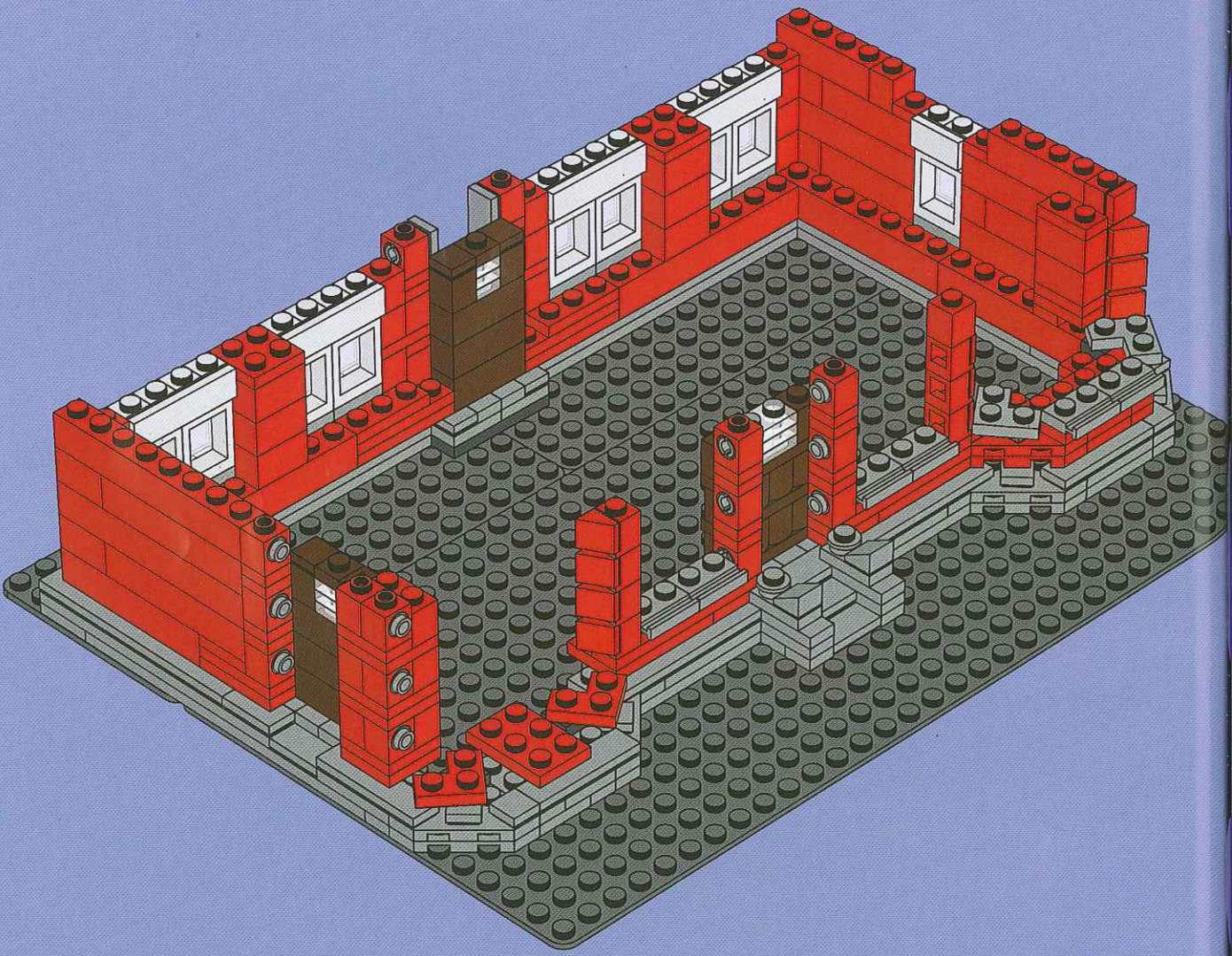

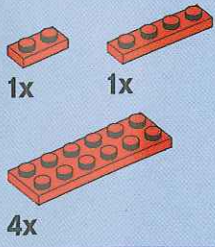

34

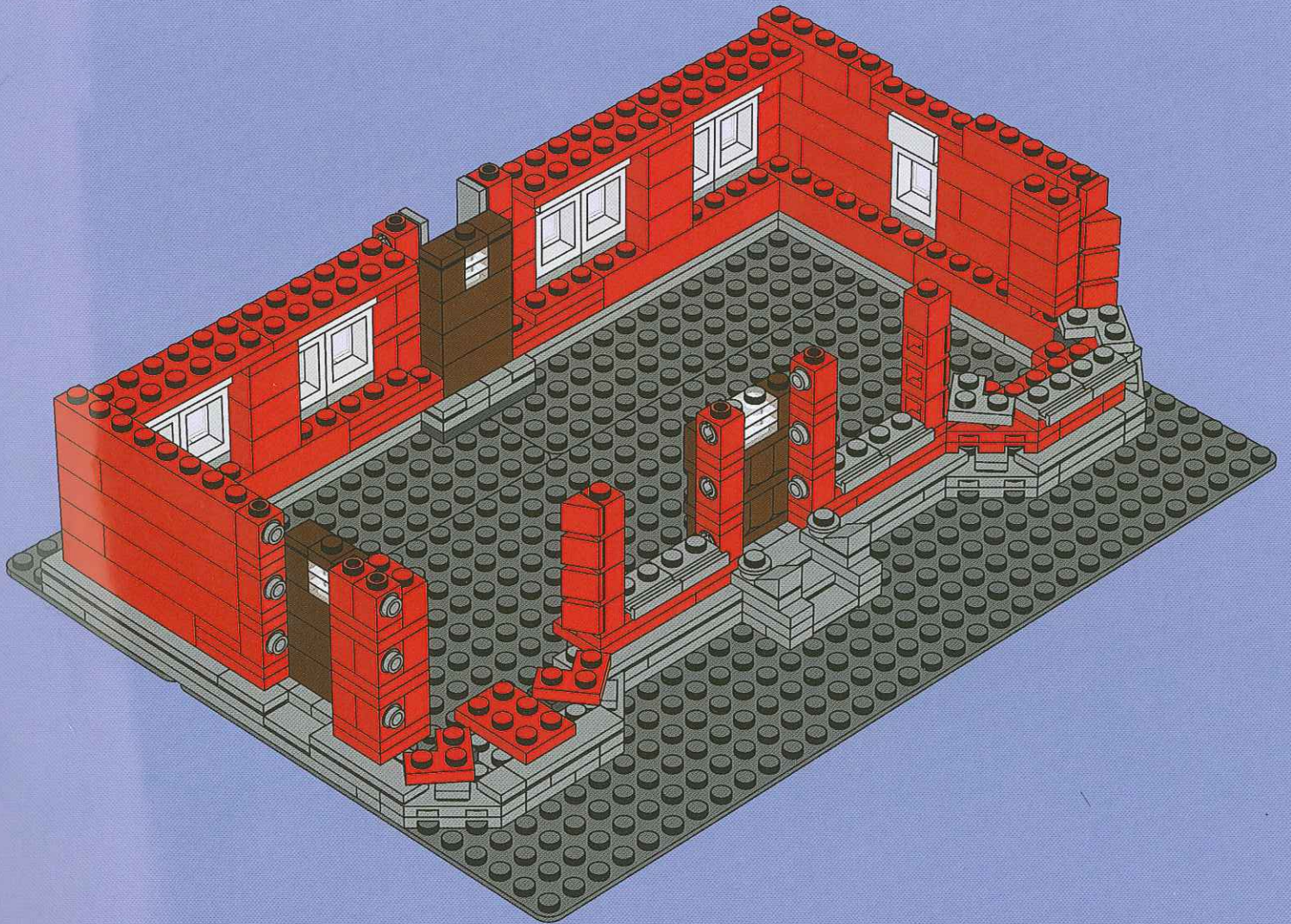

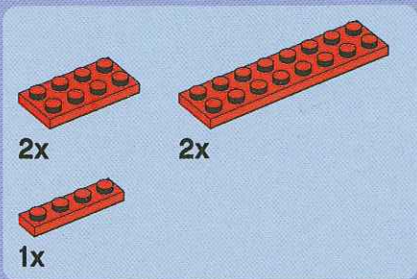

35

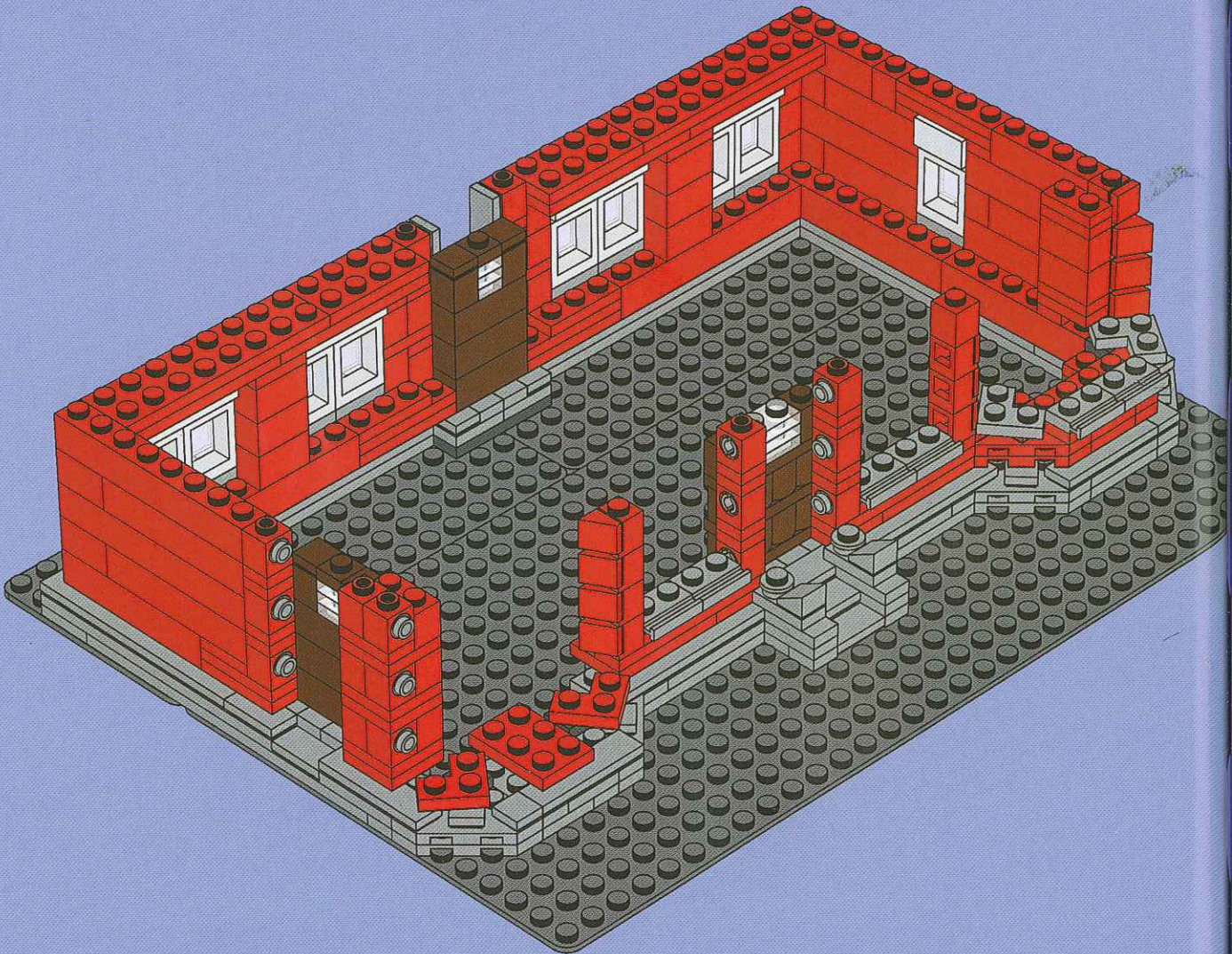

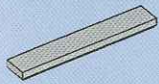

4x

36

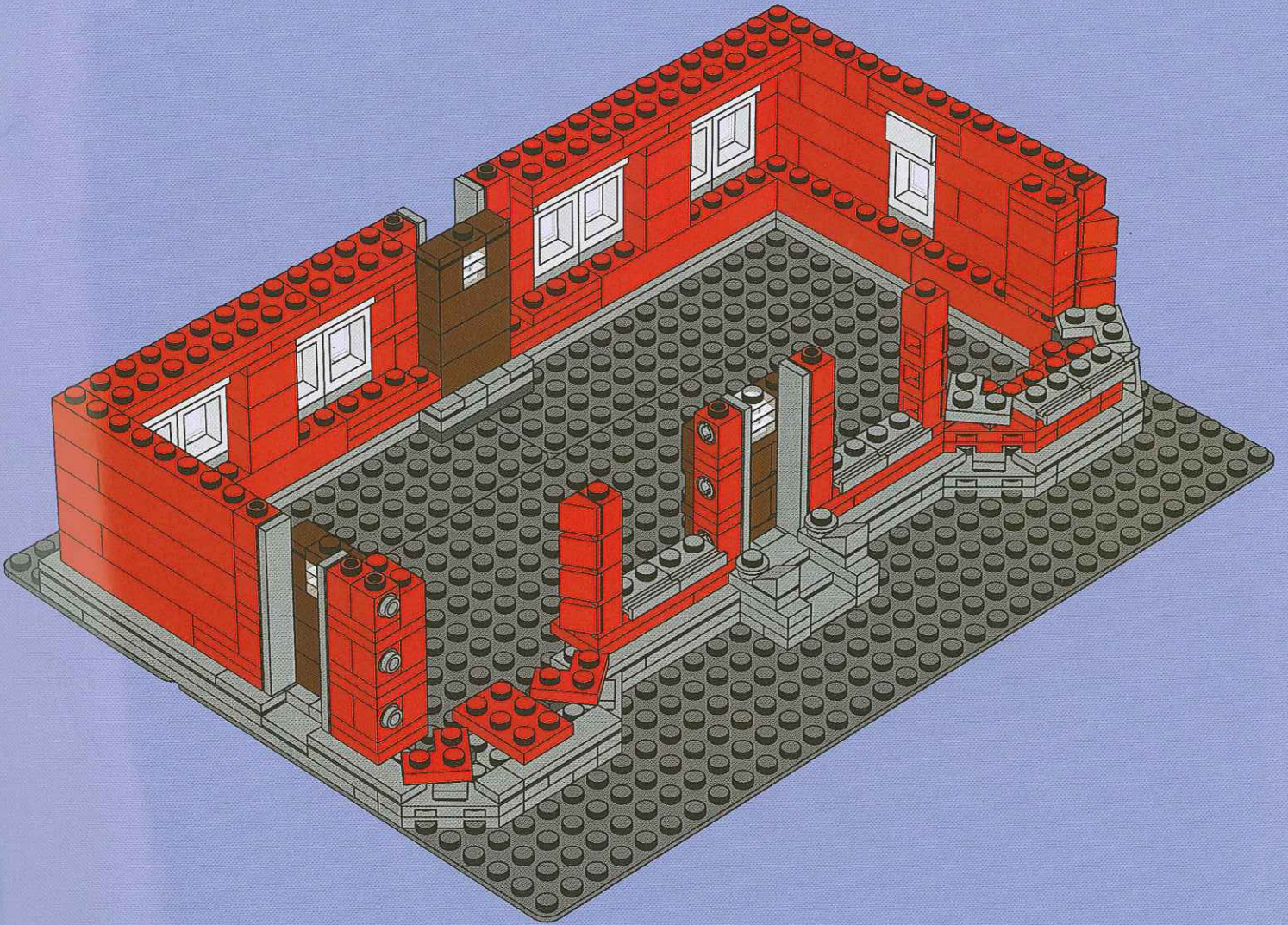

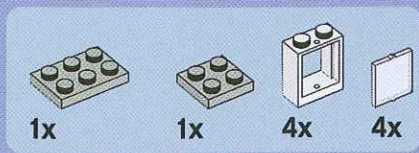

37

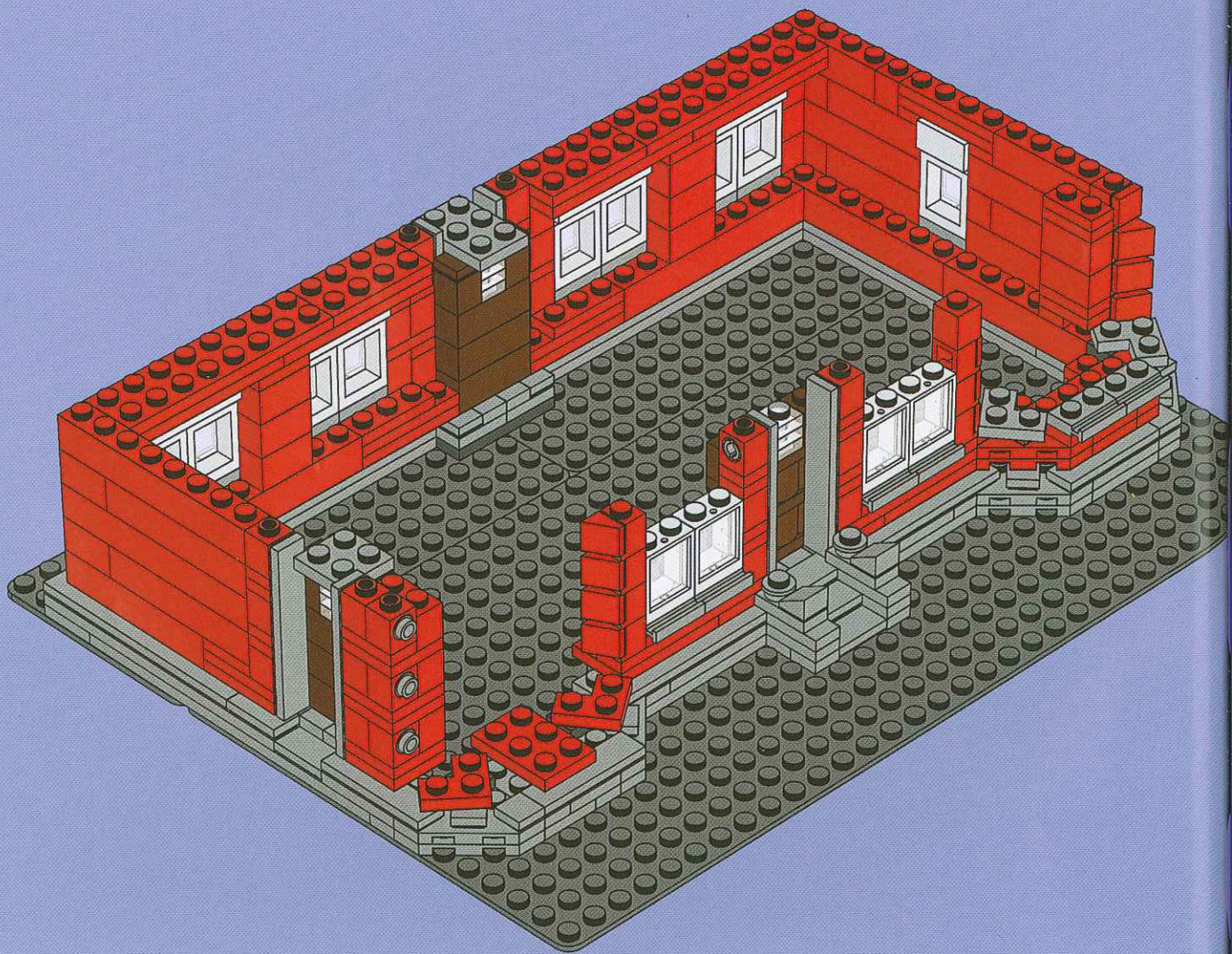



1x



4x

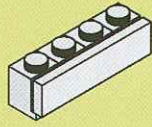

38

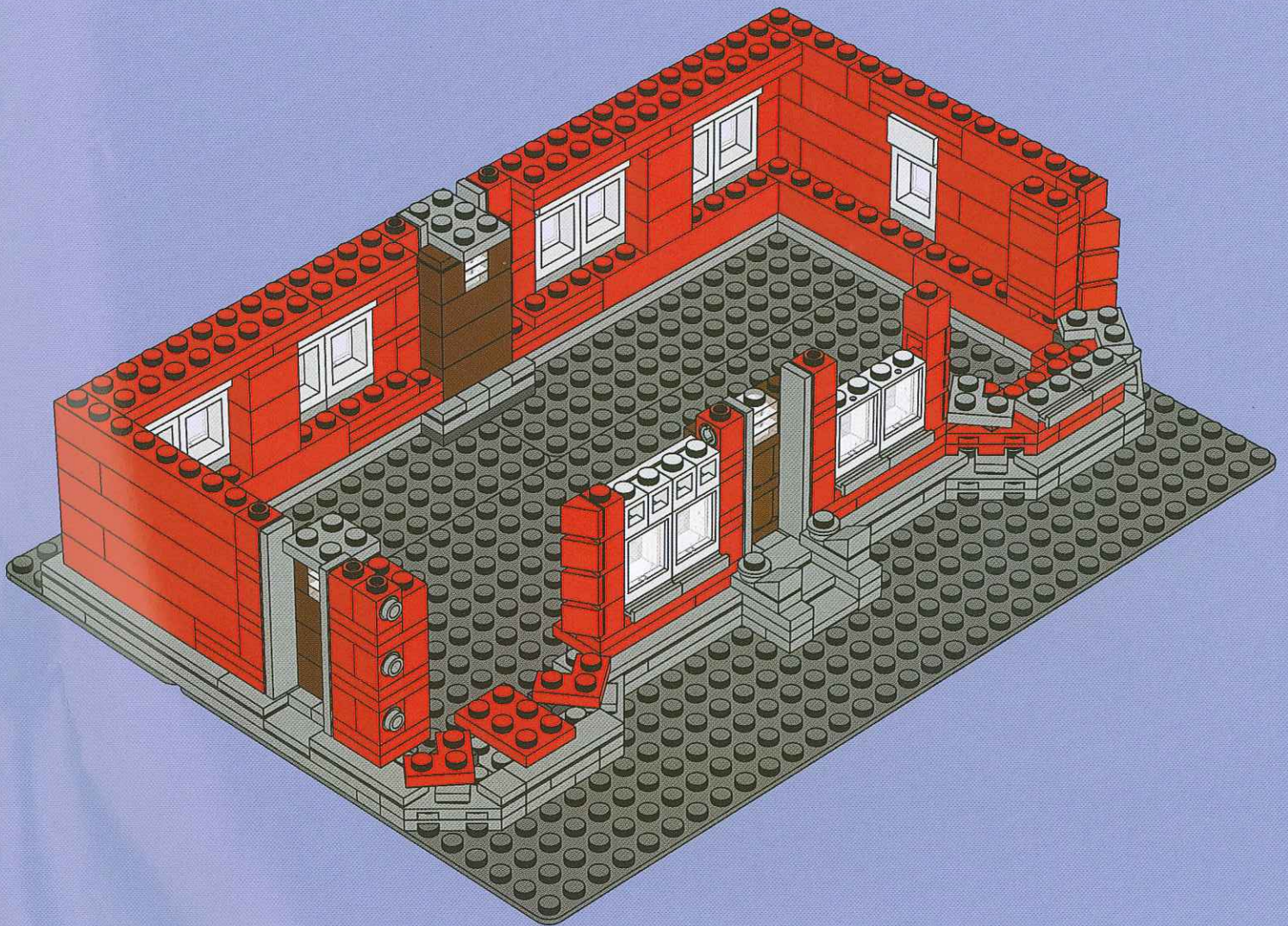



1x



4x

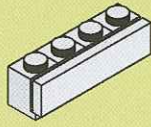

39

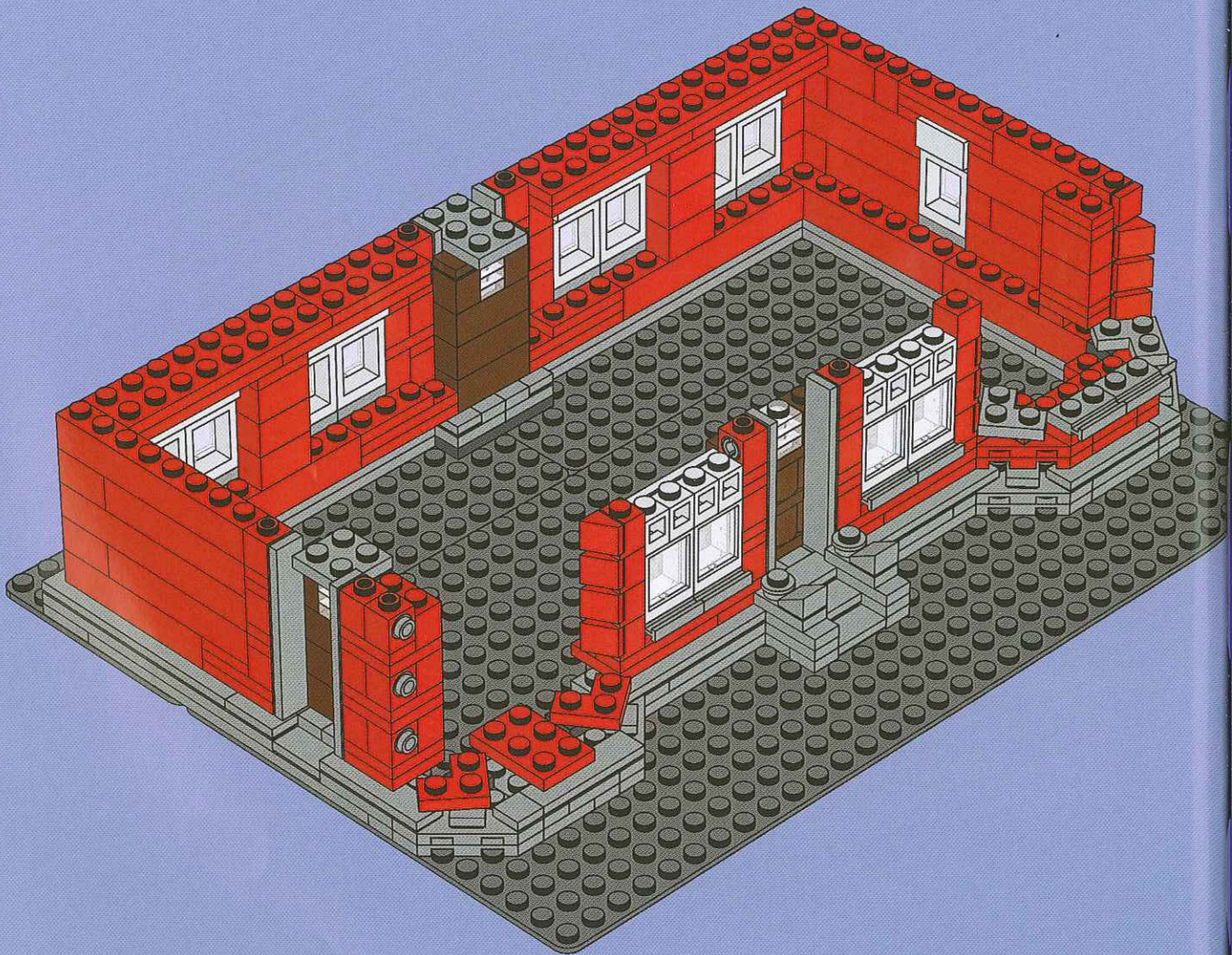



2x



1x



2x

40

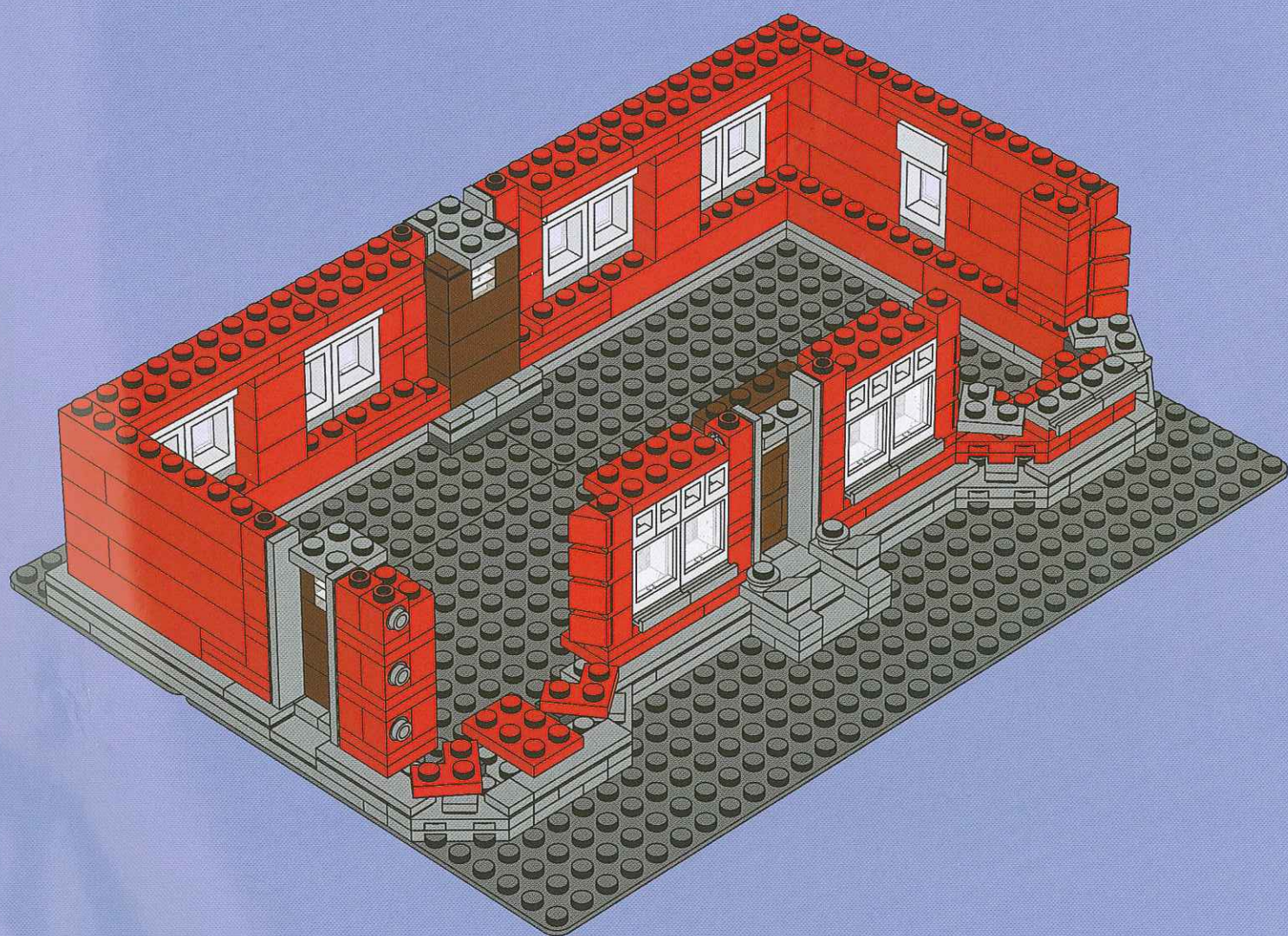

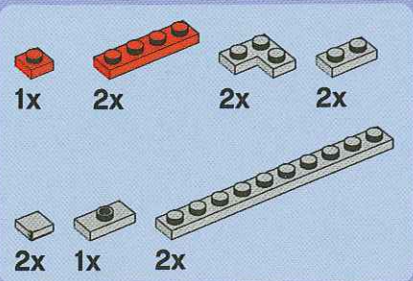

41

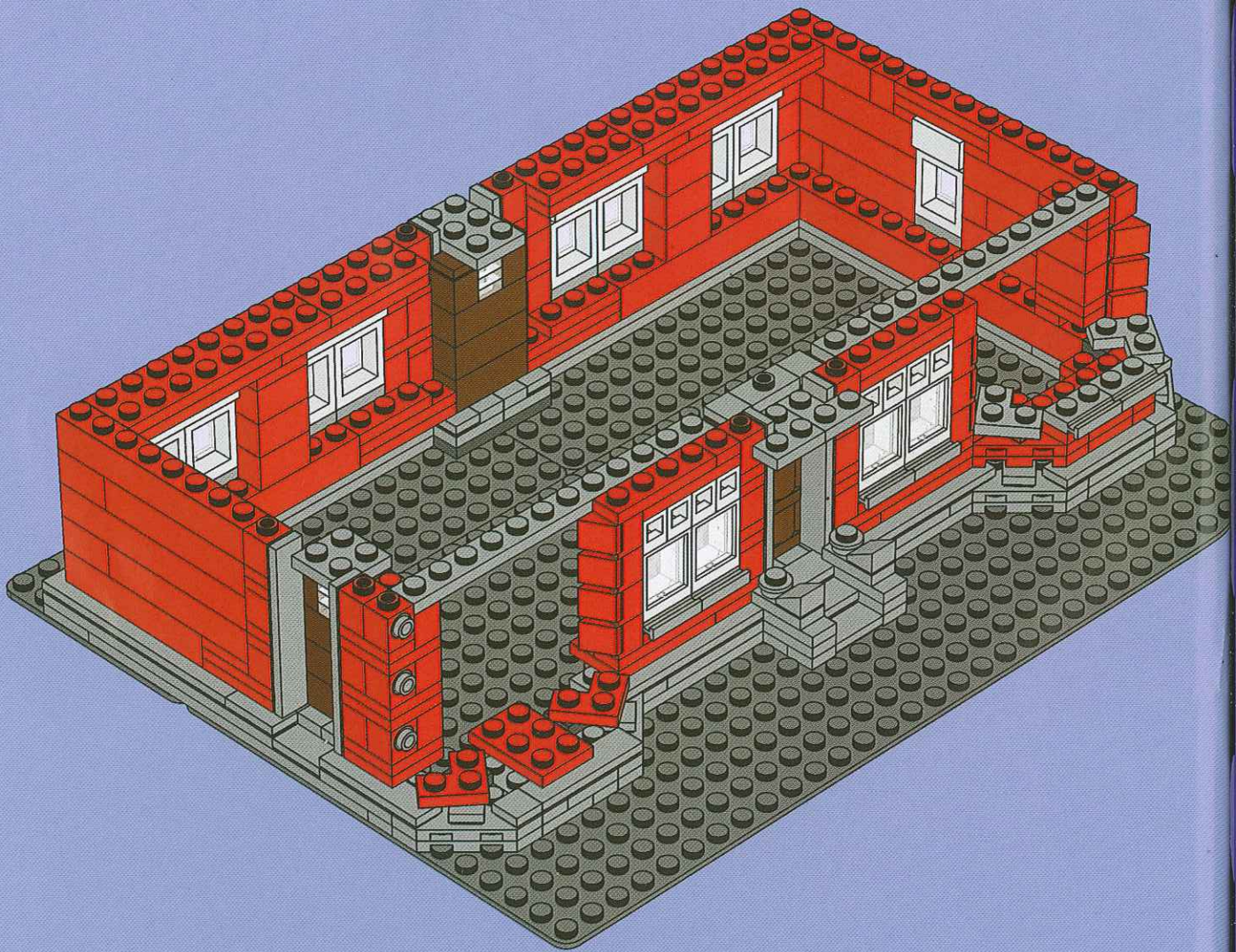

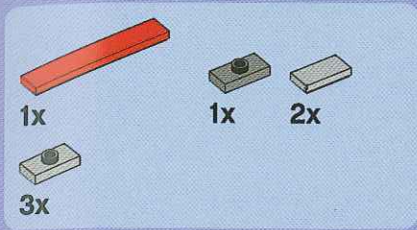

42

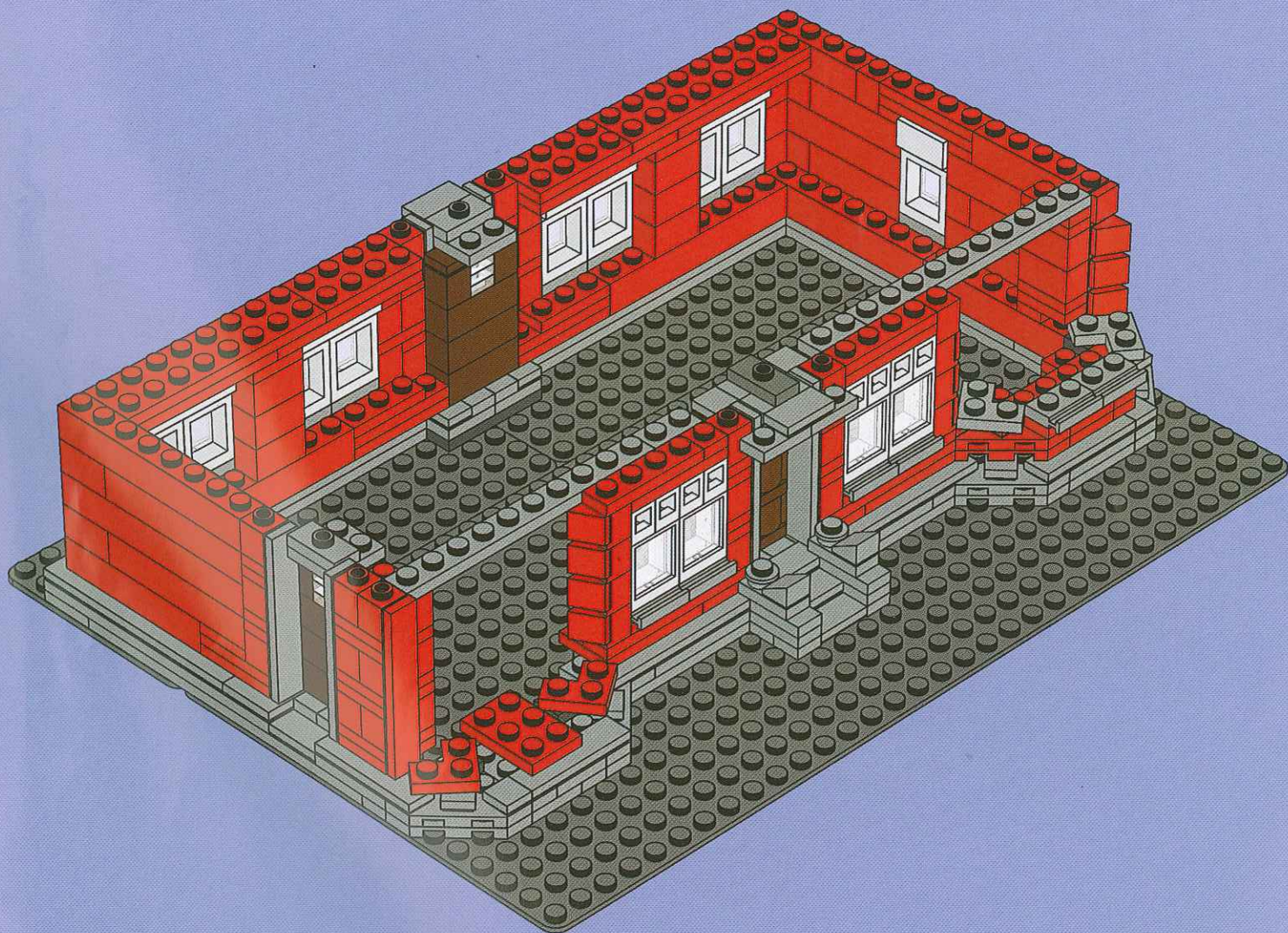

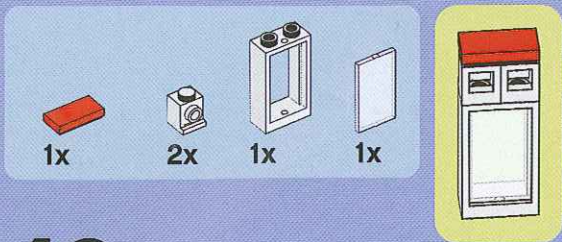

43

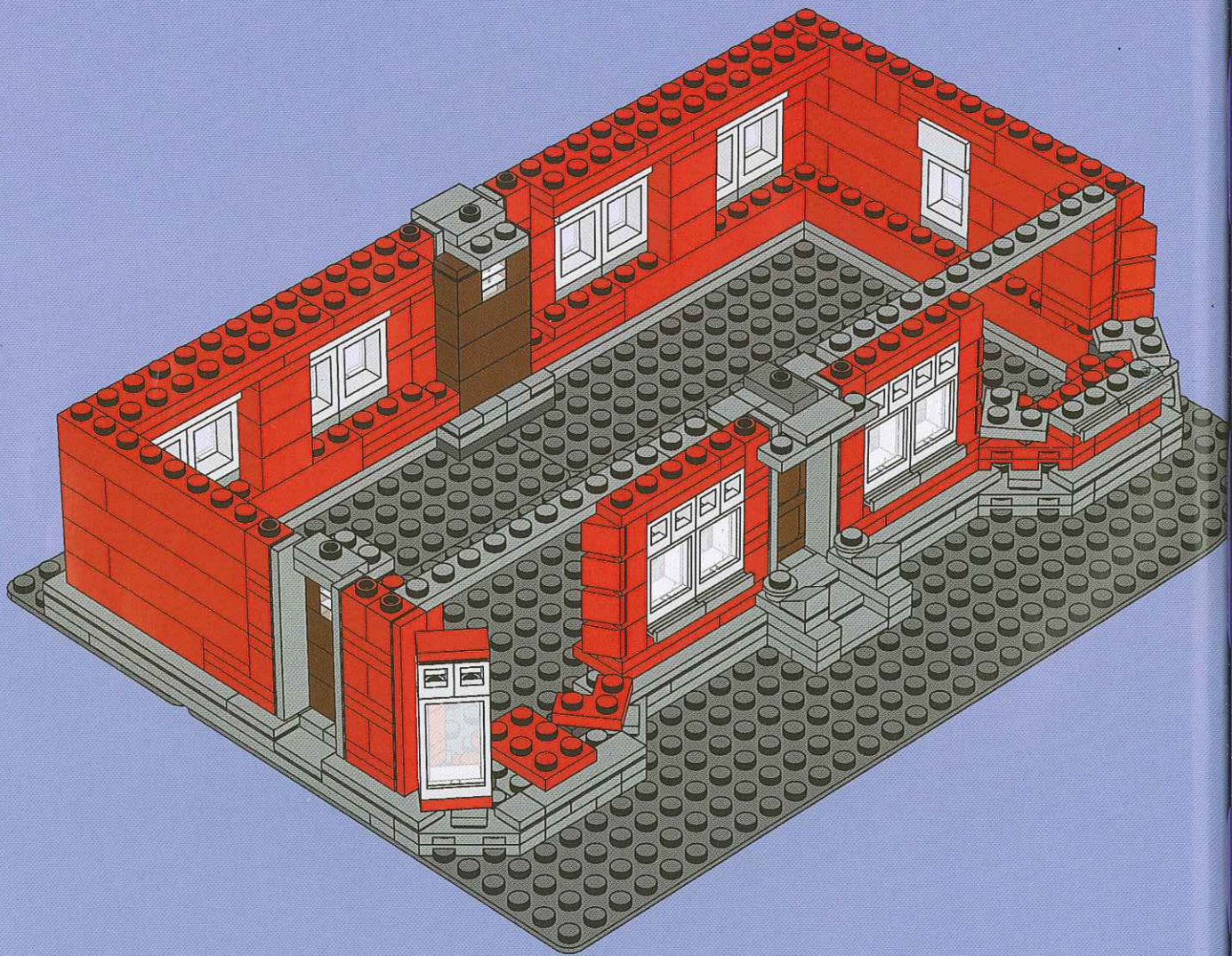

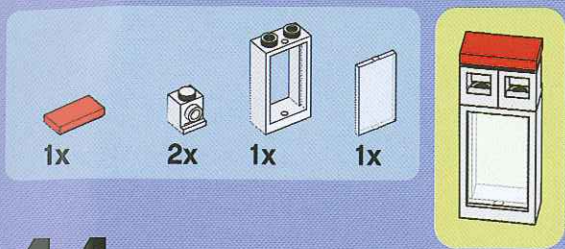



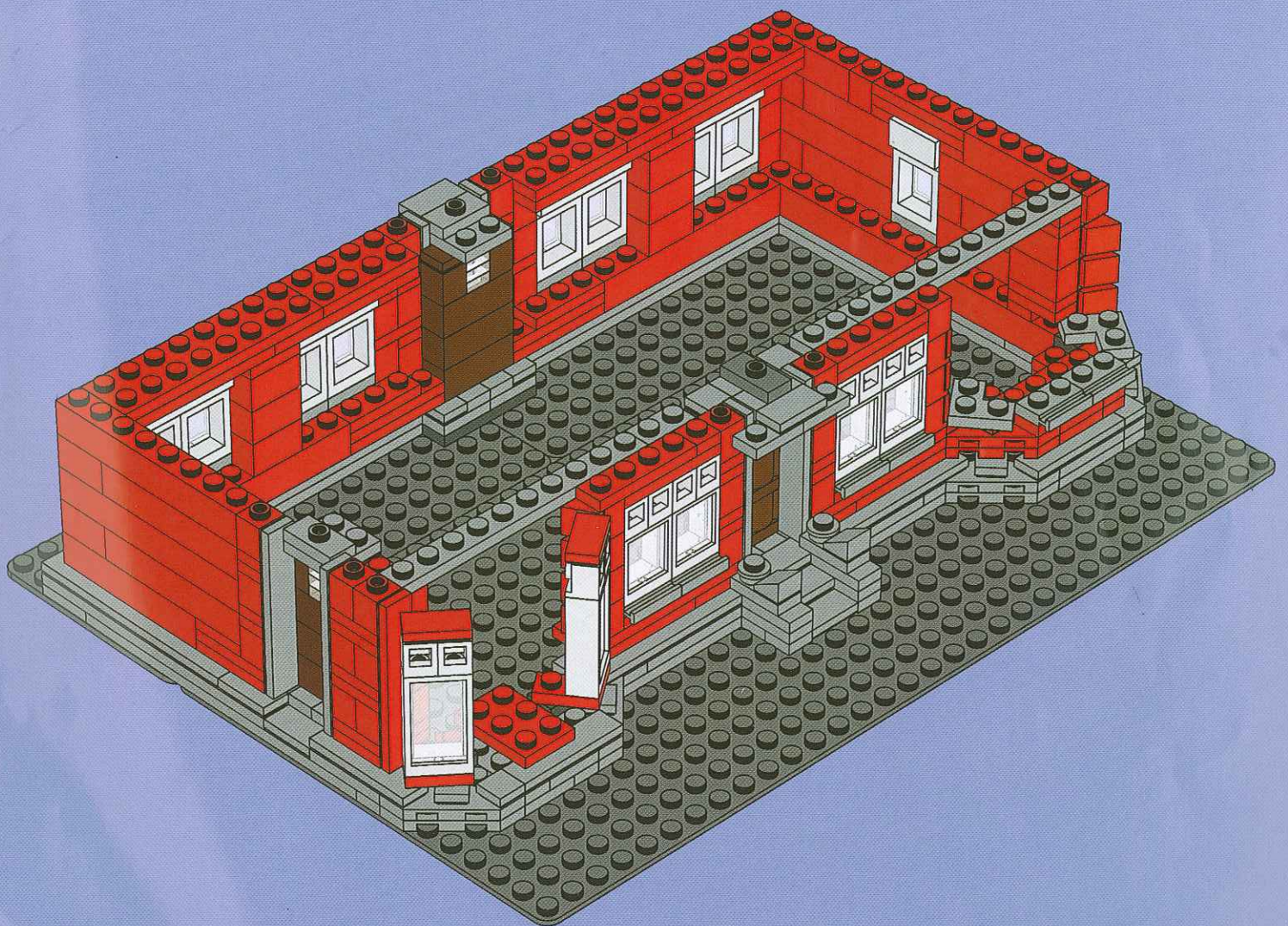

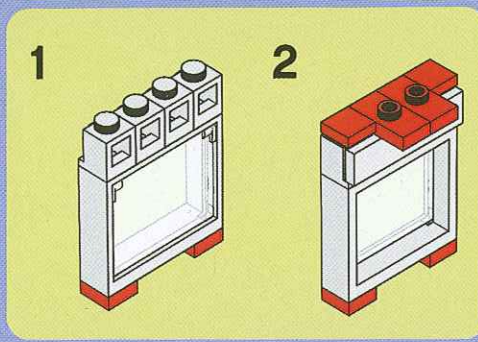
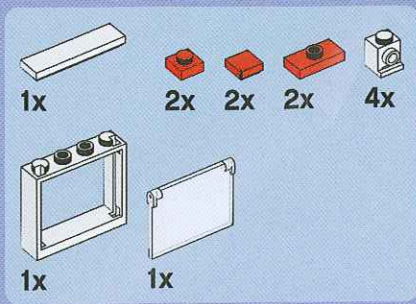
44



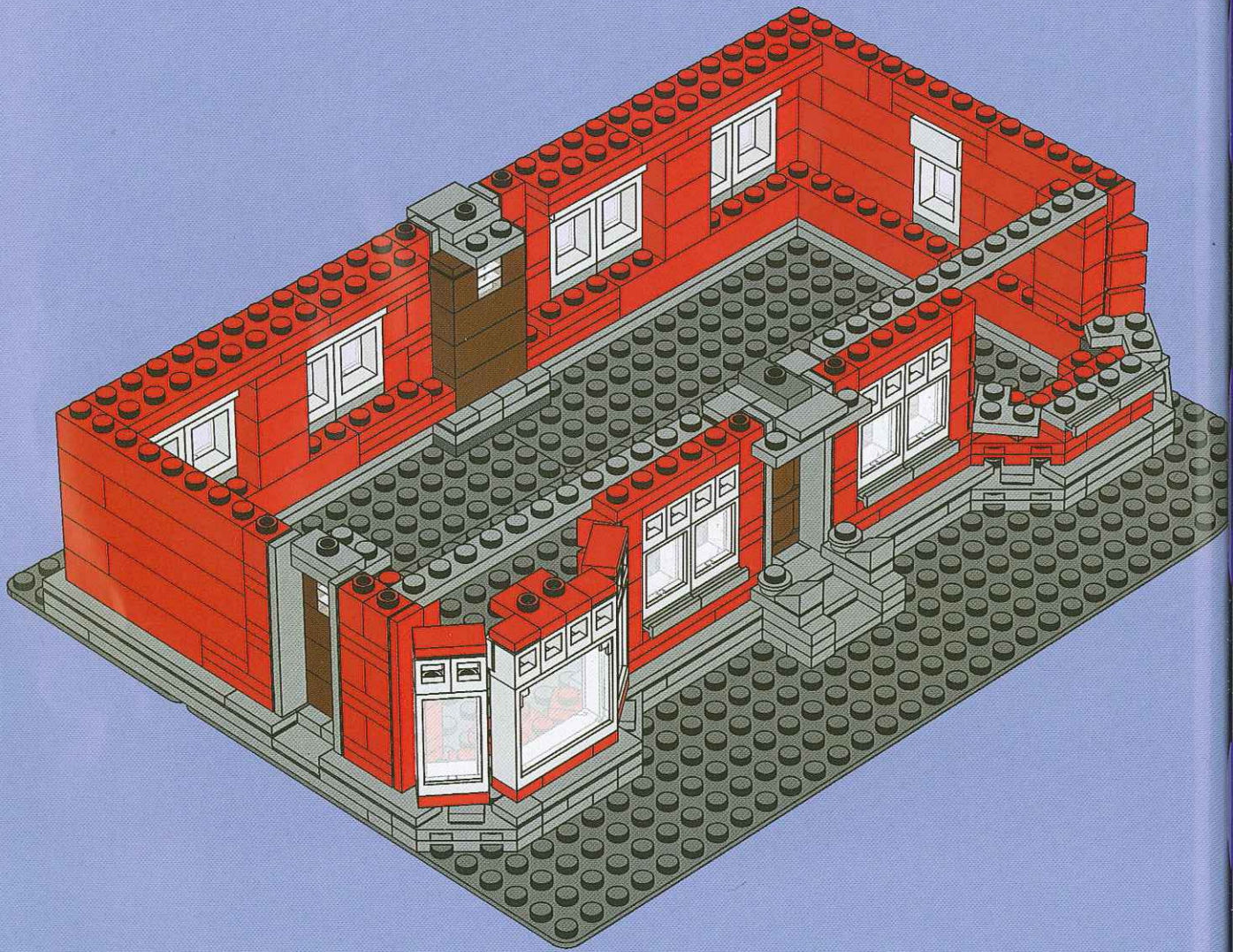

45



- 1x 
- 2x 
- 1x 
- 1x 



46

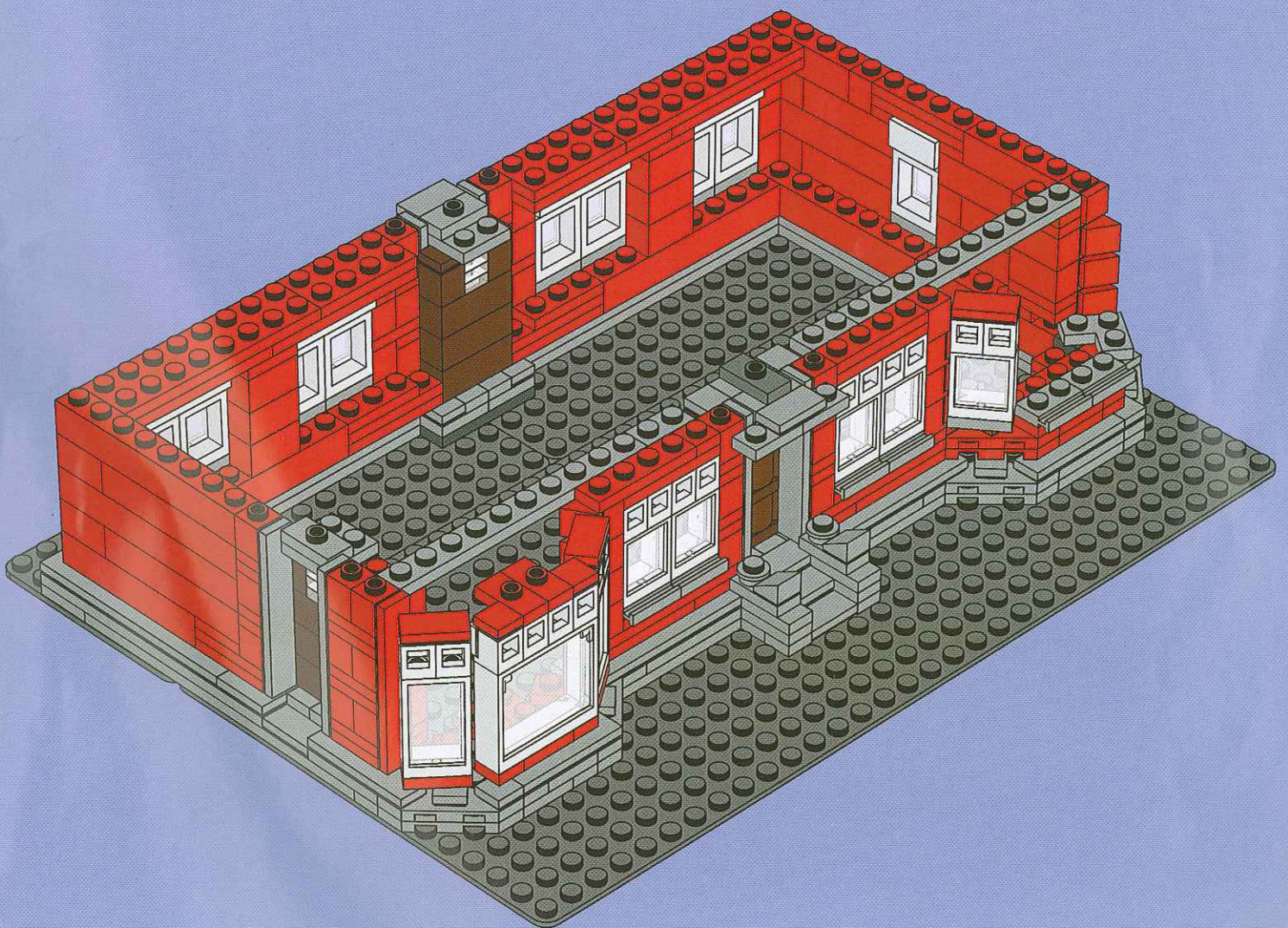

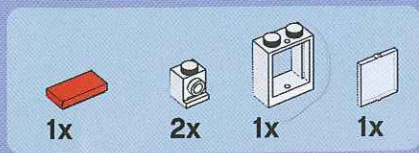

47

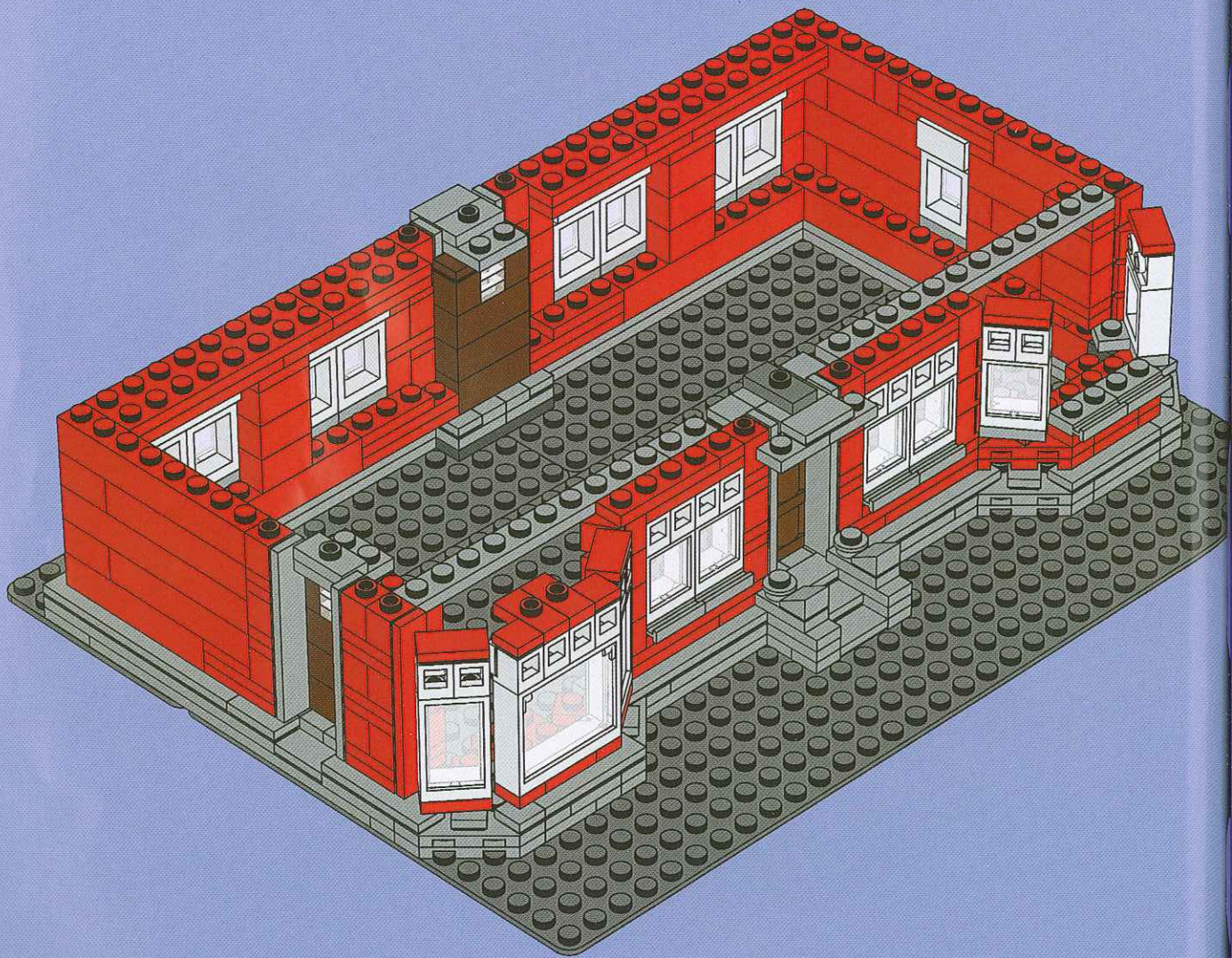

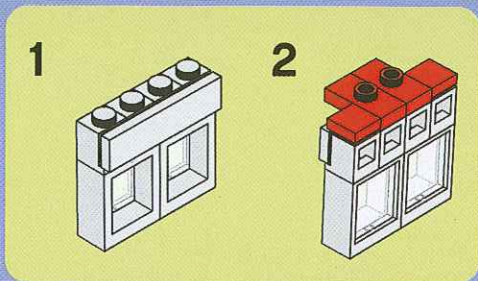
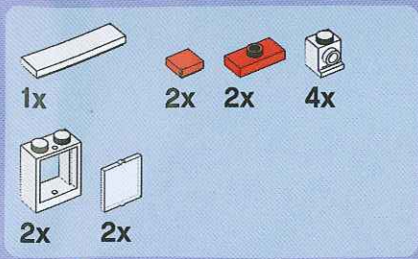

48

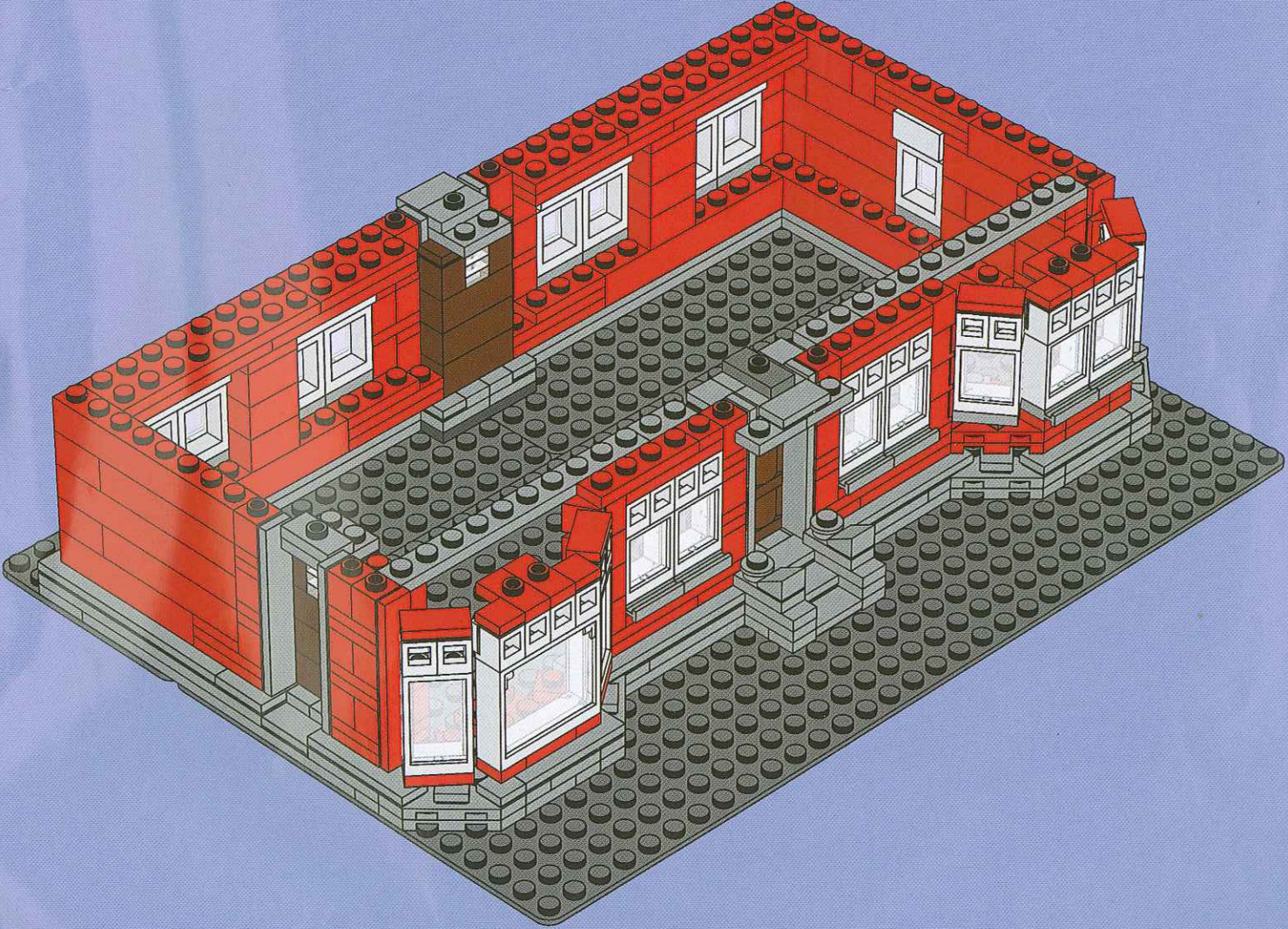



4x



4x



15x

49

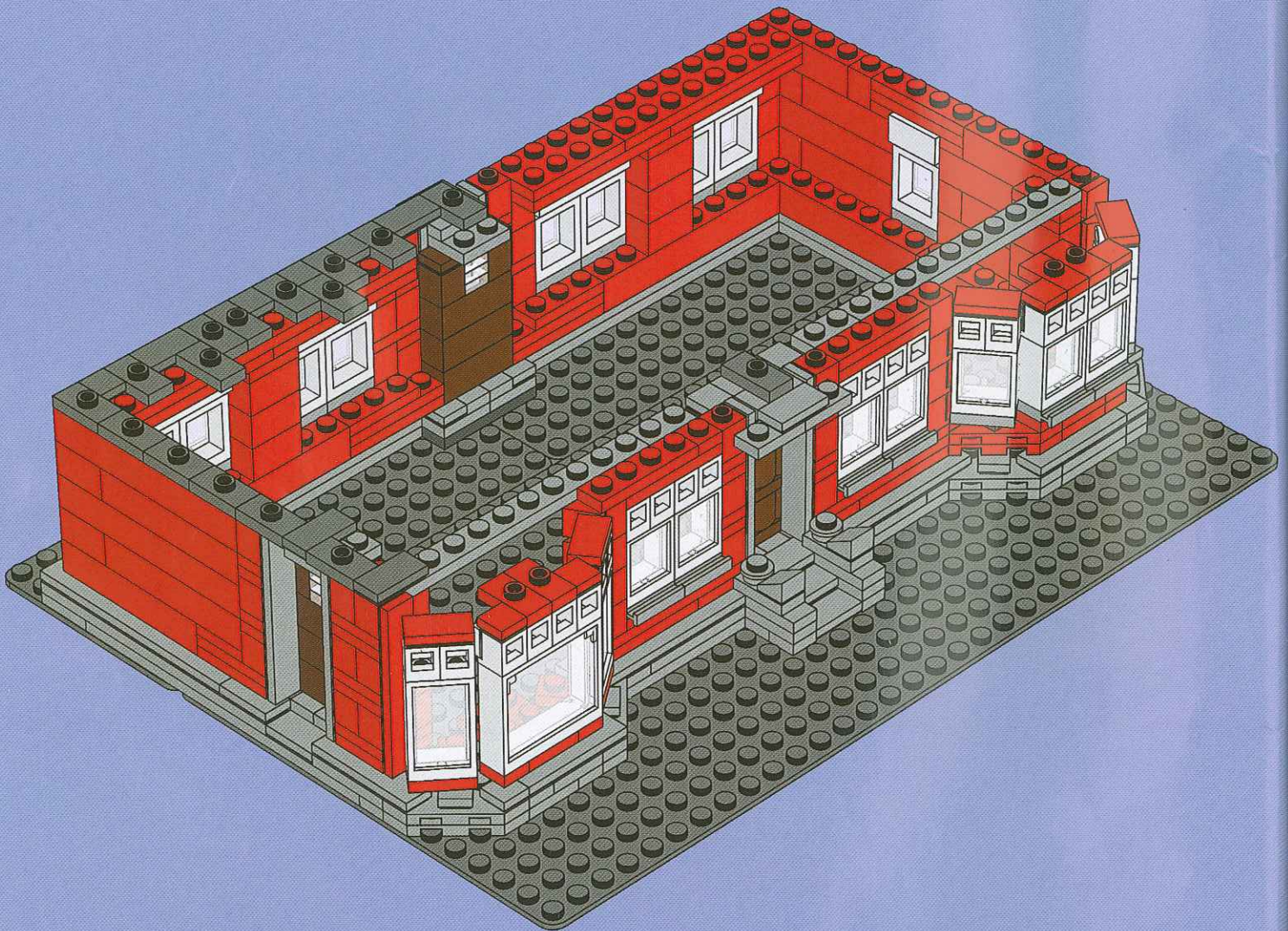



5x



3x



14x

50

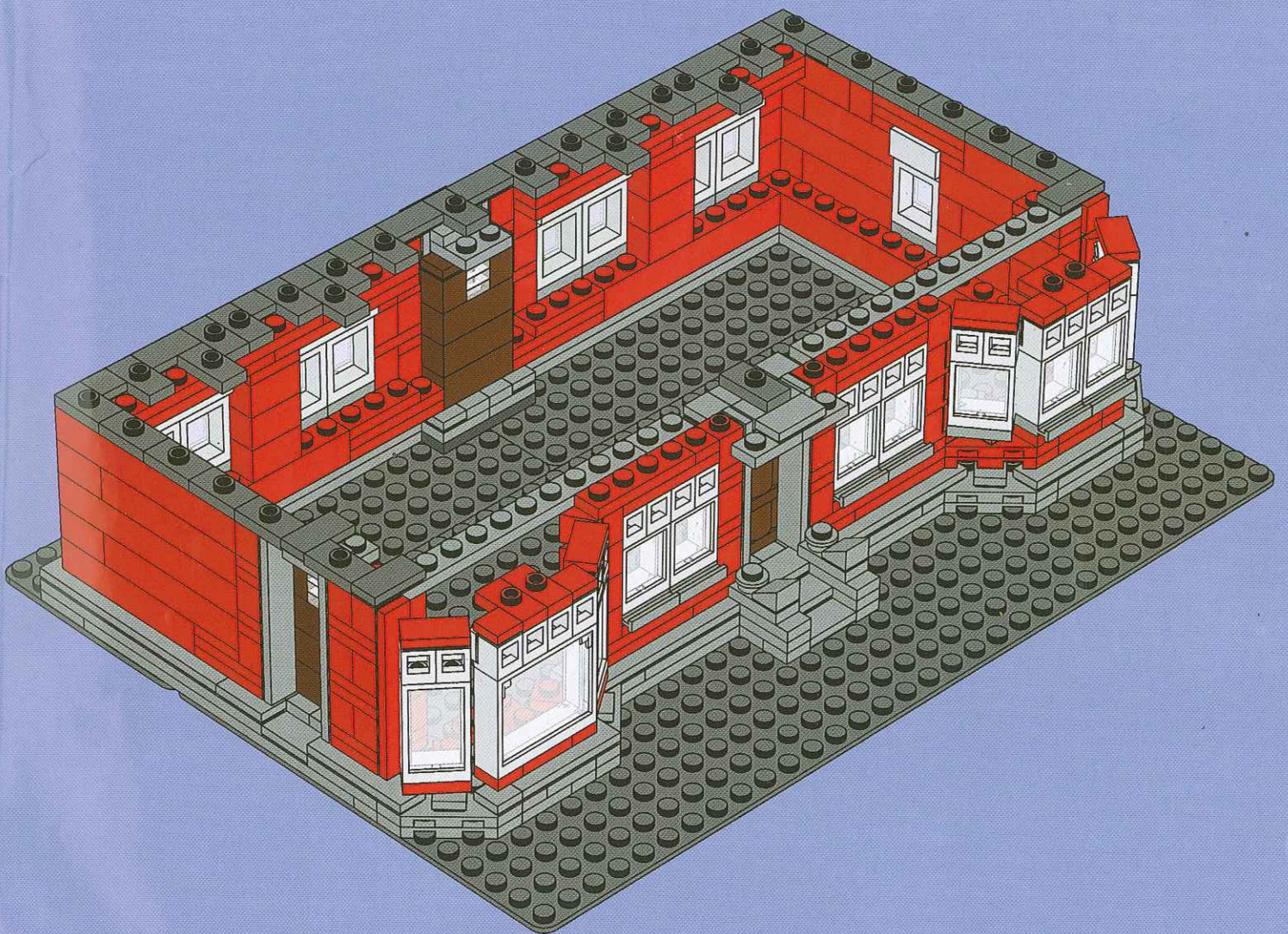

Ole Kirk's House

The founder of the LEGO Group, Ole Kirk Kristiansen, was 25-years-old when he purchased the Billund Timber Machinist and Carpentry business located in the centre of Billund. He lived and worked on this property from 1916 until 1924, when the house and workshop were destroyed in a fire. While Ole Kirk and his wife were taking an afternoon nap, their sons played in the workshop. They ignited a glue heater full of wood shavings. Shortly after, the building was engulfed in flames.

In the same year, Ole Kirk did some carpentry work for a new co-operative dairy in Billund. The architect responsible for designing the dairy also designed a new home for Ole Kirk and his family. This house still stands today and has always been known locally as 'Løvehuset' (the Lion House), because of the two lions guarding the front door.

By the standards of the day, the house was large and attractive. To make ends meet, Ole Kirk was forced to rent out as much of the house as he could. When Ole Kirk began to manufacture wooden toys in 1932, he rented out the upper storey, while his family lived in another part of the house. The rest of the house was used as office space.

In 1942, another fire broke out and burned down the entire factory. Luckily, the house itself narrowly escaped the flames.

Until 1958, the house was both the family home and the toy company office. It was at this point that Godtfred Kirk Christiansen had to face the fact he could no longer manage the growing company from the house. So he built 'Systemhuset' (The System House) in Ole Kirk's garden grounds. Then in 1963, the building was extended out towards Hovedgaden (Main Street) and joined to Ole Kirk's House.

Ole Kirk Kristiansen died in 1958. His widow Sofie continued to live in the house until 1962.

Ole Kirk's House, together with the wood factory and 'Systemhuset' (The System House), was sold to Billund Municipality in 1973, where it functioned as the town hall until 1982. Shortly after, the LEGO Group re-acquired the complex and began using Ole Kirk's House as part of the Product Development Division.

Ole Kirk's House was renovated in 2002-2003, and since 2005 has been owned by LEGO Fonden (The LEGO Foundation). Today, it forms part of the historical exhibition on display at the LEGO® Idé Huset (The LEGO Idea House).

Ole Kirks Haus

Ole Kirk Kristiansen, Gründer der LEGO Group, war 25 Jahre alt, als er eine Tischlerei im Zentrum von Billund erwarb. In diesem Gebäude lebte und arbeitete er von 1916 bis 1924, als das Haus und die Werkstatt durch ein Feuer zerstört wurden. Als Ole Kirk und seine Frau ihren Mittagsschlaf hielten, spielten die Söhne in der Werkstatt. Dabei entzündeten die Kinder einen Leimofen voller Holzspäne. Schon bald stand das ganze Gebäude in Flammen.

Im selben Jahr übernahm Ole Kirk einige Tischlerarbeiten für eine neue genossenschaftliche Molkerei in Billund. Der für den Entwurf der Molkerei verantwortliche Architekt plante auch den Bau eines neuen Heims für Ole Kirk und dessen Familie. Dieses Haus steht auch heute noch und ist im Ort als das „Løvehuset“ (Löwenhaus) bekannt, weil zwei Löwen die Vordertür bewachen.

Nach damaligen Maßstäben war das Haus sehr groß und äußerst stattlich. Um über die Runden zu kommen, musste Ole Kirk einen ziemlich großen Teil des Hauses vermieten. Als Ole Kirk im Jahr 1932 mit der Fertigung von Holzspielzeug begann, vermietete er das Obergeschoss. Er selbst bewohnte mit seiner Familie einen anderen Teil des Hauses. Die restlichen Räume wurden als Büros genutzt.

1942 brach erneut ein Feuer aus, das die ganze Fabrik vernichtete. Glücklicherweise entging das Haus selbst den Flammen – wenn auch nur knapp.

Bis 1958 diente das Haus der Familie als Wohnsitz und der Spielzeugfirma als Bürogebäude. Genau zu jener Zeit musste sich Godtfred Kirk Christiansen der Tatsache stellen, dass er das wachsende Unternehmen nicht länger von seinem Zuhause aus führen konnte. Deshalb errichtete er das „Systemhuset“ (Systemhaus) auf Ole Kirks Gartengrundstück. Im Jahr 1963 wurde das Gebäude dann in Richtung der Hovedgaden (Hauptstraße) erweitert und an Ole Kirks Haus angebaut.

Ole Kirk Kristiansen verstarb im Jahr 1958. Seine Witwe Sofie lebte noch bis 1962 in dem Haus.

1973 wurde Ole Kirks Haus zusammen mit der Holzfabrik und dem „Systemhuset“ (Systemhaus) an die Gemeinde Billund veräußert, die das Gebäude bis 1982 als Rathaus nutzte. Kurz darauf erwarb die LEGO Group erneut den ganzen Gebäudekomplex und brachte dort einen Teil der Produktentwicklungsabteilung unter.

Ole Kirks Haus wurde 2002-2003 renoviert und befindet sich seit 2005 im Besitz des LEGO Fonden (The LEGO Foundation). Heute ist es Teil der historischen Ausstellung, die im LEGO® Idé Huset (The LEGO Idea House) zu bestaunen ist.

La maison d'Ole Kirk

Le fondateur du Groupe LEGO, Ole Kirk Kristiansen, avait 25 ans lorsqu'il acheta l'entreprise de bois et de charpenterie située dans le centre de Billund. Il vécut et travailla dans ce bâtiment de 1916 jusqu'à 1924 quand la maison et l'atelier furent détruits par un incendie. Pendant qu'Ole et sa femme faisaient une sieste, leurs fils jouaient dans l'atelier. Ils allumèrent une machine à chauffer la colle pleine de copeaux de bois. Le bâtiment fut rapidement dévoré par les flammes.

La même année, Ole Kirk fit des travaux de charpenterie pour une nouvelle coopérative laitière à Billund. L'architecte responsable de la conception de la laiterie créa également une nouvelle maison pour Ole Kirk et sa famille. La maison existe toujours aujourd'hui et est connue localement comme la « Løvehuset » (la maison du lion), à cause des deux lions qui gardent la porte d'entrée.

La maison était grande et attirante selon les standards de l'époque. Pour joindre les deux bouts, Ole Kirk fut obligé de louer une partie aussi grande que possible de la maison. Lorsqu'Ole Kirk commença à fabriquer des jouets en bois en 1932, il loua l'étage supérieur, tandis que sa famille vivait dans une autre partie de la maison. Le reste du bâtiment était utilisé comme espace de bureaux.

En 1942, un autre incendie se déclara et brûla toute l'usine. Heureusement, la maison elle-même échappa de justesse aux flammes.

Jusqu'en 1958, la maison devint la maison de famille et les bureaux de l'entreprise de jouets. C'est à ce moment que Godtfred Kirk Christiansen dut faire face au fait qu'il ne pouvait plus gérer depuis sa maison l'entreprise en pleine expansion. Il construisit donc « Systemhuset » (la maison système) dans le jardin d'Ole Kirk. Puis en 1963, le bâtiment fut étendu vers Hovedgaden (la rue principale) et relié à la maison d'Ole Kirk.

Ole Kirk Kristiansen mourut en 1958. Sa veuve Sofie continua à vivre dans la maison jusqu'en 1962.

La maison d'Ole Kirk, ainsi que l'usine de bois et « Systemhuset » (la maison système), furent vendues à la municipalité de Billund en 1973, et utilisées comme mairie jusqu'en 1982. Peu après, le Groupe LEGO racheta le complexe et commença à utiliser la maison d'Ole Kirk pour la division de développement de produits.

La maison d'Ole Kirk fut rénovée en 2002-2003, et est depuis 2005 la propriété de LEGO Fonden (la Fondation LEGO). Elle fait aujourd'hui partie de l'exposition historique à LEGO® Idé Huset (la maison des Idées LEGO).

