



# NINJAGO

71781





[LEGO.com/sustainable-packaging](https://LEGO.com/sustainable-packaging)



# BUILDER



Apple and the Apple logo are trademarks of Apple Inc., registered in the U.S. and other countries and regions. App Store is a service mark of Apple Inc. Google Play and the Google Play logo are trademarks of Google LLC. Tencent and the Tencent logo are trademarks of Tencent Inc.

 [LEGO.com/devicecheck](https://www.lego.com/devicecheck)

**EN** Ask parents' permission before going online | **DE** Eltern um Erlaubnis bitten, bevor du online gehst | **FR** Demande l'autorisation d'un parent avant d'aller en ligne | **IT** Chiedi il permesso ai tuoi genitori prima di andare online | **ES** Pídeles permiso a tus papás antes de conectarte a Internet | **PT** Pede autorização aos pais antes de acederes online | **JA** オンラインになる前に ほご者の方のきよかをもらおう | **ZH** 上网前应先征得父母的同意 | **KO** 온라인 접속 전에 보호자 동의가 필요합니다 | **RU** Спроси разрешения у родителей, прежде чем заходить в интернет | **PL** Poproś rodziców o zgodę, zanim wejdiesz do Internetu | **CS** Než půjdeš na internet, požádej rodiče o svolení | **SK** Skôr než pôjdeš na internet, vypýtaj si povolenie od rodičov | **HU** Kérj szülői engedélyt, mielőtt online csatlakoznál! | **RO** Cere permisiunea părinților înainte de a te conecta online | **BG** Поискайте разрешение от родител, преди да влезете онлайн | **LV** Pirms došanās tiešsaistē palūdz atļauju vecākiem | **ET** Enne Interneti kasutamist küsi vanematelt luba | **LT** Prieš prisijungdami prie interneto, atsiklauskite tėvų

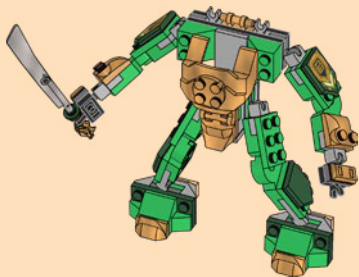

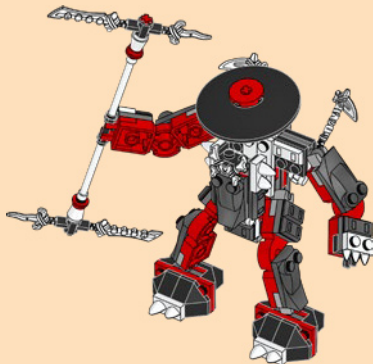

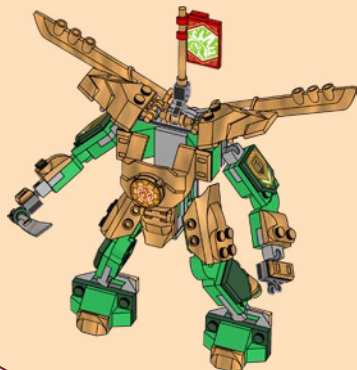
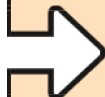



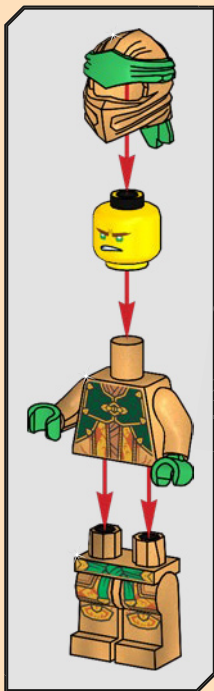



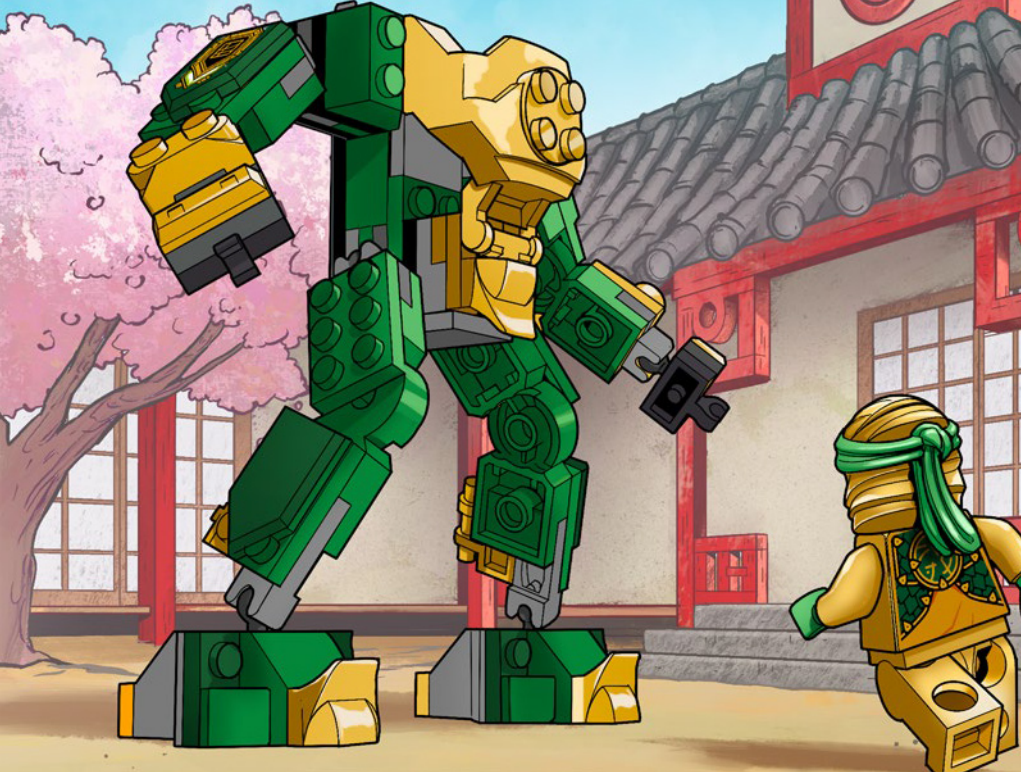



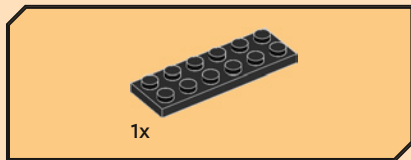
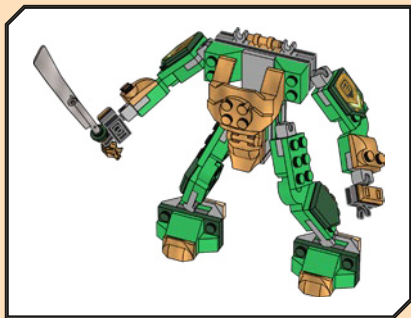

1x

1

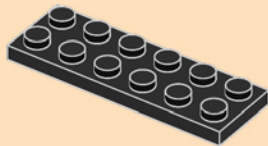



2

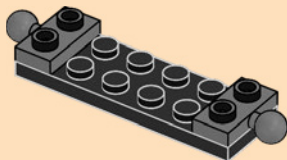

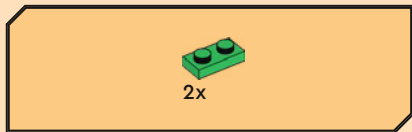

3

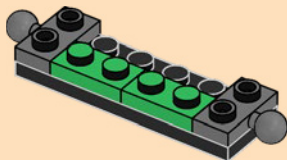

4

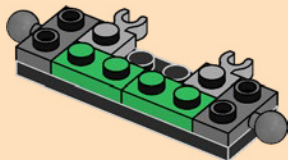



5

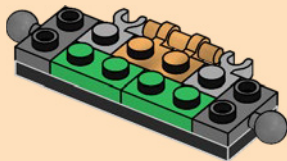

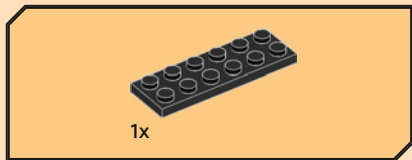

6

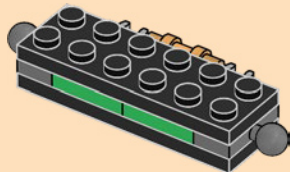

7

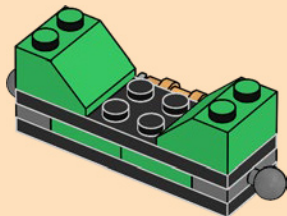

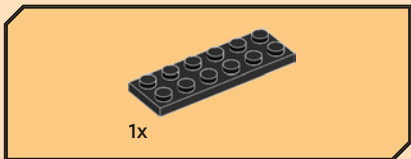

8

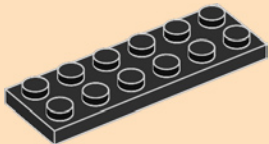



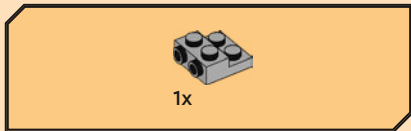

9

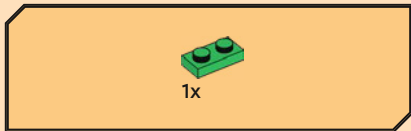
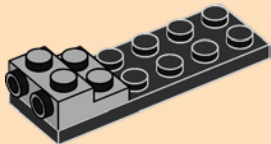

10

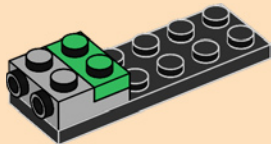



11

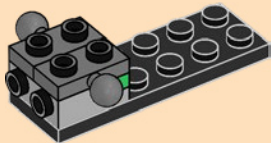

18

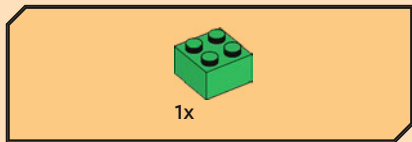

12

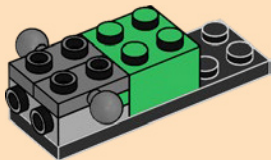

13

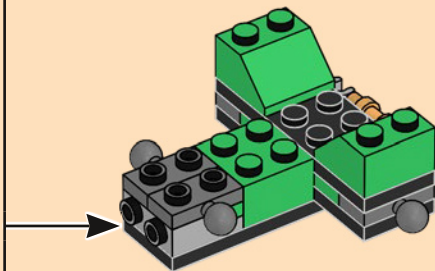

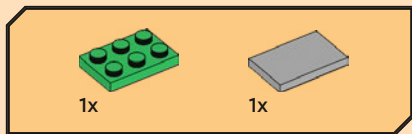

14

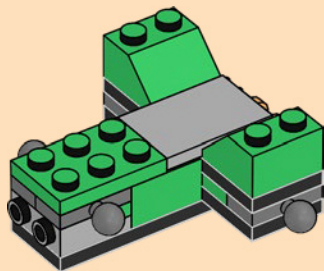



1x

15

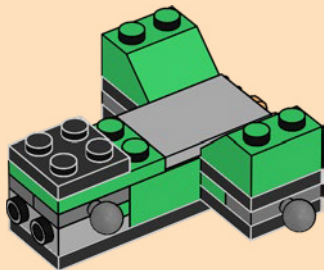

1x

16

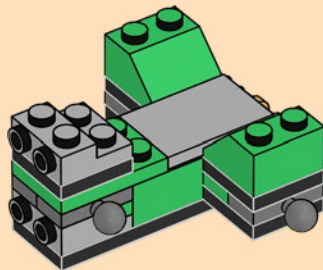

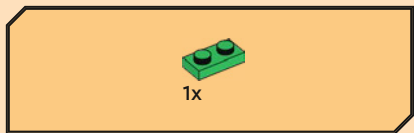

17

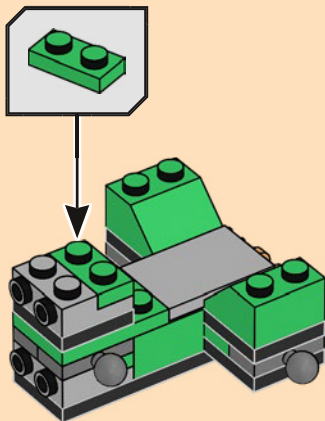



18

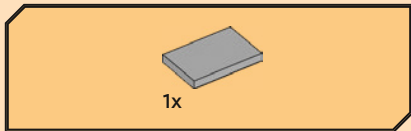
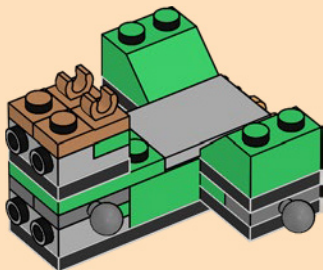

19

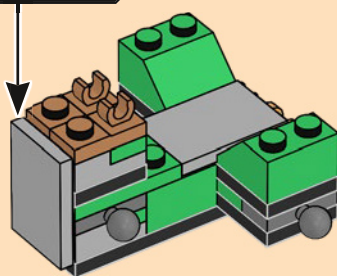
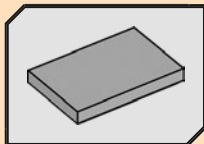

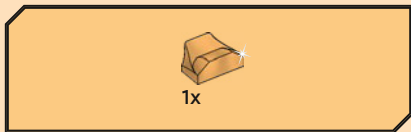

20

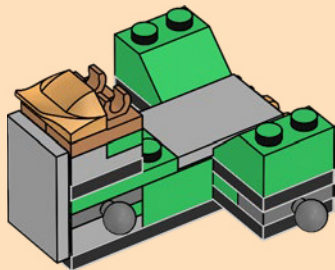

24



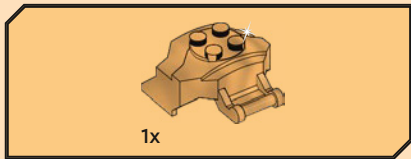

21

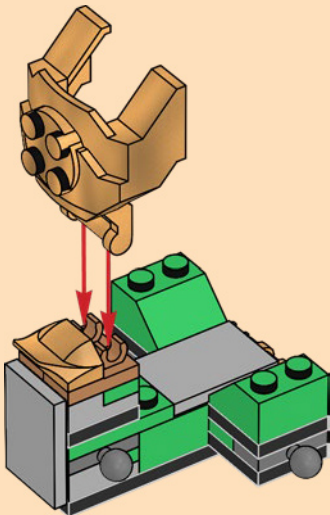

22

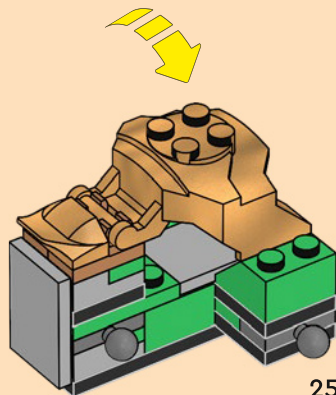

25



23

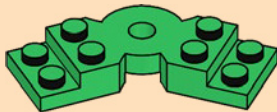

26



24

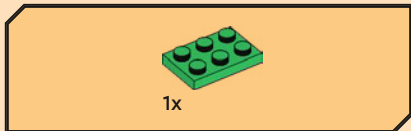

25

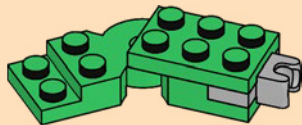



1x

26

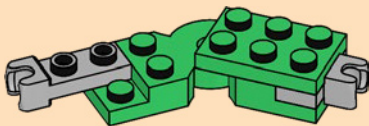



1x

27

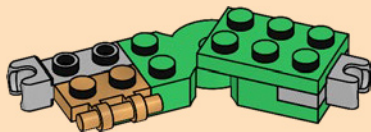

1x

28

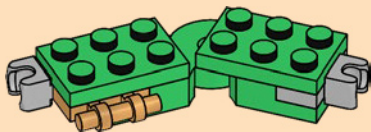



29



30

30

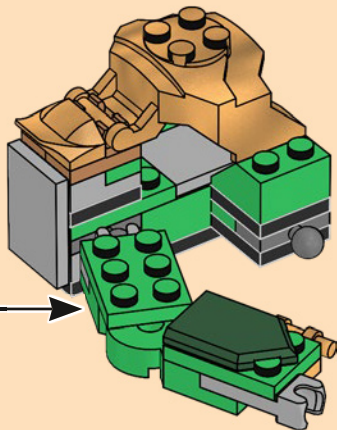



1x

31



32





1x

32



1x

33

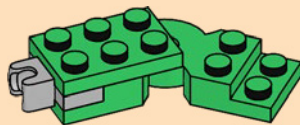



1x

34

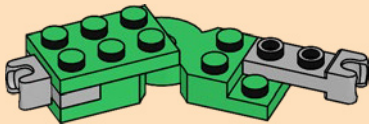

34

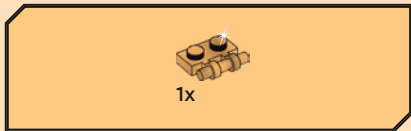

35

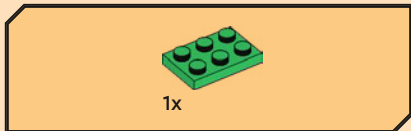

36

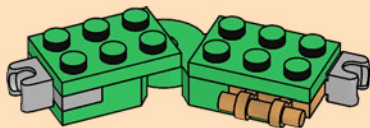



37



36

38

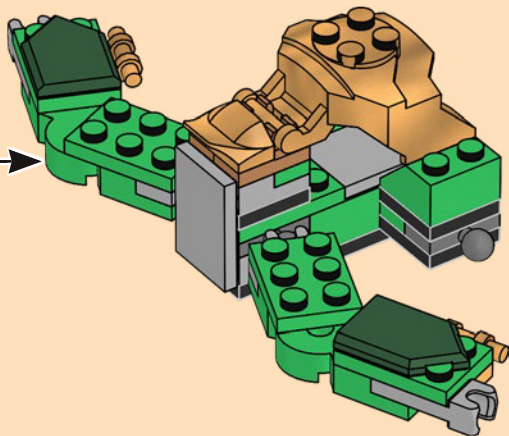

39

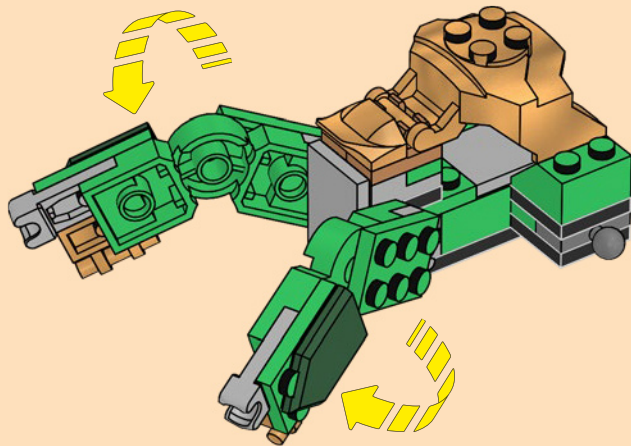

38



2x

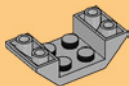

1x

40

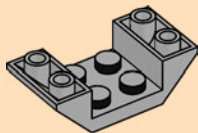

1x

41

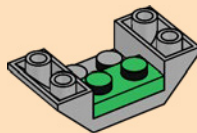

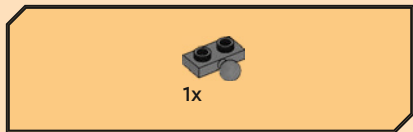

42

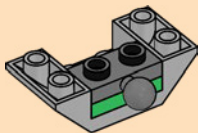

40



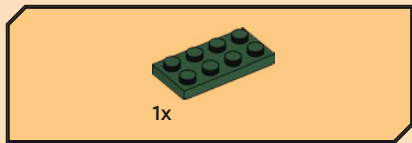

43

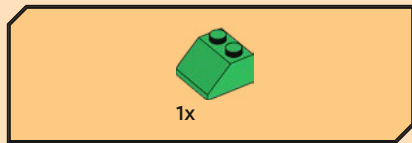
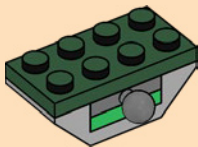

44

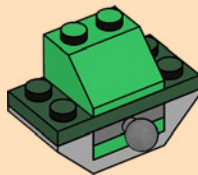



2x

45

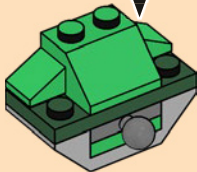
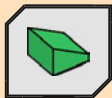

42

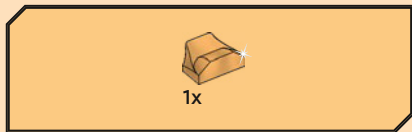

46

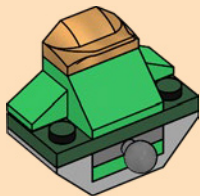

47

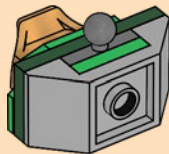

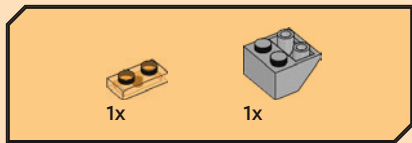

48

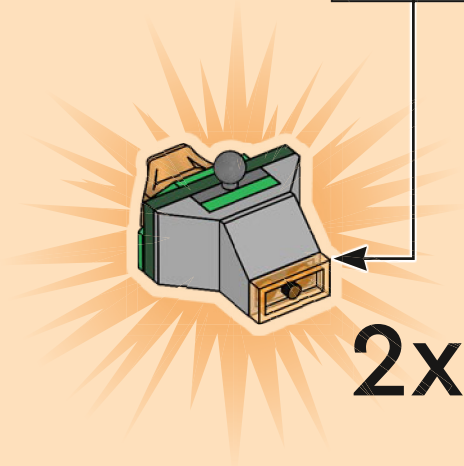
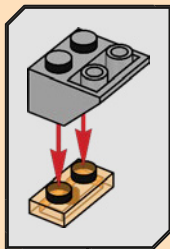

2x

49

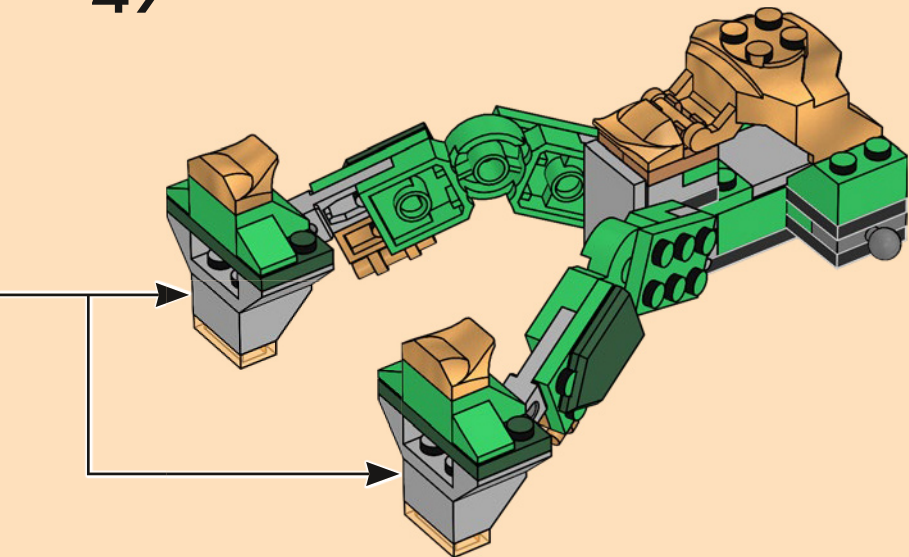



50





2x

51



1x

52

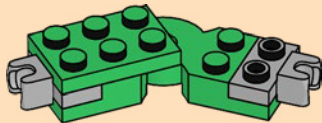



1x

53

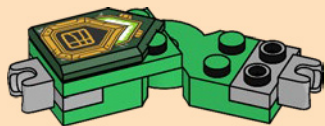

1x

54





55

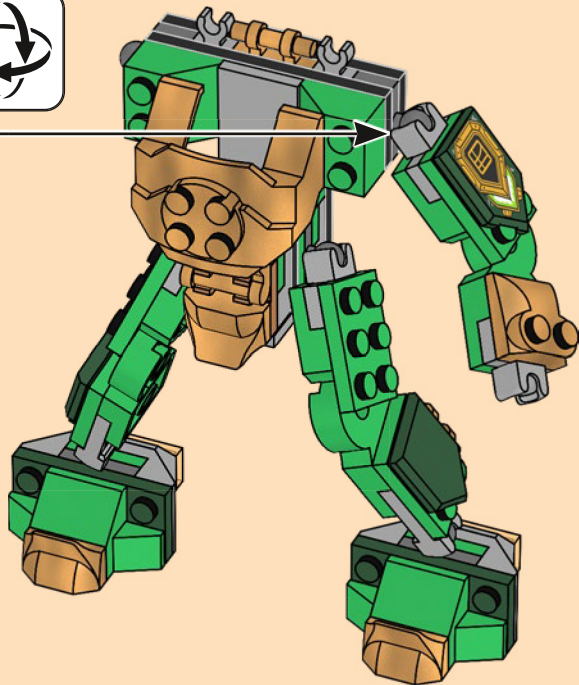
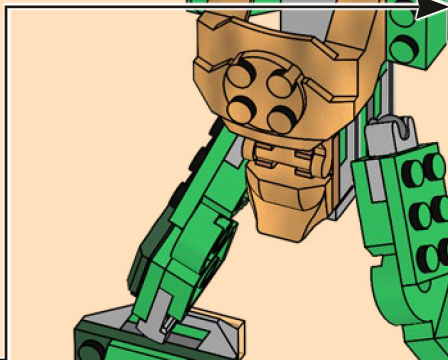

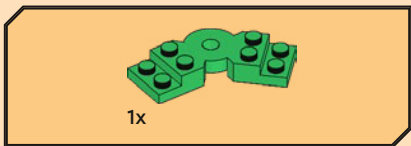

56





2x

57



1x

58

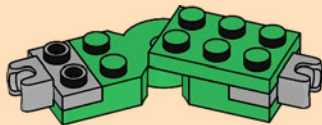



1x

59

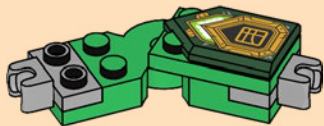

52



1x

60



61

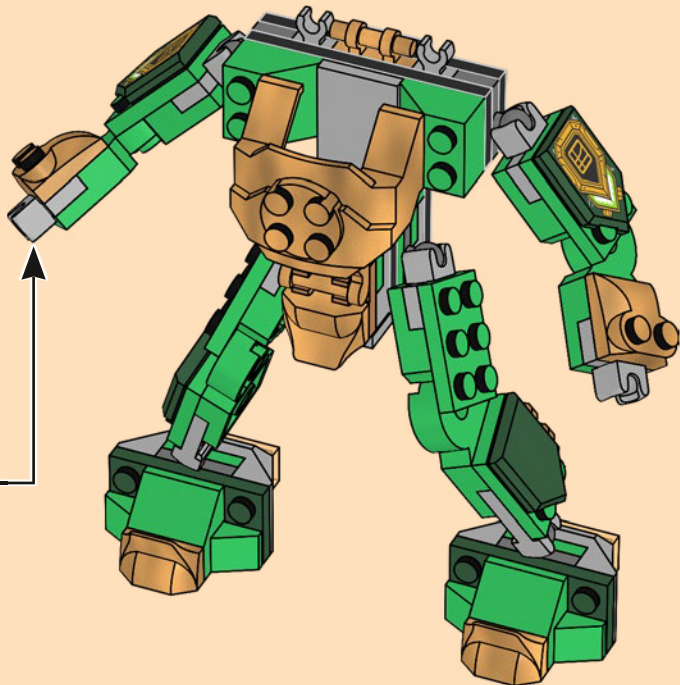



62

1



2



3



2x

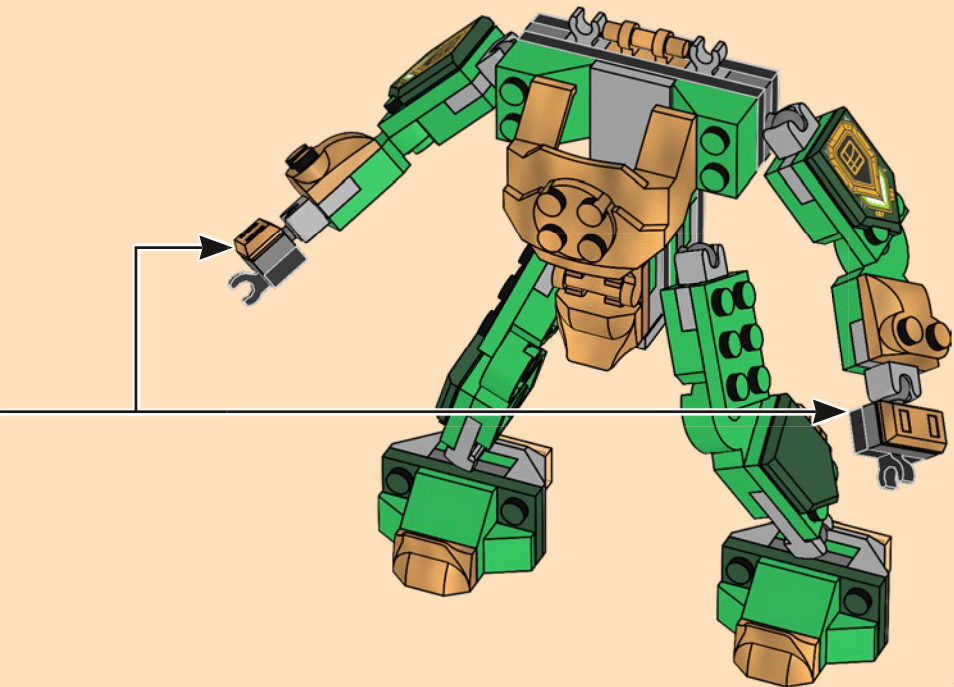

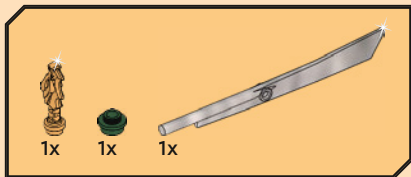

63

1



2

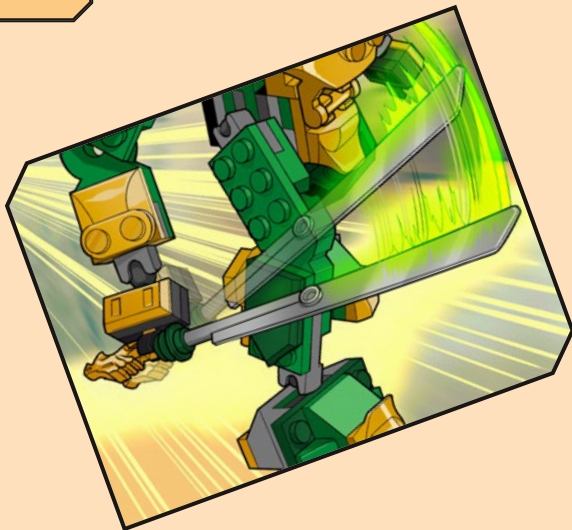



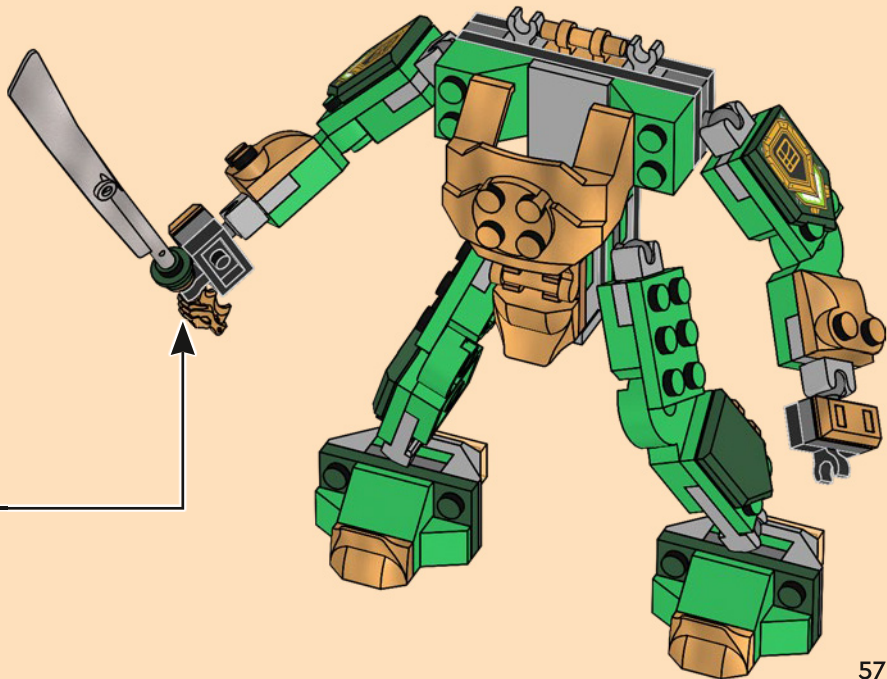

64

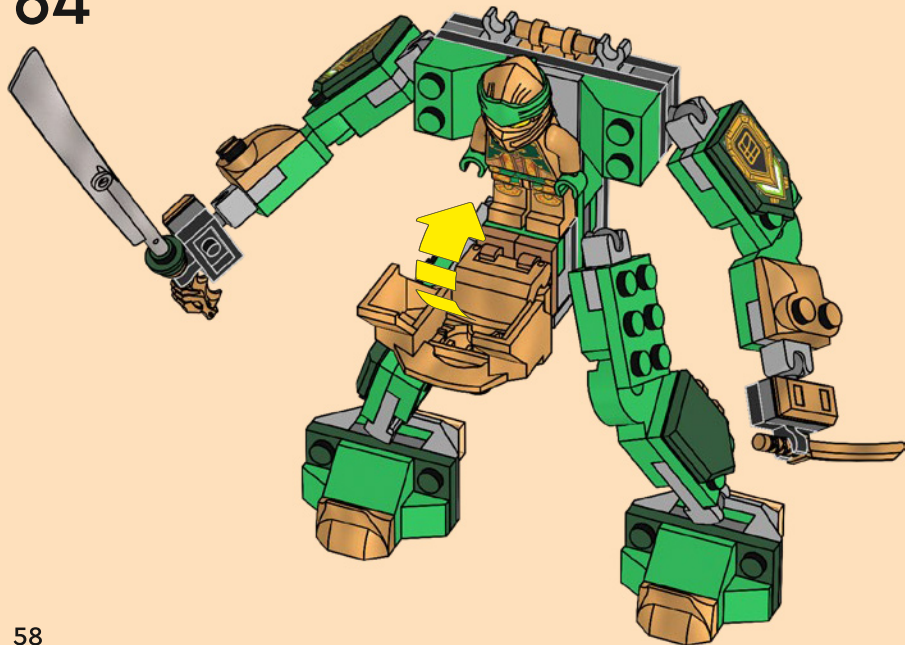

58

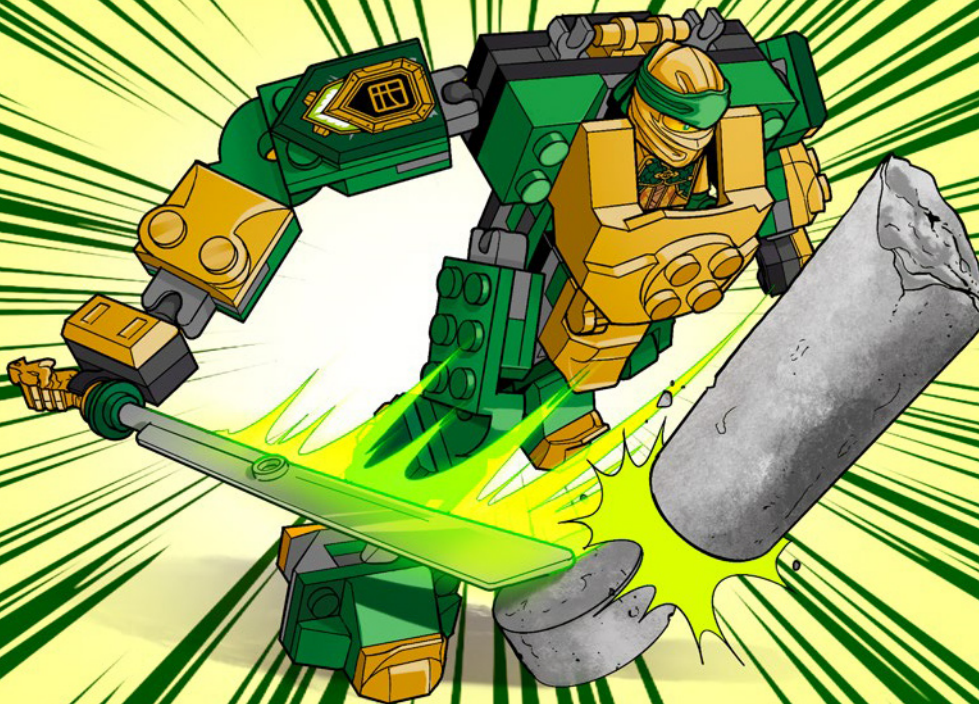

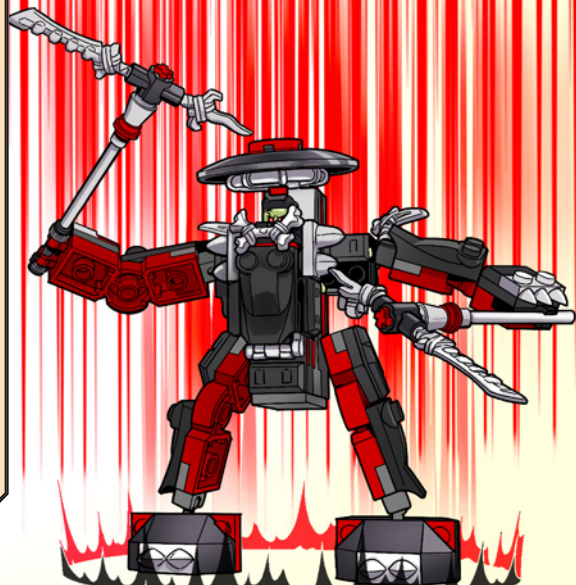
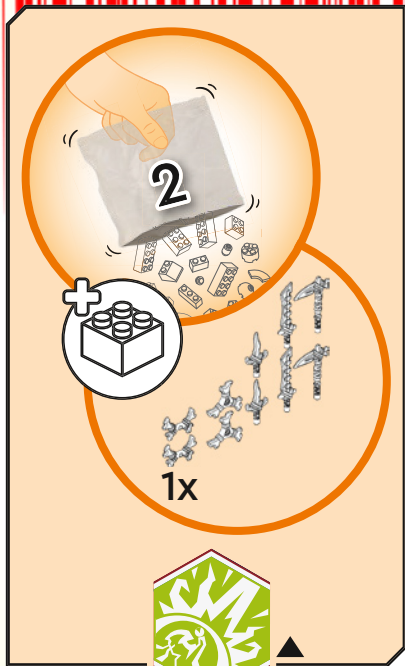

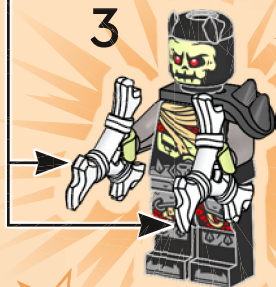
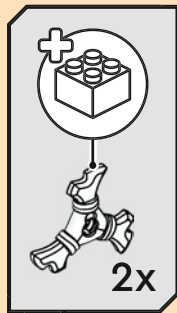
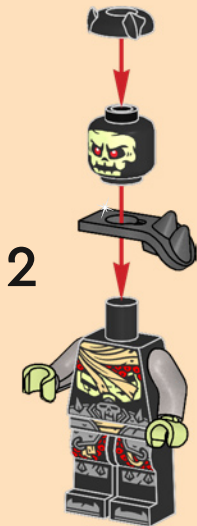
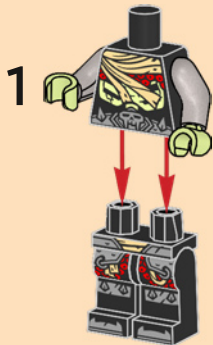

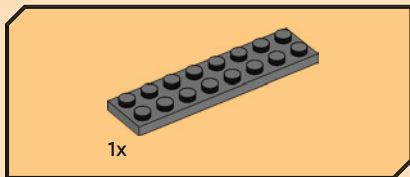
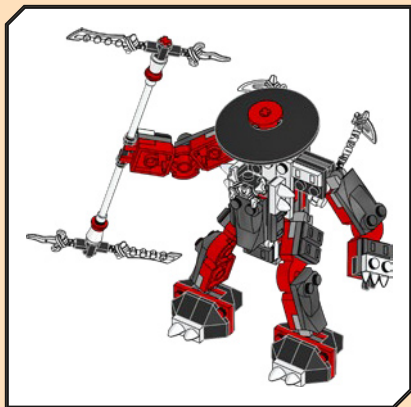

1

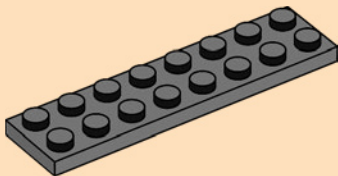



2

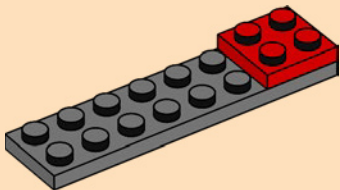

3

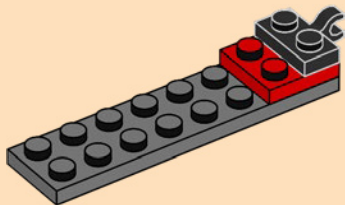

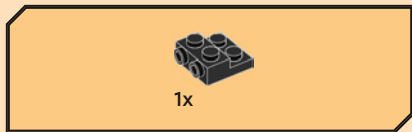

4

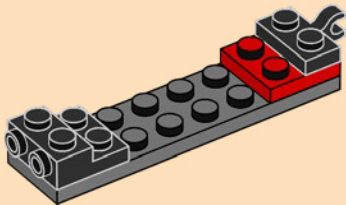



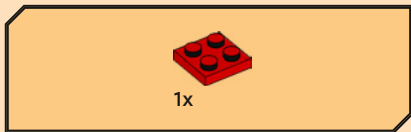

5

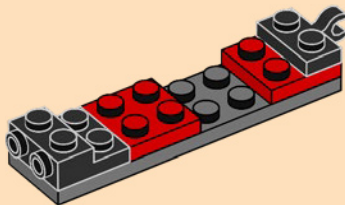

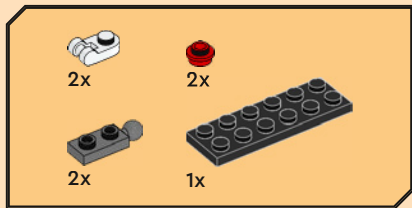

6

1

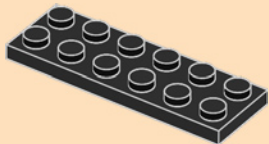

2

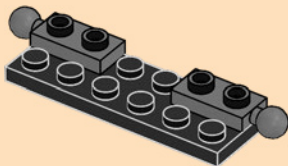

3

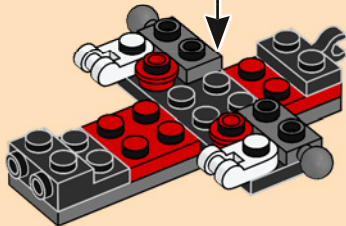
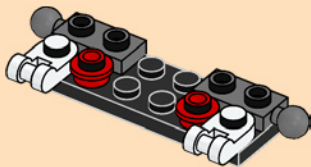

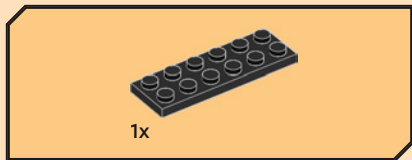

7

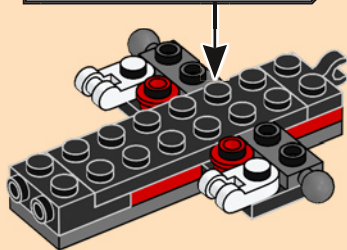
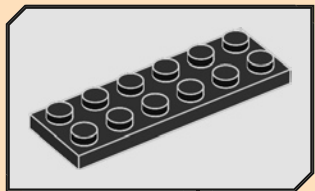

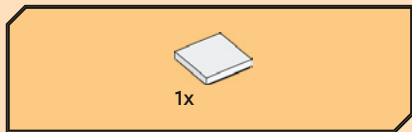

8

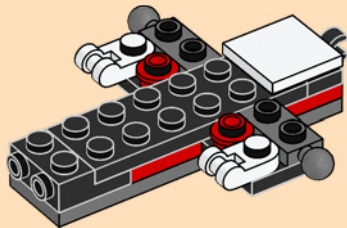

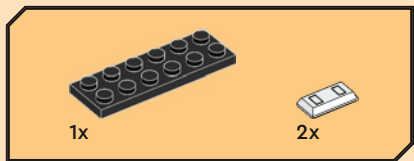

9

1

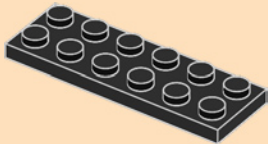

2

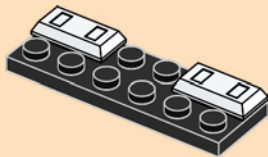

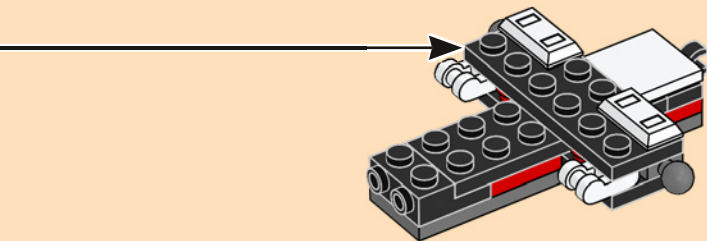

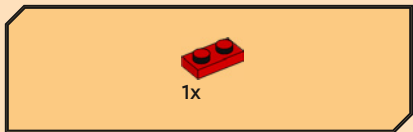

10

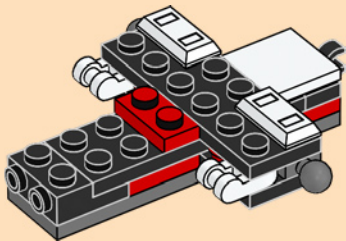





2x

11

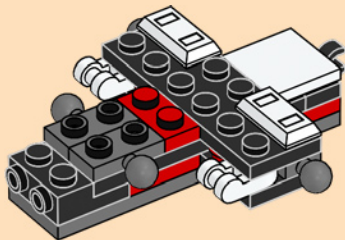

1x

12

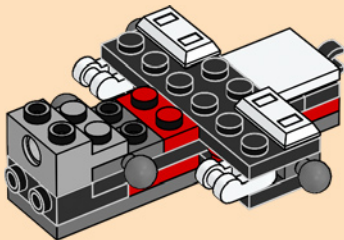

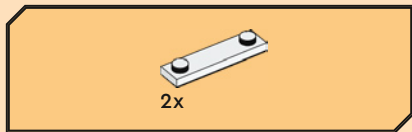

13

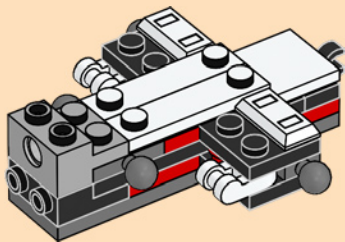



14

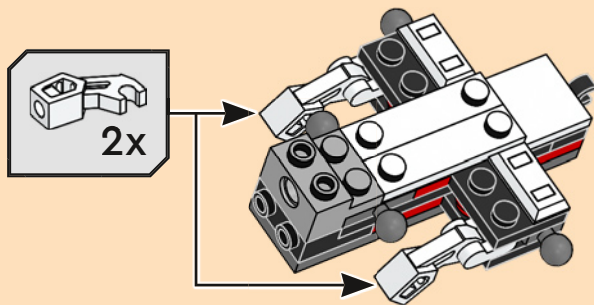

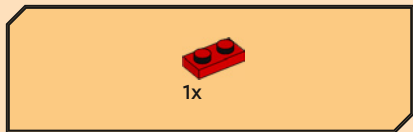

15

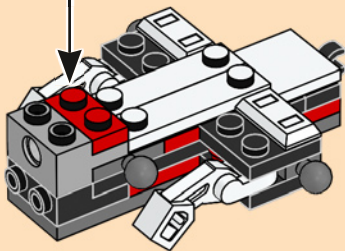



1x

16

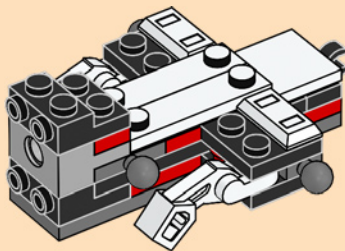

1x

17

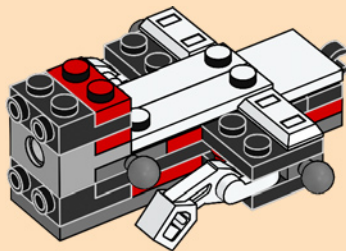



2x

18

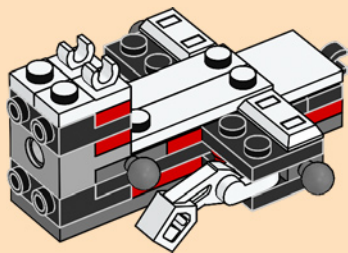

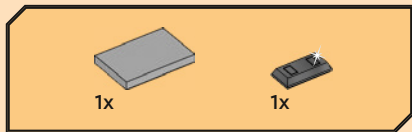

19

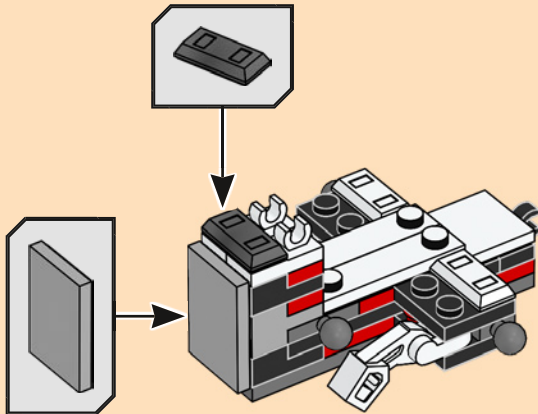

20

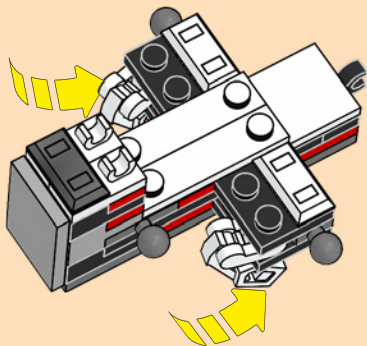

80





1x

21



2x

22



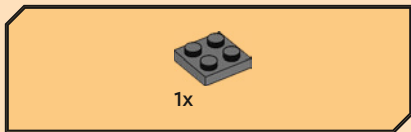

23

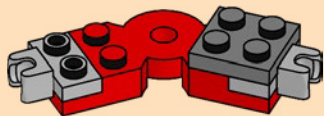

24

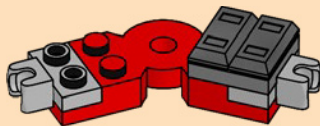



25

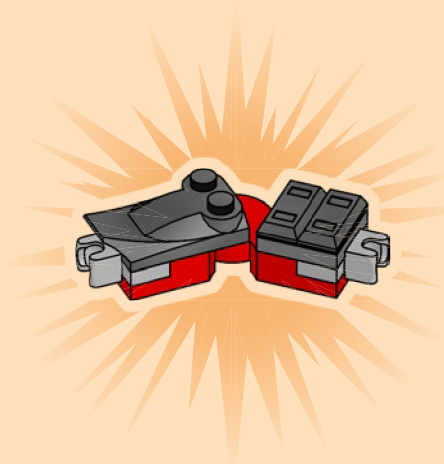

26

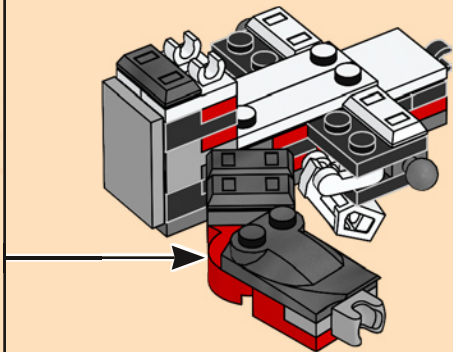



1x

27





2x

28

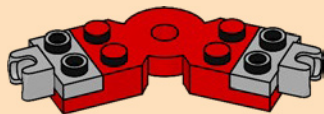

1x

29

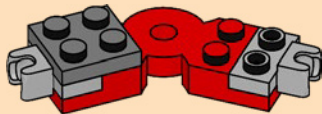

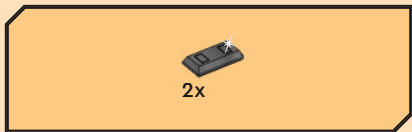

30



31

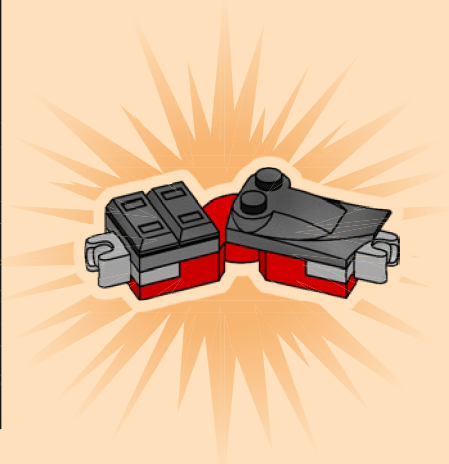

32

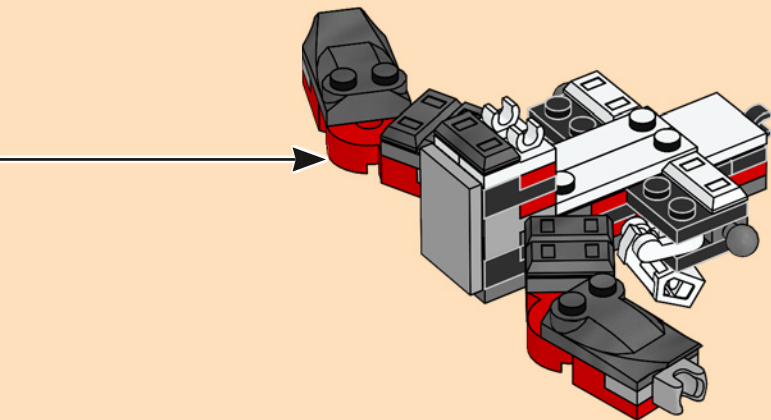

33

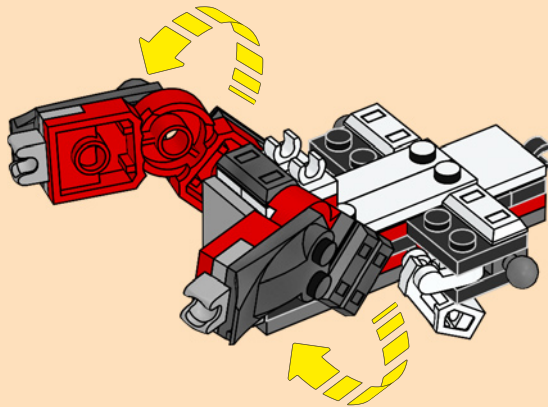

88





2x

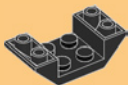

1x

34

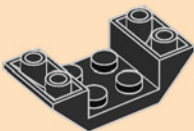

1x

35

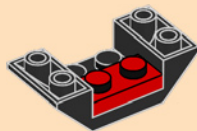



1x

36

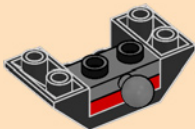

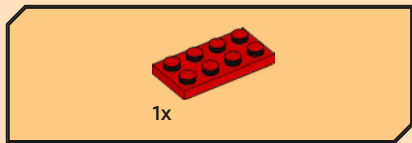

37

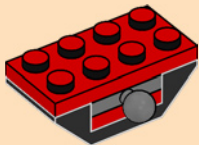

38

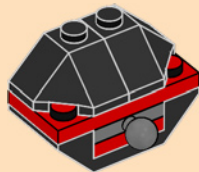



1x

39



40



41

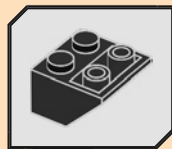
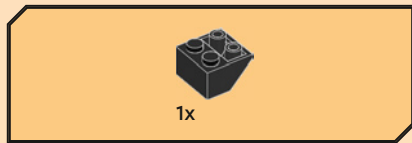

2x

42

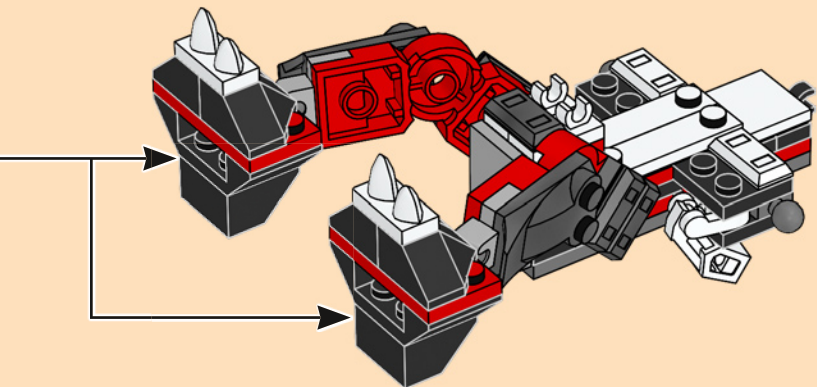

94



43



44





1x

45

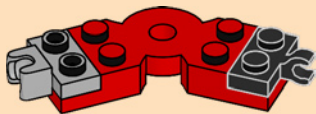



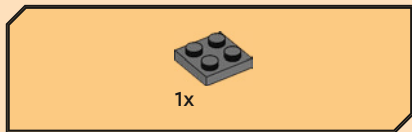

46

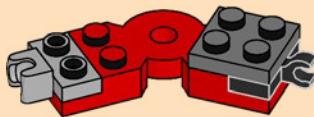

47

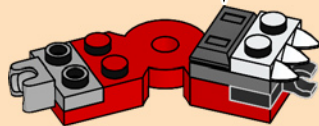
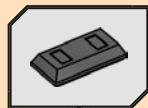



1x

48

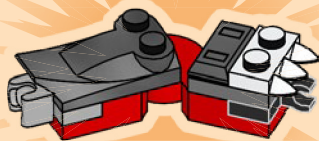

49

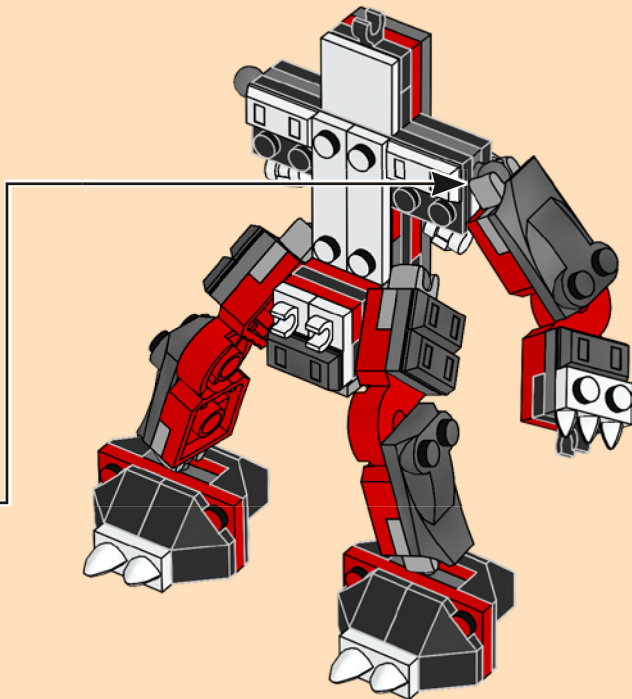



50



100



51



52



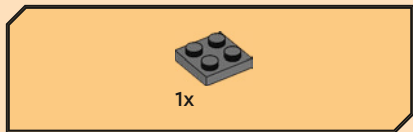

53

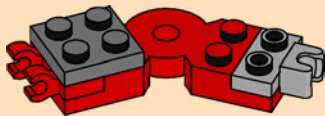



1x

54

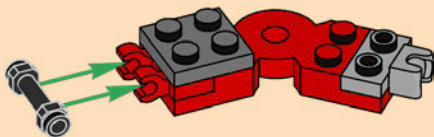

1x



1x

55

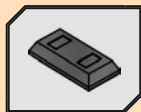



1x

56





57

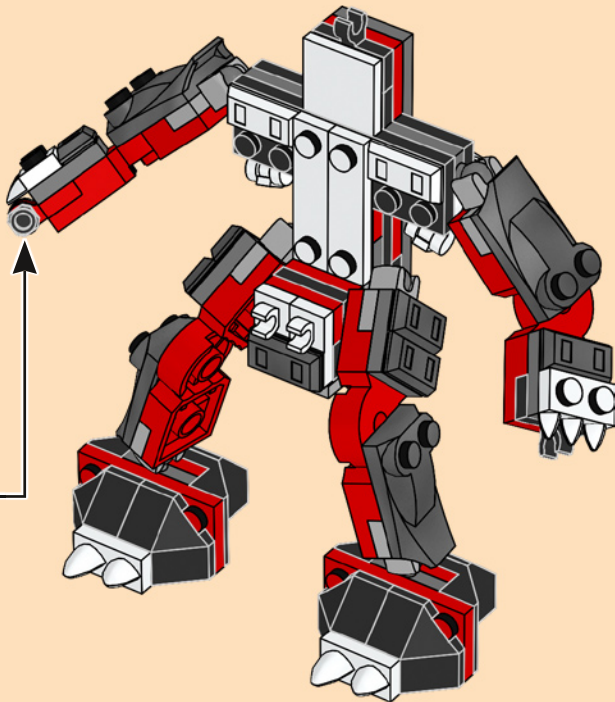



58

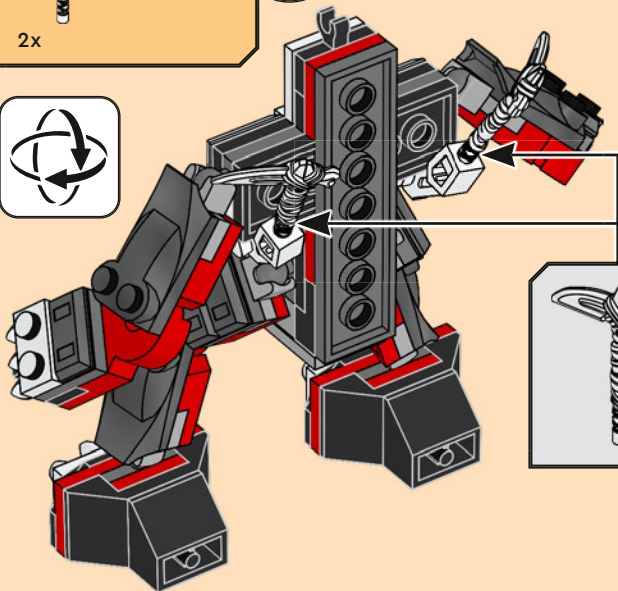

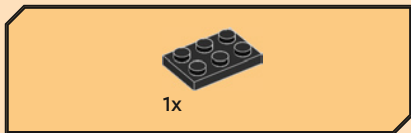

59

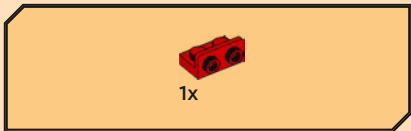
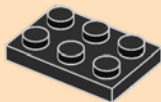

60

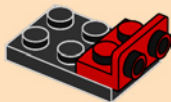

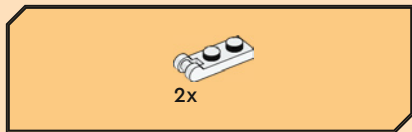

61





1x

62



2x

63

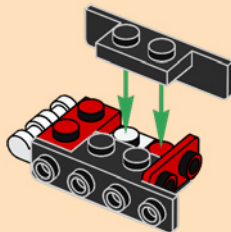



64

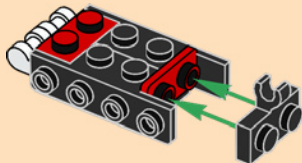

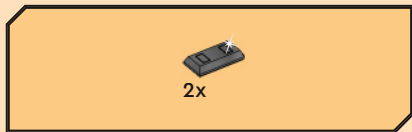

65

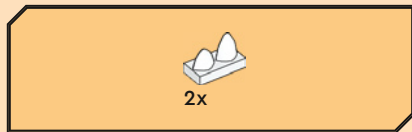
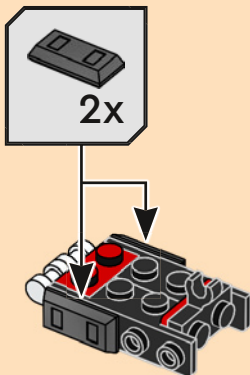

66

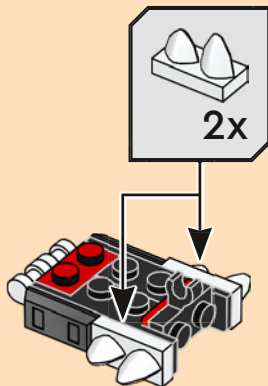



67

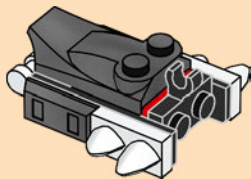

68

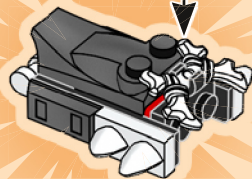



69

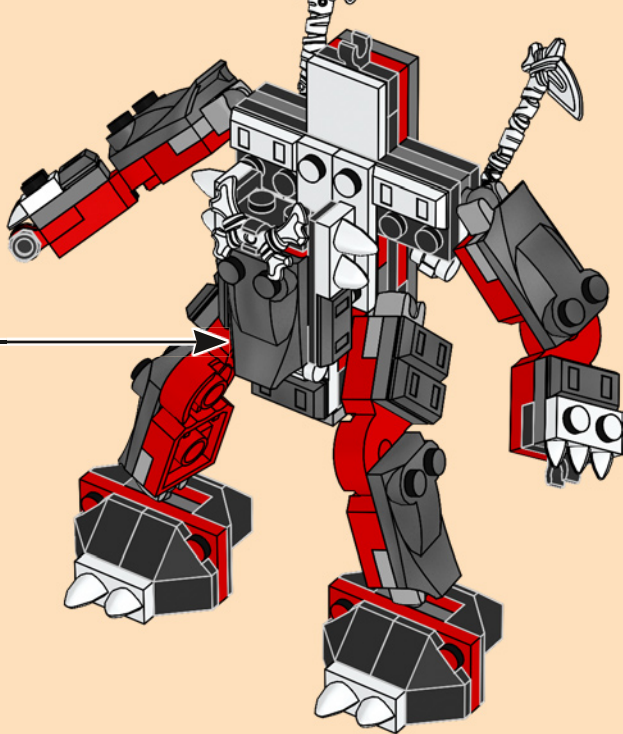

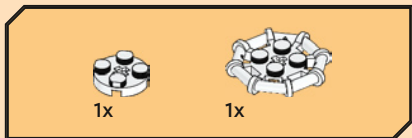
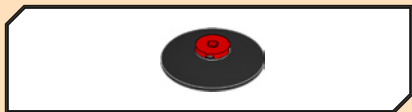

70

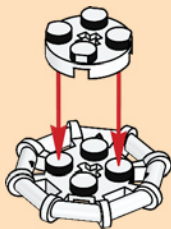

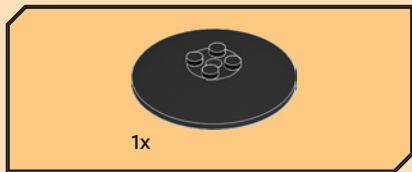

71

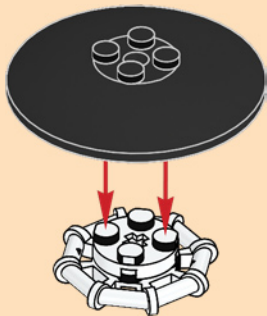

72

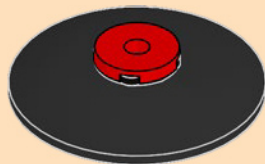

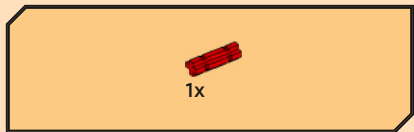

73

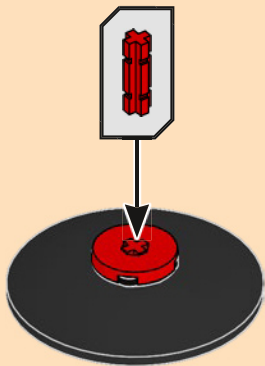

74

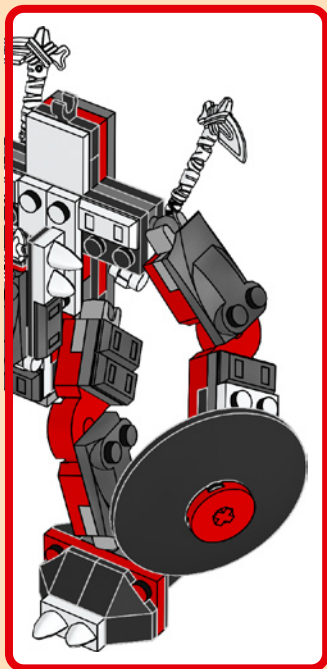
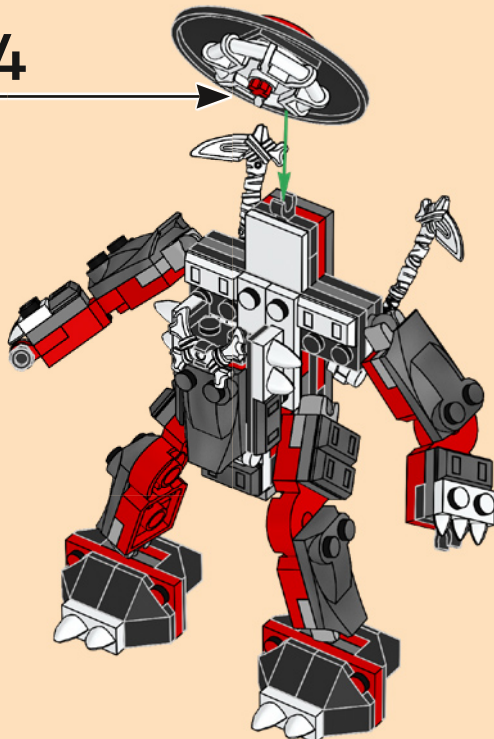

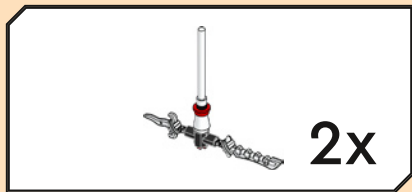

75

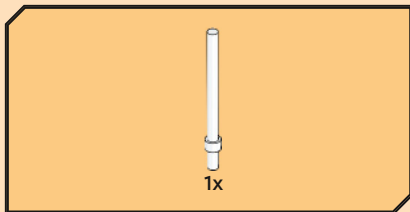

76

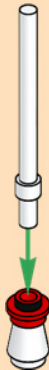

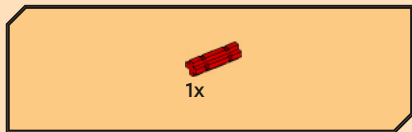

77



78



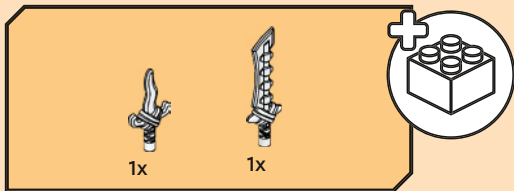

79

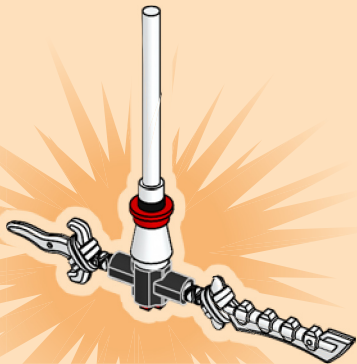

2x



80

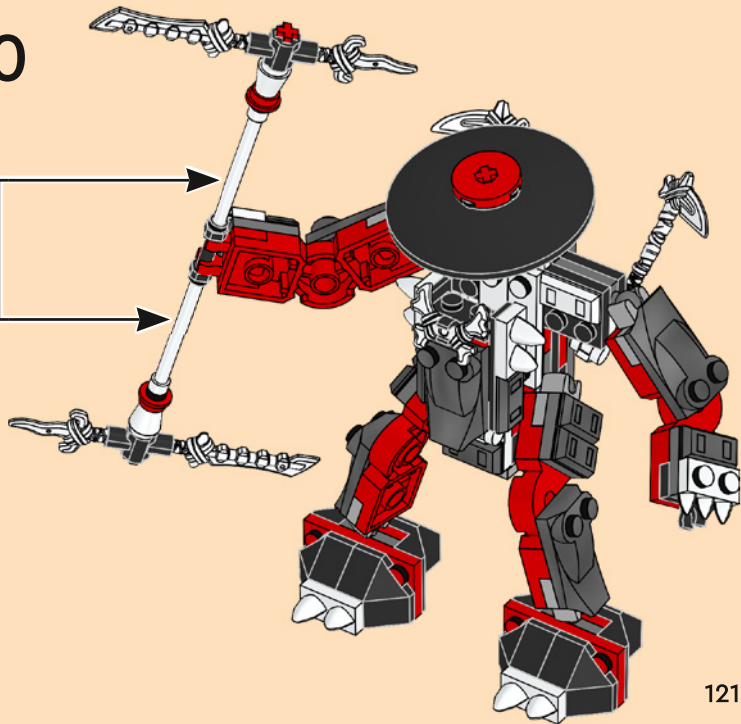

81

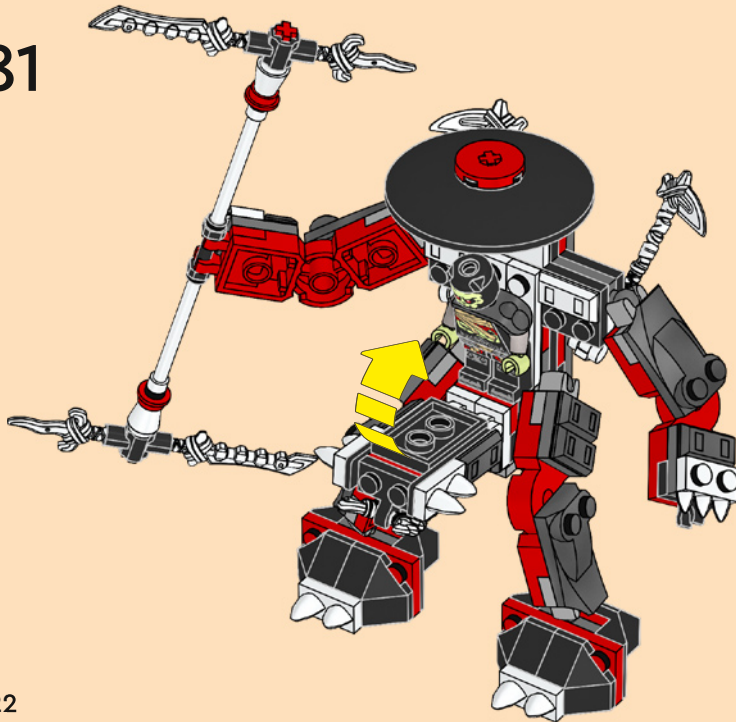

122



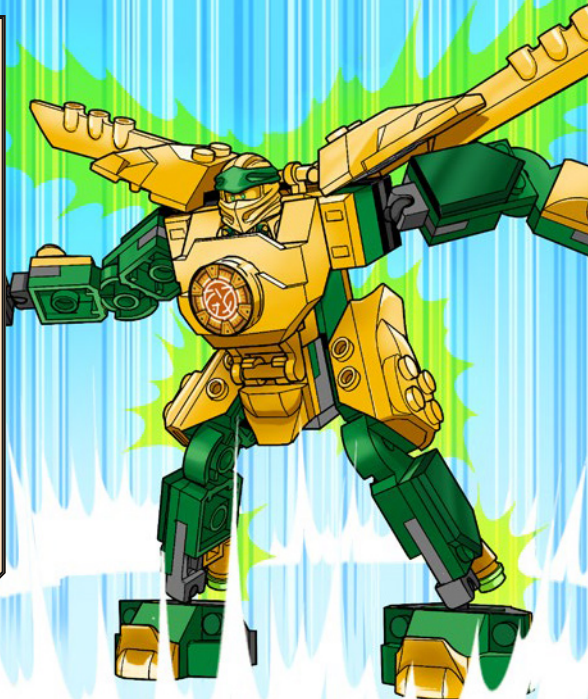



1

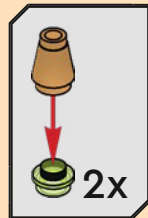
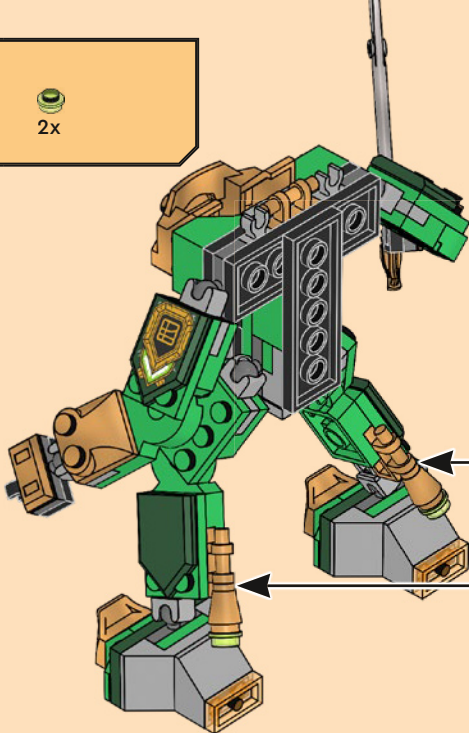

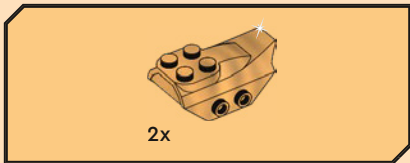

2

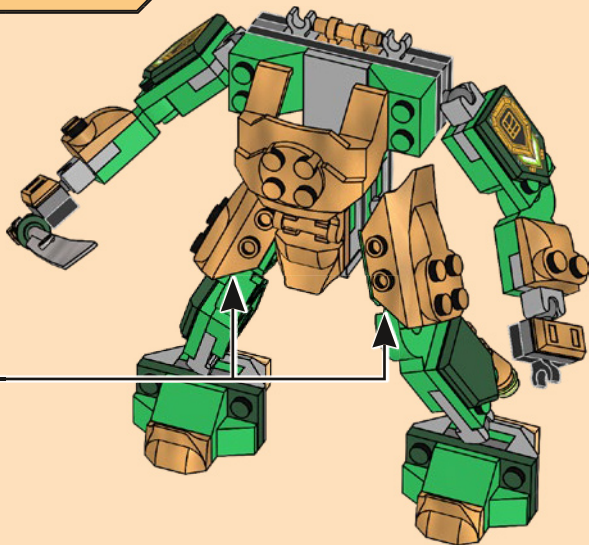
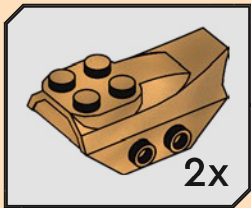



3

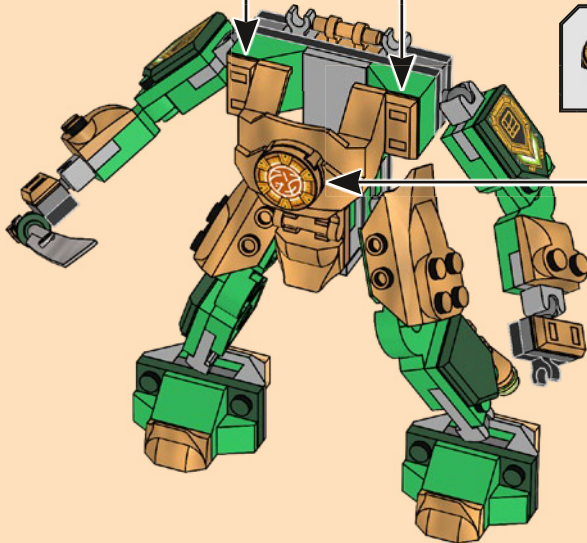

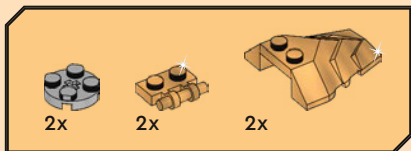

4

1



2



3

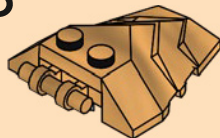

2x



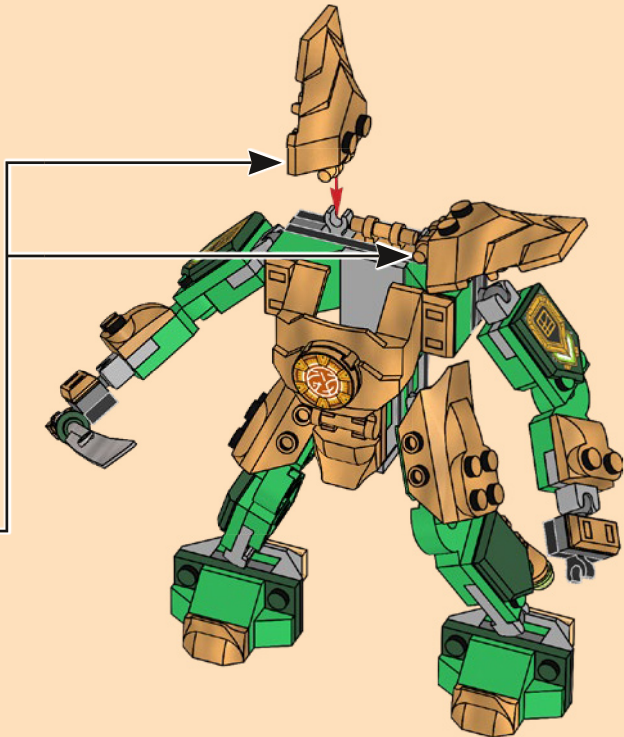

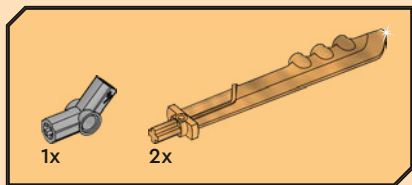

5

1



2

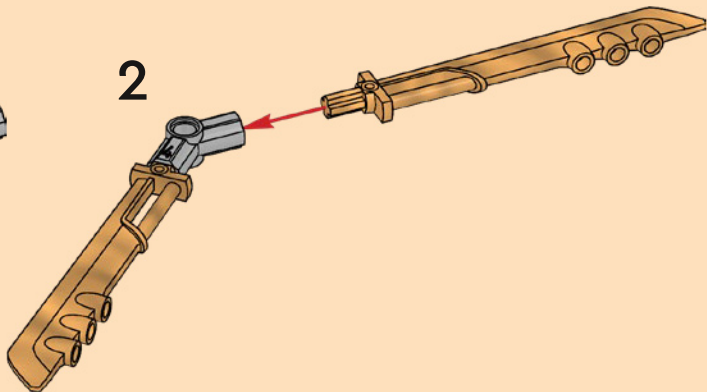

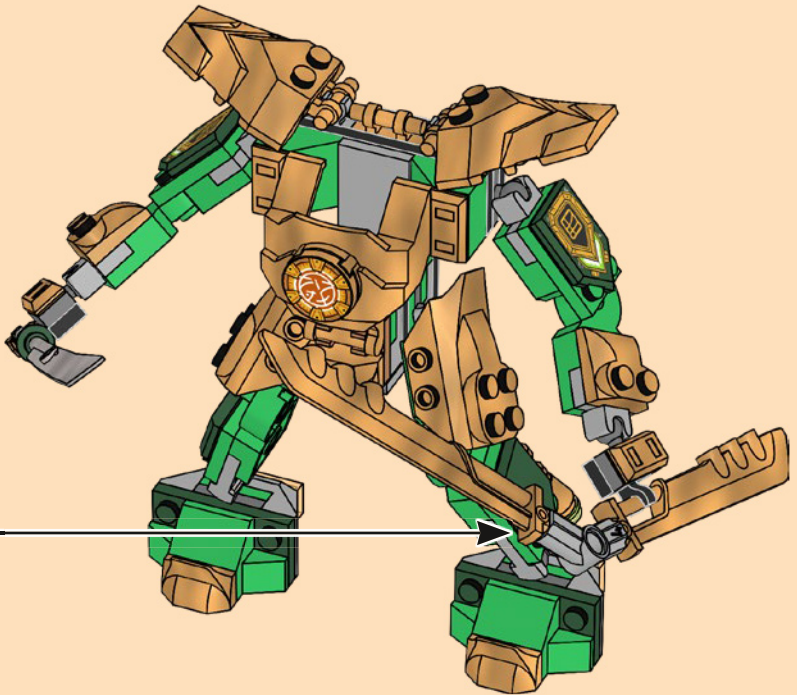



6

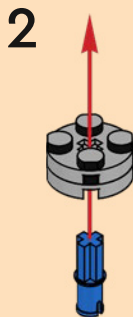
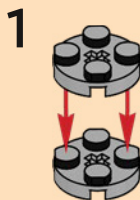

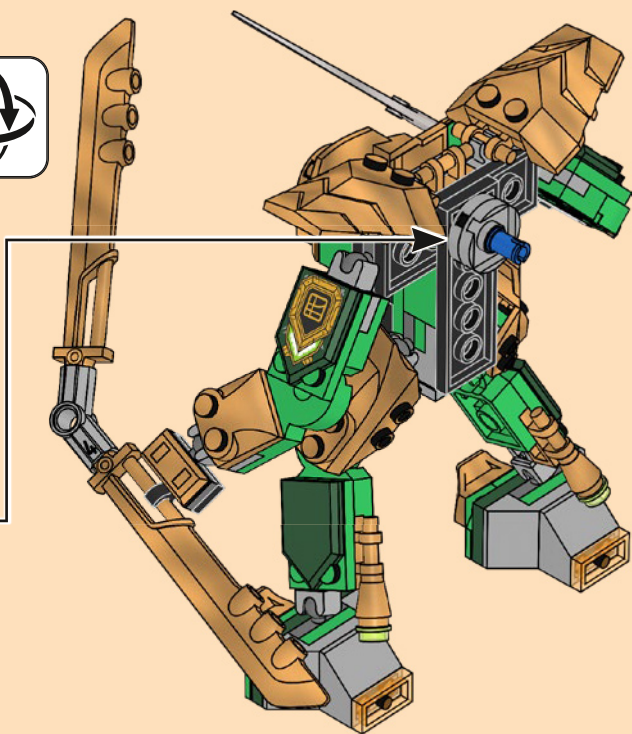

7

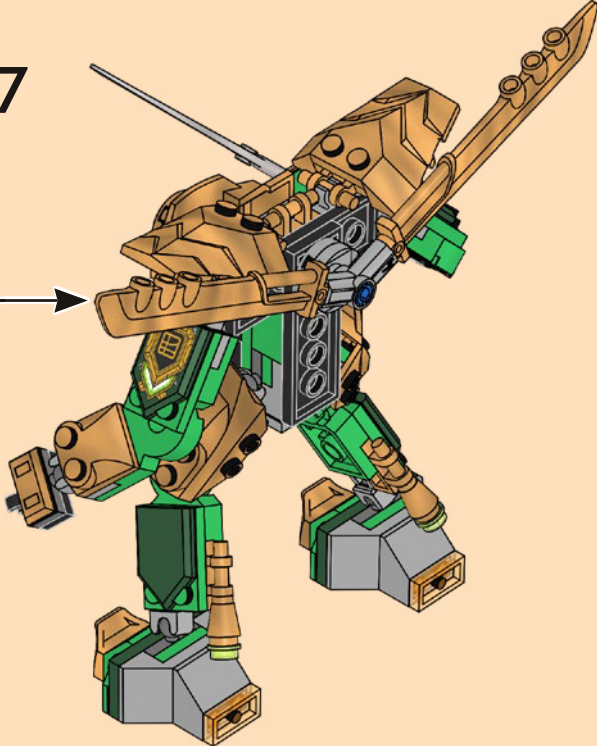
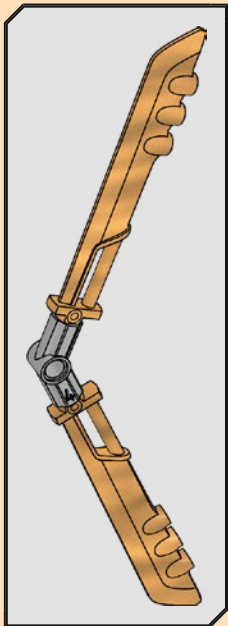





8

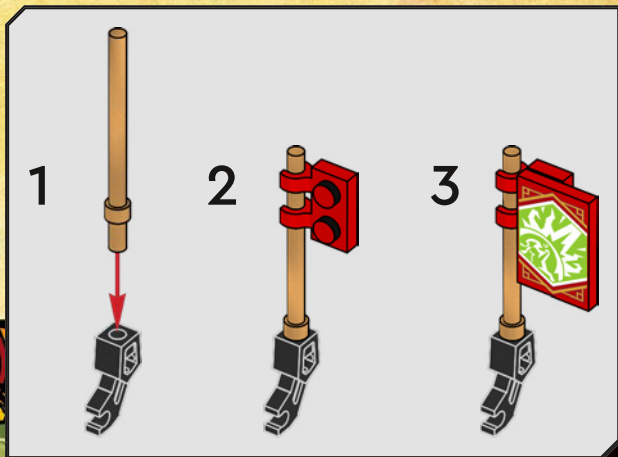



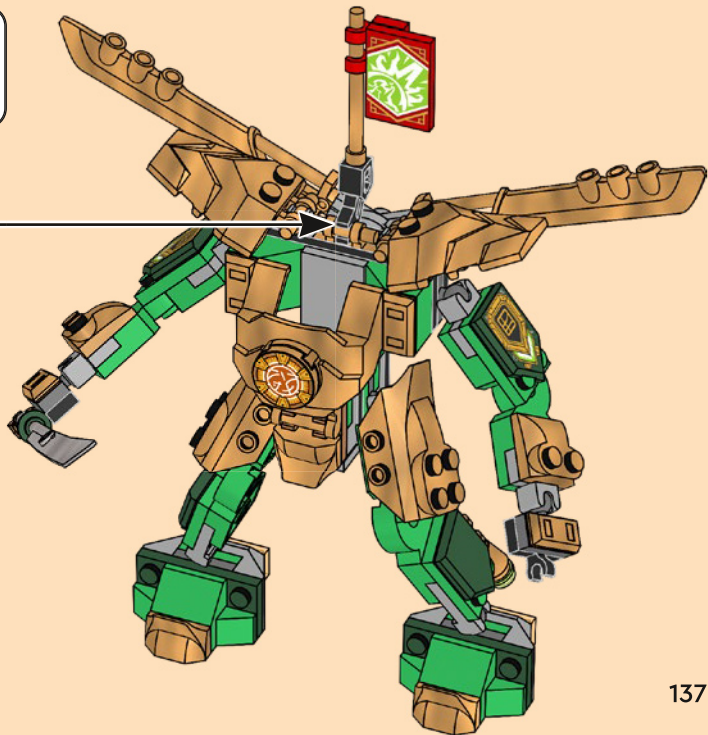



**LEGO**

# NINJAGO



**71785**



**71786**



**71787**



**71781**



**71782**



**71780**



**71784**



**71783**

# EXPLORE MORE!



Explore more / Mehr entdecken / En savoir plus / Esplora di più /  
Explora más / Explora mais / 探索更多 / Узнайте больше /  
Zobacz więcej / Objev více / Objav viac / Tudj meg többet! /  
Descoperă mai multe / Разгледайте още / Uzzini vairāk /  
Uuri lähemalt / Atrask daugiau



Flag illustrations: stockdevil - stock.adobe.com

Flag illustrations / Abgebildete Flaggen / Illustrations de drapeaux / Illustrazioni delle bandiere /  
Ilustraciones de banderas / Ilustrações de bandeiras / 旗帜插图 / Иллюстрации флагов /  
Ilustracje — flagi / Obrázky vlajek / Obrázky vlajek / Zászló illusztrációk / Ilustrații cu steaguri /  
Иллюстрации на знамена / Karogu attēli / Lippude pildid / Vėliavų iliustracijos

[Blue-Ocean-AG.com/LEGONinjagoMagazine](http://Blue-Ocean-AG.com/LEGONinjagoMagazine)



2x  
4518400



4x  
6046384



6x  
302321



2x  
6360036



4x  
6223427



4x  
4546705



2x  
6174937



2x  
6046381



1x  
6089698



3x  
4142865



6x  
302328



1x  
403201



1x  
306801



2x  
302221



1x  
6102138



4x  
303928



2x  
6276864



2x  
4515364



2x  
6170419



1x  
6421043



1x  
6230571



1x  
300328



2x  
6210076



2x  
6347309



1x  
6009016



2x  
302021



2x  
6421048



7x  
302128



2x  
6347309



2x  
6249091



4x  
6375427



2x  
6285134



4x  
6372712



1x  
6417344



2x  
4586057



1x  
6331084



1x  
6421033



1x  
6406666



2x  
6280097



1x  
6421035



1x  
6276867



5x  
6313116



4x  
6176768



2x  
6425507



1x  
302226



2x  
6052126



1x  
6424325



2x  
6168620



1x  
302126



2x  
4188534



2x  
6296894



4x  
4211475



1x  
4206482



1x  
6191962



1x  
6058341



6x  
379526



12x  
6043656



1x  
6326478



2x  
6435857



2x  
6043639



2x  
4654577



3x  
6171894



1x  
6262905



2x  
4211517



12x  
6039479



2x  
6123814



4x  
4211094



1x  
4210997



2x  
6347304



2x  
6240217



2x  
6240206



1x  
6224825



2x  
4529247



1x  
6424355



1x  
6341738



1x  
6421032



4x  
6207933



3x  
6375715



5x  
6279731



2x  
4286597



1x  
6424356



1x  
6116596



2x  
6376233



2x  
6371694



1x  
6371693



1x  
6170470



2x  
6330240



1x  
6378729



5x  
6167034



9x  
6208447



1x  
6248797



[LEGO.com/service](https://www.LEGO.com/service)

YOU COULD

WIN



Scan this QR code or go to  
**LEGO.COM/PRODUCTFEEDBACK** and give us  
your short feedback about this LEGO® set  
for a chance to win a cool LEGO prize.

Terms and Conditions apply\*

**DE: Du könntest GEWINNEN.** Es gelten die Teilnahmebedingungen\* **FR: Tu pourrais GAGNER.** Des conditions s'appliquent\* **IT: Potresti VINCERE tu.** Termini e condizioni sono applicabili\* **ES: Puedes GANAR.** Aplican términos y condiciones\* **PT: Poderá GANHAR.** Aplicam-se termos e condições\* **JA: プレゼント付き! 利用規約が適用されます\*** **ZH: 轻松获奖. 条款和条件适用\*** **KO: 상품의 주인이 되어보세요. 소정의 약관이 적용됩니다\*** **RU: Вы можете ВЫИГРАТЬ.** Действуют положения и условия\* **PL: Szansa na WYGRANĄ.** Obowiązują warunki korzystania\* **CS: Máte šanci VYHRÁT.** Platí všeobecné smluvní podmínky\* **SK: Máte šancu VYHRATĚ.** Platia všeobecné zmluvné podmienky\* **HU: TE IS NYERHETSZ.** Felhasználási feltételek érvényesek\* **RO: Ai putea CÂȘTIGA.** Se aplică termenii și condiții\* **BG: Можете да СПЕЧЕЛИТЕ.** Има определени правила и условия\* **LV: Tu vari LAIMĒT.** Ir spēkā noteikumi un nosacījumi.\* **ET: Sul on võimalus VÕITA.** Kehtivad tingimused\* **LT: Jūs galite LAIMĖTI.** Taikomos sąlygos\*

\*[LEGO.com/productfeedback-terms](https://www.lego.com/productfeedback-terms)