

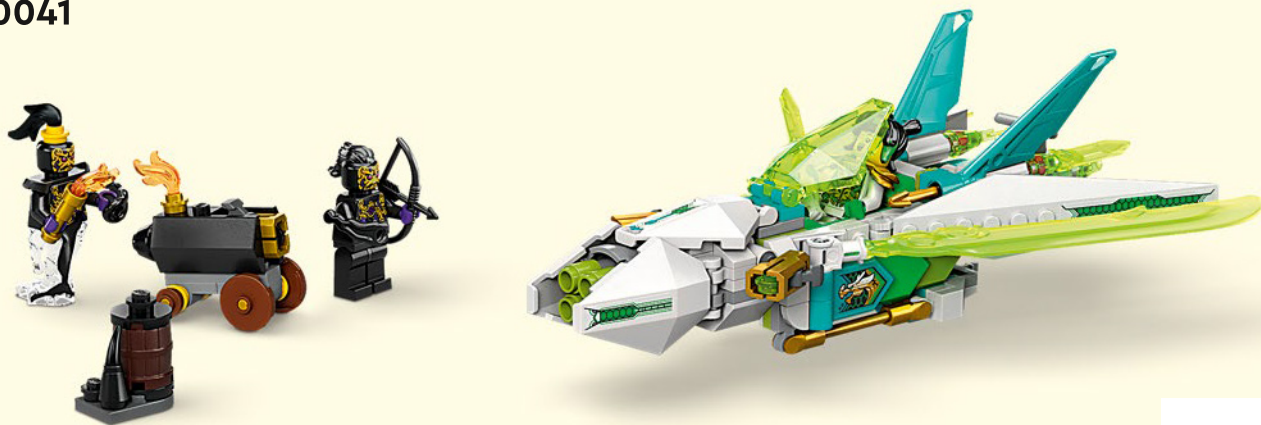

MONKIE KID 悟空小侠

80041





FR
DONNEZ
OU
RECYCLEZ

 OU  OU 

ASSOCIATION MAGASIN DÉCHÈTERIE

Adresses sur quefairedemesdechets.fr



LEGO.com/sustainable-packaging



BUILDER



Apple and the Apple logo are trademarks of Apple Inc., registered in the U.S. and other countries and regions. App Store is a service mark of Apple Inc. Google Play and the Google Play logo are trademarks of Google LLC. Tencent and the Tencent logo are trademarks of Tencent Inc.

Q [LEGO.com/devicecheck](https://www.lego.com/devicecheck)

EN Ask parents' permission before going online | **DE** Eltern um Erlaubnis bitten, bevor du online gehst | **FR** Demande l'autorisation d'un parent avant d'aller en ligne | **IT** Chiedi il permesso ai tuoi genitori prima di andare online | **ES** Pídeles permiso a tus papás antes de conectarte a Internet | **PT** Pede autorização aos pais antes de acederes online | **JA** オンラインになる前に ほか者の方のきよかをもらおう | **ZH** 上网前应先征得父母的同意 | **KO** 온라인 접속 전에 보호자 동의가 필요합니다 | **RU** Спроси разрешения у родителей, прежде чем заходить в интернет | **PL** Poproś rodziców o zgodę, zanim wejdziesz do Internetu | **CS** Než půjdeš na internet, požádej rodiče o svolení | **SK** Skôr než pôjdeš na internet, vypýtaj si povolenie od rodičov | **HU** Kérj szülői engedélyt, mielőtt online csatlakoznál! | **RO** Cere permisiunea părinților înainte de a te conecta online | **BG** Поискайте разрешение от родител, преди да влезете онлайн | **LV** Pirms došanās tiešsaistē palūdz atļauju vecākiem | **ET** Enne Interneti kasutamist küsi vanematelt luba | **LT** Prieš prisijungdami prie interneto, atsklauskite tėvų

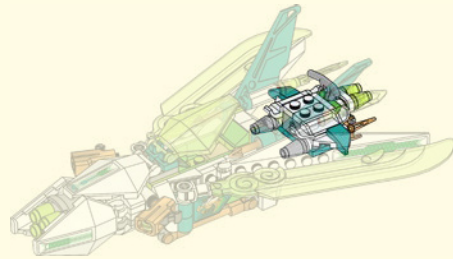

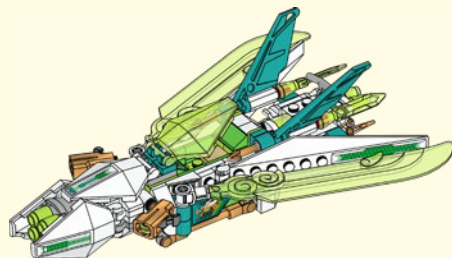
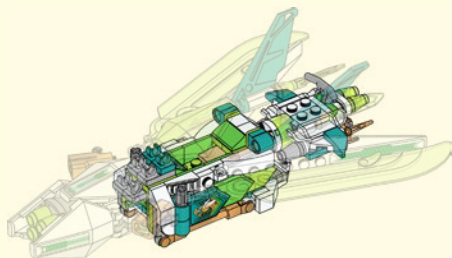

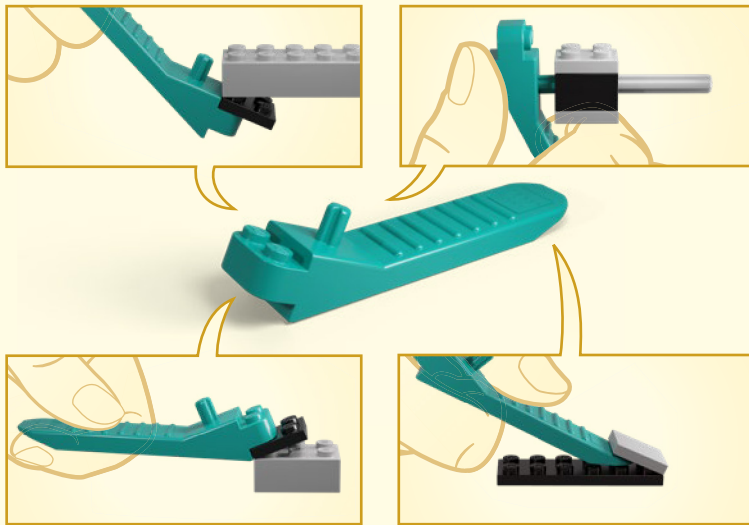

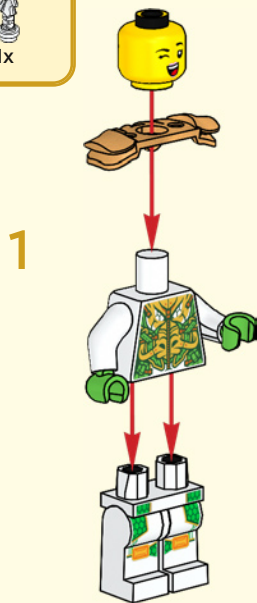
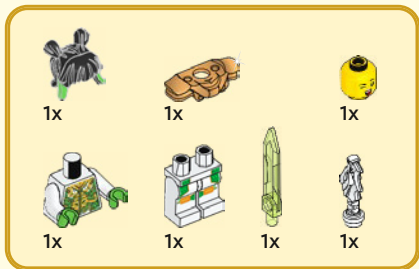

2

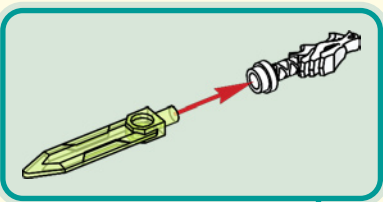

3





1

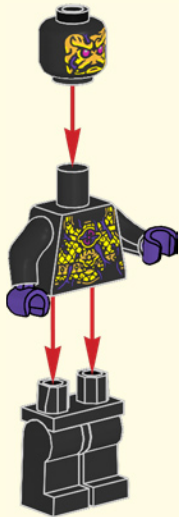

2



3



4

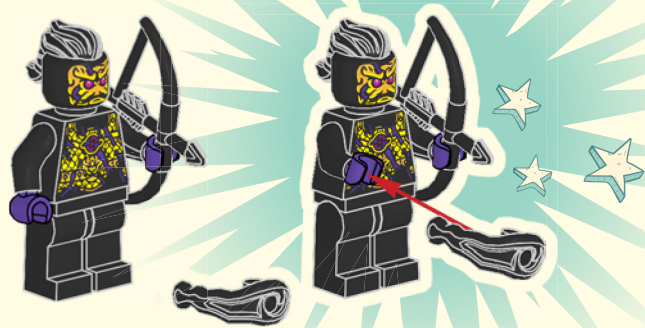
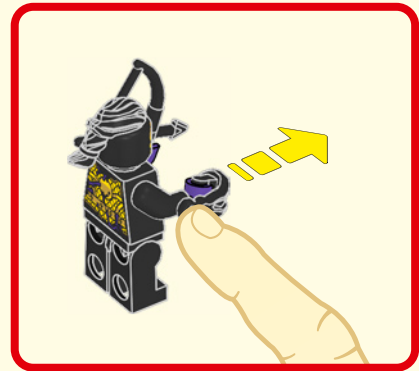

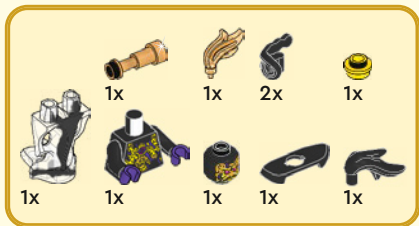

1

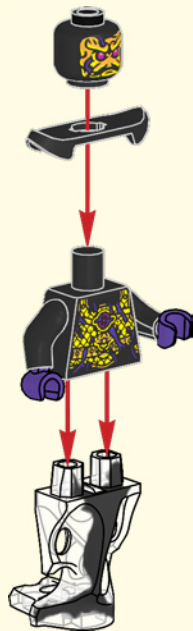

2



3

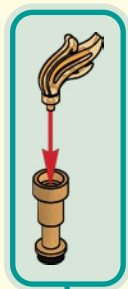



4





1

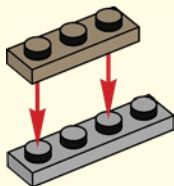

2

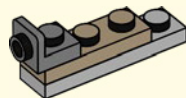



3

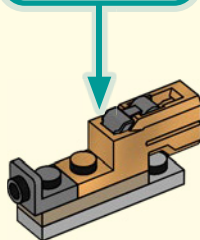
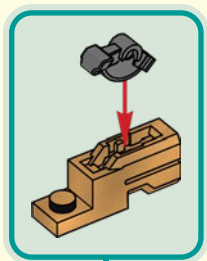

4

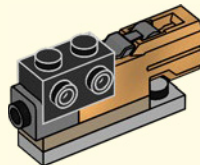



1x

5

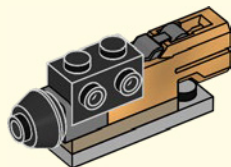

2x

6

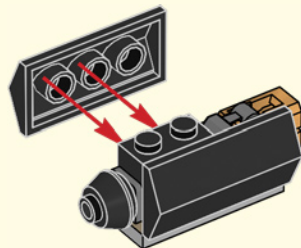



7

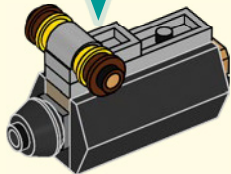
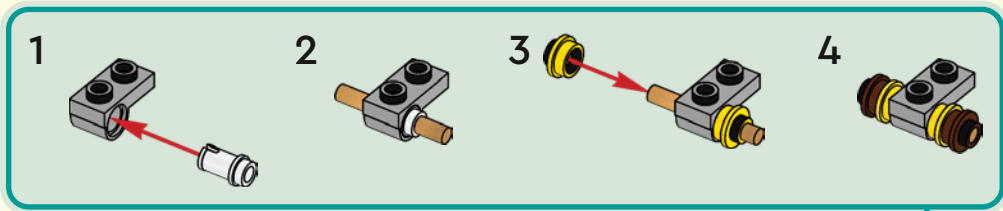



8

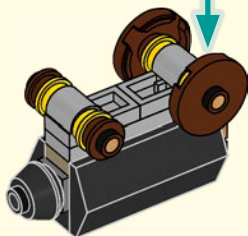
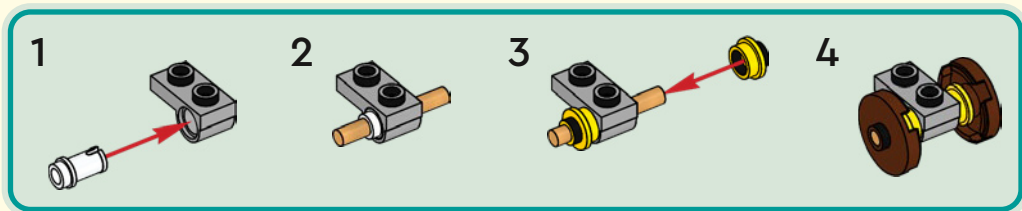



1x

9

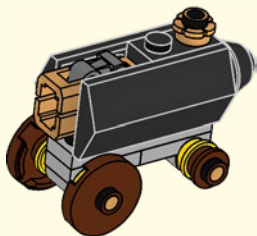

1x

10

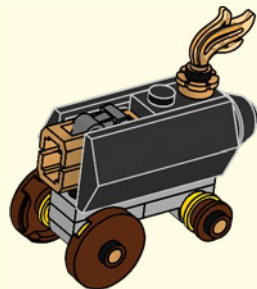

3x

11

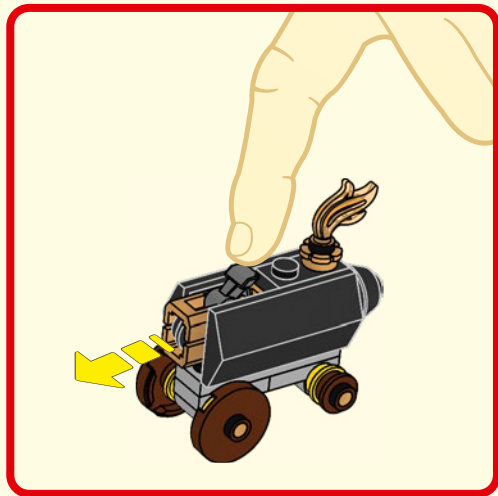
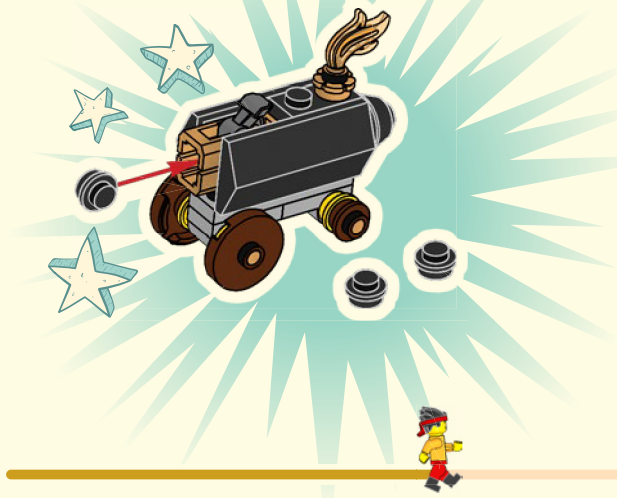



1x



1x

1

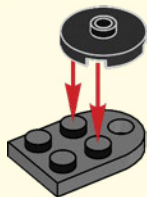

1x

2





1x



1x

3





4



5

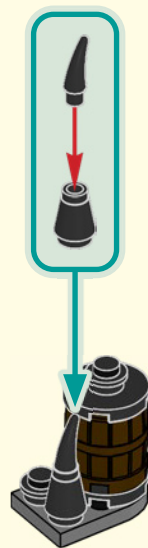



1x



1x

1

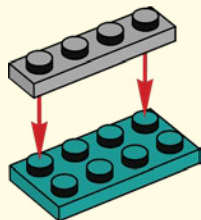

2x

2

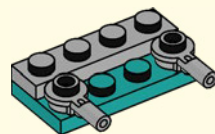



2x



1x

3

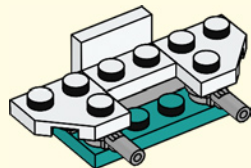

1x



1x

4

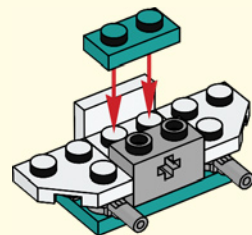



2x



2x

5

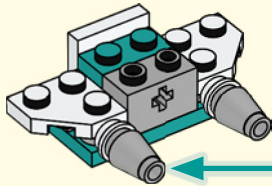
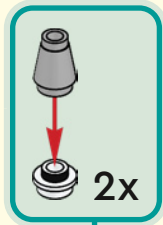

2x



1x

6

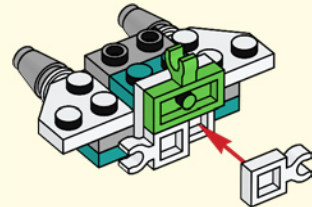



2x

7

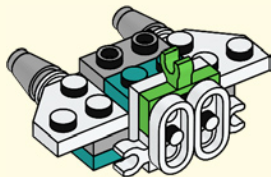

2x

8

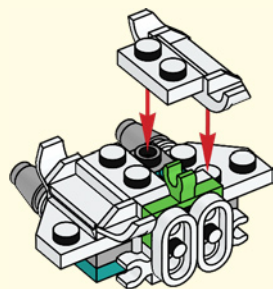



1x



1x

9

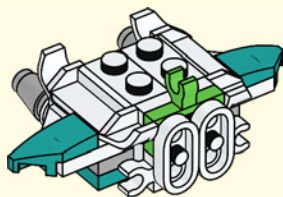

1x

10

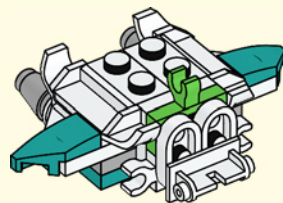



1x



2x



2x

11

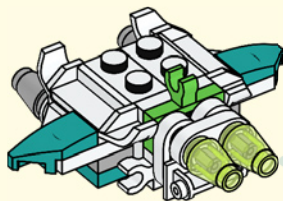
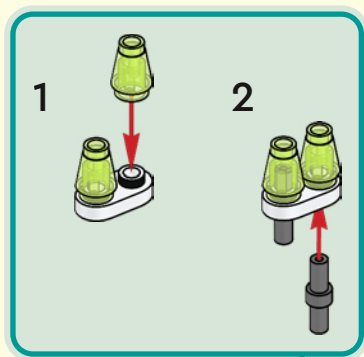

1x



2x

12



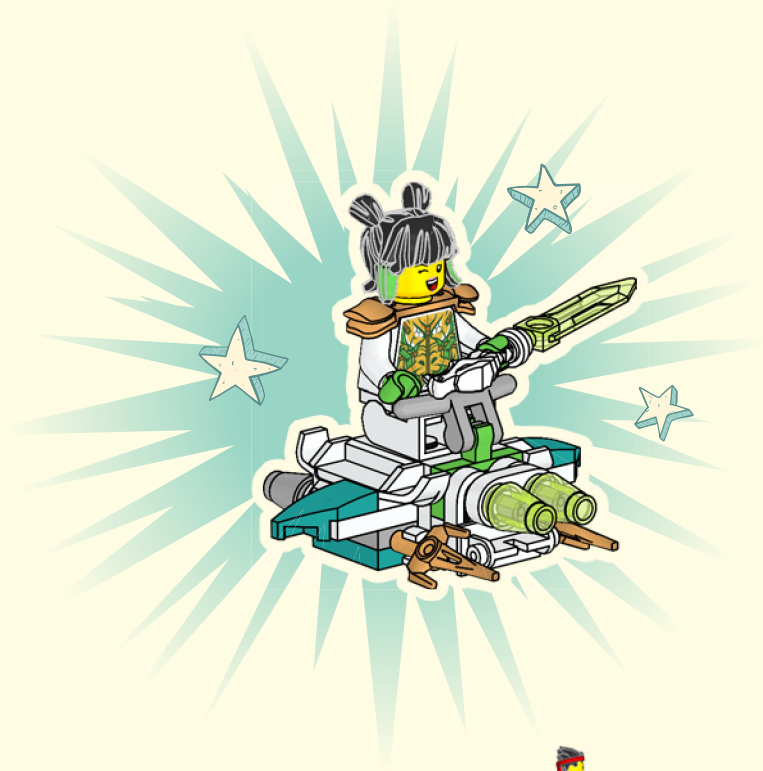

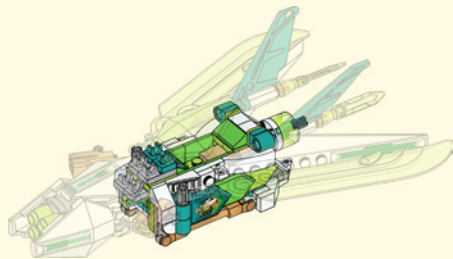

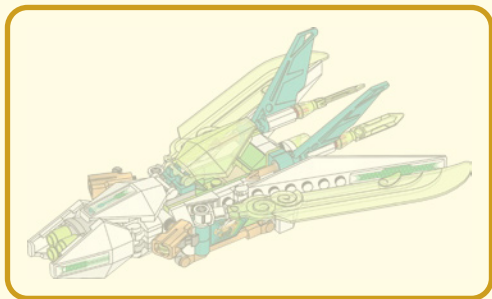

1

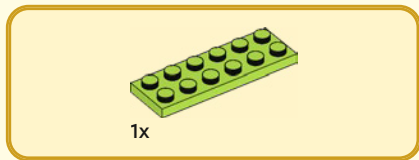
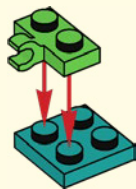

2

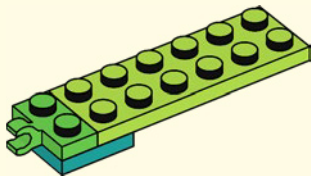



1x

3

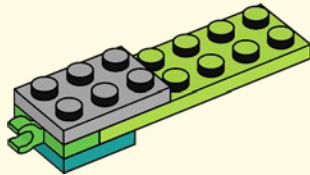

1x

4

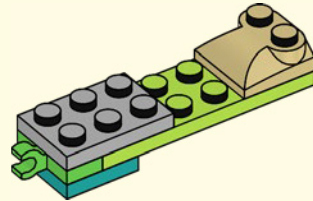



1x



1x

5

1

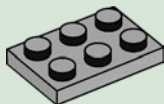

2

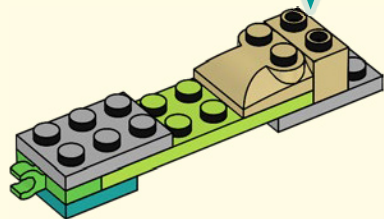
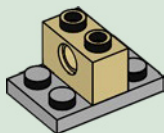

2x

6

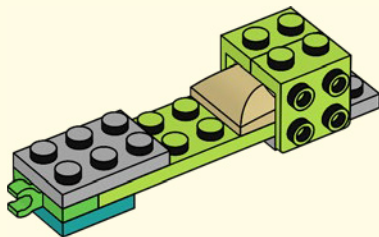



1x



2x

7

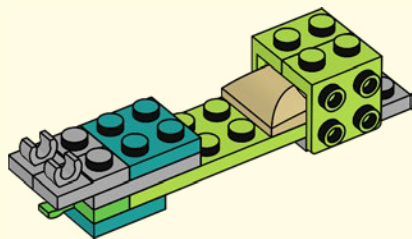

1x

8



1



2

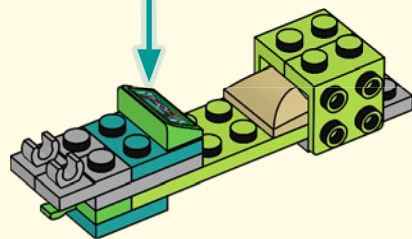



2x

9

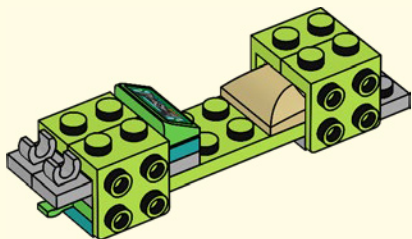

2x

10

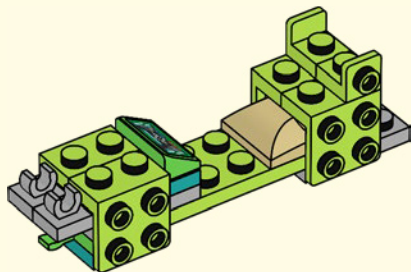

11

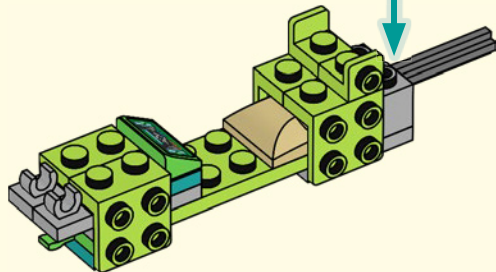
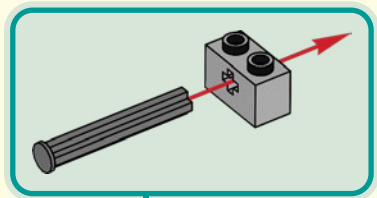
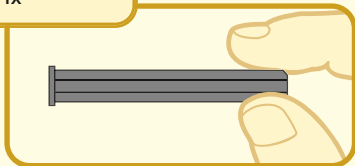
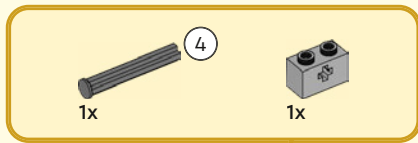



2x

12

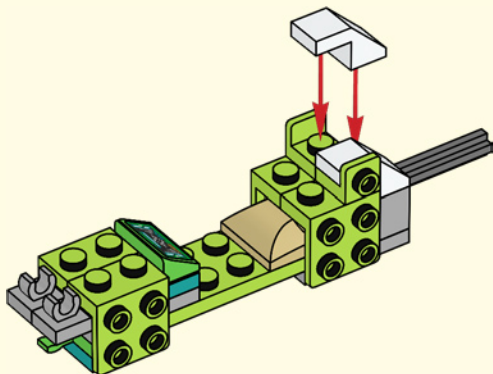

1x



1x

13

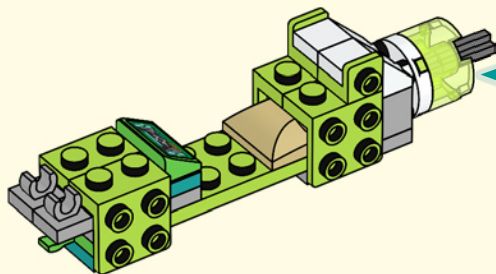



2x

14

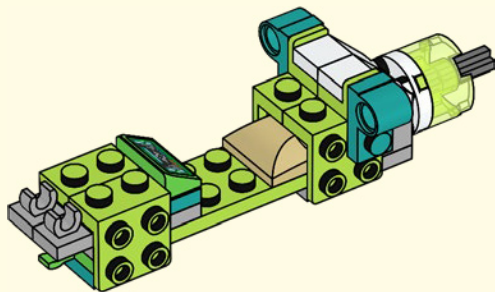

2x



2x

15

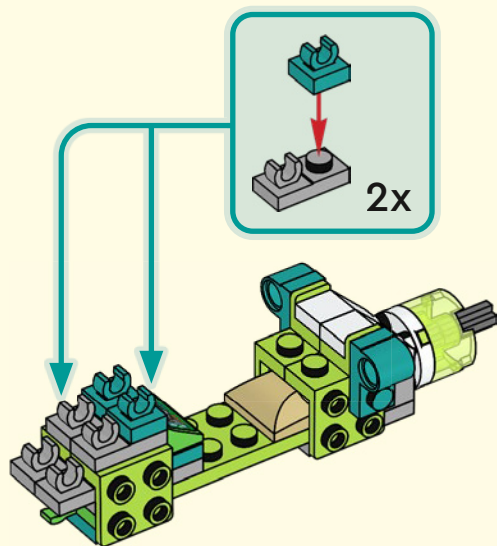



1x

16

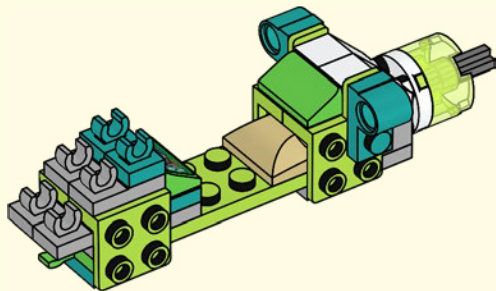



4x

17

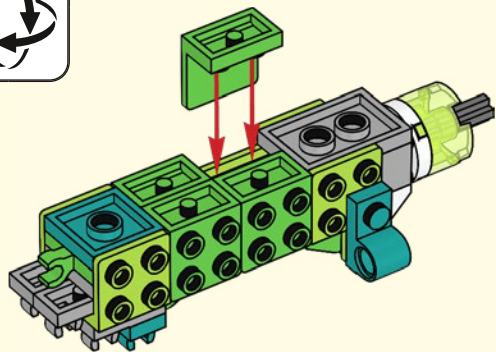

1x



1x



1x

18

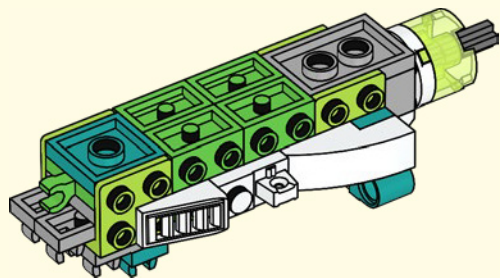



1x



1x

19

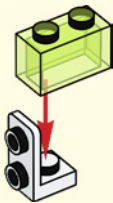

1x

20





1x

21



1x

22





2x

23

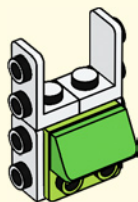

1x

24

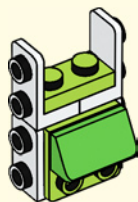



2x

25



1x



1x

26

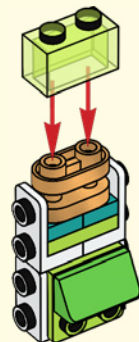



2x

27

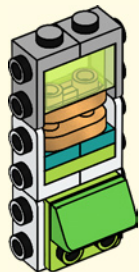

2x

28





1x

29

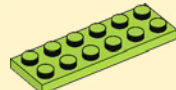
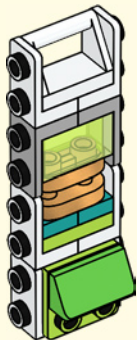

1x

30

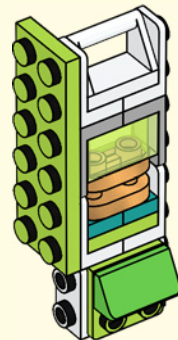

31

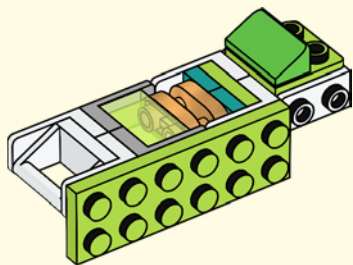

32





1x

33

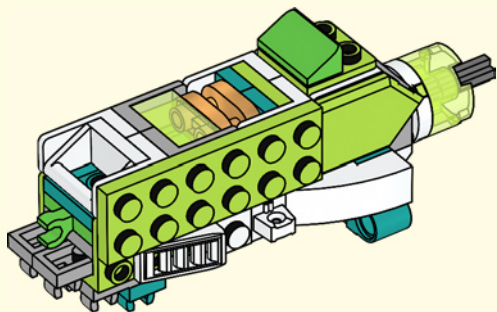

1x



1x



2x



1x

34

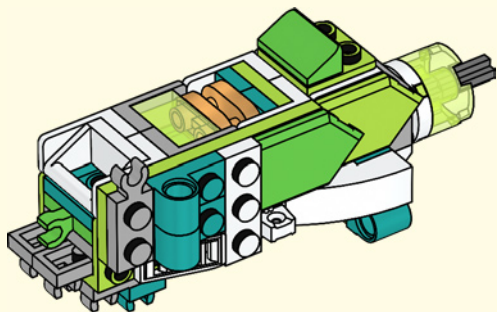



1x



1x

35

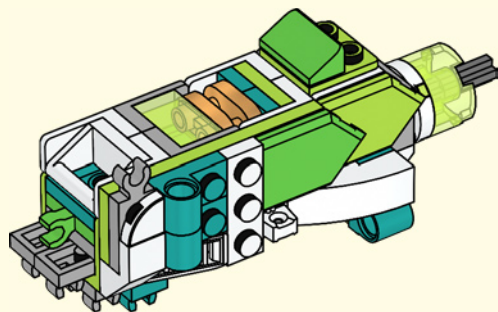

1x

36

1



2



4

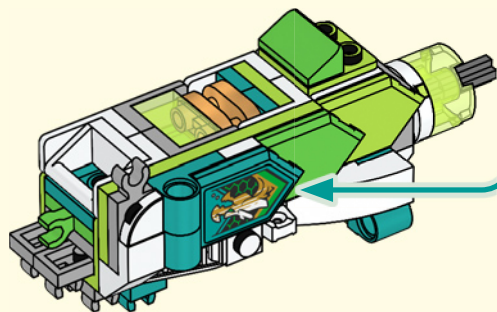



1x



1x



1x

37

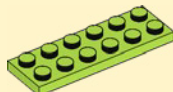
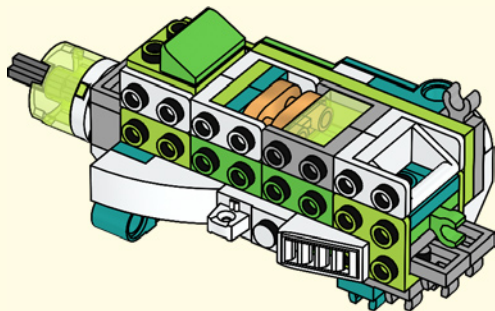

1x



1x

38

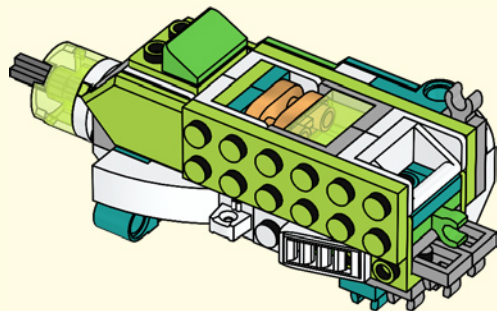

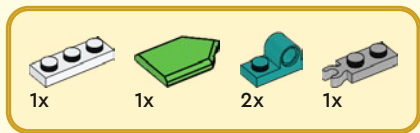

39

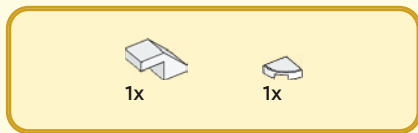
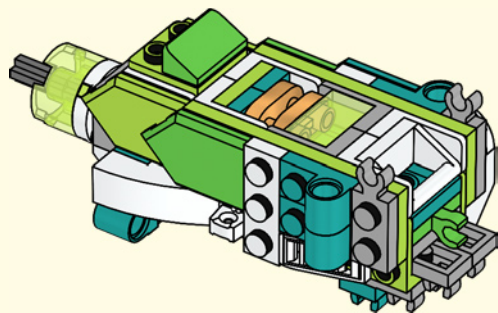

40

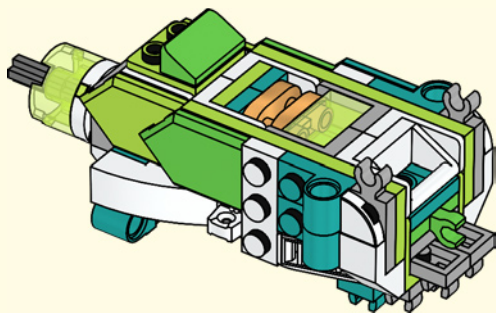



41

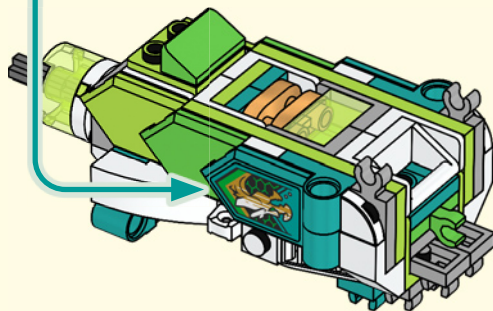
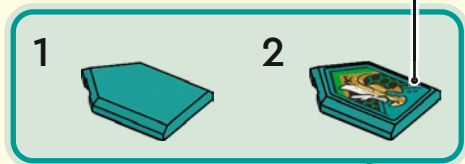

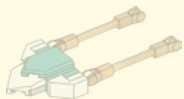

1x



1x

42



2x

43



2x

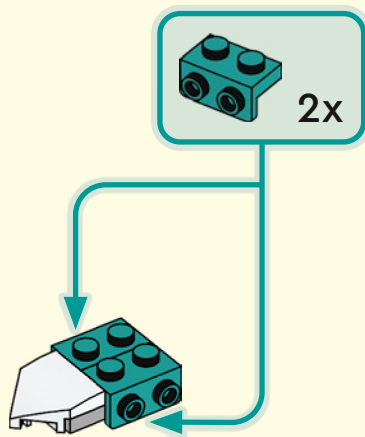



1x

44

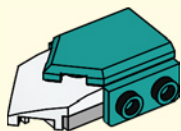

2x



2x



2x

45

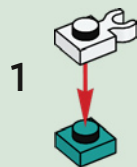

1

2



2x

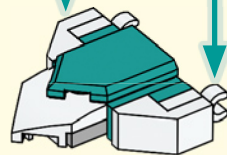



46

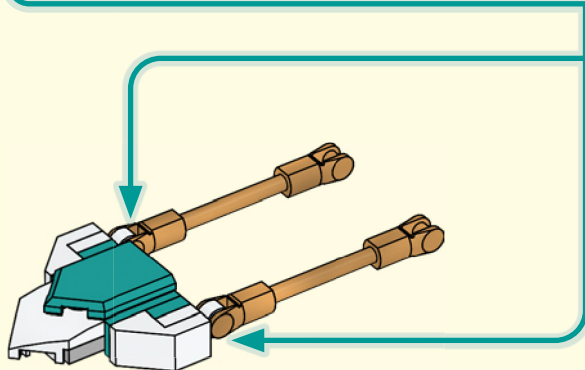
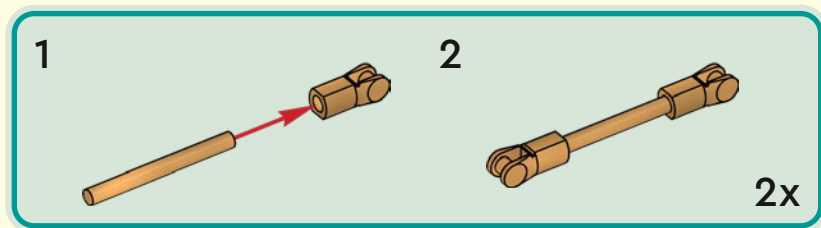

47

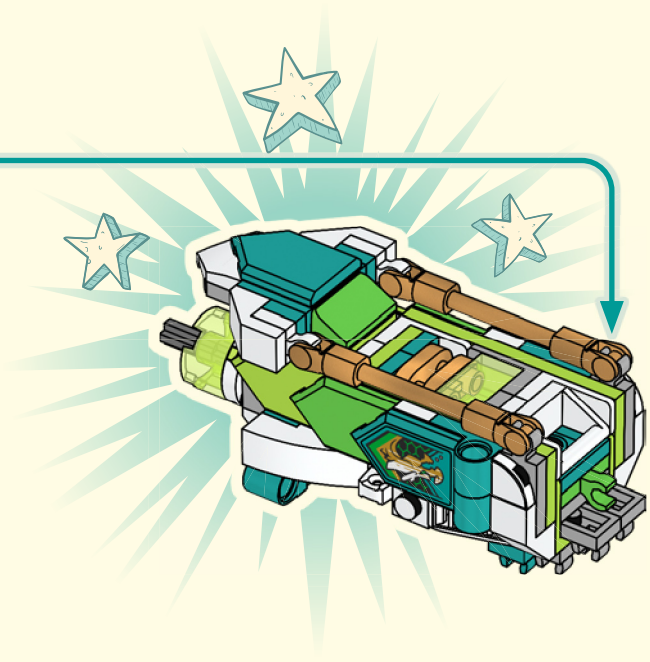



2x

48

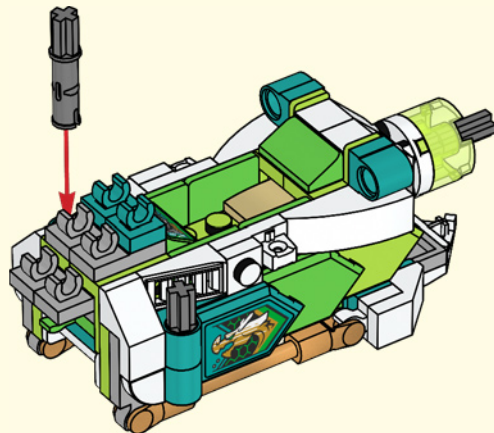



1x

49

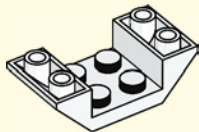

2x

50

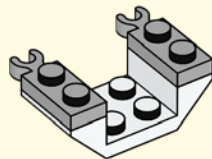



2x

51

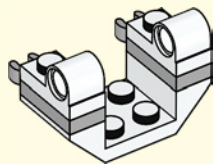

2x

52

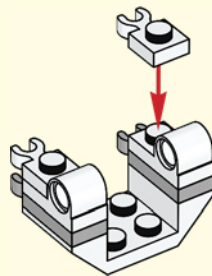

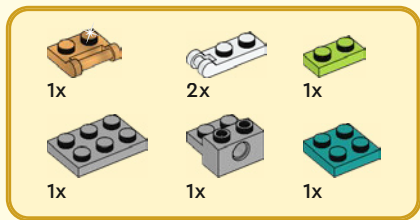

53

1

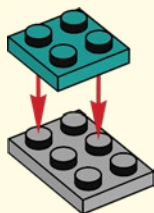

2

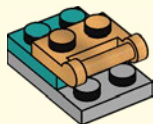

3

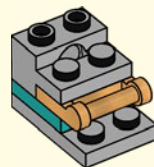

4

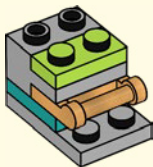

5

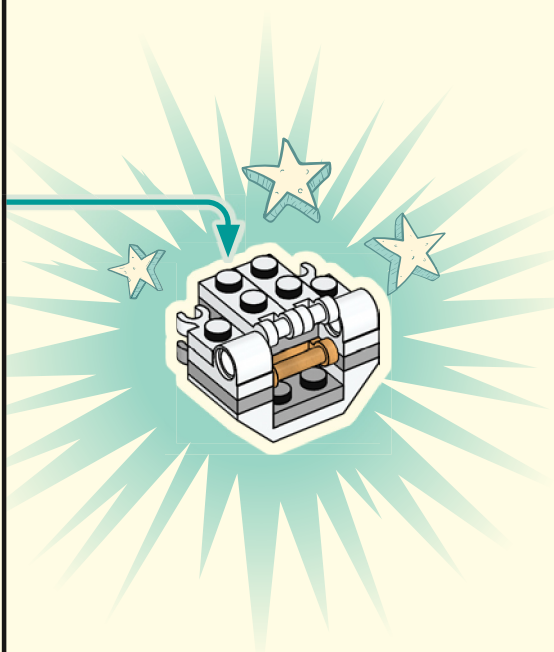
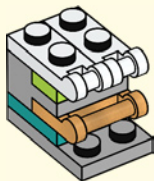



54

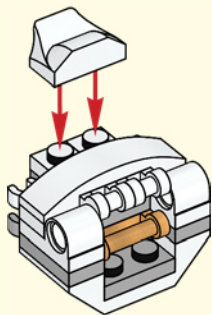

55

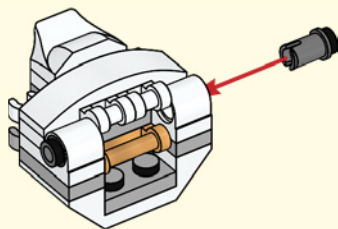

56

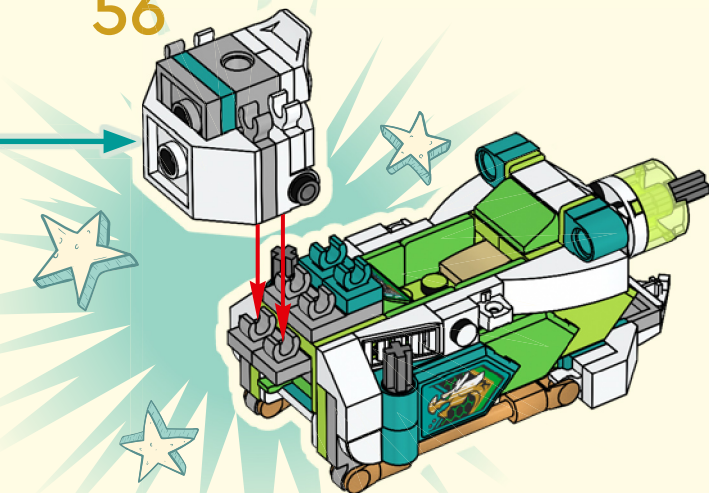

57

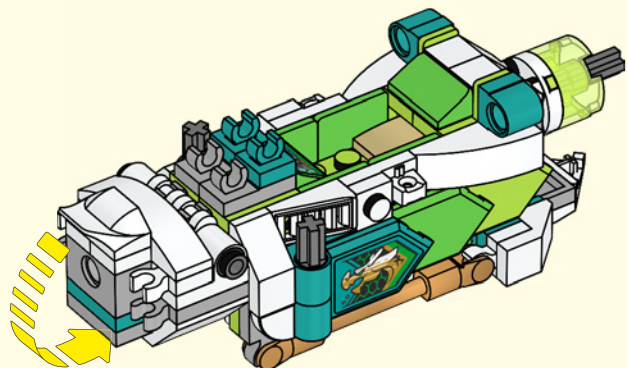

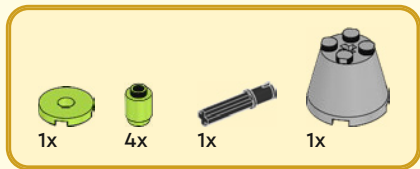

58

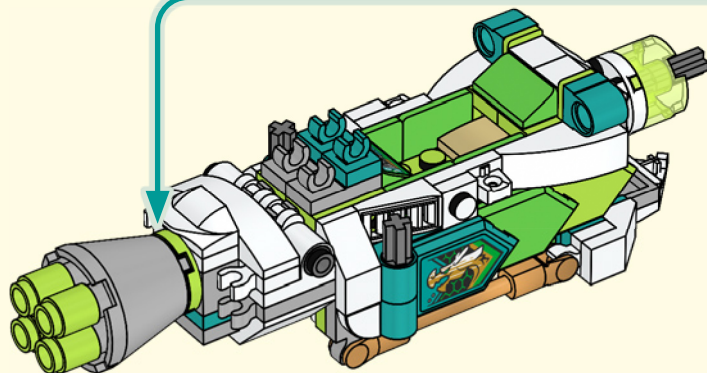
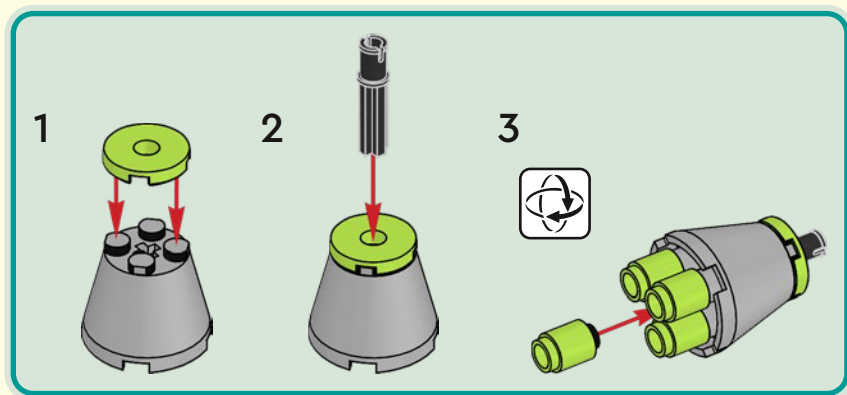

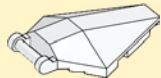

2x

59



1

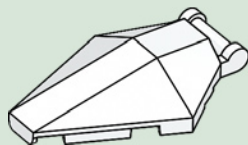

2

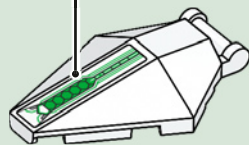

2x

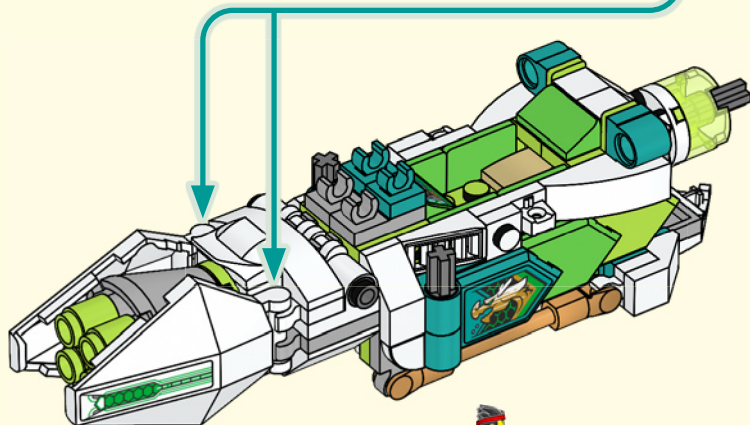

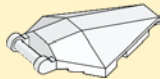

1x

60



1



2

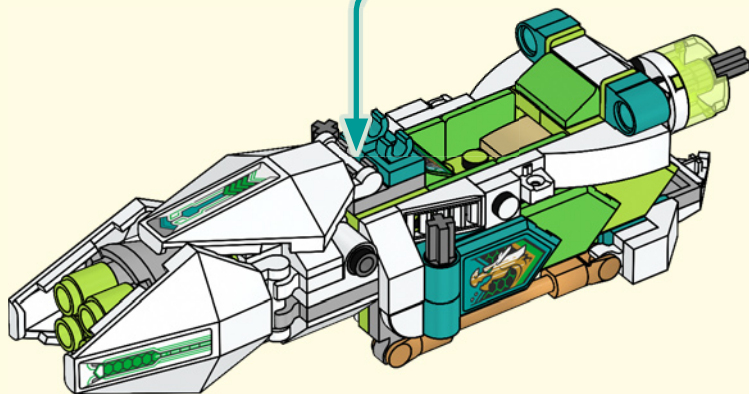
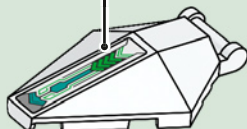



2x



2x



2x



2x



2x



2x

61

1

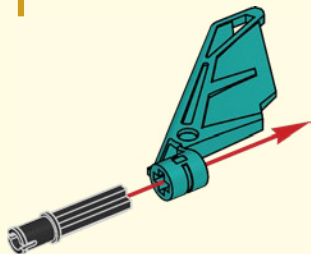

2

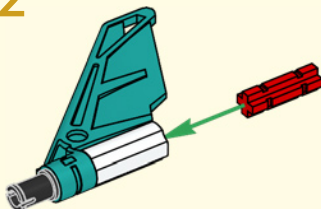

3

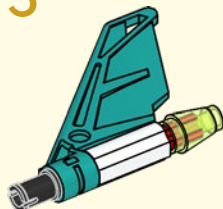

2x



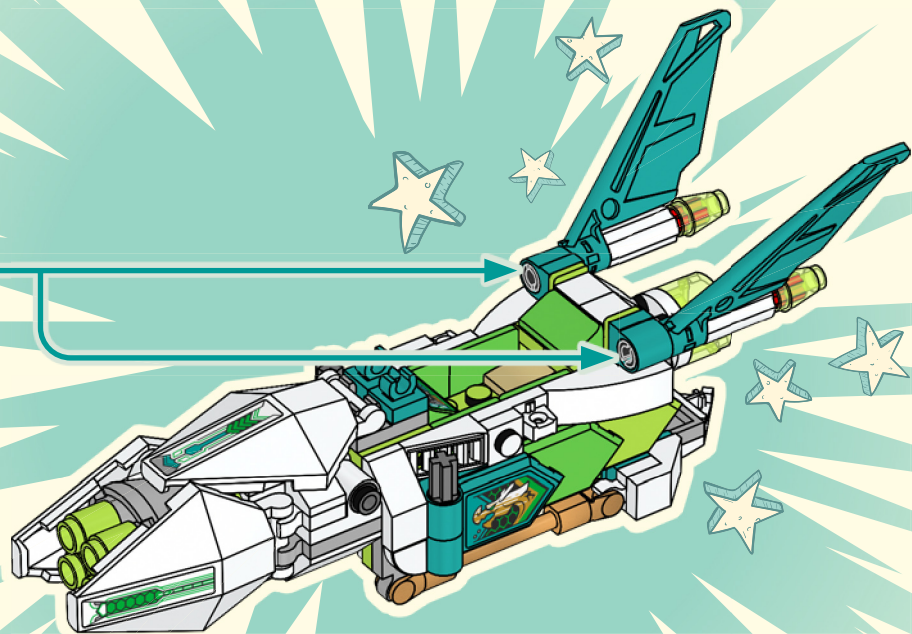



2x



2x

62

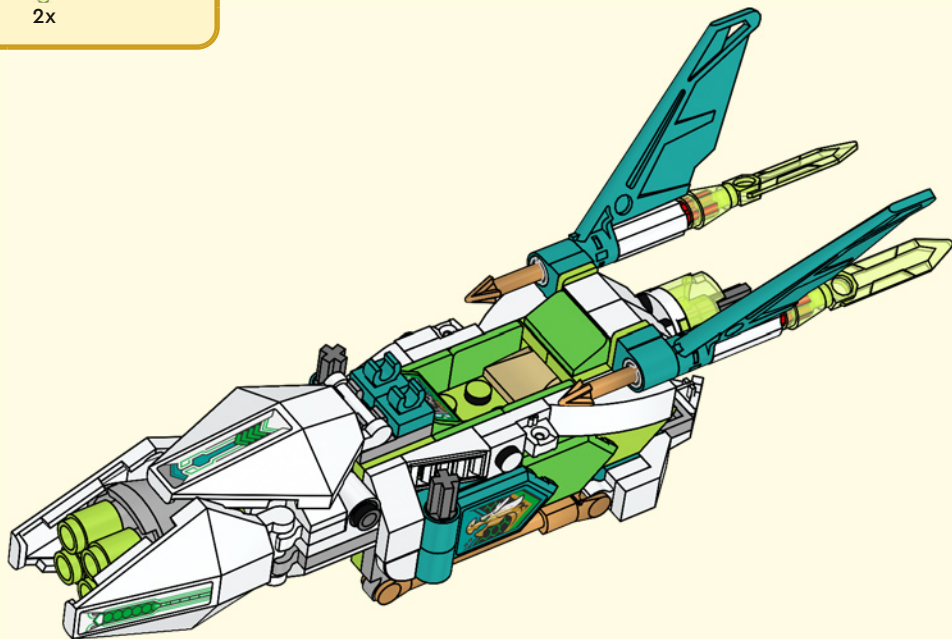

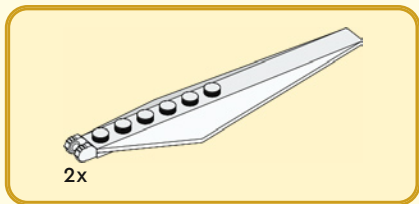
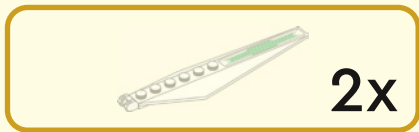

63

1

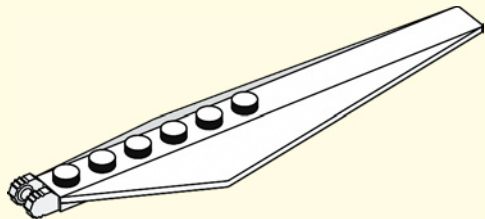

2

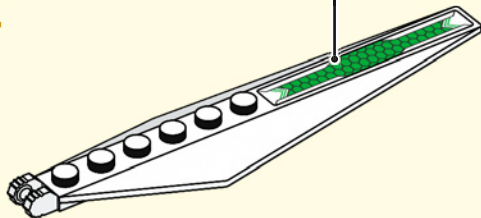

2x

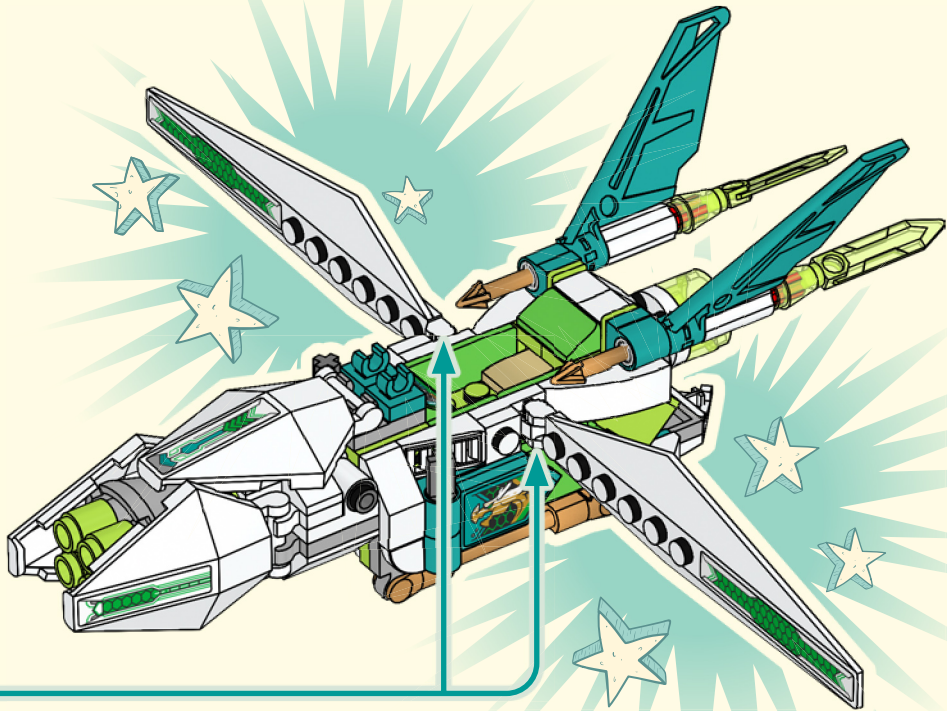

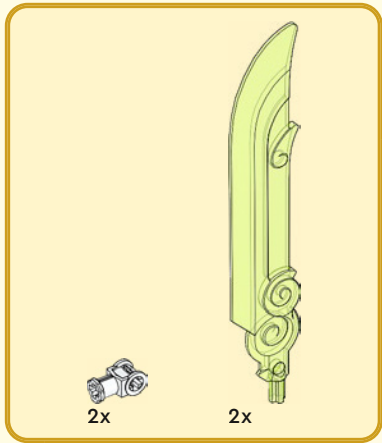

64

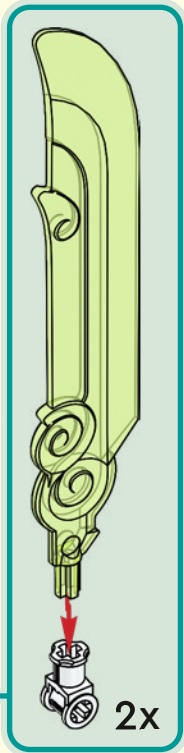
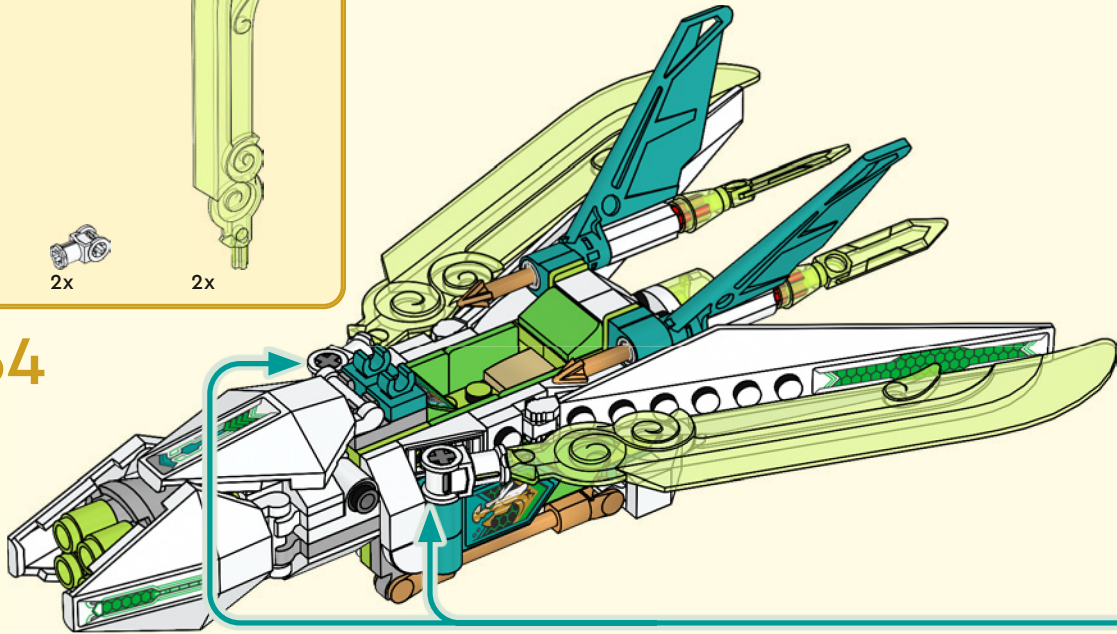

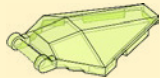

1x

65

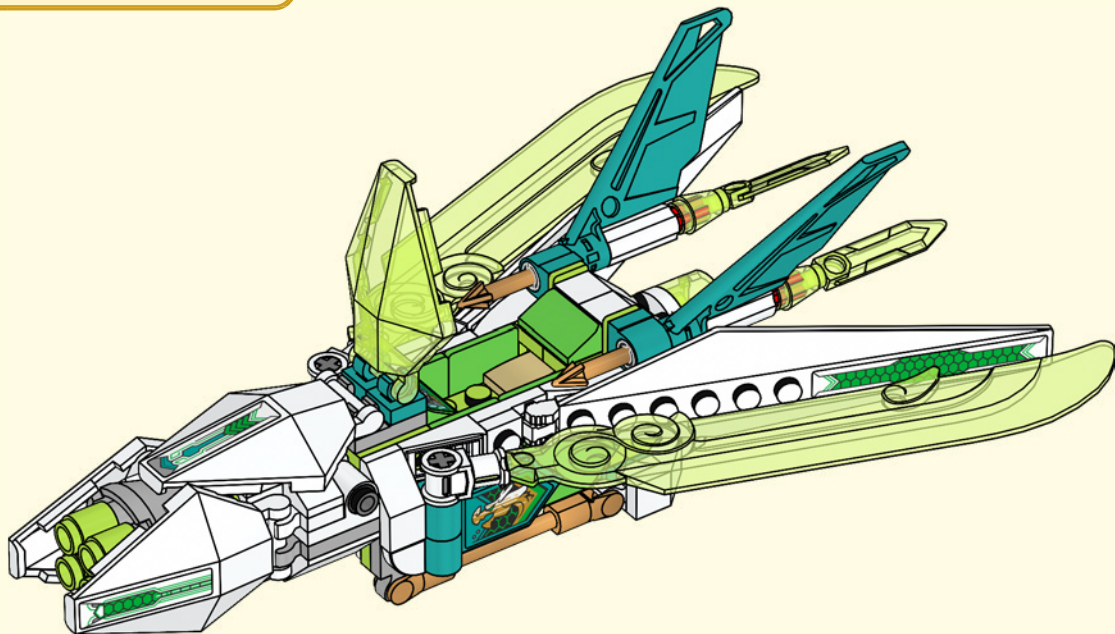



66

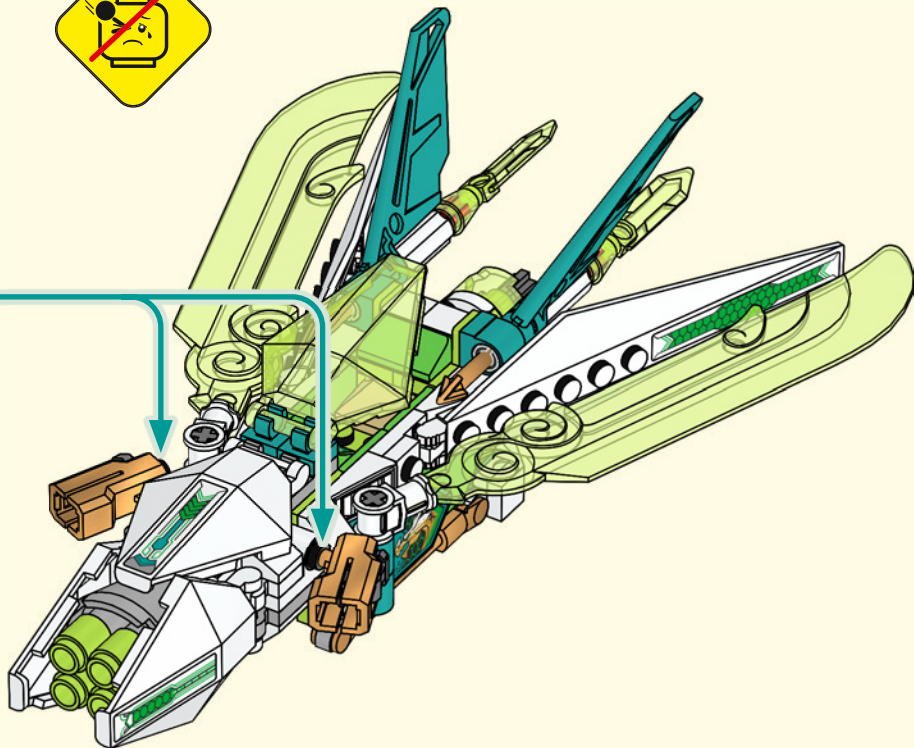
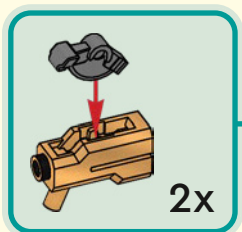

4x

67

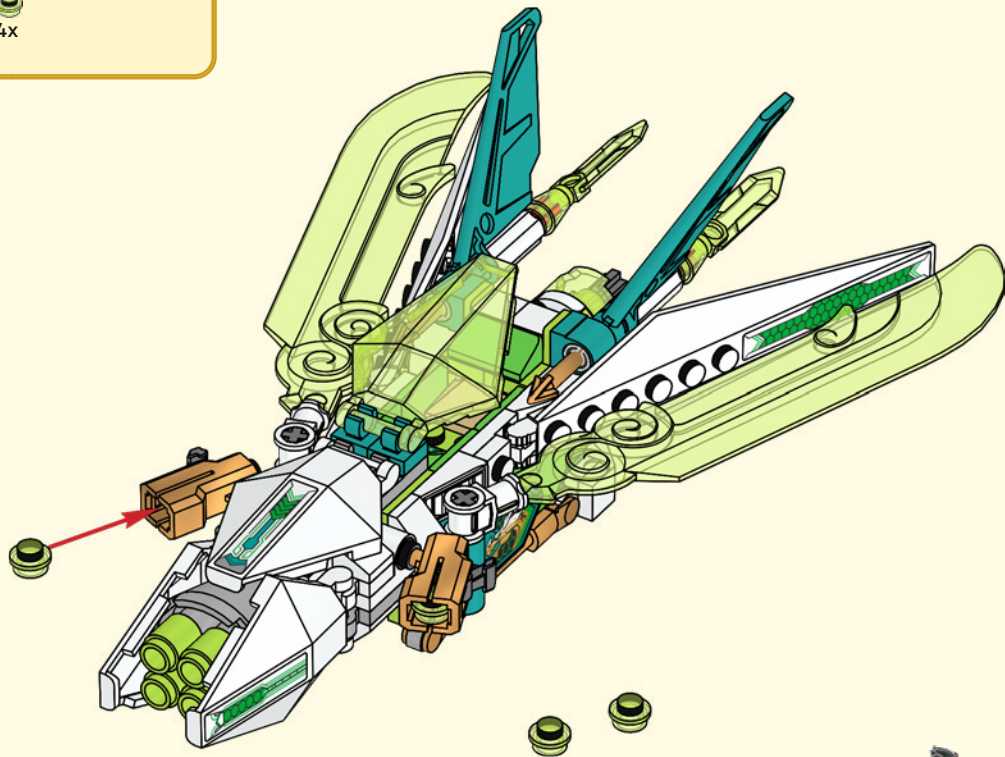

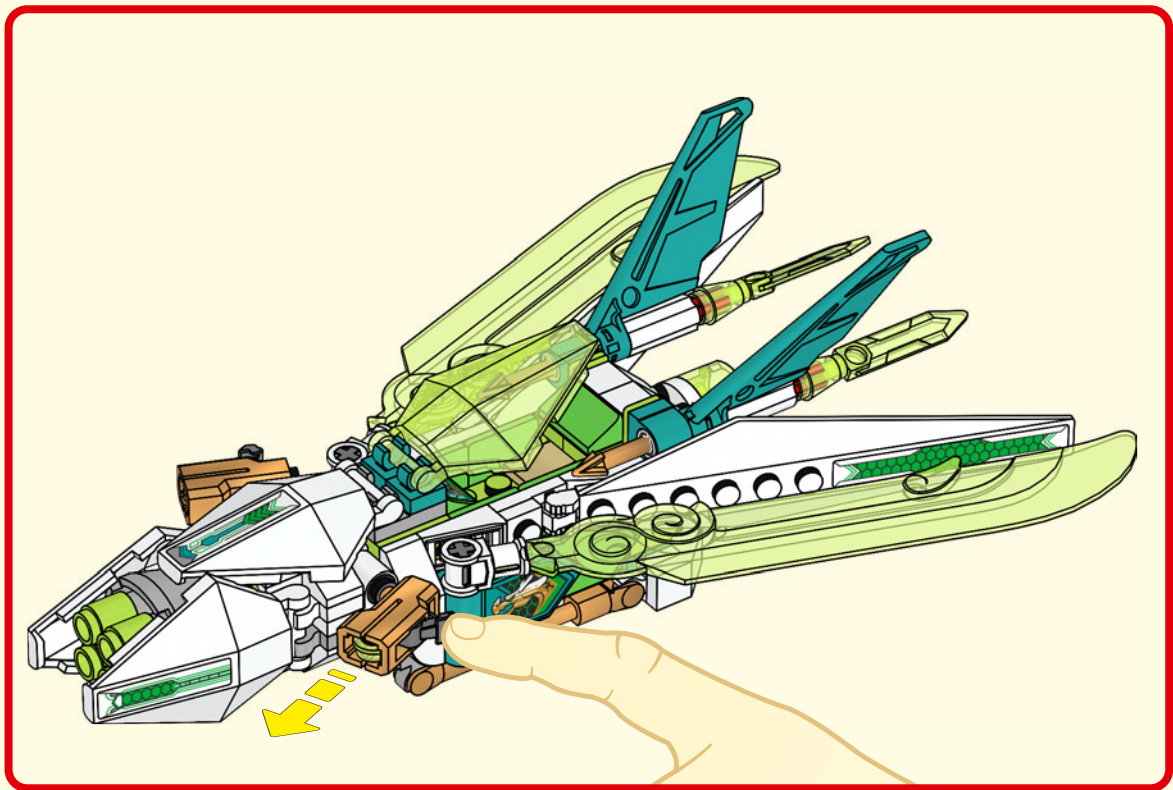

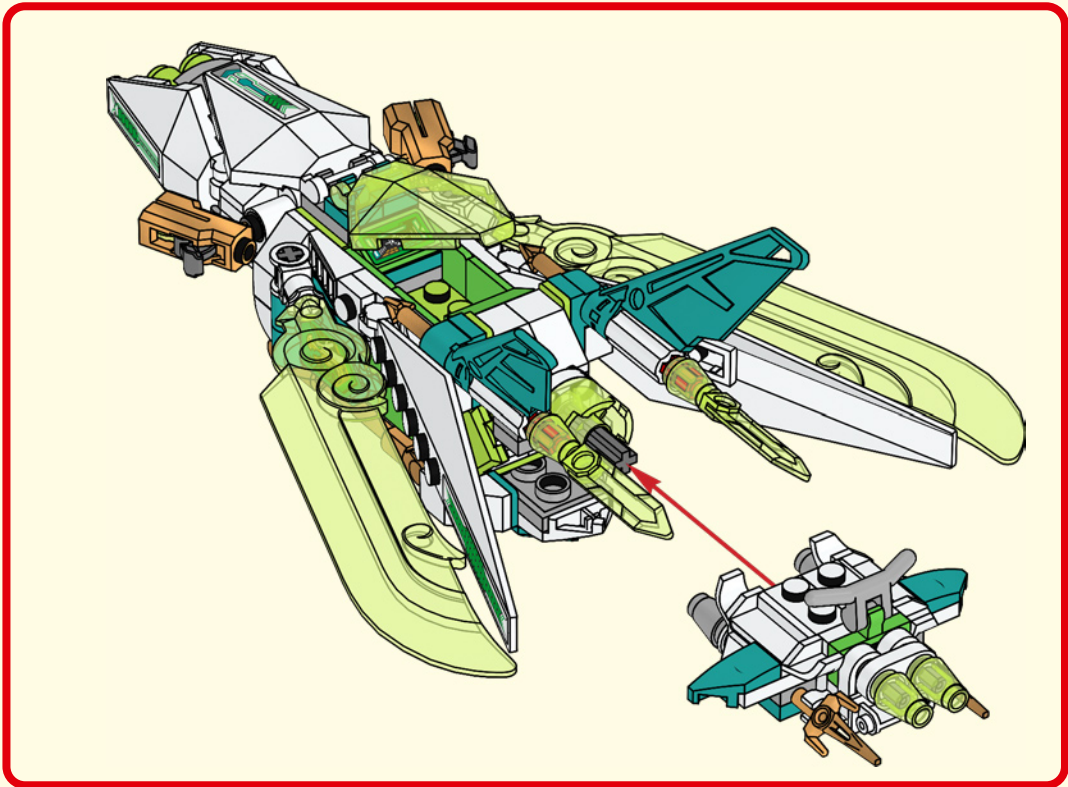



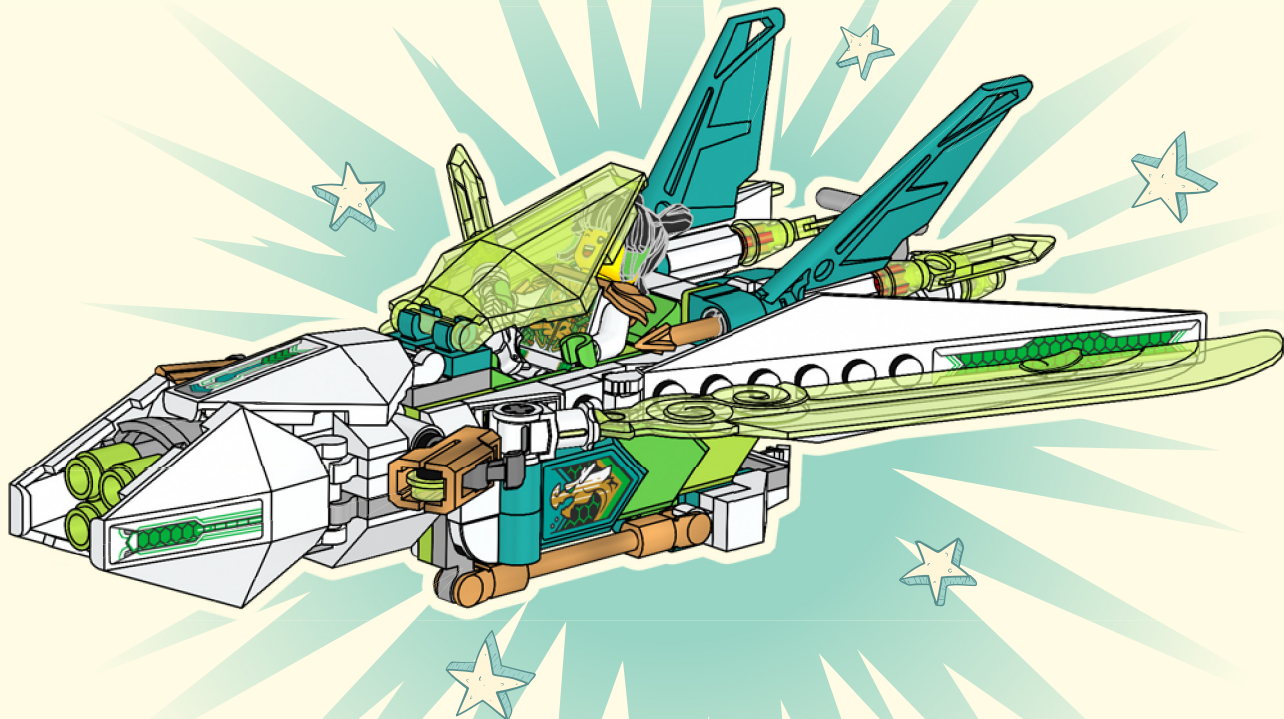



MONKIE KID 悟空 小侠



COMBINE 80040+80041

Combine 80040 + 80041
Kombinierbar mit 80040 und 80041
Combinez les sets 80040 et 80041
Combina 80040 + 80041
可将 80040 和 80041 组合玩乐
Объедините наборы 80040 + 80041
Połącz 80040 + 80041

Zkombinujte stavebnice 80040 a 80041
Skombinujte stavebnice 80040 a 80041
Kombinálđ a 80040-es és 80041-es szettel!
Combină 80040 + 80041
Комбинируйте 80040 + 80041
Savieno komplektus 80040 un 80041
Sobita kokku komplektid 80040 ja 80041
Sujunkite 80040 + 80041





MONKIE KID 悟空小侠



80040



80043



80045



80041

**COMBINE
80036+80044**



COMBINE 80036 + 80044 / KOMBINIERBAR MIT 80036 UND 80044 / COMBINEZ LES SETS 80036 ET 80044 / COMBINA 80036 + 80044 / 可将 80036 和 80044 组合玩乐 / ОБЪЕДИНИТЕ НАБОРЫ 80036 + 80044 / POŁĄCZ 80036 + 80044 / ZKOMBINUJTE STAVEBNICE 80036 A 80044 / SKOMBINUJTE STAVEBNICE 80036 A 80044 / KOMBINÁLD A 80036-OS ÉS 80044-ES SZETTTEL! / COMBINÁ 80036 + 80044 / КОМБІНІРАЙТЕ 80036 + 80044 / SAVIENO KOMPLEKTUS 80036 UN 80044 / SOBITA KOKKU KOMPLEKTID 80036 JA 80044 / SUJUNKITE 80036 + 80044

 1x 6301803	 2x 6375684	 2x 6265695	 2x 6249277	 5x 6168644	 2x 6417491	 1x 6280161	 6x 6336511
 2x 6168642	 1x 6296331	 6x 6166894	 1x 6023806	 1x 6334588	 1x 6422914	 3x 6089119	 2x 6249418
 2x 6388018	 2x 6212049	 2x 6176240	 1x 4173943	 3x 6138510	 1x 6199468	 2x 6424050	 2x 6328993
 2x 6172366	 1x 6375711	 2x 6023804	 3x 6341902	 2x 6405103	 2x 6195325	 2x 4529155	 3x 6249390
 6x 6337079	 2x 6057414	 1x 6250019	 2x 6423003	 4x 6401818	 1x 9339	 2x 6355014	 3x 6328050
 3x 6210272	 1x 393801	 2x 4515364	 1x 4205107	 1x 6270103	 1x 4253815	 4x 6213778	 1x 6338181
 6x 6330191	 1x 6301907	 1x 6339329	 1x 6055783	 5x 614126	 1x 6296345	 1x 6291018	
		 2x 4249112	 2x 4142865	 1x 4529236	 1x 6129476	 1x 6291017	
 1x 403201	 1x 243201	 2x 362301		 4x 6422913	 1x 6250480	 1x 6213777	 1x 6254100



1x
6381703



4x
4212454



2x
6365620



1x
6167483



2x
4164037



5x
6212972



2x
6253457



3x
4621548



1x
6132768



2x
6314353



2x
6215659



2x
6102360



2x
4529241



2x
6362975



2x
6227897



2x
6206249



2x
6168633



4x
6326078



1x
4258308



4x
6354568



1x
6326478



1x
6410336



4x
4211396



2x
4211445



1x
6278987



2x
6162580



4x
6296657



1x
6209691



1x
6370621



1x
4538126



2x
6270135



1x
4585493



2x
6093529



1x
6303532



2x
6345878



1x
6345949



2x
6147169



1x
6296849



2x
6244911



2x
6420280



1x
6423004



1x
6225494



2x
6350724



2x
6015356



1x
4225733



1x
6083620



4x
6337628



3x
6301802



4x
6240206



2x
6395635



3x
6360675



1x
6225494



2x
6350724



2x
6015356



1x
4225733



1x
6083620

4



LEGO.com/service

YOU COULD
WIN



Scan this QR code or go to
LEGO.COM/PRODUCTFEEDBACK and give
us your short feedback about this LEGO® set
for a chance to win a cool LEGO prize.

Terms and Conditions apply*



DE: Du könntest GEWINNEN. Es gelten die Teilnahmebedingungen* **FR: Tu pourrais GAGNER.** Des conditions s'appliquent* **IT: Potresti VINCERE tu.** Termini e condizioni sono applicabili* **ES: Puedes GANAR.** Aplican términos y condiciones* **PT: Poderá GANHAR.** Aplicam-se termos e condições* **JA: プレゼント付き! 利用規約が適用されます*** **ZH: 轻松获奖. 条款和条件适用*** **KO: 상품의 주인이 되어보세요. 소정의 약관이 적용됩니다*** **RU: Вы можете ВЫИГРАТЬ.** Действуют положения и условия* **PL: Szansa na WYGRANĄ.** Obowiązują warunki korzystania* **CS: Máte šanci VYHRÁT.** Platí všeobecné smluvní podmínky* **SK: Máte šancu VYHRAŤ.** Platia všeobecné zmluvné podmienky* **HU: TE IS NYERHETSZ.** Felhasználási feltételek érvényesek* **RO: Ai putea CĂȘTIGA.** Se aplică termenii și condițiile* **BG: Можете да СПЕЧЕЛИТЕ.** Има определени правила и условия* **LV: Tu vari LAIMĒT.** Ir spēkā noteikumi un nosacījumi.* **ET: Sul on võimalus VÕITA.** Kehtivad tingimused* **LT: Jūs galite LAIMĖTI.** Taikomos sąlygos*
*LEGO.com/productfeedback-terms

LEGO and the LEGO logo are trademarks of the LEGO Group. ©2023 The LEGO Group.

6501855