



# STAR WARS

MINI BUILDING SET

4485

Sebulba's™ Podracer



Anakin's™ Podracer

MINI

4193295





**STAR  
WARS™**



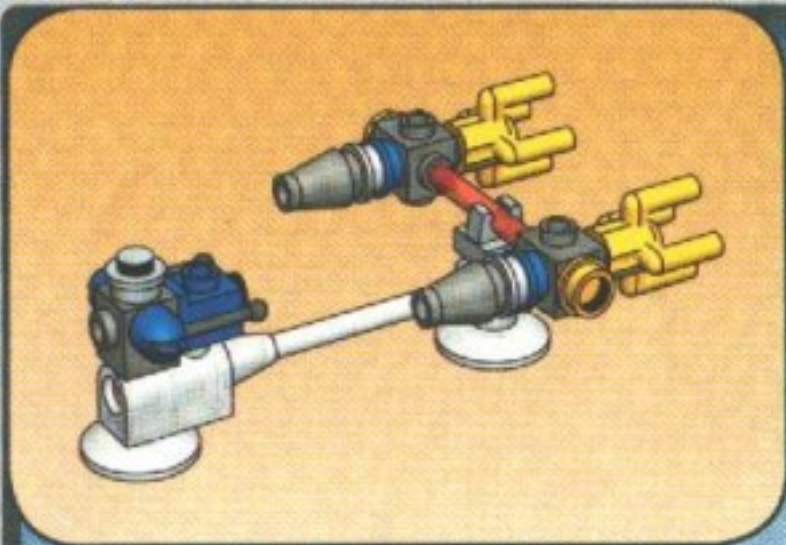

1

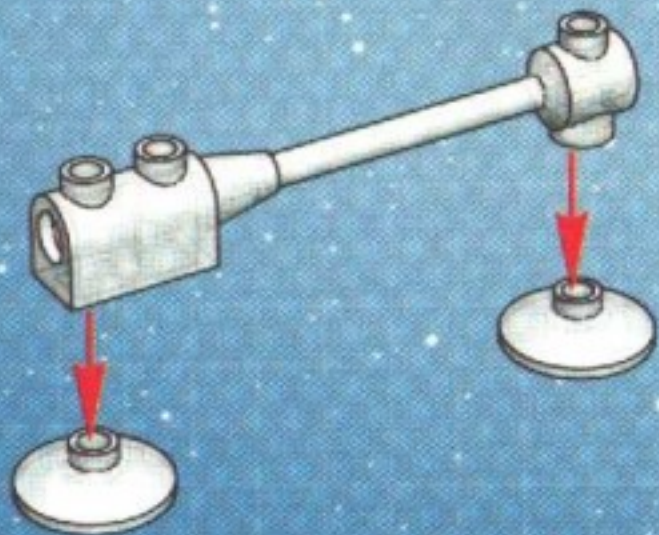

2

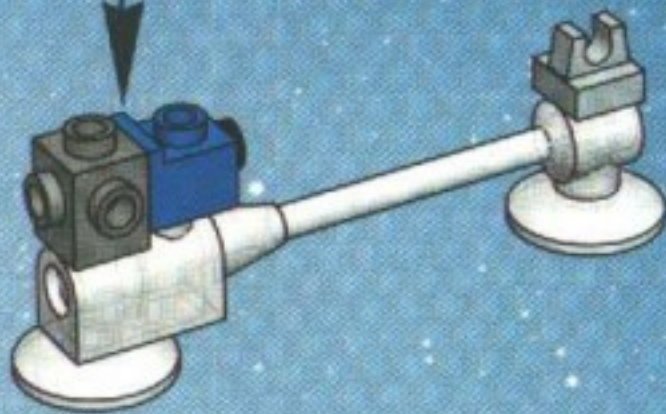
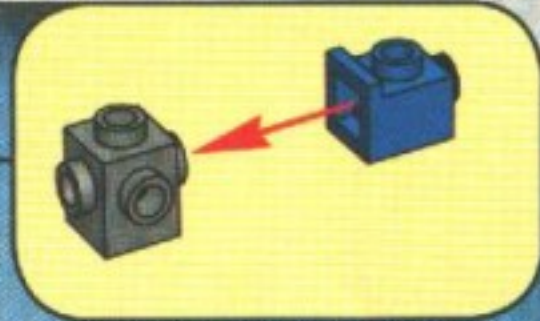

3





1



2



3



2x



4

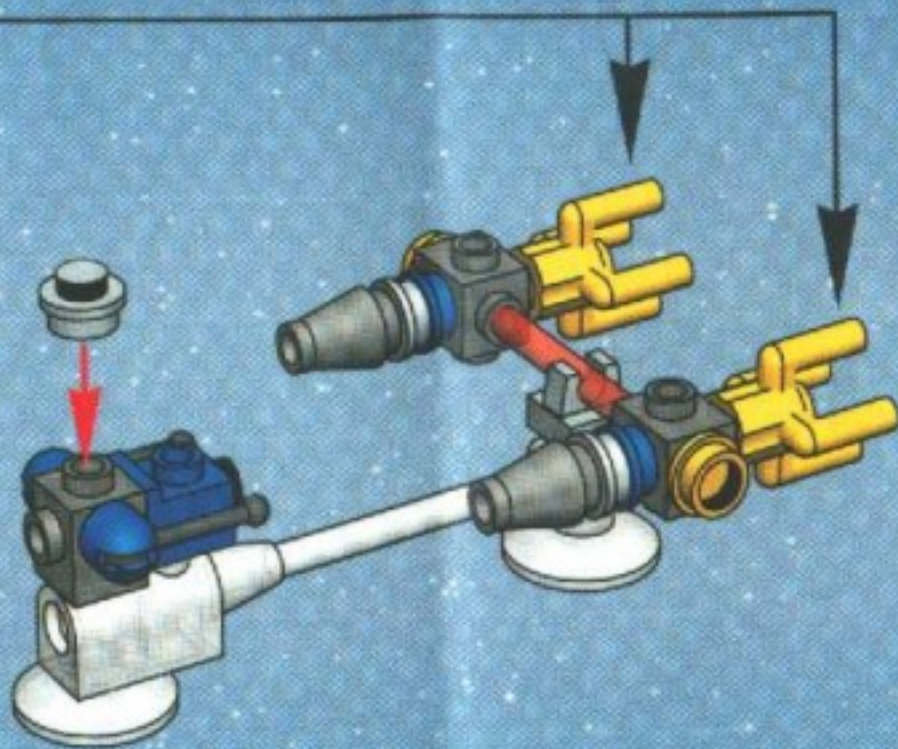



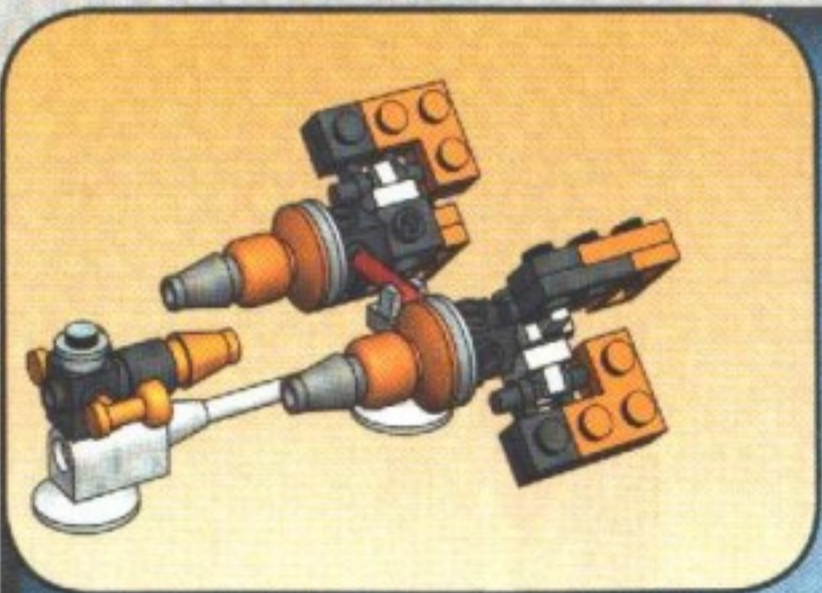

1

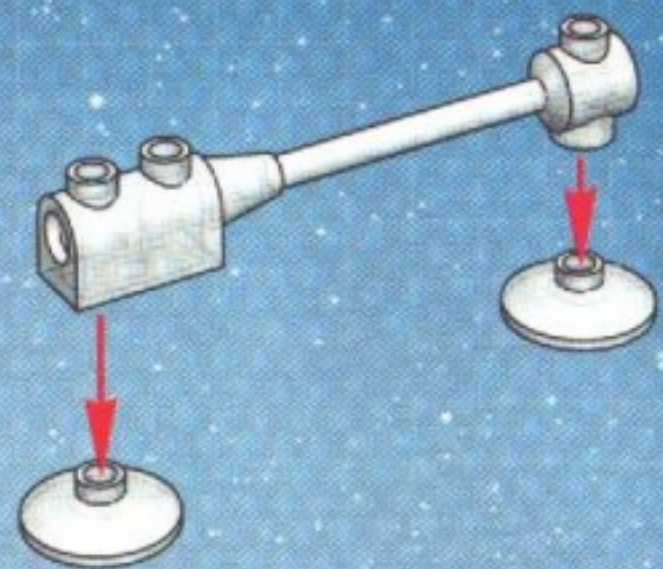

2

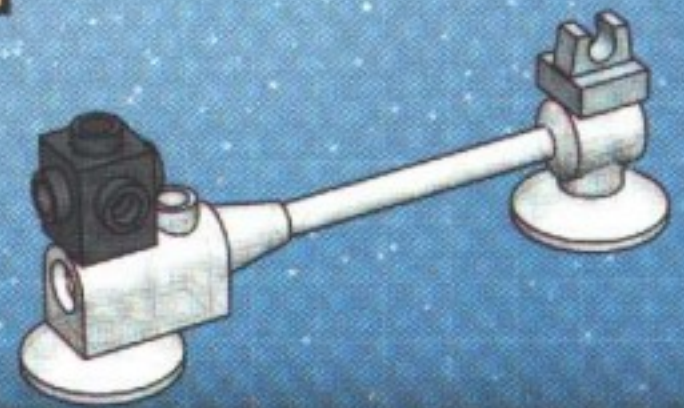



B



4

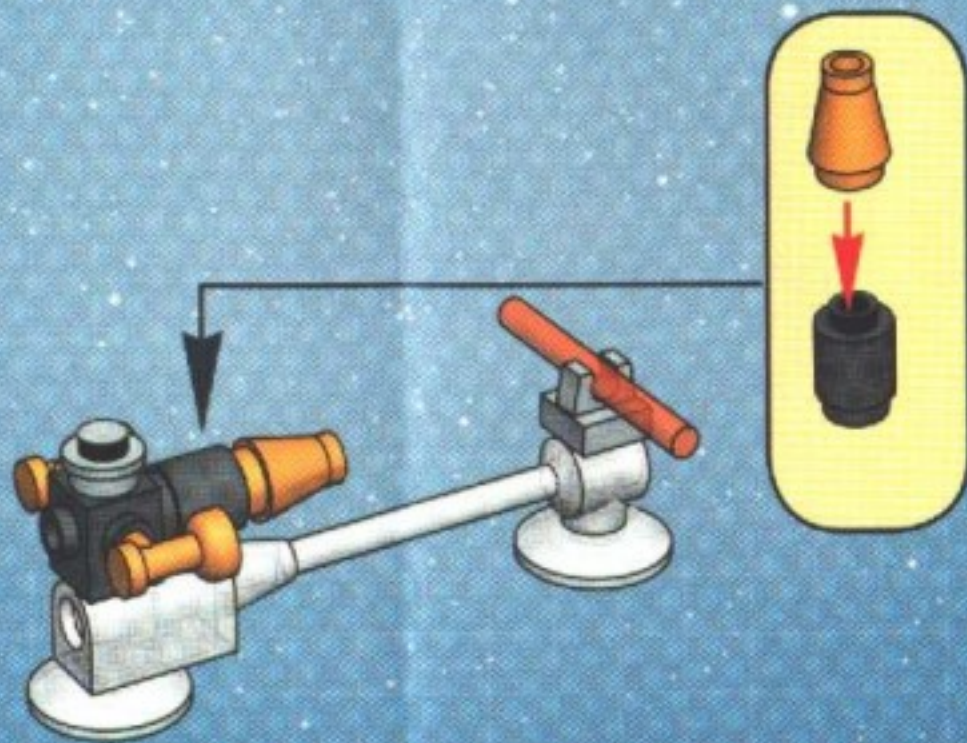



1



2



3



2x



5







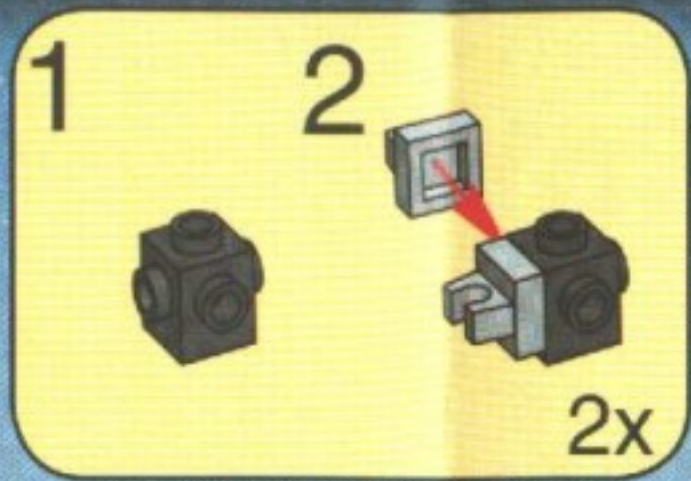

6





1 

2   
  

2x





1



2



2x







# STAR WARS

# WIN







1

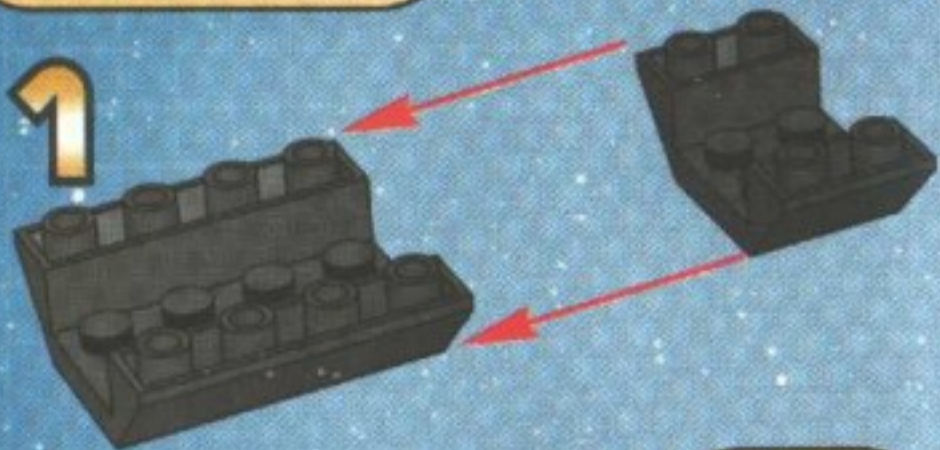

2

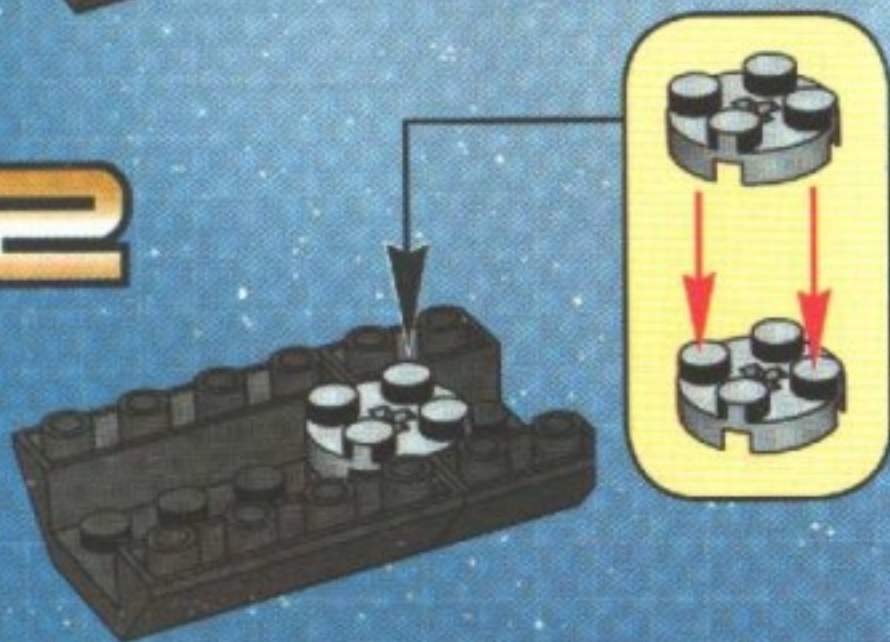

B

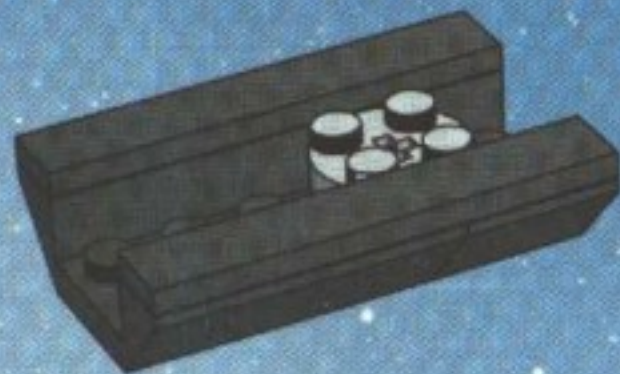

4

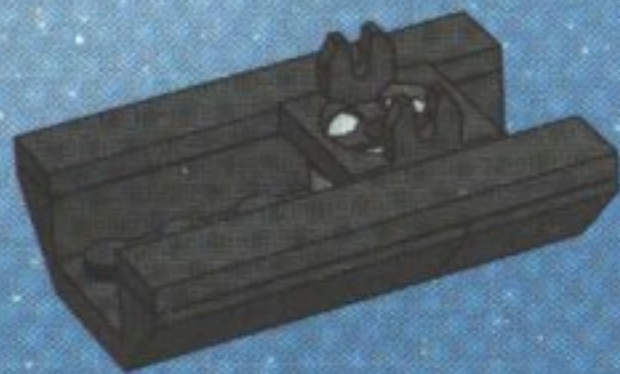





1

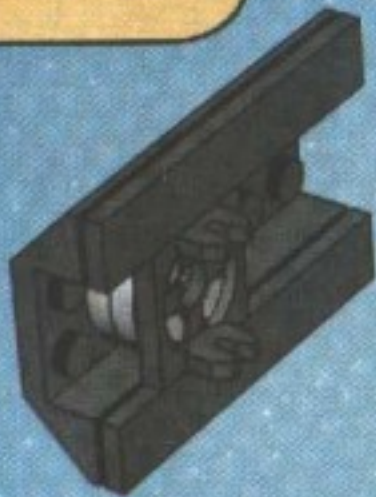

2



3

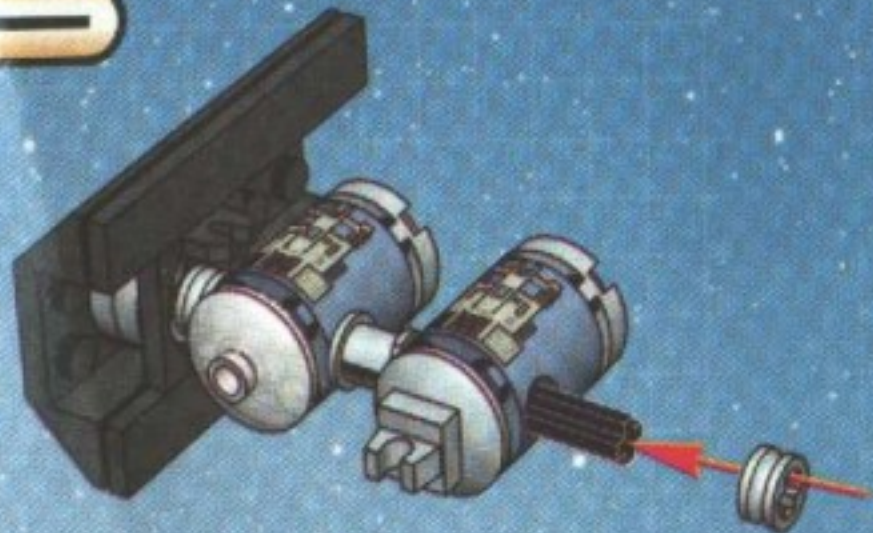

4

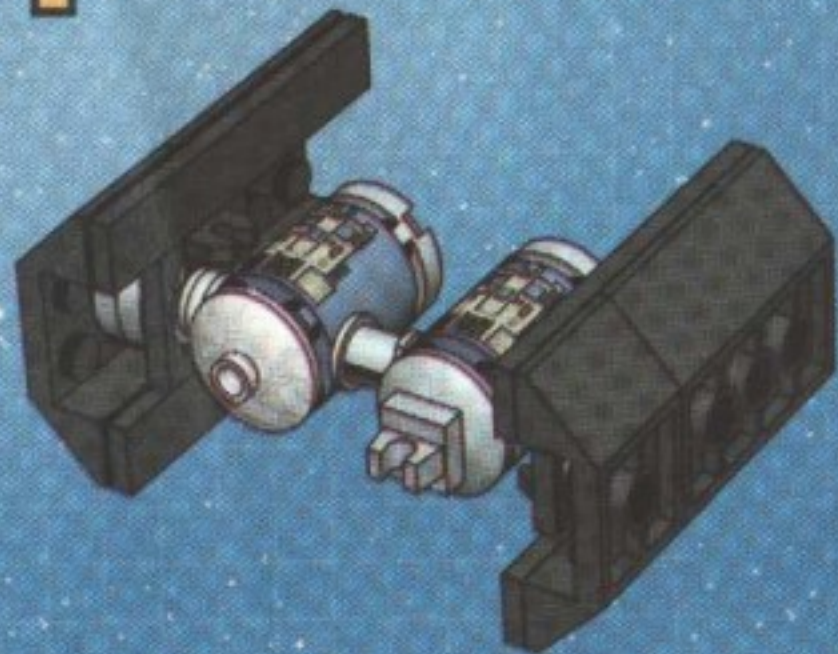



**STAR WARS**  
WWW.STARWARS.COM



[www.LEGO.com](http://www.LEGO.com)



LEGO, the LEGO logo and the minifigure are trademarks of the LEGO Group.  
© 2003 The LEGO Group.

© 2003 Lucasfilm Ltd. & TM. All rights reserved. Used under authorization