

LEGO

Harry Potter

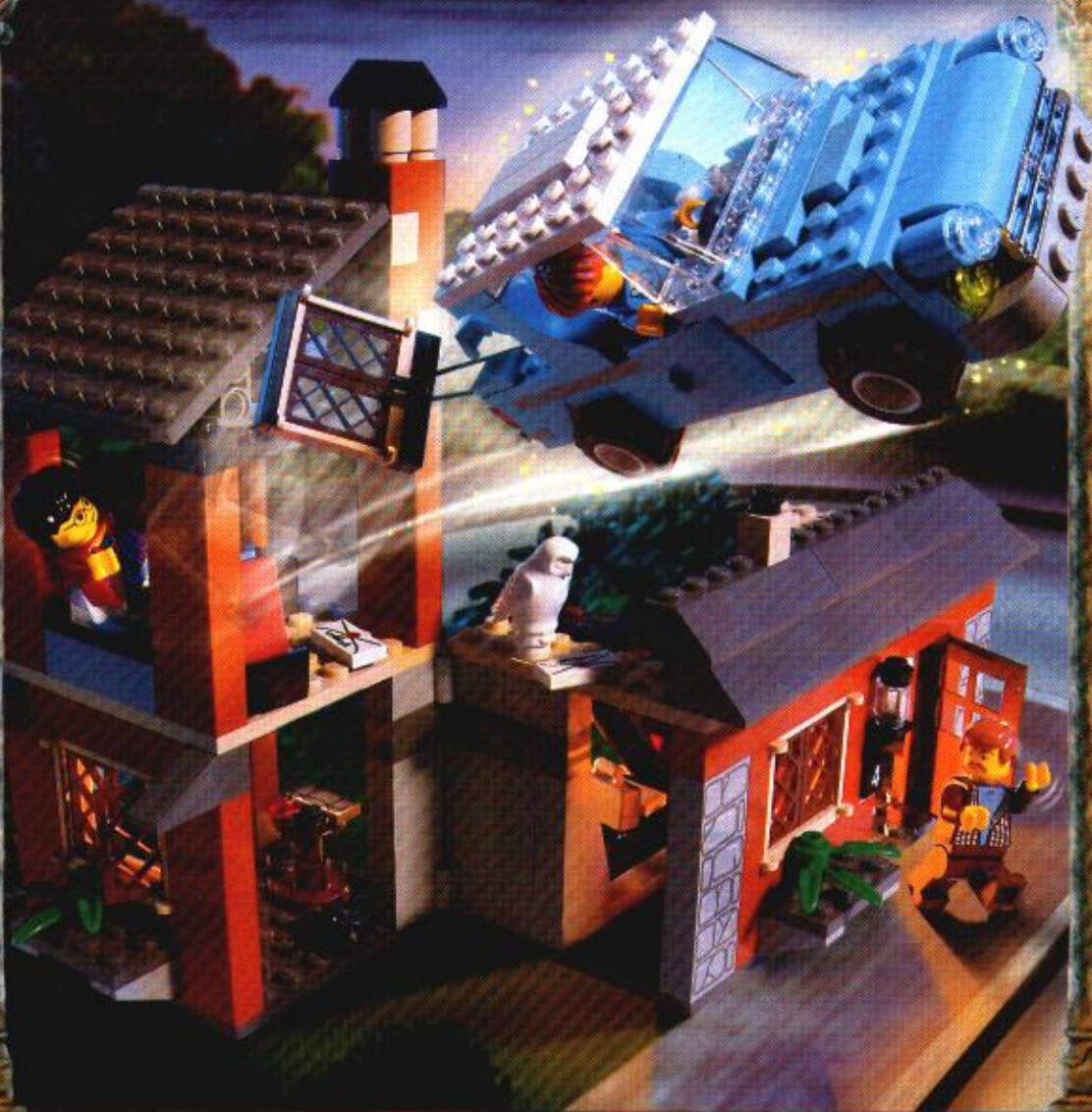

4728

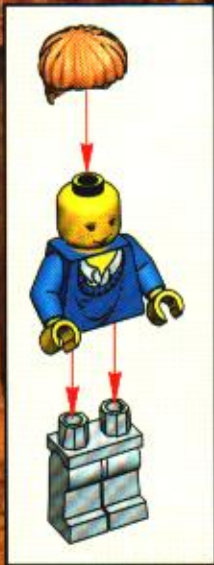

1

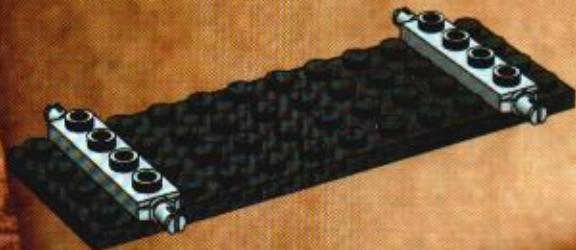

2

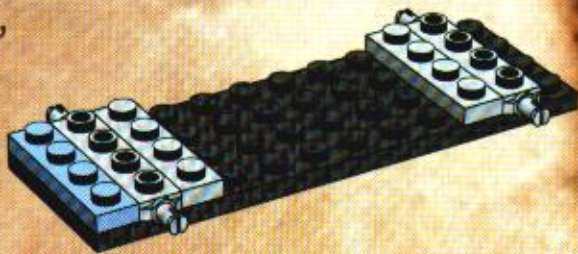

3

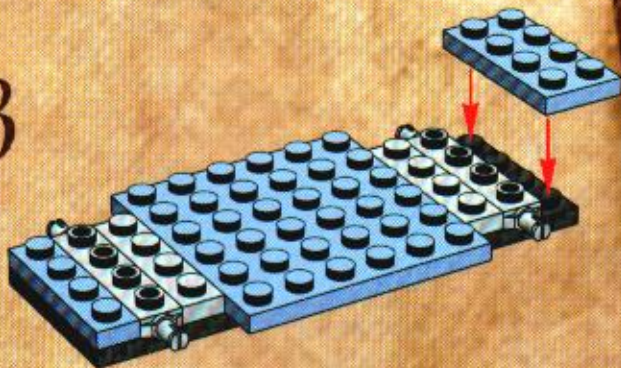

4

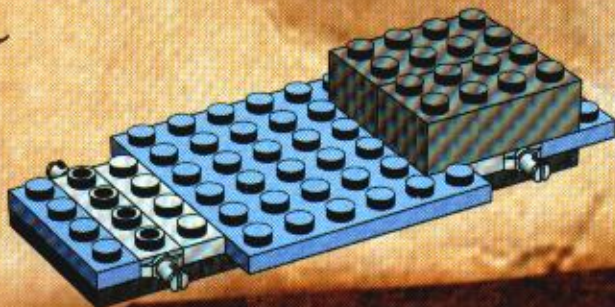

5

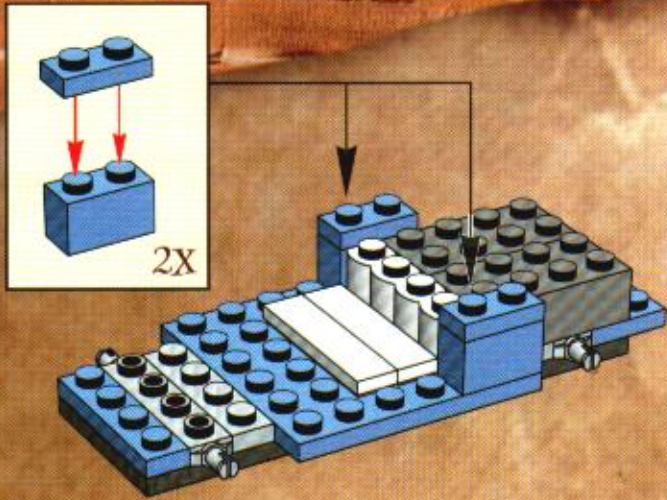

1



2



3

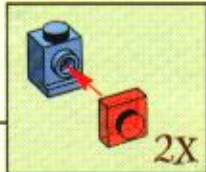
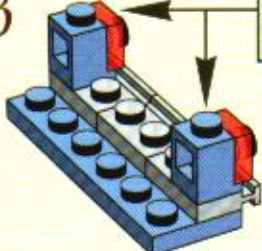

4

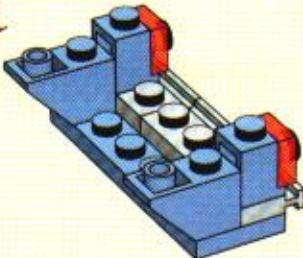

6

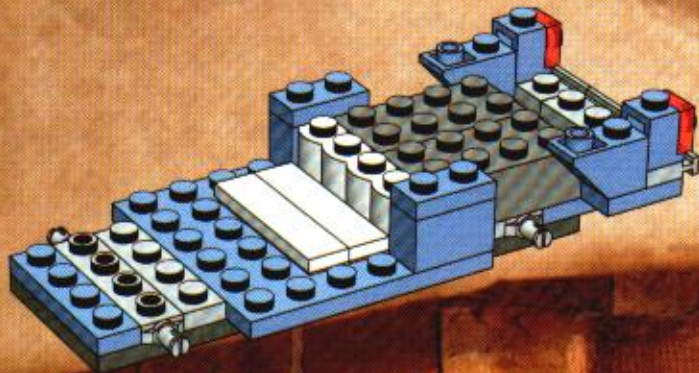

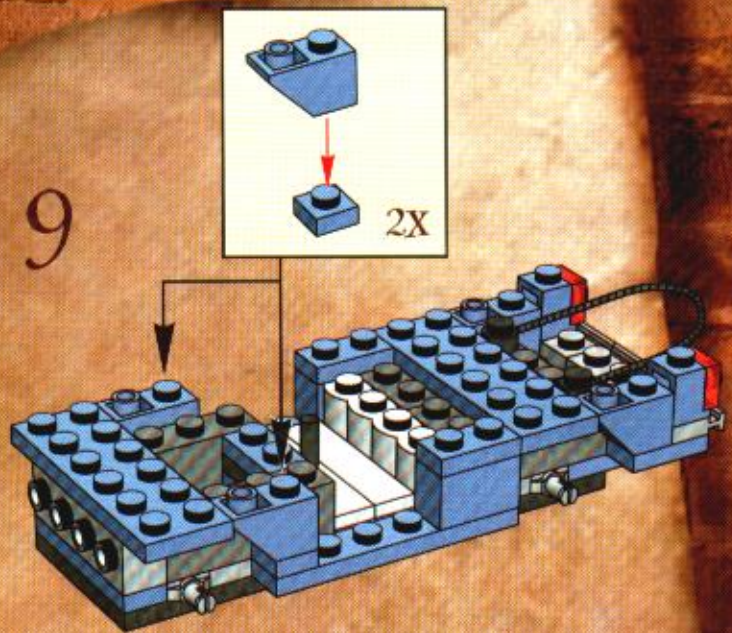
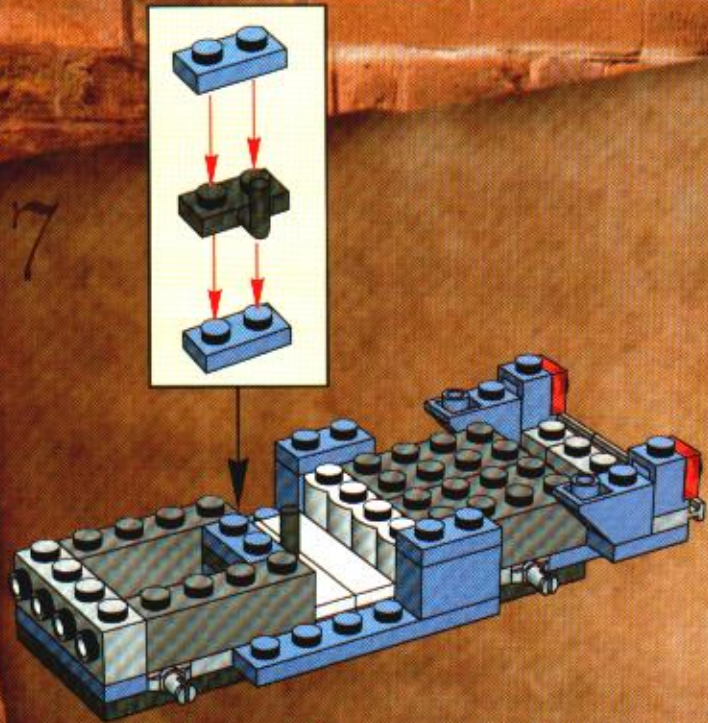

11

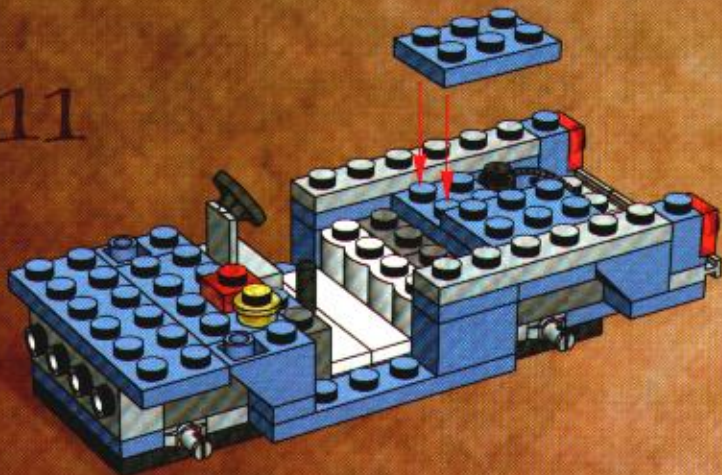

12

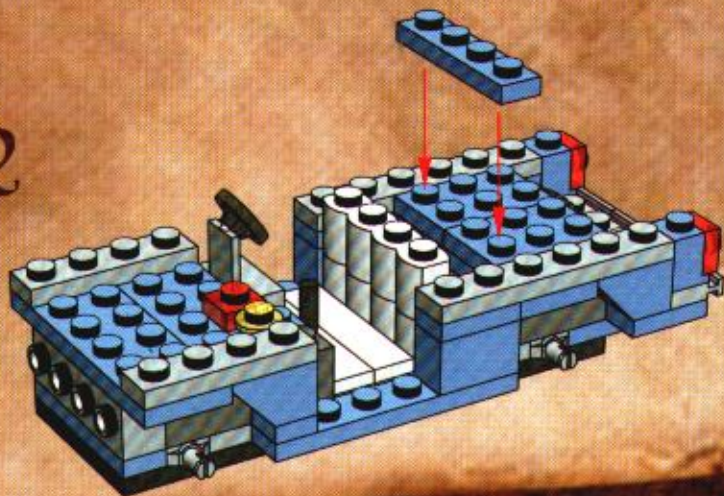

13

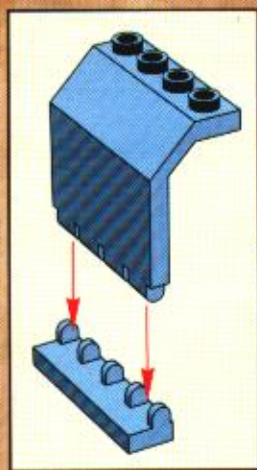
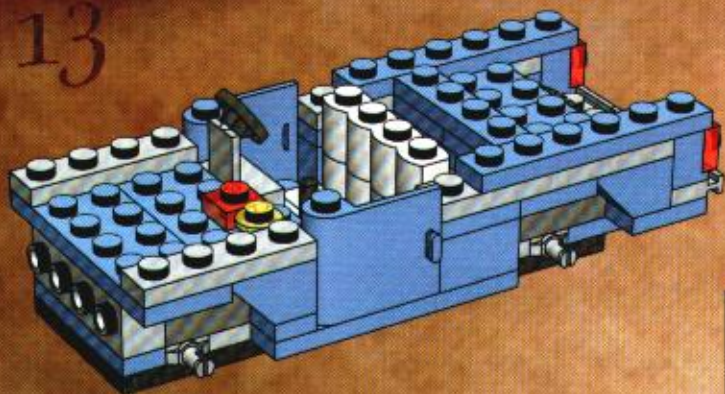

14

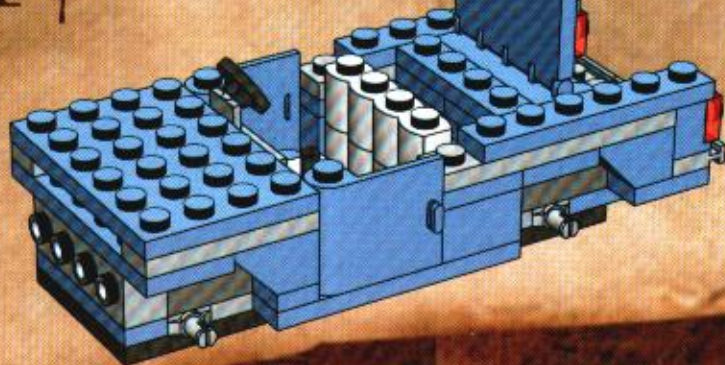

1

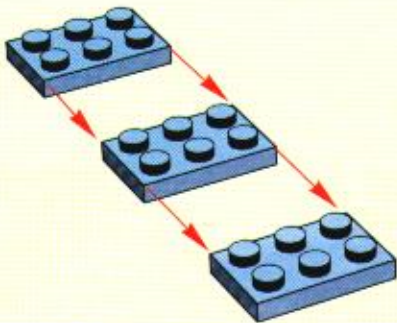

2

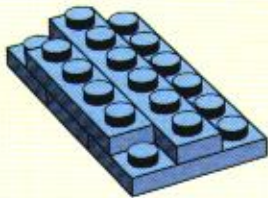

3

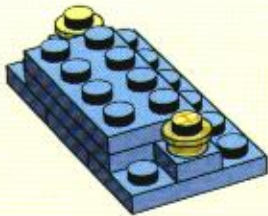

4

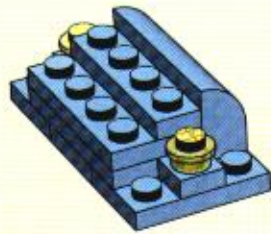

5

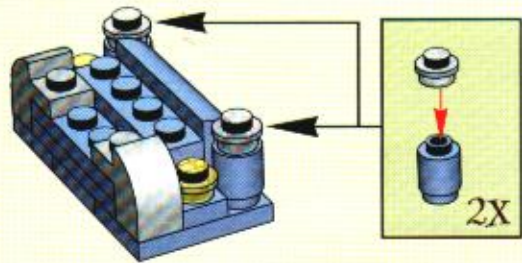

6

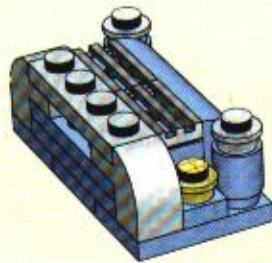

15

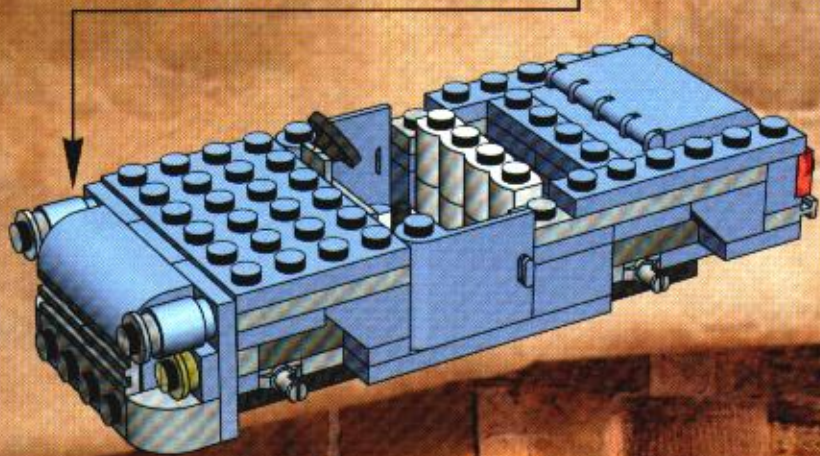

16

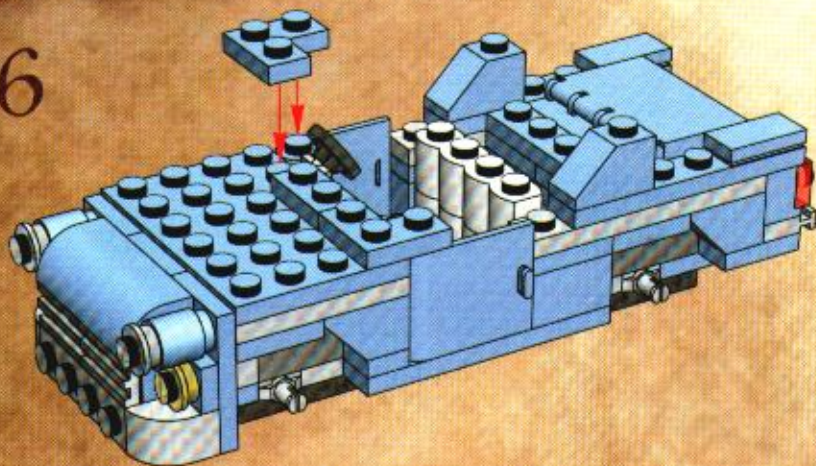

17

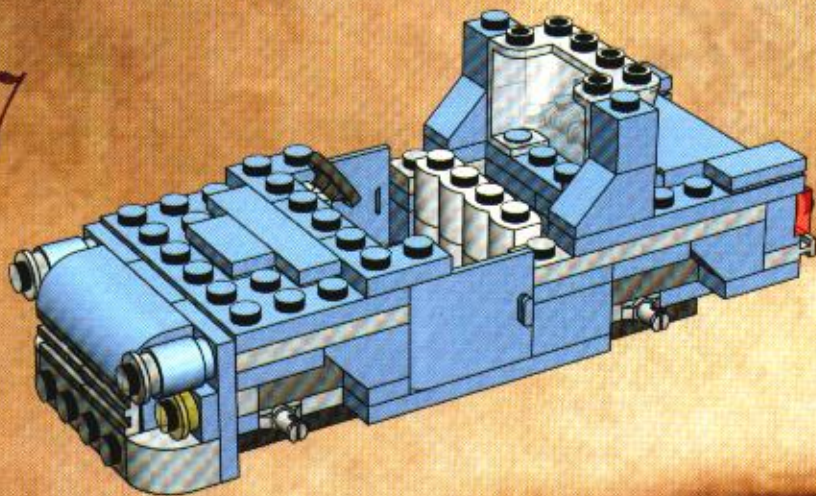

18

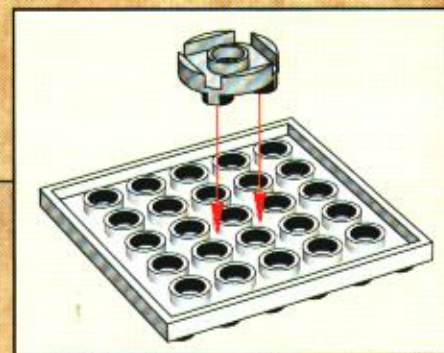
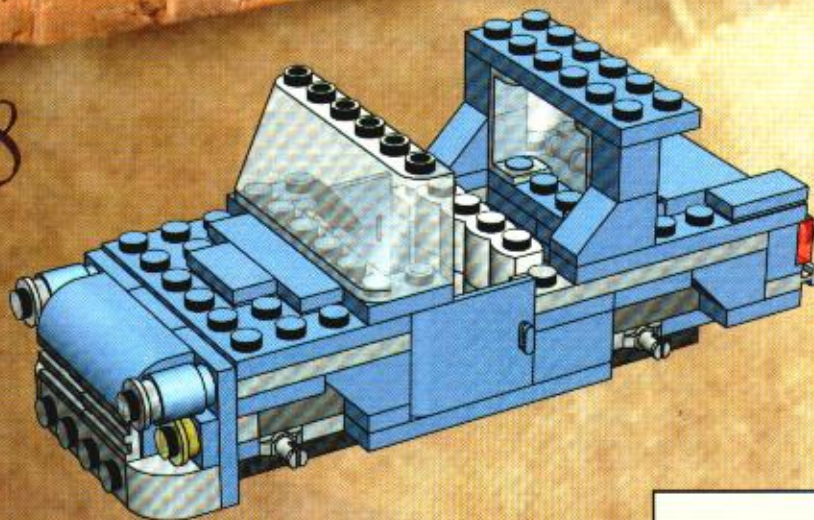

19

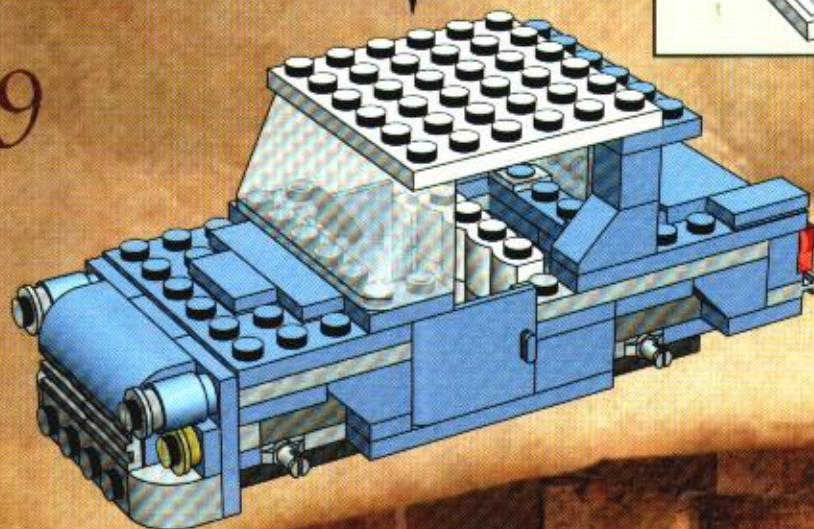

20

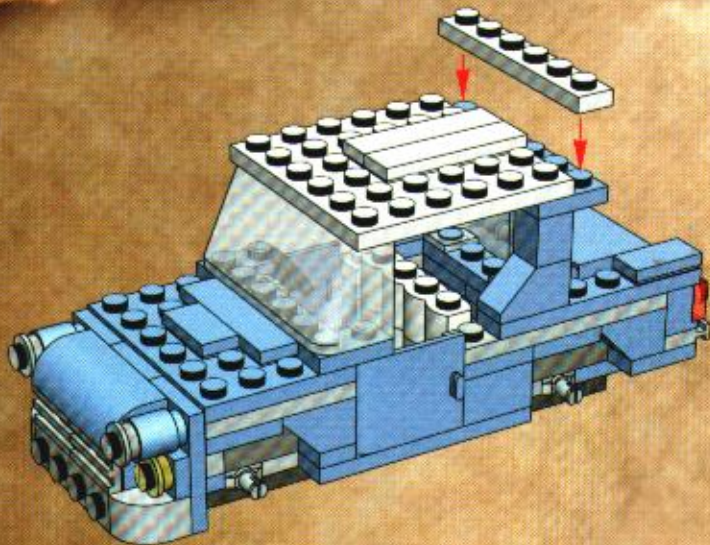

21

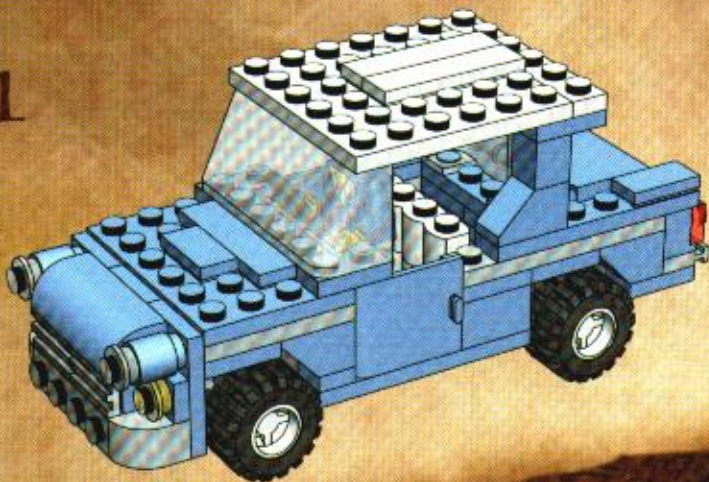

1

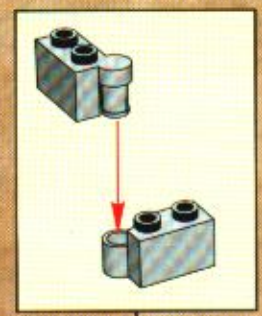
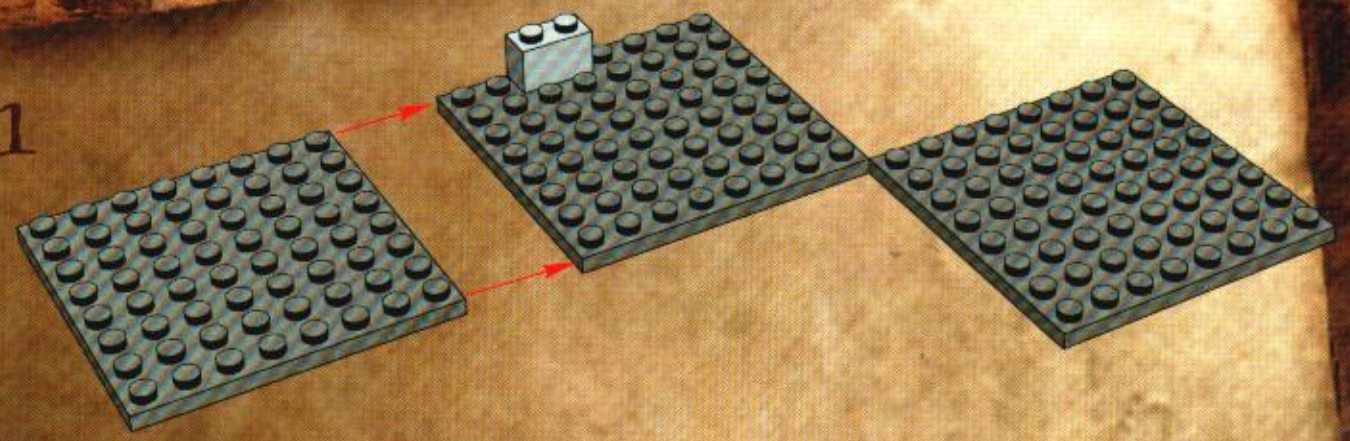

2

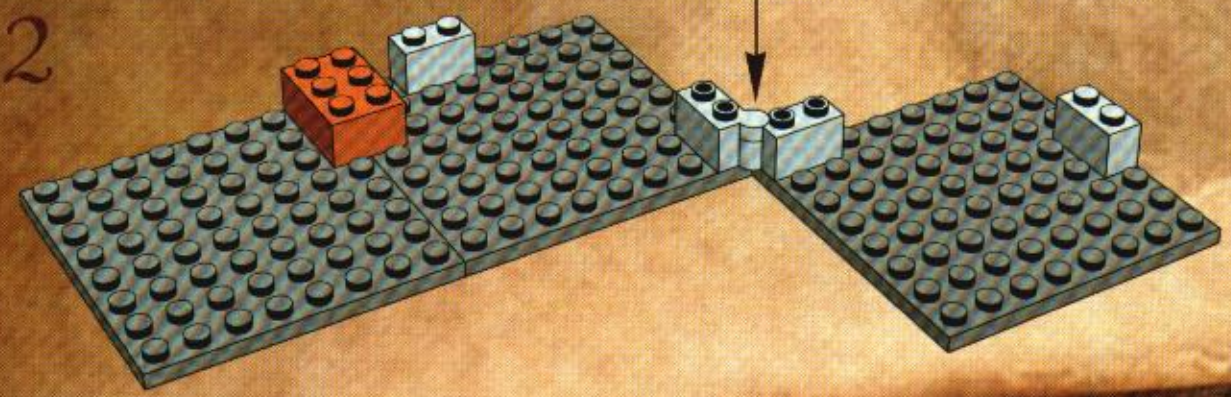

3

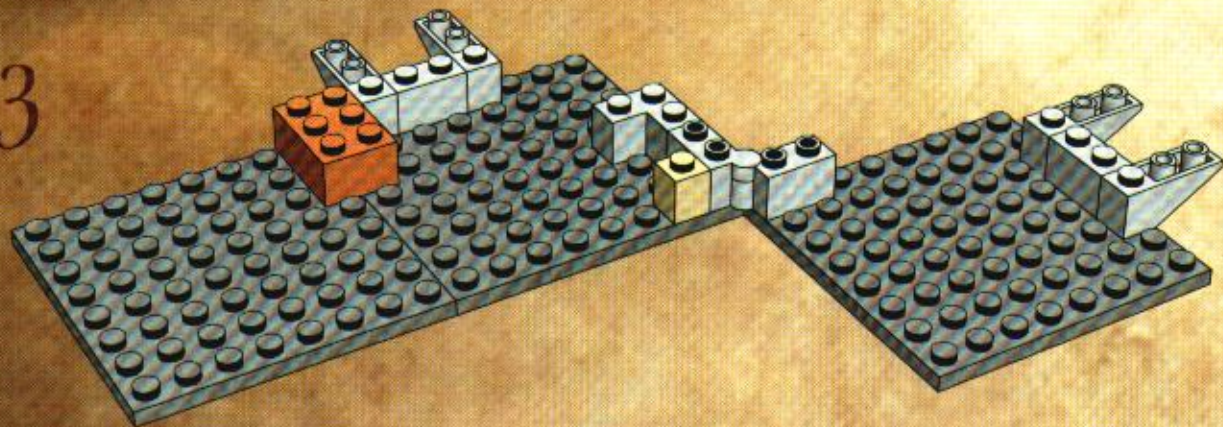

4

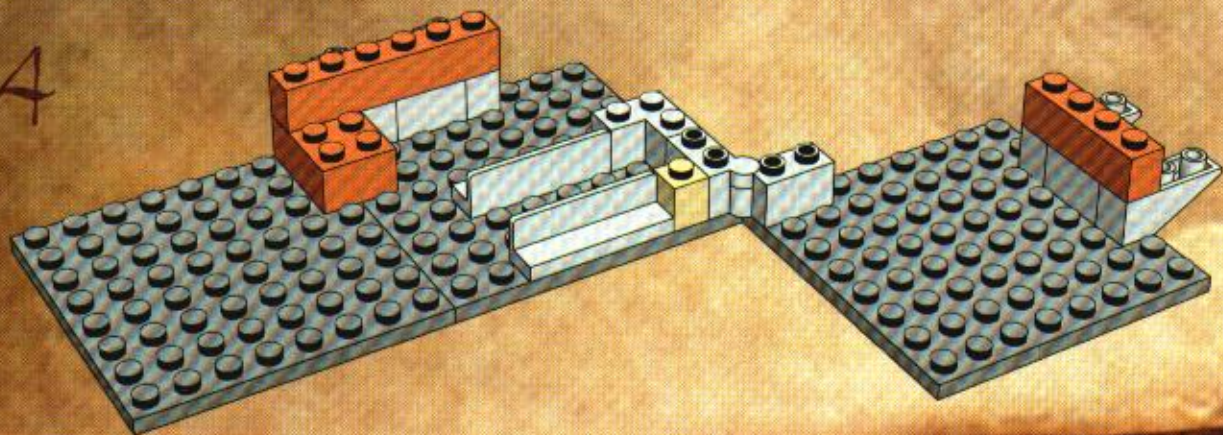

5

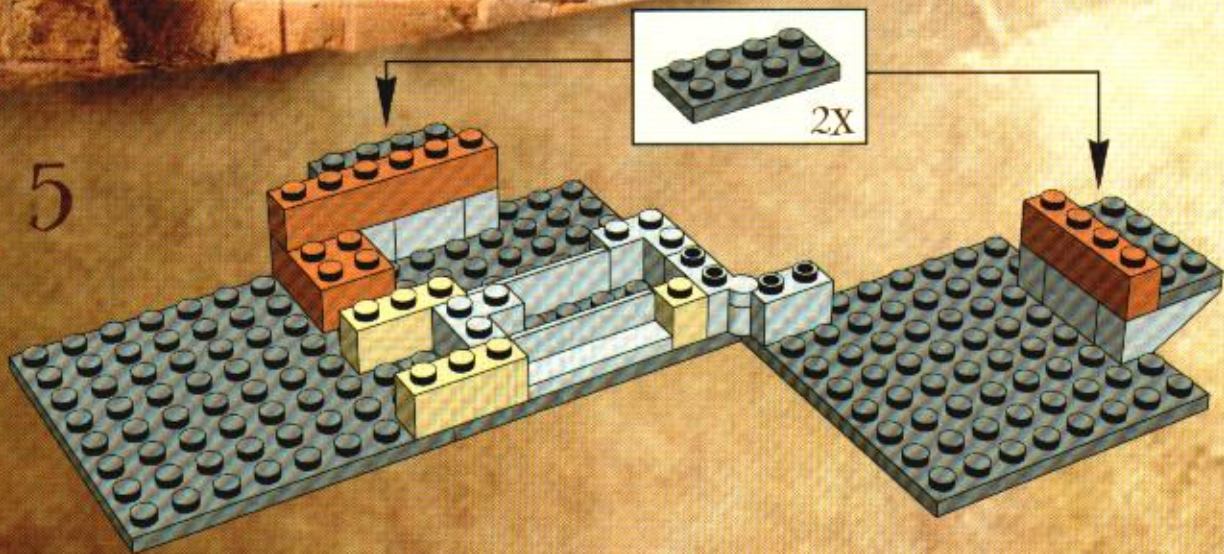

6

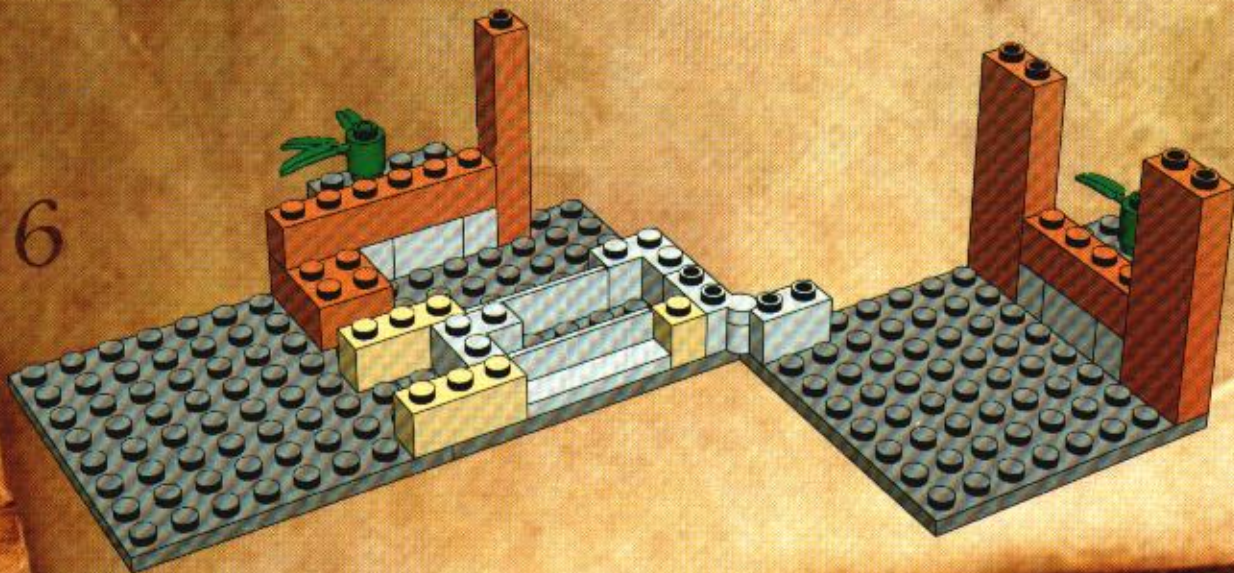

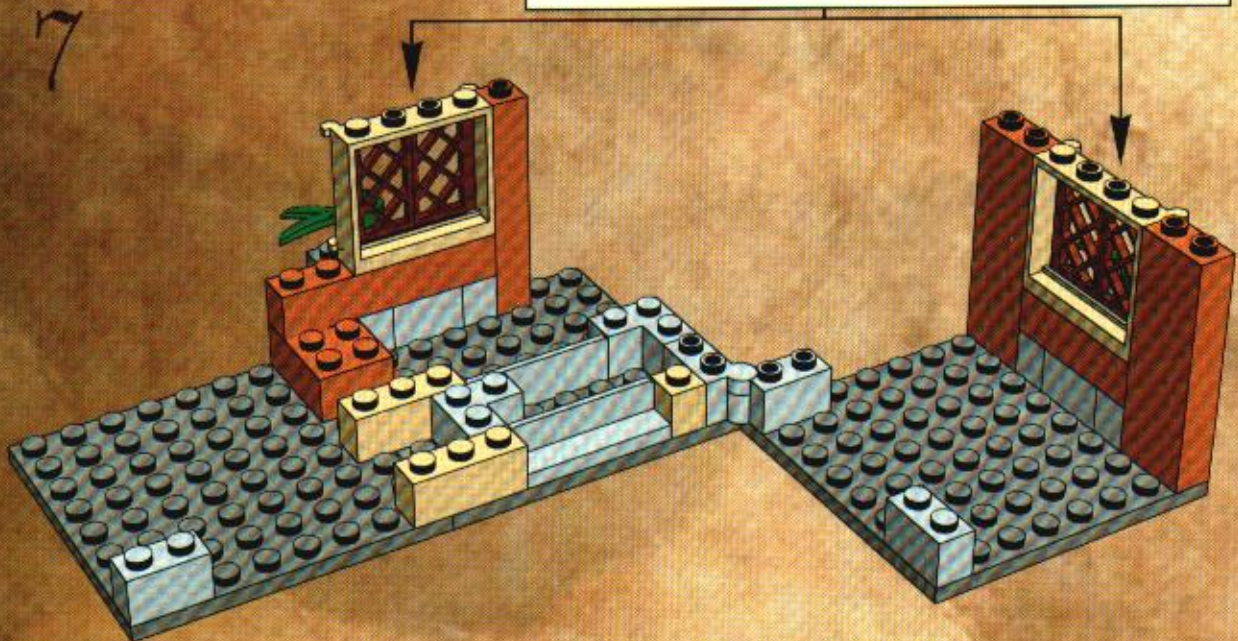
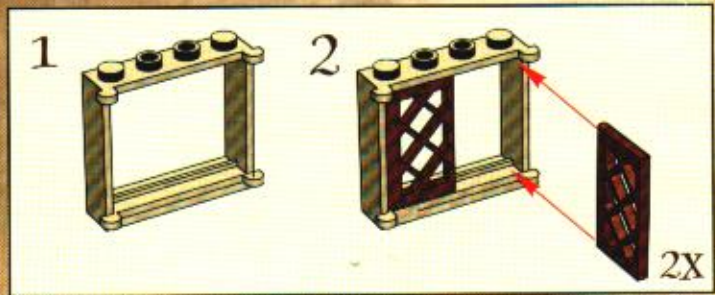

8

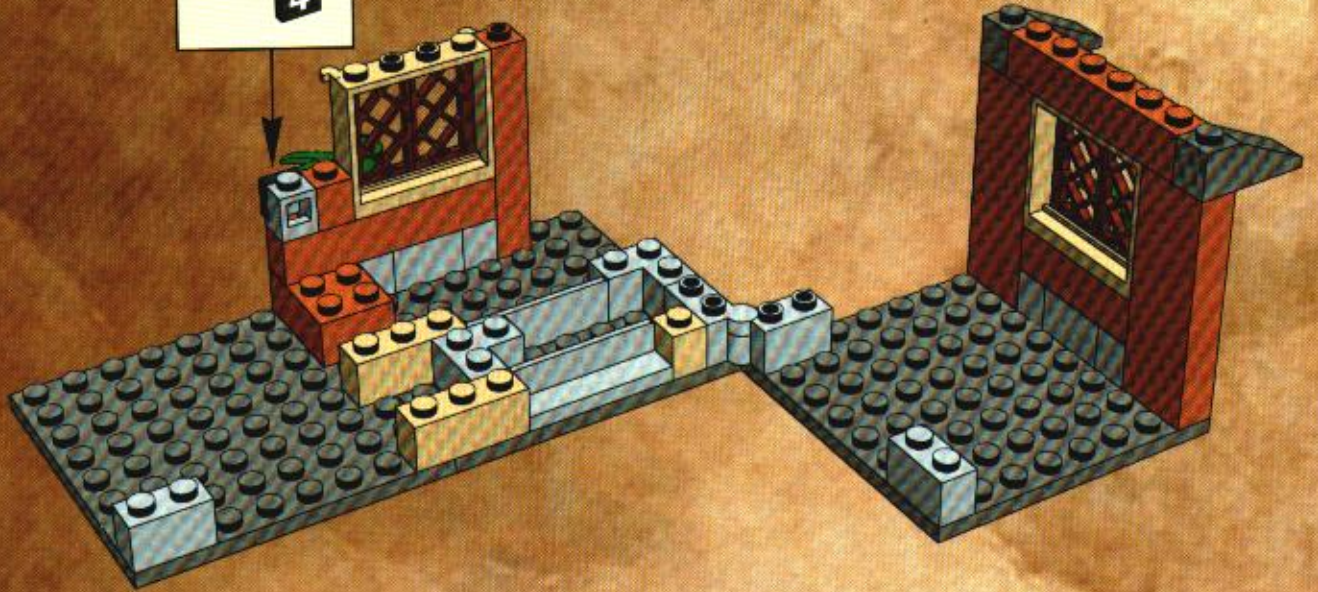

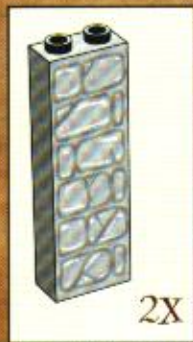

9

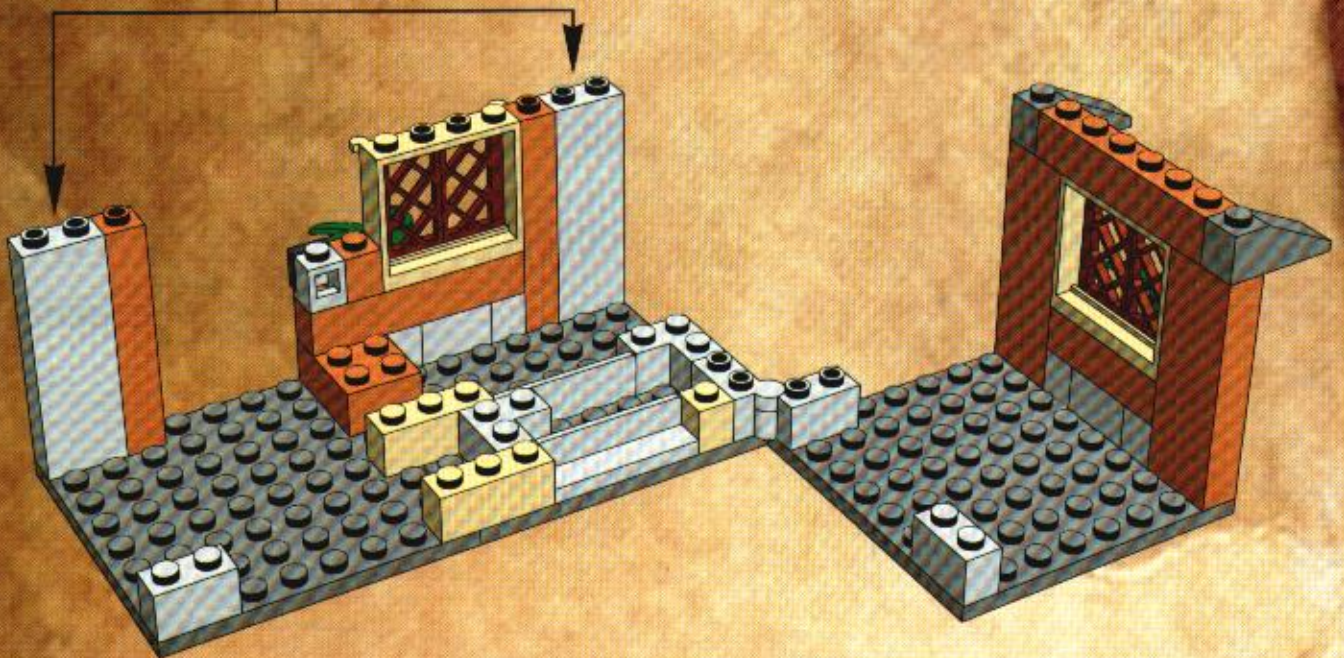

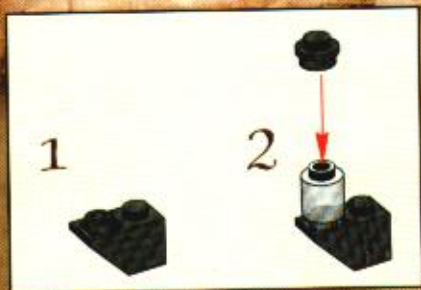

10

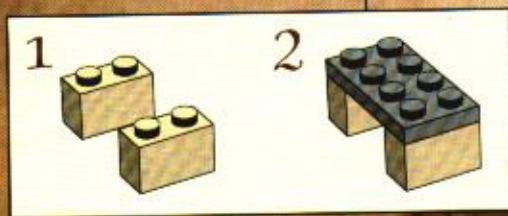
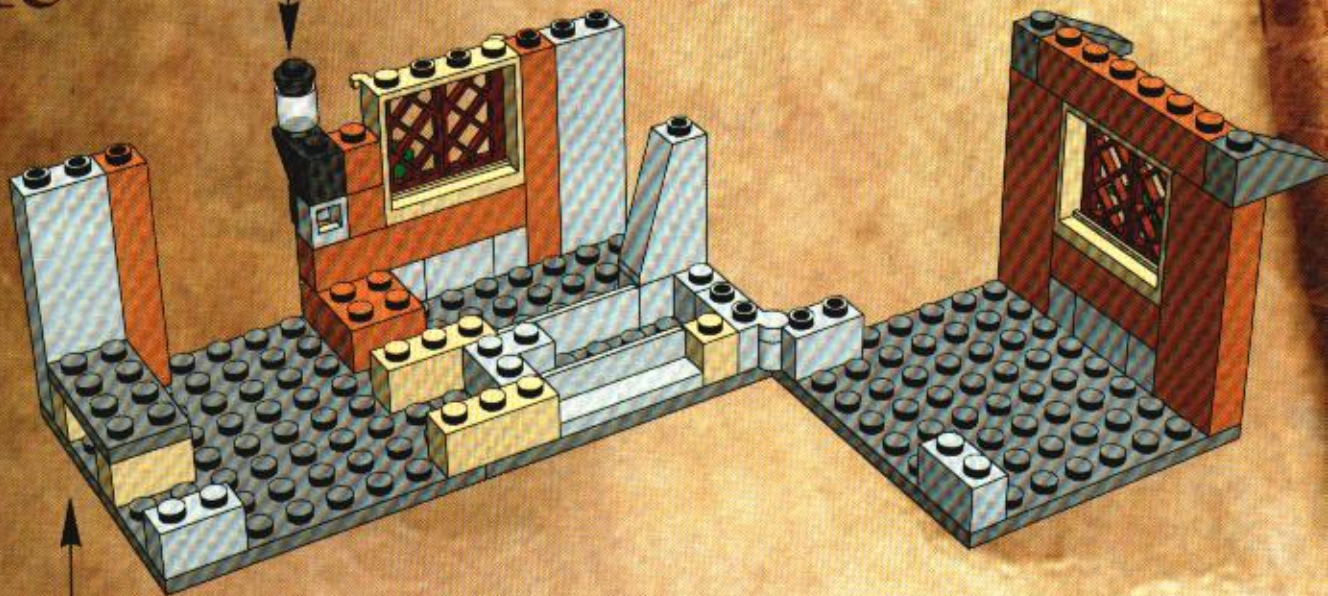

11

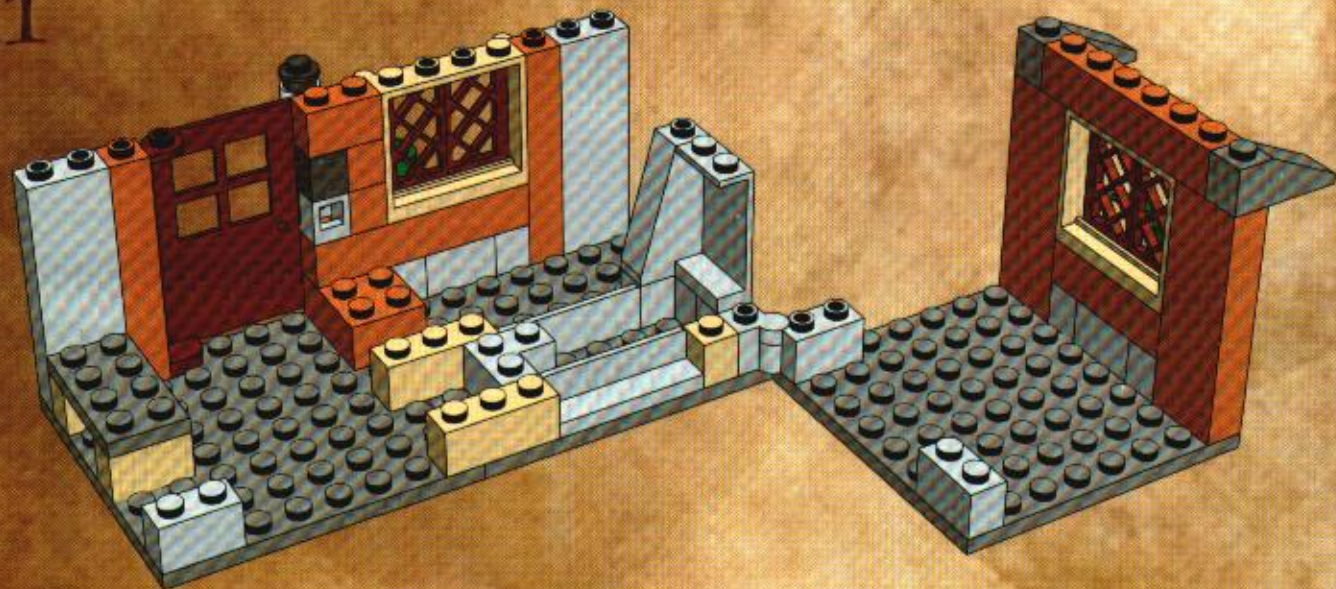

12

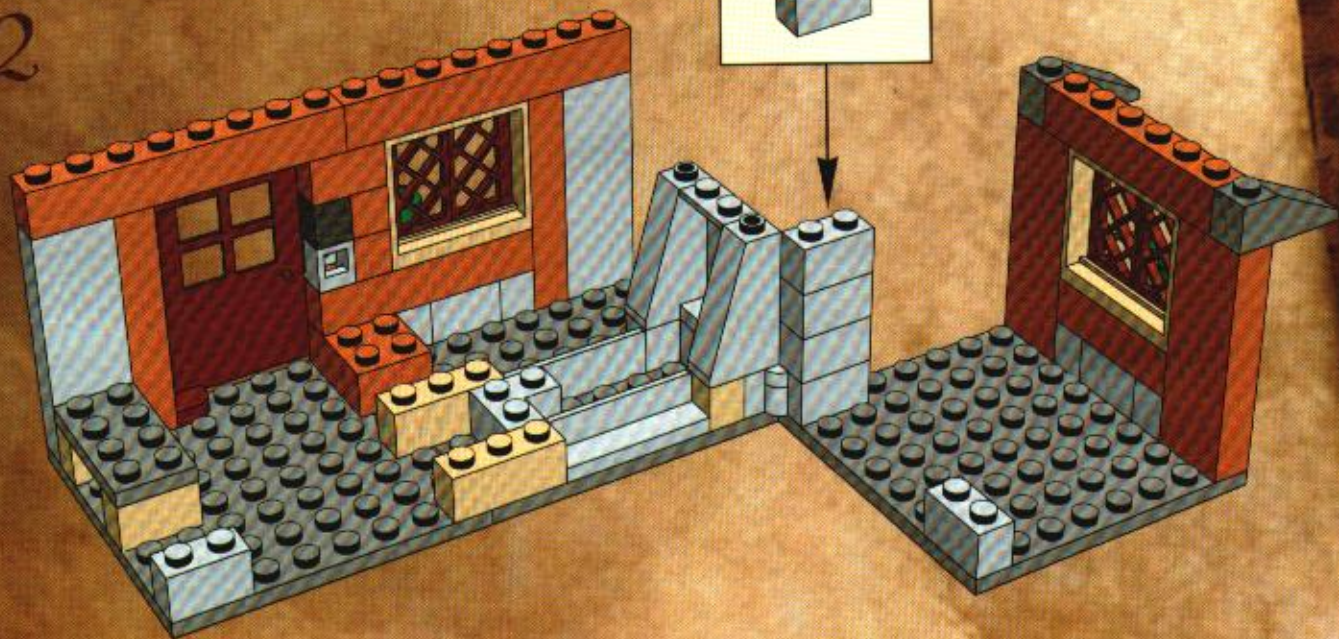

13

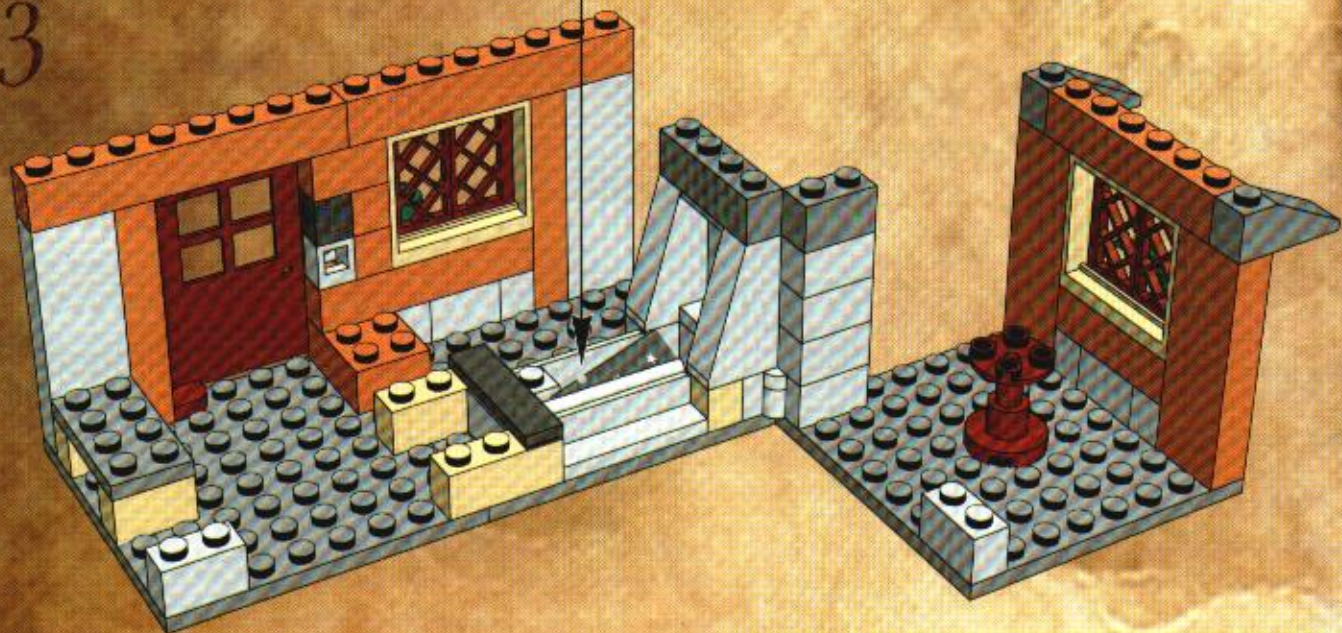
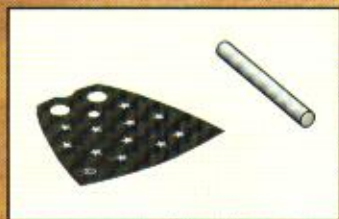

14

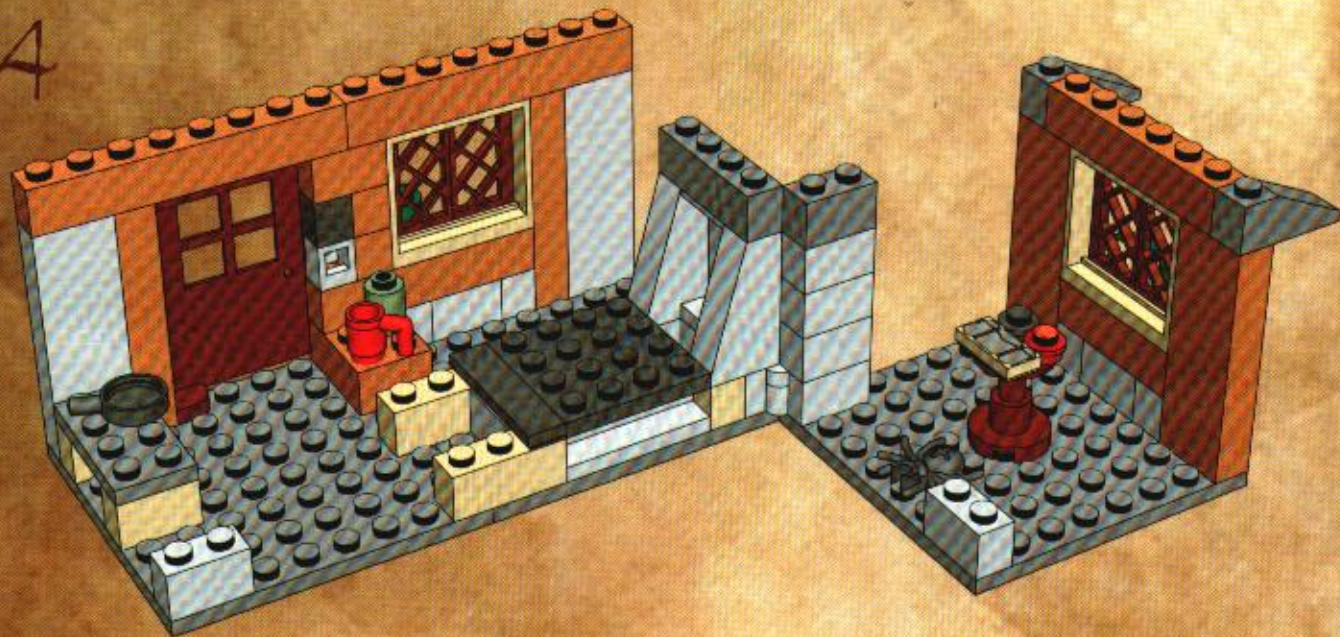

15

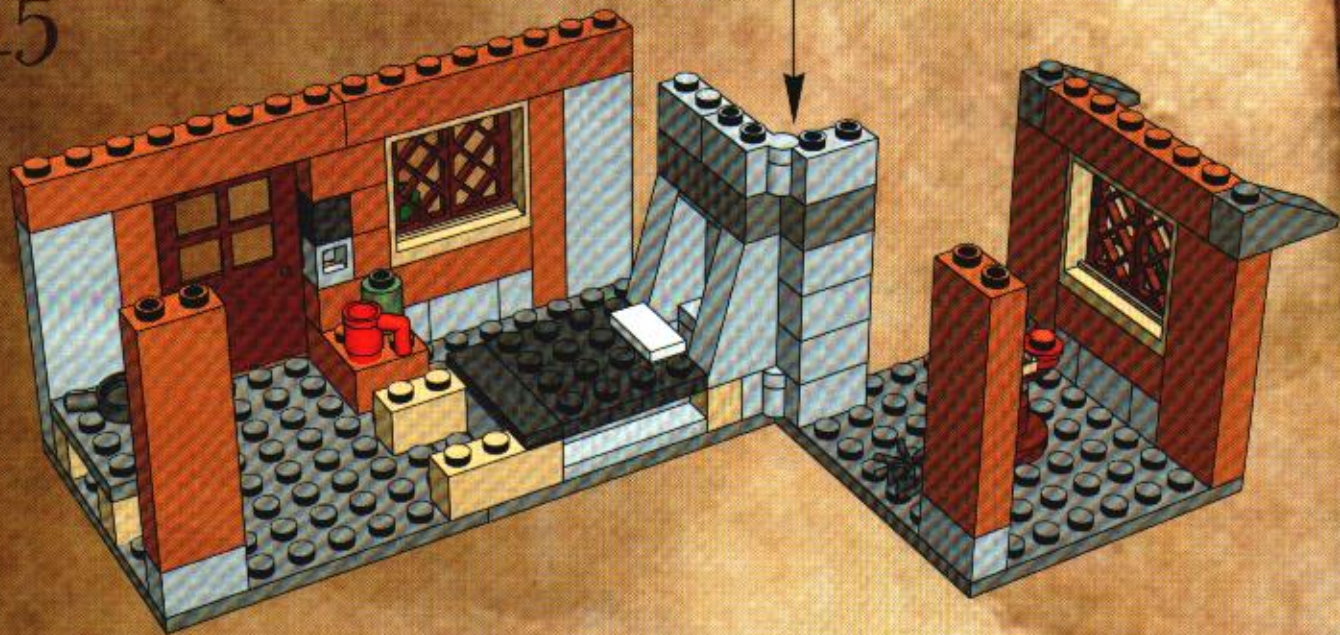
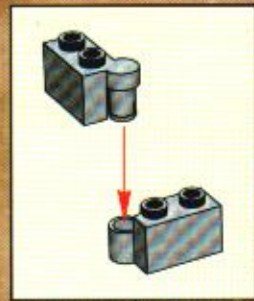

16

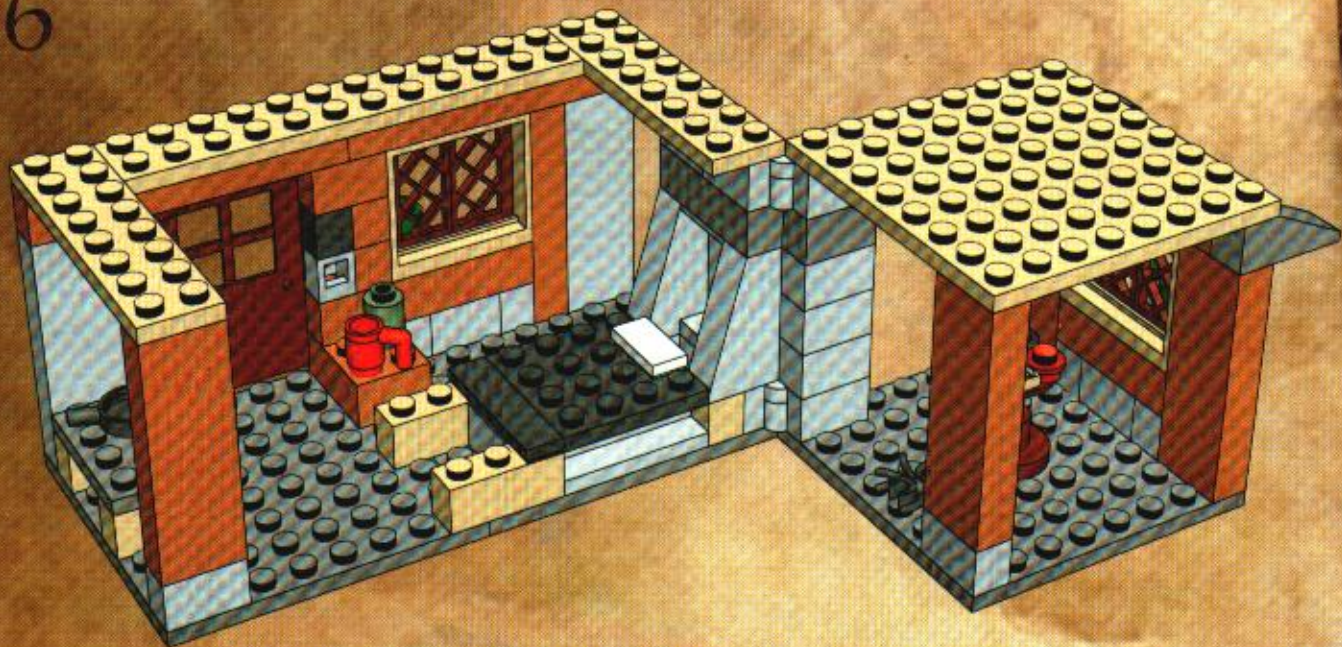

17

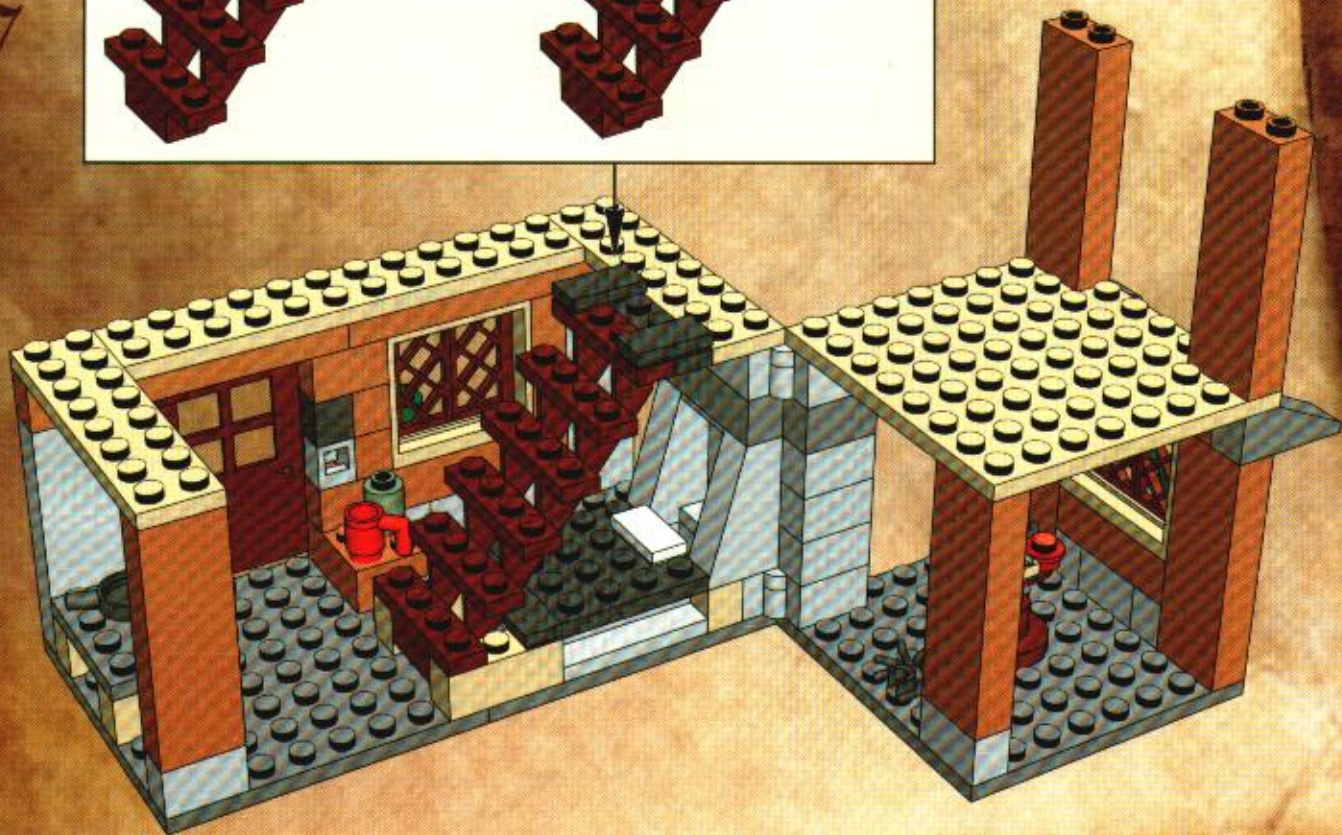
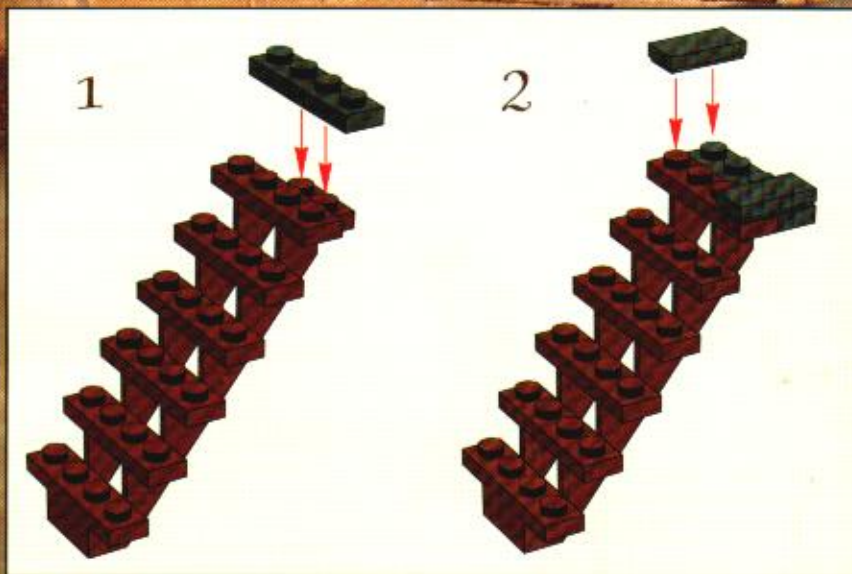

18

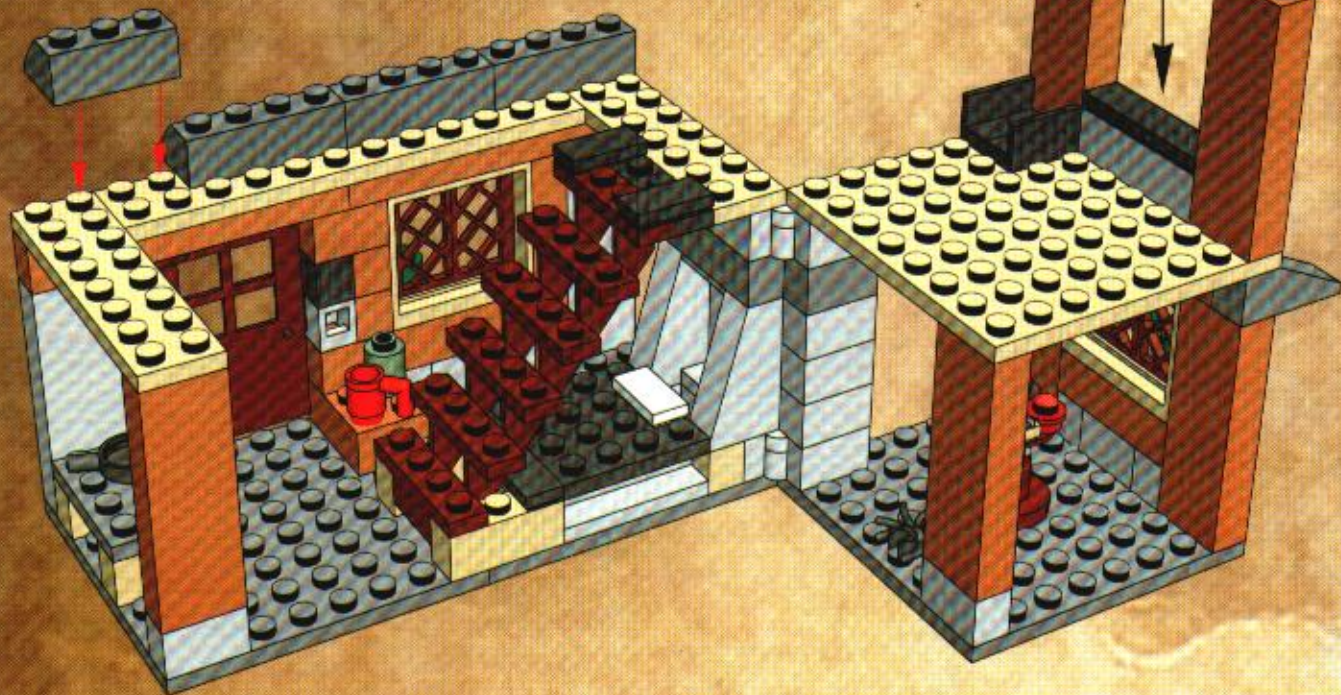

19

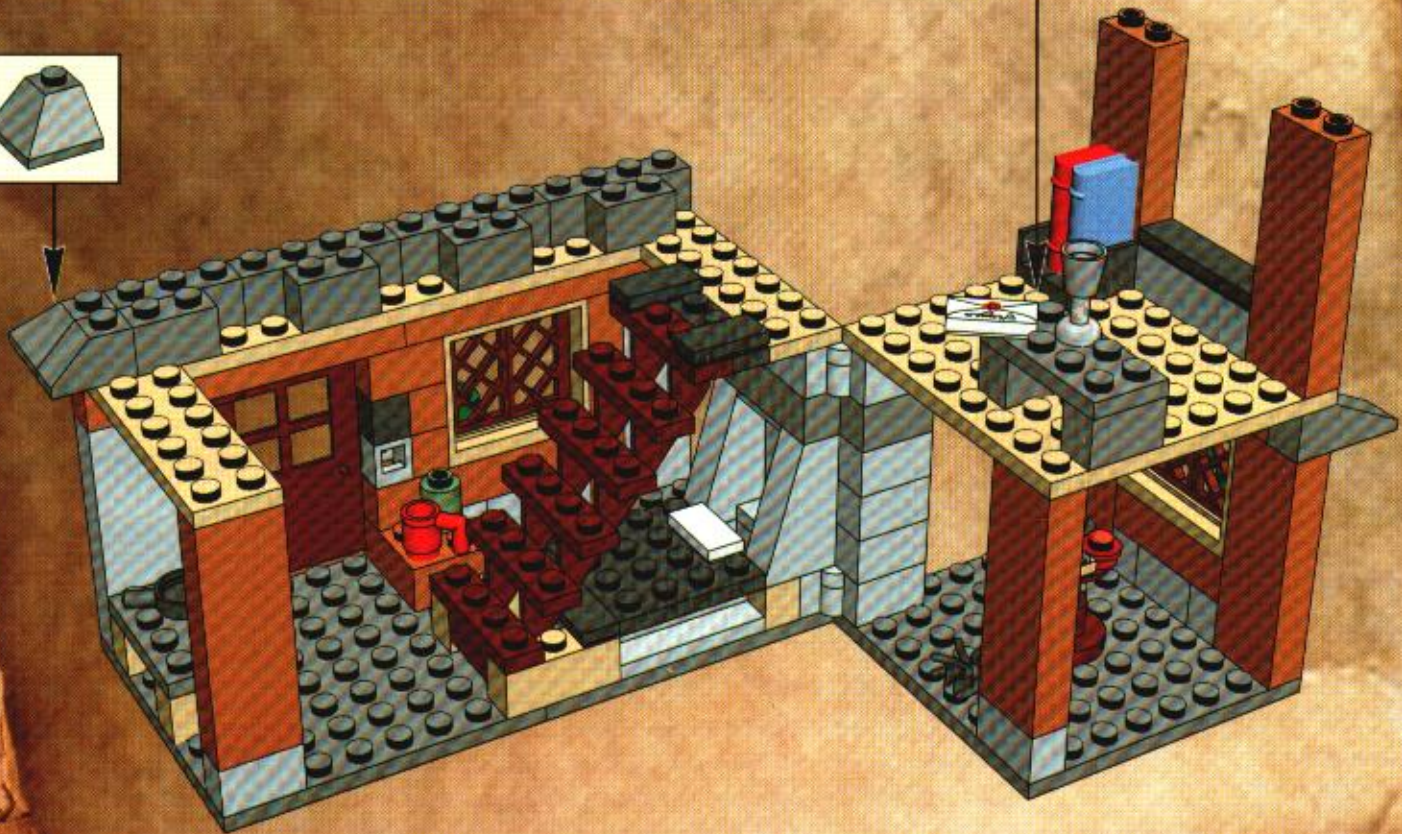
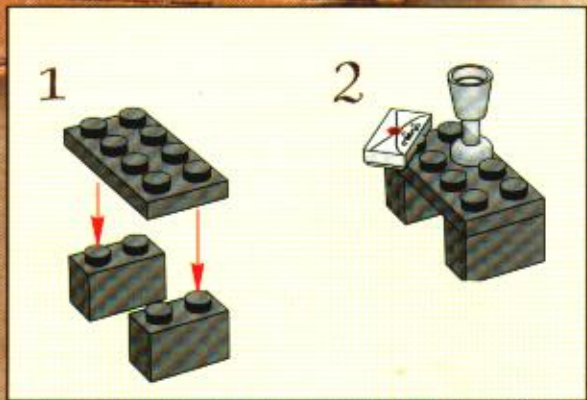

20

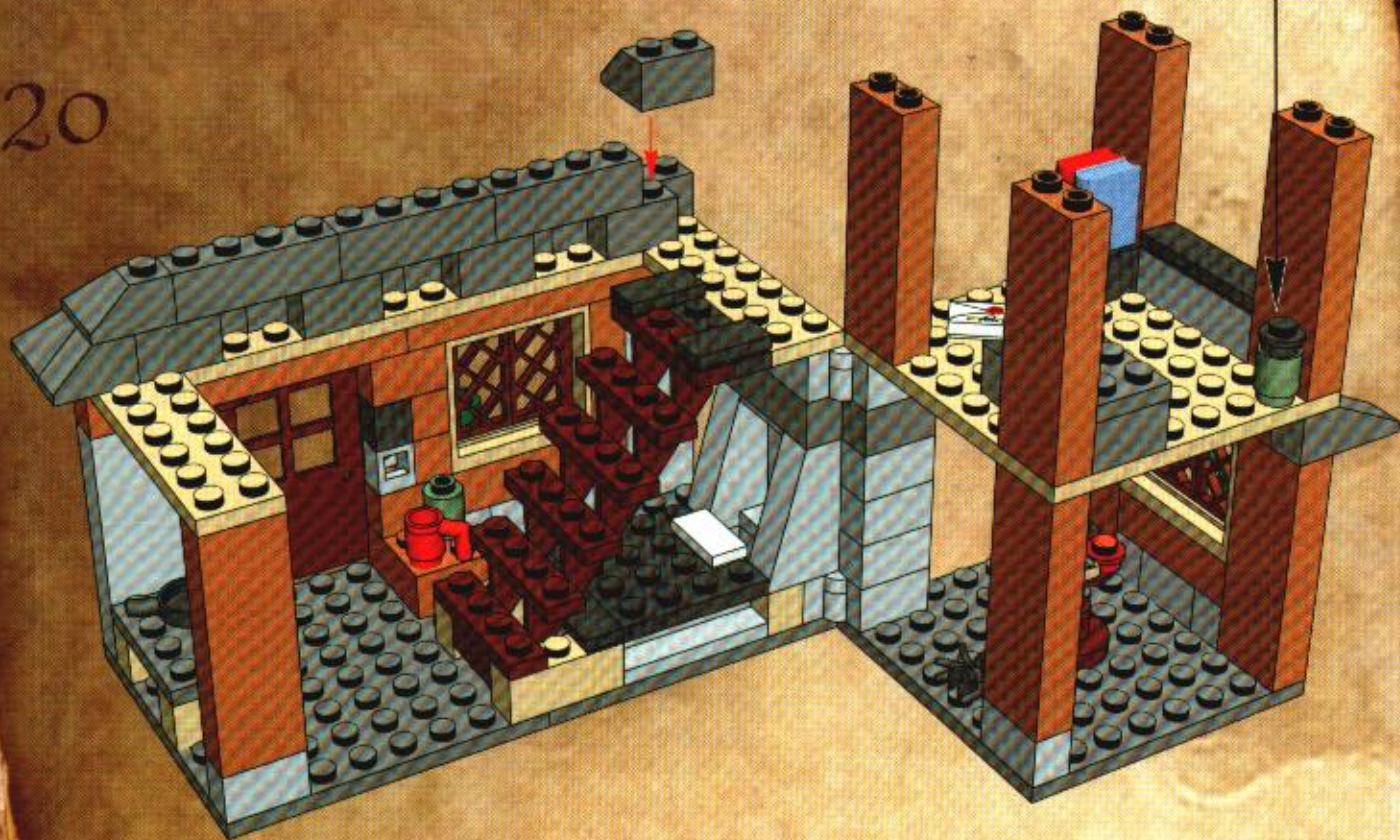

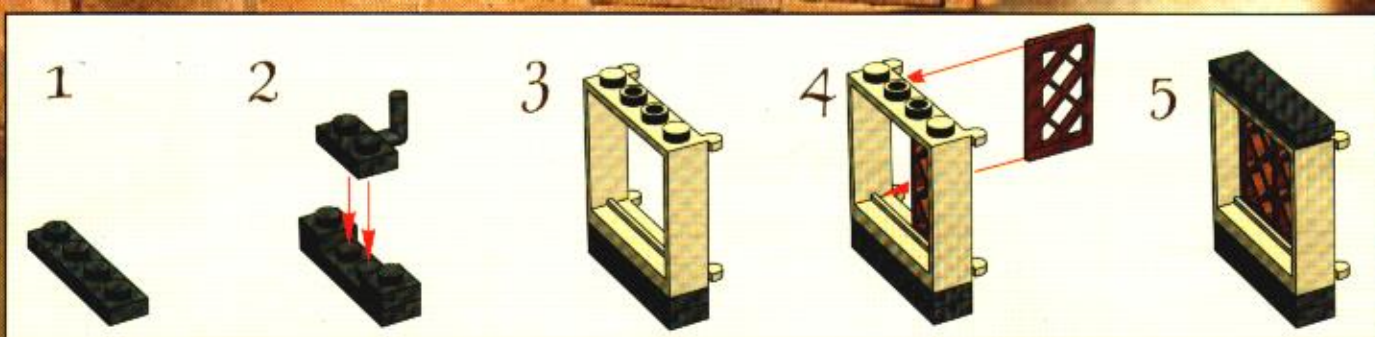

21

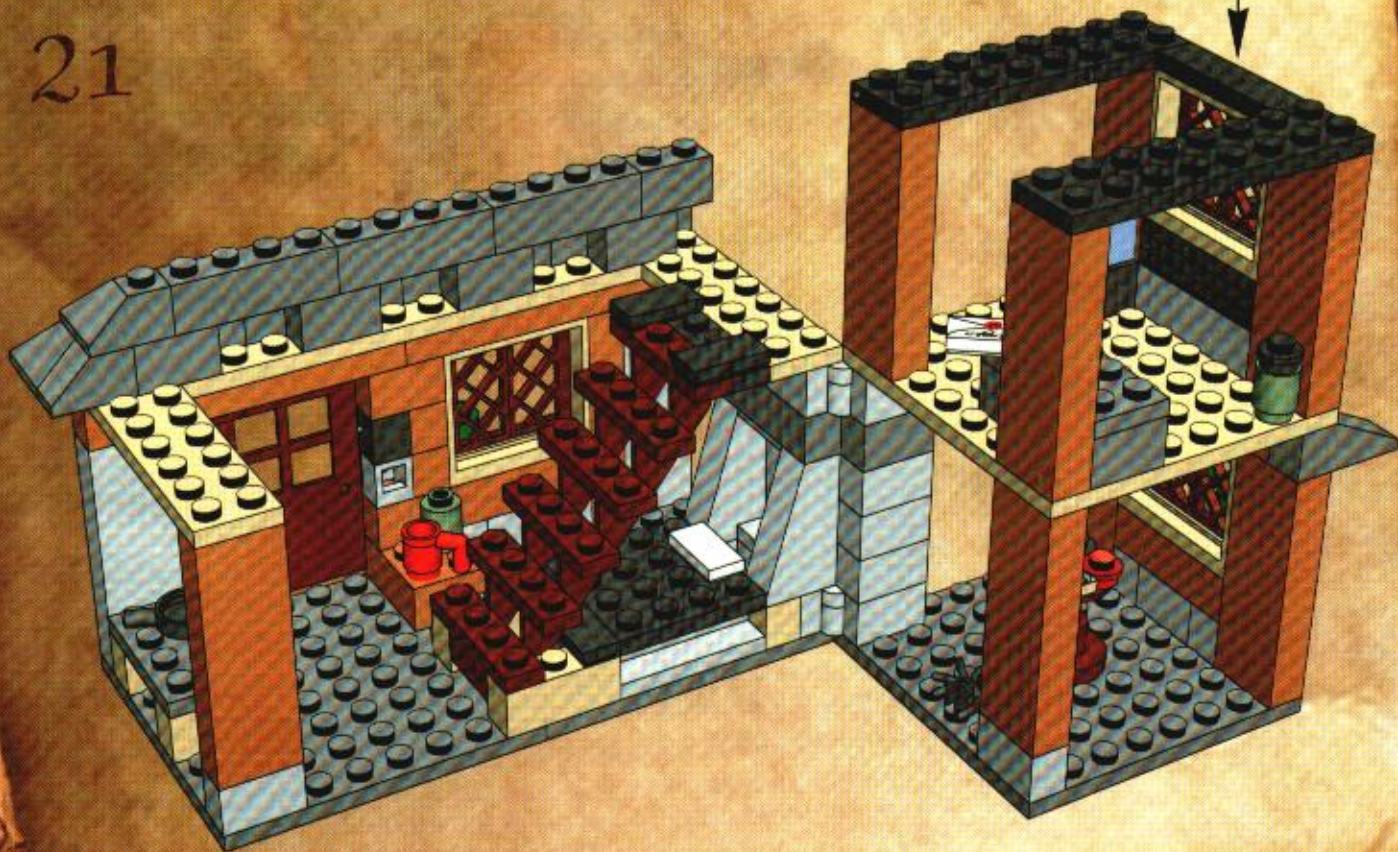

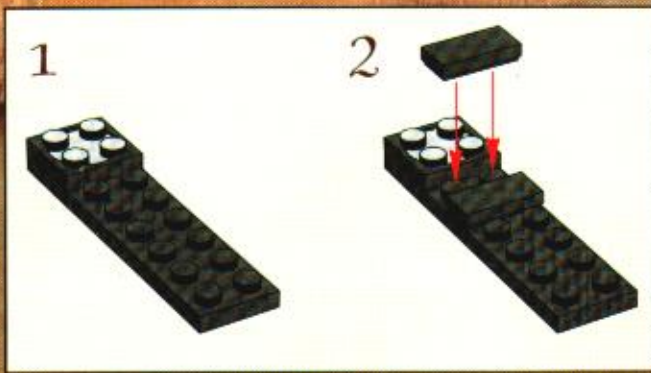

22

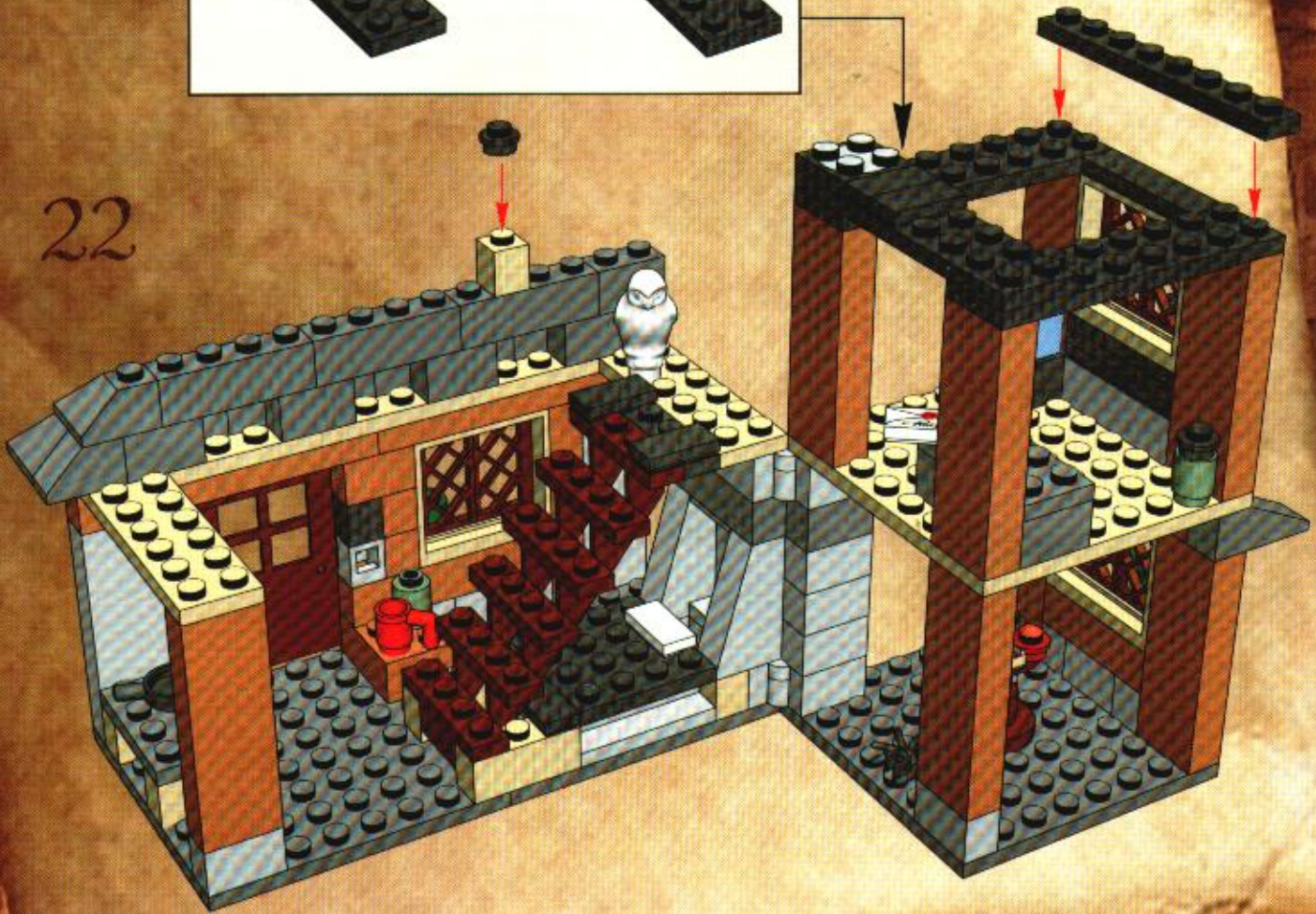

1

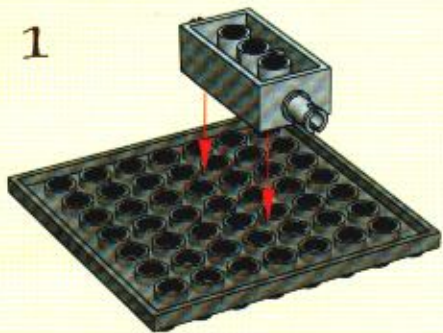

2

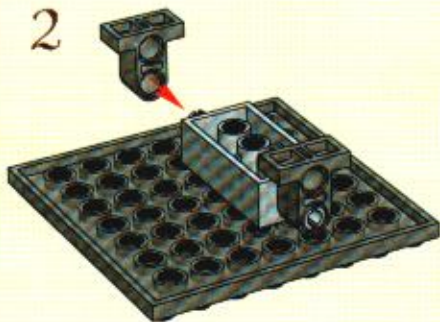

3

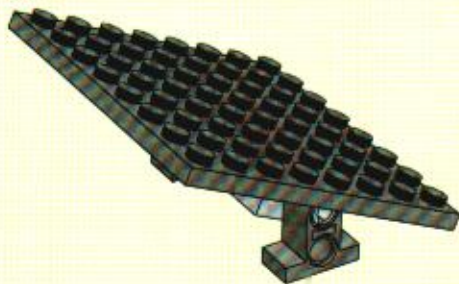

23

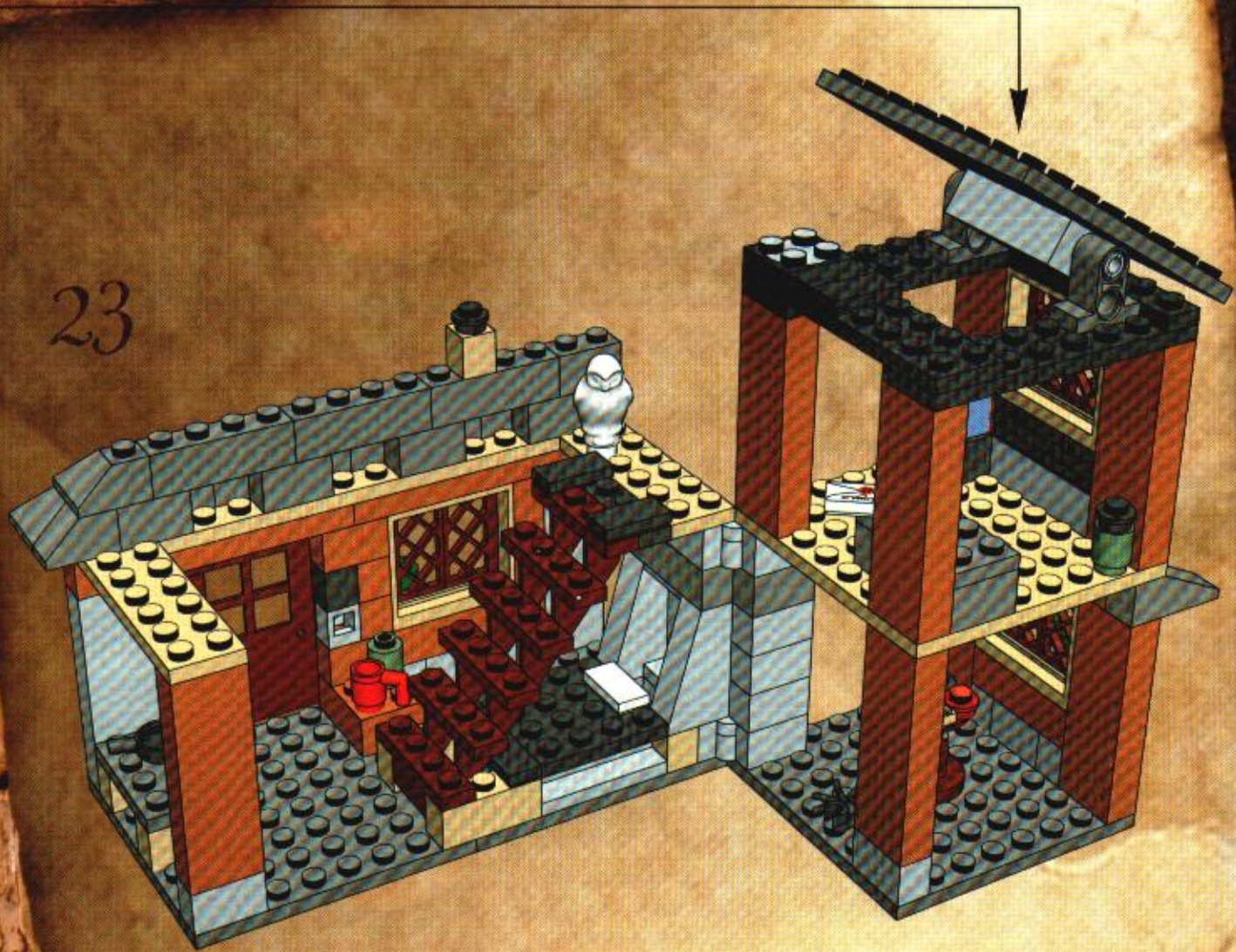

1



2



3



4



5



6



24

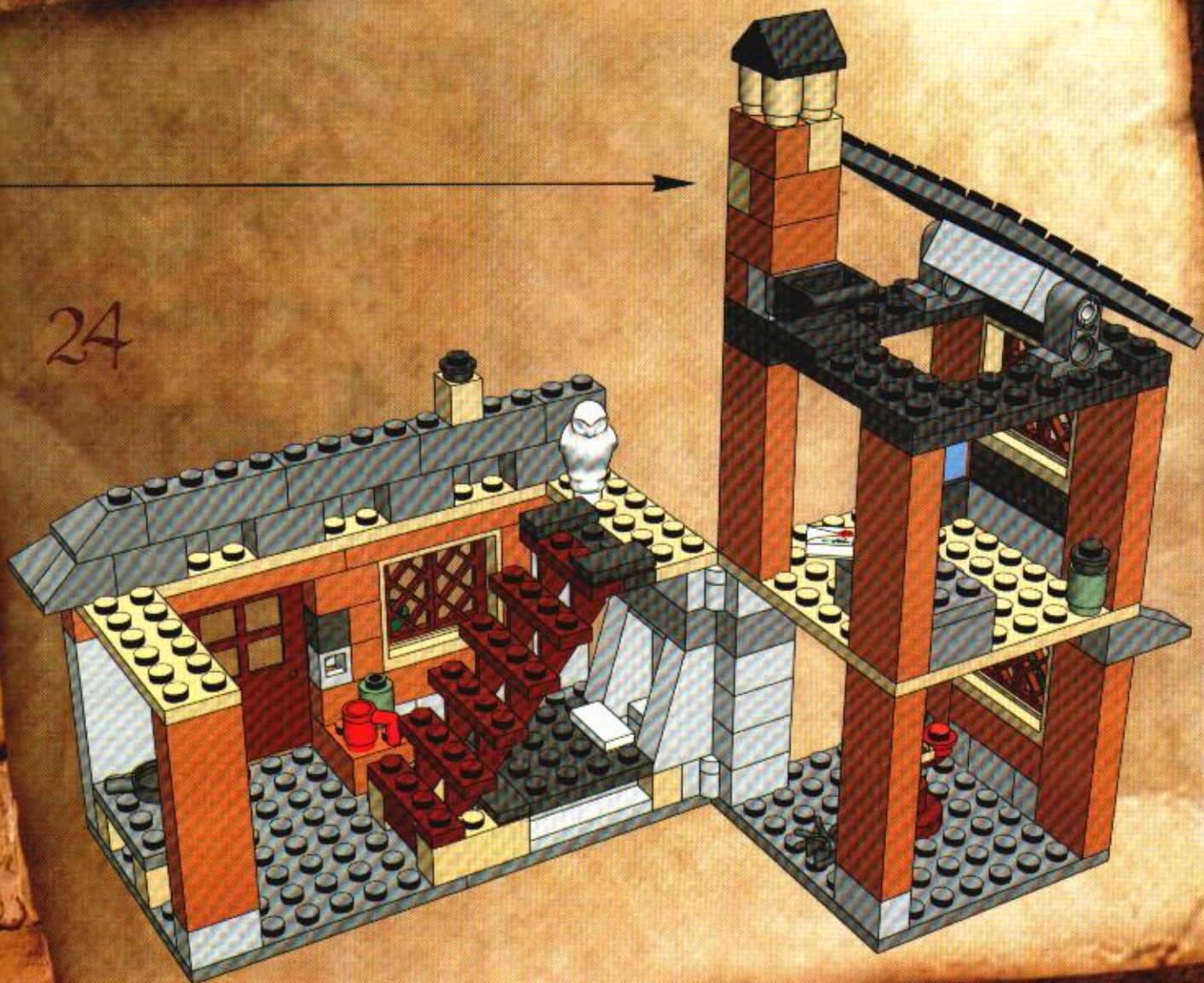

25

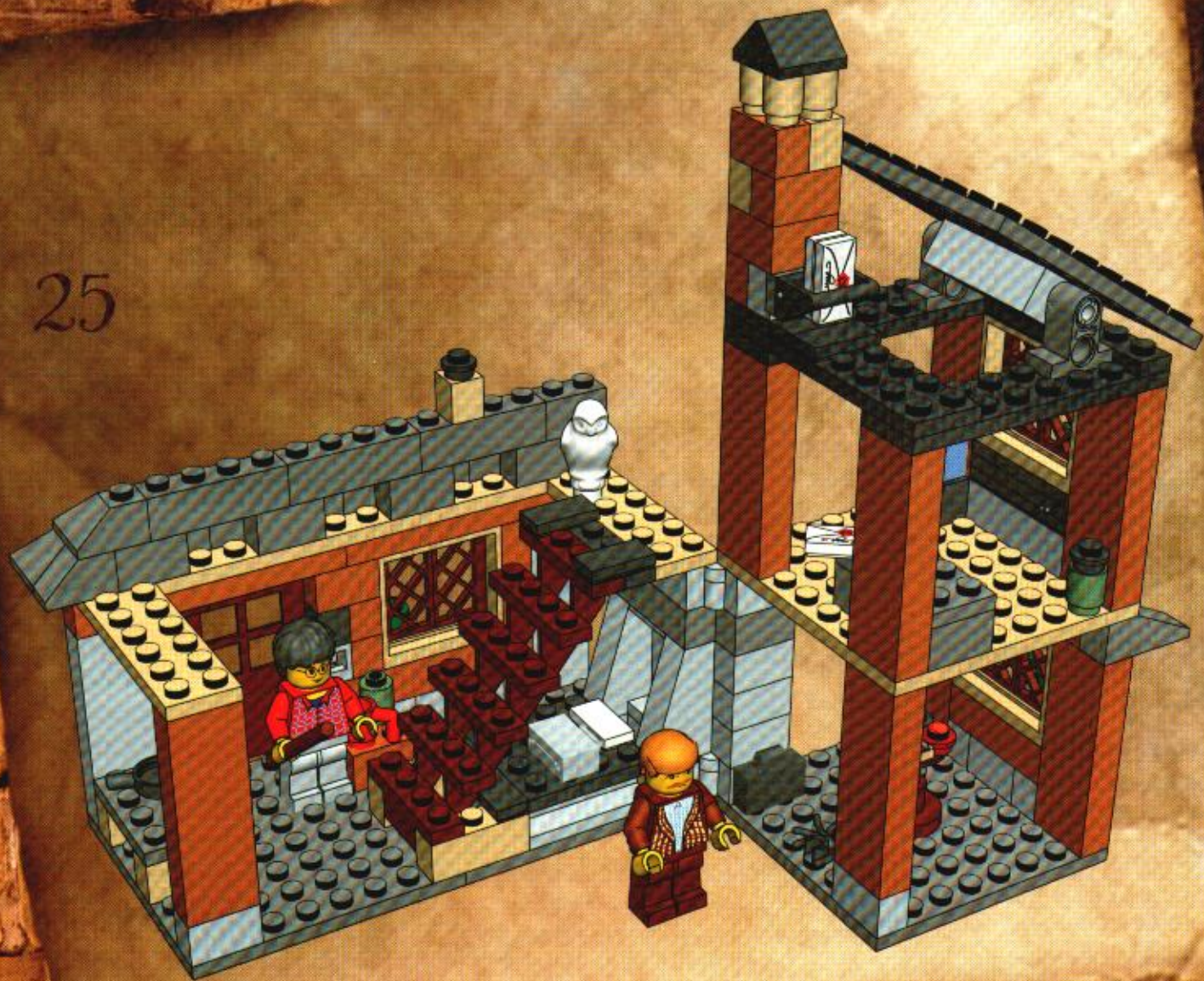

26

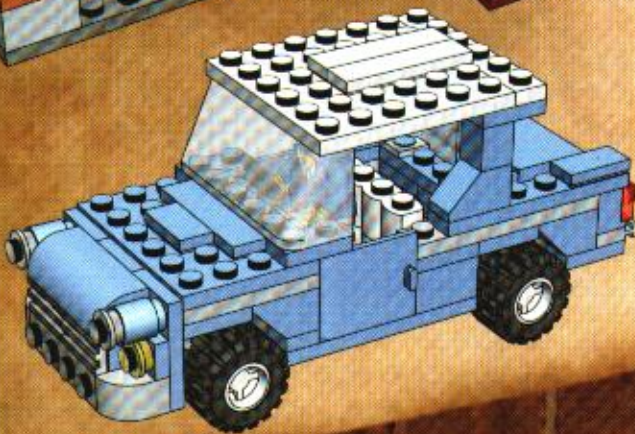
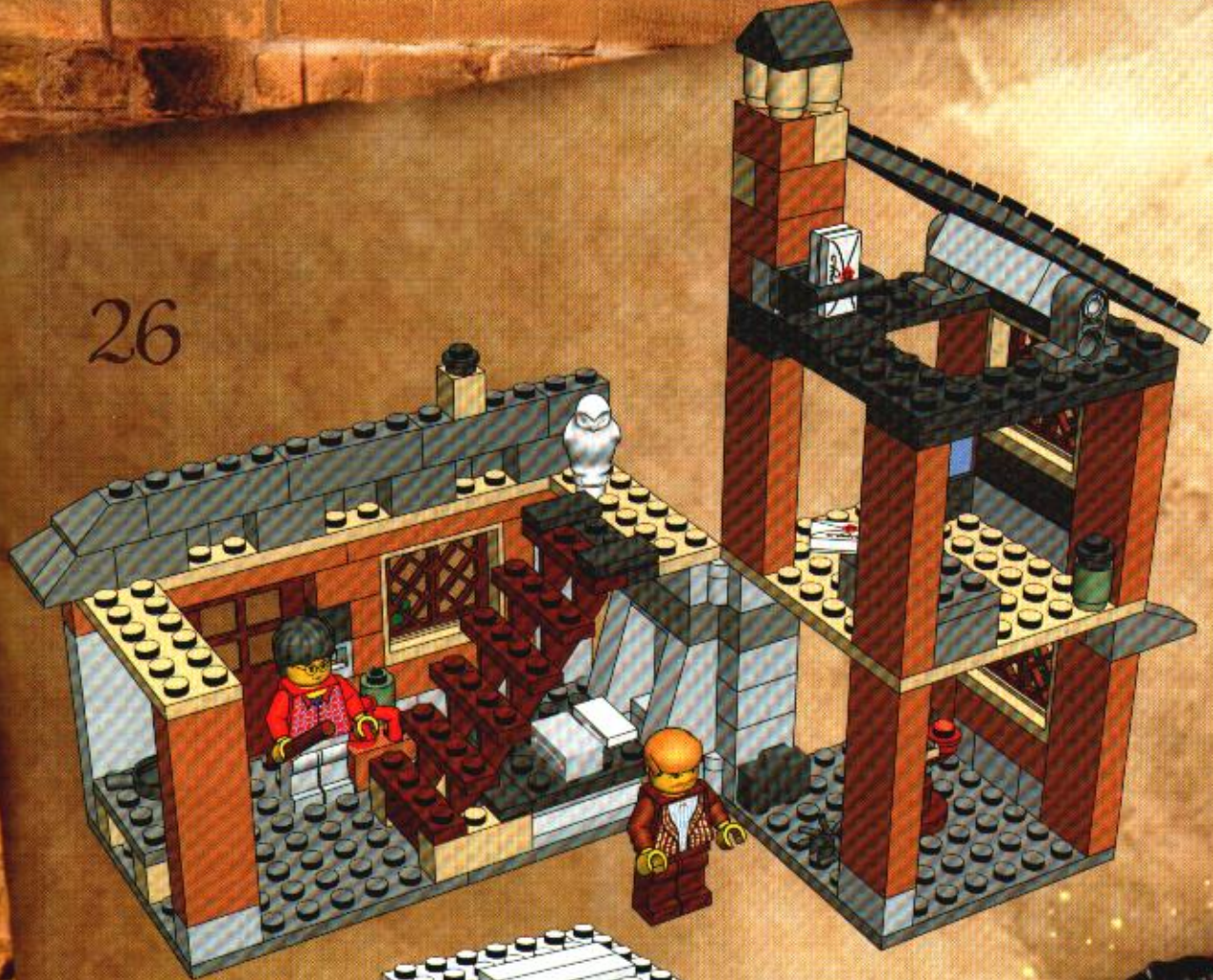

1

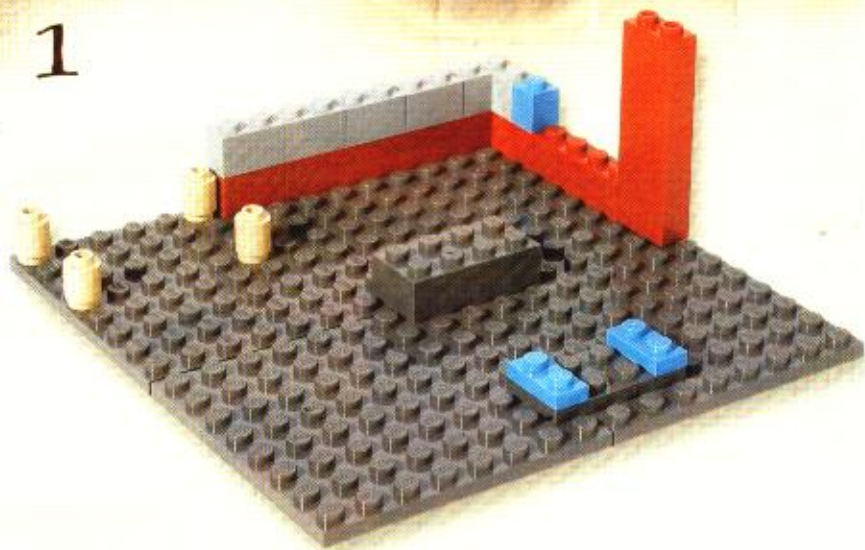

2

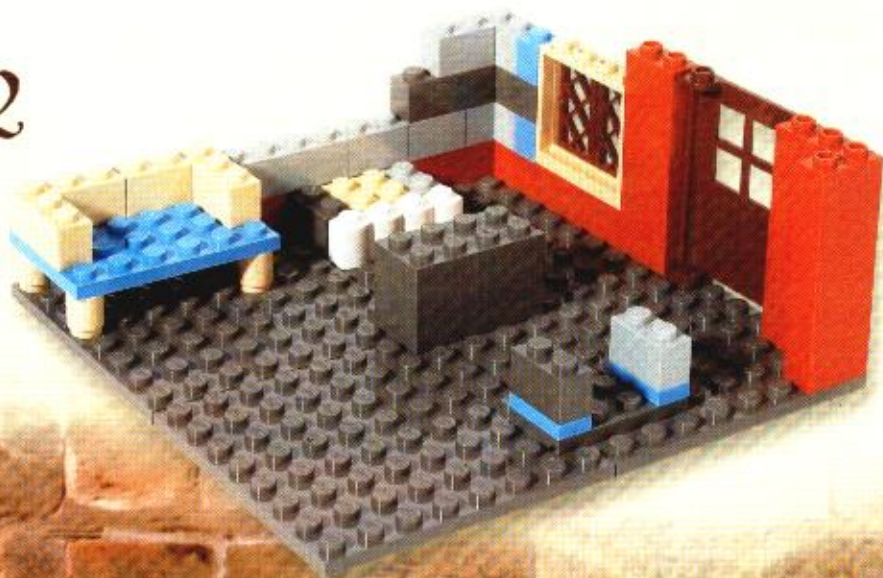

3



4



1

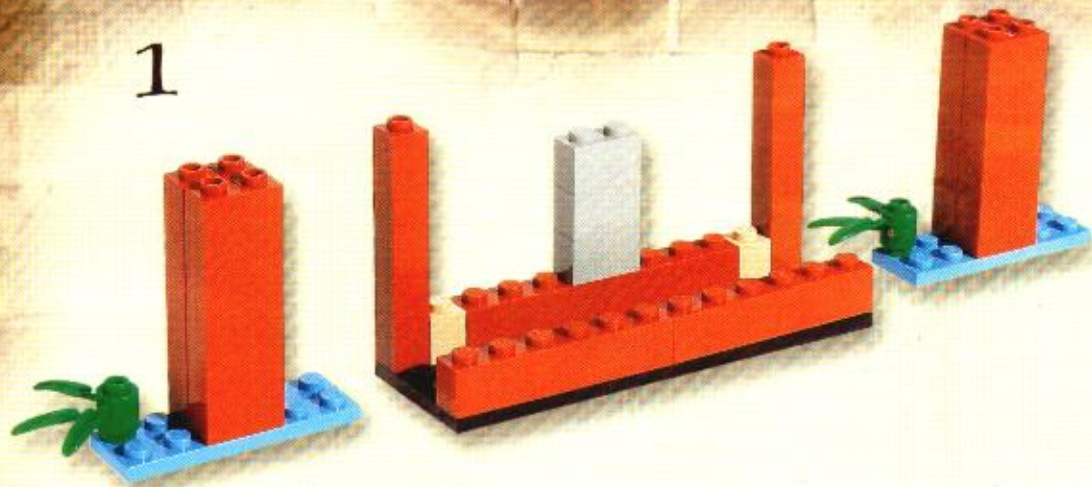

2



3



1



2

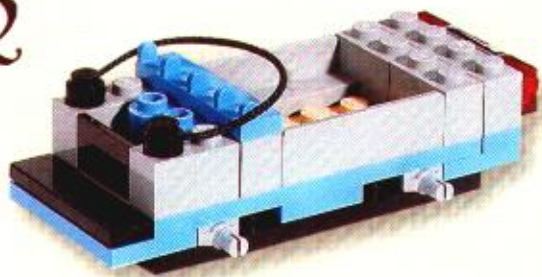

3

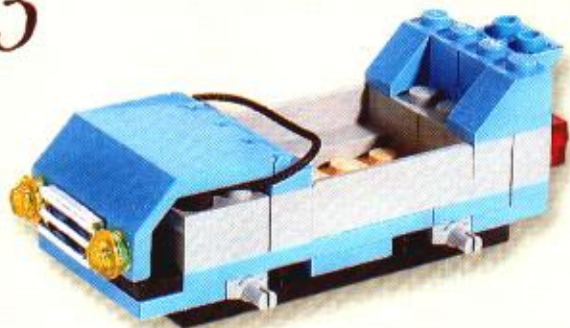

4





LEGO

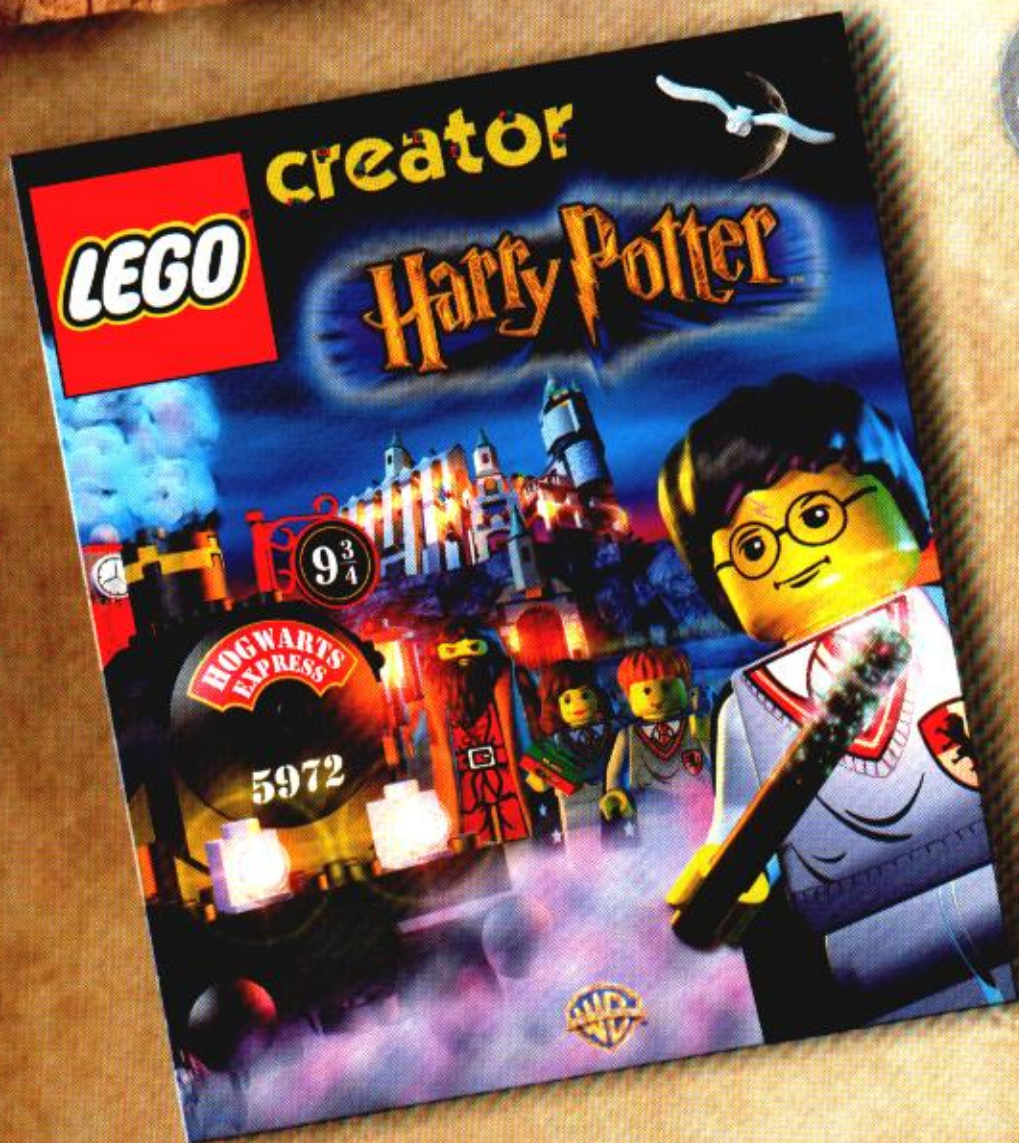

LEGO and the LEGO logo are trademarks of the LEGO Group.
©2002 The LEGO Group.

HARRY POTTER characters, names and related indicia are trademarks of
© Warner Bros.
Harry Potter Publishing Rights © J.K. Rowling.



LEGO and the LEGO logo are trademarks of the LEGO Group.
© 2002 The LEGO Group.

HARRY POTTER, characters, names and related indicia are trademarks of and © Warner Bros.

TM & © Warner Bros.

Harry Potter Publishing Rights © J.K. Rowling

© 2002



www.harrypotter.com

www.LEGO.com

JOIN THE FUN!