



# Architecture

21035

Solomon R. Guggenheim Museum®

New York City, USA



[LEGO.com/architecture/booklet](https://www.lego.com/architecture/booklet)

# Solomon R. Guggenheim Museum



Widely regarded as an exceptional icon of the 20<sup>th</sup> century, the Solomon R. Guggenheim Museum launched the great age of museum architecture and proved that a collection's physical home could be as crucial a part of the museum experience as the work itself.



# The Story of an Iconic Building

In June 1943, Frank Lloyd Wright was asked by Hilla Rebay, the art advisor to Solomon R. Guggenheim, to design a new building to house Guggenheim's four-year-old Museum of Non-Objective Painting.

The project would evolve into a complex struggle pitting the architect against his clients, city officials, the art world and public opinion. It would take over 15 years, 700 sketches and seven complete sets of working drawings before Wright's vision would be realized and the Solomon R. Guggenheim Museum would open its doors for the first time in 1959. By then both Guggenheim and Wright had died.

The location of the Guggenheim Museum on Fifth Avenue between 88<sup>th</sup> and 89<sup>th</sup> Streets is not accidental. Its proximity to Central Park was key; as close to nature as one can get in New York, the park affords relief from the noise and congestion of the city.

Nature not only provided the museum with a respite from New York's distractions, but also lent it inspiration. The Guggenheim Museum is an embodiment of Frank Lloyd Wright's attempts to utilize organic forms in architecture.

But even as it embraced nature, Wright's design also expresses his unique take on modernist architecture's rigid geometry. The building is a symphony of triangles, ovals, arcs, circles and squares.

Wright dispensed with the conventional approach to museum design, which led visitors through a series of interconnected rooms. Instead, he whisked people to the top of the building via elevator and led them downward at a leisurely pace on the gentle slope of a continuous ramp. The open rotunda afforded viewers the unique possibility of seeing several bays of work on different levels simultaneously.

The building itself has often been called the most important piece of art in the Guggenheim collection.

*[ "An idea is salvation  
by imagination" ]*

Frank Lloyd Wright



THE SOLOMON R. GUGGENHEIM M U

## The Story Continues

When the museum opened to an enthusiastic public on October 21, 1959, just six months after Frank Lloyd Wright's death, the relationship between the breathtaking architecture of the building and the art it was built to display inspired both controversy and debate. One critic wrote that the museum "turned out to be the most beautiful building in America... never for a minute dominating the pictures being shown," while another insisted that the structure was "less a museum than a monument to Frank Lloyd Wright."

Wright had originally suggested the construction of a tall building behind the museum itself to house its administration and provide the perfect backdrop to his structure, but it would be 1992 before this was finally achieved.

Today the Guggenheim collection has grown substantially and is now shared with other sister museums around the world. The New York museum, however, remains the spiritual home of the collection and receives over one million visitors every year.





## About the Architect

Arguably America's greatest architect and among the world's most gifted, Frank Lloyd Wright was also a man of boundless energy. In a career that spanned over 74 years, he designed more than 900 works – including houses, offices, churches, schools, libraries, bridges, museums and many other building types. Of that total, over 500 resulted in completed works. Today, over 400 of these buildings still remain.

Wright's creative mind was not only confined to architecture. He also designed furniture, fabrics, art glass, lamps, dinnerware, silver, linens and graphic arts. In addition, he was a prolific writer, an educator and a philosopher. He authored twenty books and countless articles and lectured throughout the United States, as well as in Europe.

Wright was born in 1867 in the rural farming town of Richland Center, Wisconsin, just two years after the American Civil War ended, and passed away at the age of 91 in 1959. While there is evidence of Wright attending both high school and the University of Wisconsin-Madison, there is no record of him graduating from either. In 1887 Wright moved to Chicago and by the early 1890s he was already head draftsman at the architectural firm of Adler & Sullivan.

Wright was recognized as a brilliant architect by his peers and continues to be revered today. No other architecture took greater advantage of setting and environment. No other architect glorified the sense of "shelter" as did Frank Lloyd Wright. As he famously stated: "A building is not just a place to be. It is a way to be."





# Facts

Architect: ..... Frank Lloyd Wright  
Classification: ..... Art Museum  
Location: ..... New York City, New York, USA  
Architectural Style: ..... Modern Movement  
Height: ..... 92 ft. (28 m)  
Materials: ..... Aluminum, Steel, Concrete  
and Glass  
Year: ..... 1943-1959

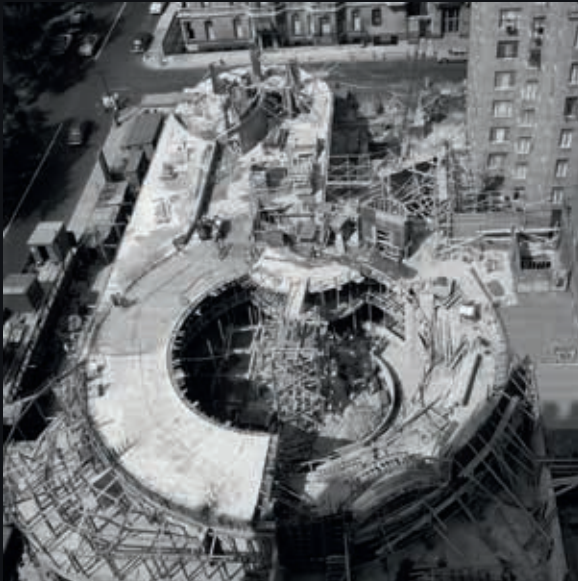

©The Solomon R. Guggenheim Foundation, New York



©The Solomon R. Guggenheim Foundation, New York



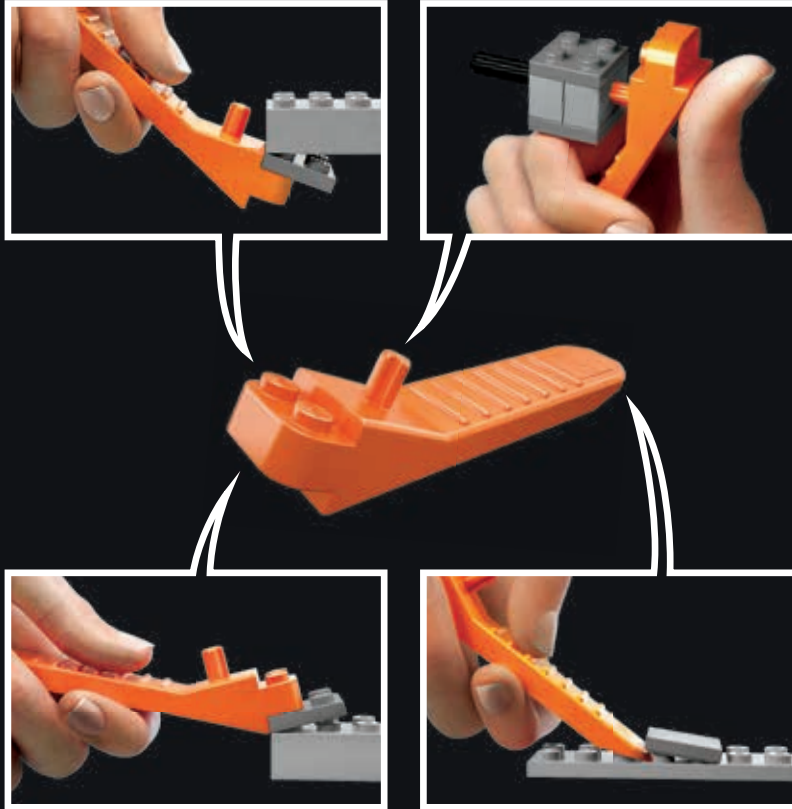

[LEGO.com/brickseparator](https://LEGO.com/brickseparator)

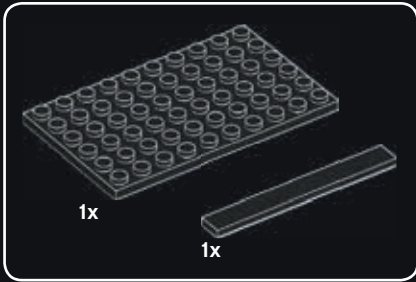
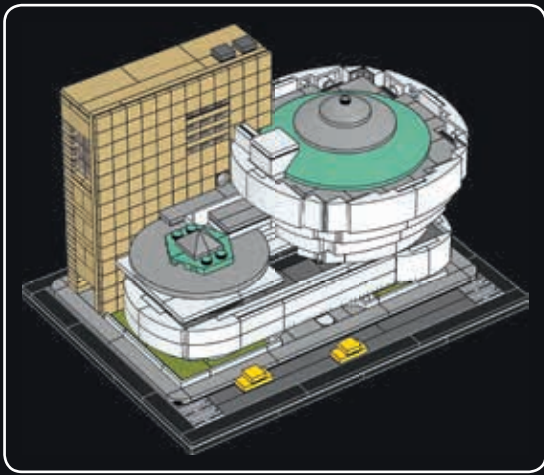

1

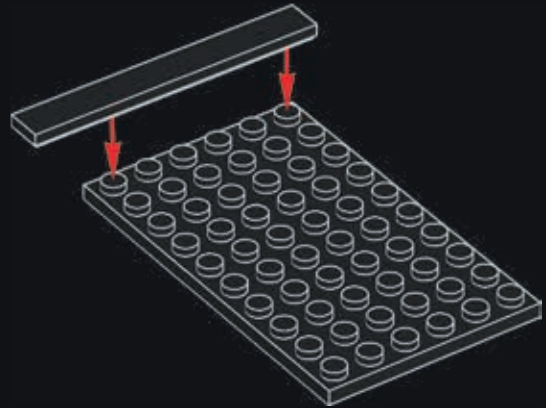

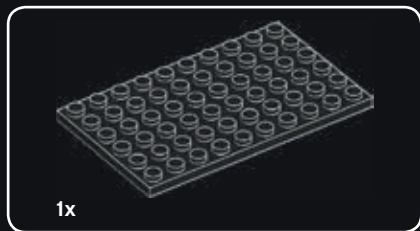

2

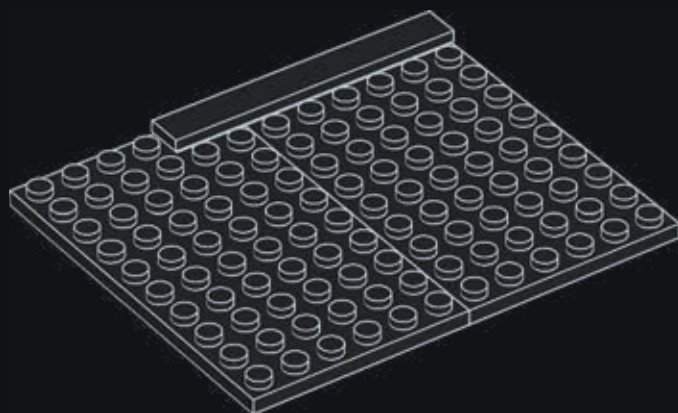



**3**

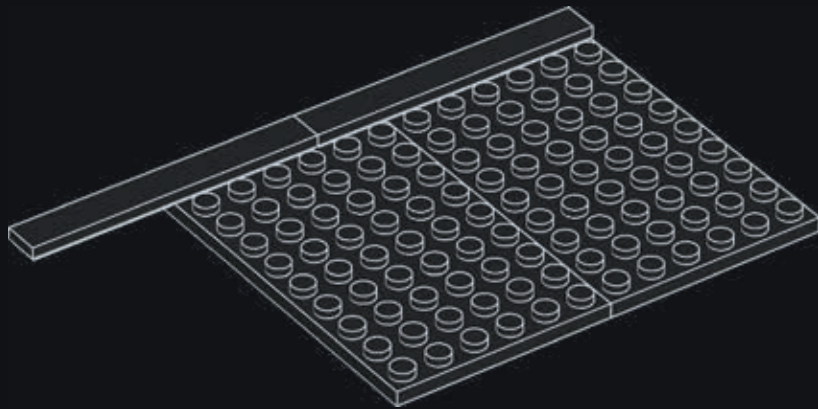

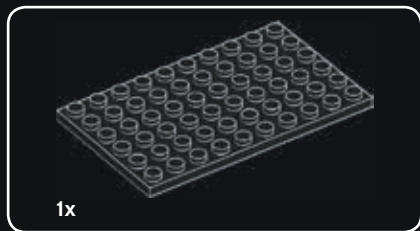

4

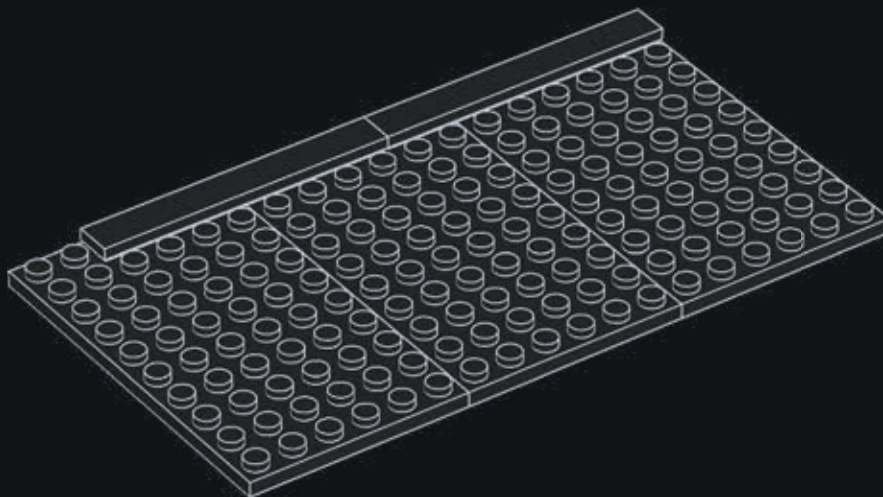





5

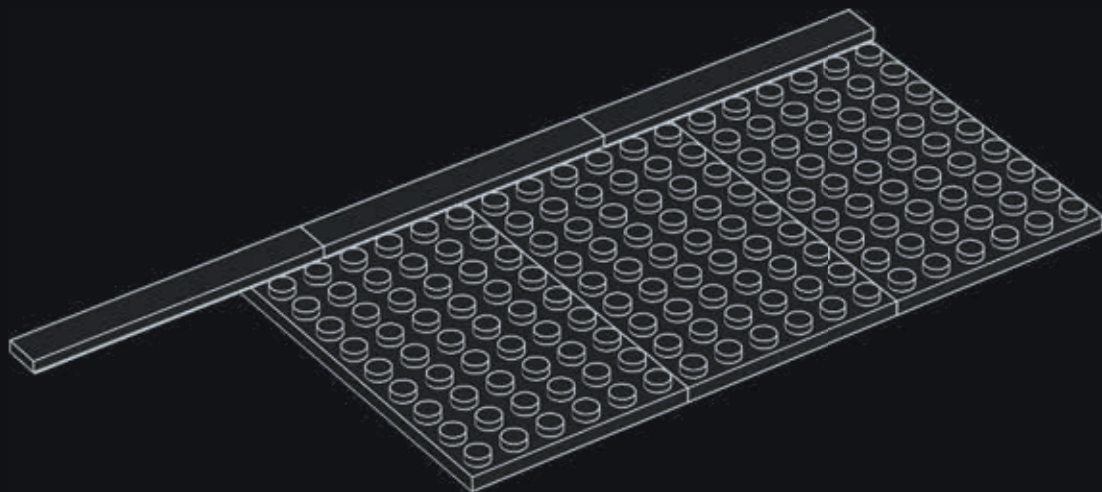

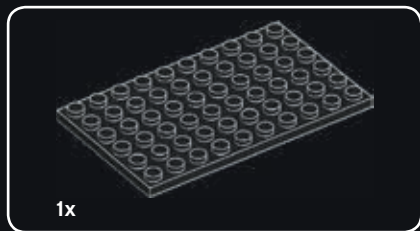

6

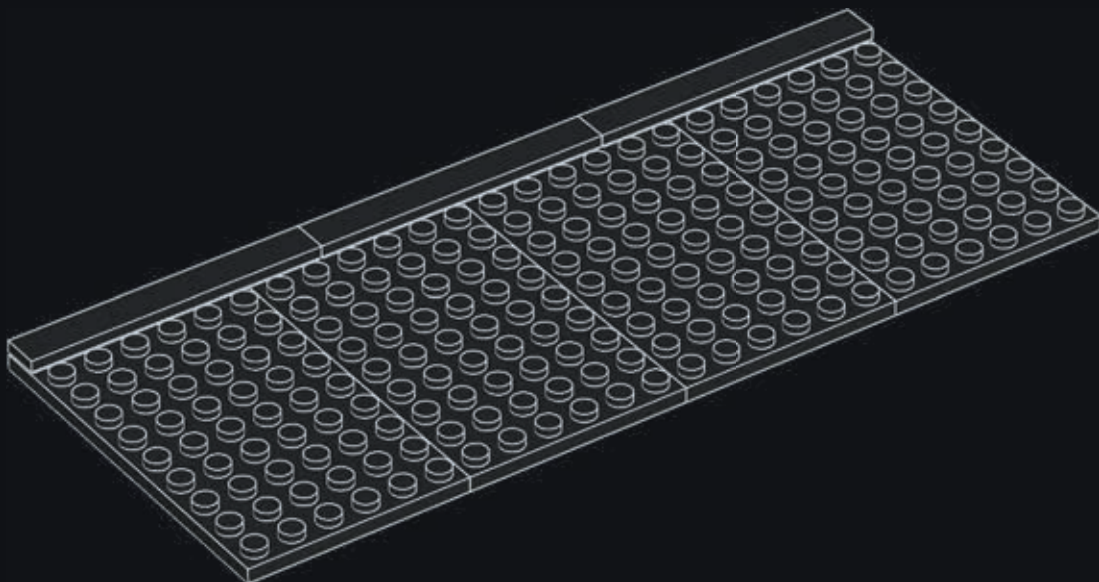

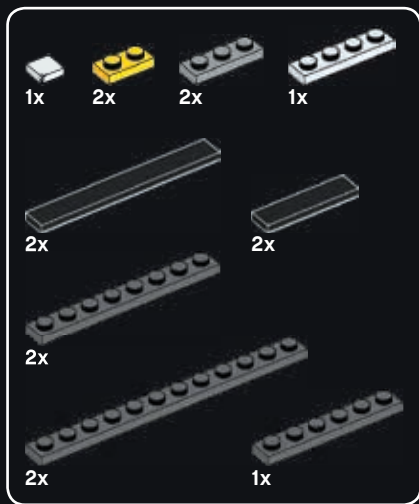

7

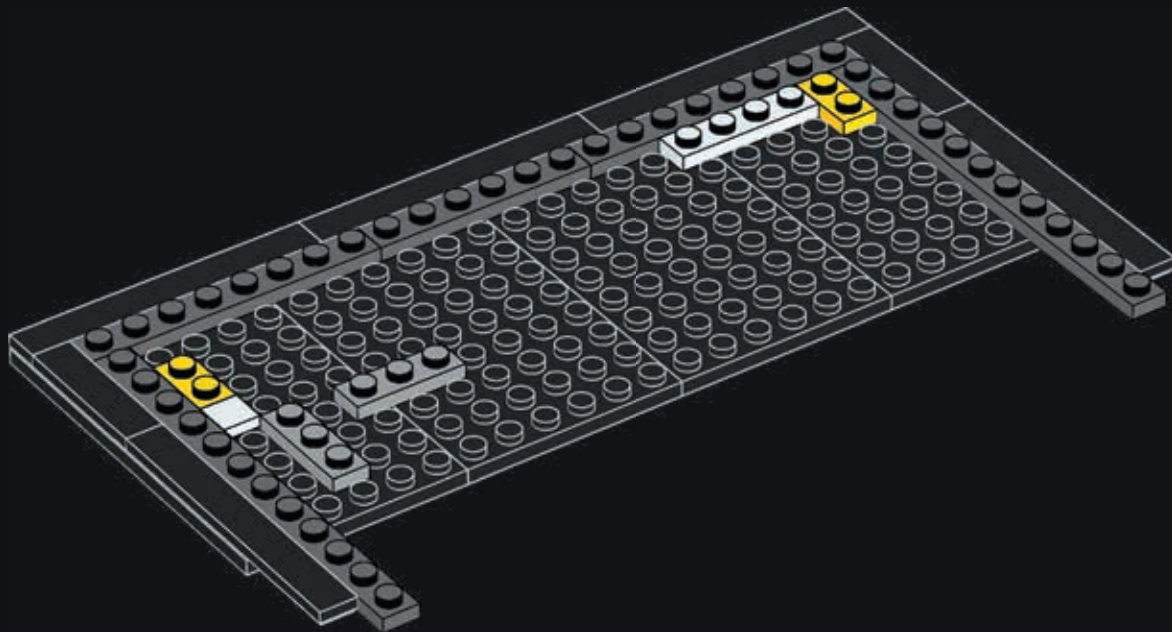

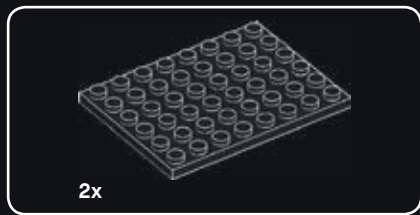

8

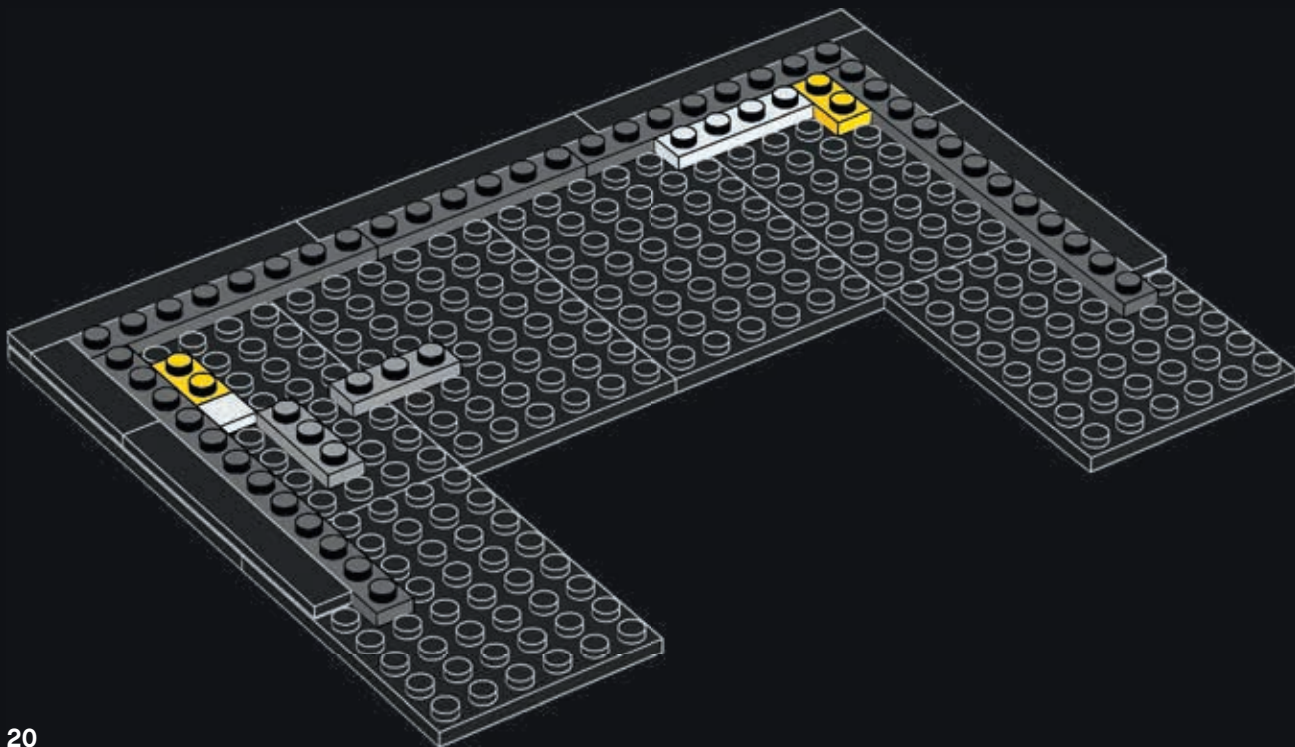

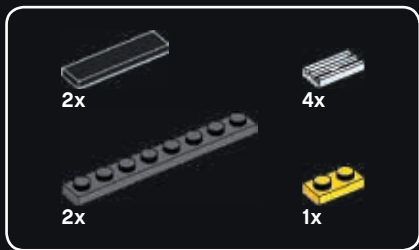

9

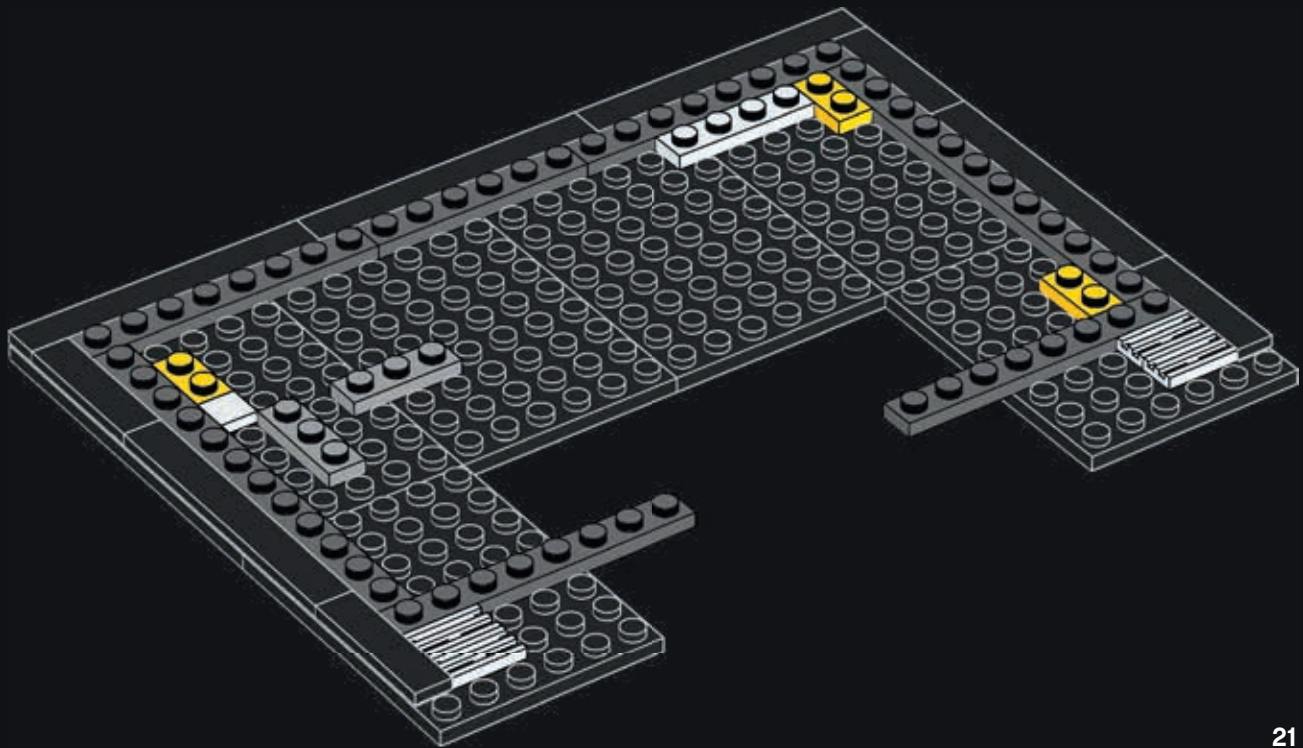

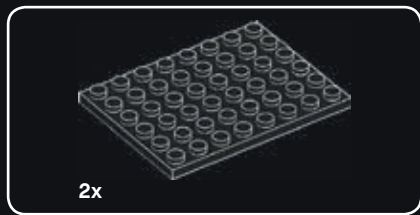

10

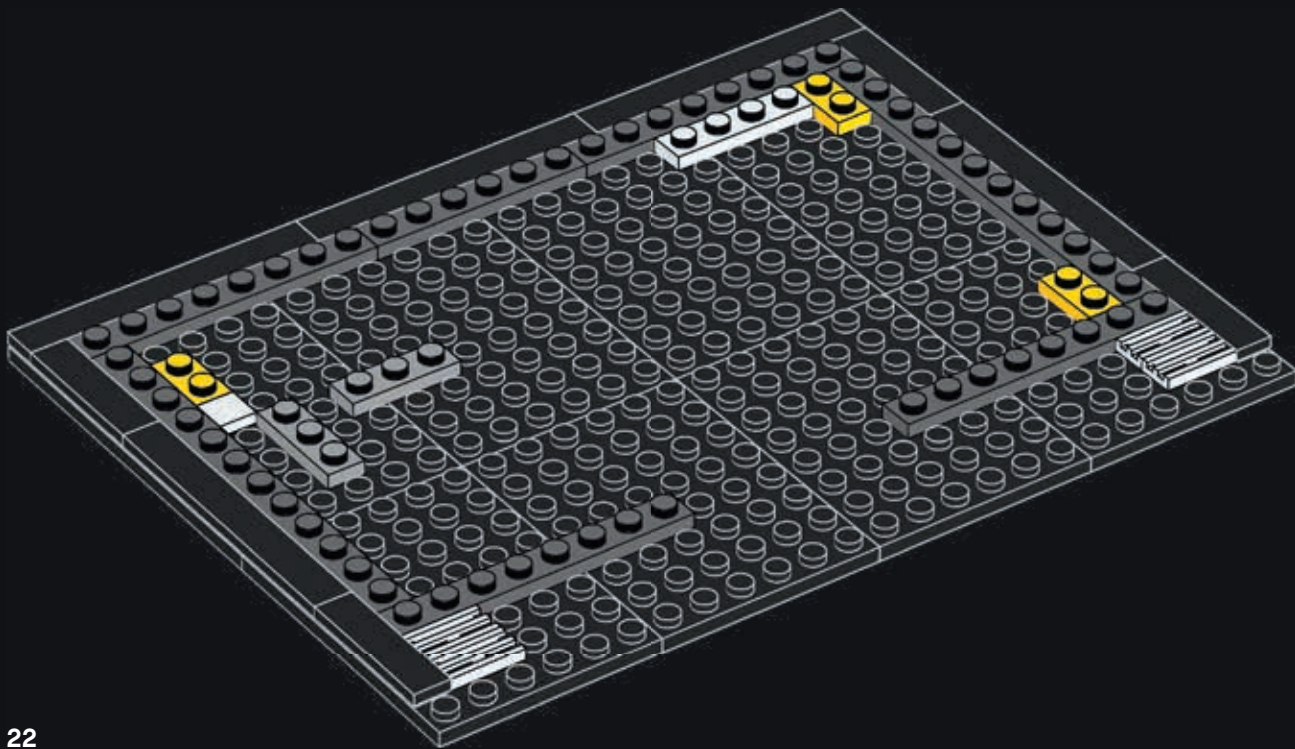

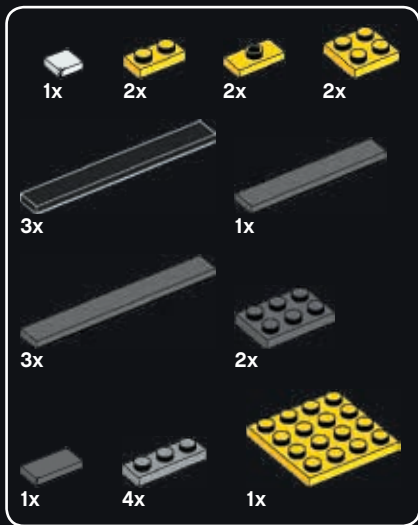

Frank Lloyd Wright insisted on designing every detail in the Guggenheim Museum, right down to the chairs and elevators.



11

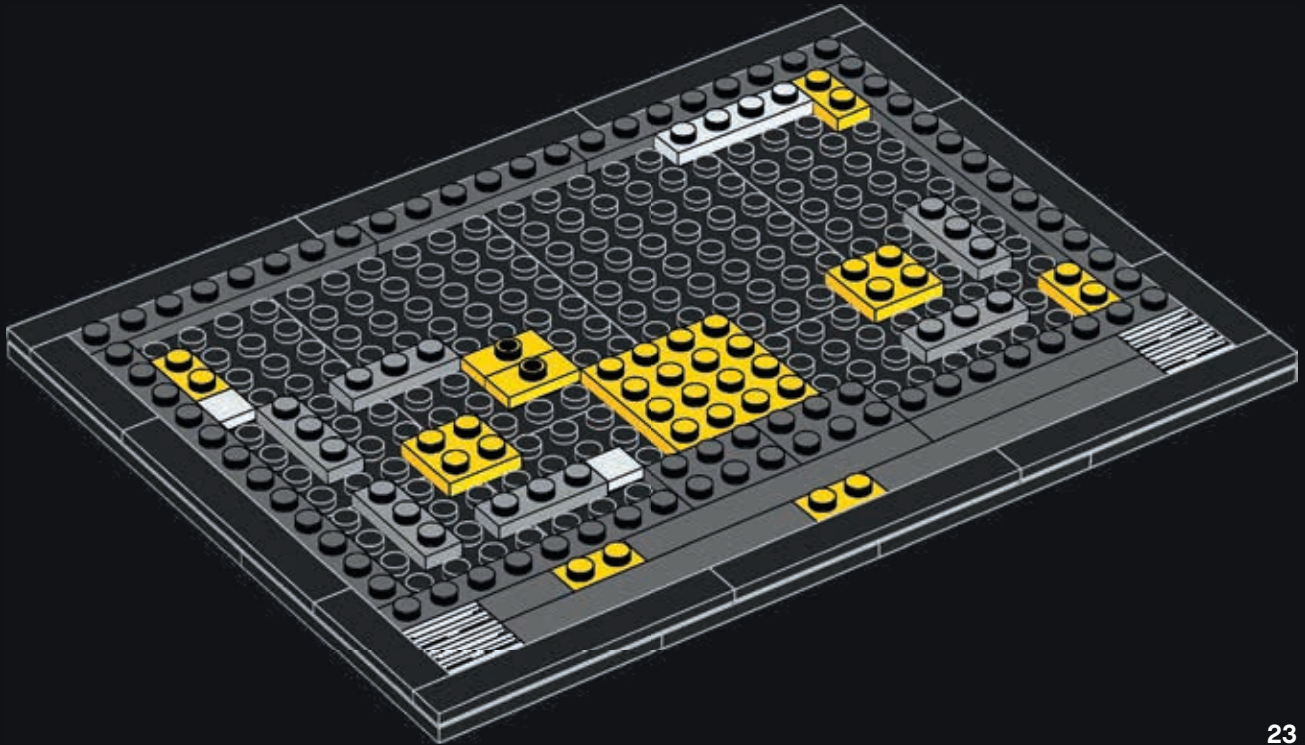

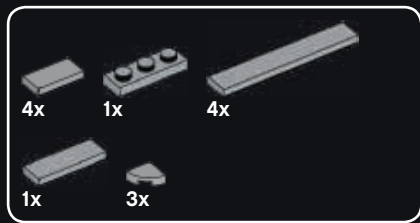

12

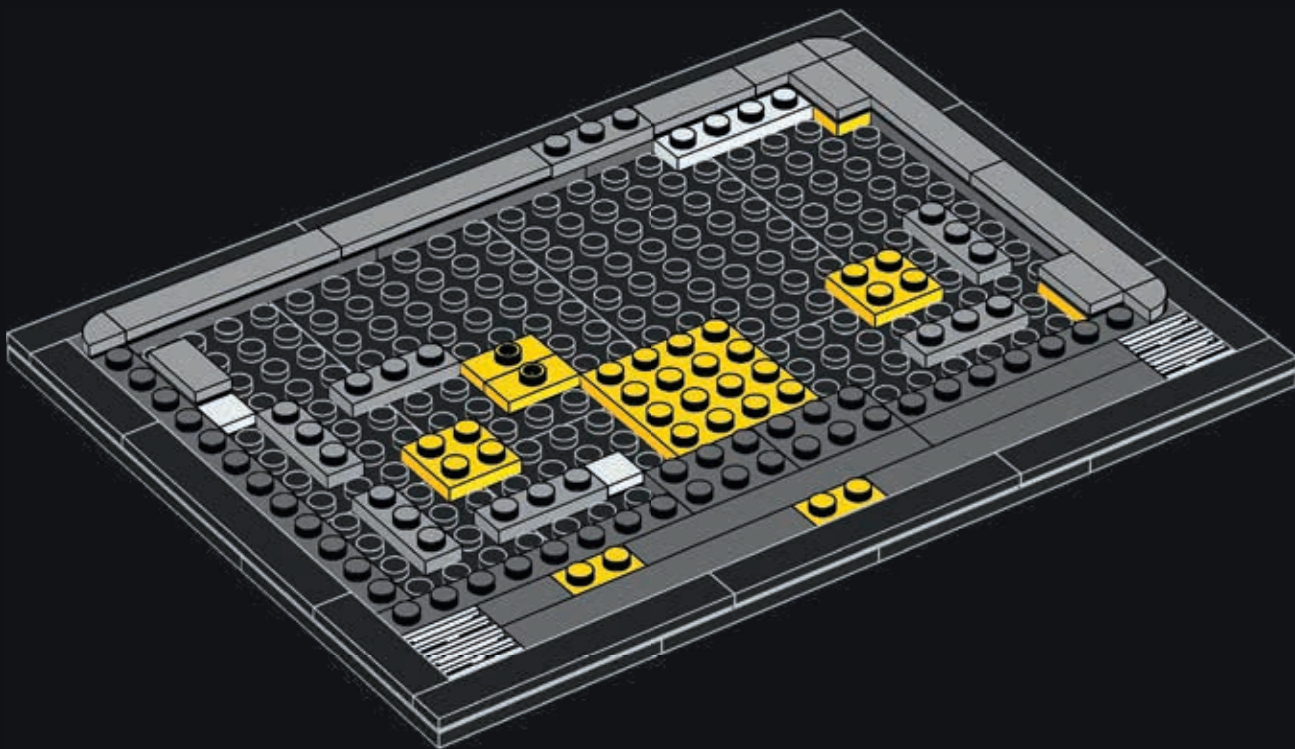



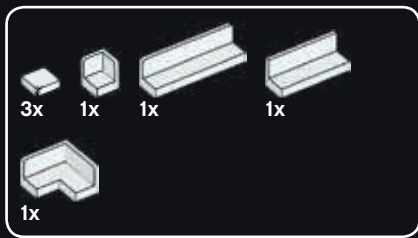

13

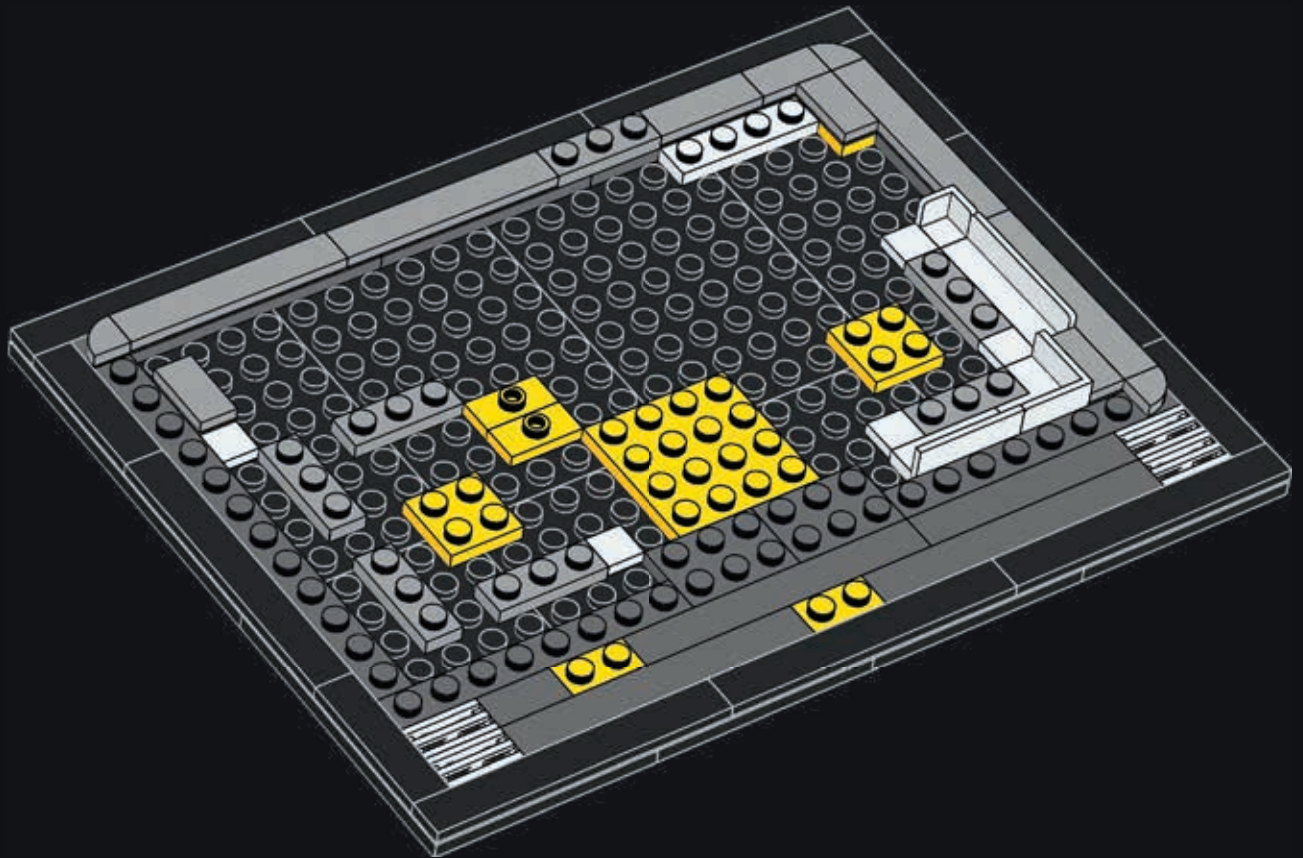



2x

14

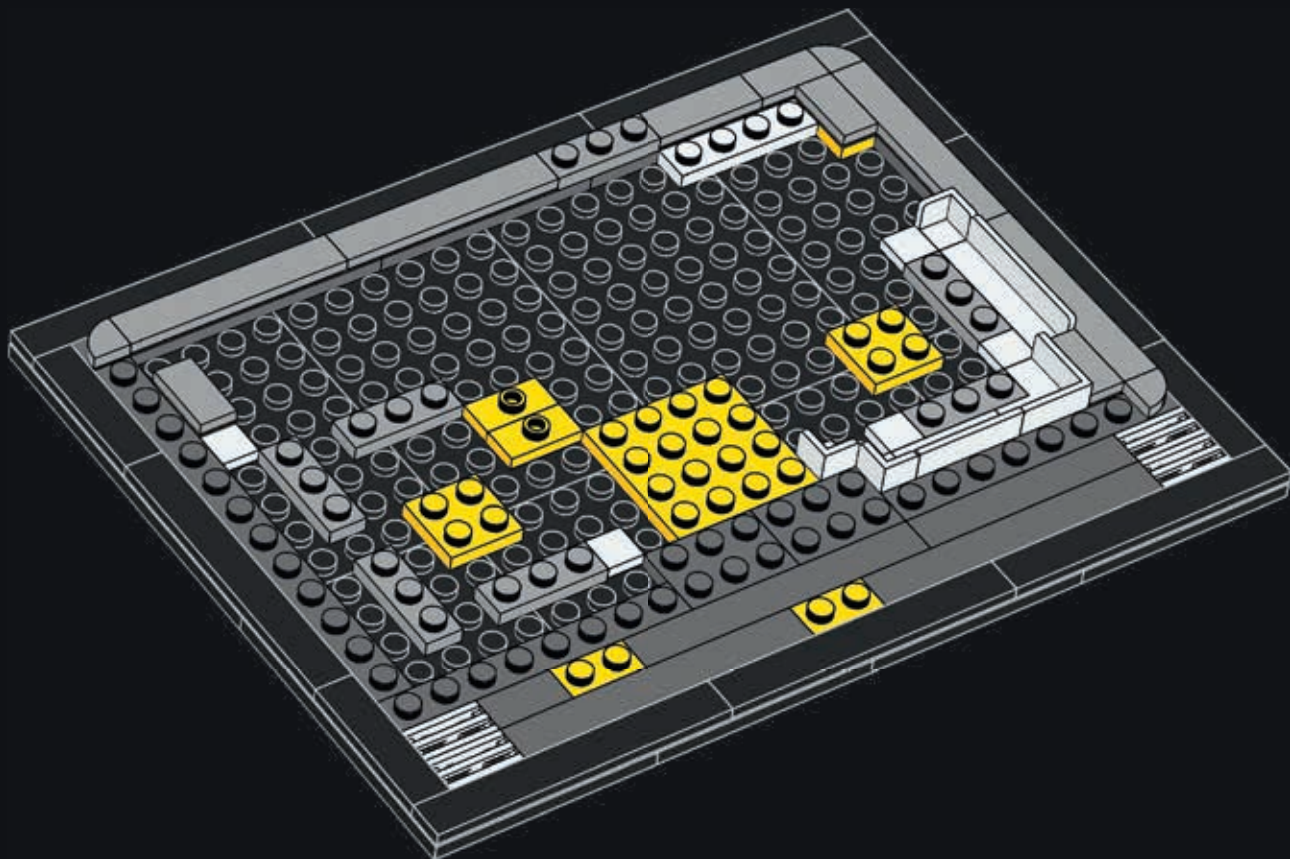



4x

15

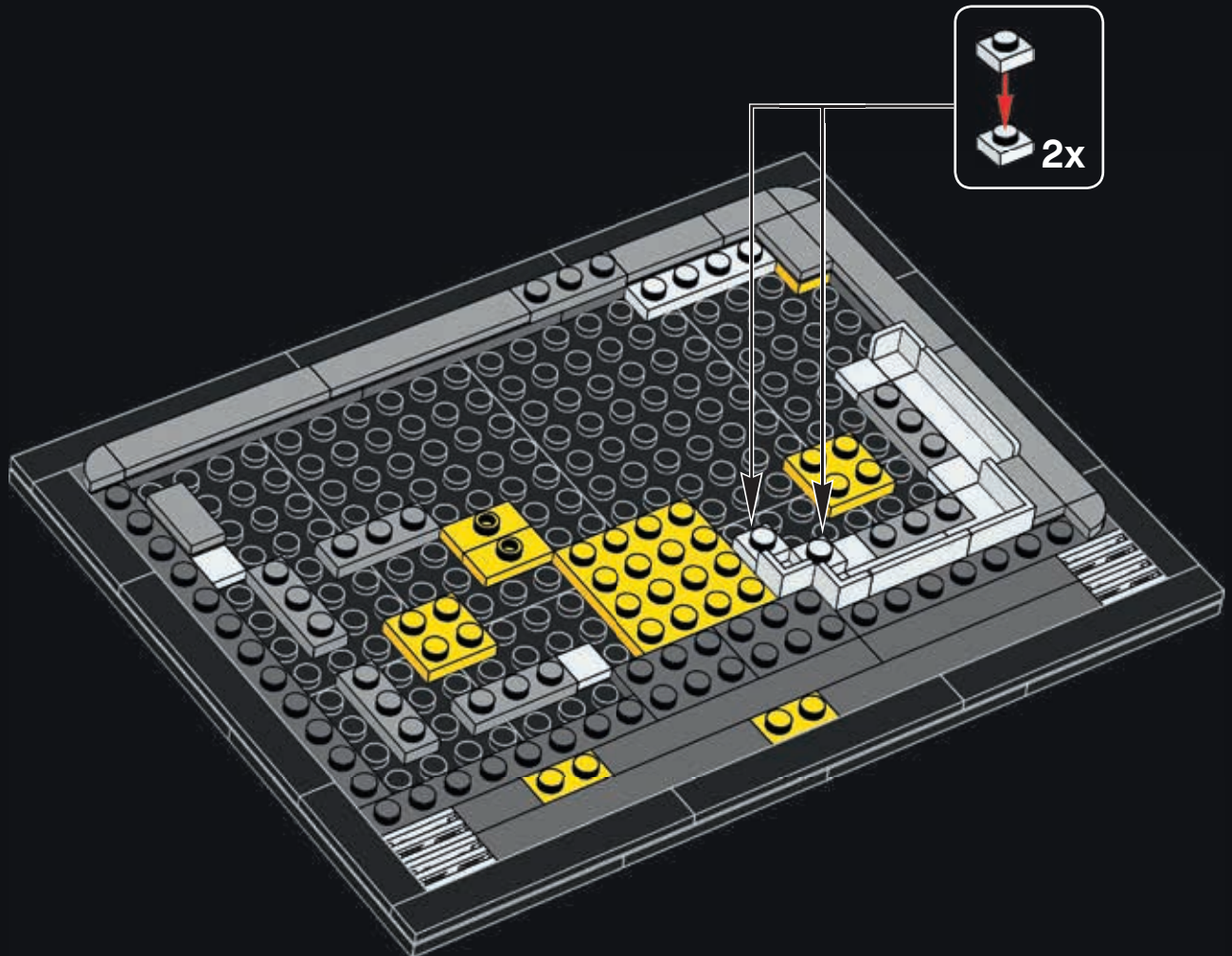

2x



# 16

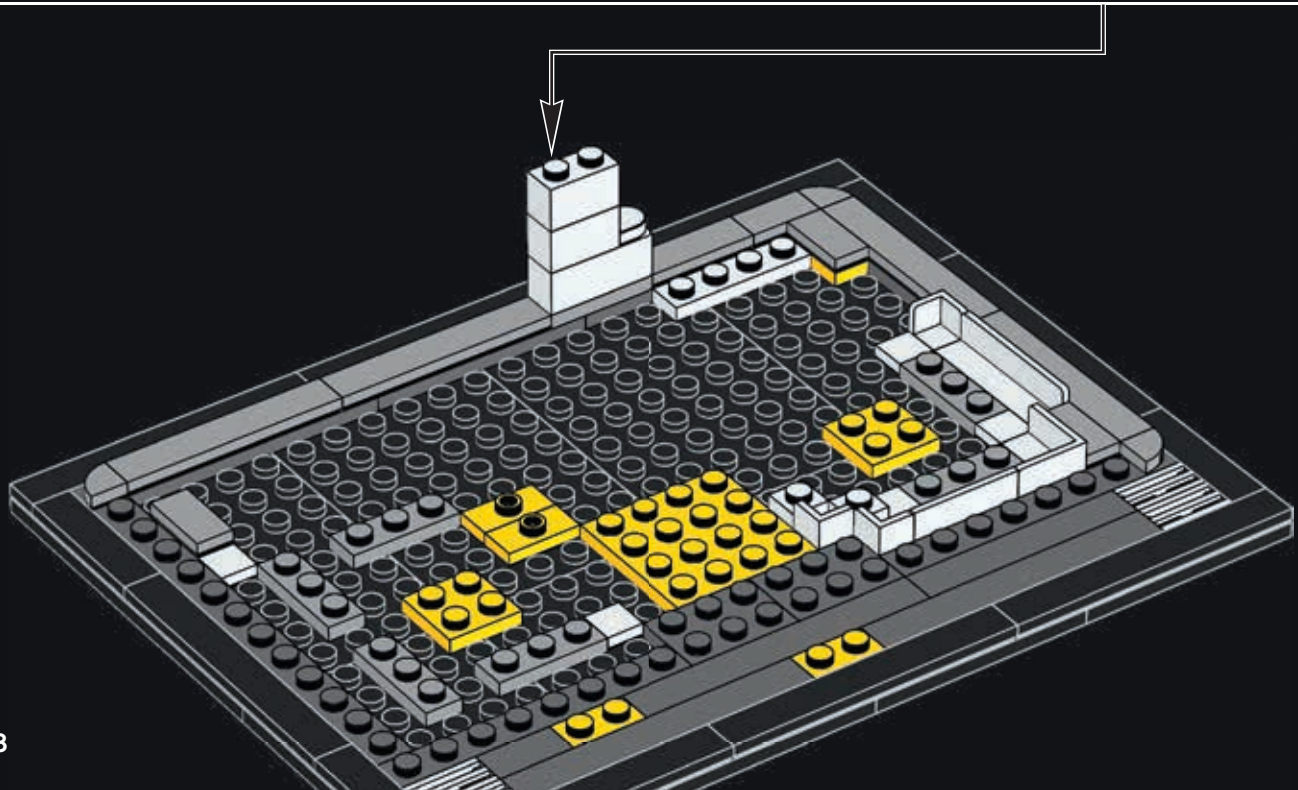

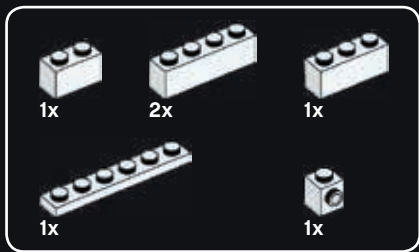

17

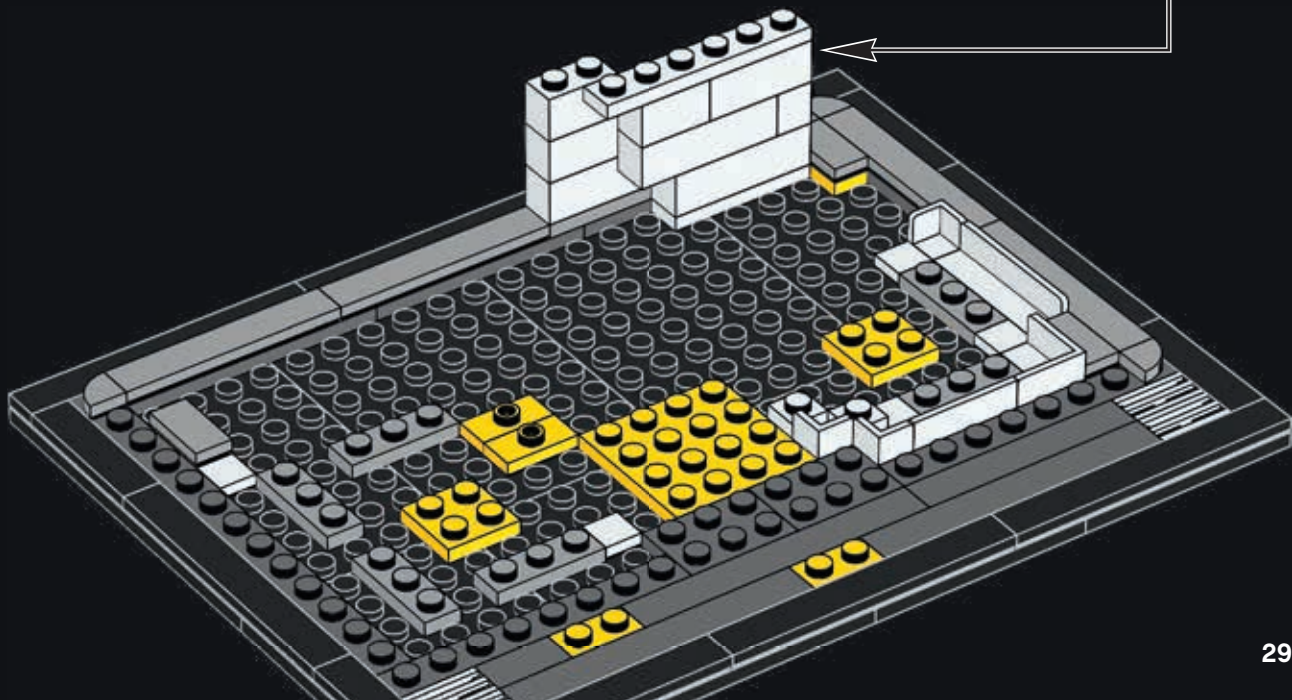
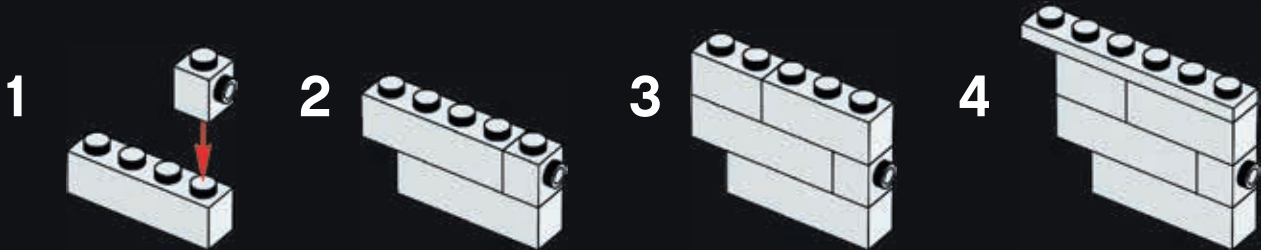



18

1



2



3



4



5

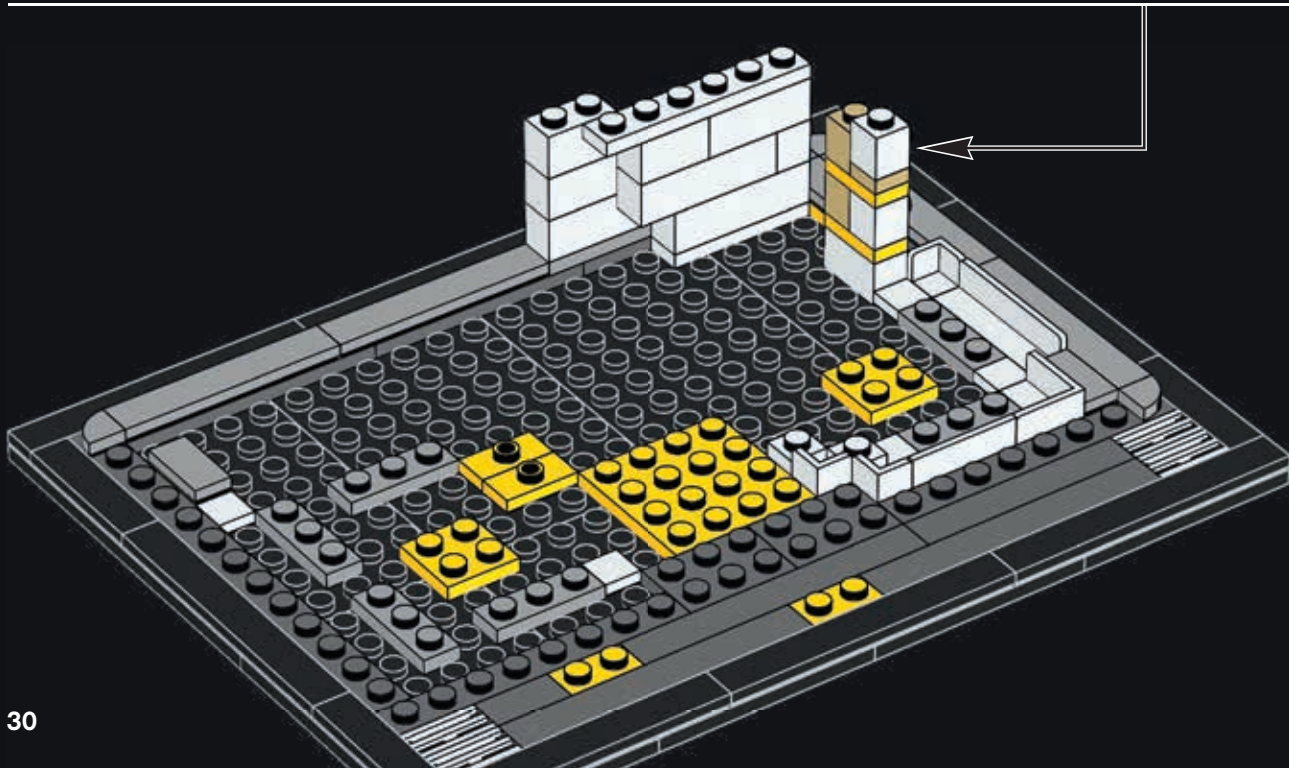



19

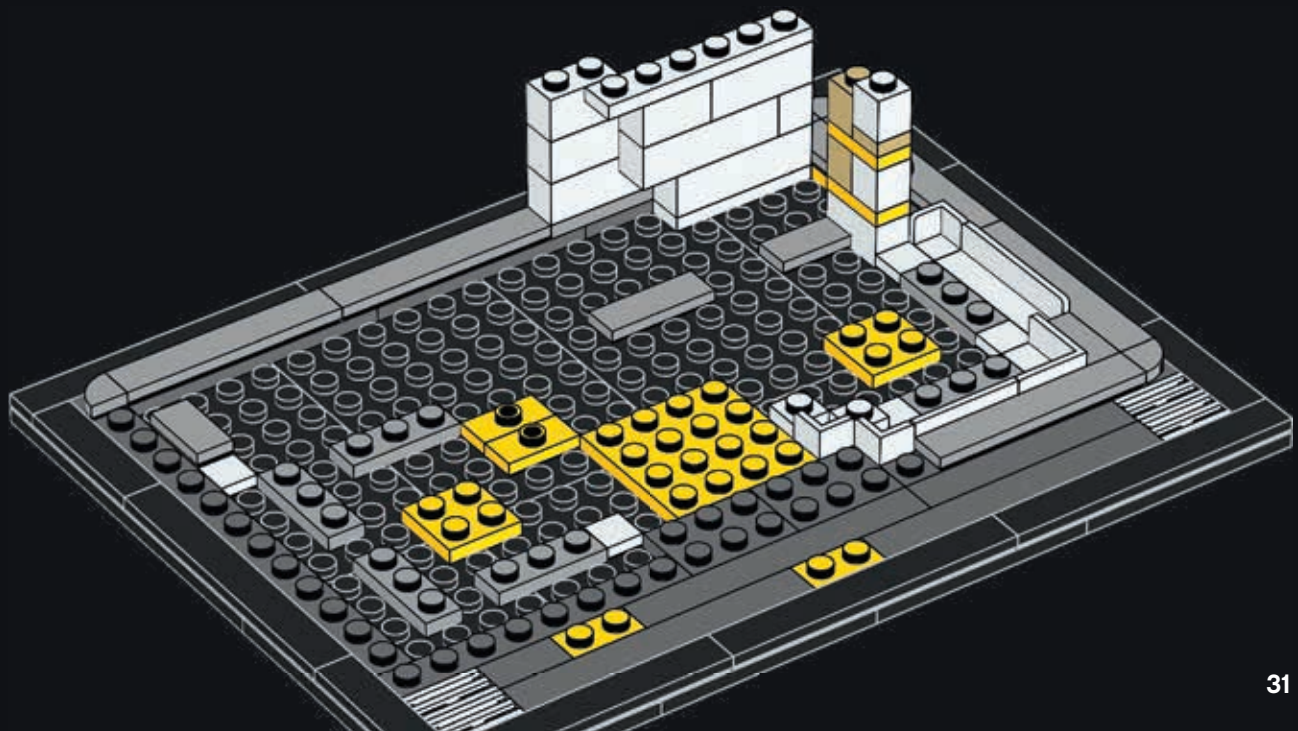



20

1

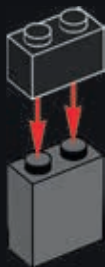

2



3

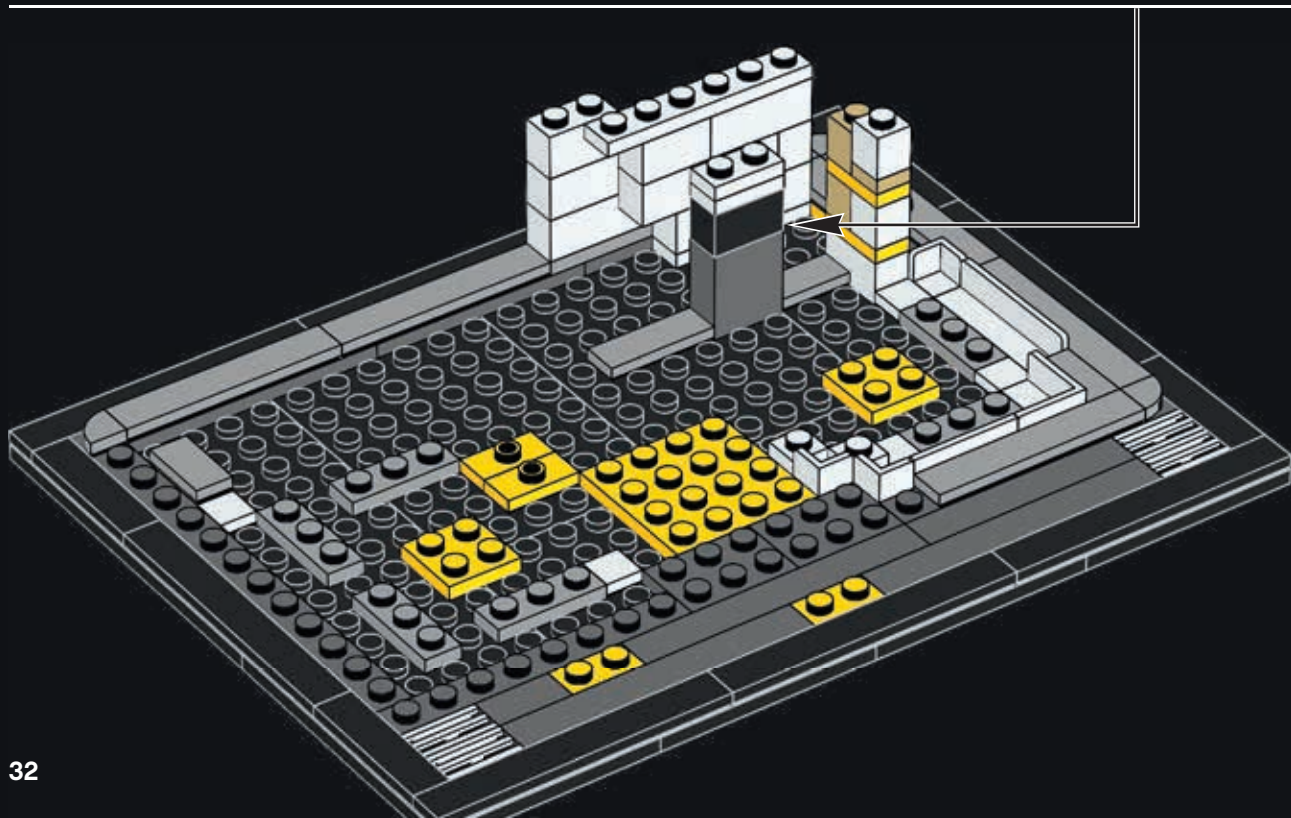



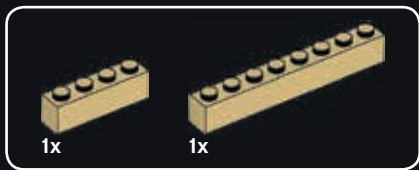

21

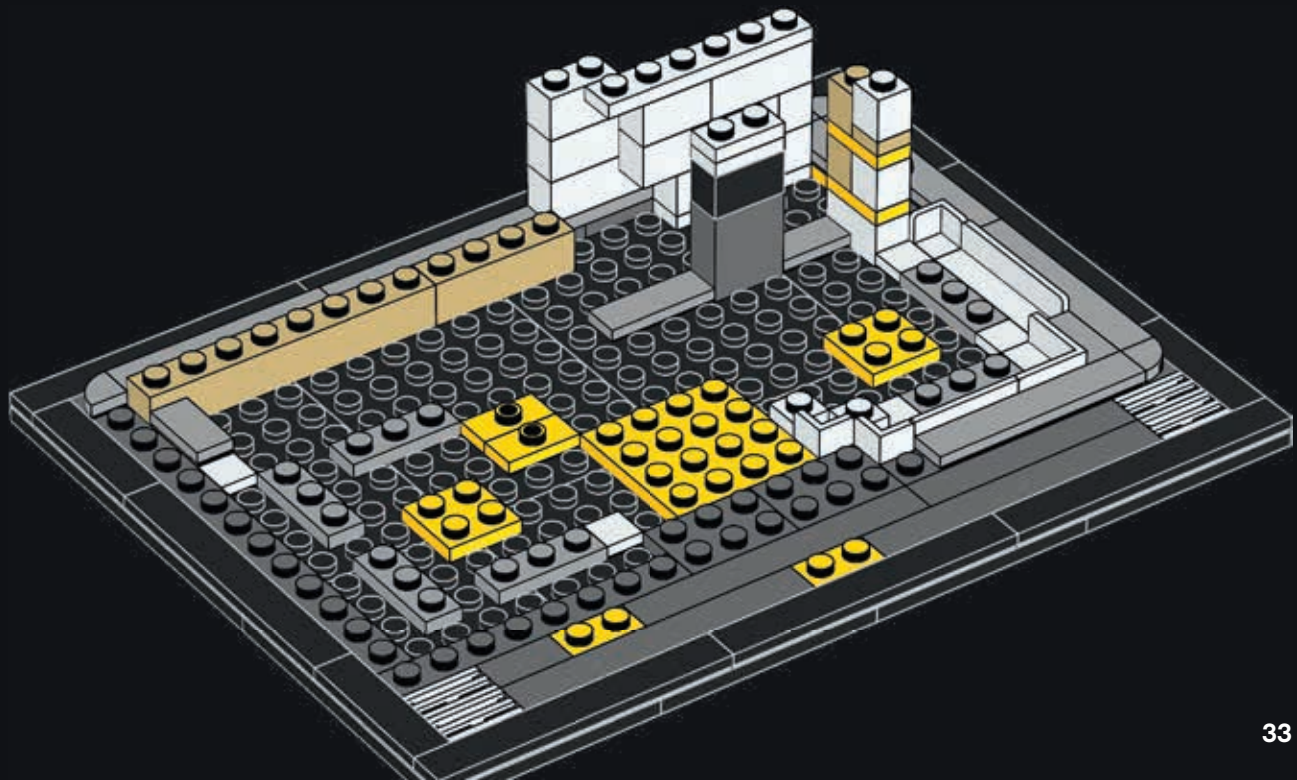

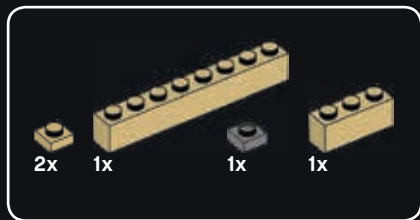

22

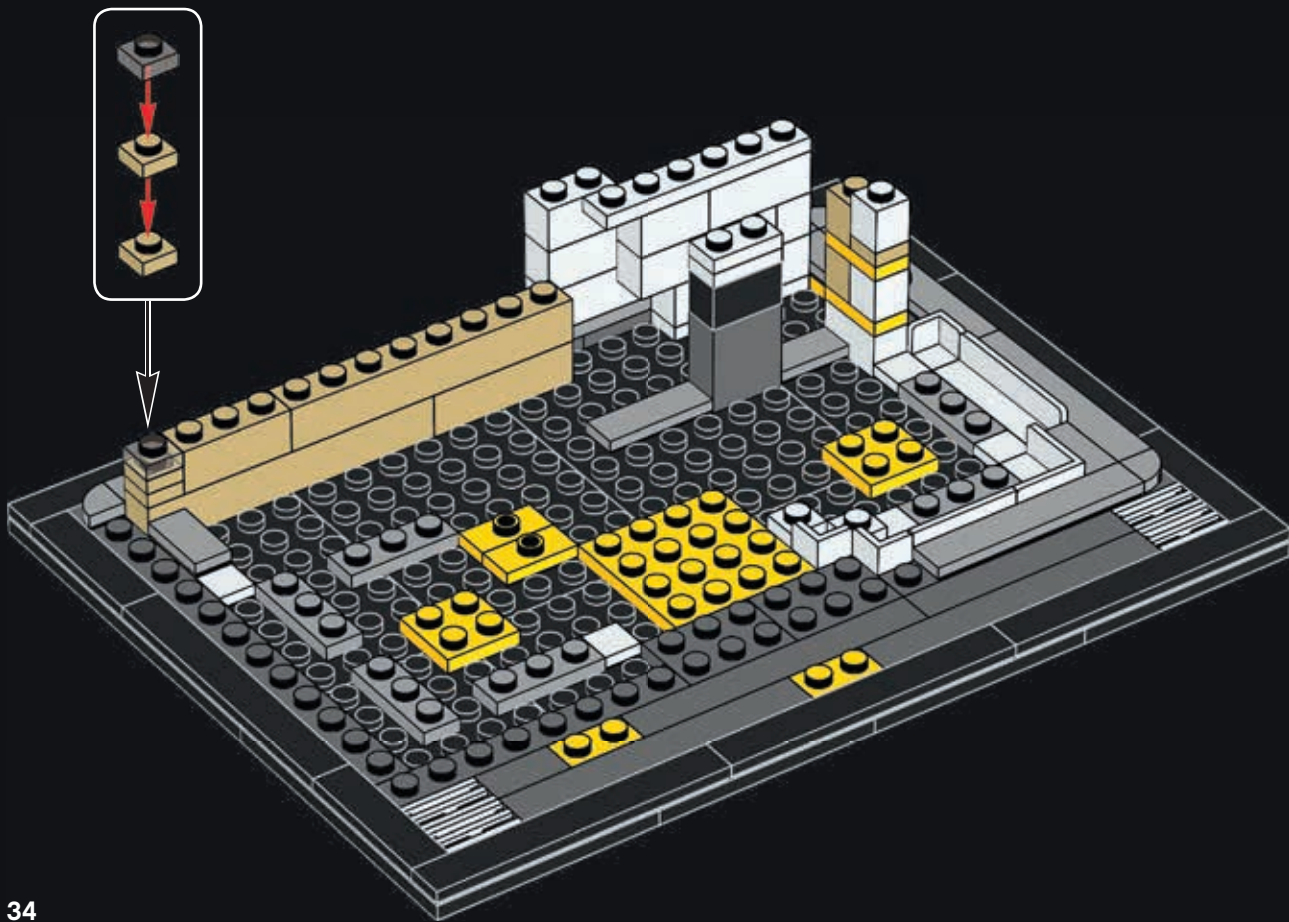



23

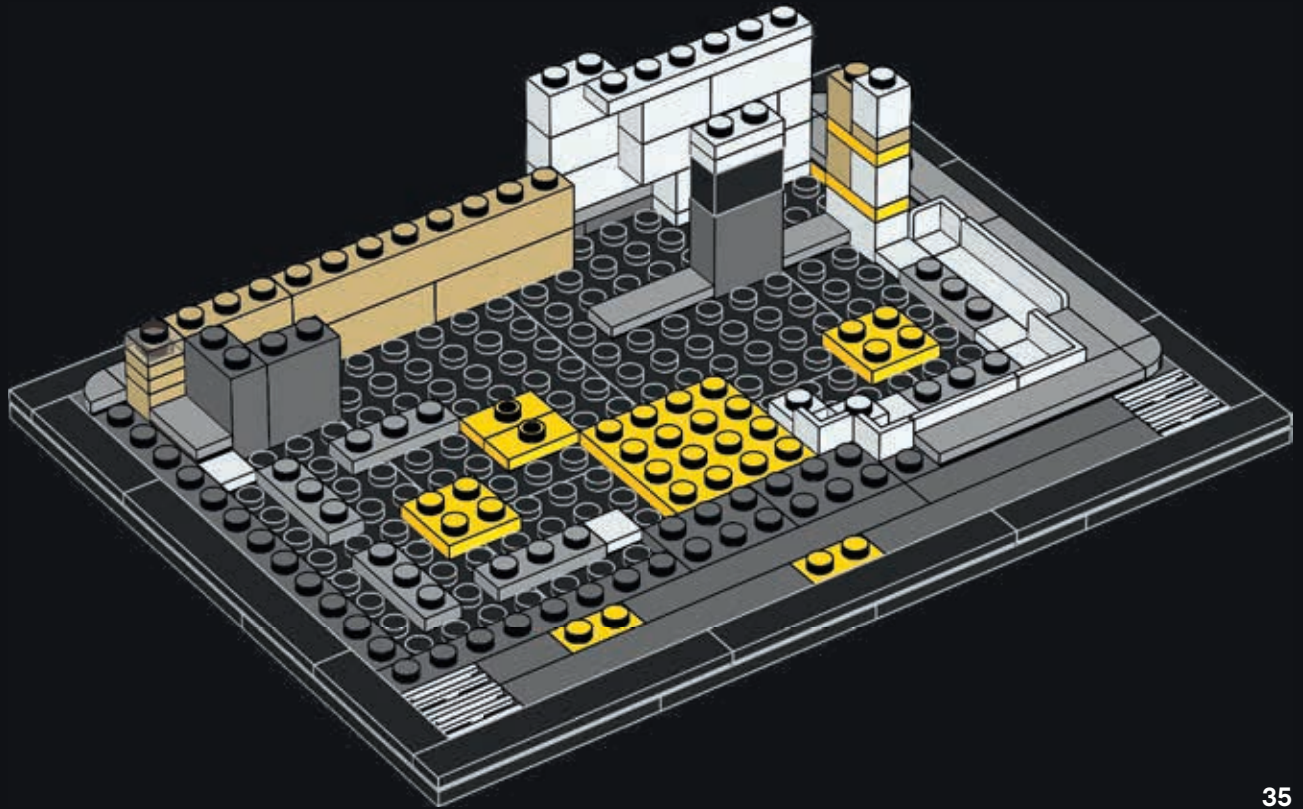



24

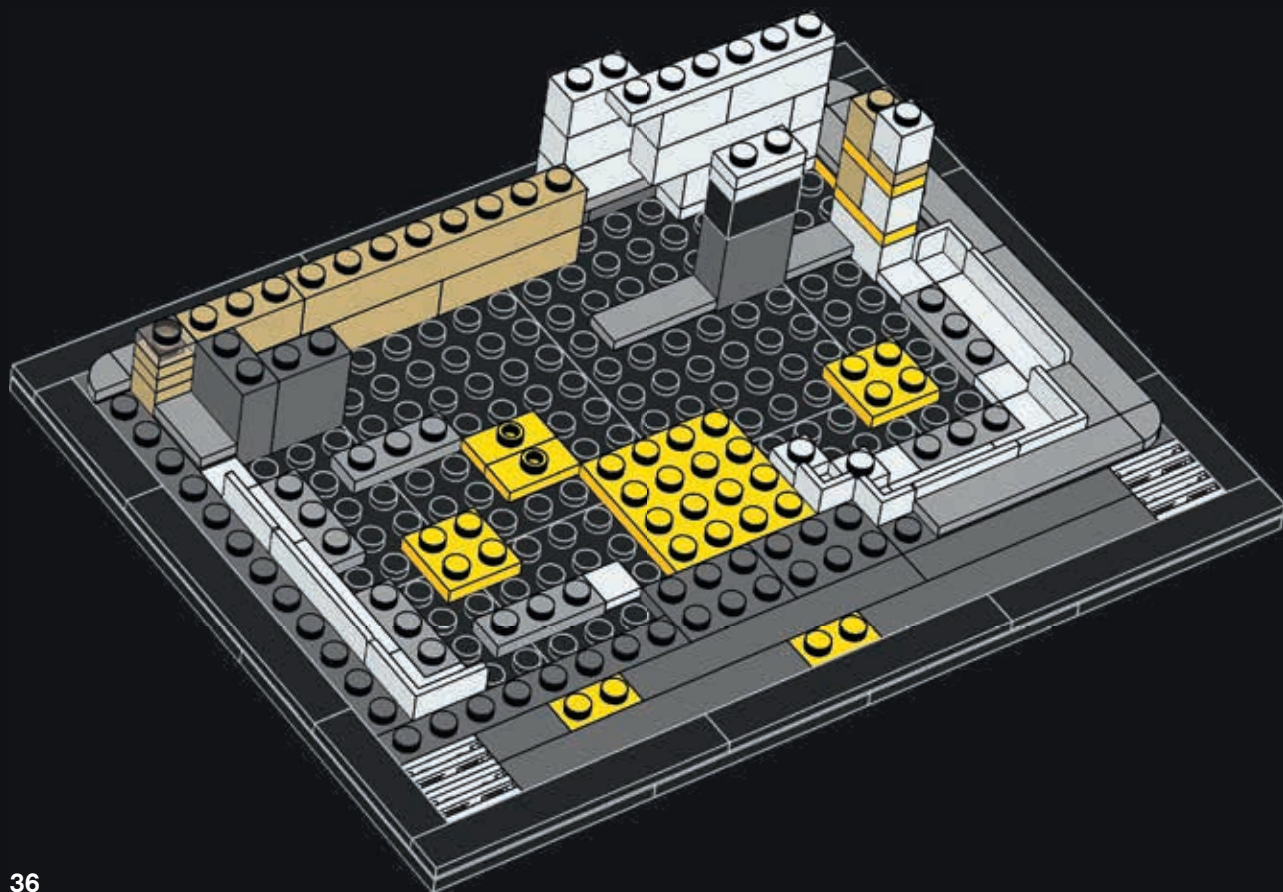



25

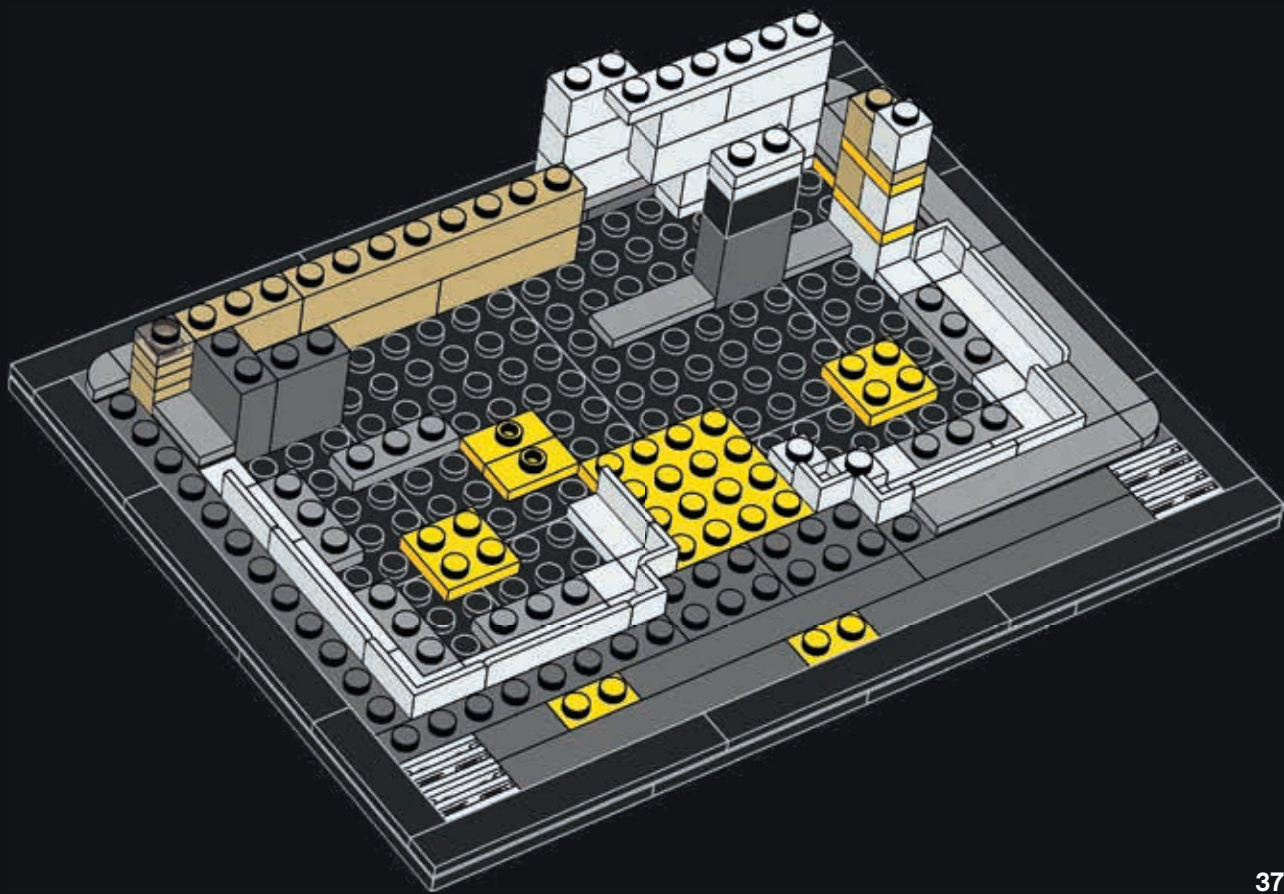



26

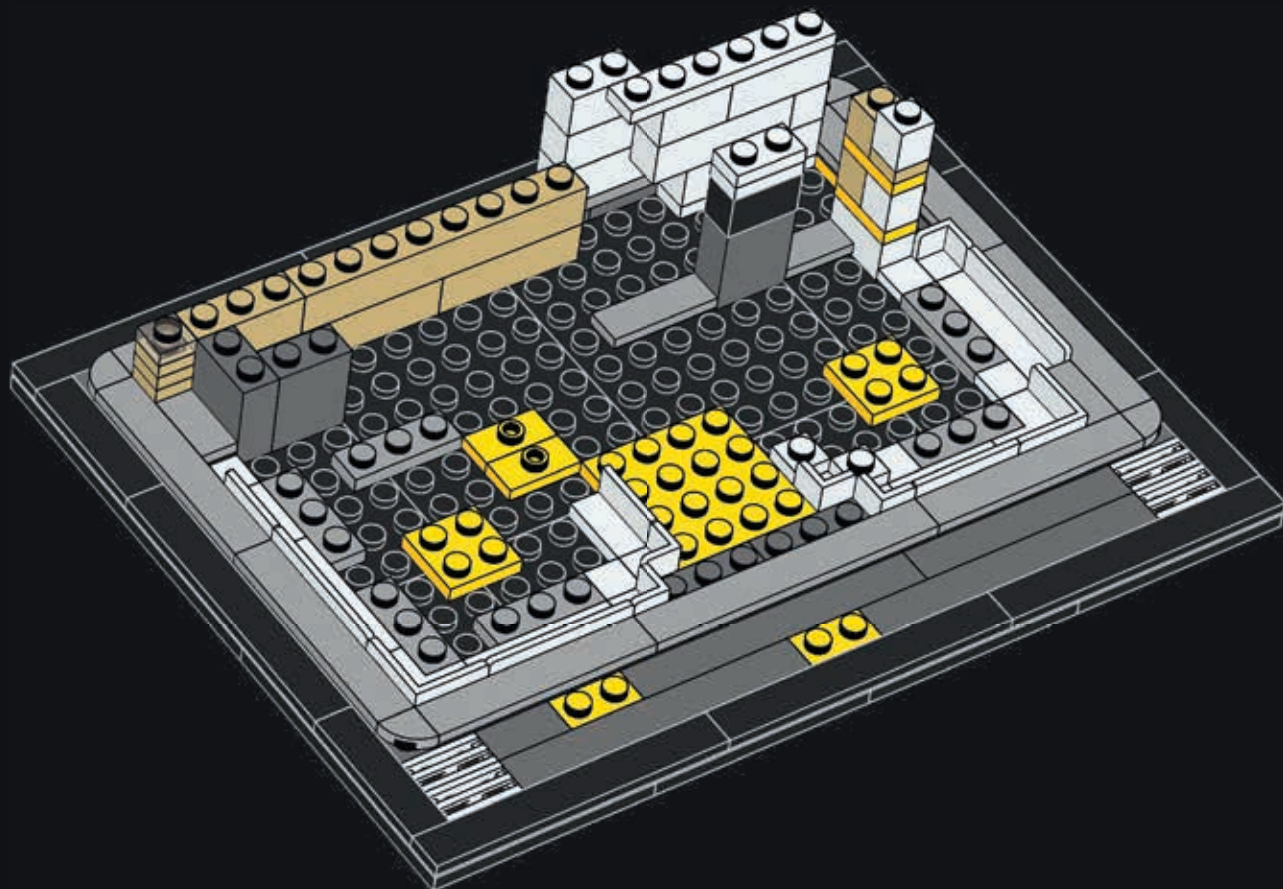

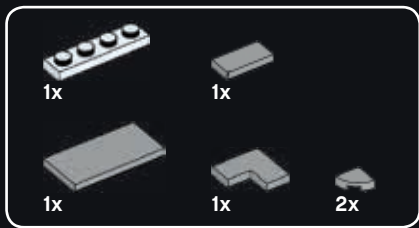

27

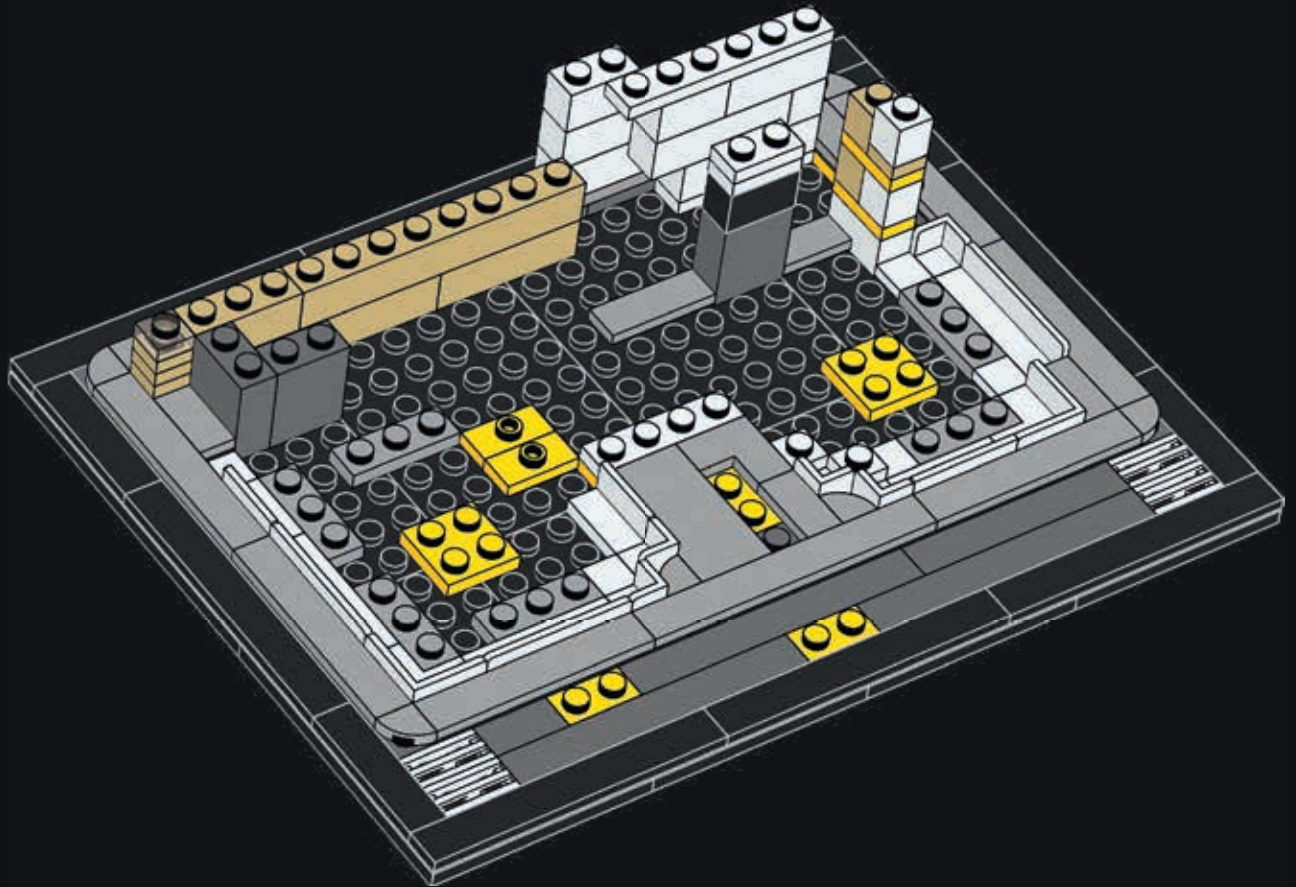



1x



2x

28

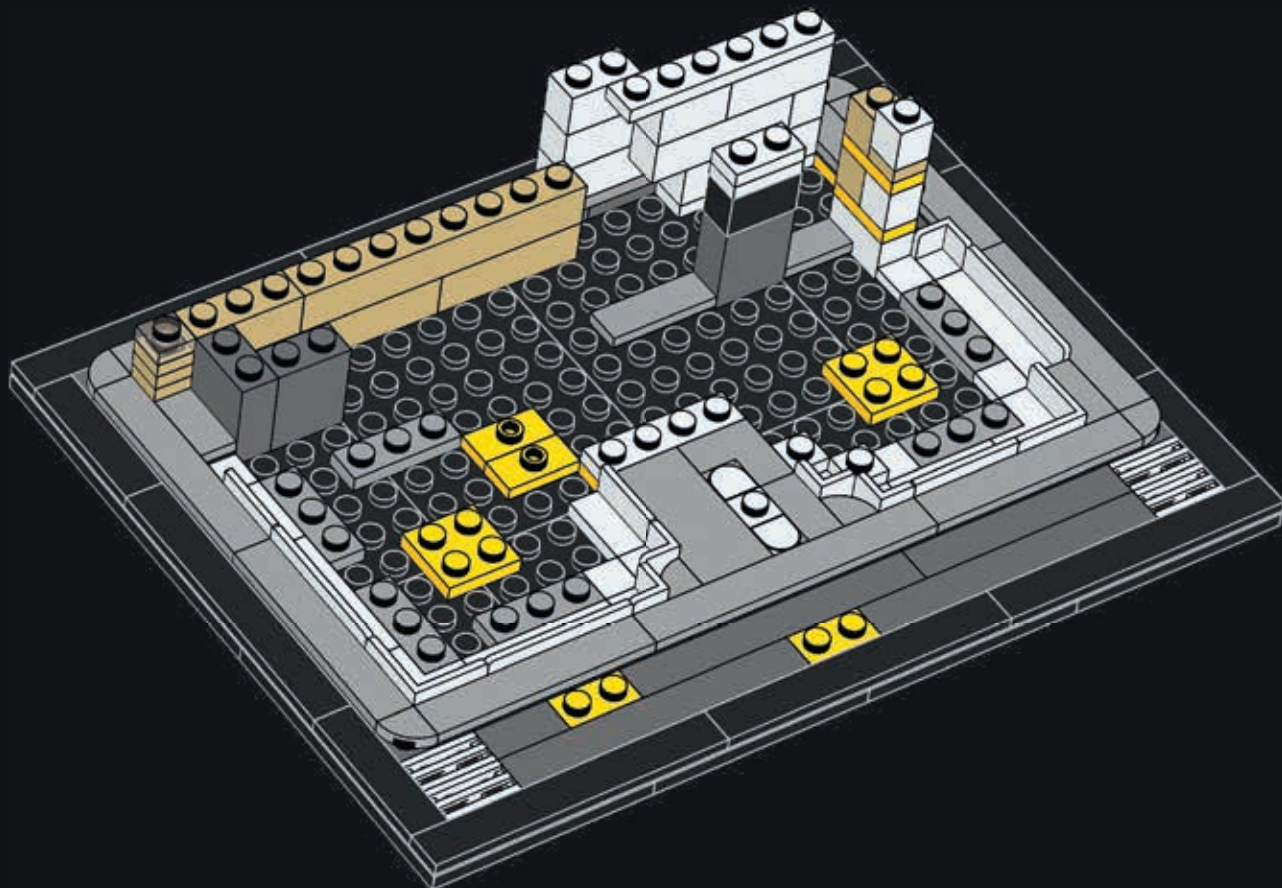





2x

29

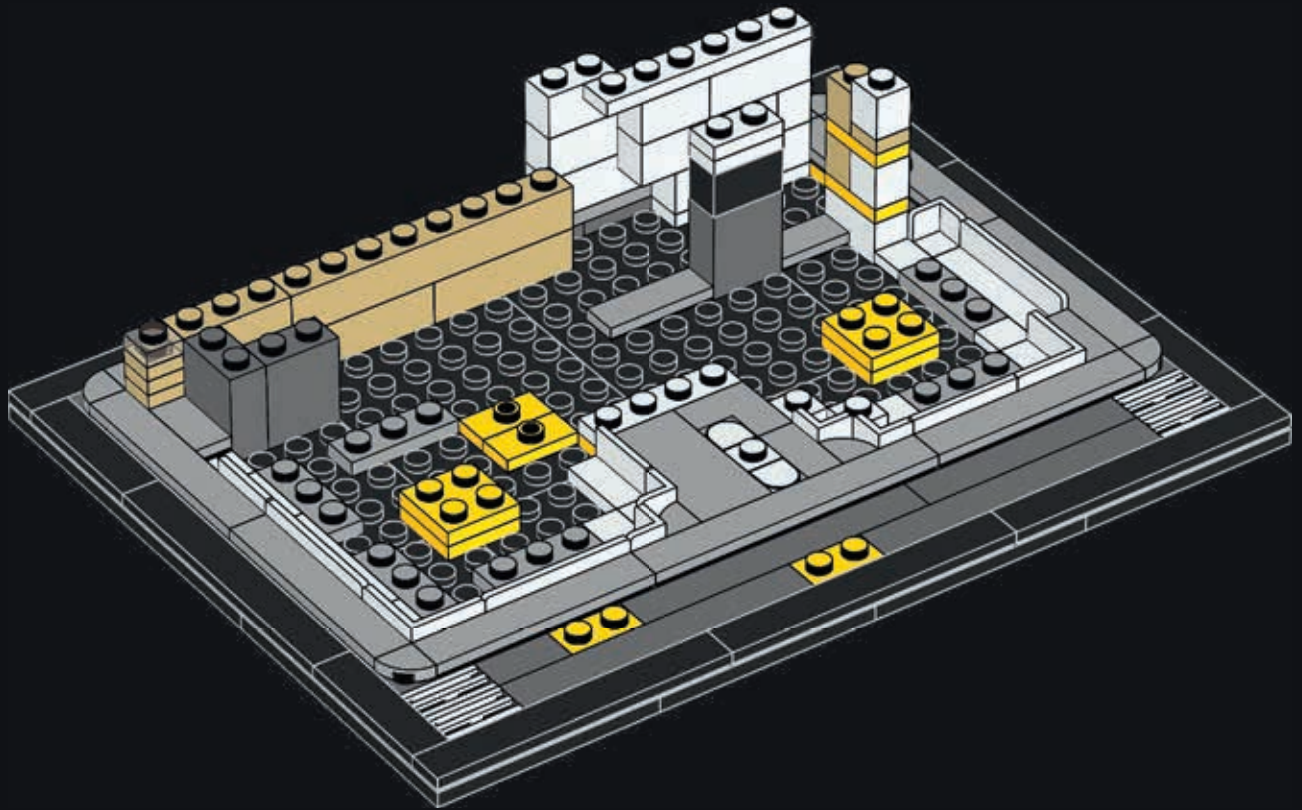



30

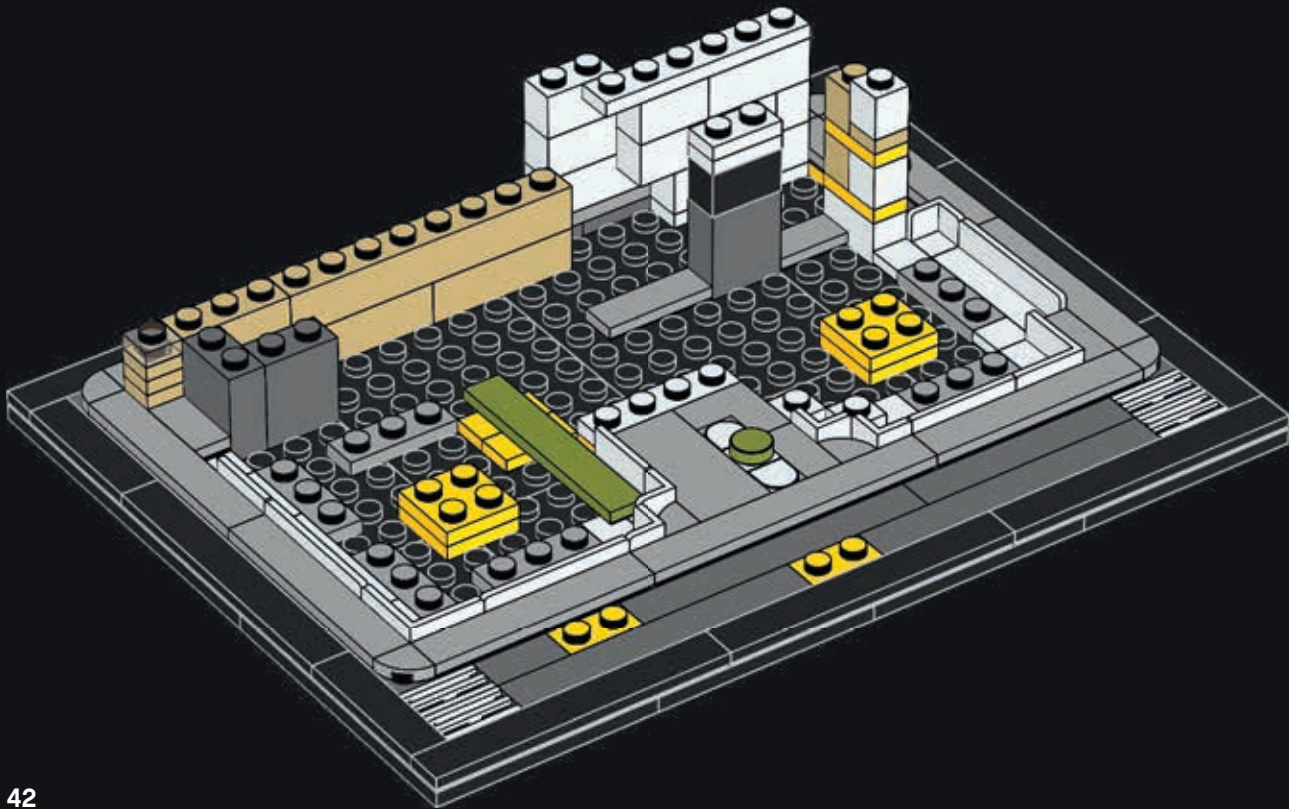



31

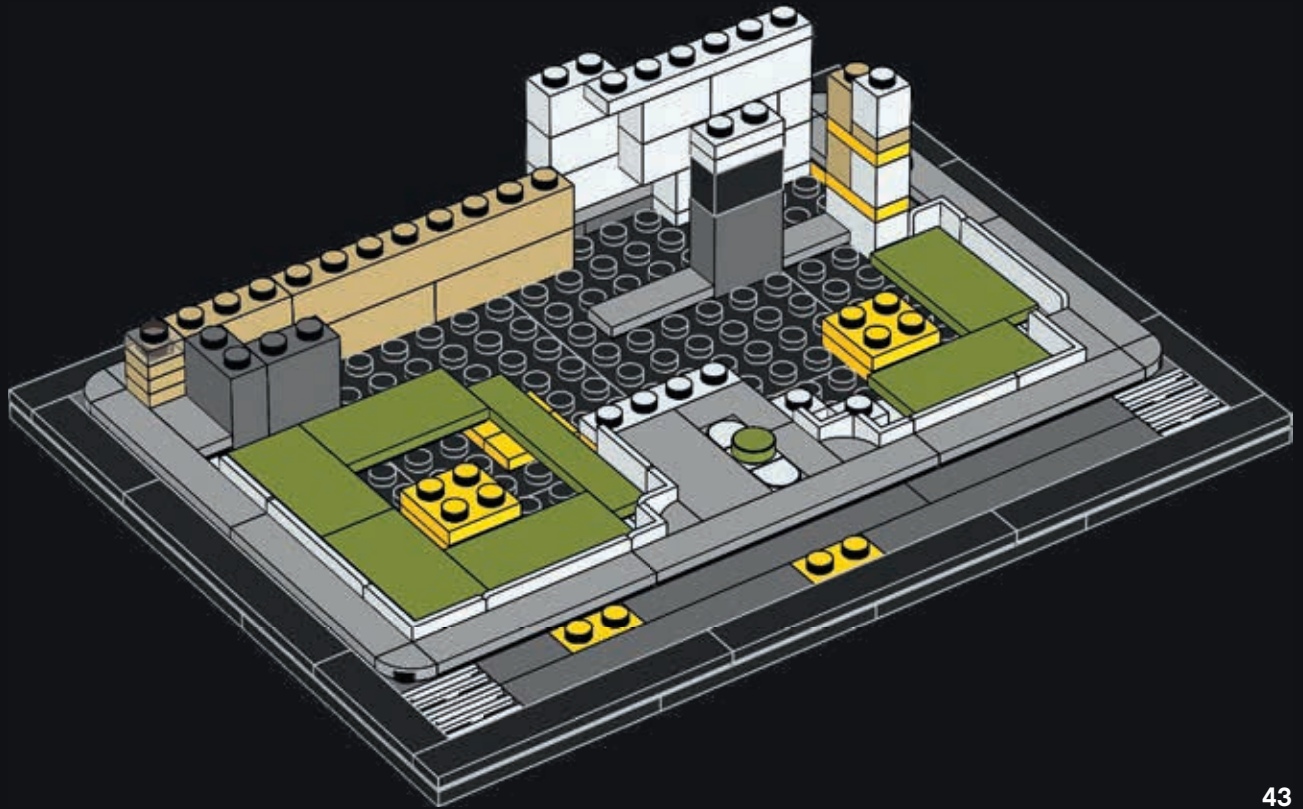

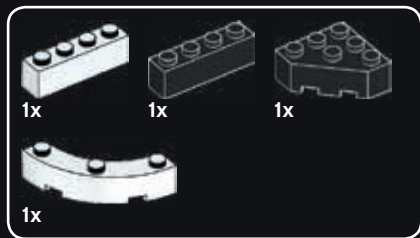

32

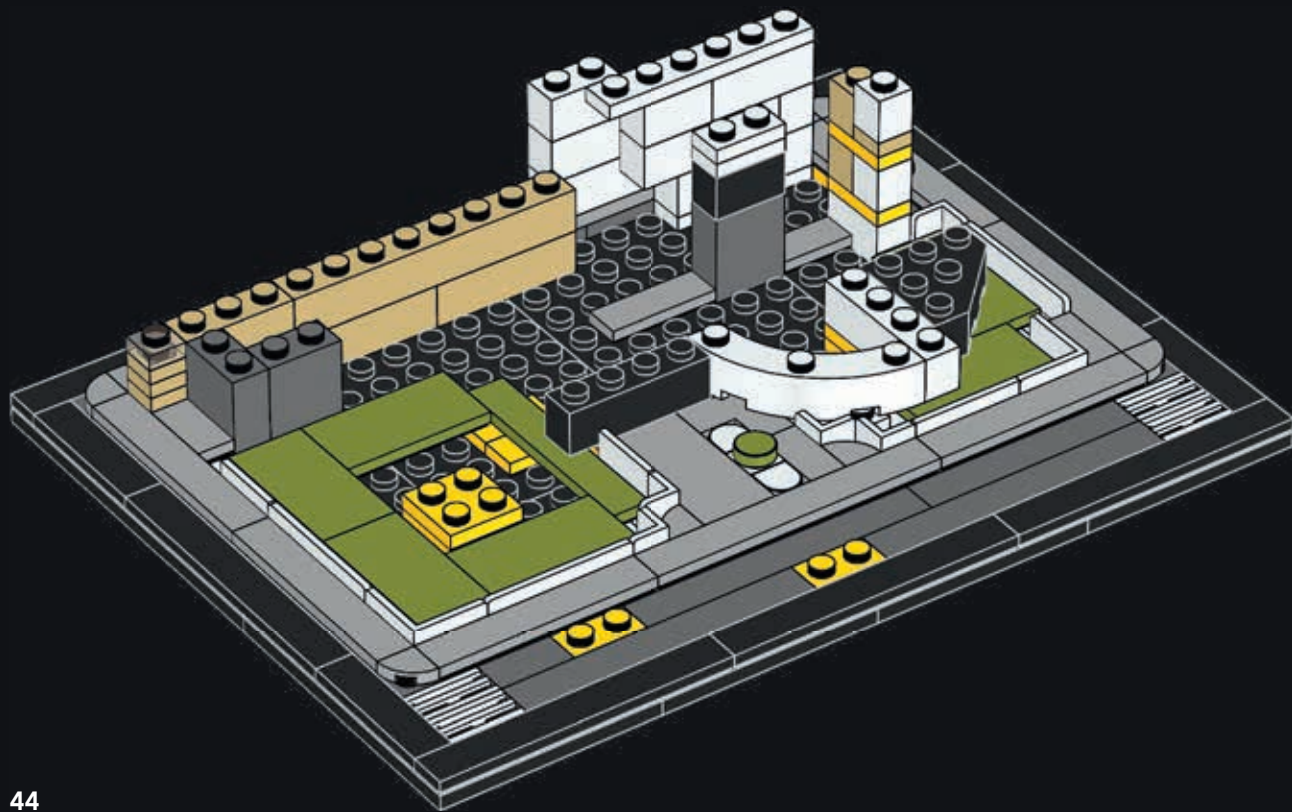



33

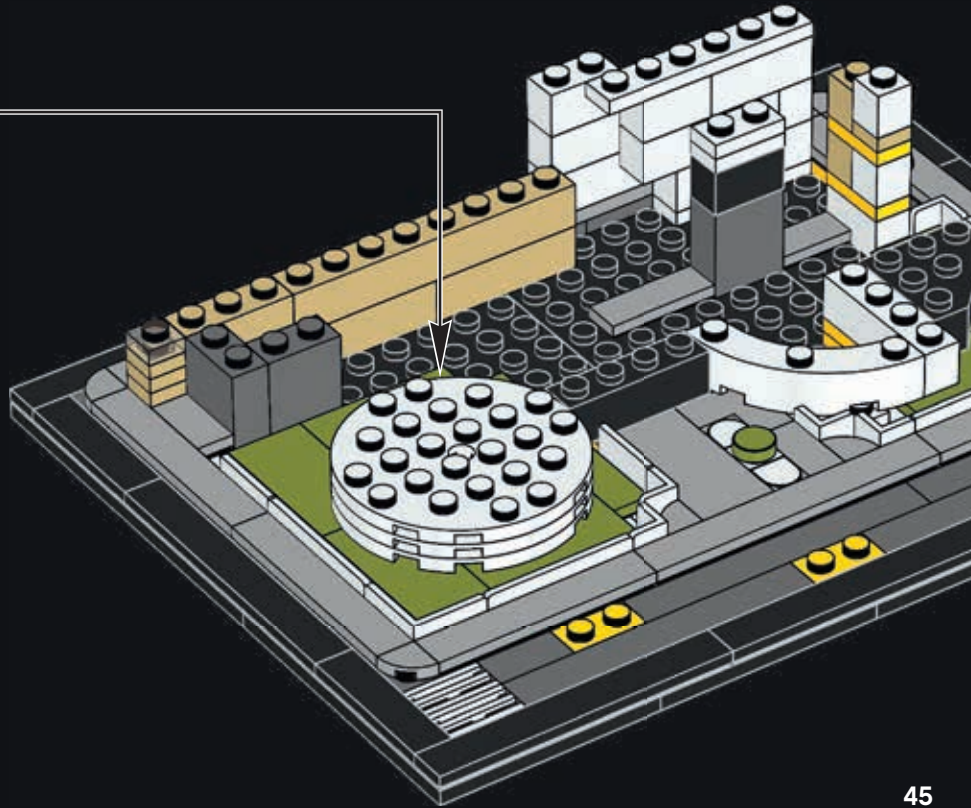
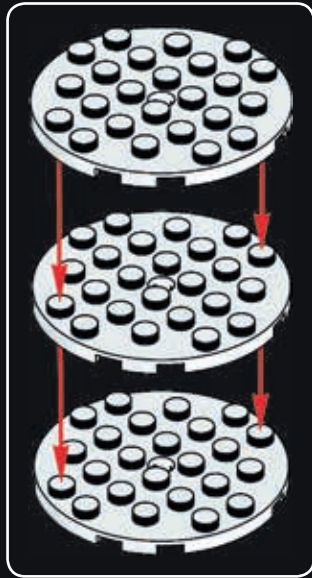

Frank Lloyd Wright originally wanted to call the Guggenheim the "Archeseum," which means "to see from the highest."



©The Solomon R. Guggenheim Foundation, New York



34

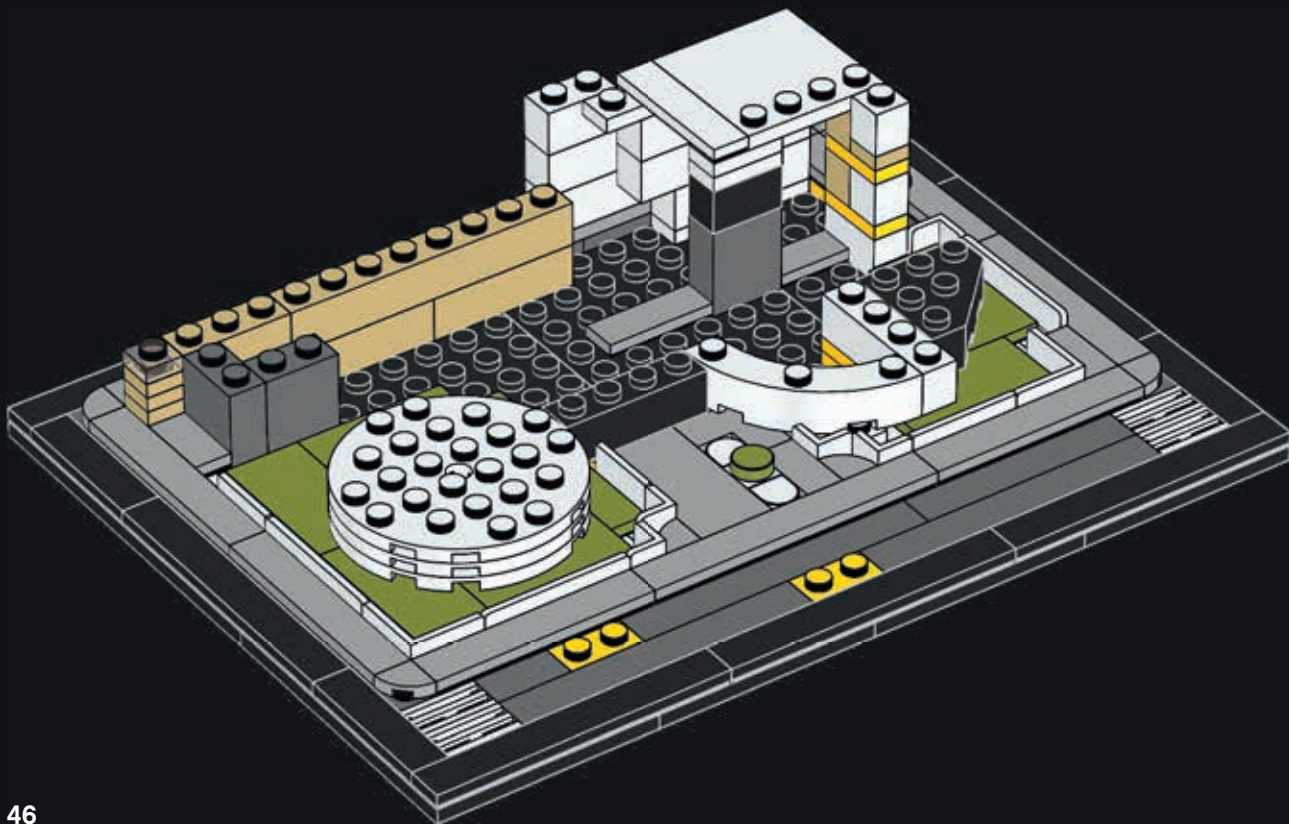



1x



1x

35

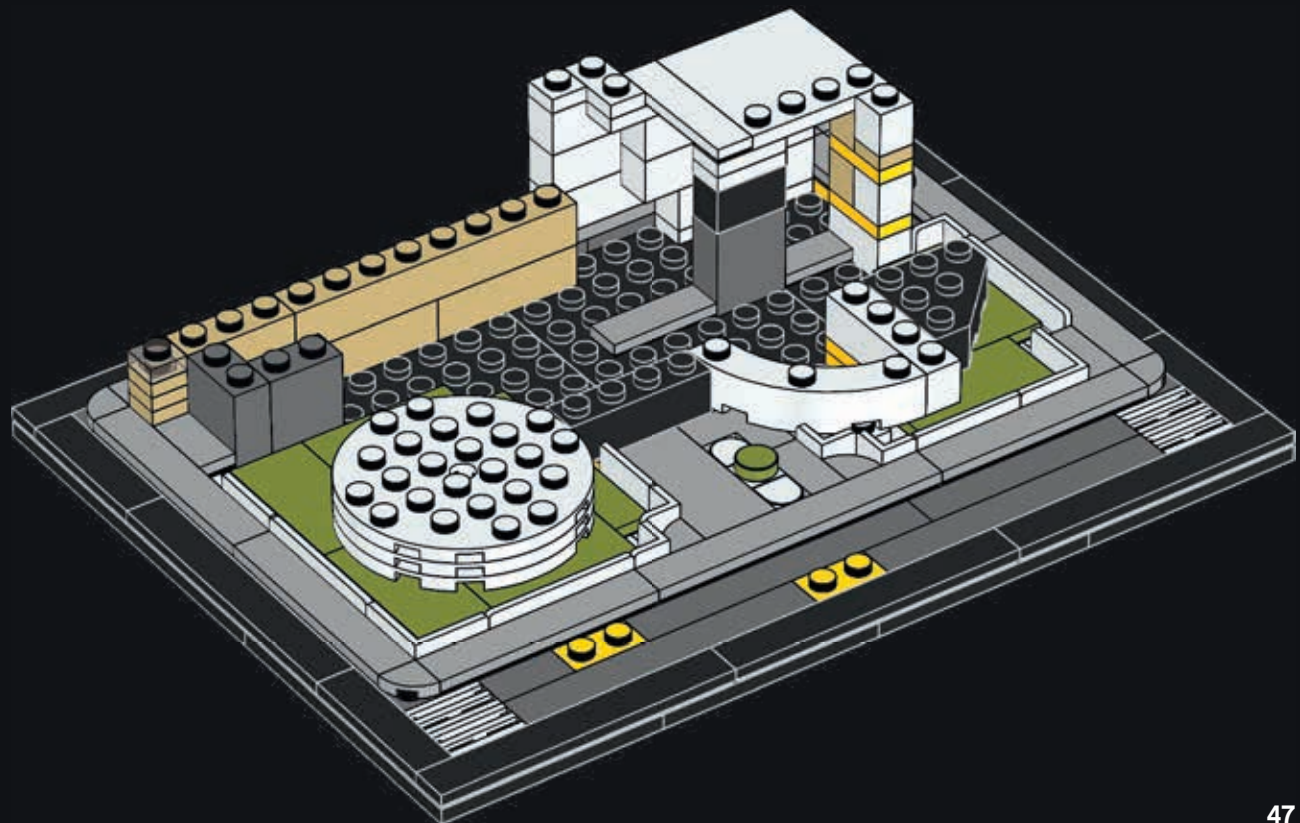

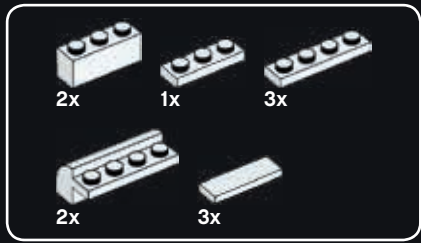

# 36

1

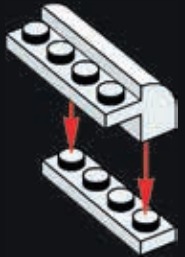

2

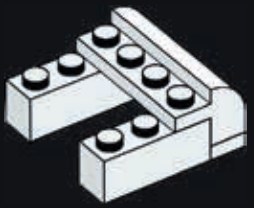

3

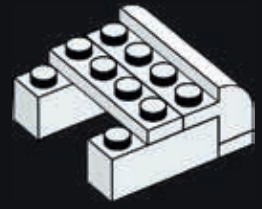

4

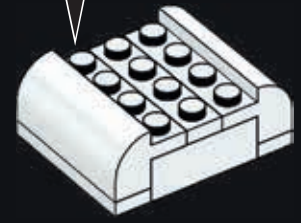
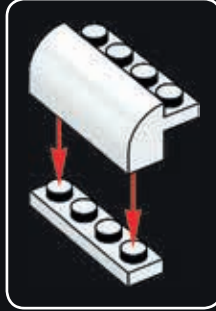

5

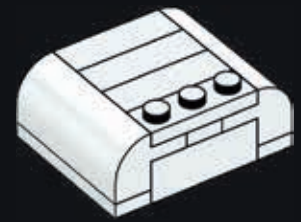



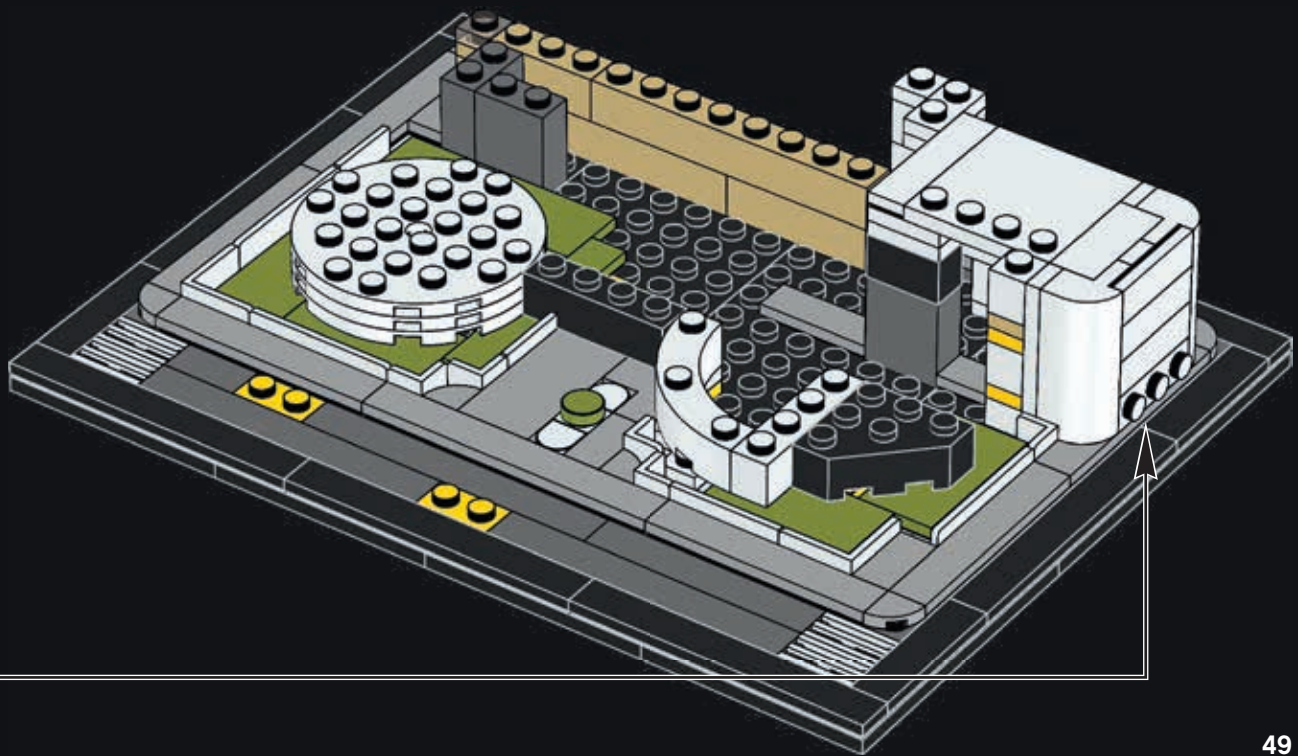

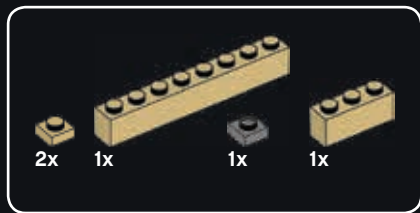

37

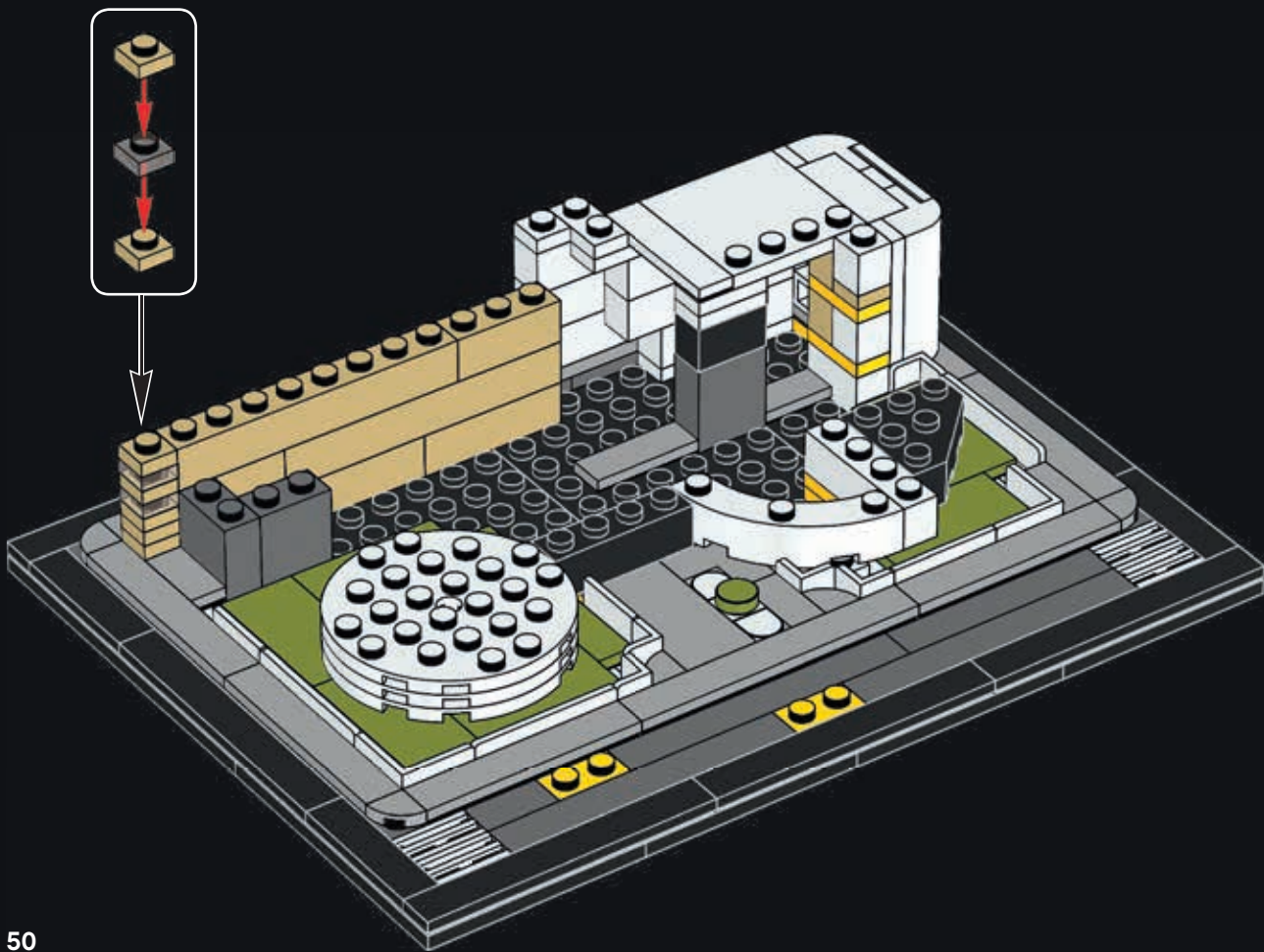



1x

38

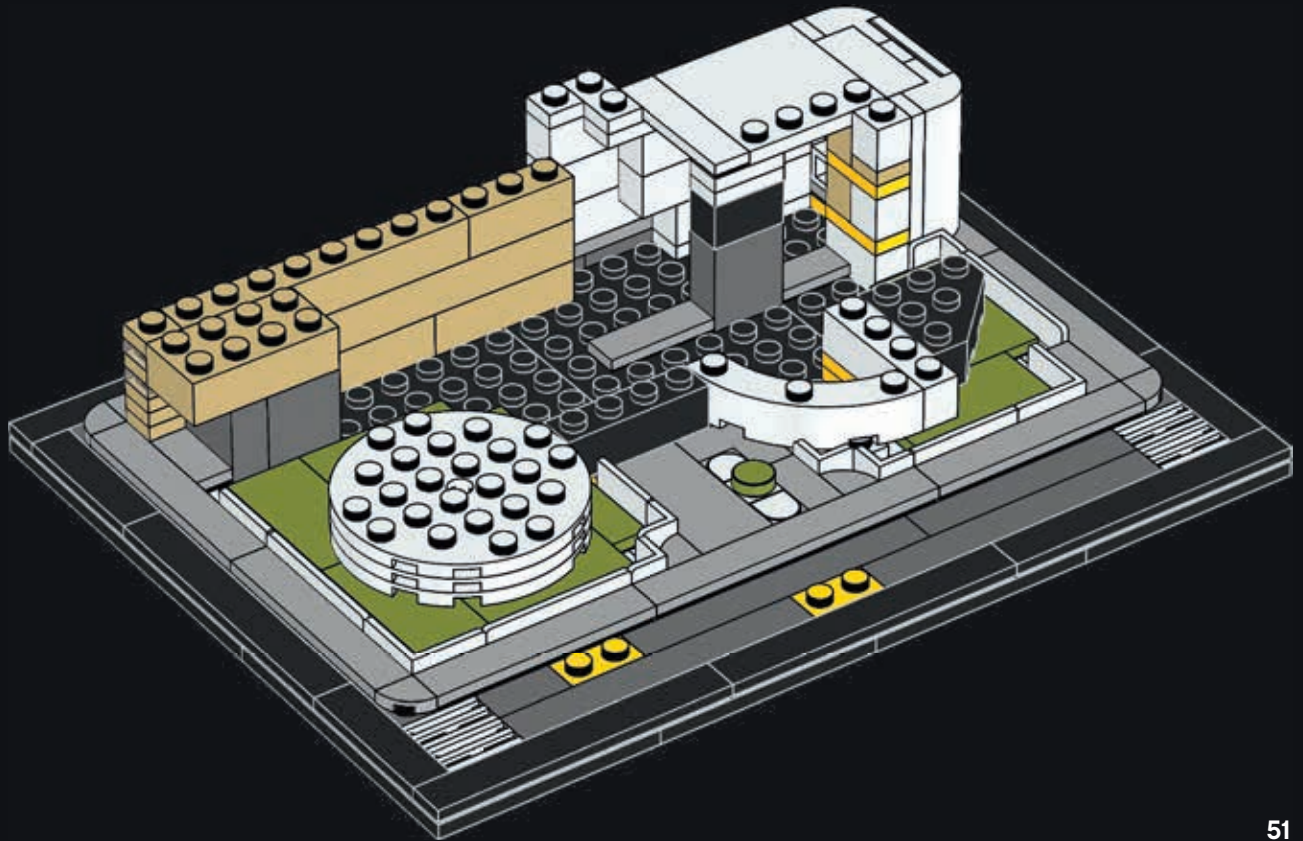

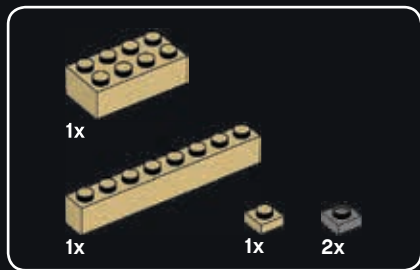

39

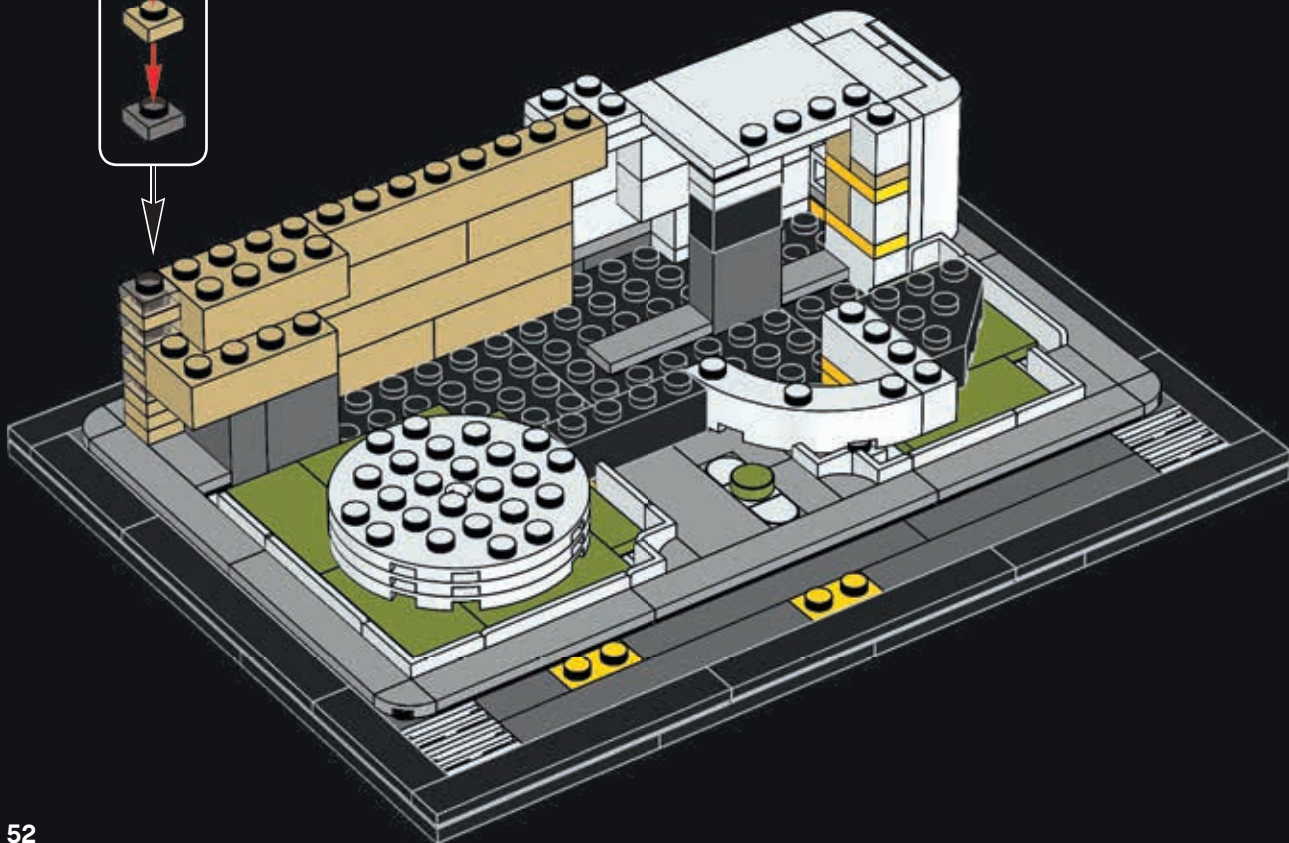



40

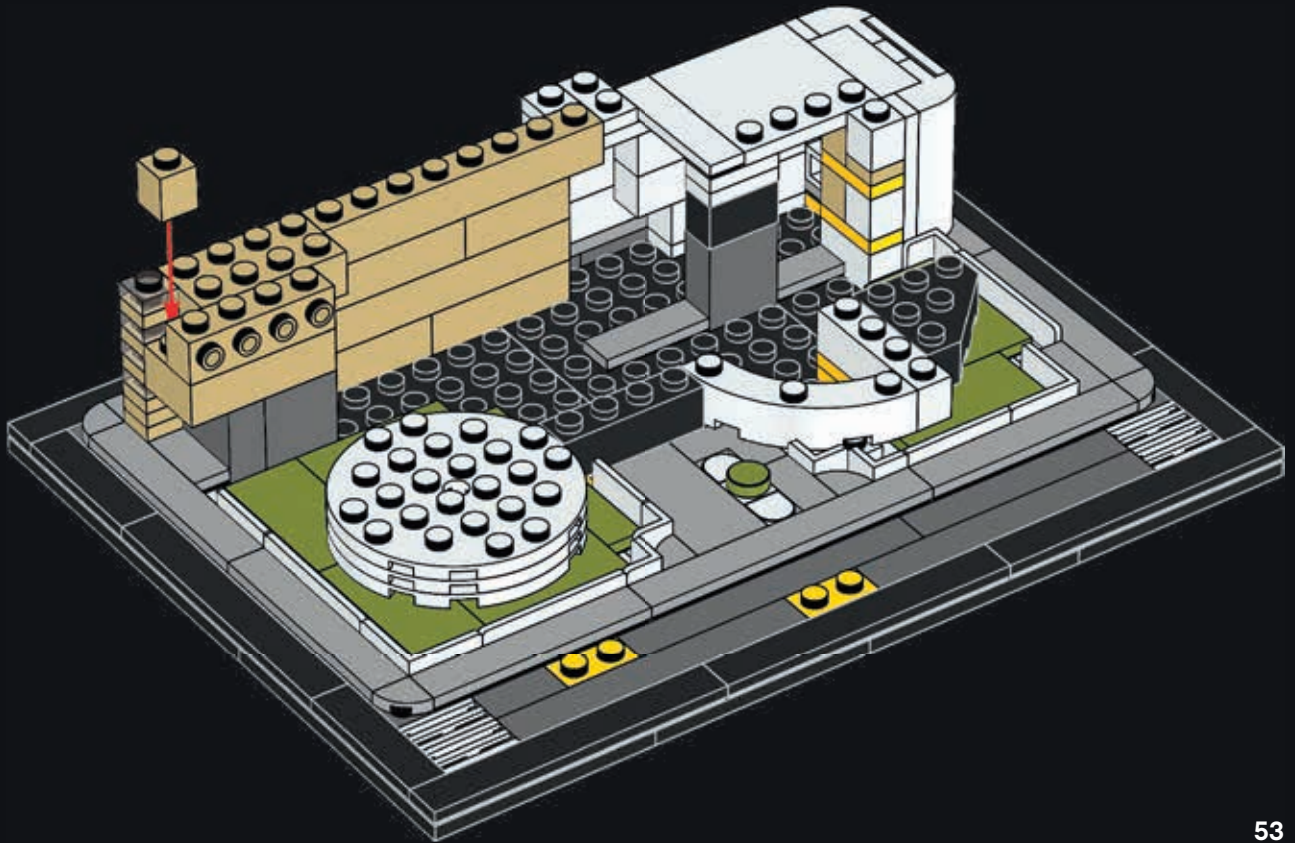

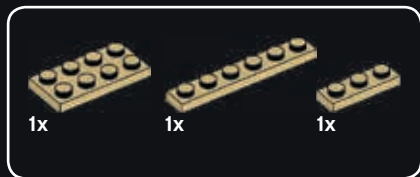

41

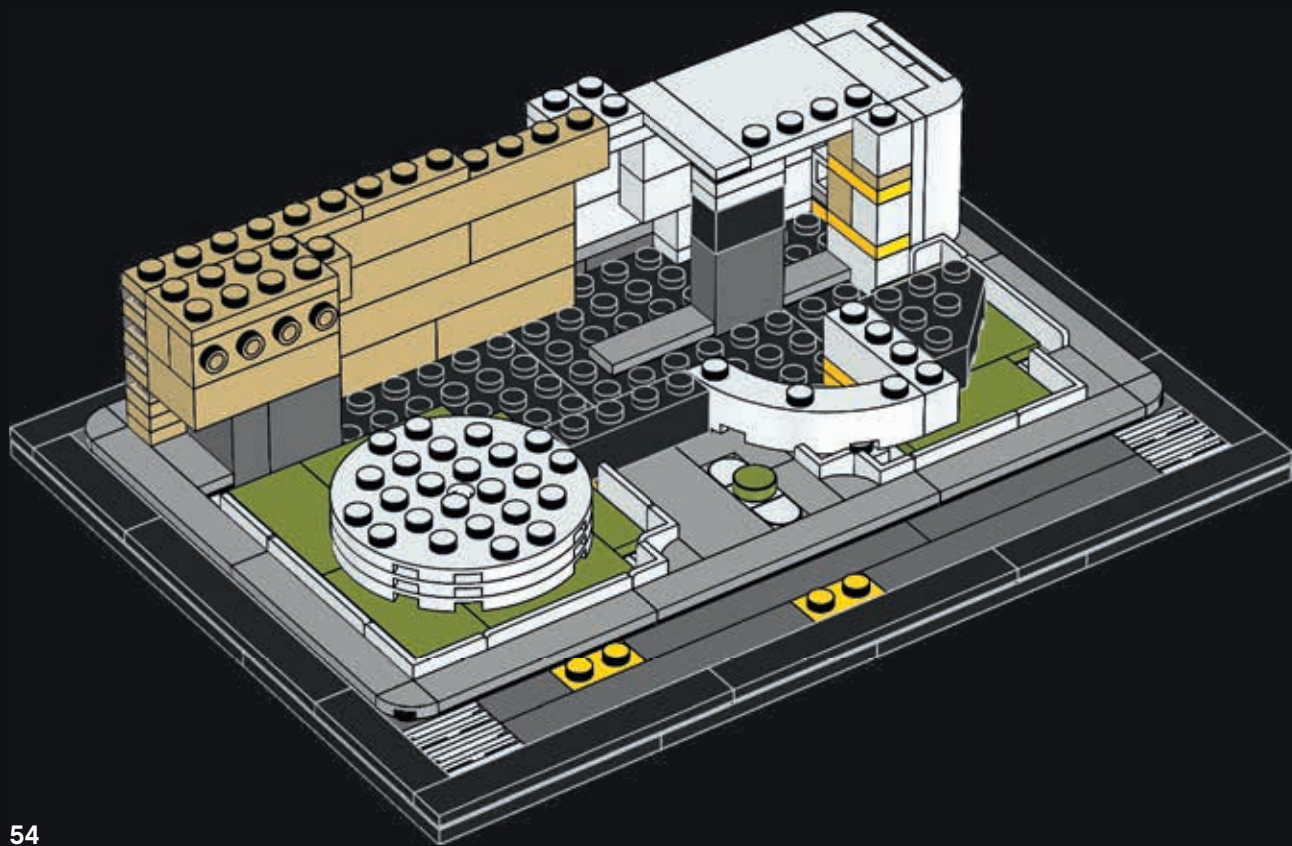



42

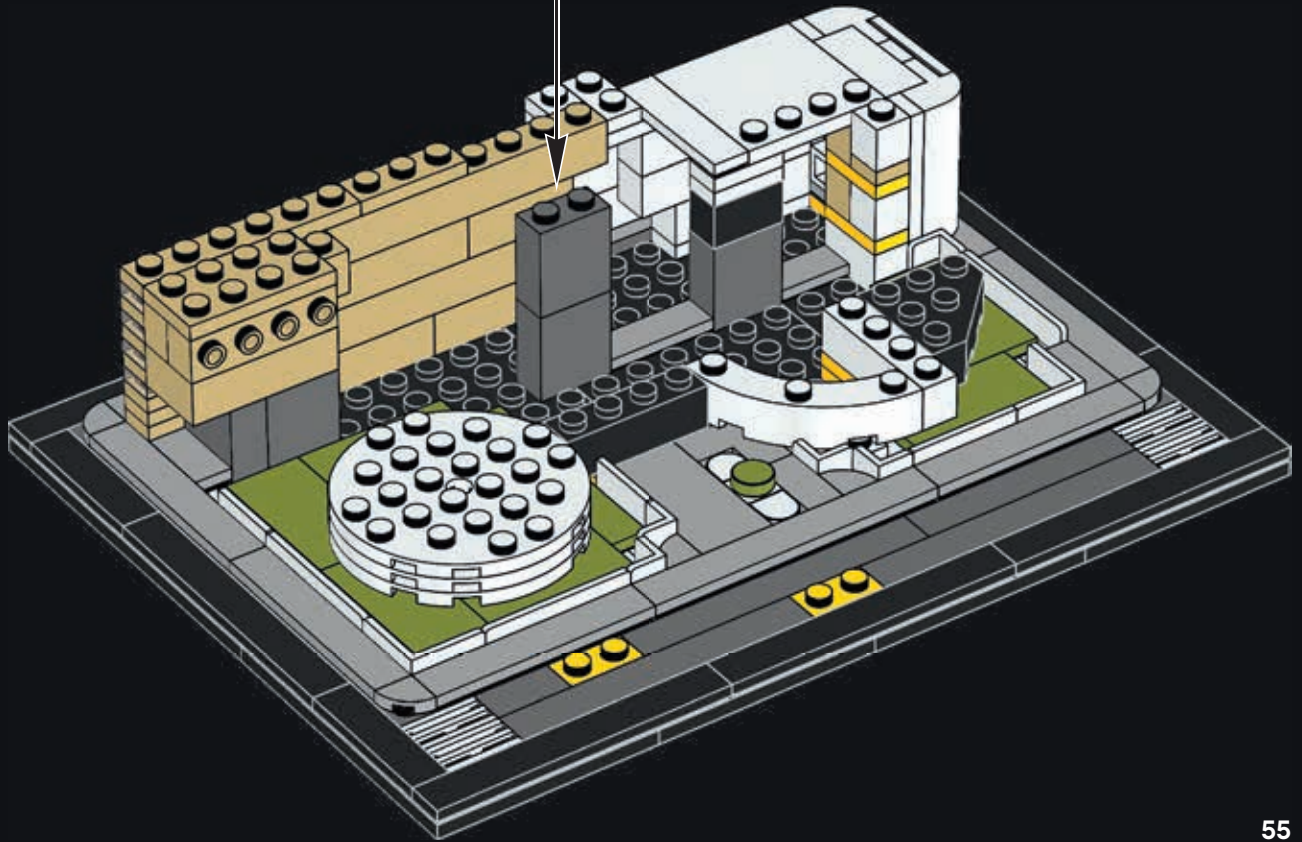
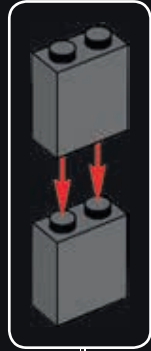



43

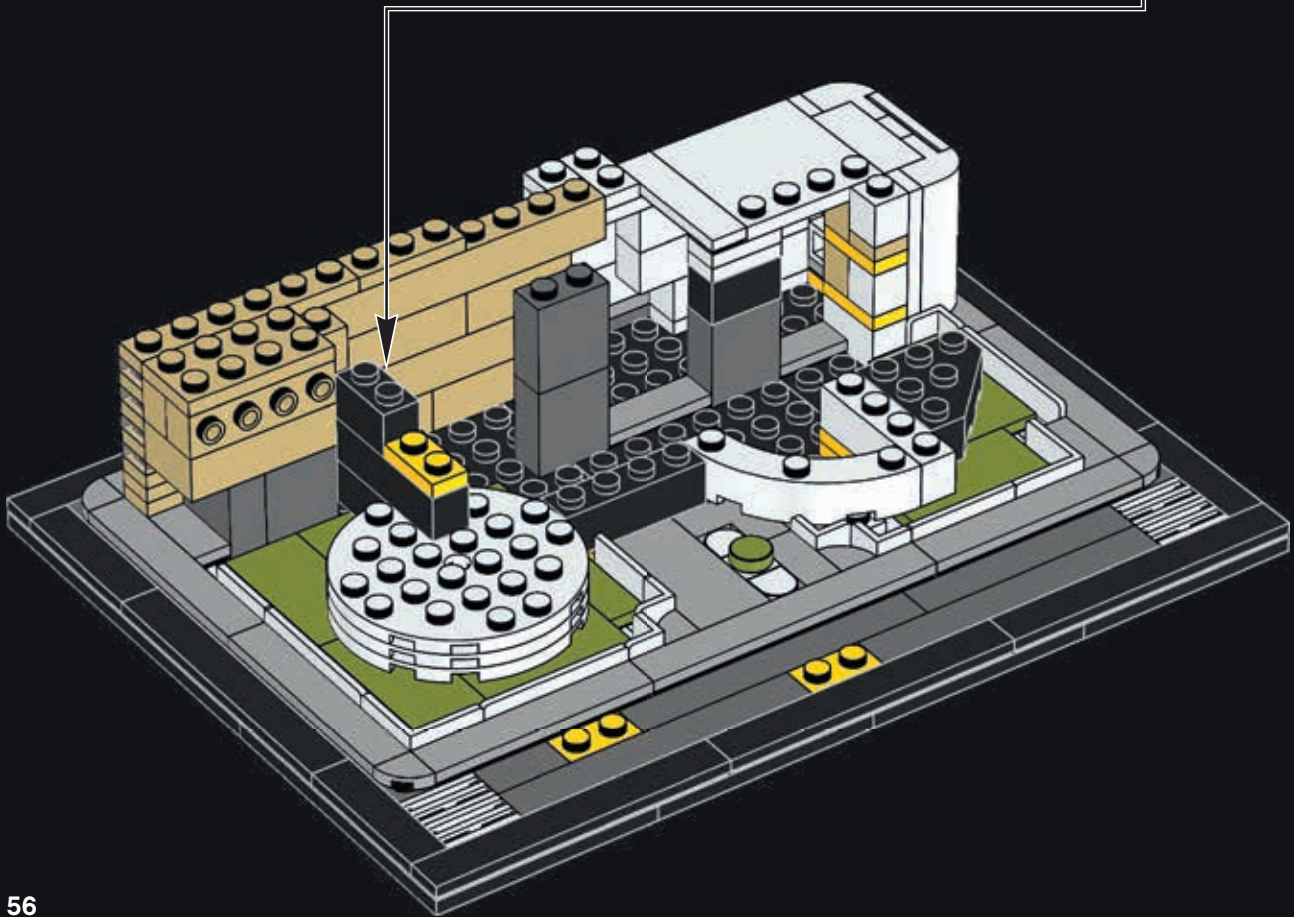
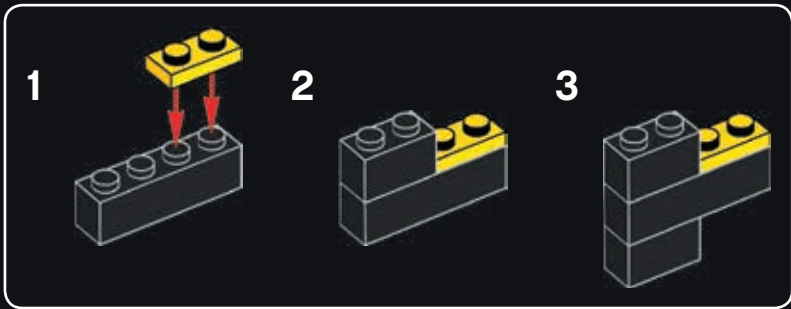



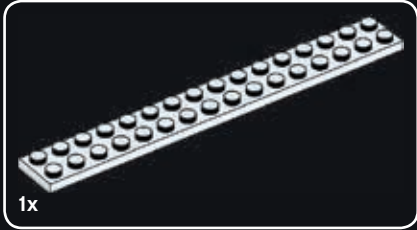
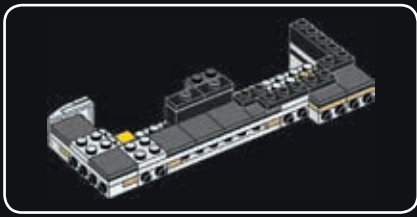

44



45





1x

46



1x

2x

47





48

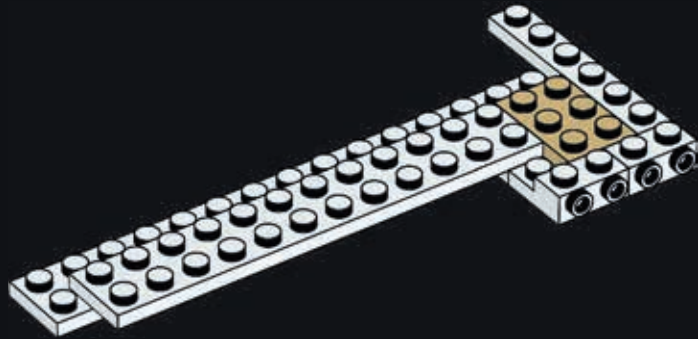

49

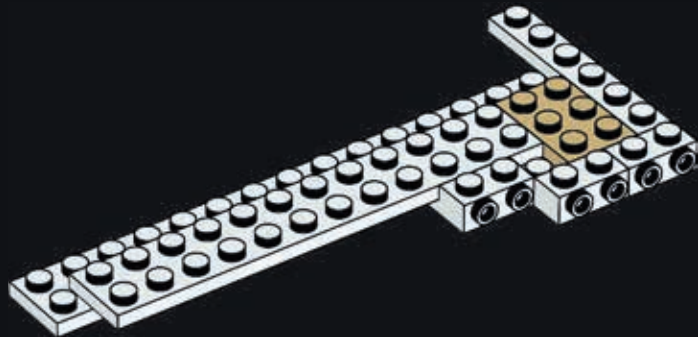



50

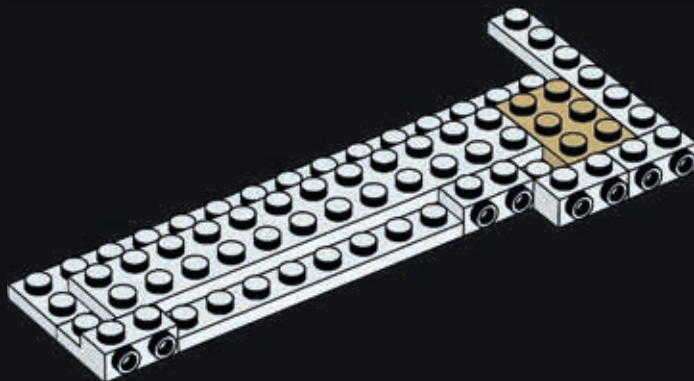

51

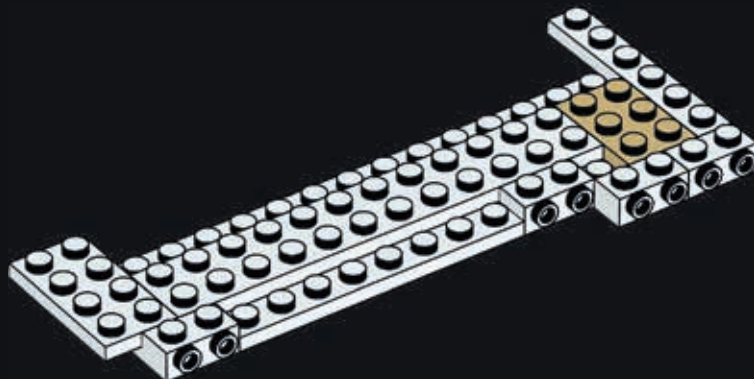



2x

52

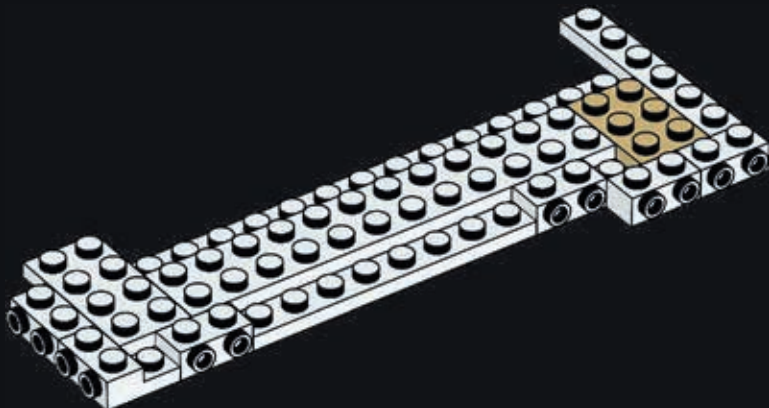

1x

53

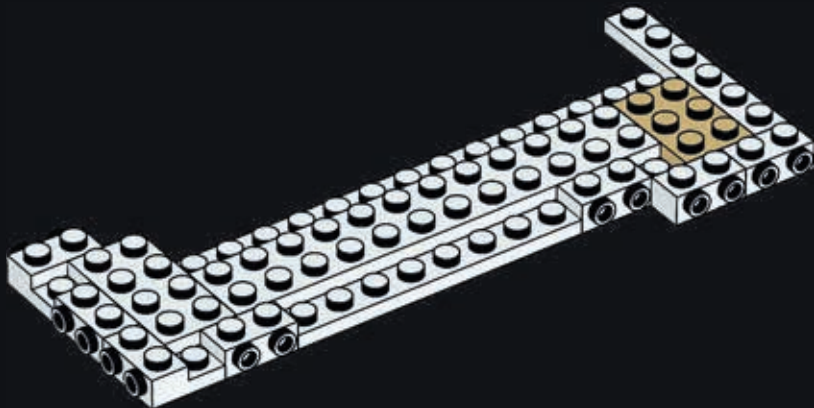



1x



5x

# 54

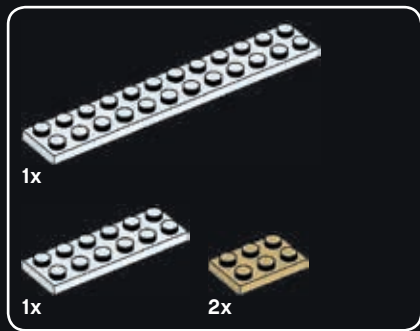
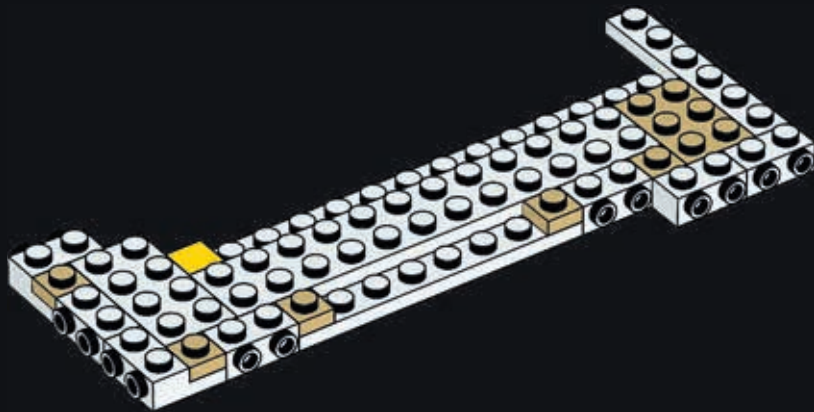

# 55

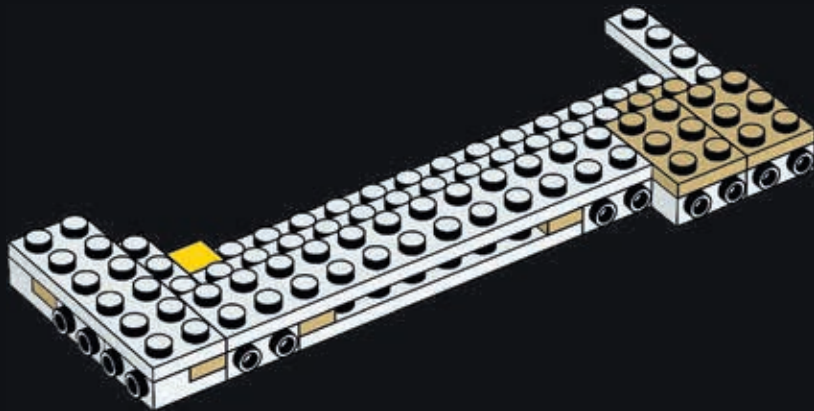

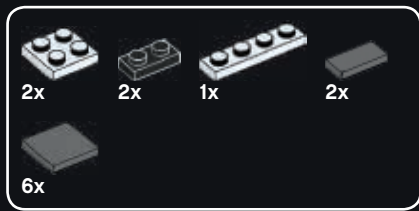

56

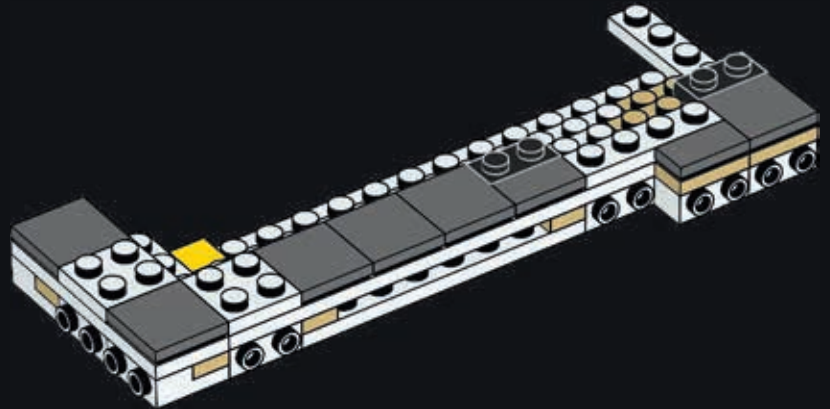

57

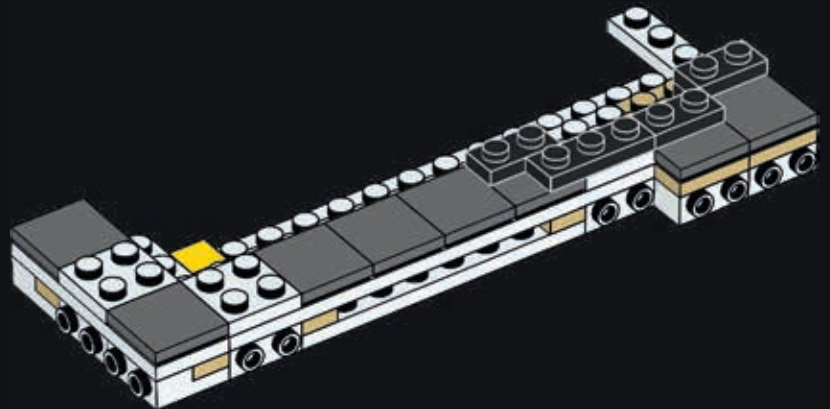

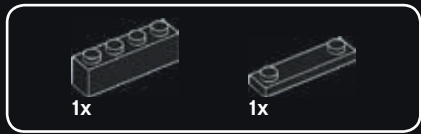

58

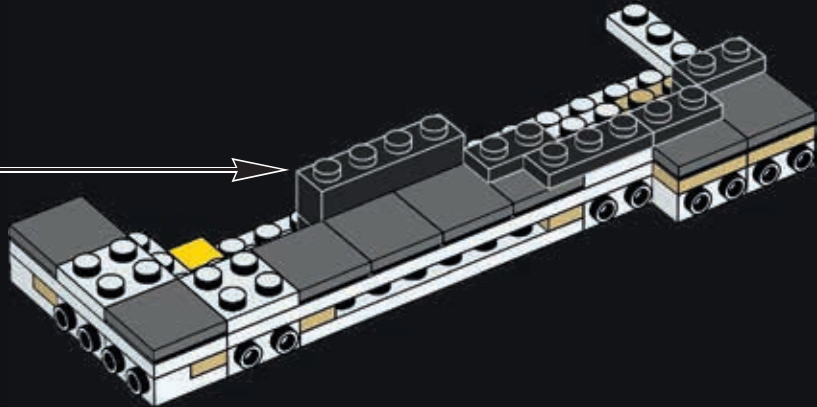
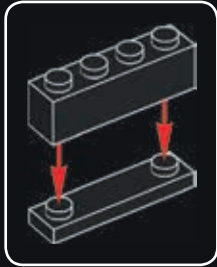

59

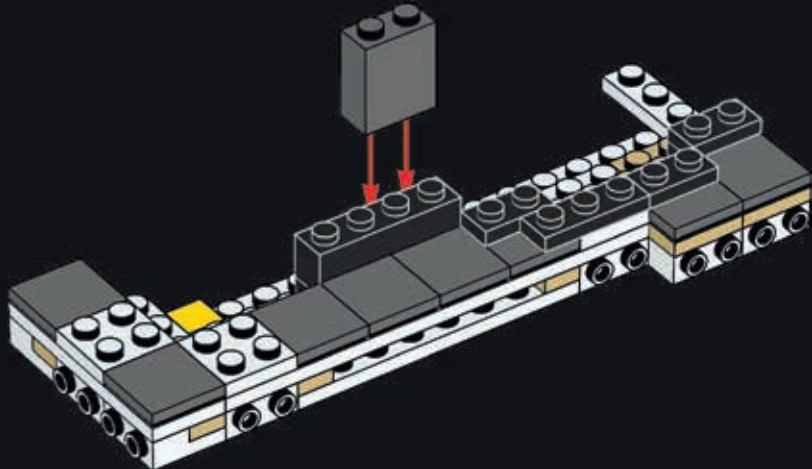





2x

60

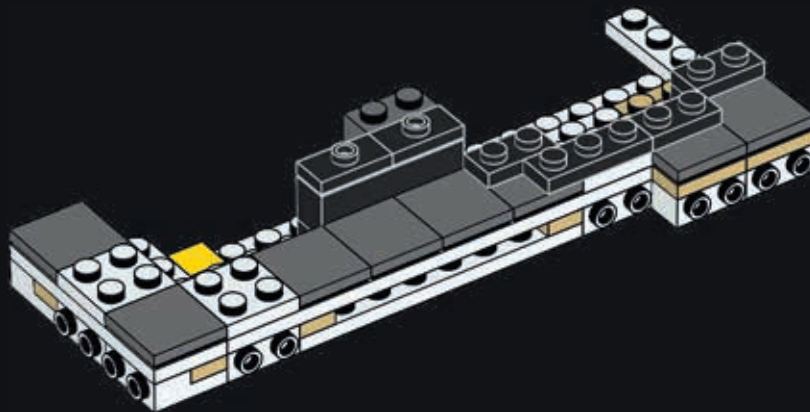

1x

61

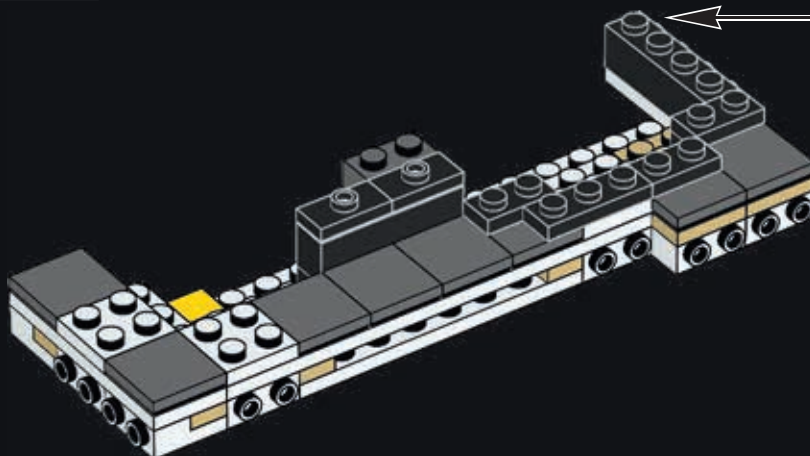



62

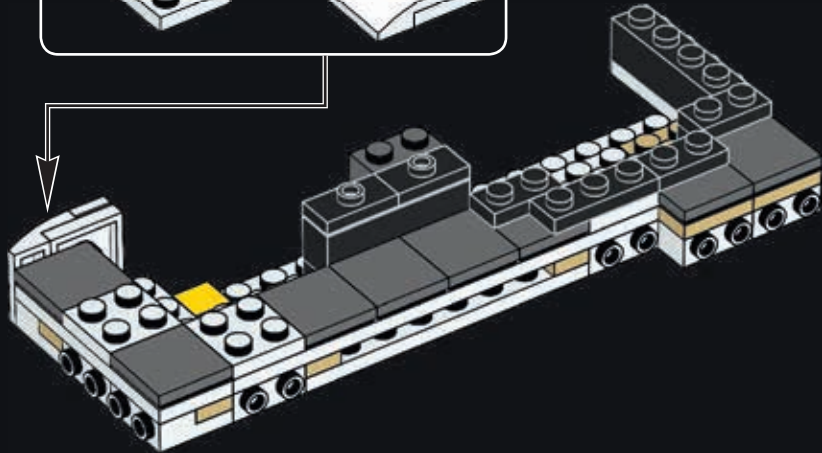
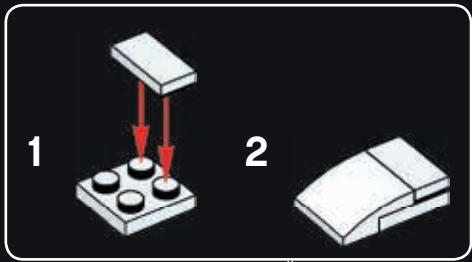

63

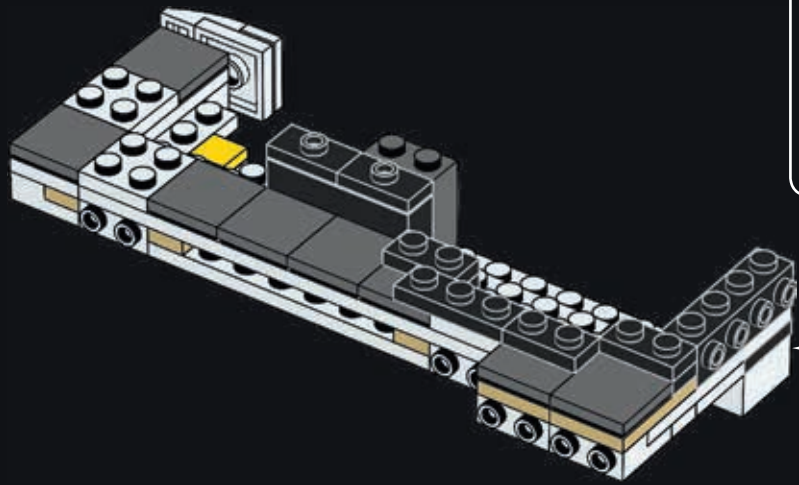
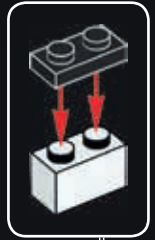

64

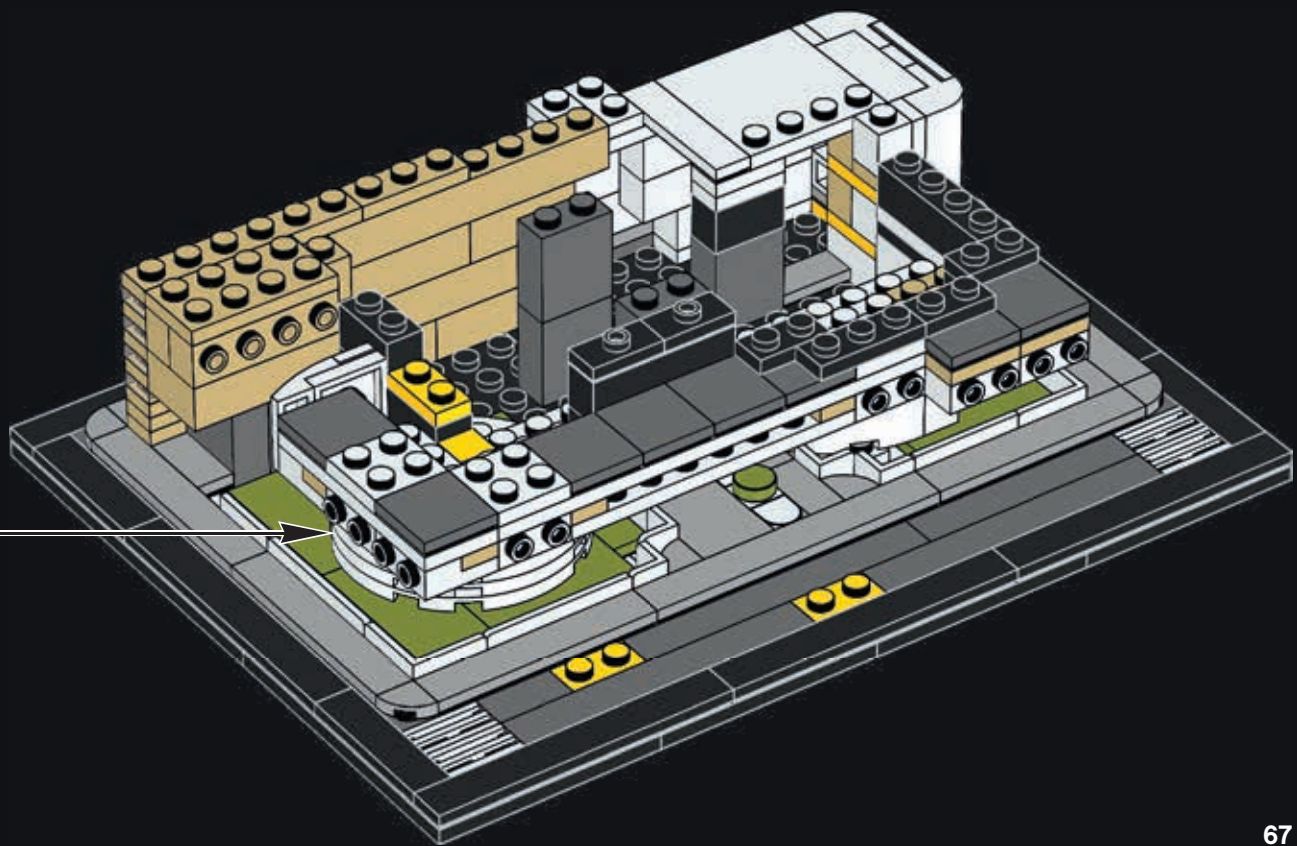

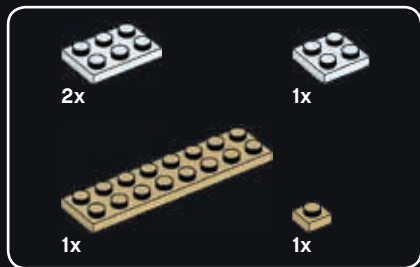

65

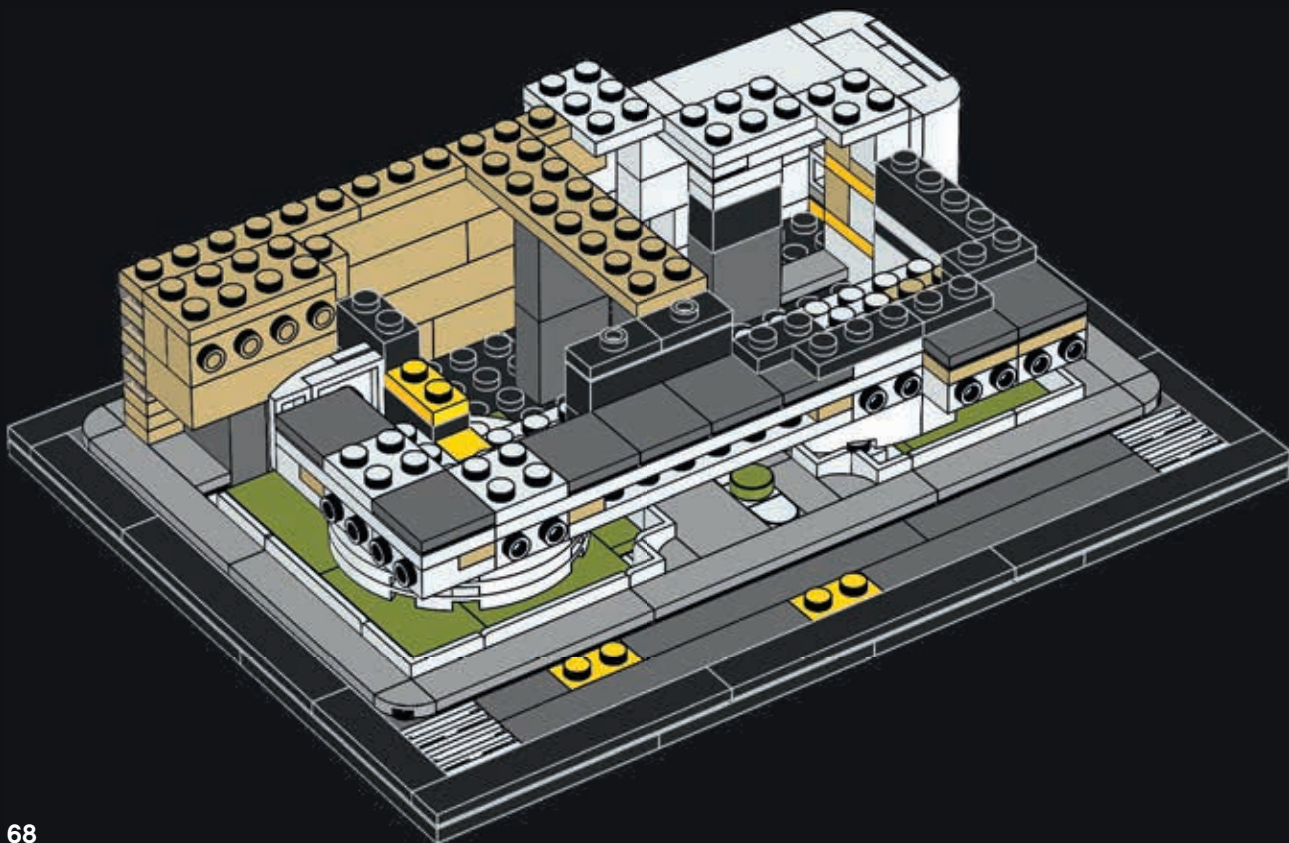

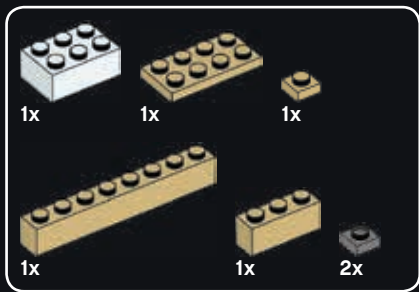

66

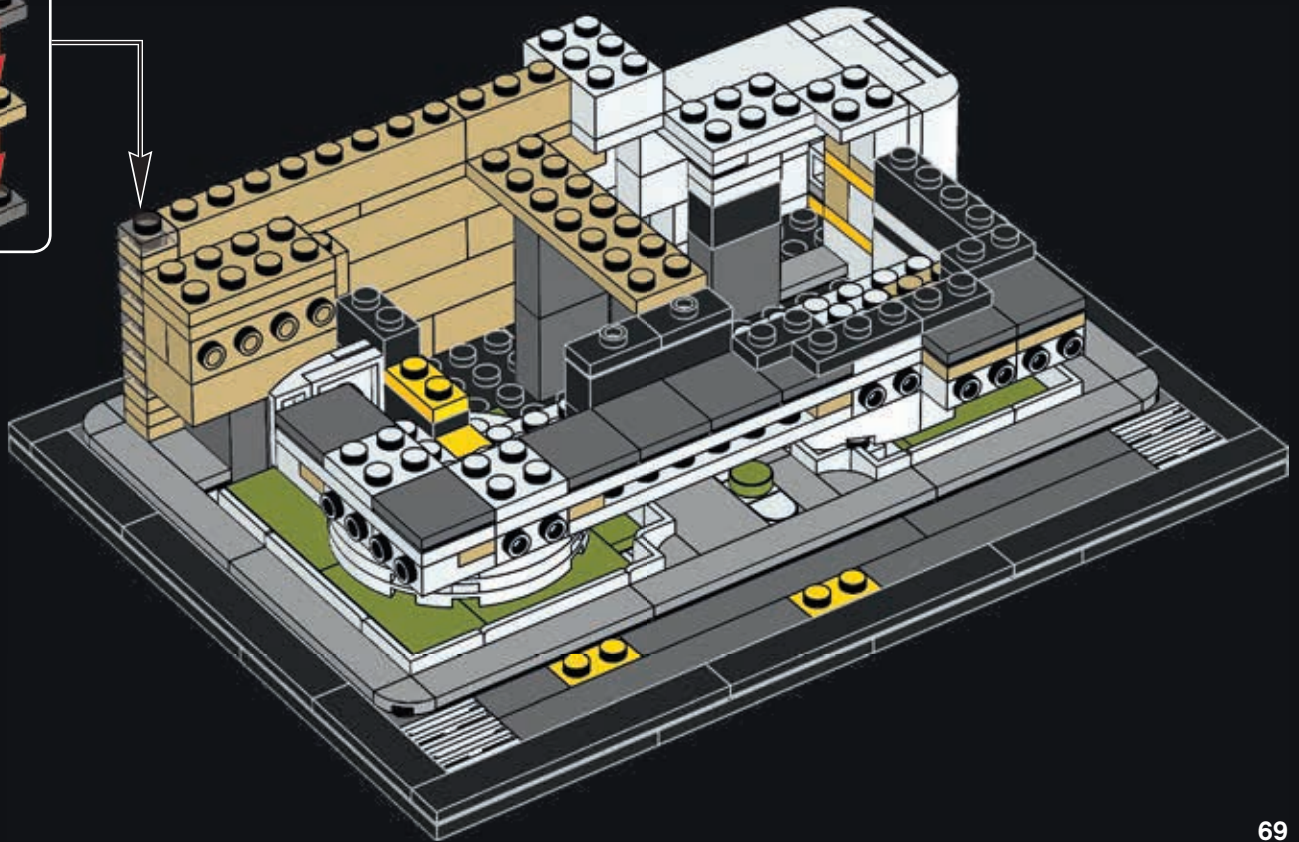
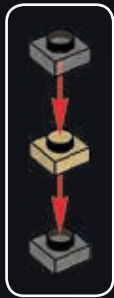

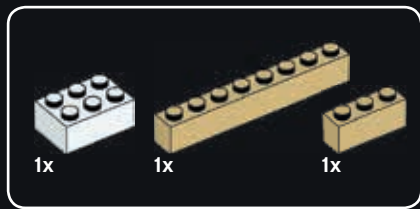

67

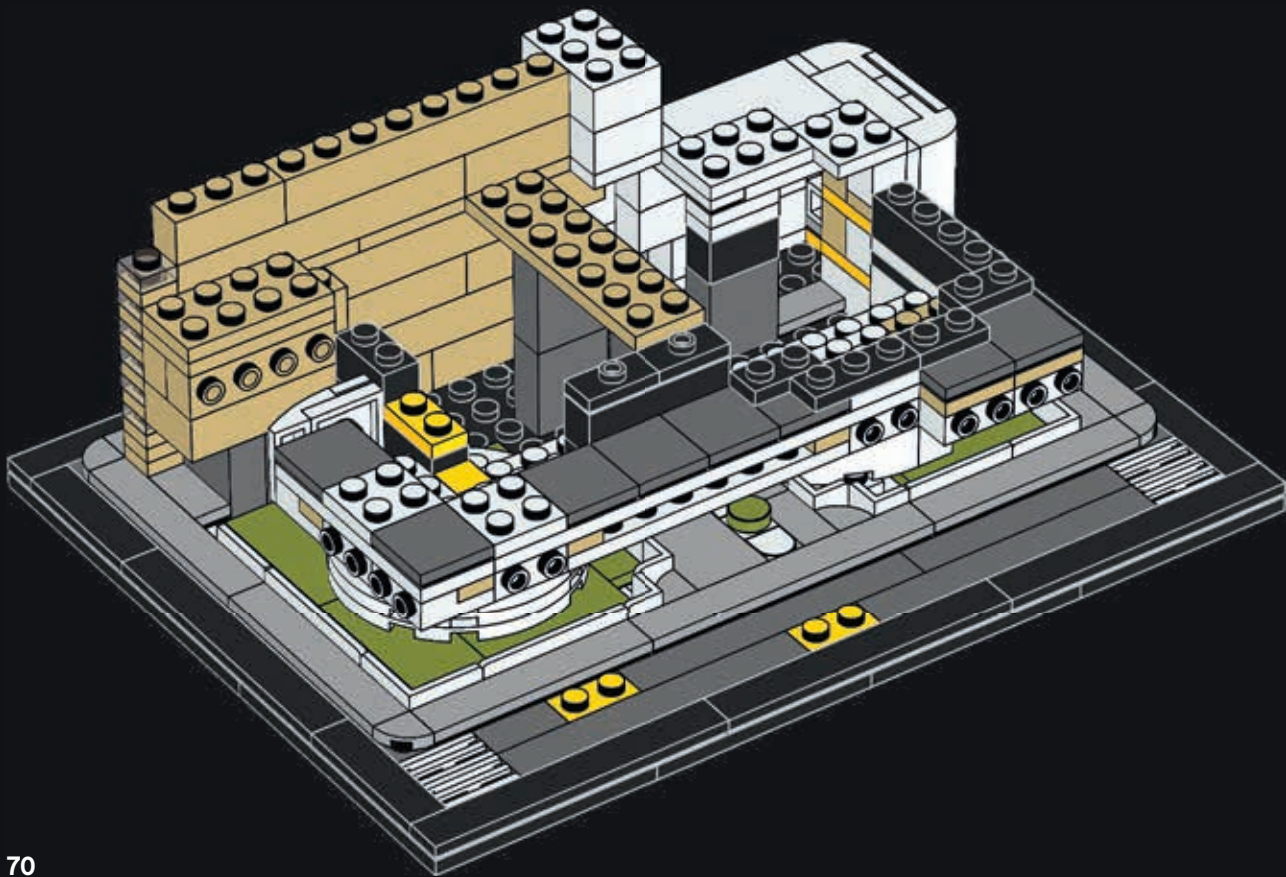



68

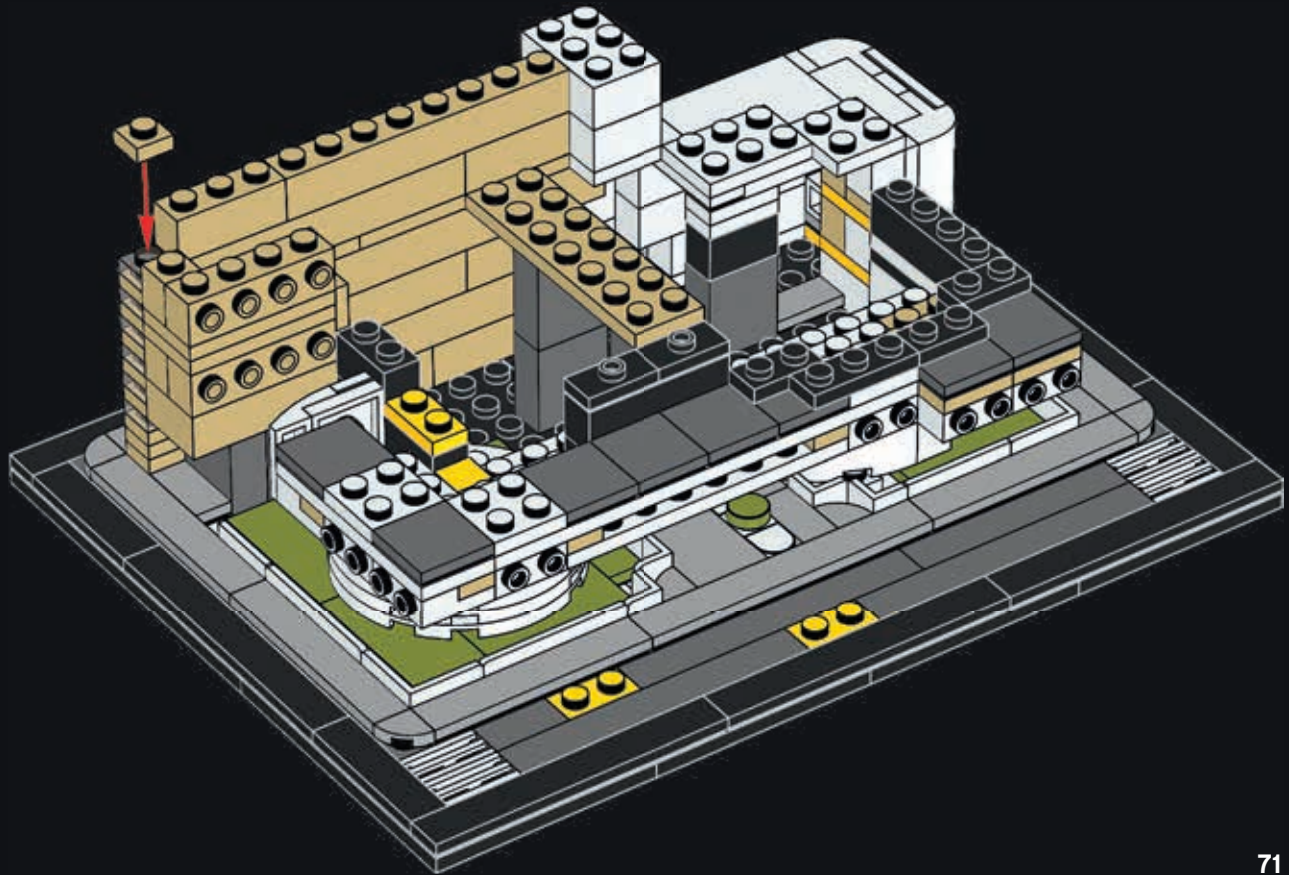



69

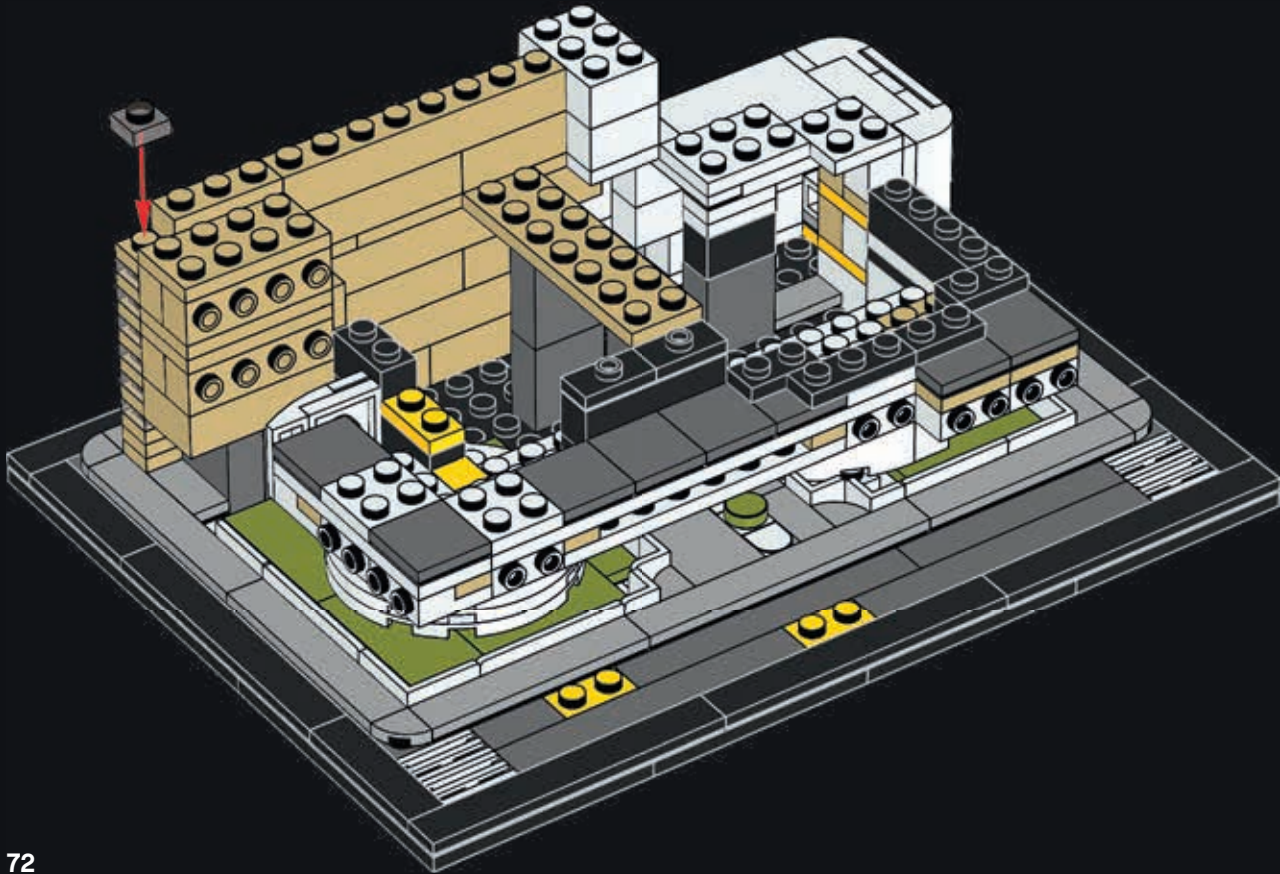





70

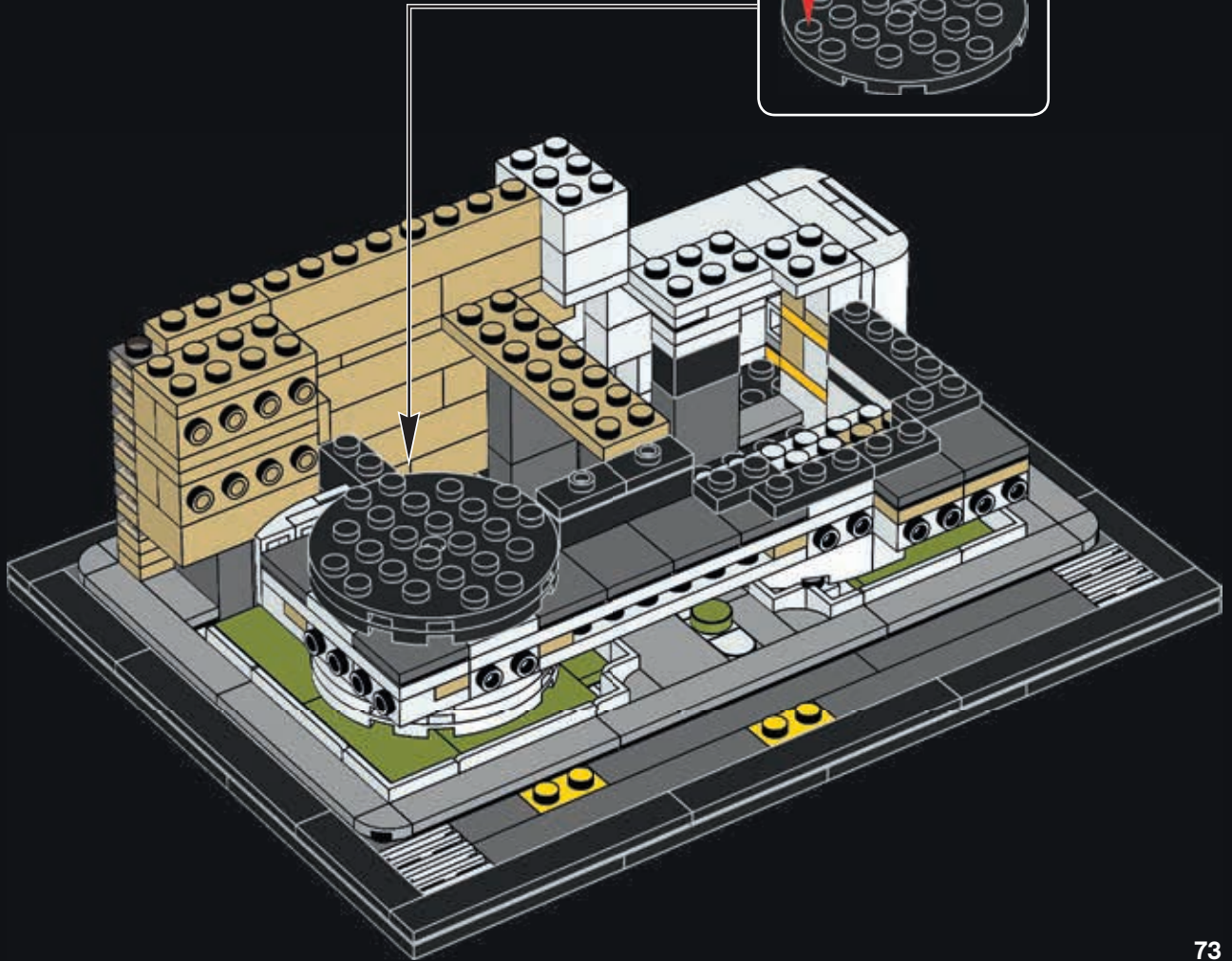
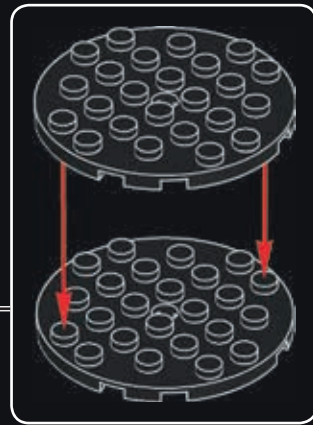



71

1



2

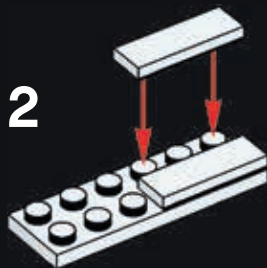

3

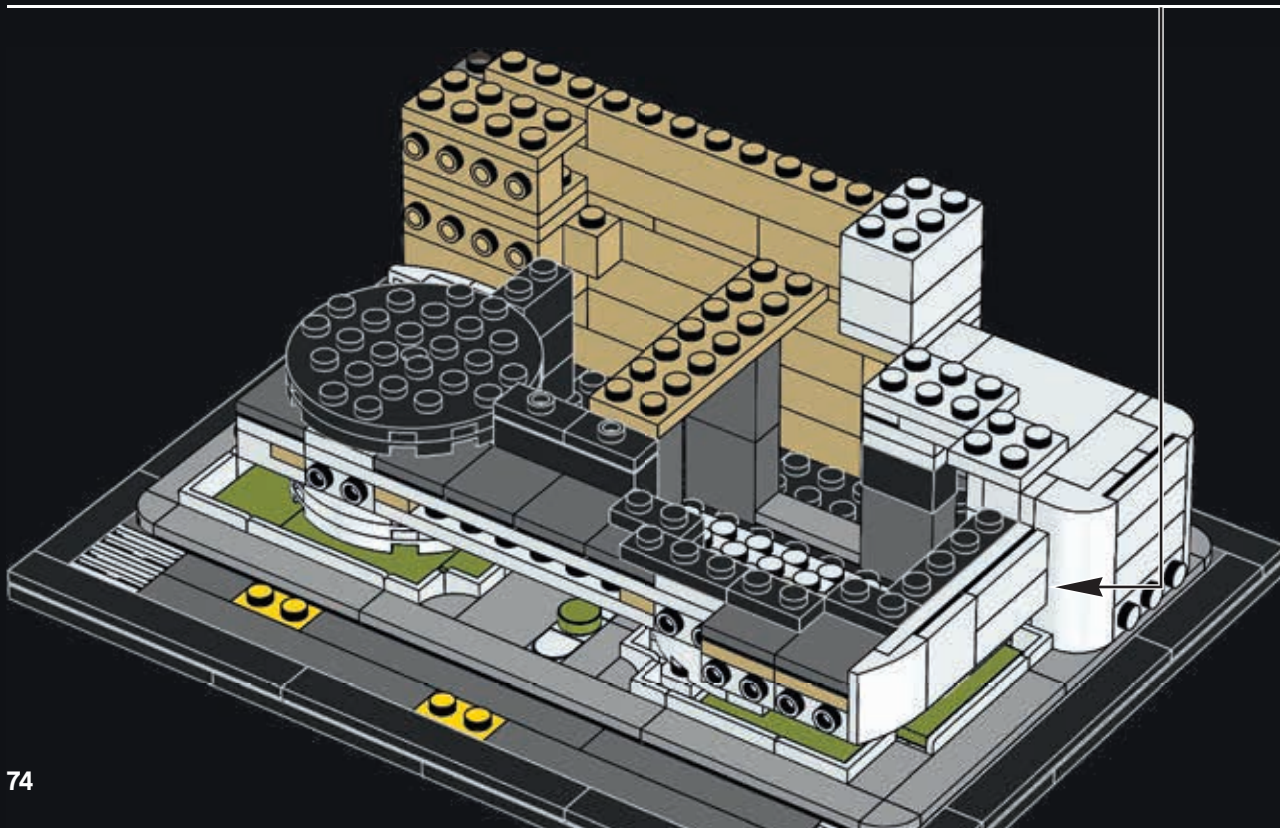
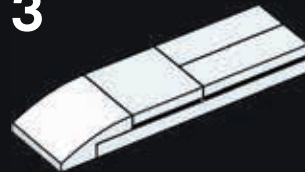



72

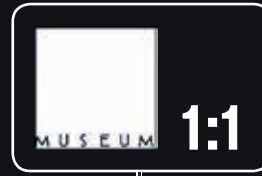

1



2

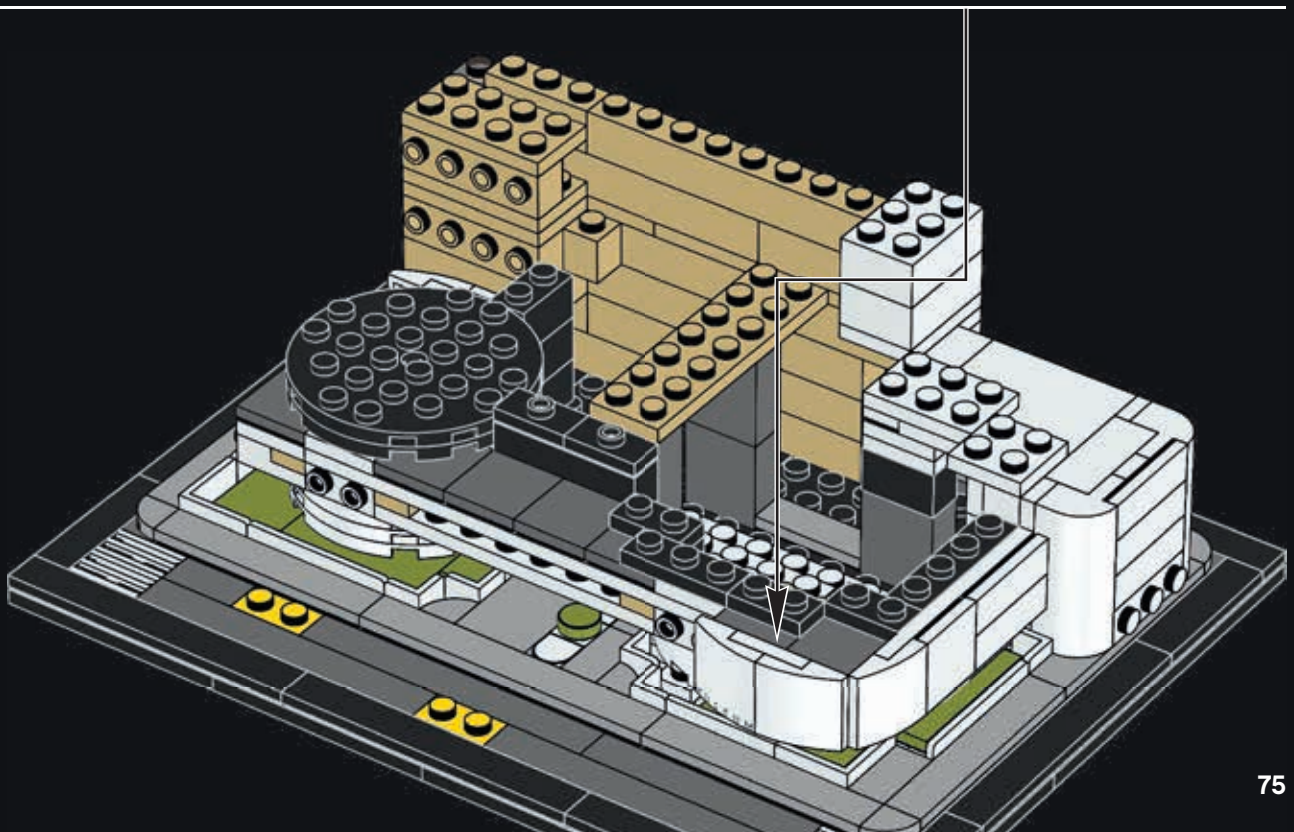

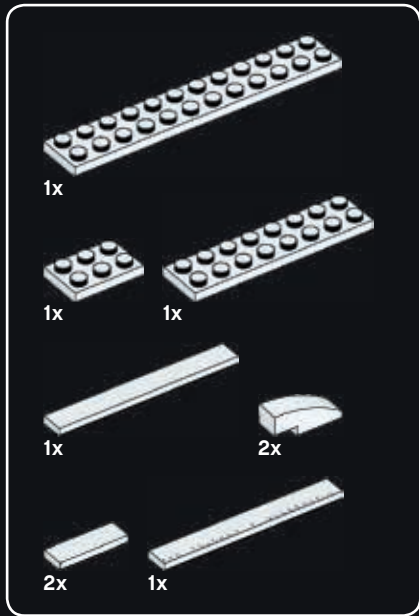

73

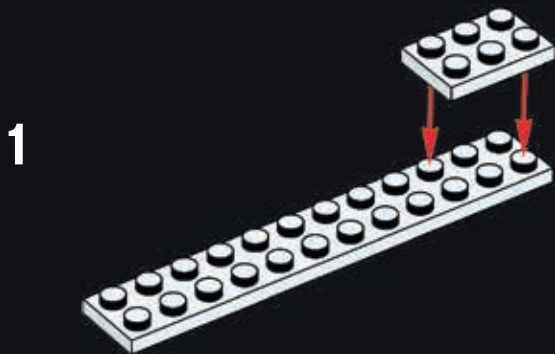

76

2



3



4

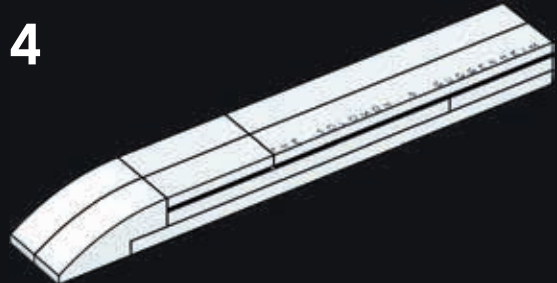

The seal on the floor of  
the Guggenheim entrance  
says, "Let each man  
exercise the art he knows"  
– Aristophanes 422 B.C.

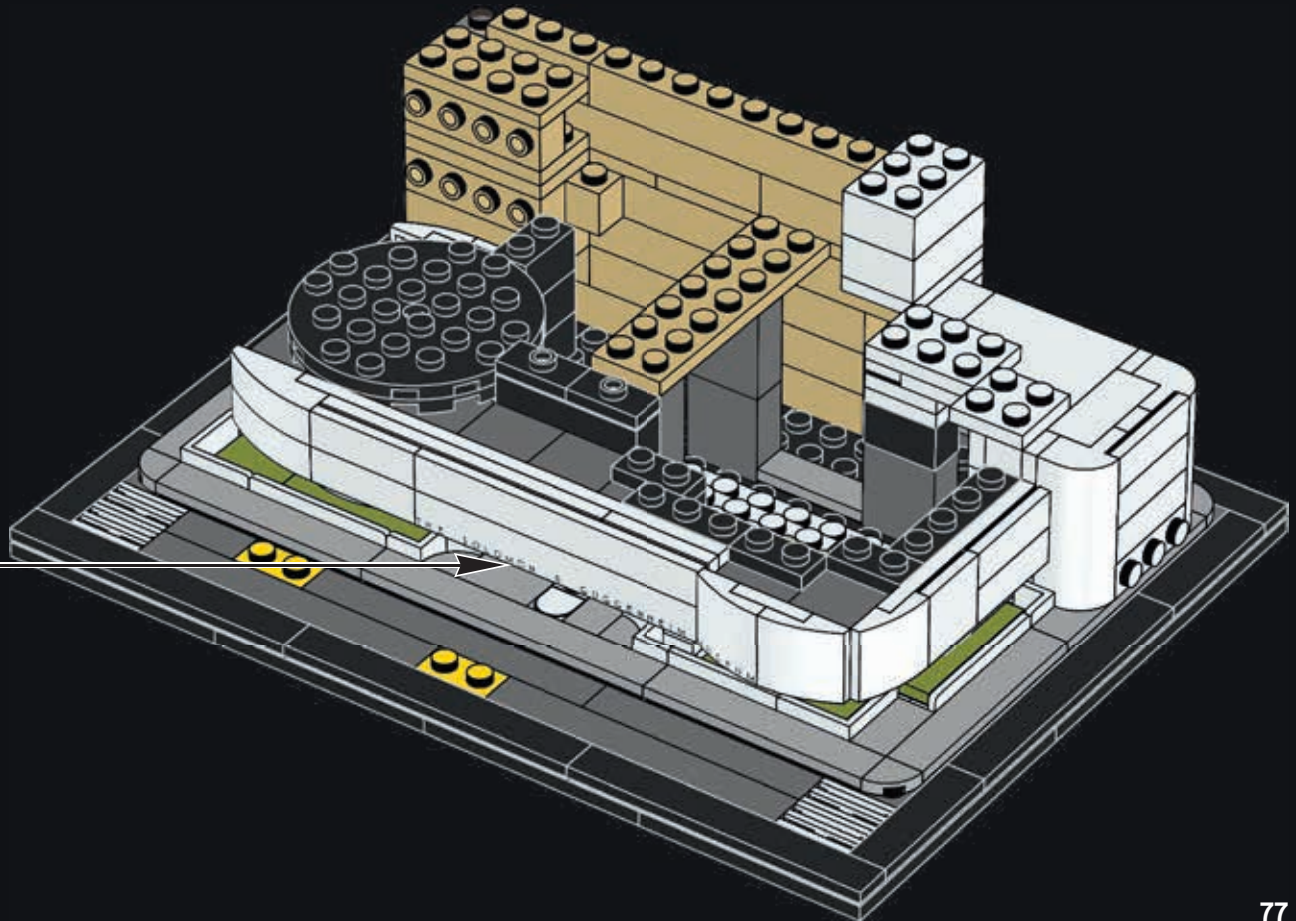



74

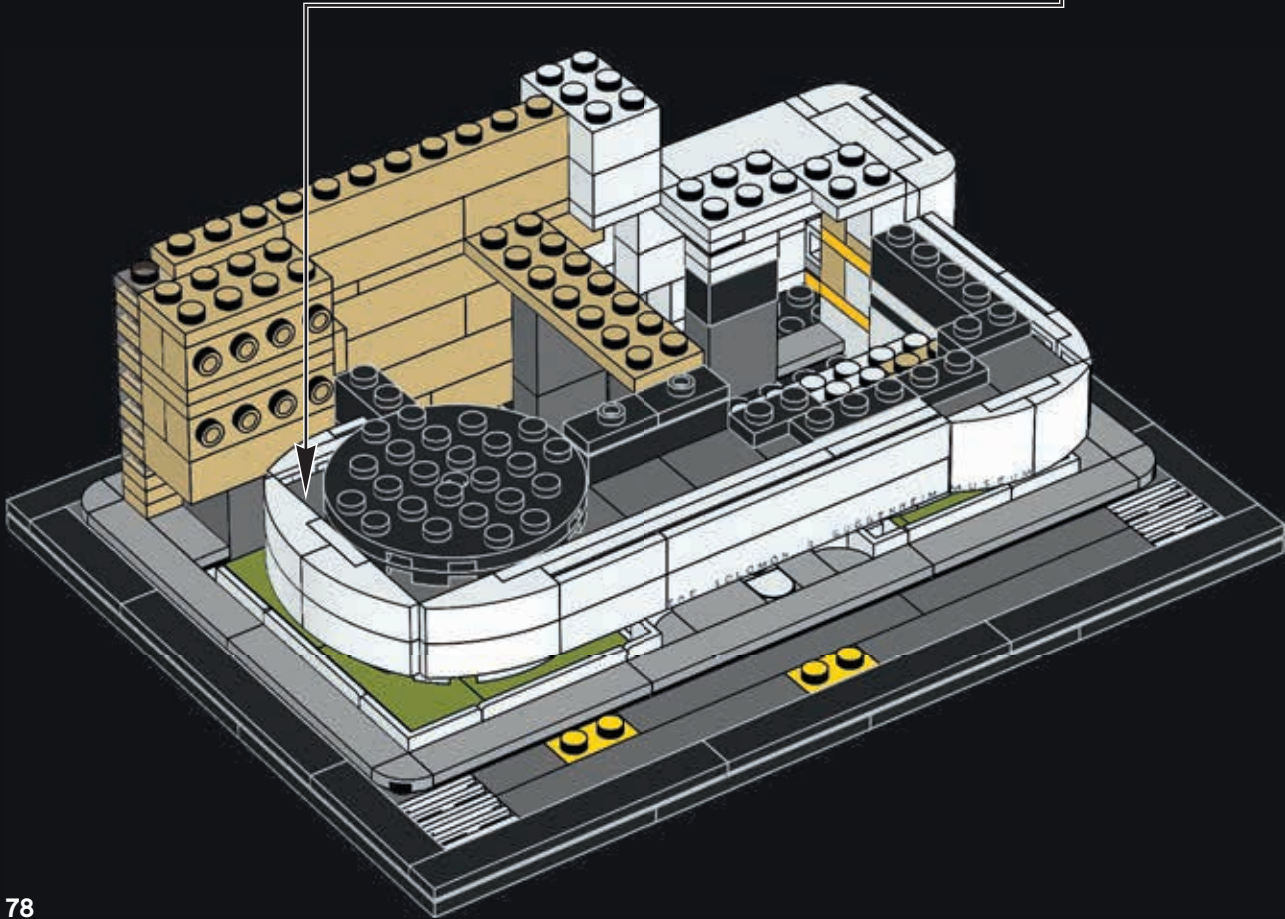
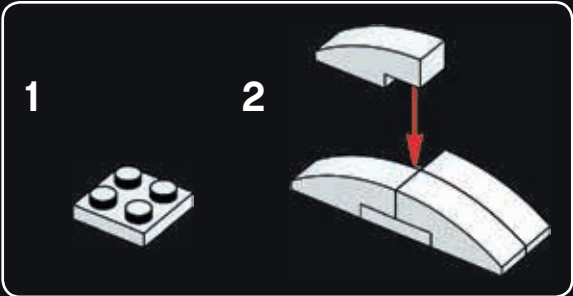



75

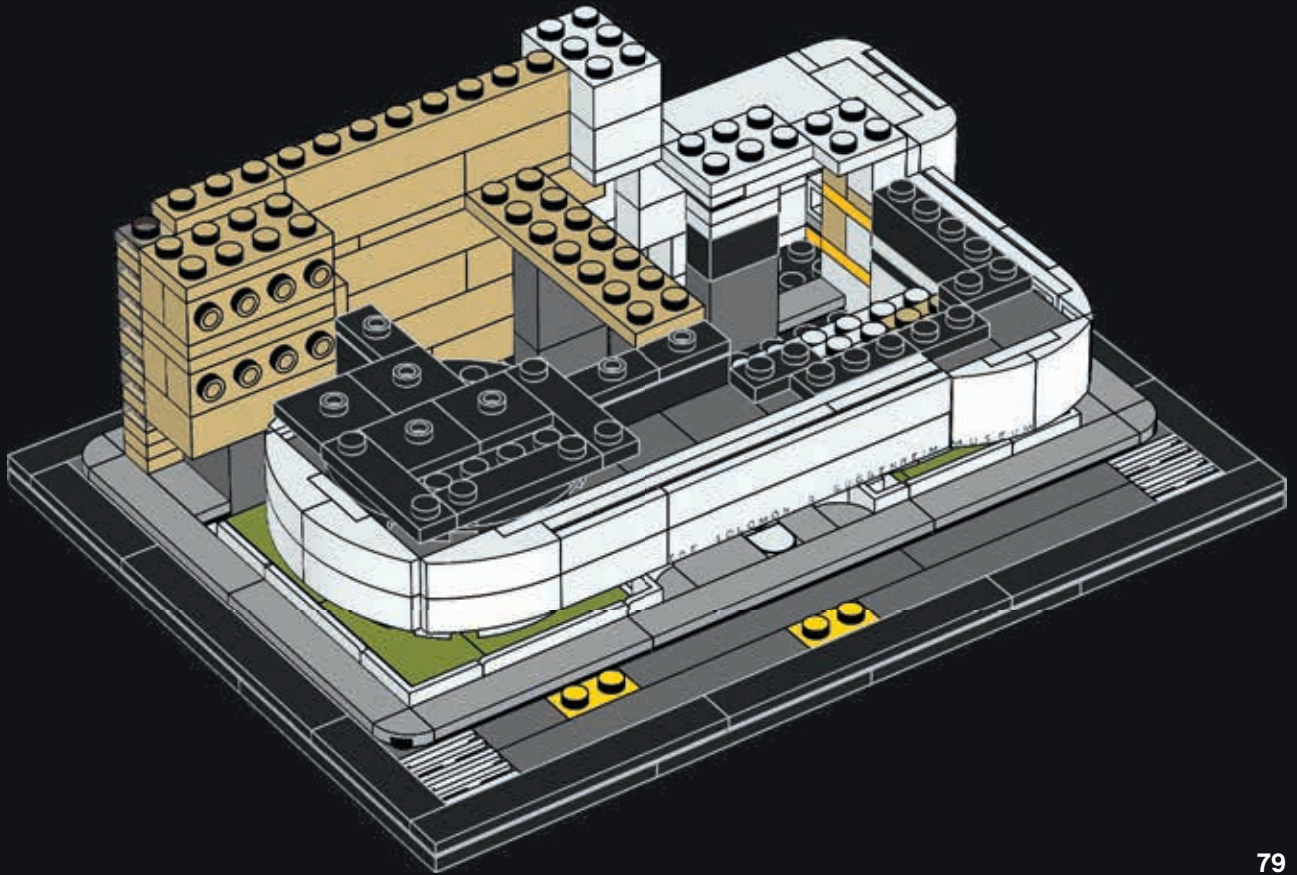



1x

76

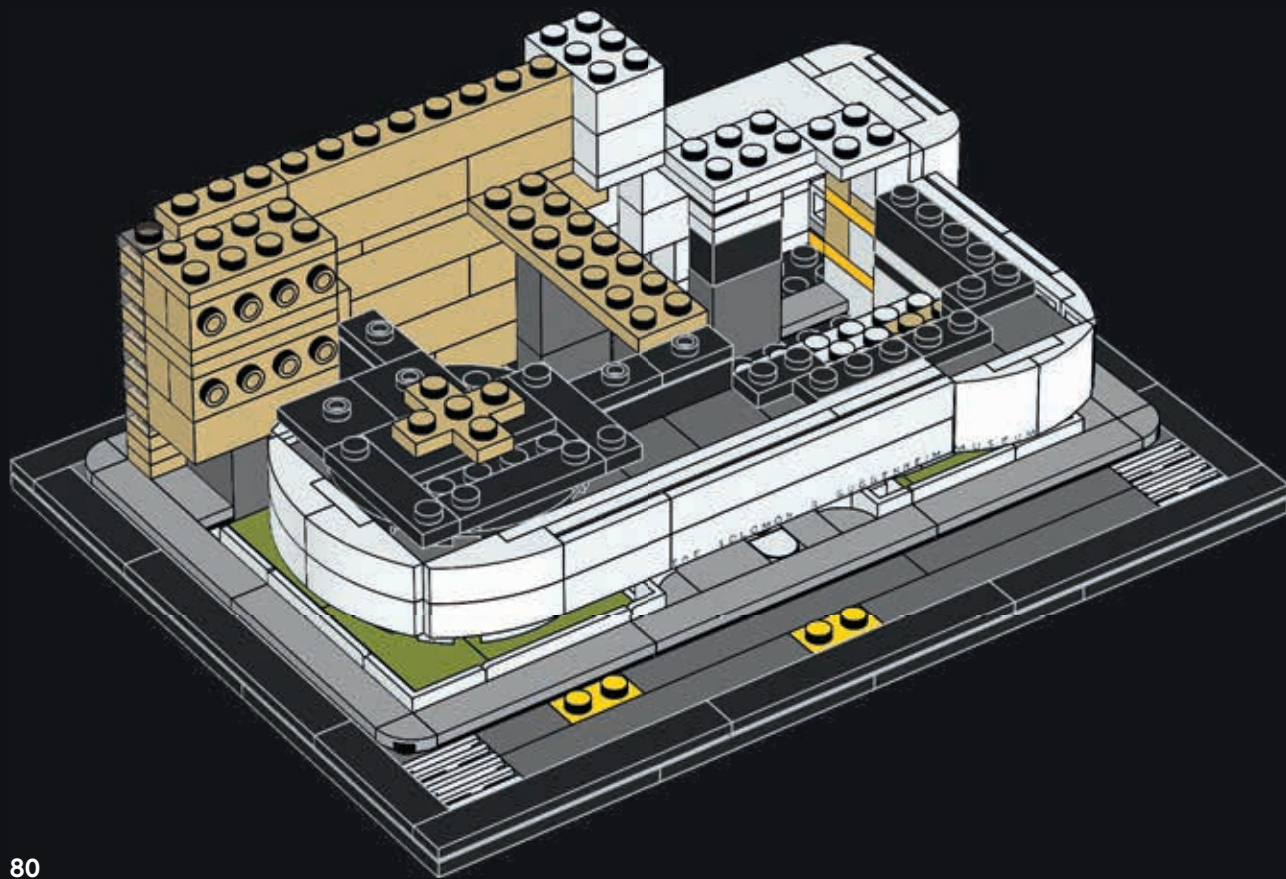





77

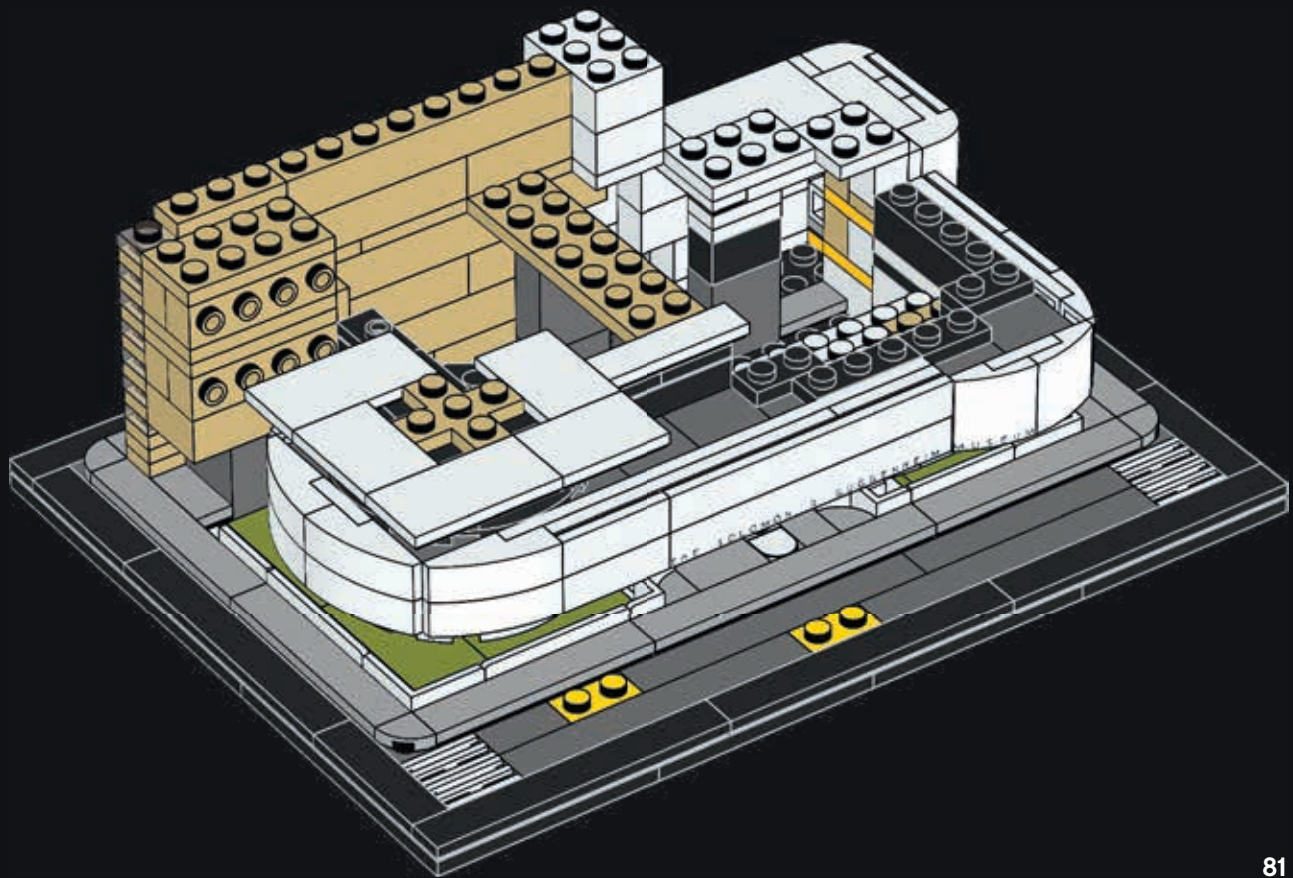



1x

78

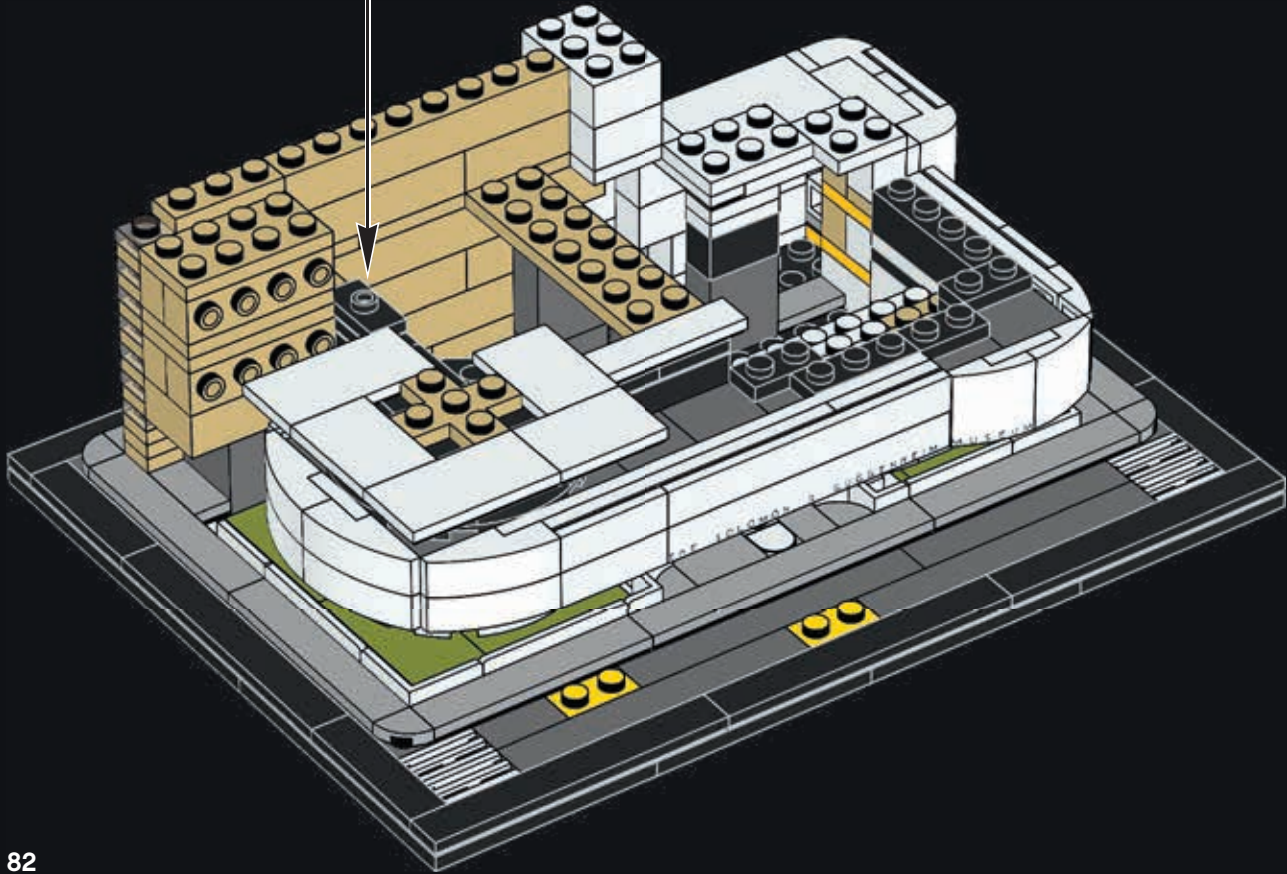



79

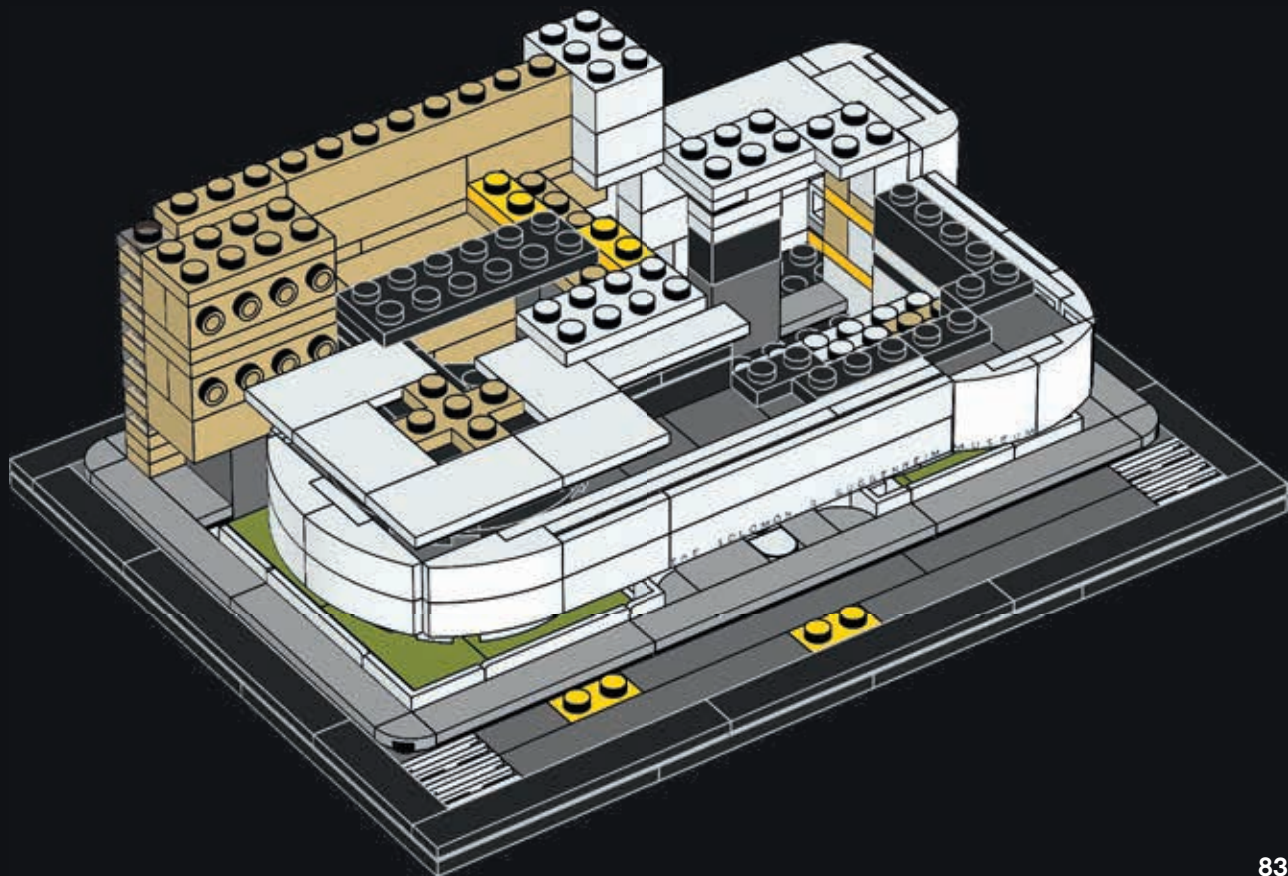

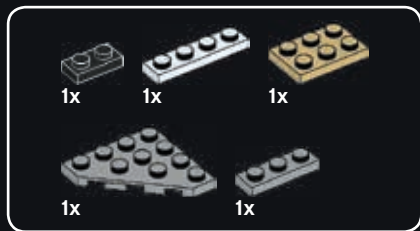

80

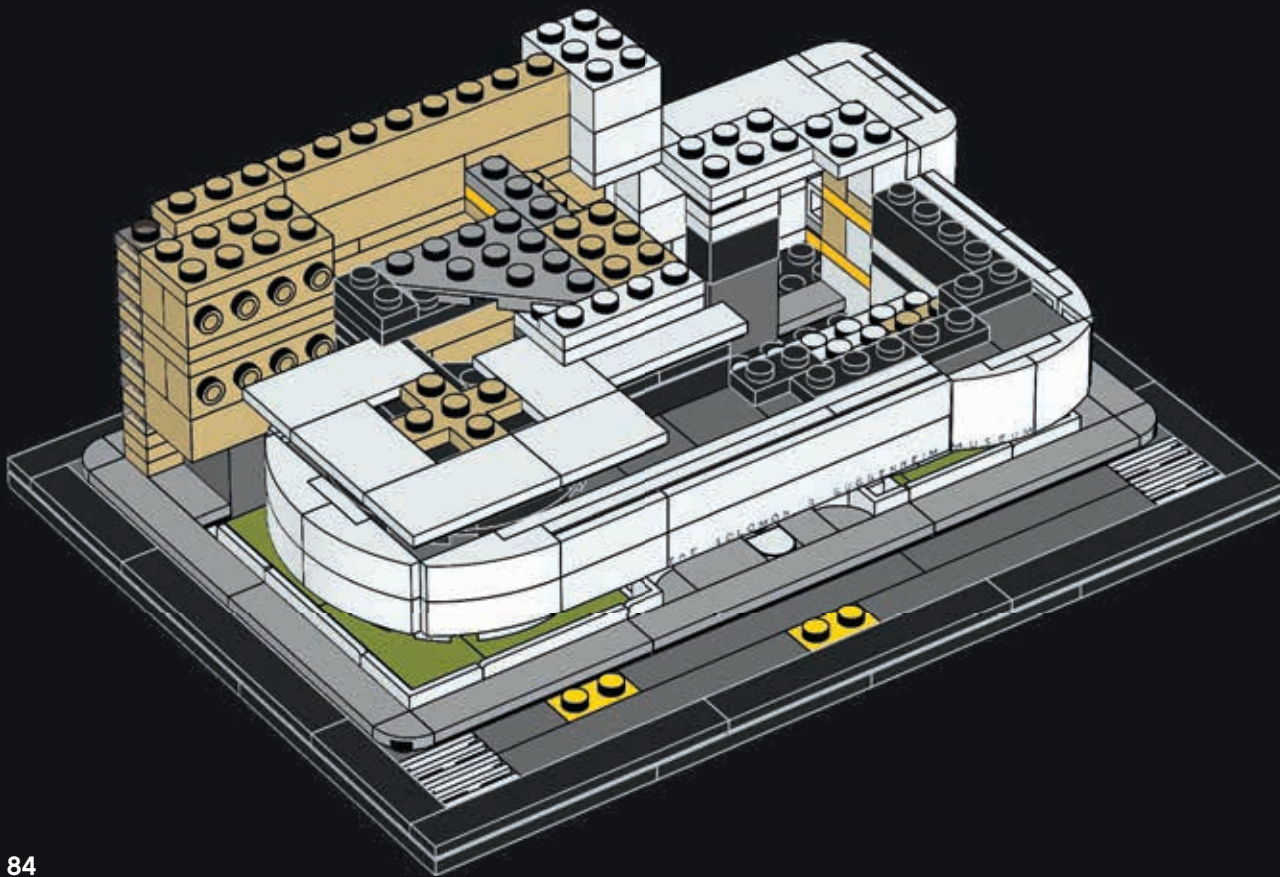



81

The Guggenheim building is made of 700 tons (635,000 kg) of steel and 7,000 cubic feet (198.2 cubic meters) of poured concrete.

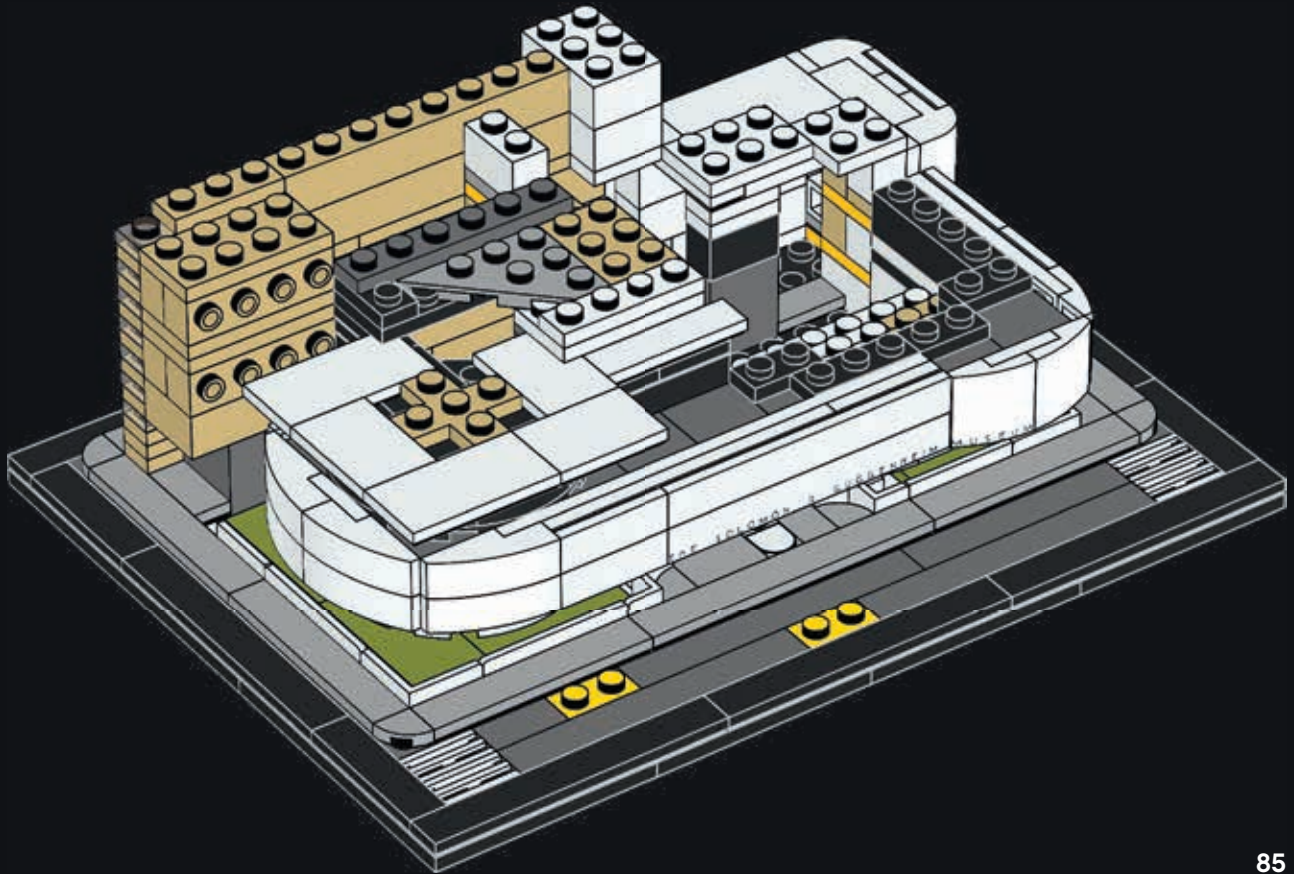



82

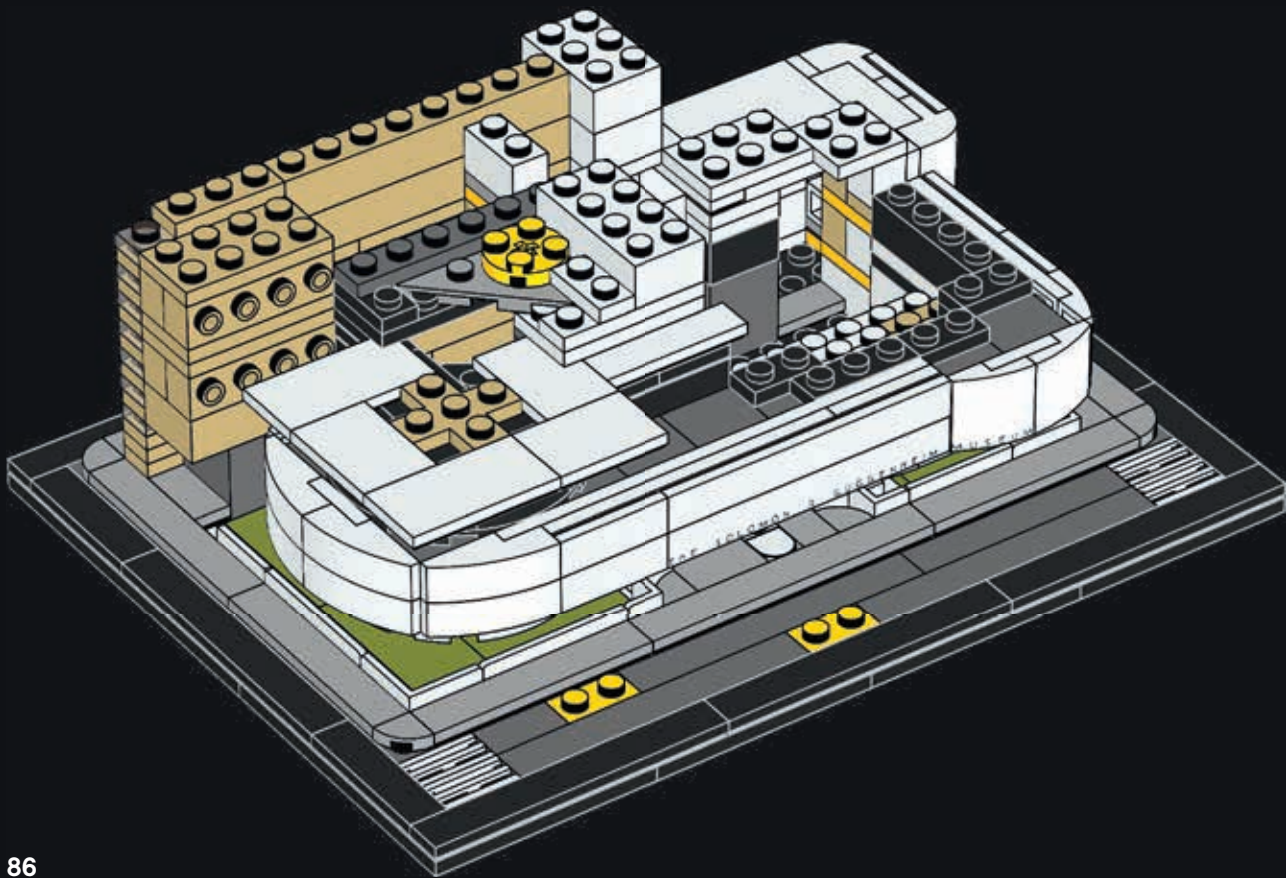



83

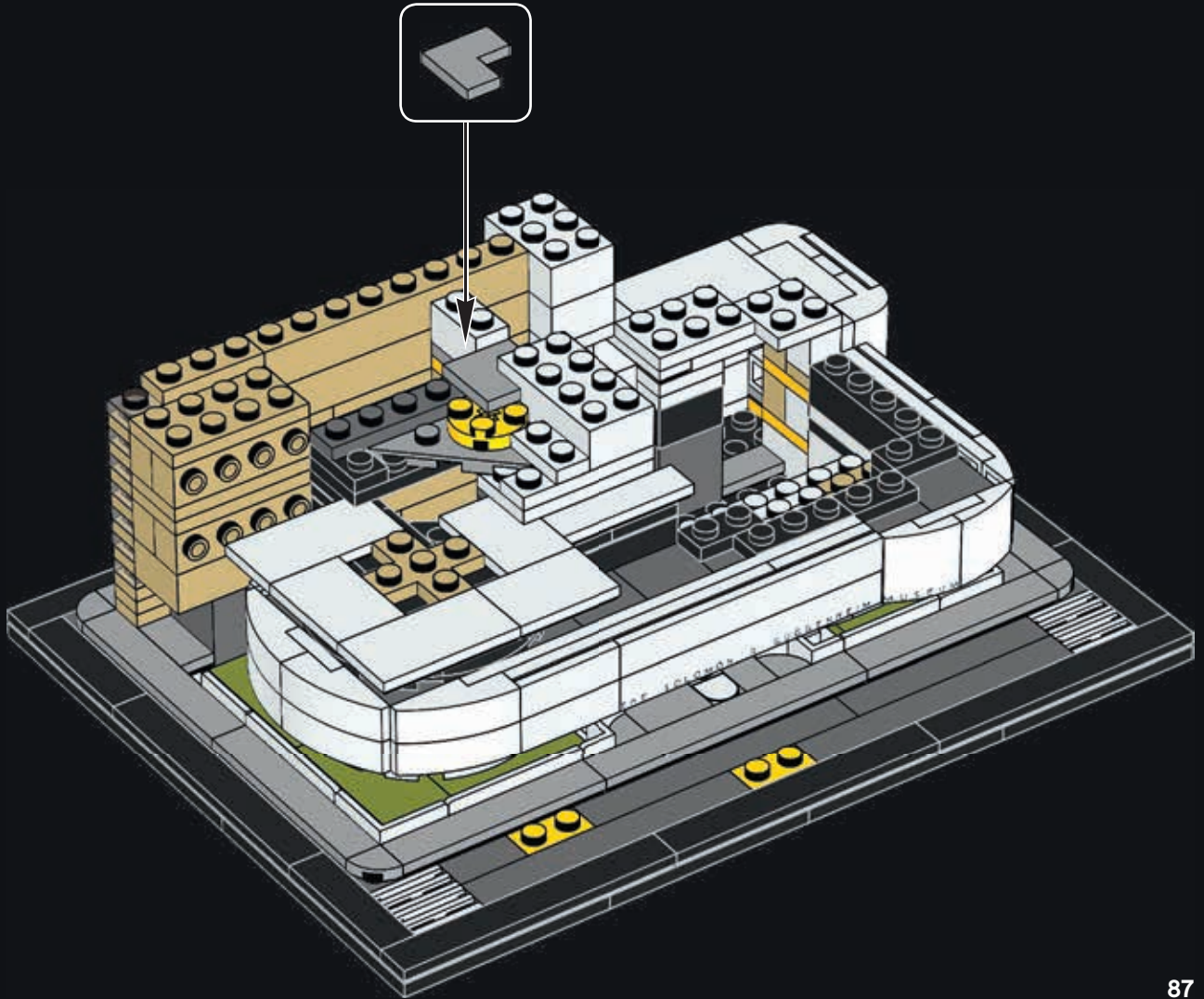

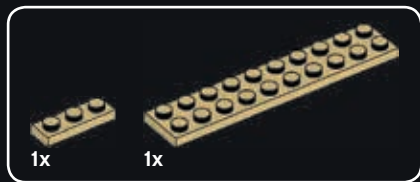

84

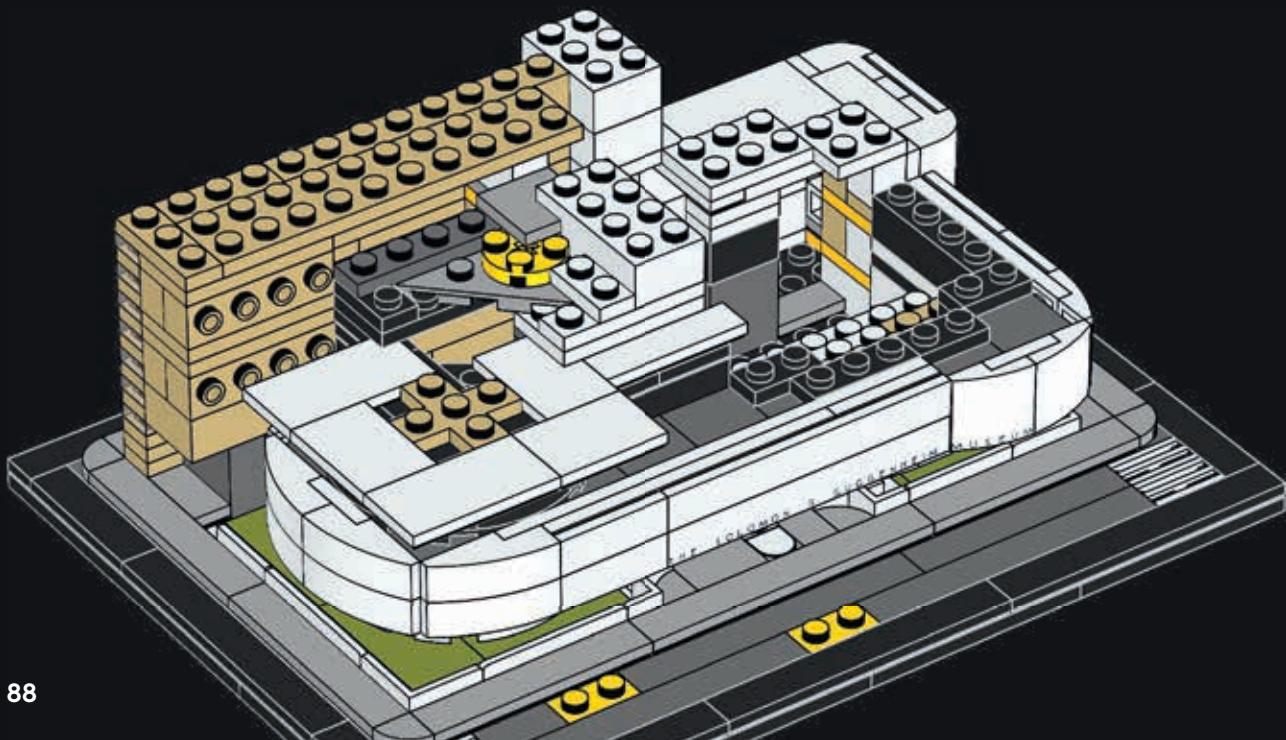





85

1



2



3



4

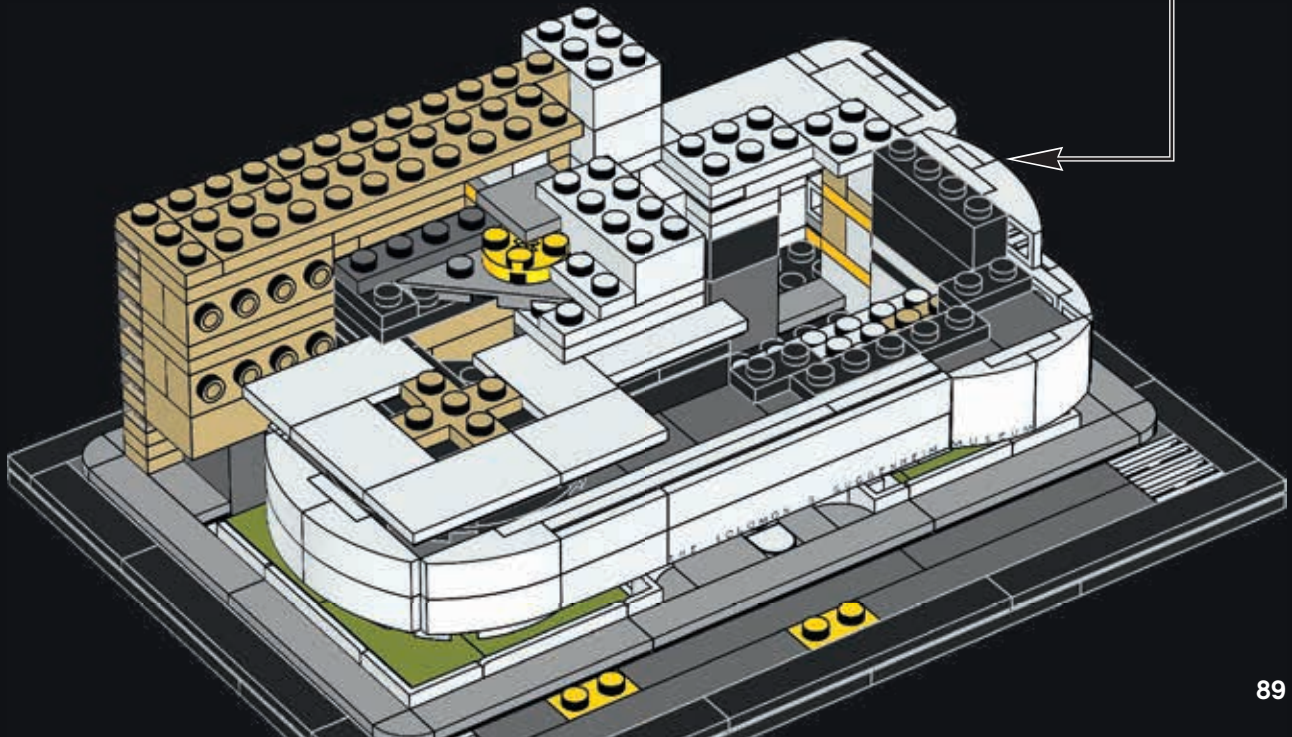
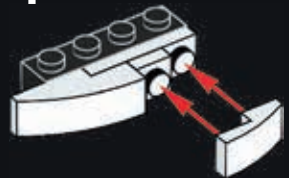



86

1

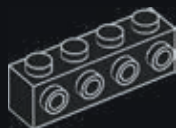

2



3



4

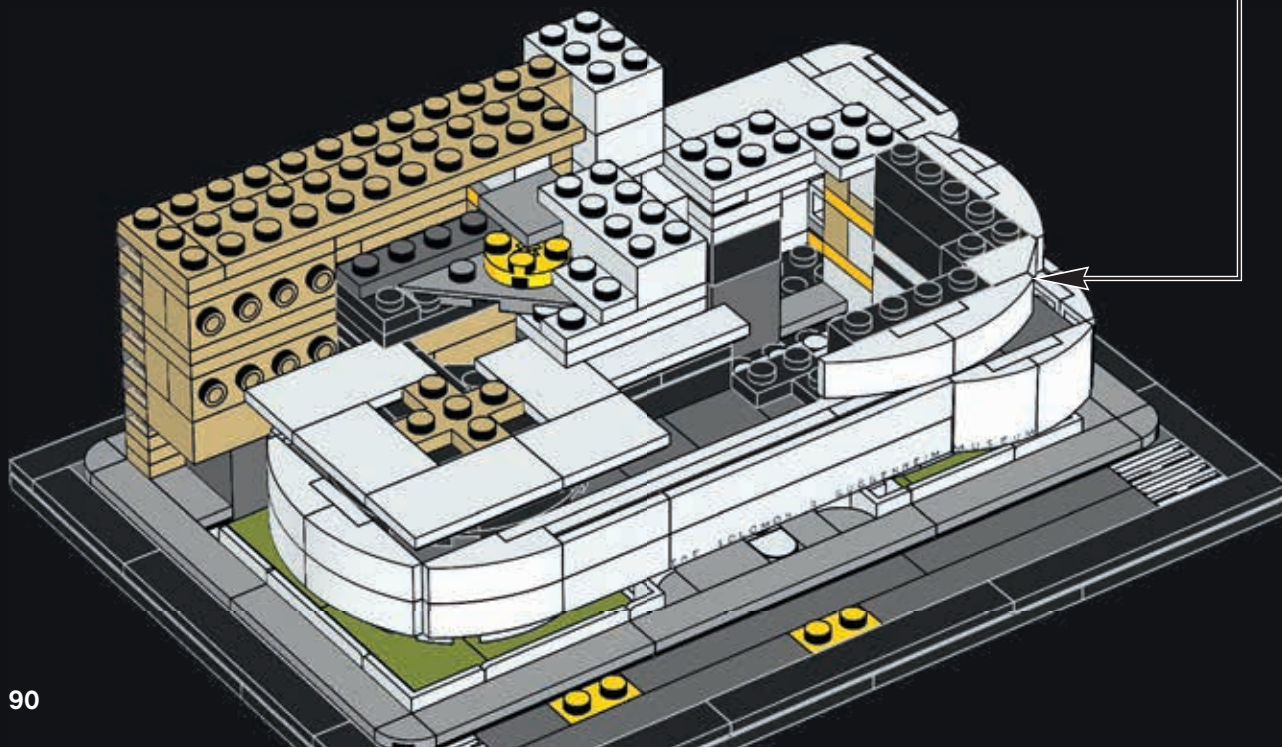
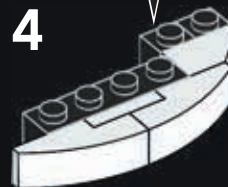



1x

87

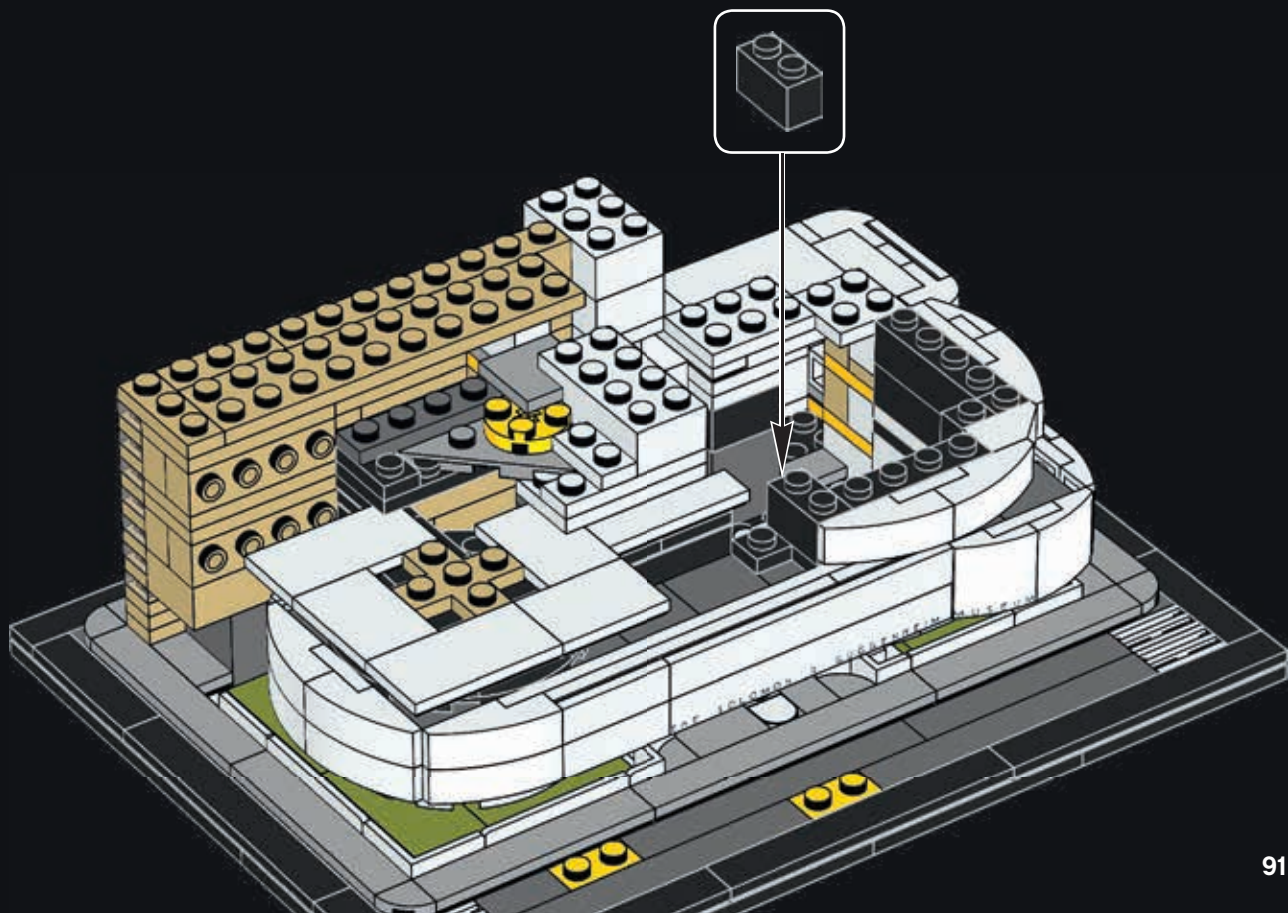

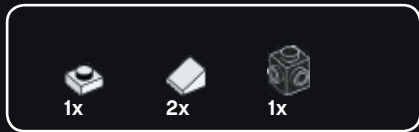

88

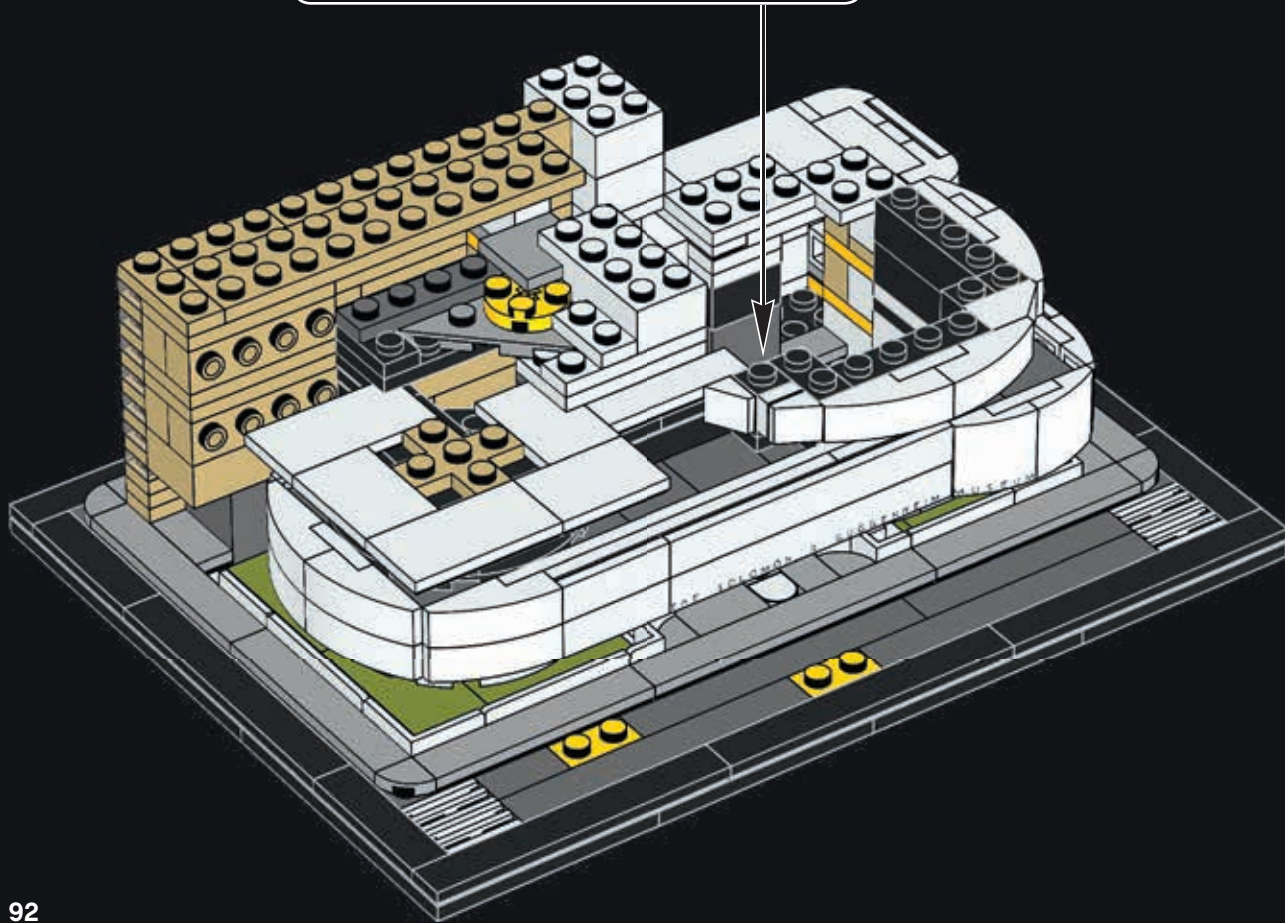



2x



1x



3x



1x

# 89

1

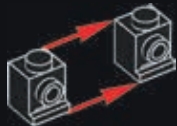

2



3



4



5

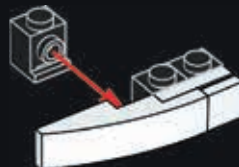

6



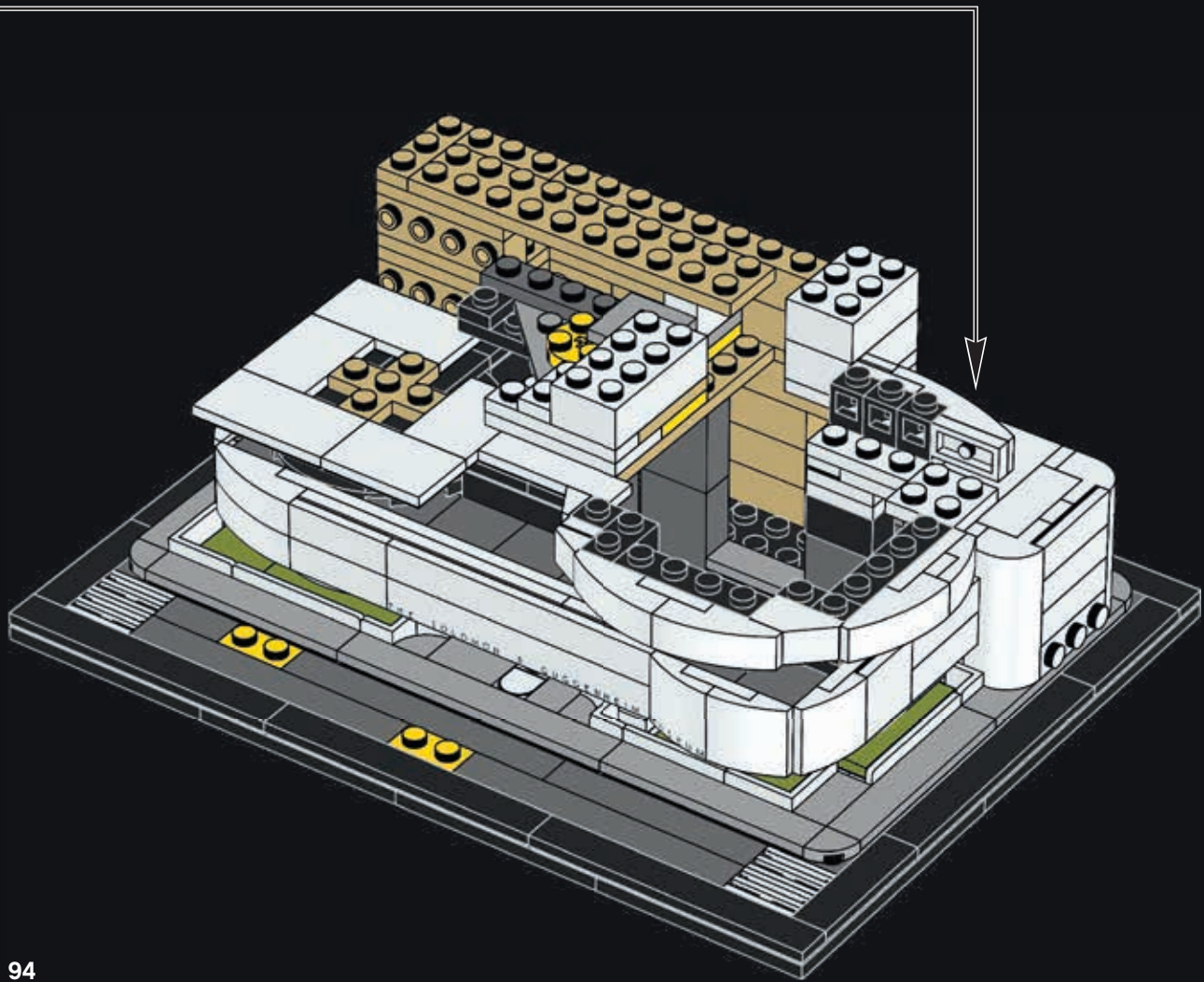



2x

90

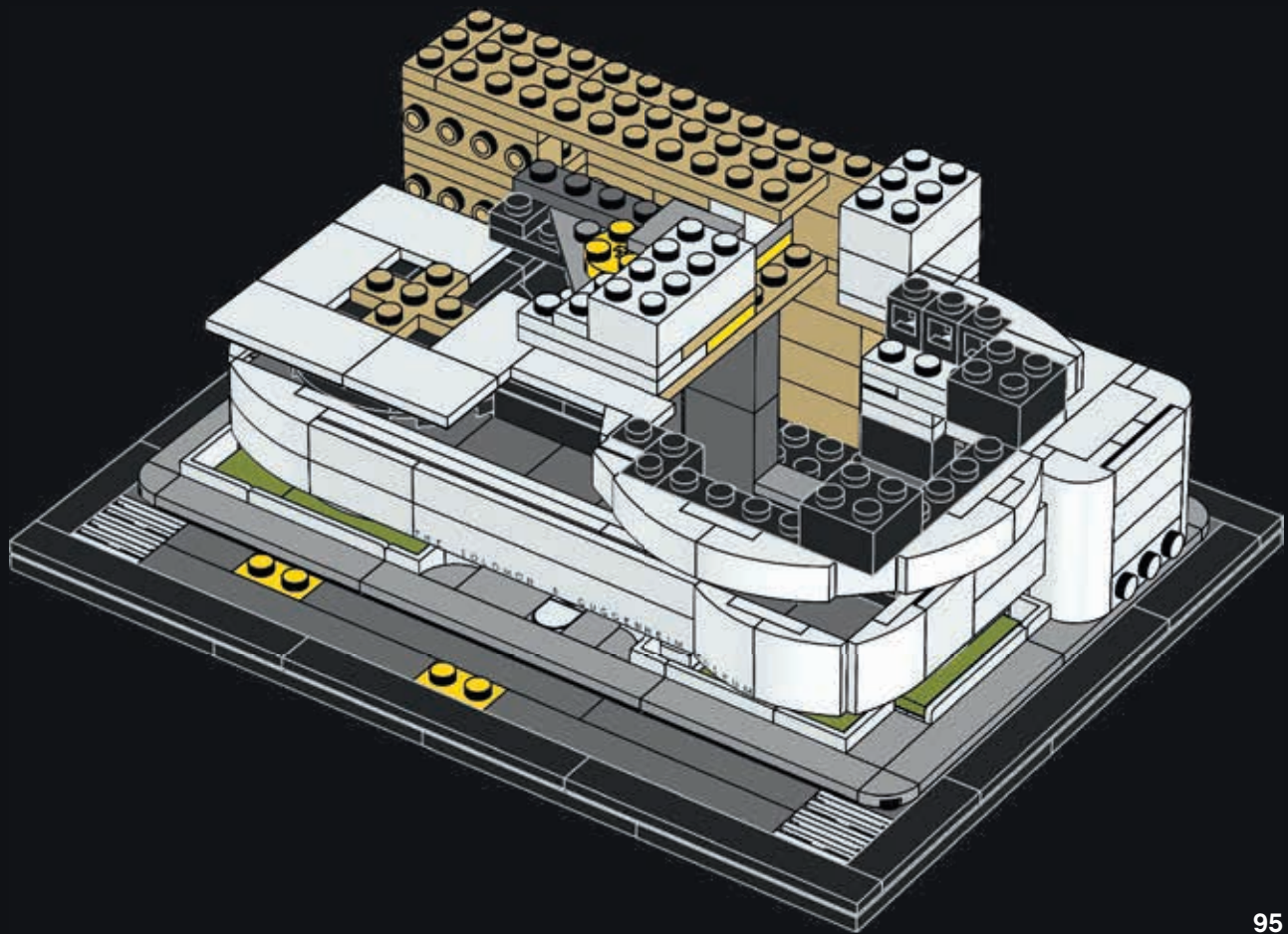



2x



2x



4x



4x



4x



2x



4x

91

1



2

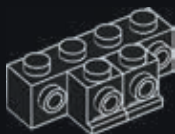

3

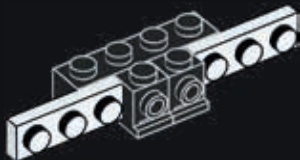

4

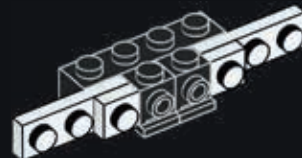

5

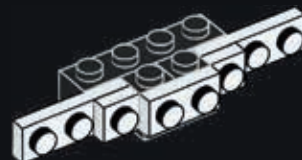

6

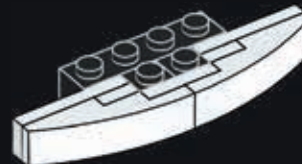

2x



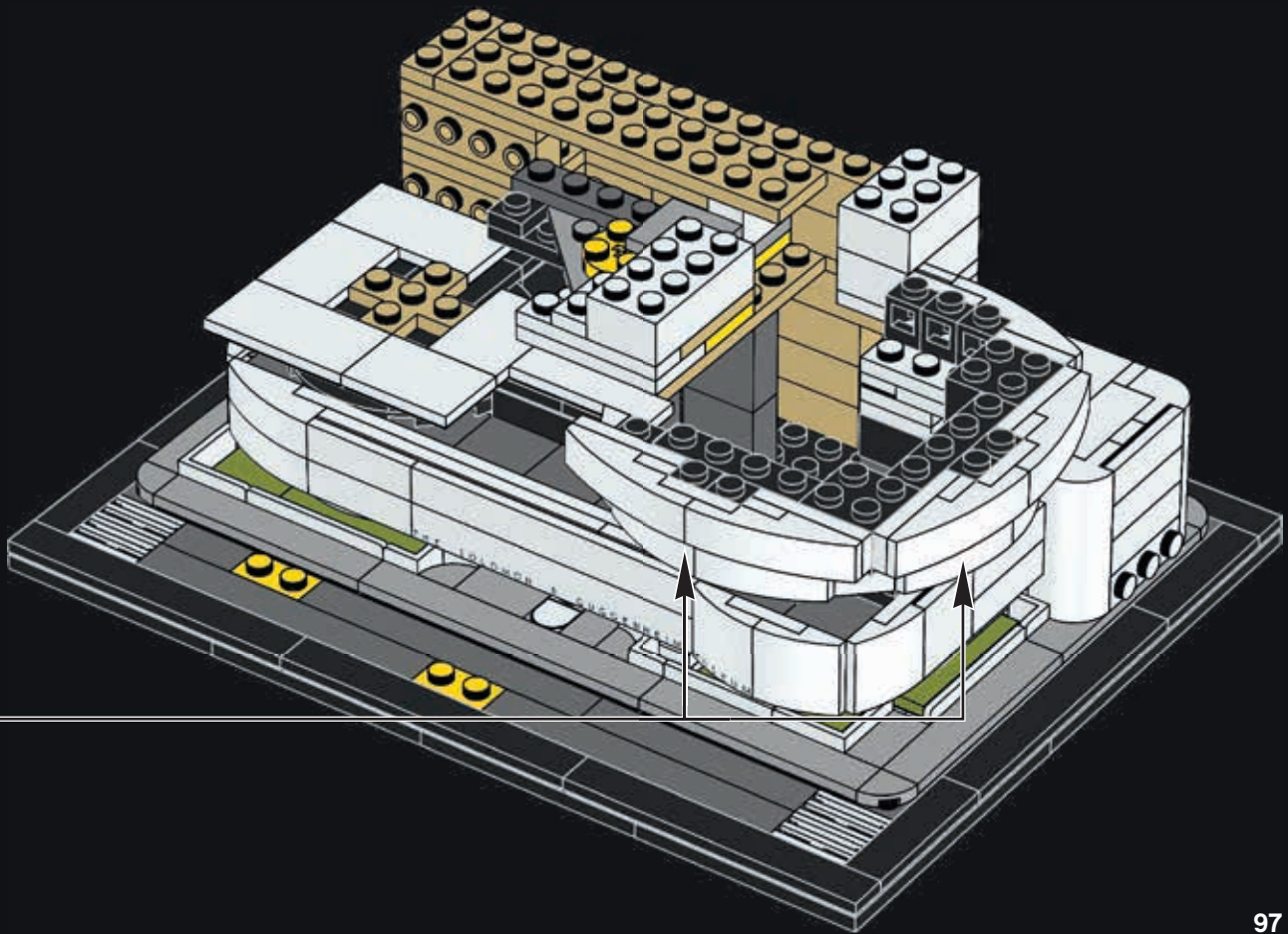



1x

92

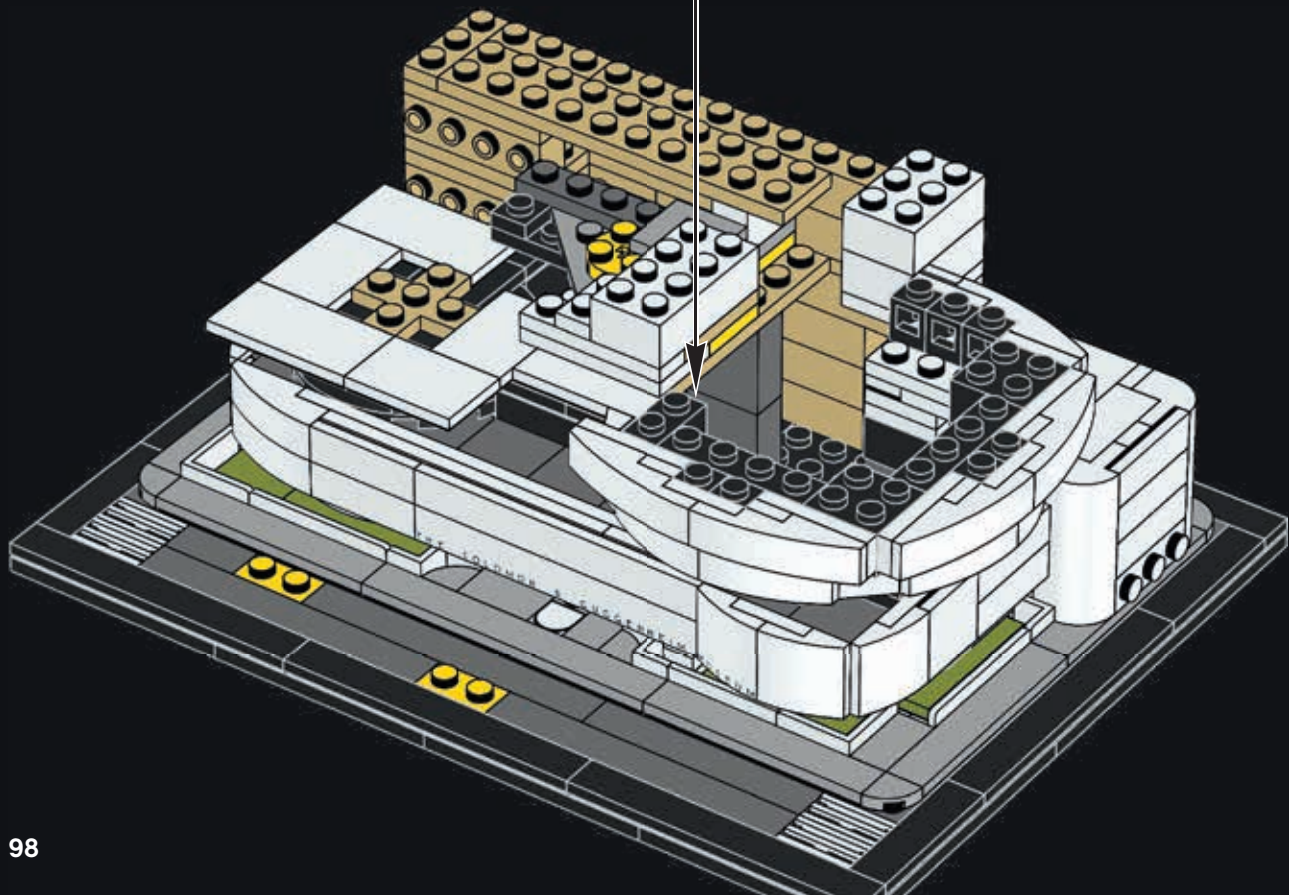

98



93

1



2



3



4

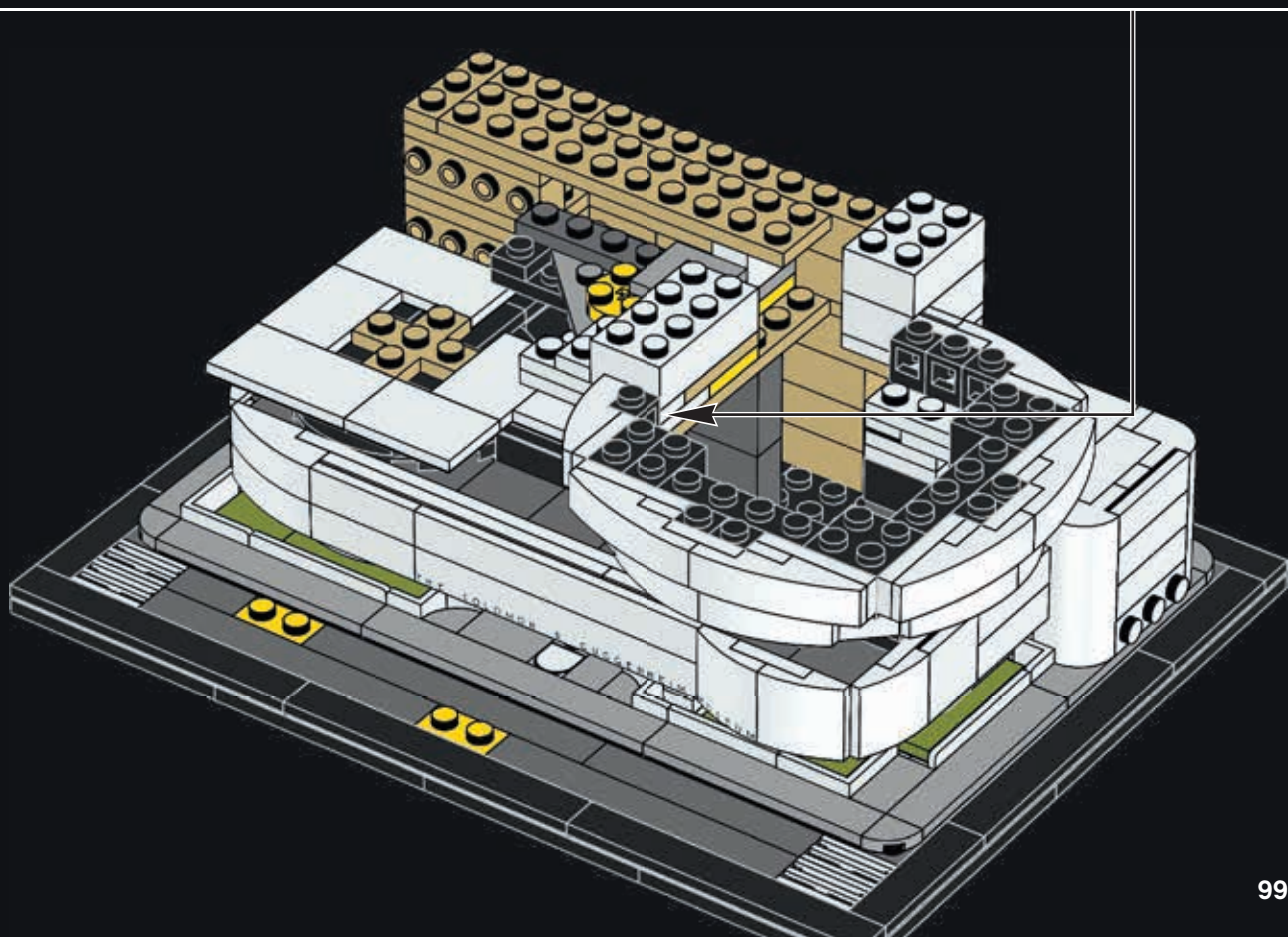
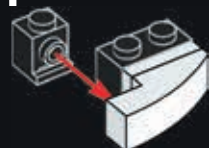



94

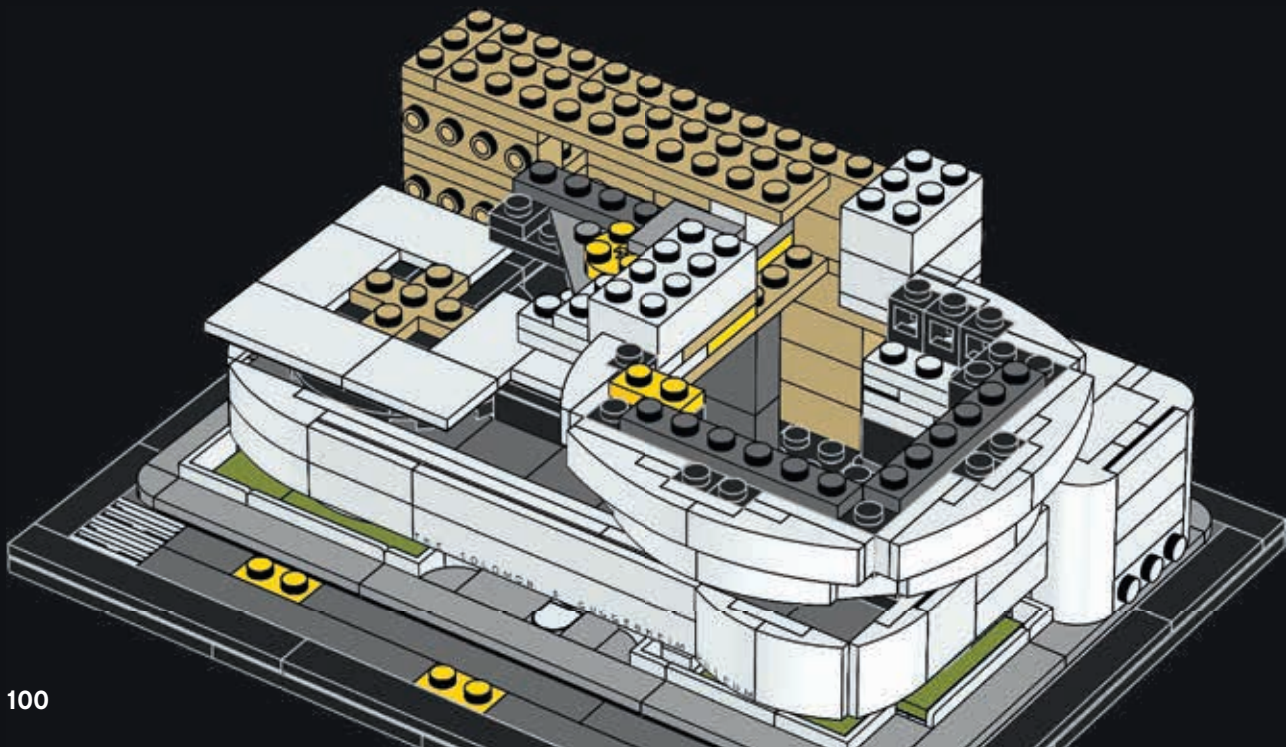

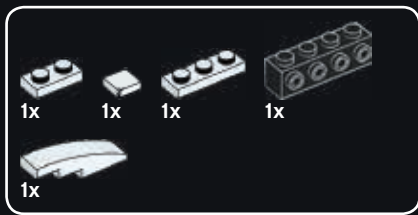

95

1

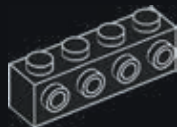

2



3



4

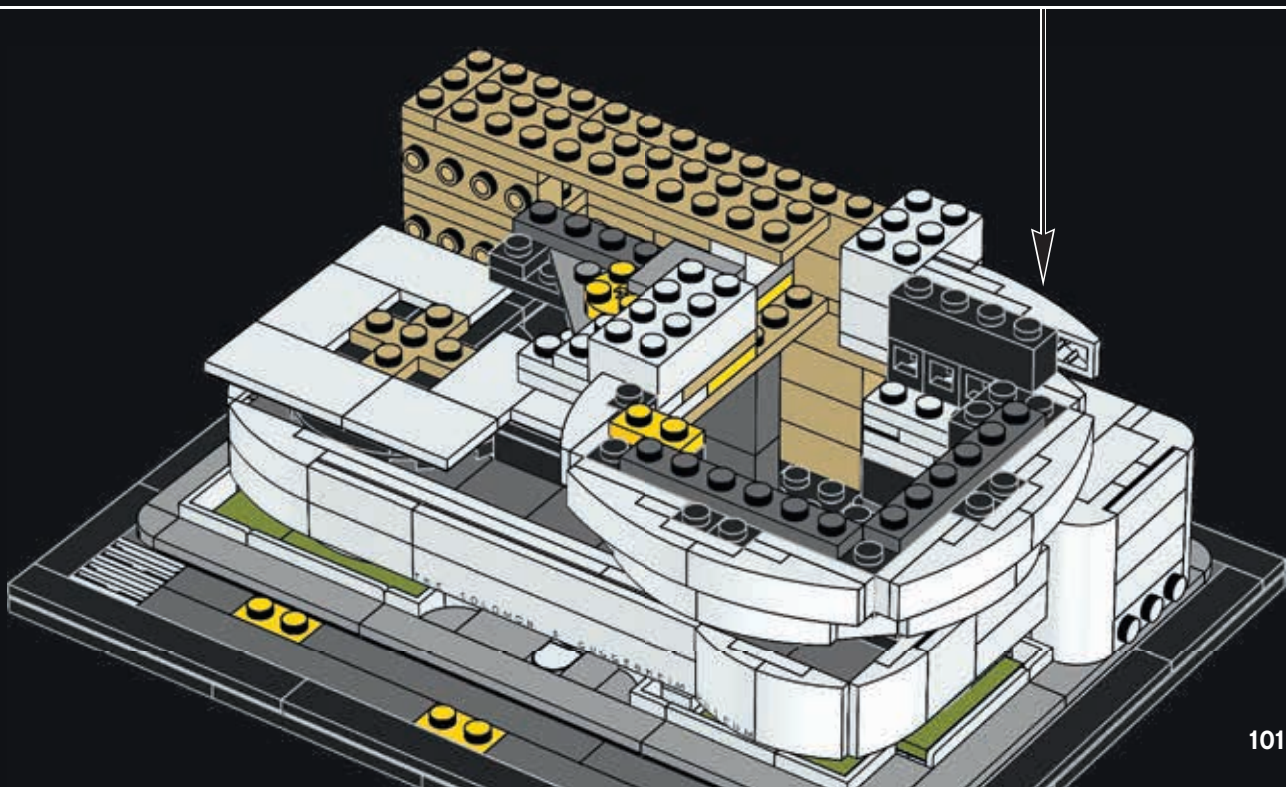



2x



1x

96

1

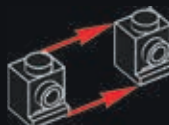

2

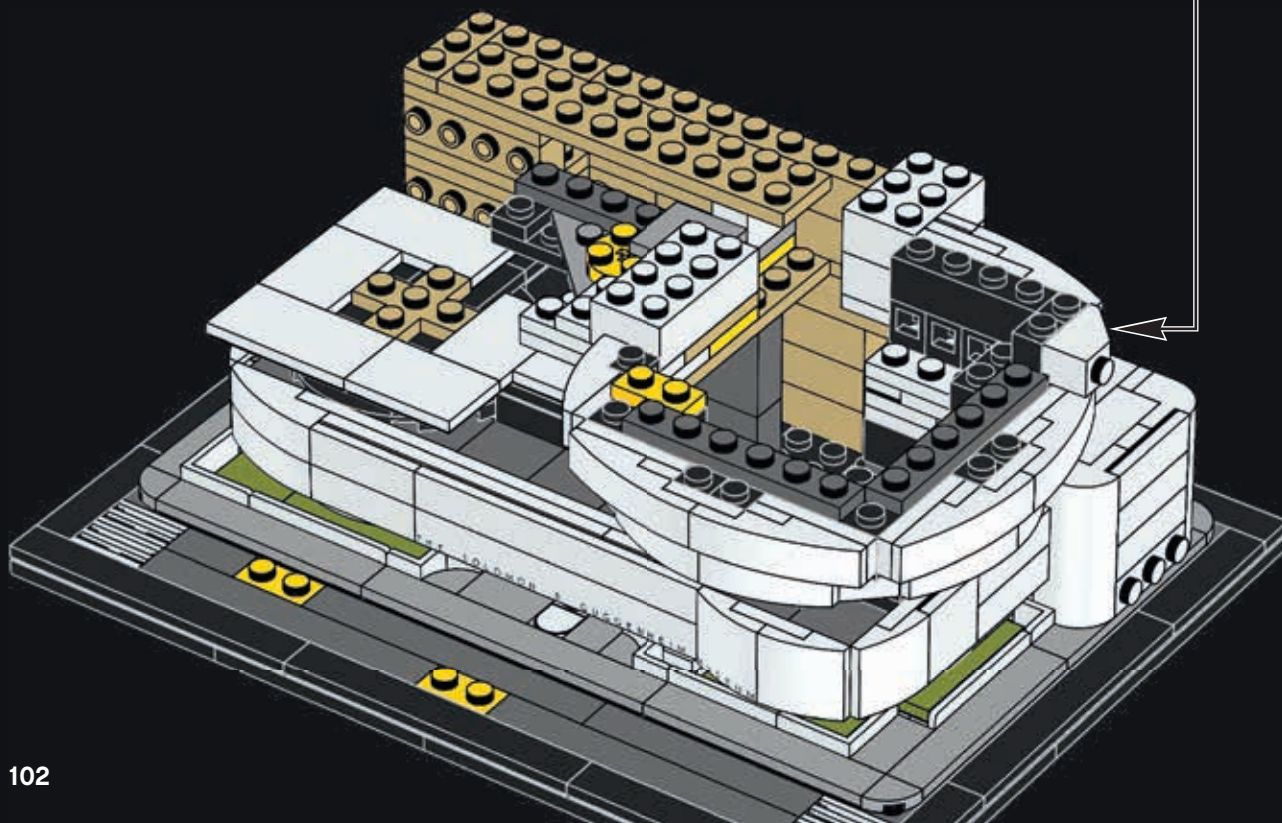

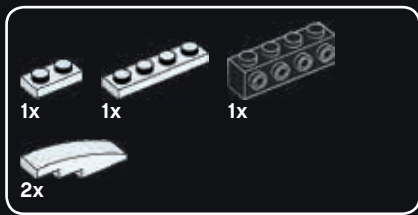

97

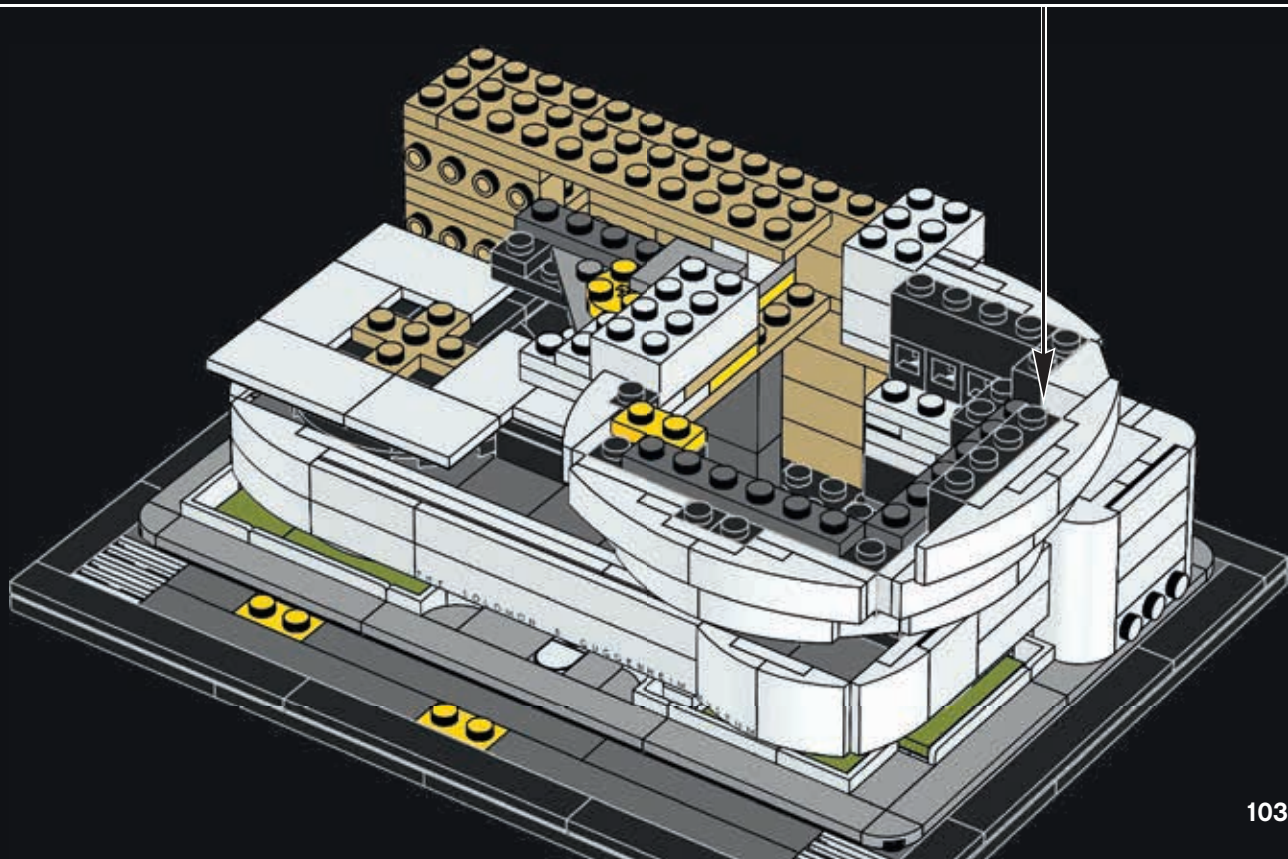



2x



1x

98

1

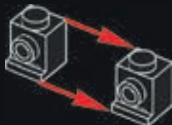

2

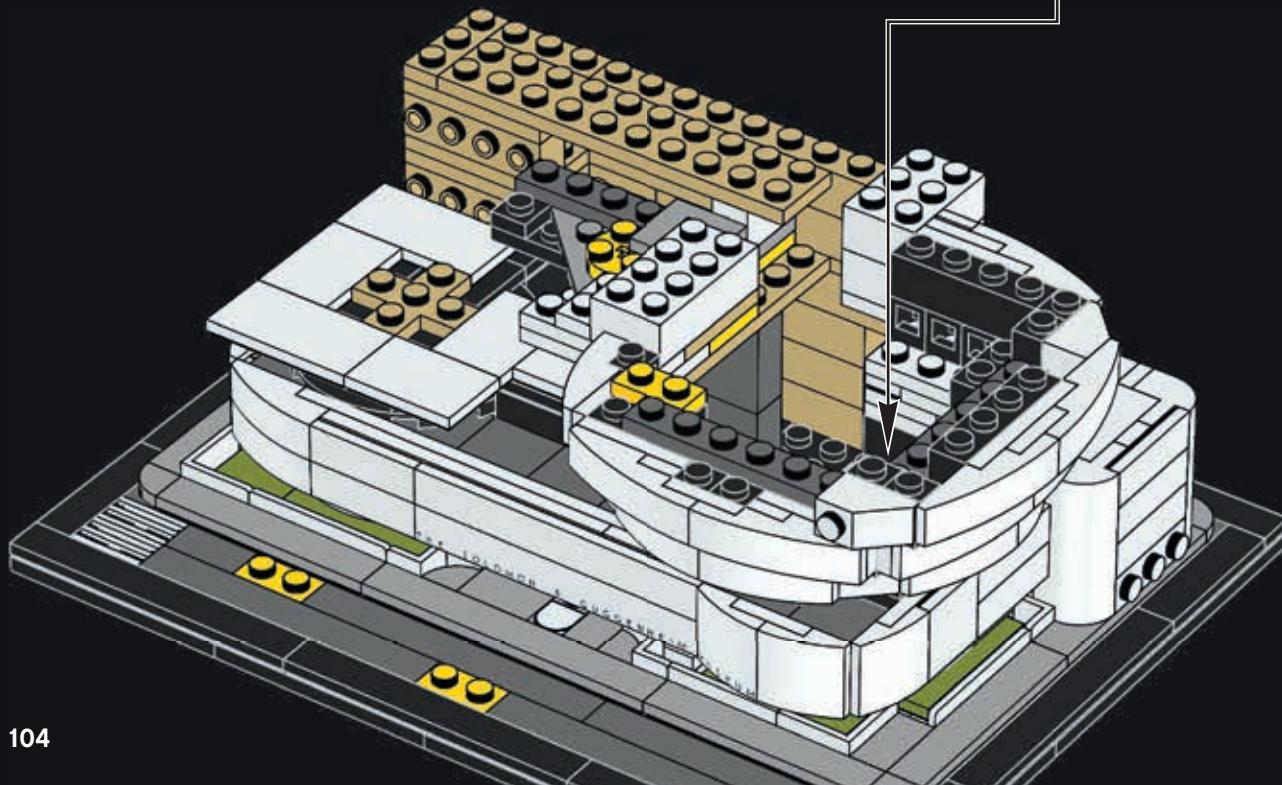



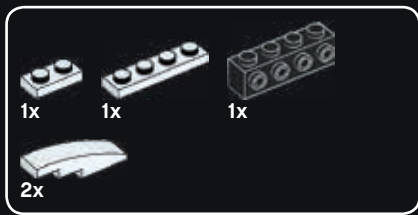

99

1

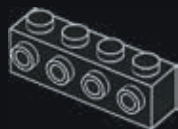

2

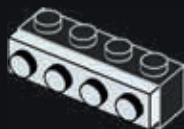

3



4

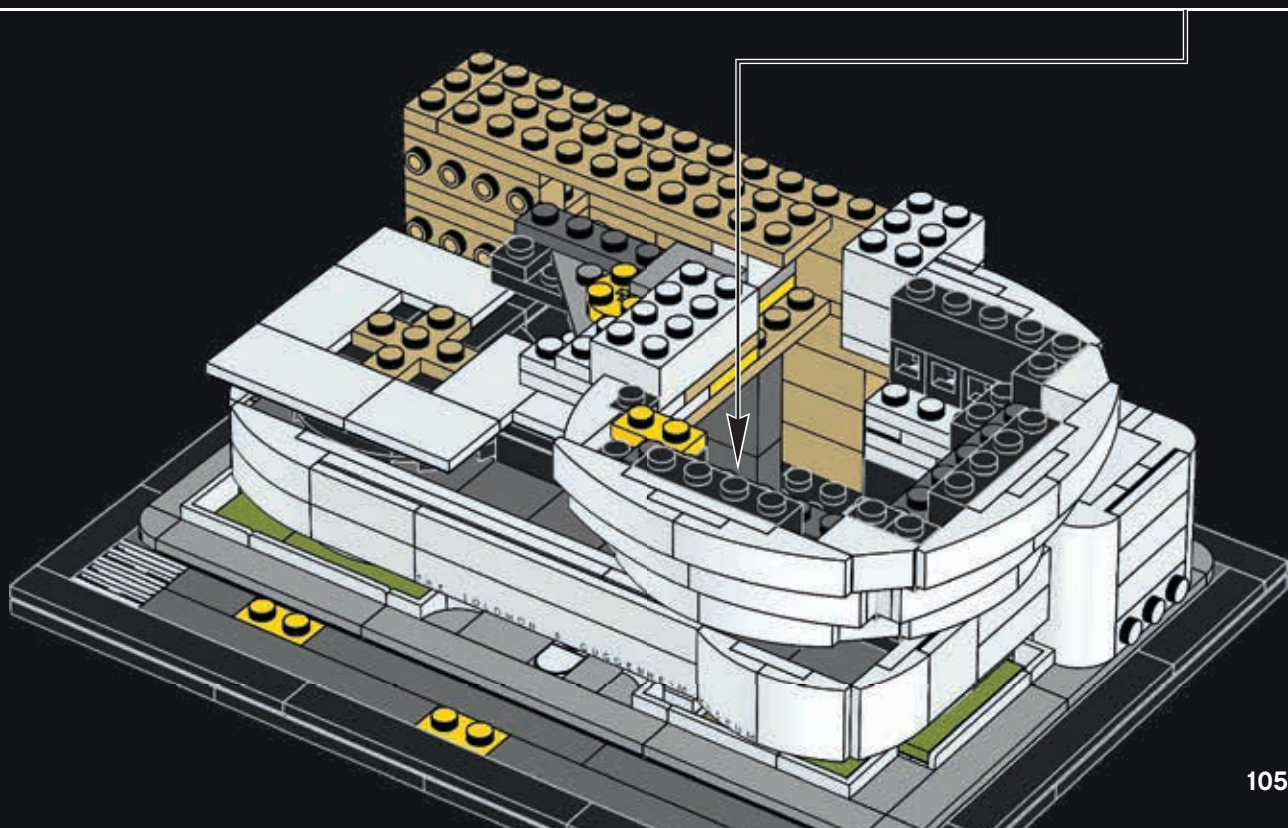

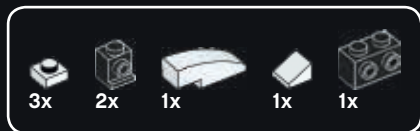

100

1



2



3



4



5

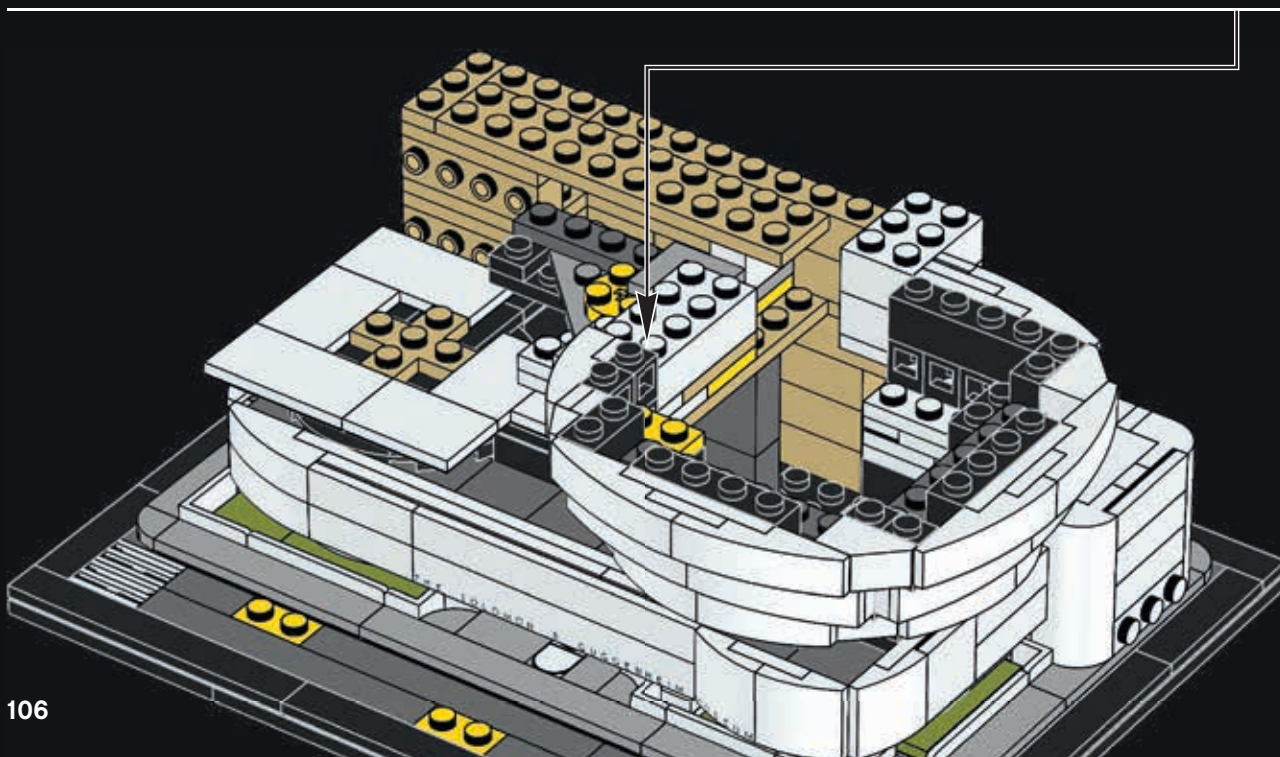
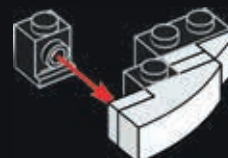

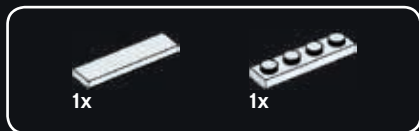

101

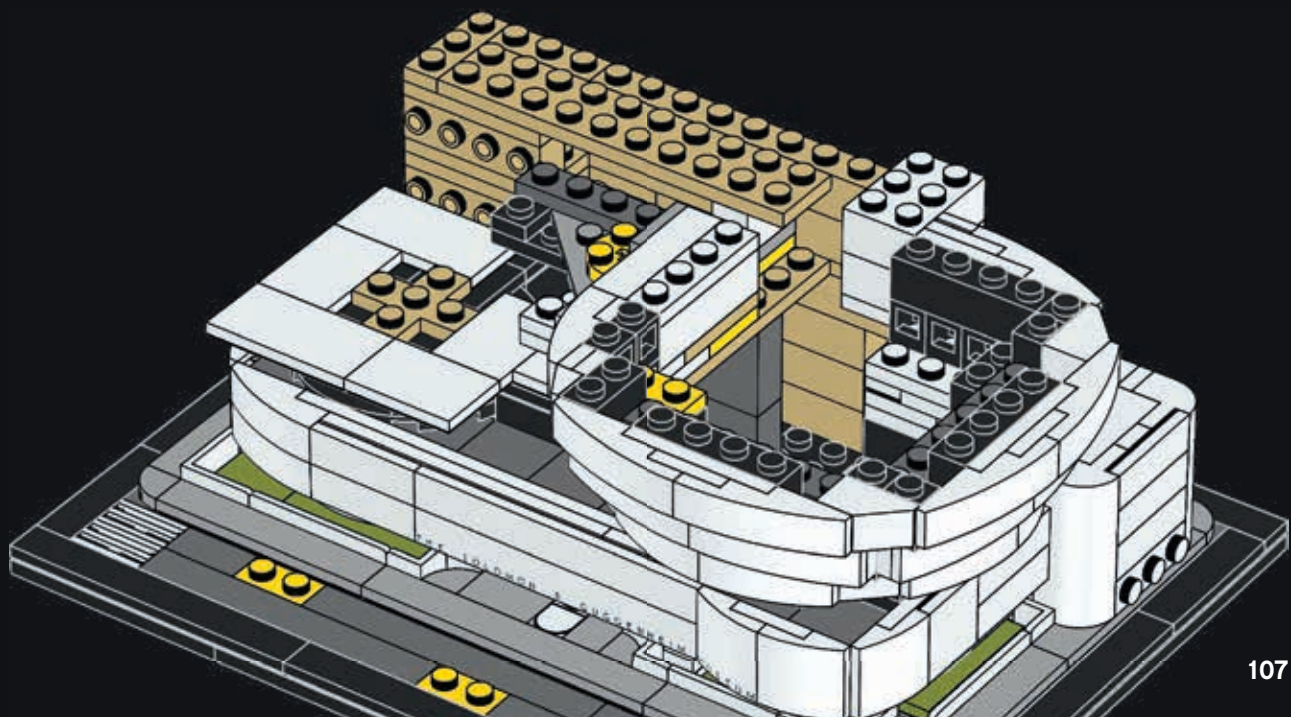



102

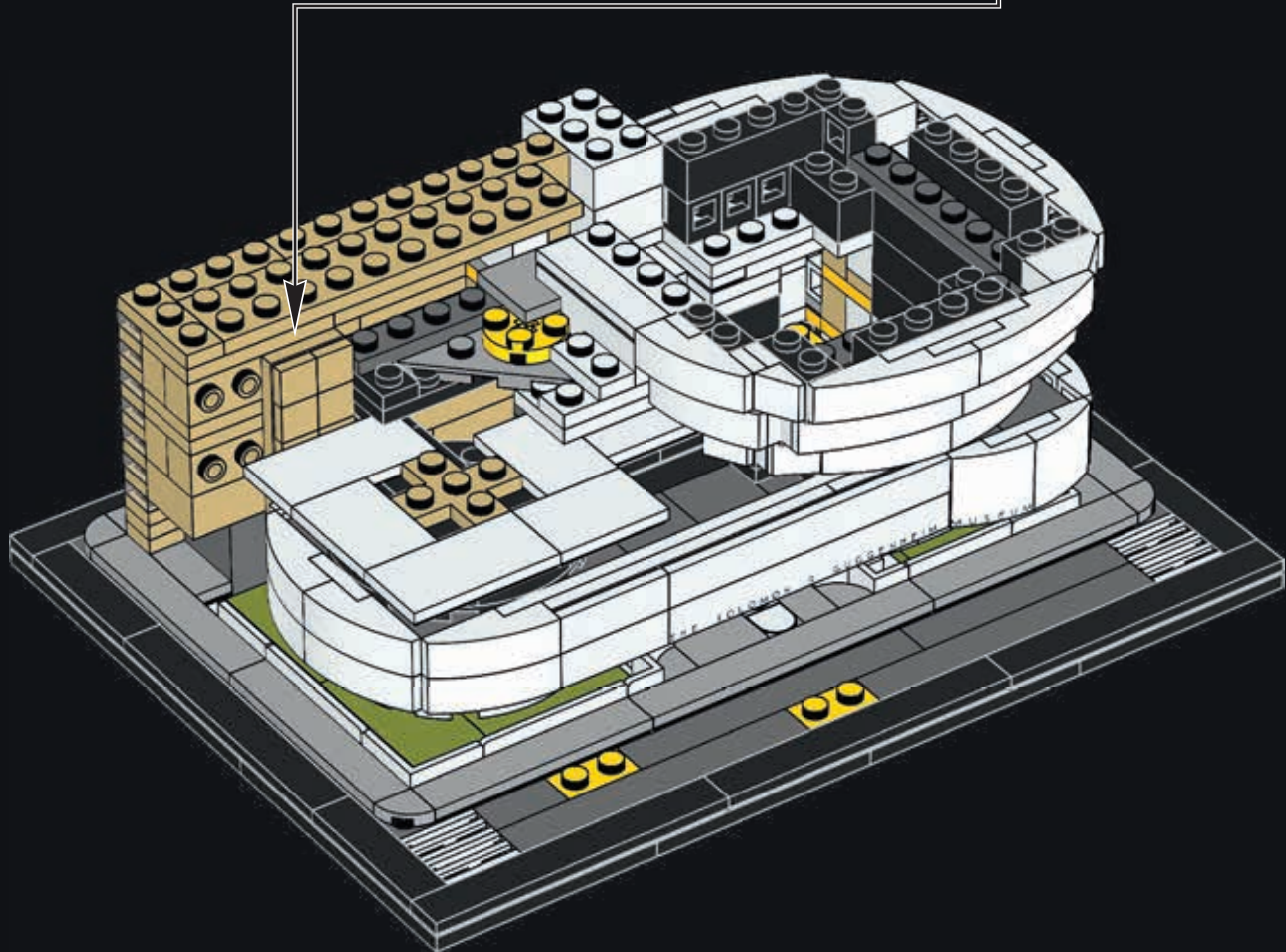
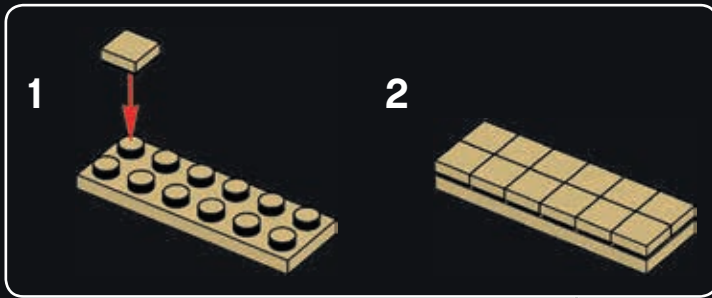

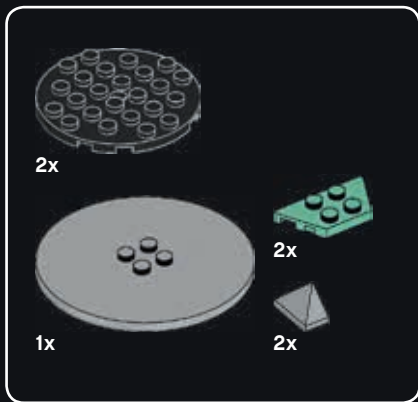

103

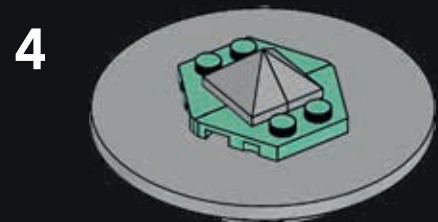
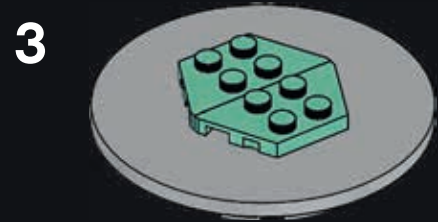
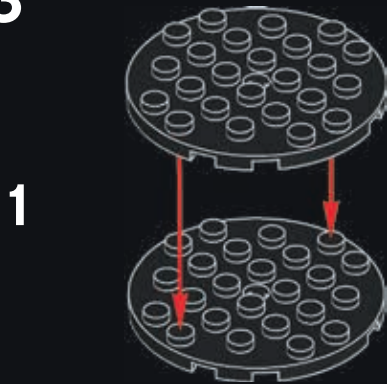

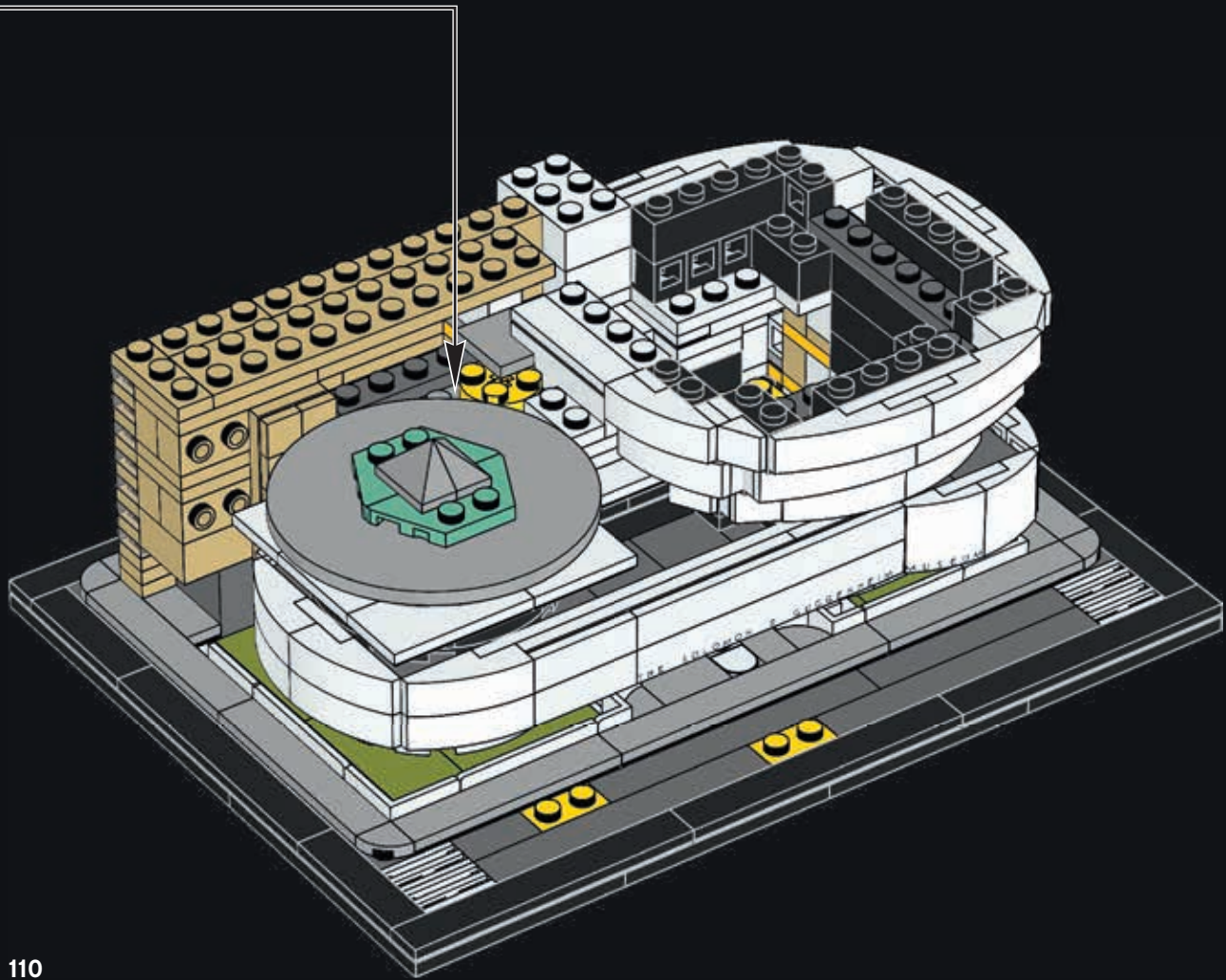



104

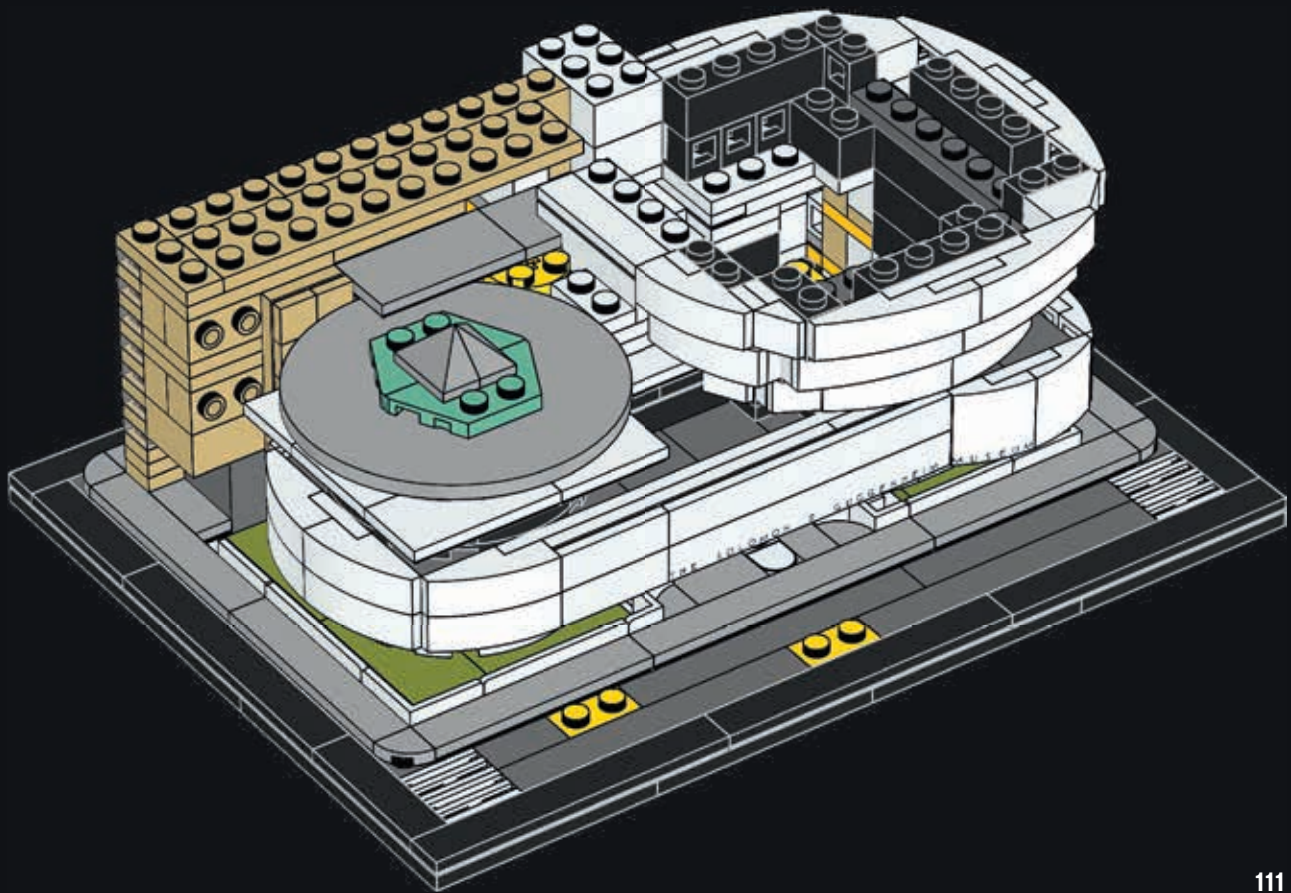



1x

105

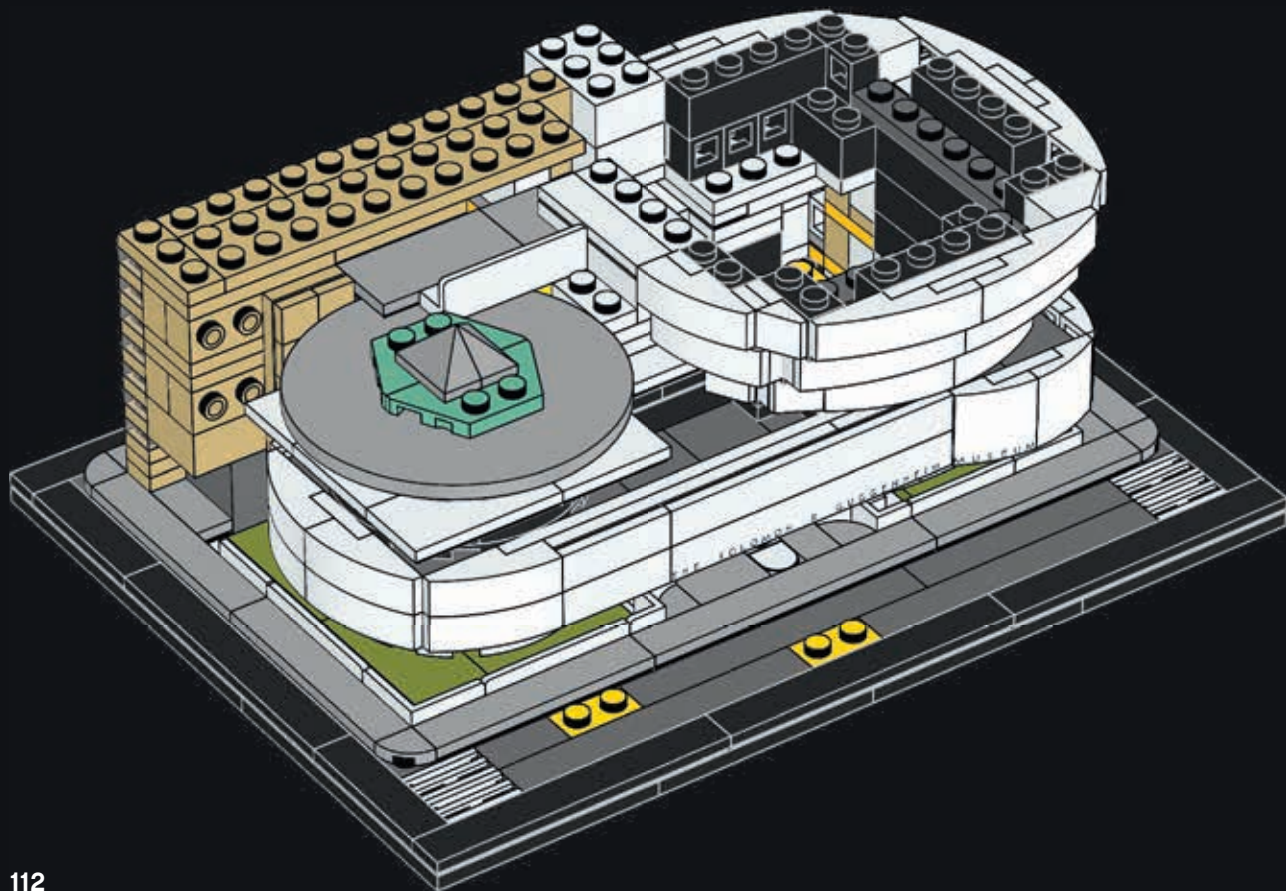





106

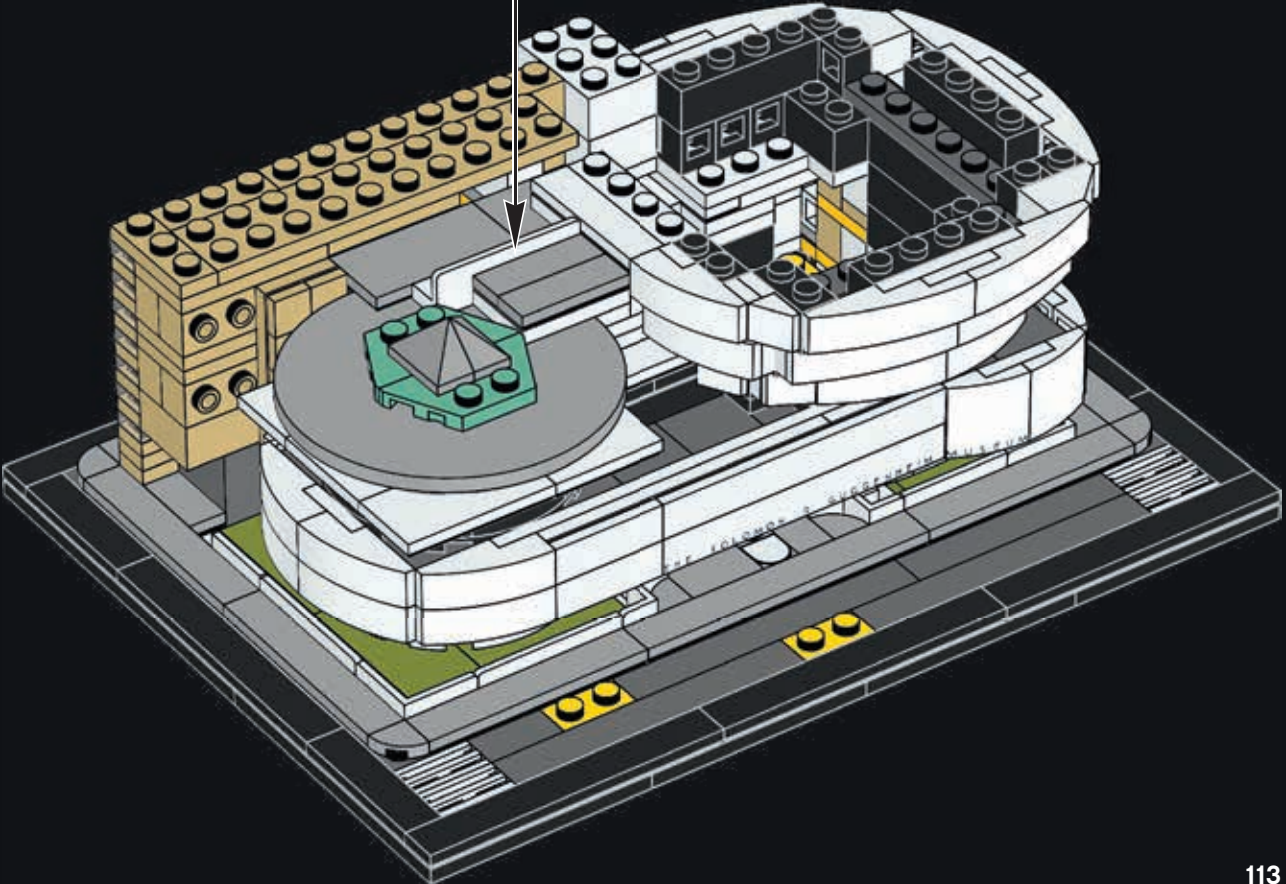
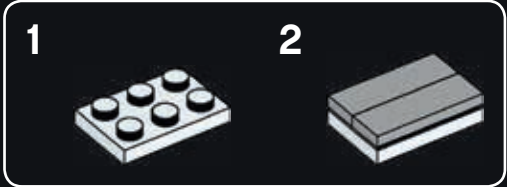



107

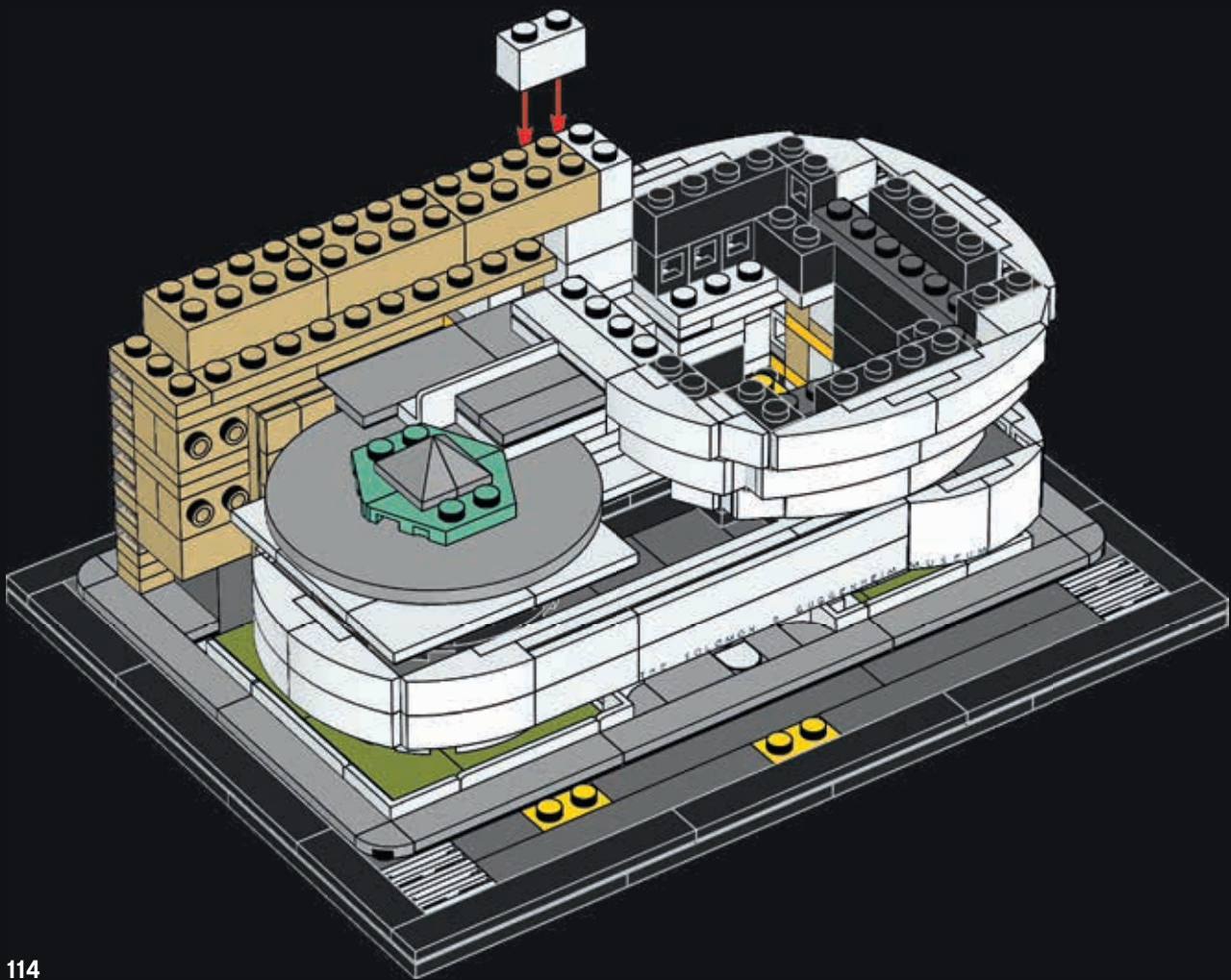



1x



1x



2x

# 108

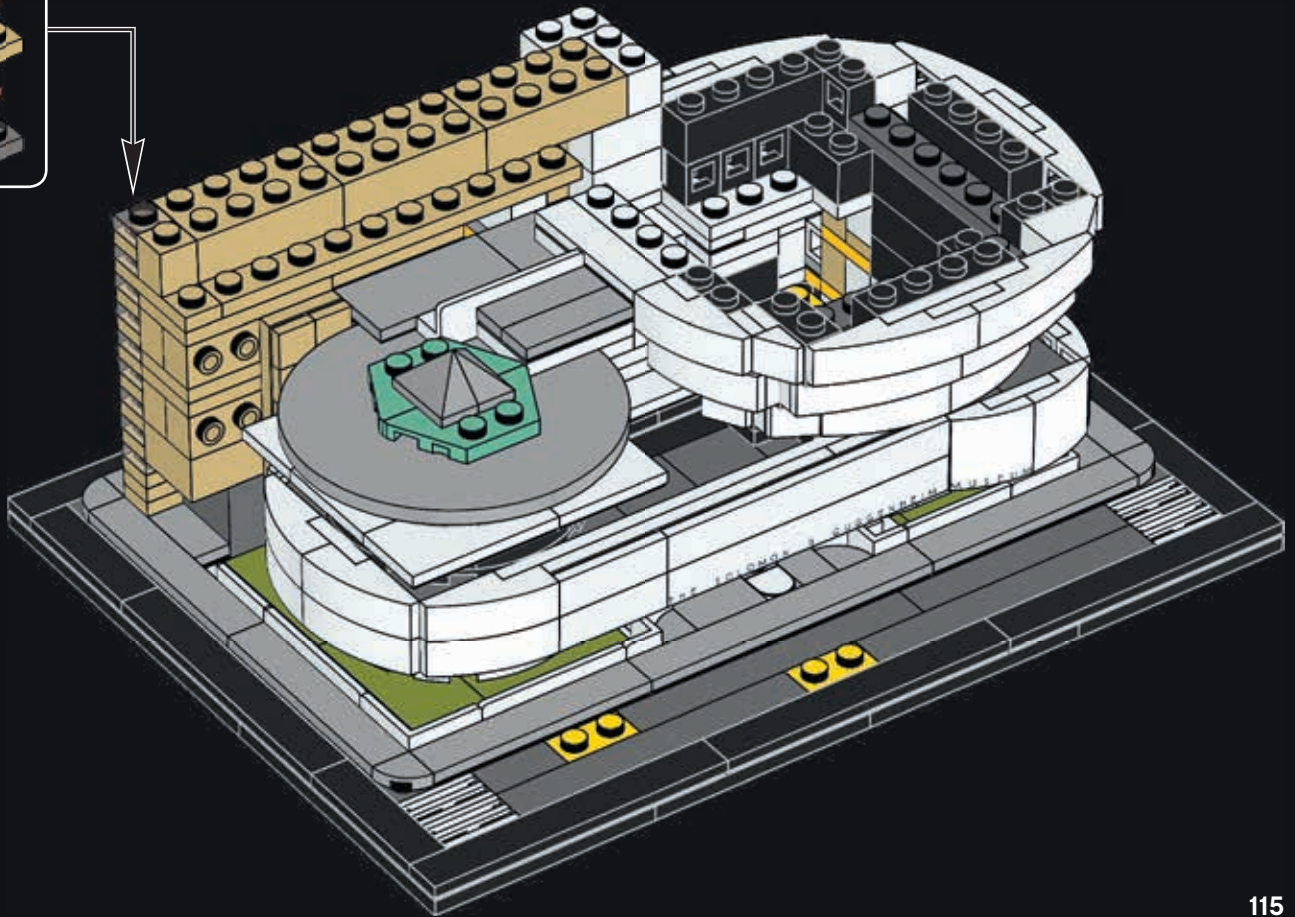
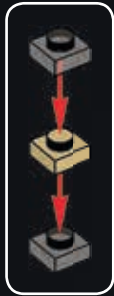



109

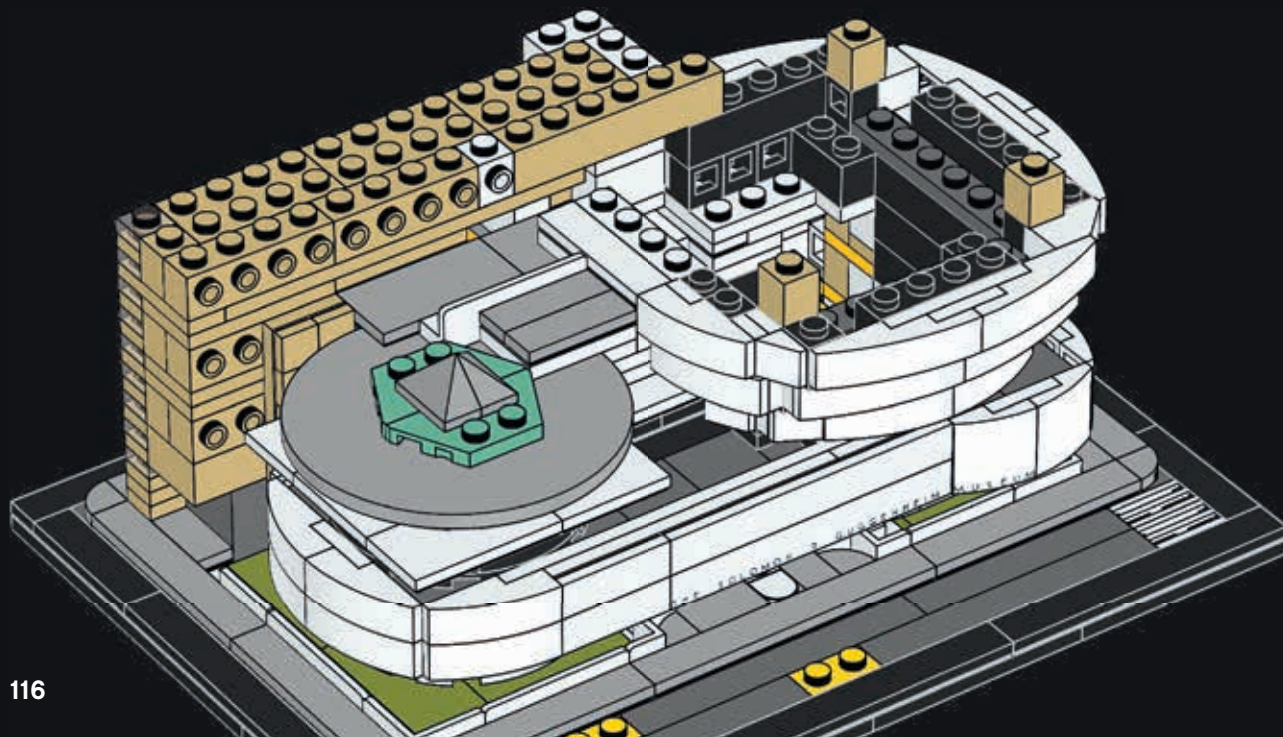

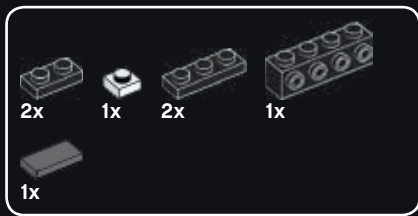

110

1



2

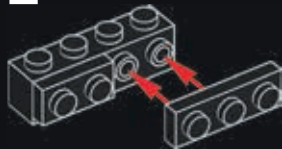

3

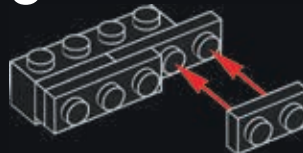

4

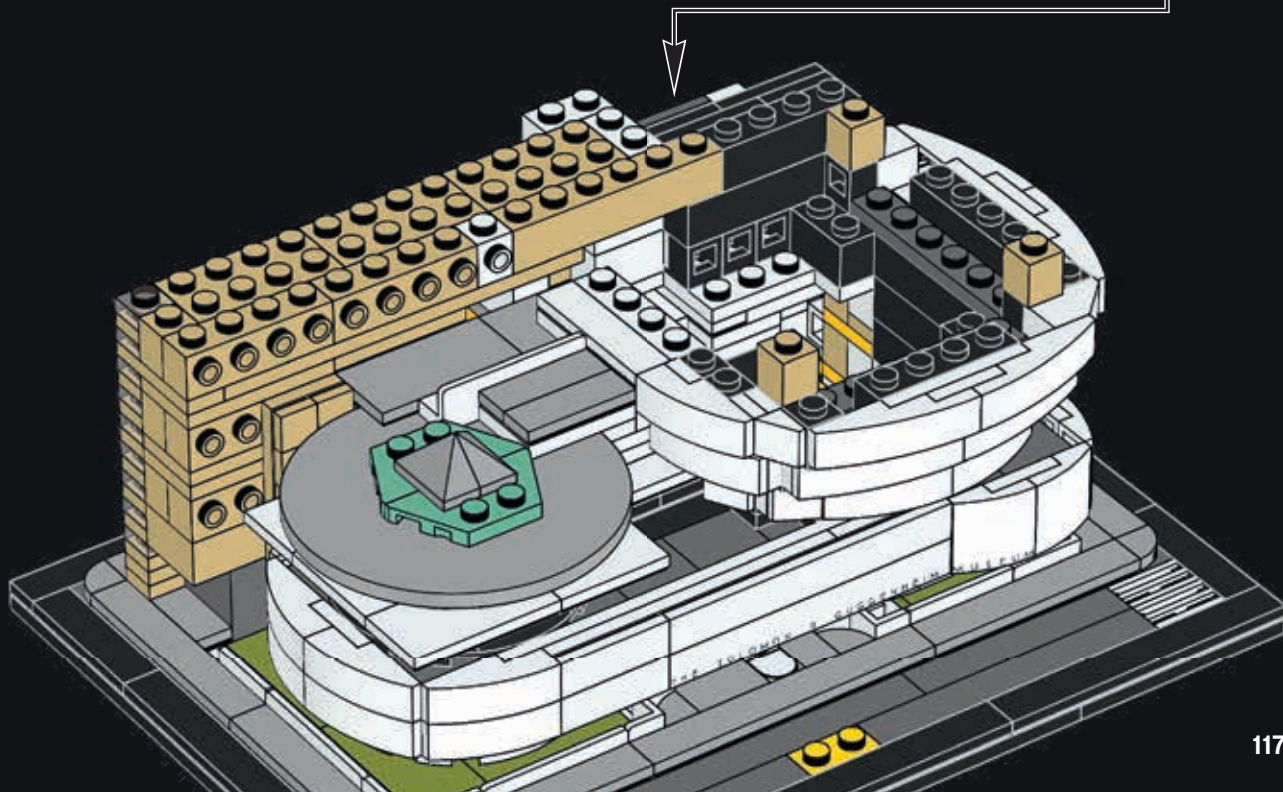
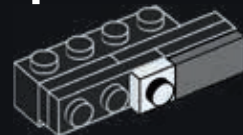

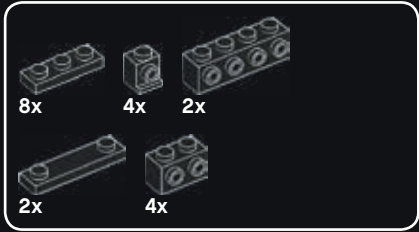

# 111

1



2

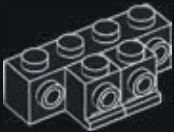

3

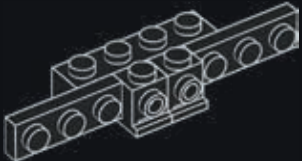

4

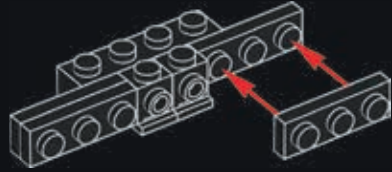

5

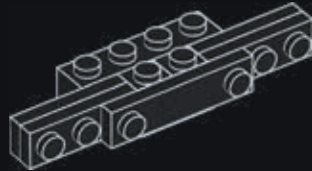

6

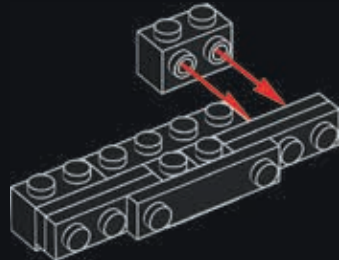

2x

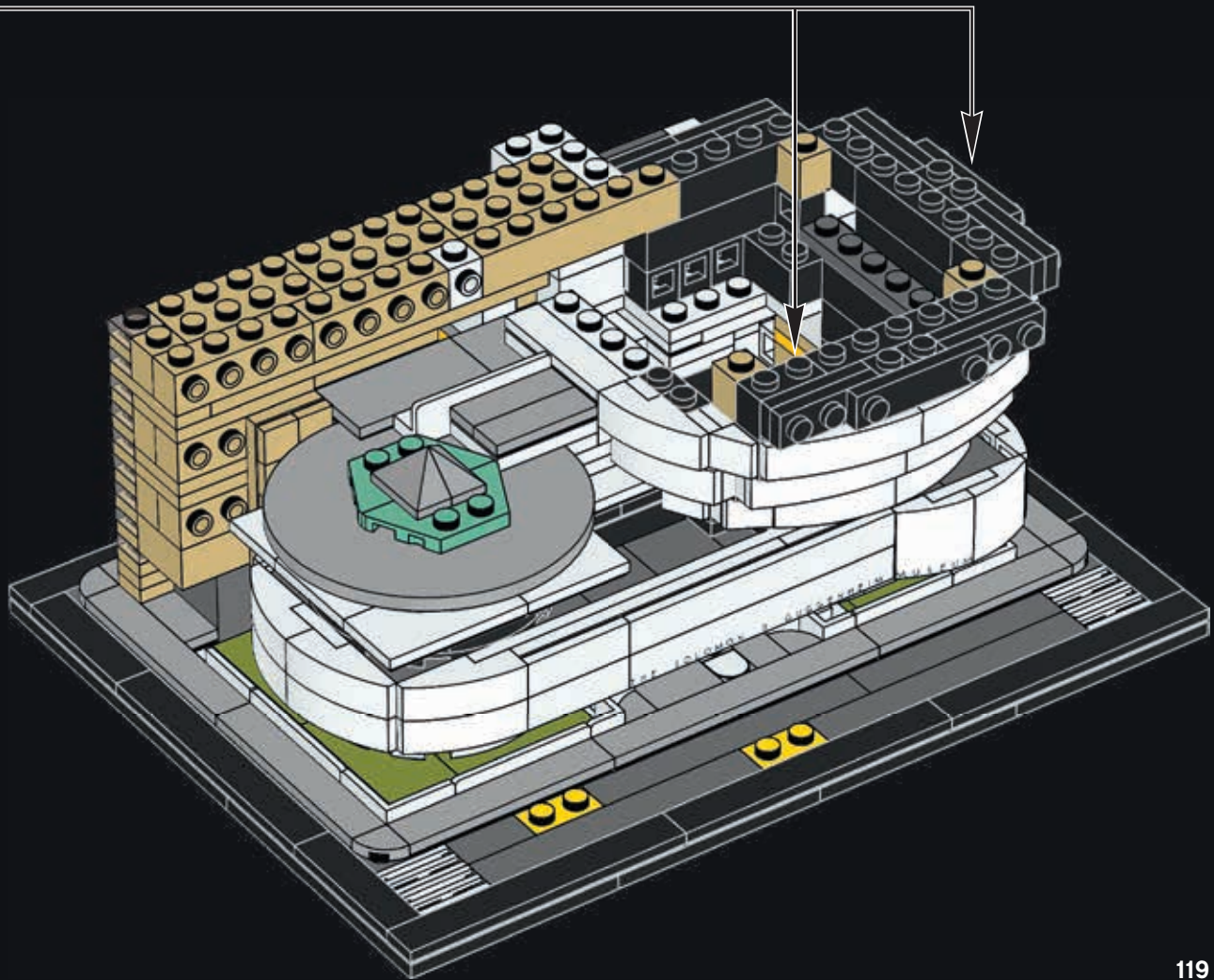



# 112

1

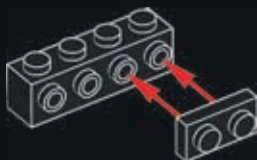

2

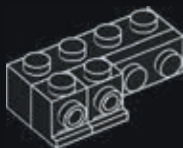

3

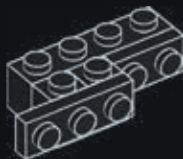

4

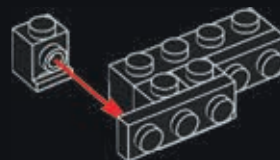

5

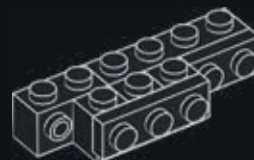

6

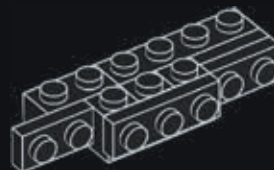

7

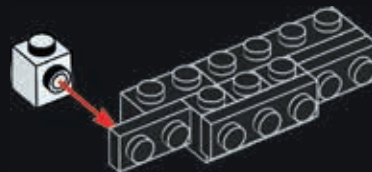



It took \$3 million to build the Guggenheim Museum between 1943-1959. The restoration of the exterior from 2005 to 2008 cost \$2 million.



@The Solomon R. Guggenheim Foundation, New York

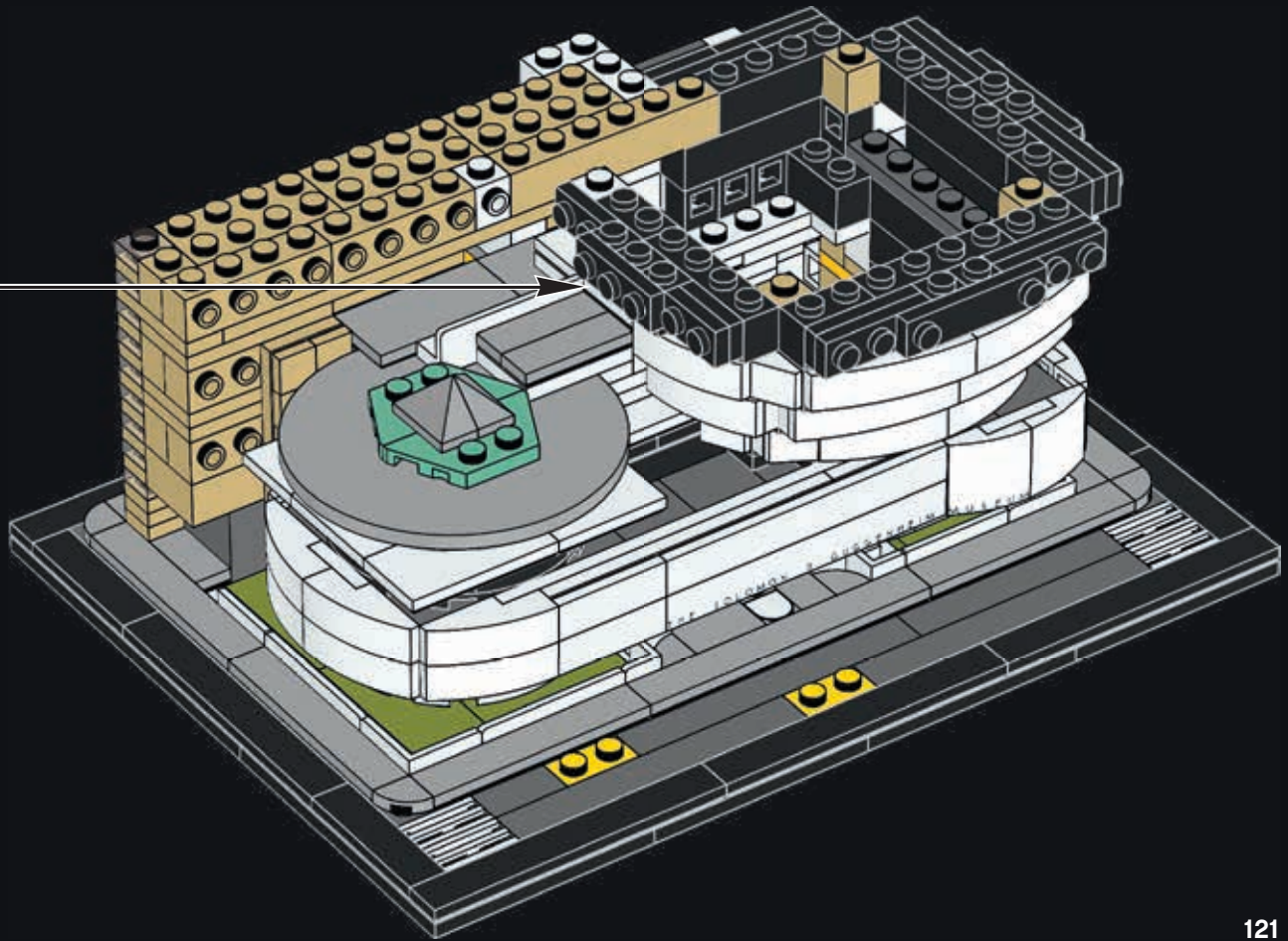



113

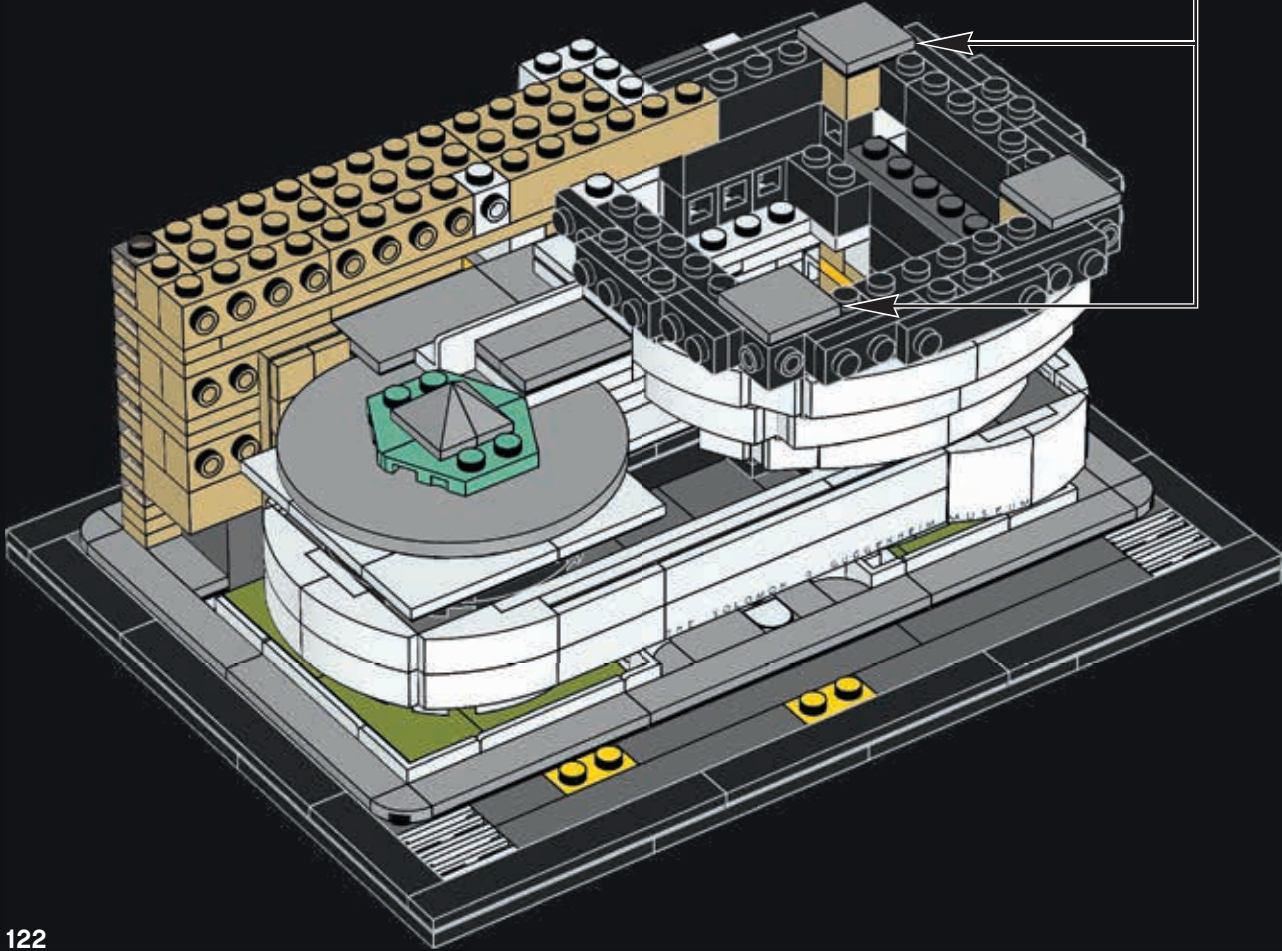



114

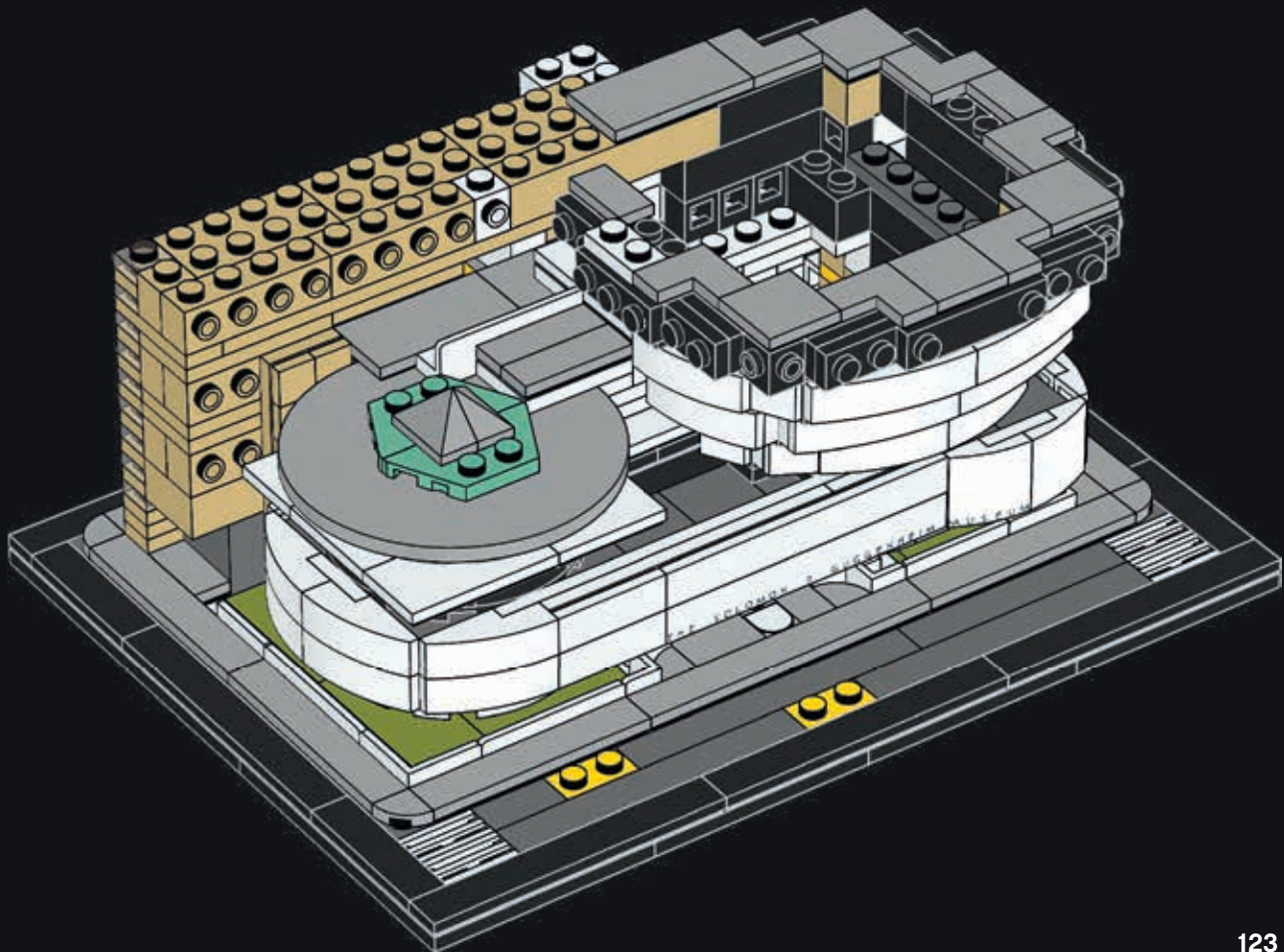



115

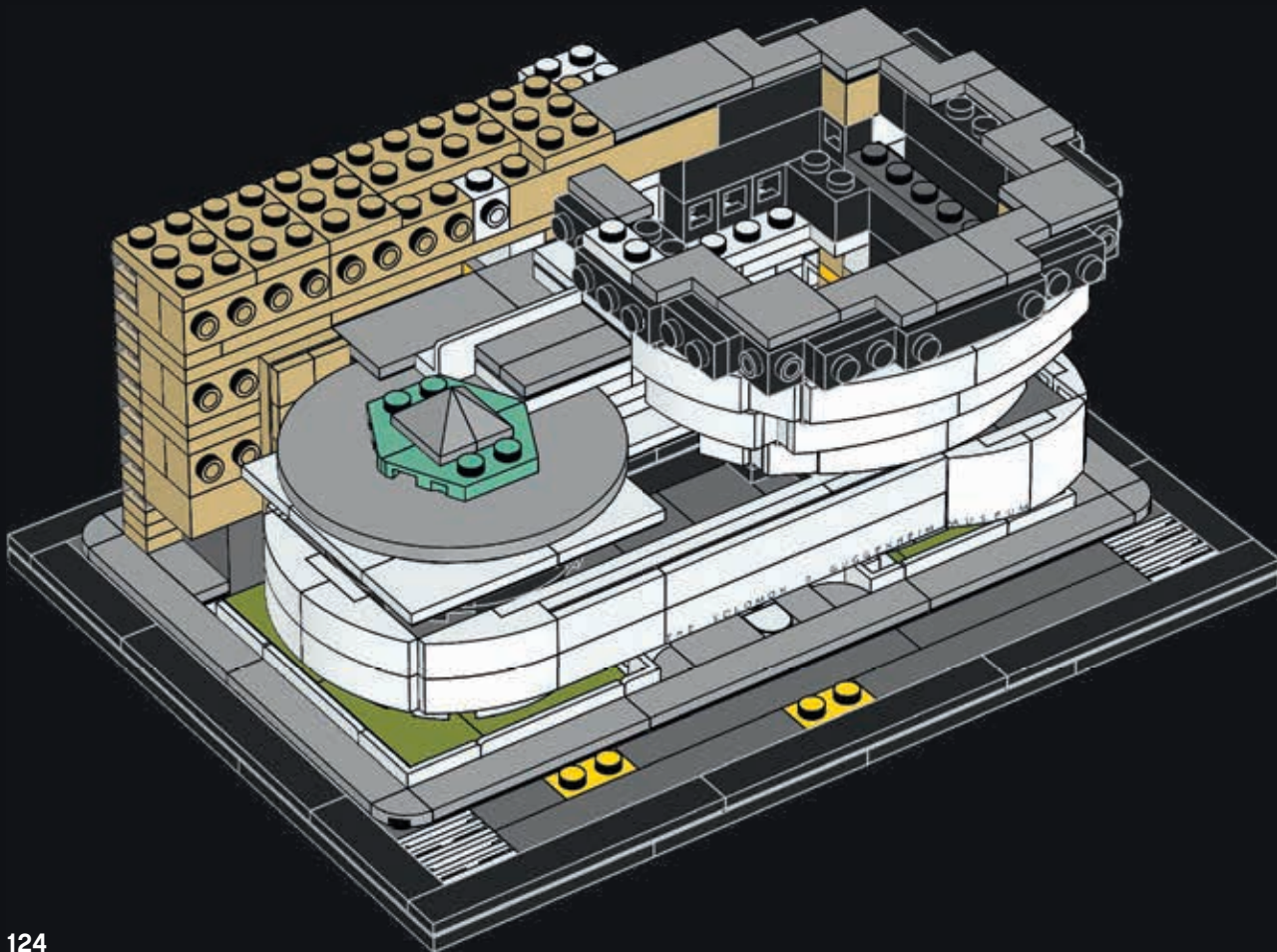



116

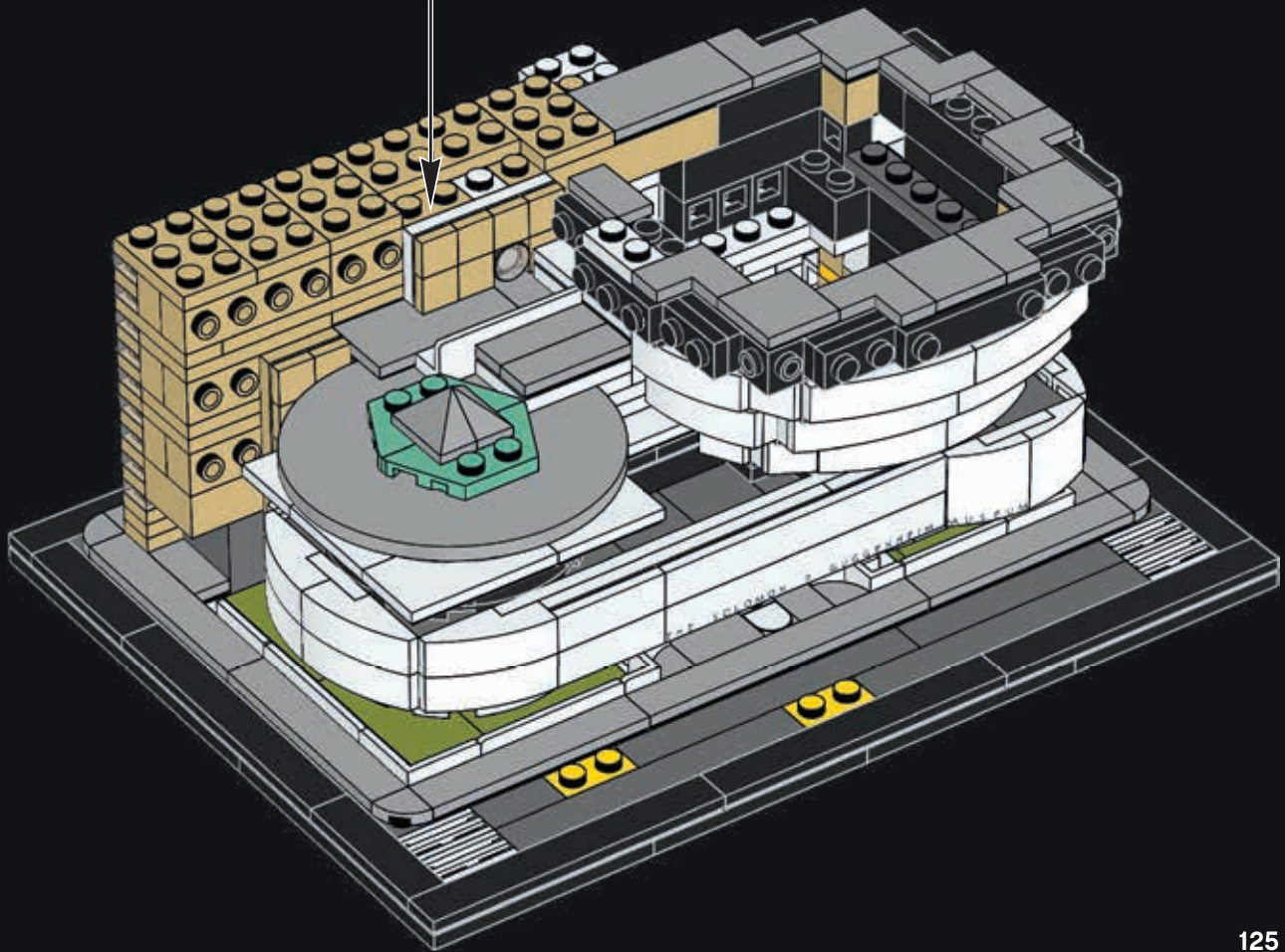
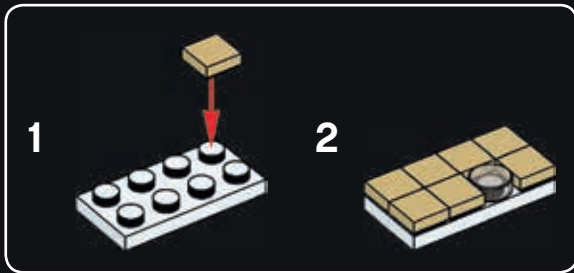



4x

117

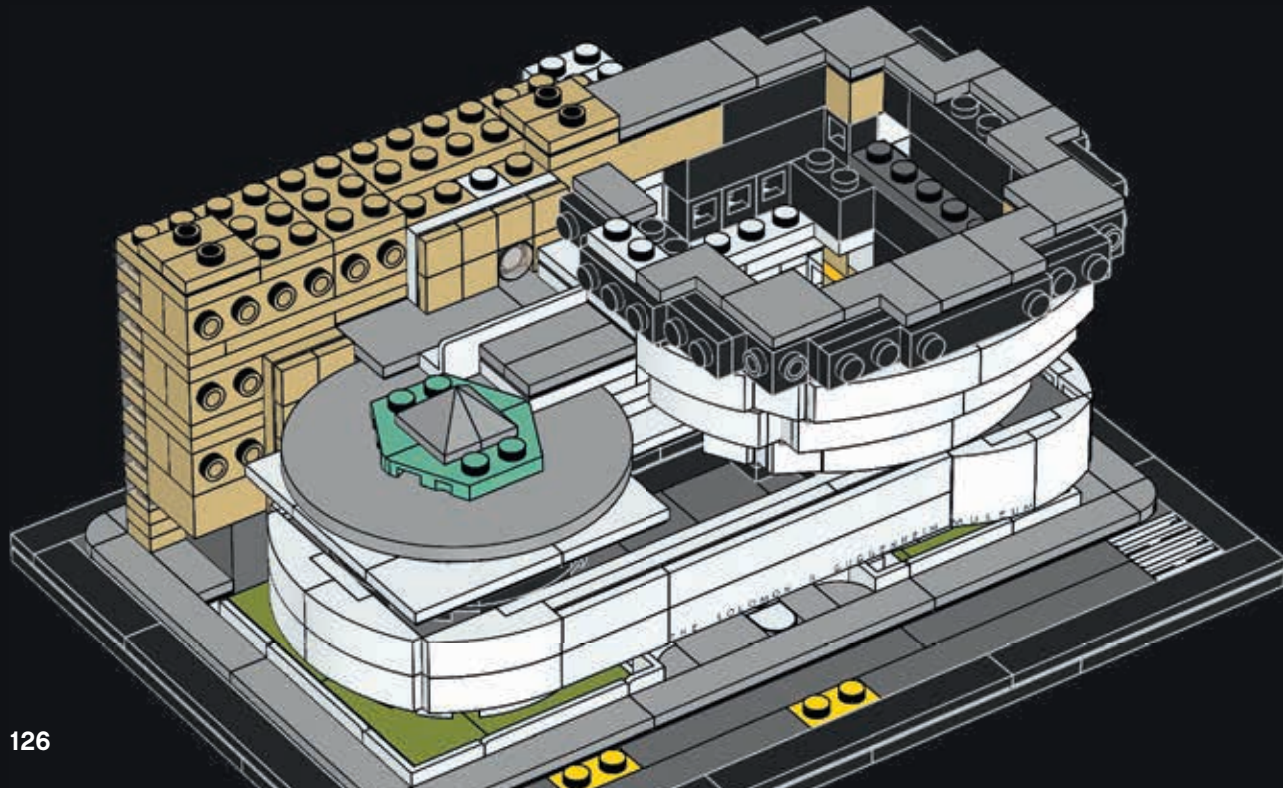

126



# 118

1



2



3



4

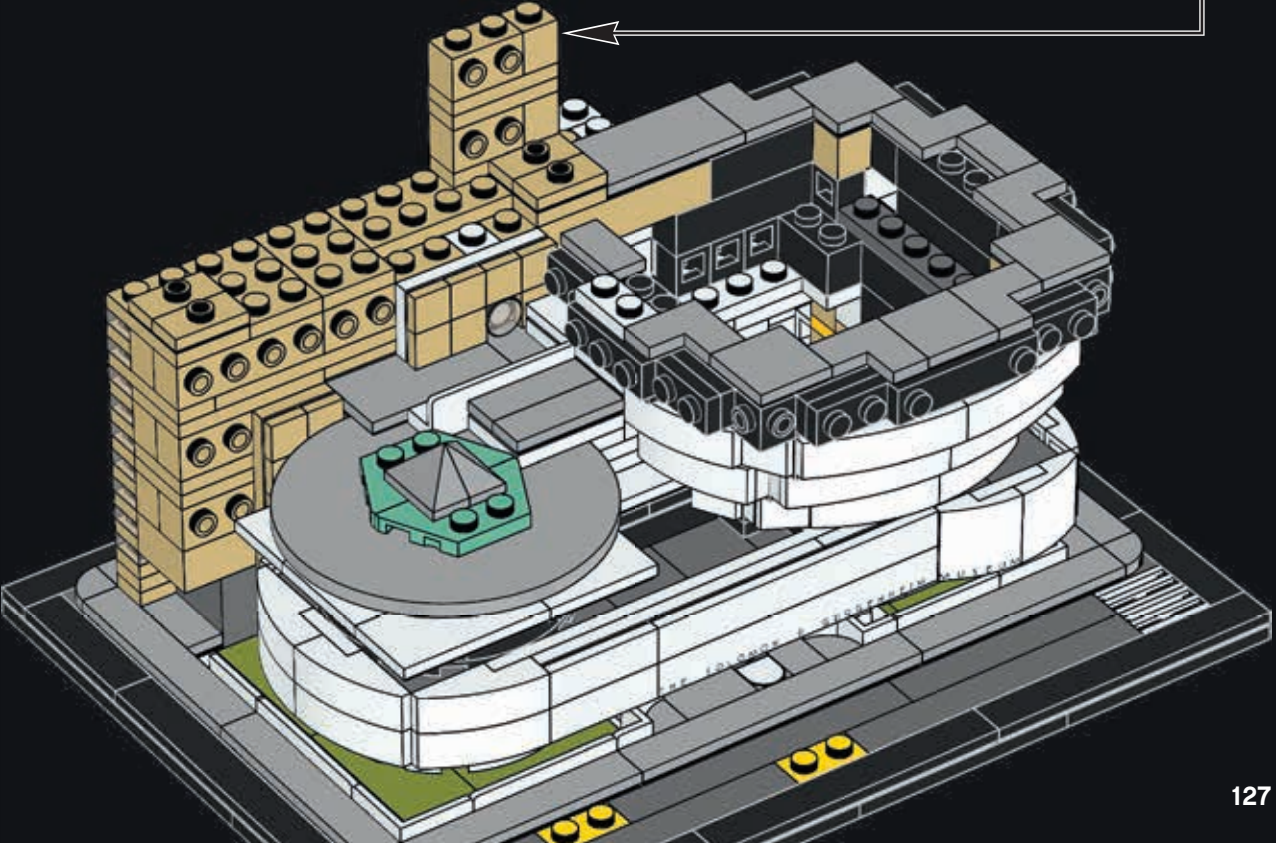



3x

119

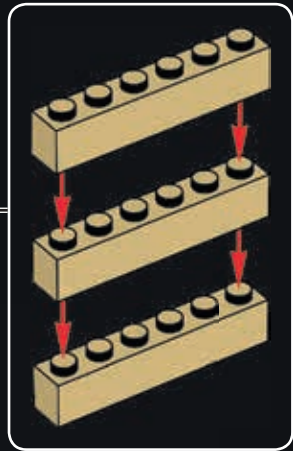
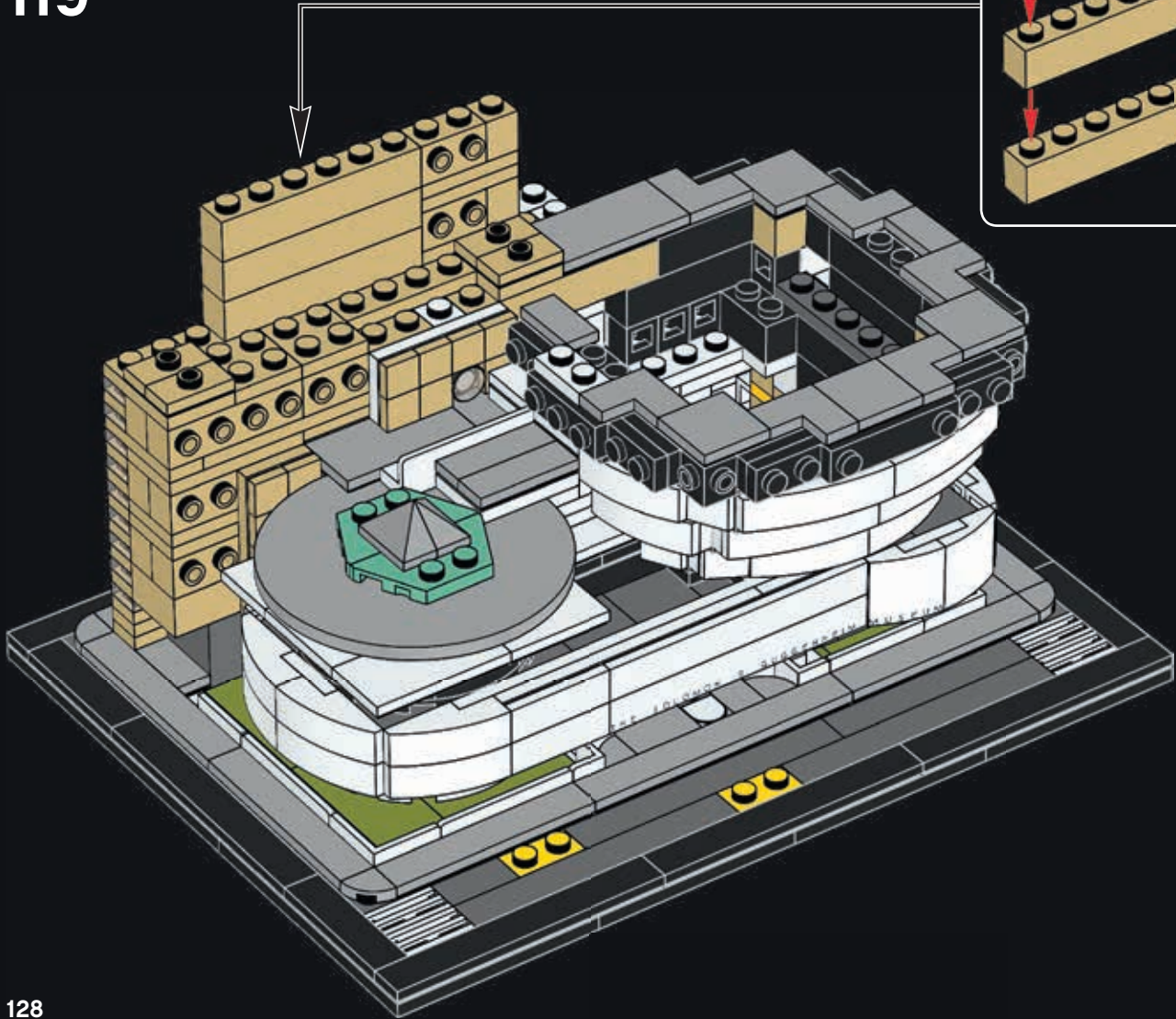



2x

1x

120

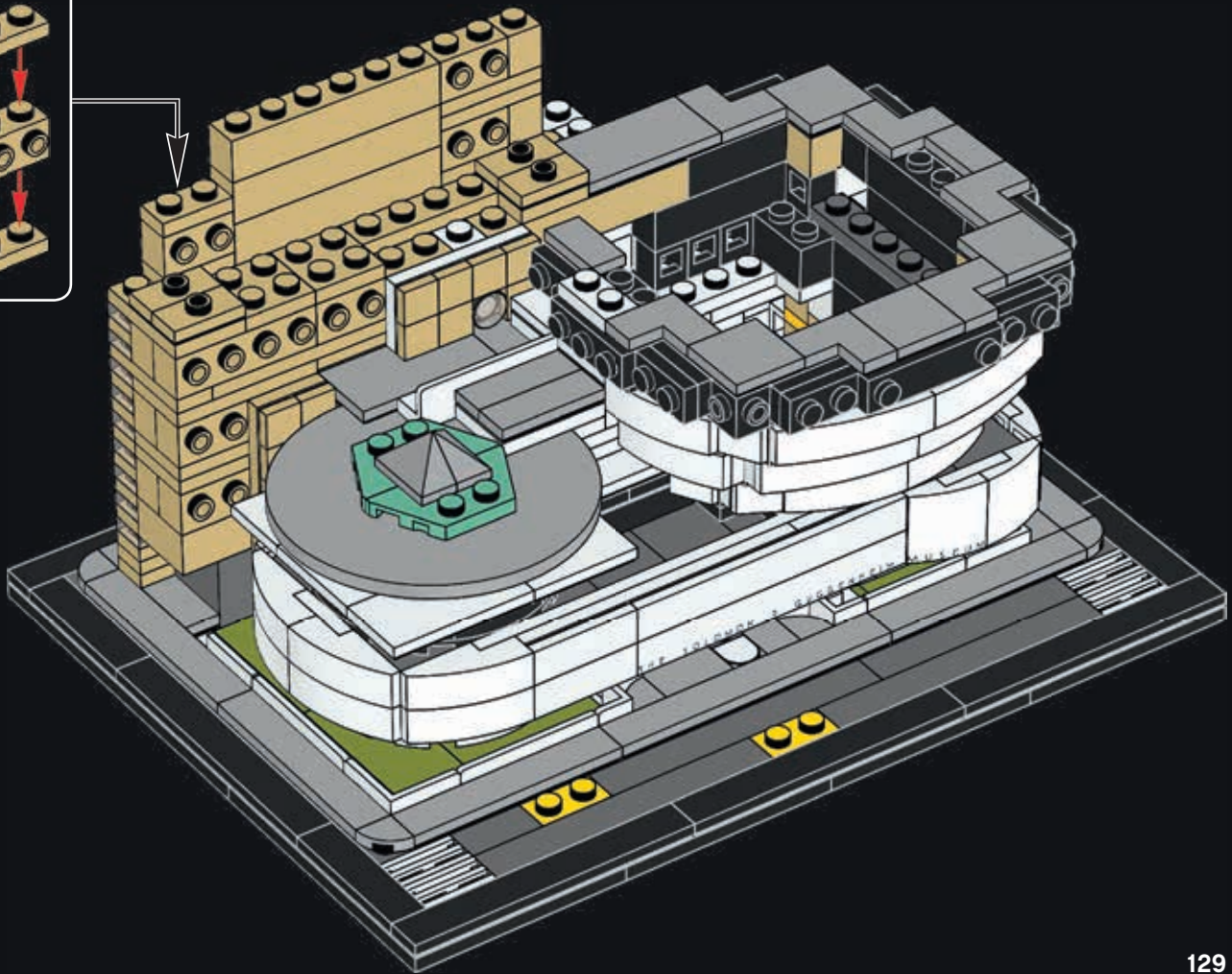
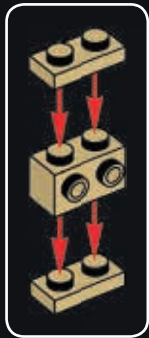



2x



3x

121

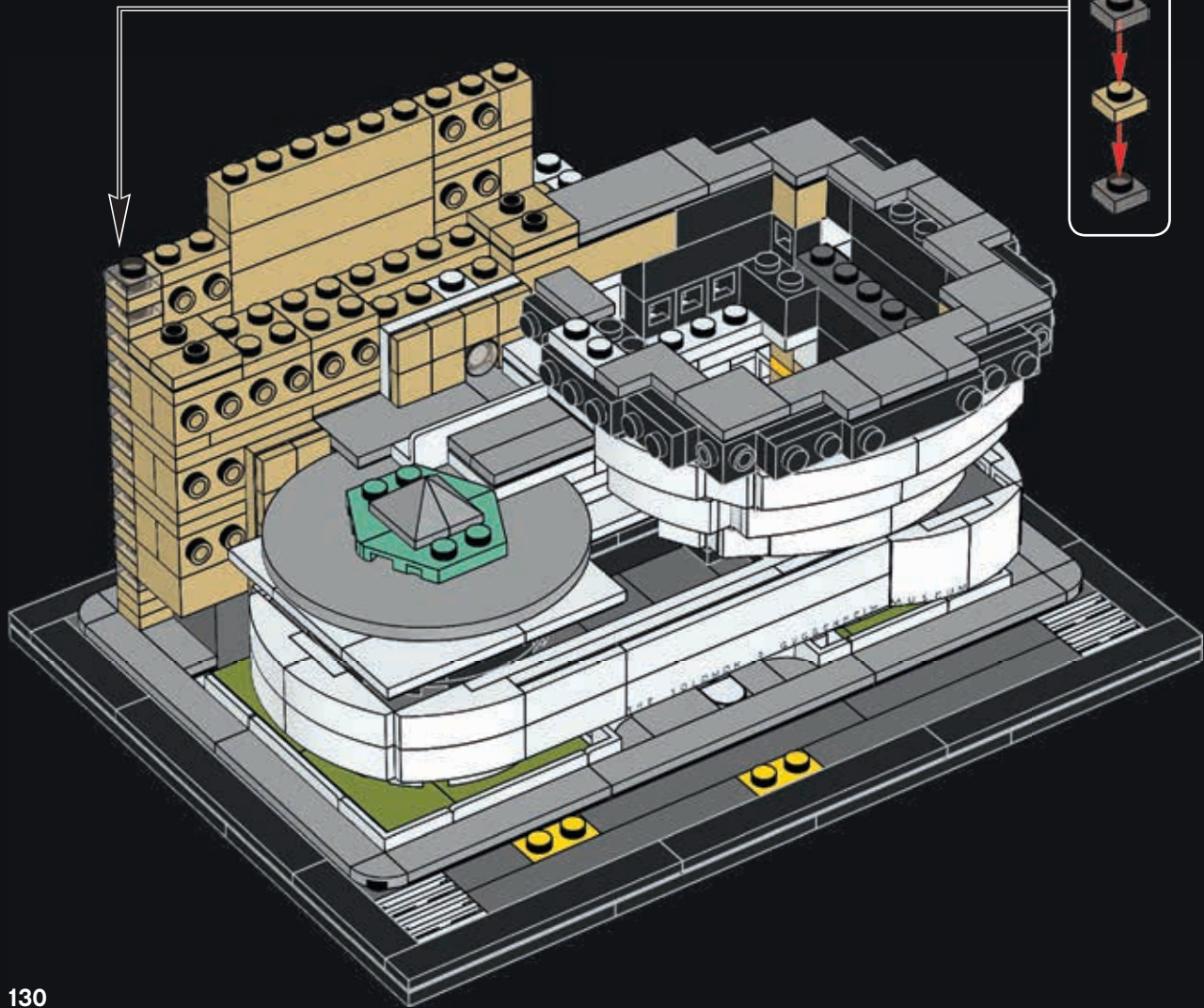



122

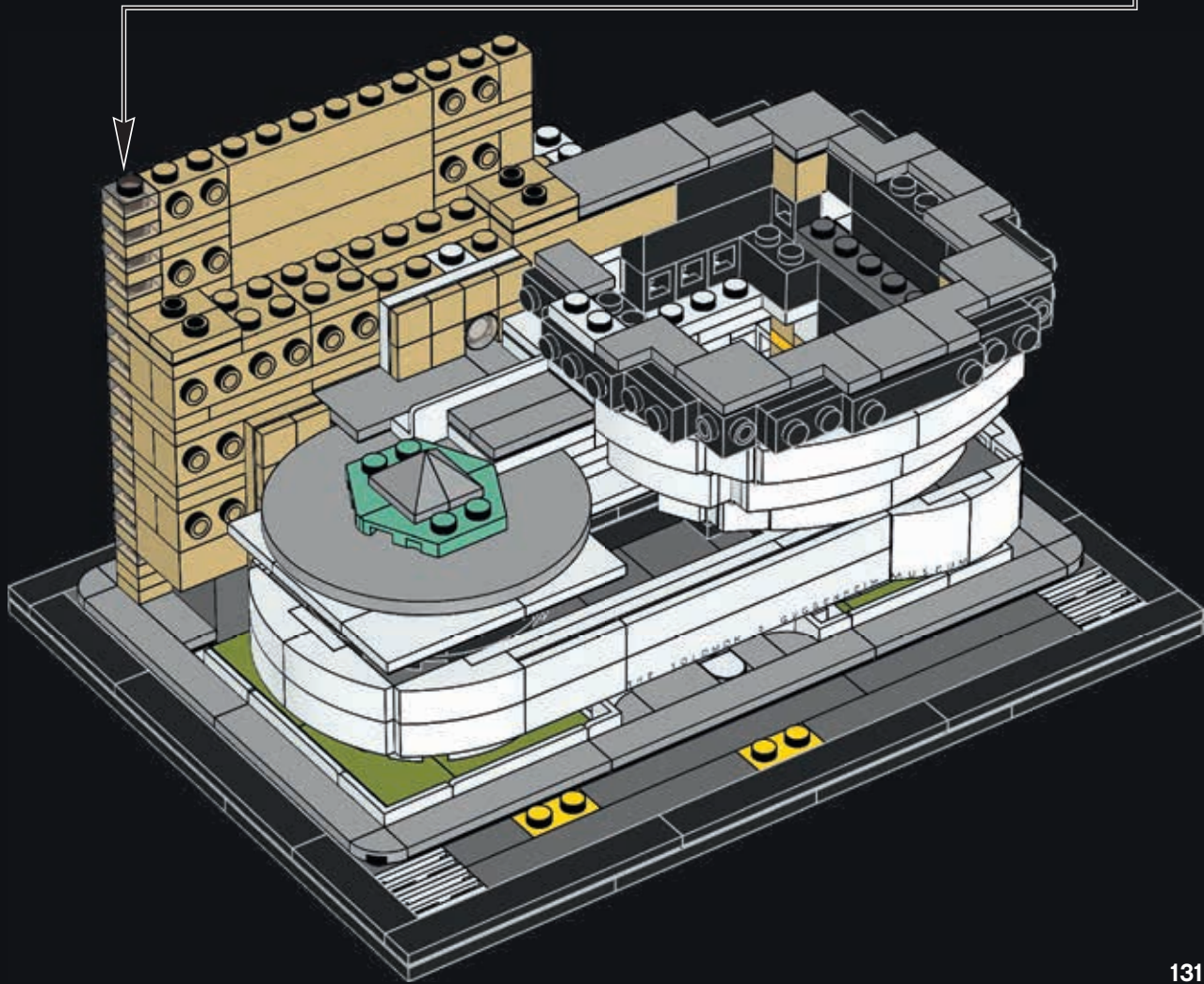



123

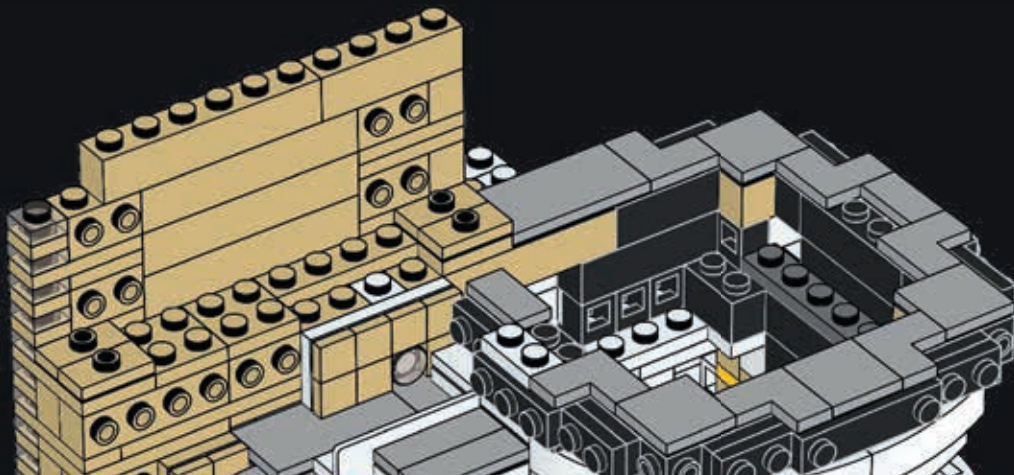

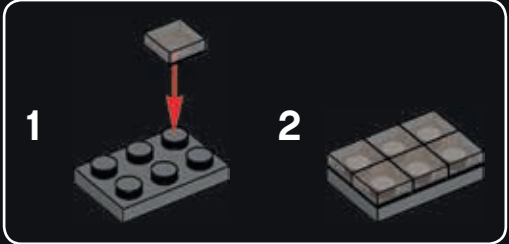
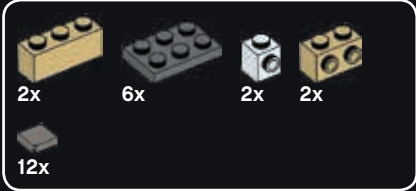

# 124

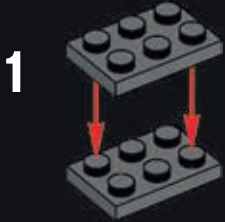

2x

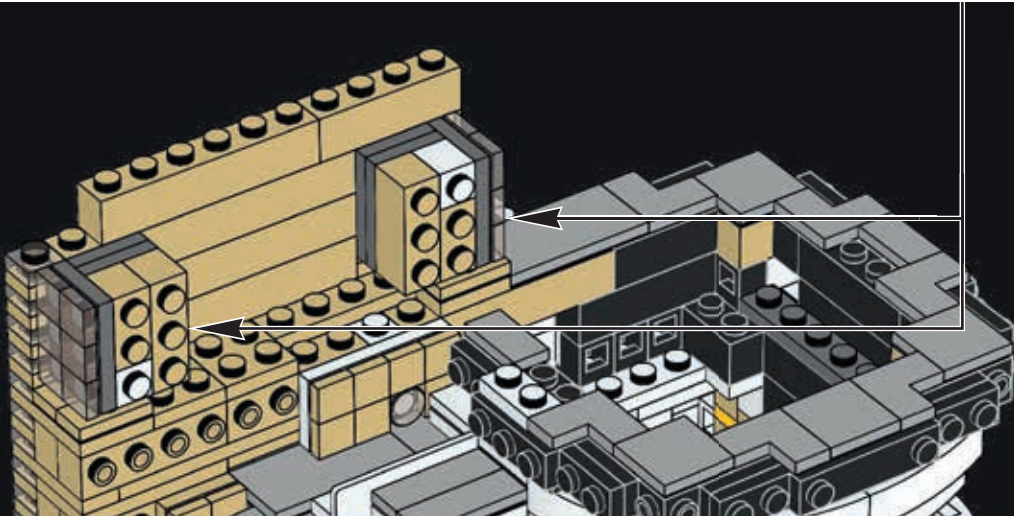



125

1

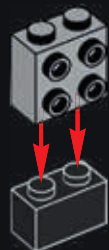

2



3



4

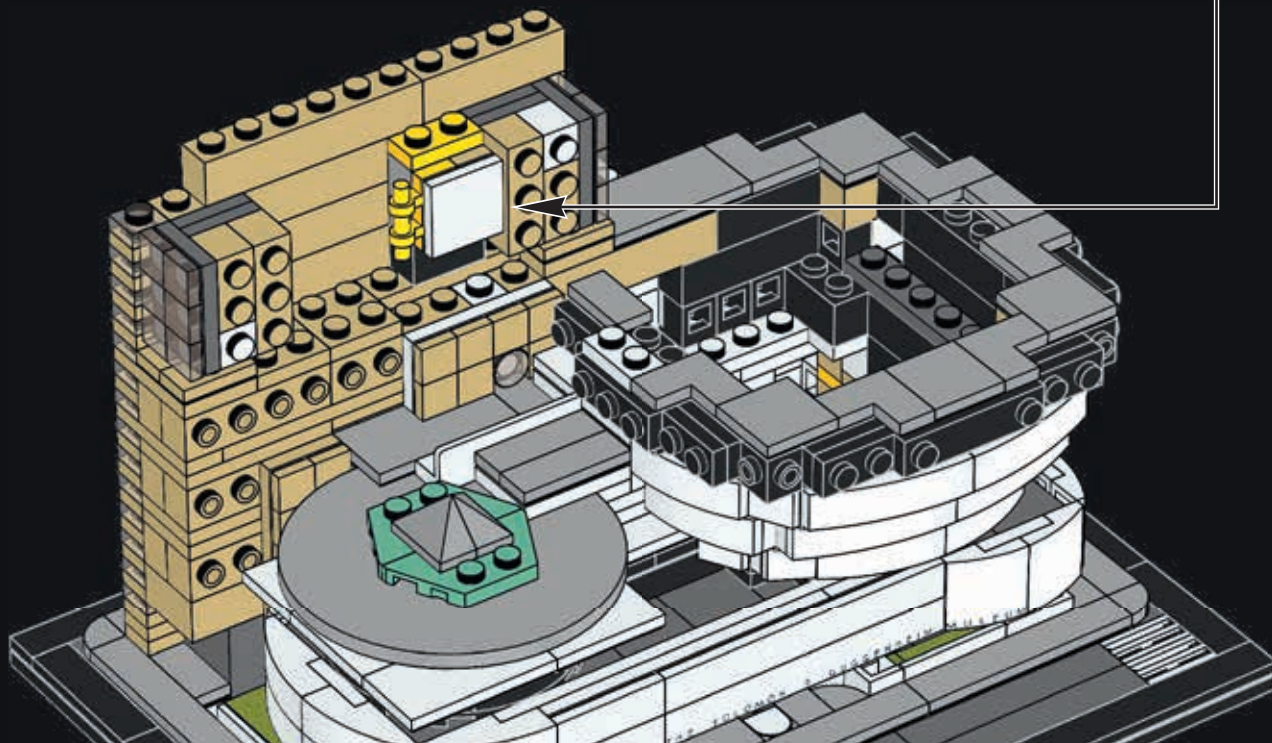

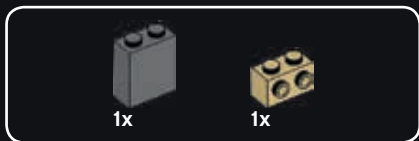

126

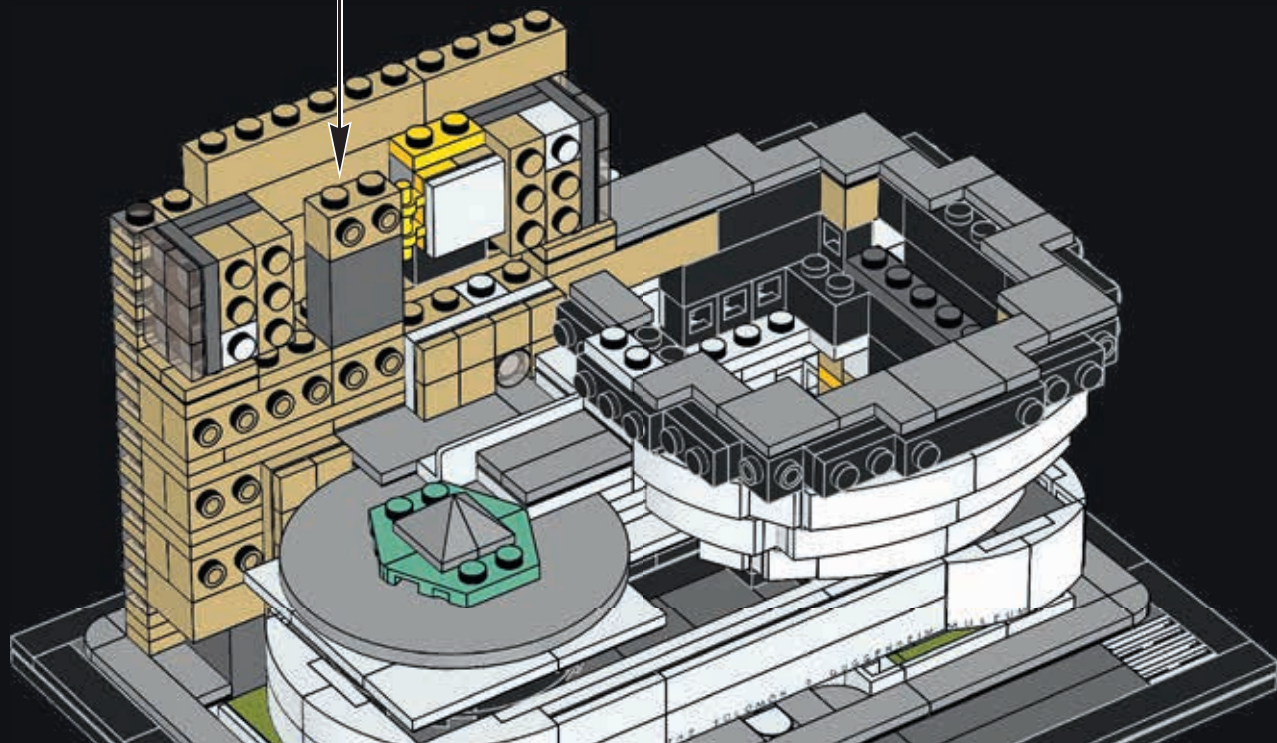
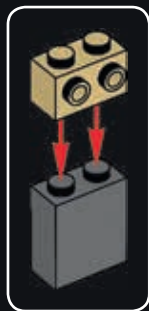

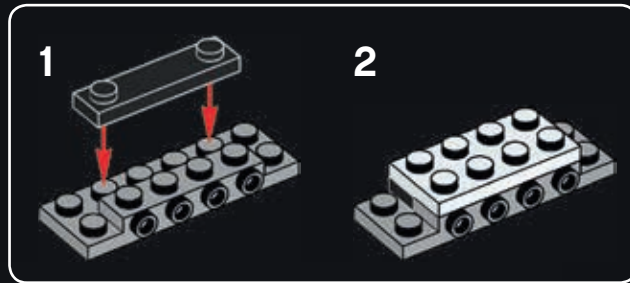
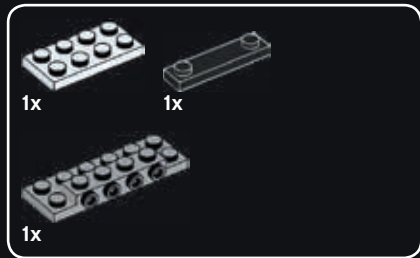

127

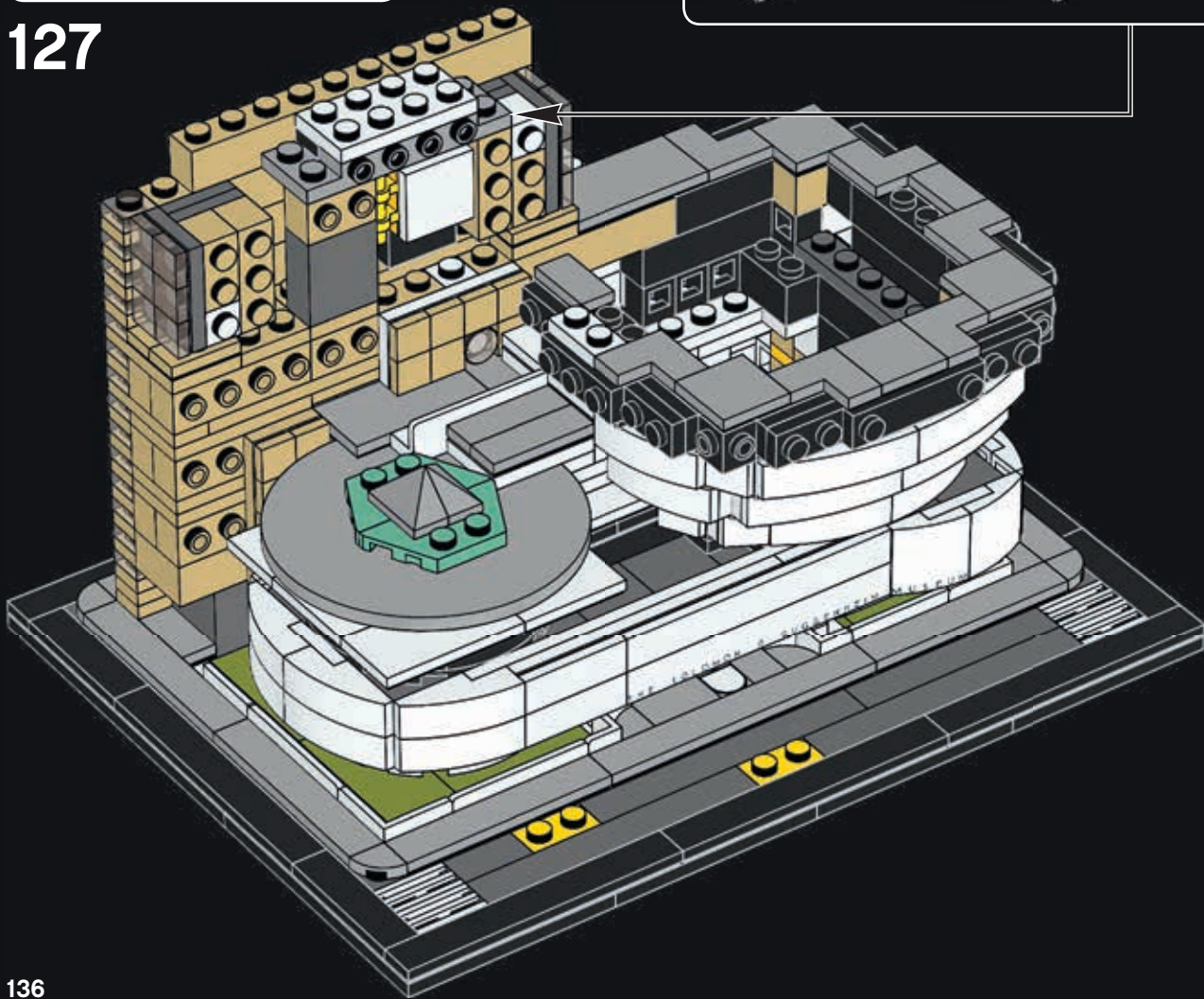





128

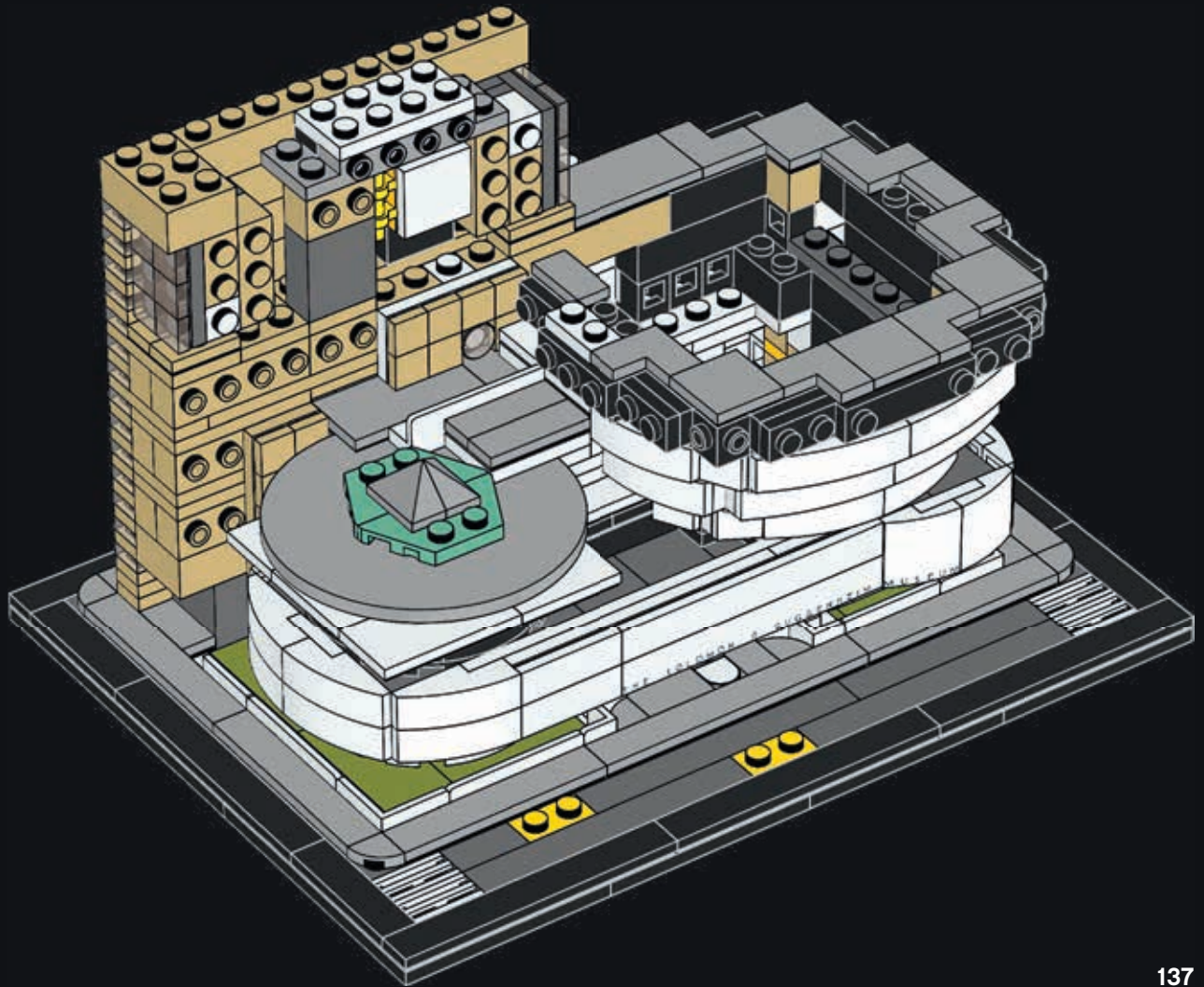

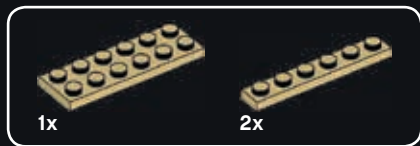

129

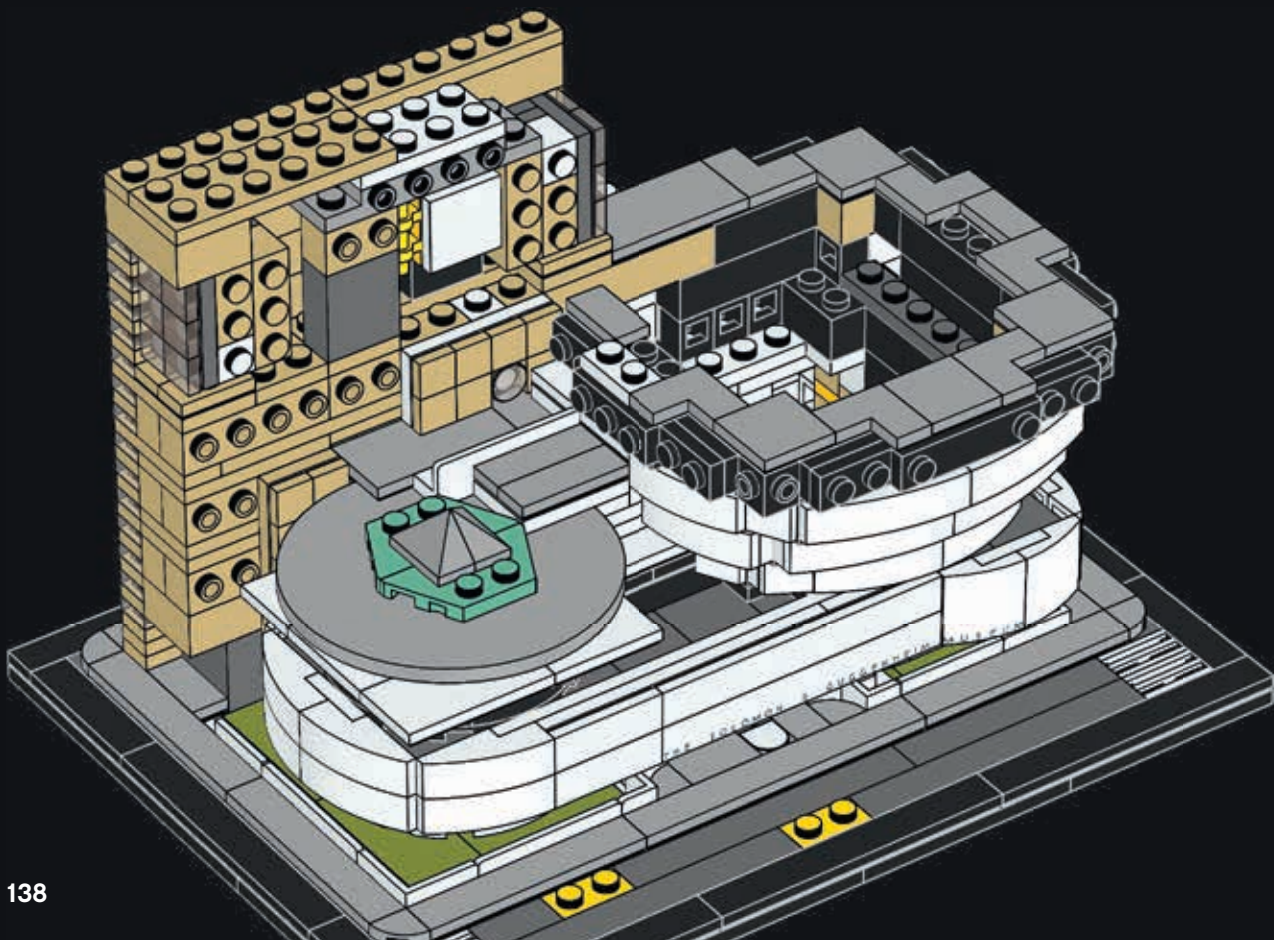



130

1

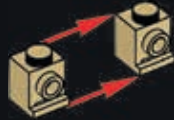

2



3

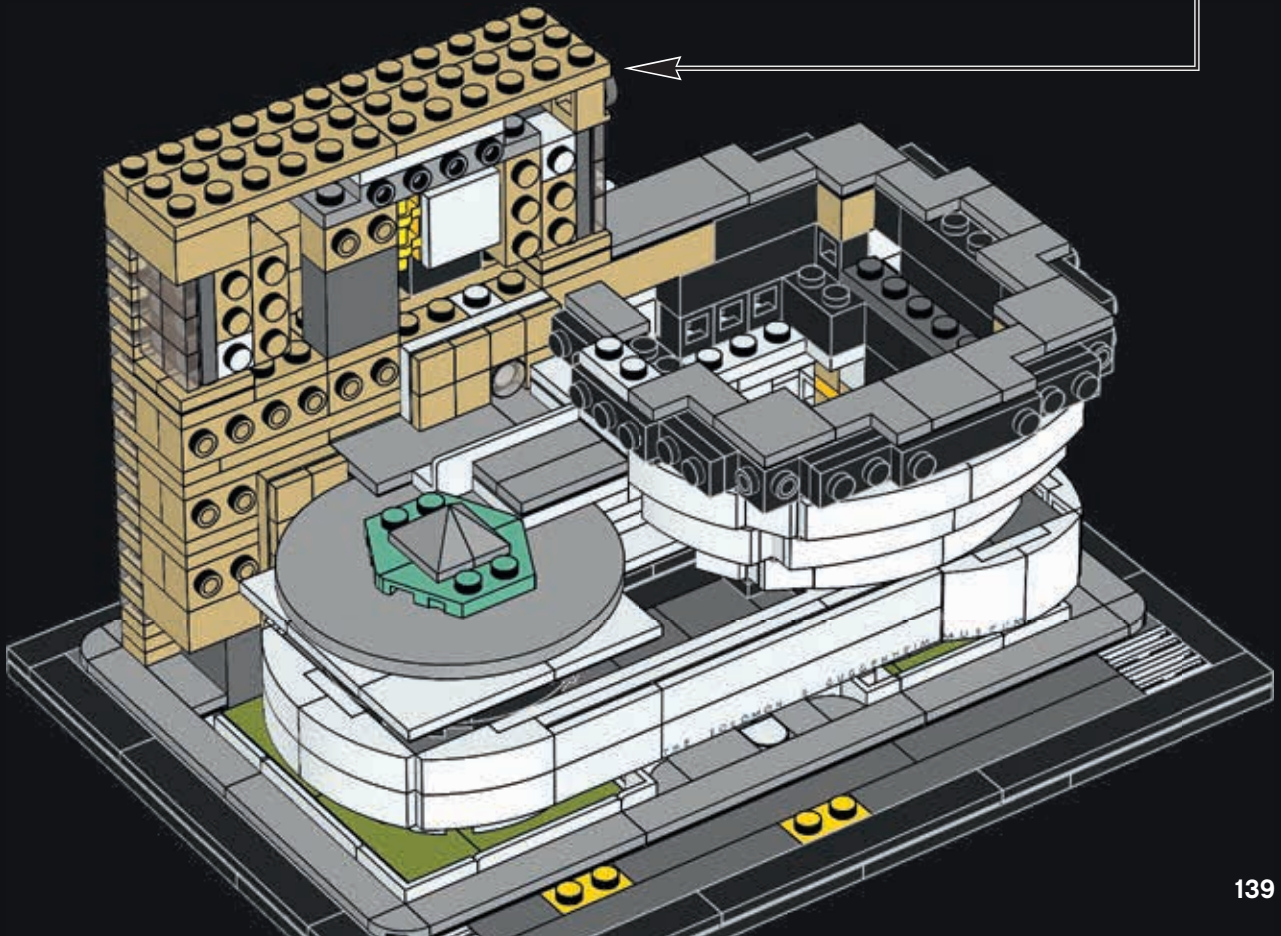

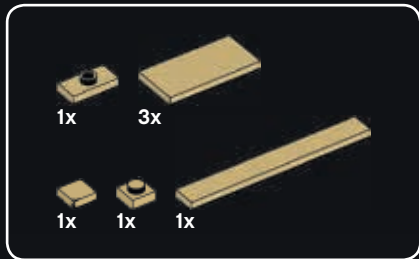

131

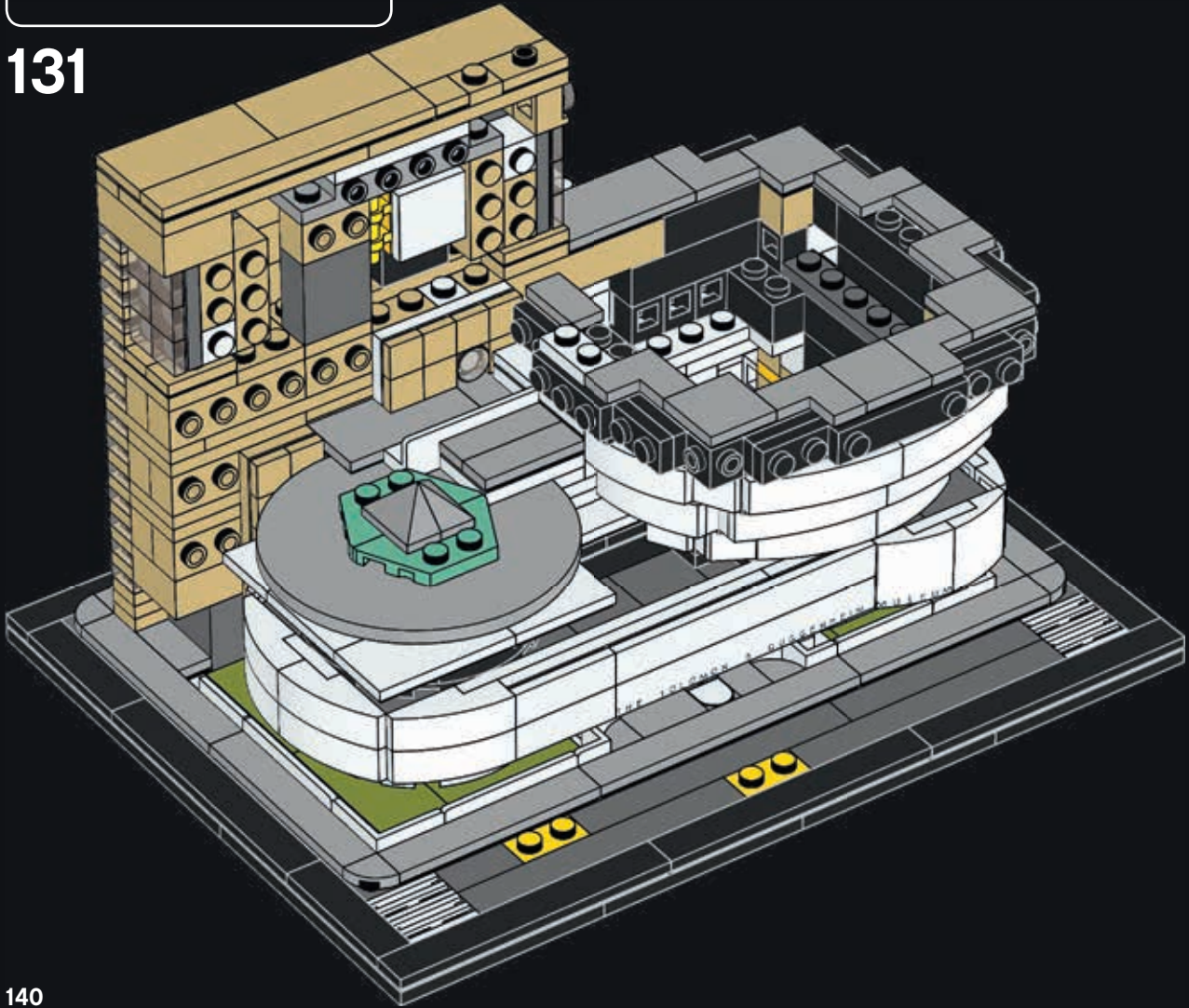



132

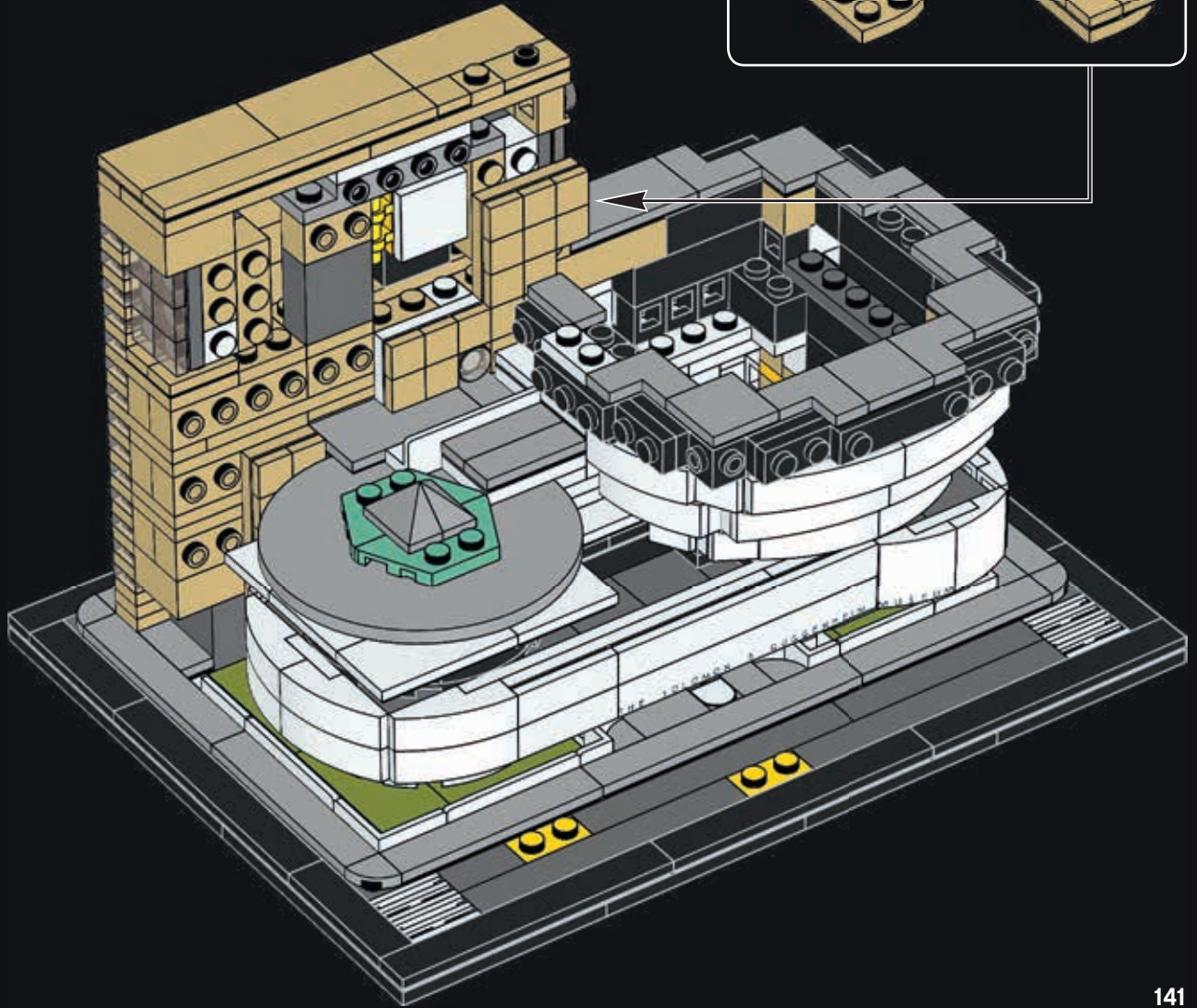
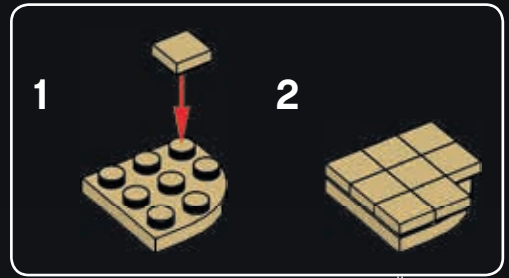



133

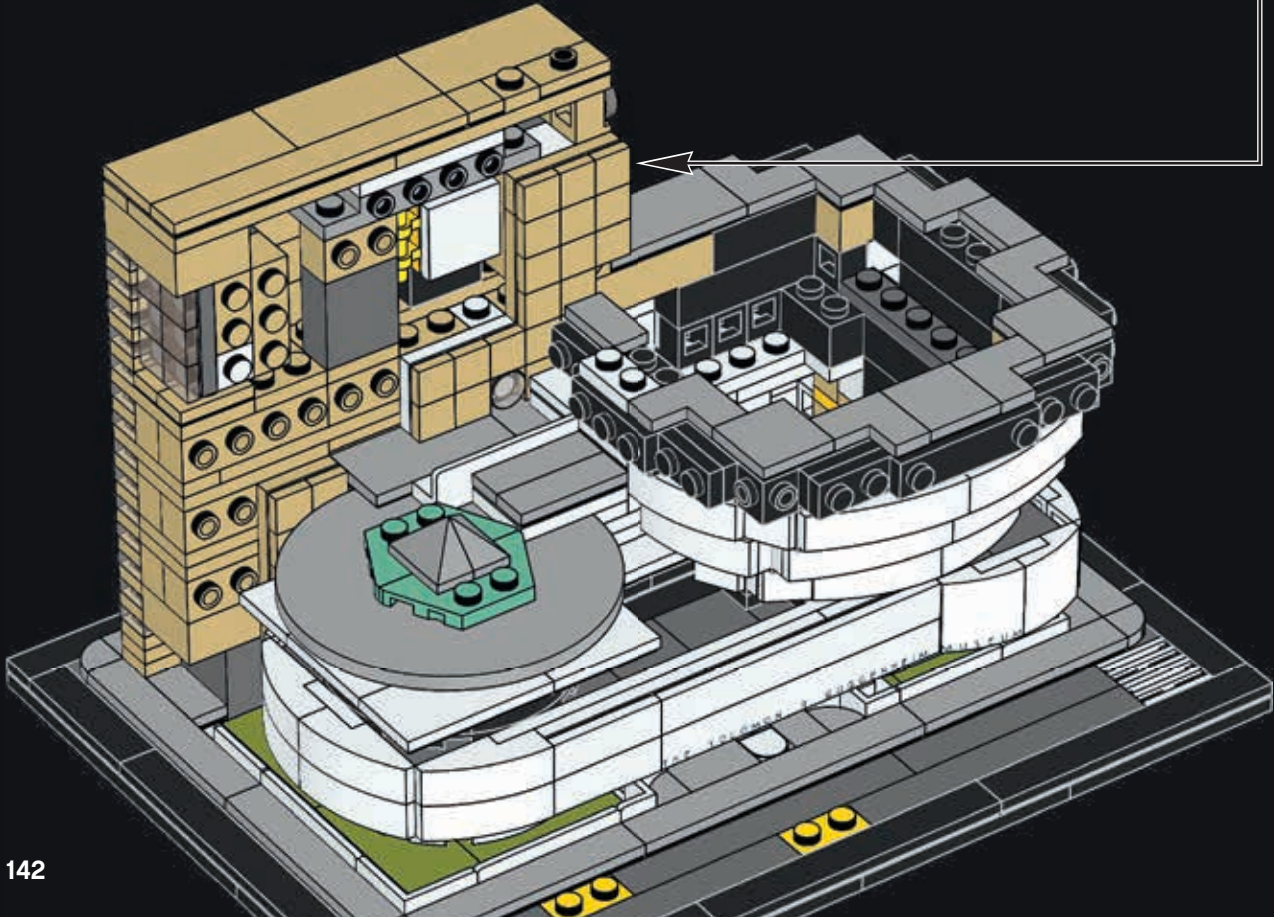
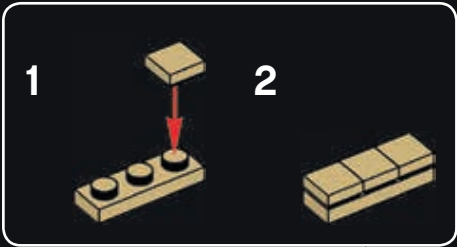



134

1

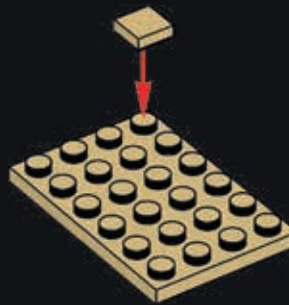

2

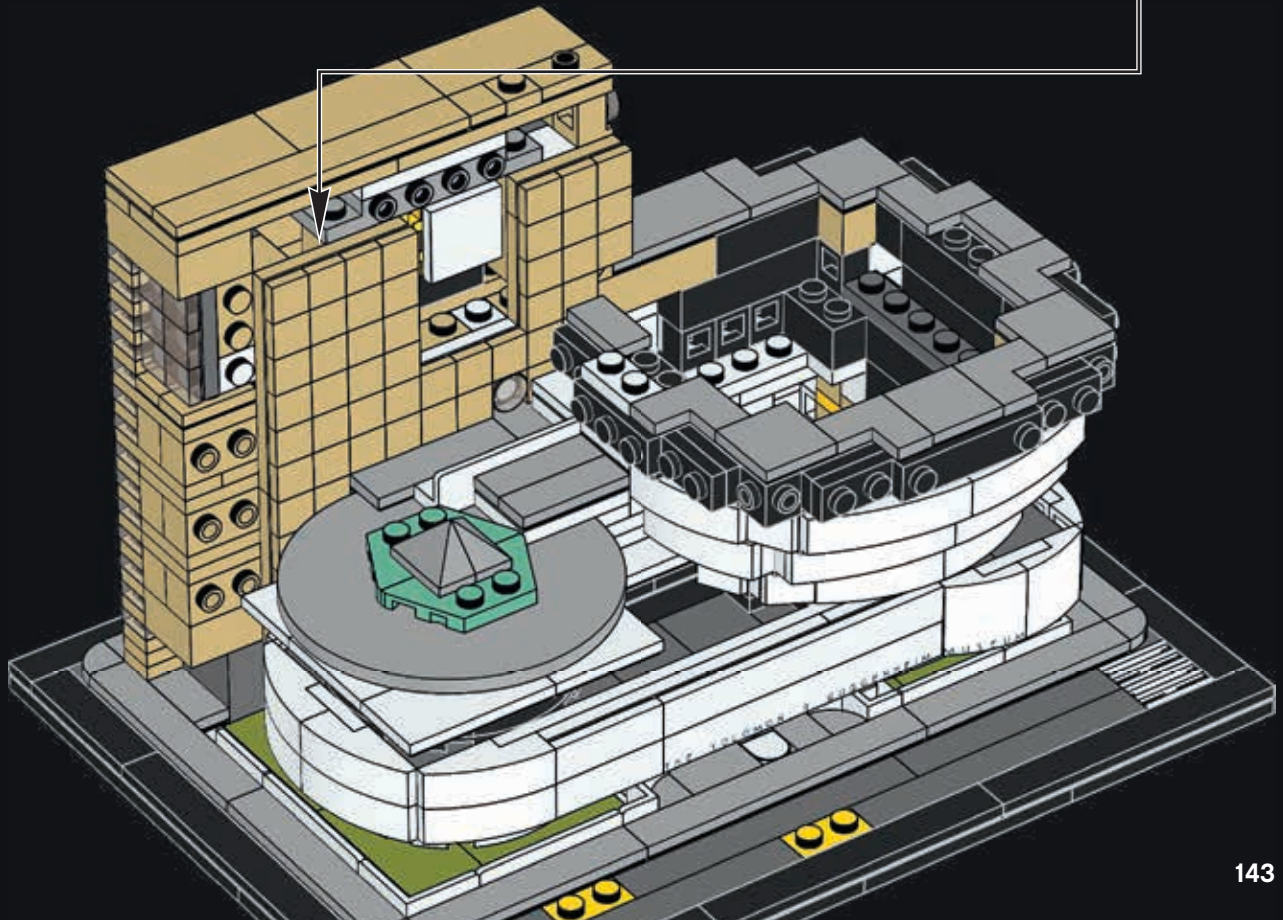



135

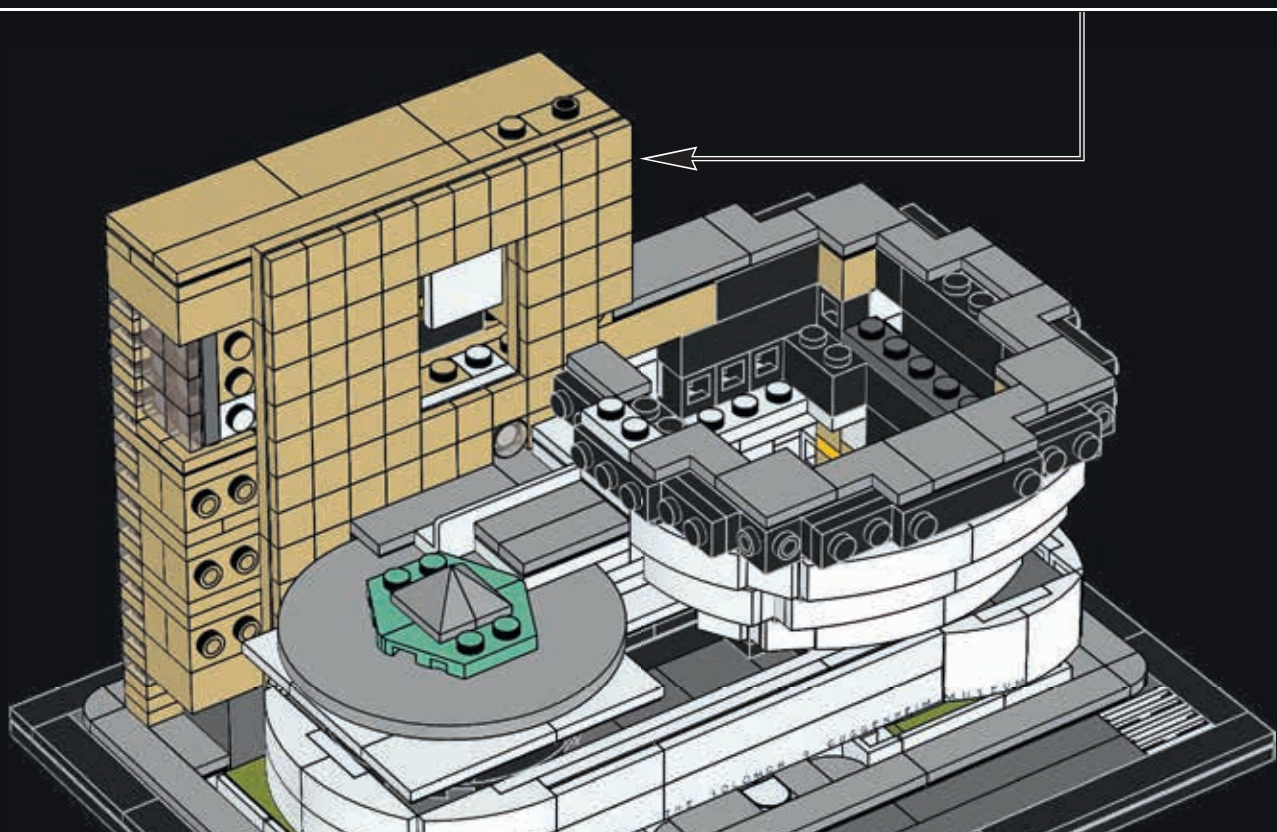
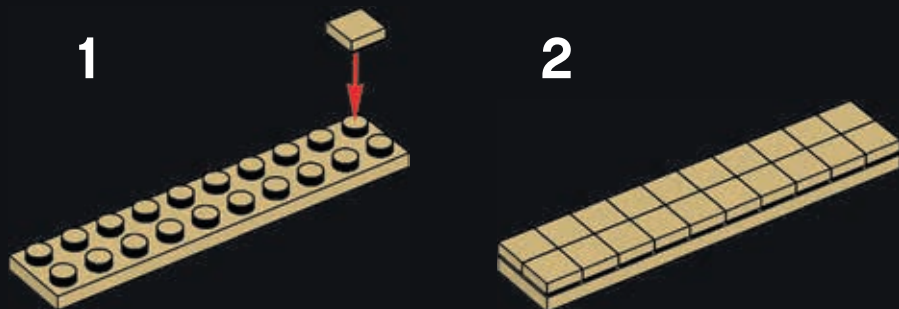



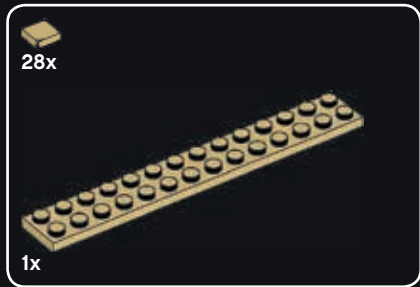

136

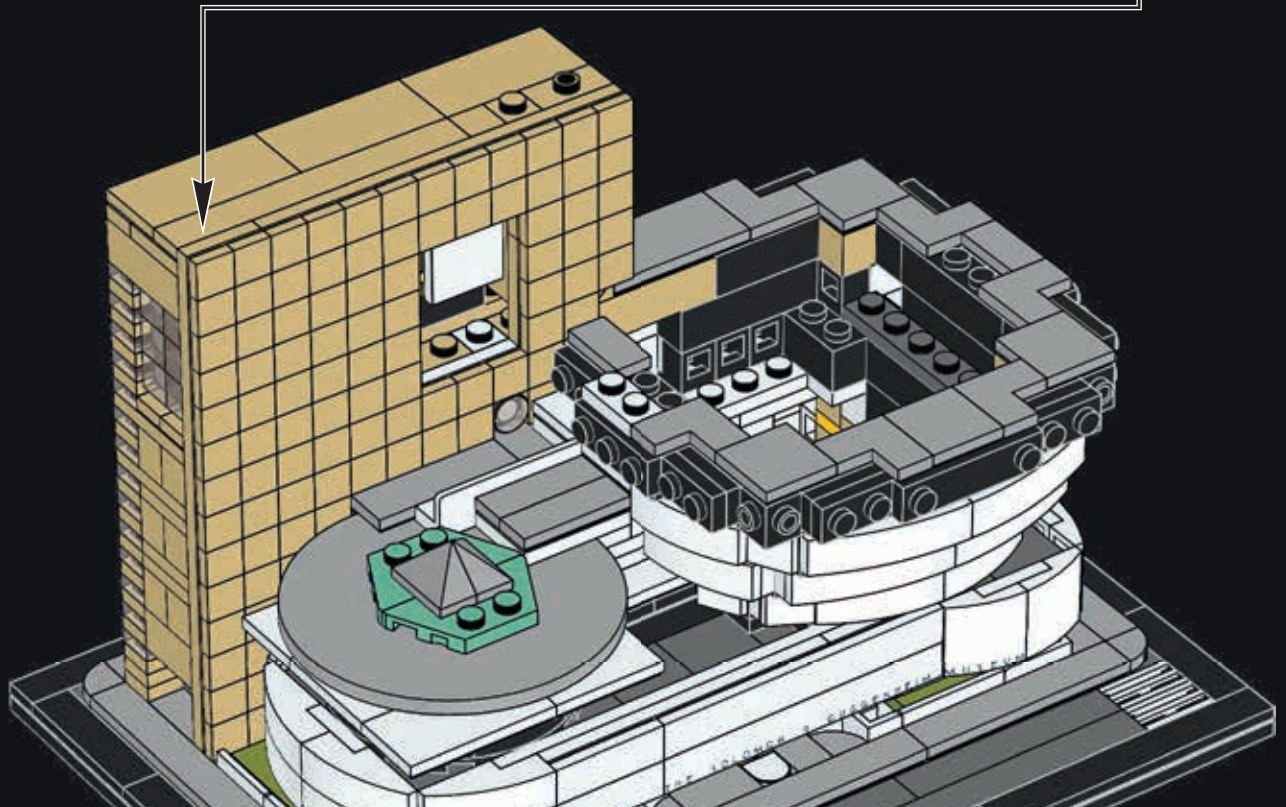
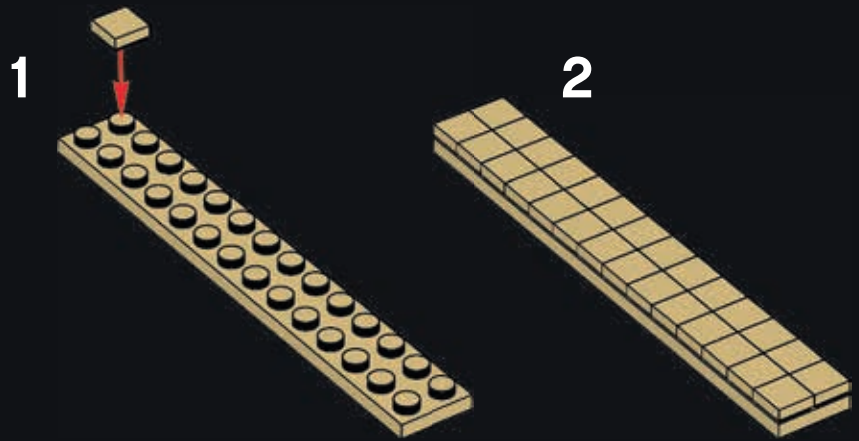



# 137

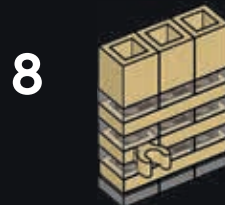

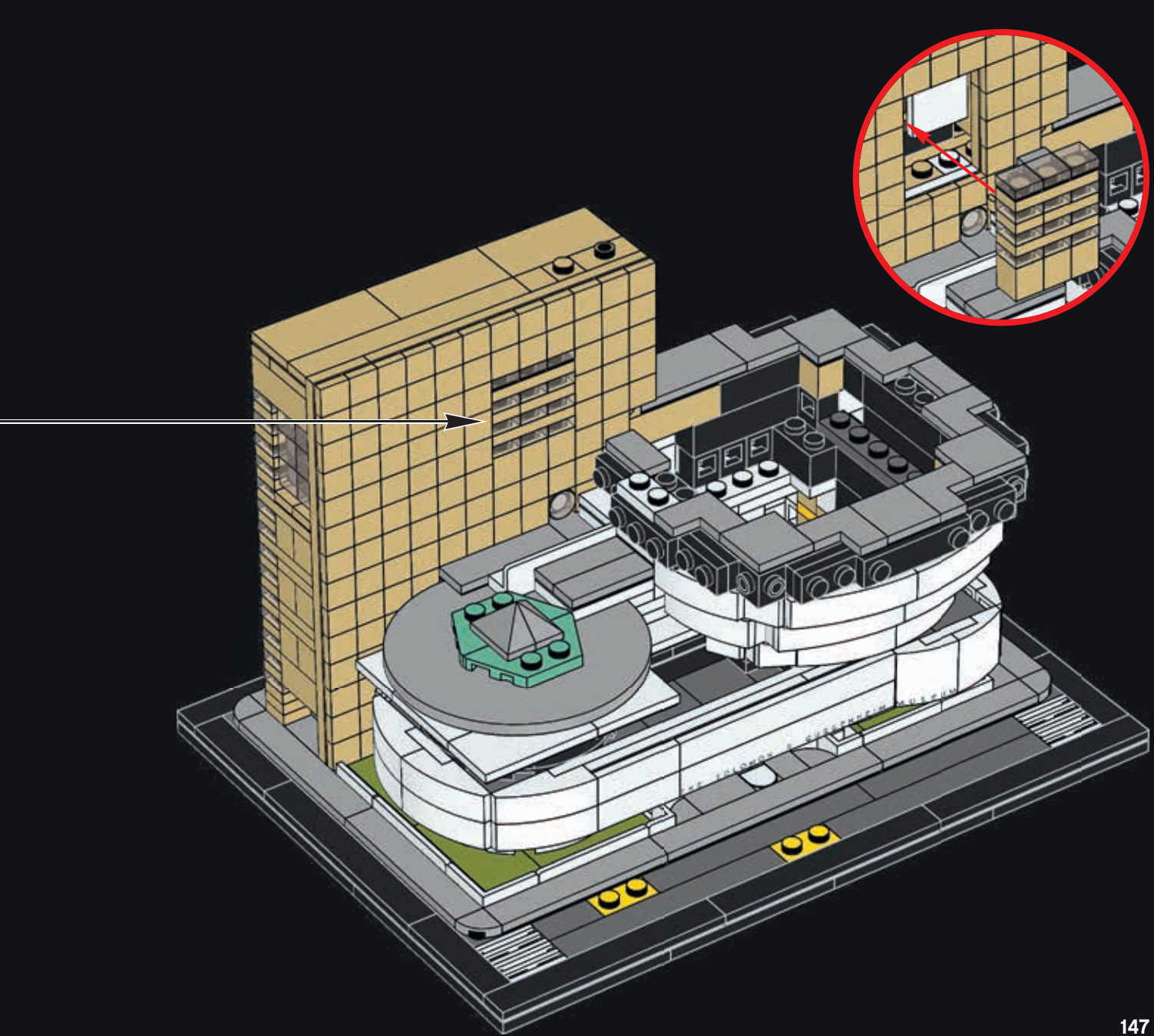

2x

138

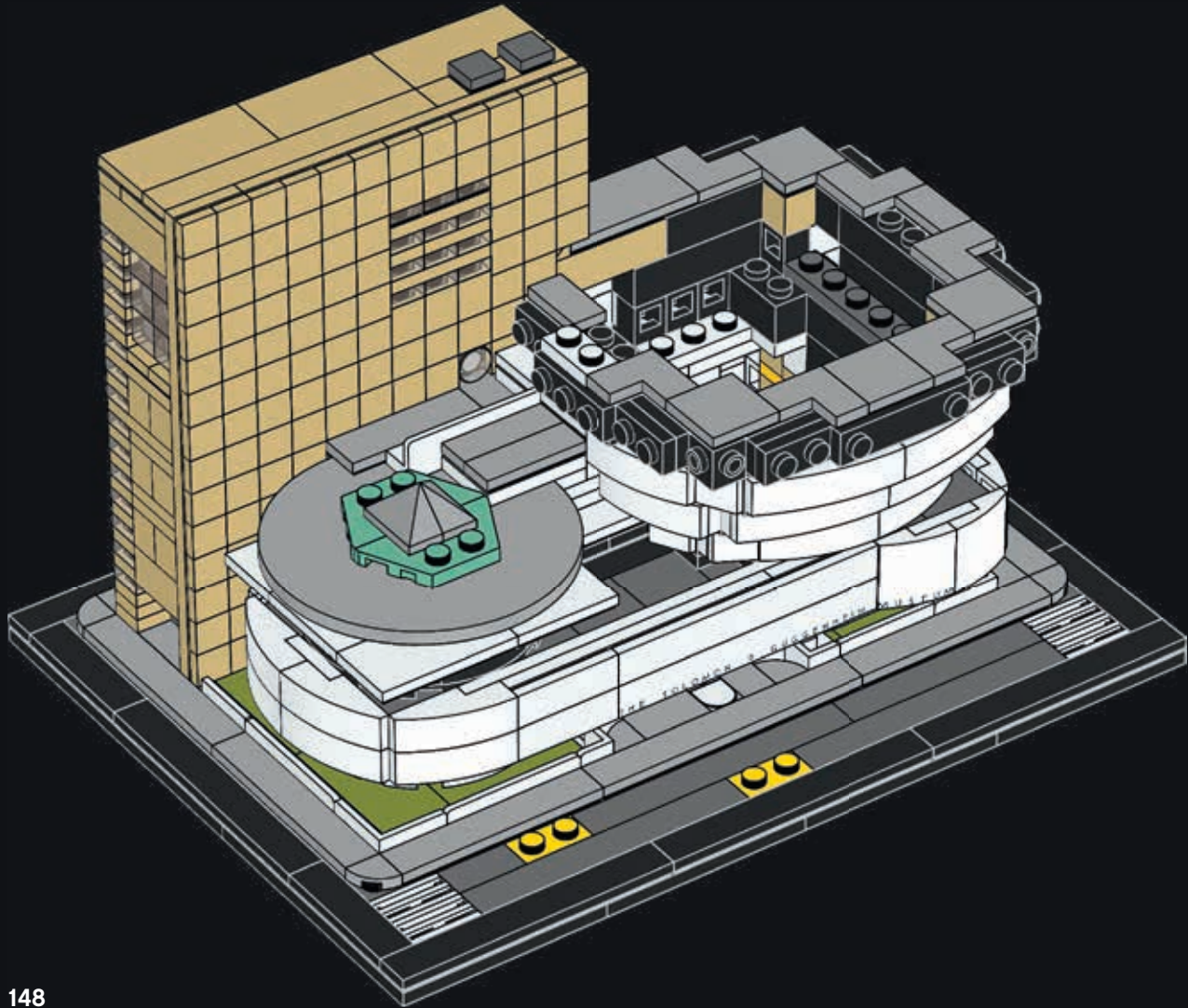

148



139

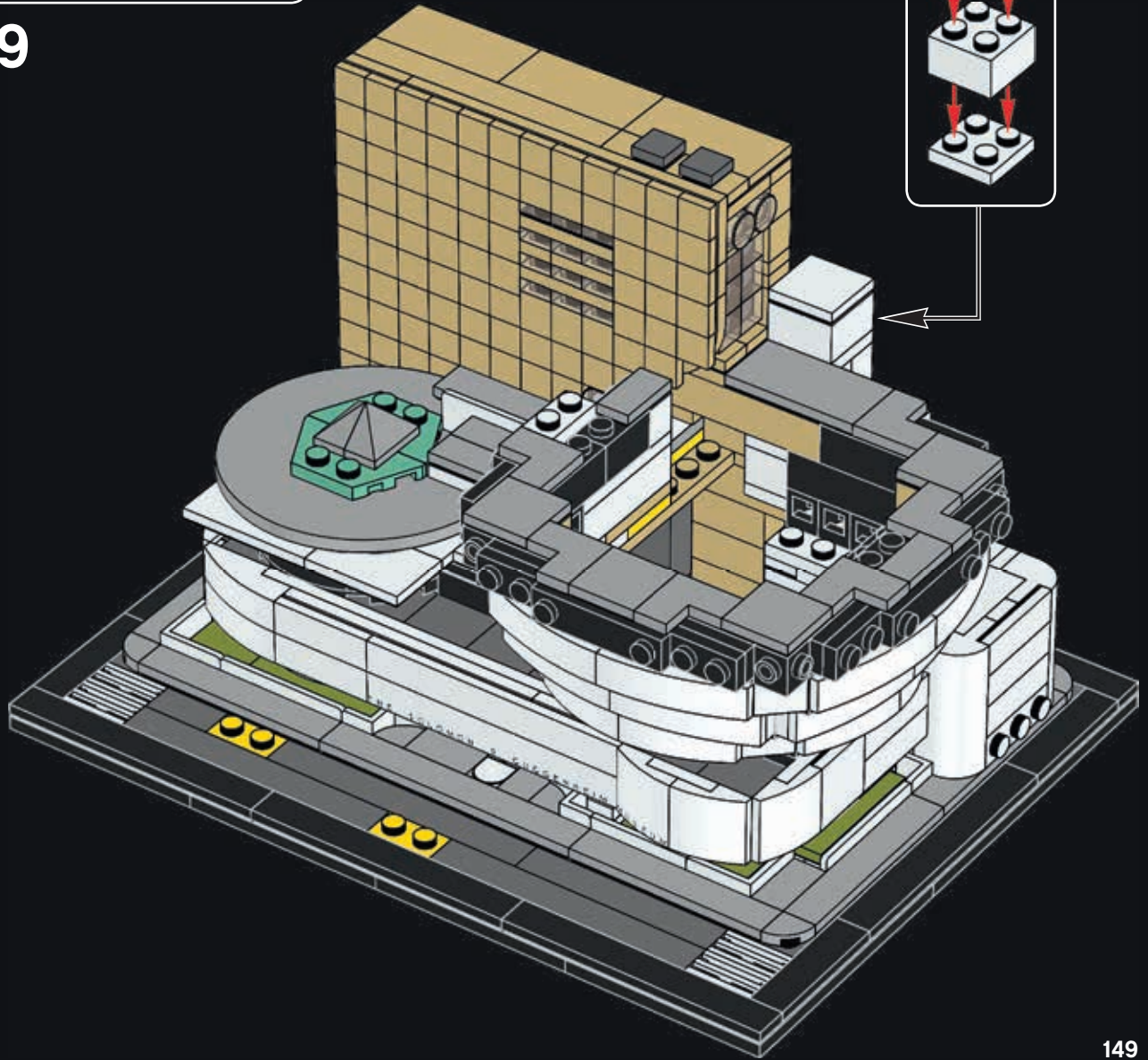



140

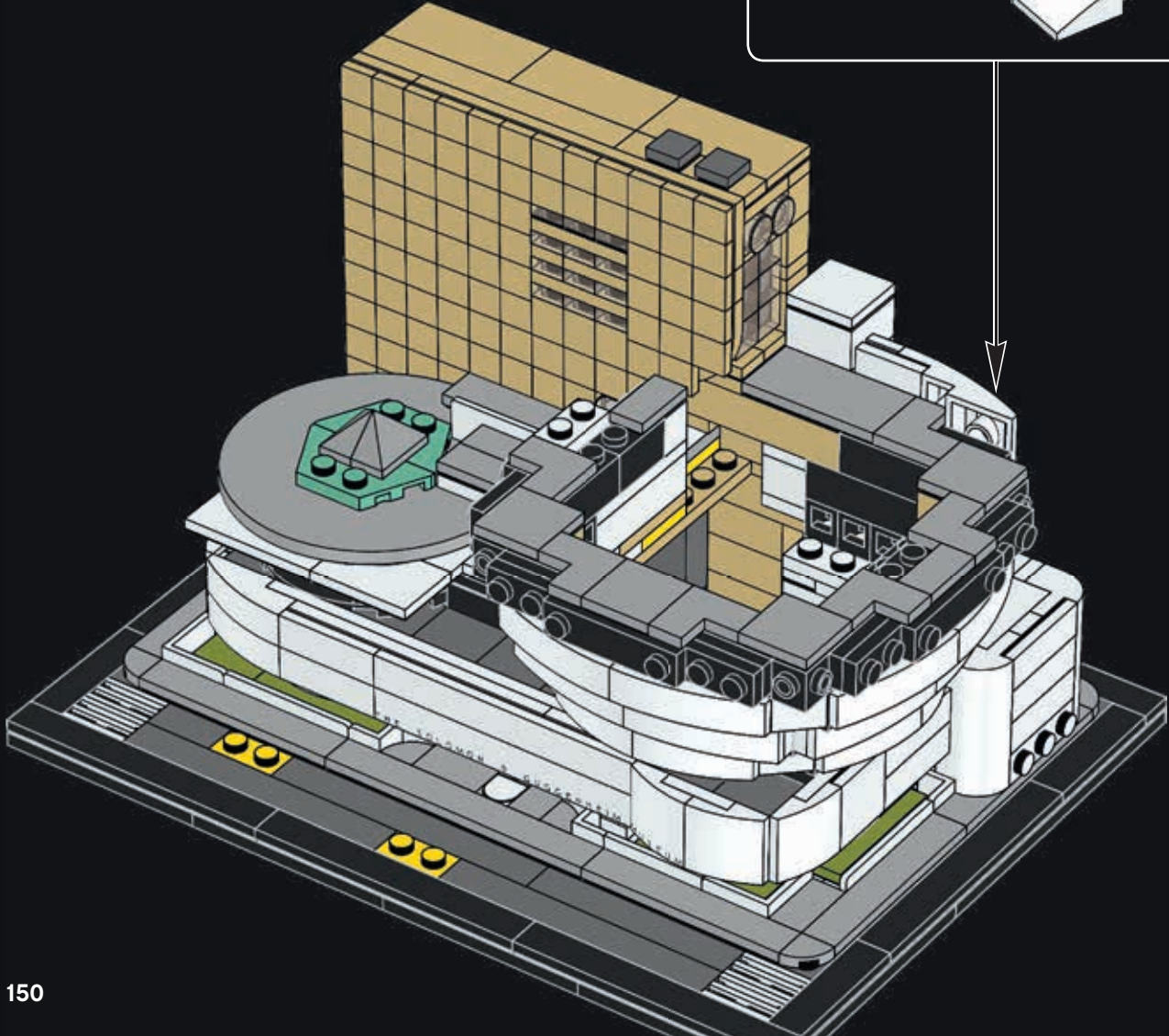
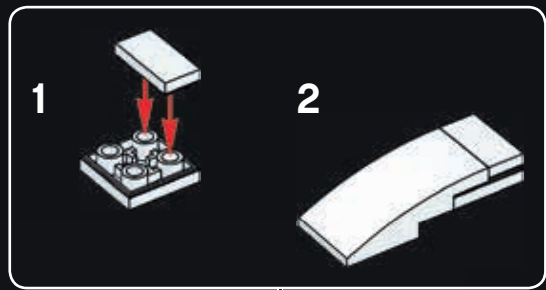



6x

141

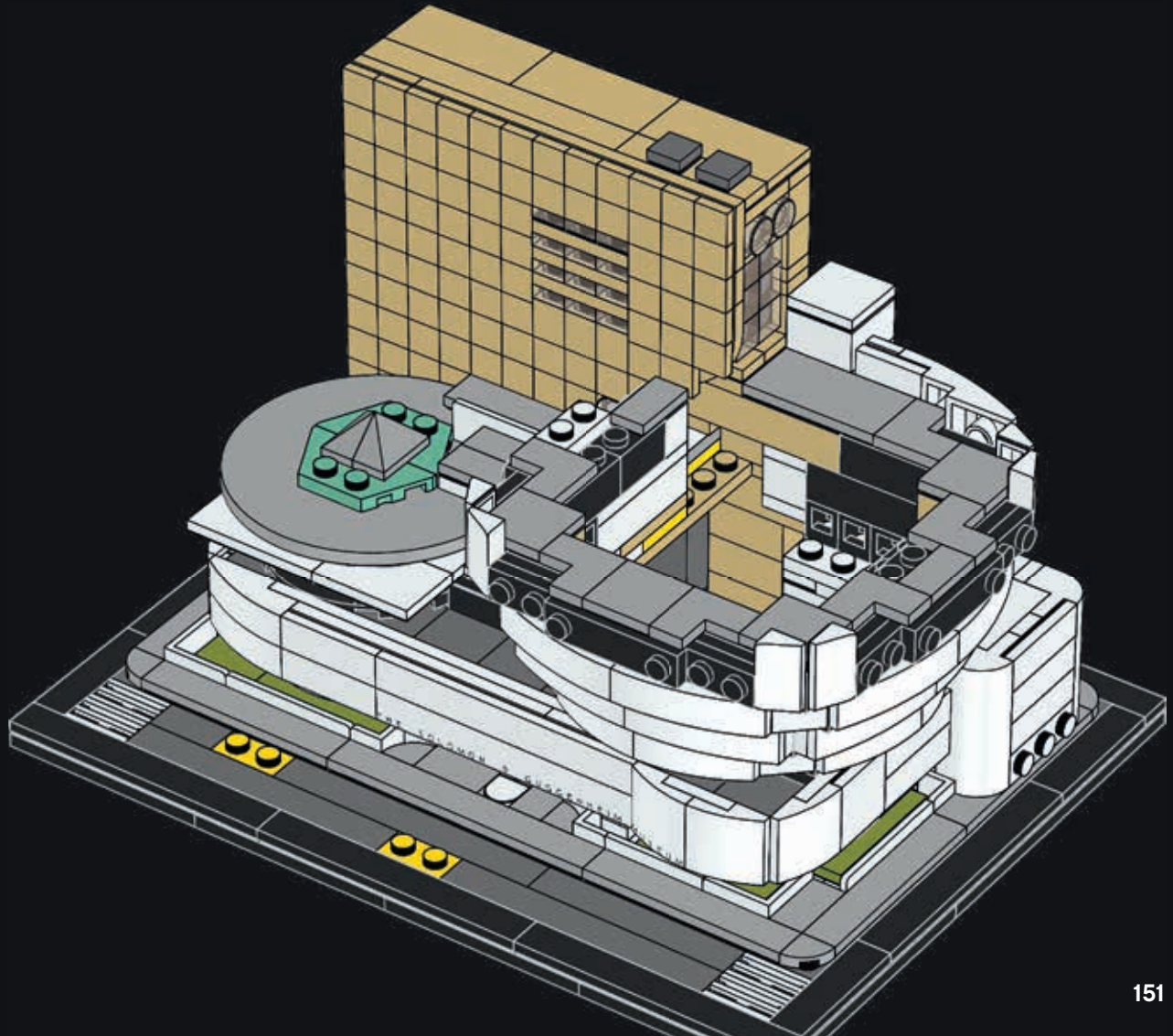

A walk up the Guggenheim ramp from the ground floor to the dome is 1,416 feet (431.5 m) long.





142

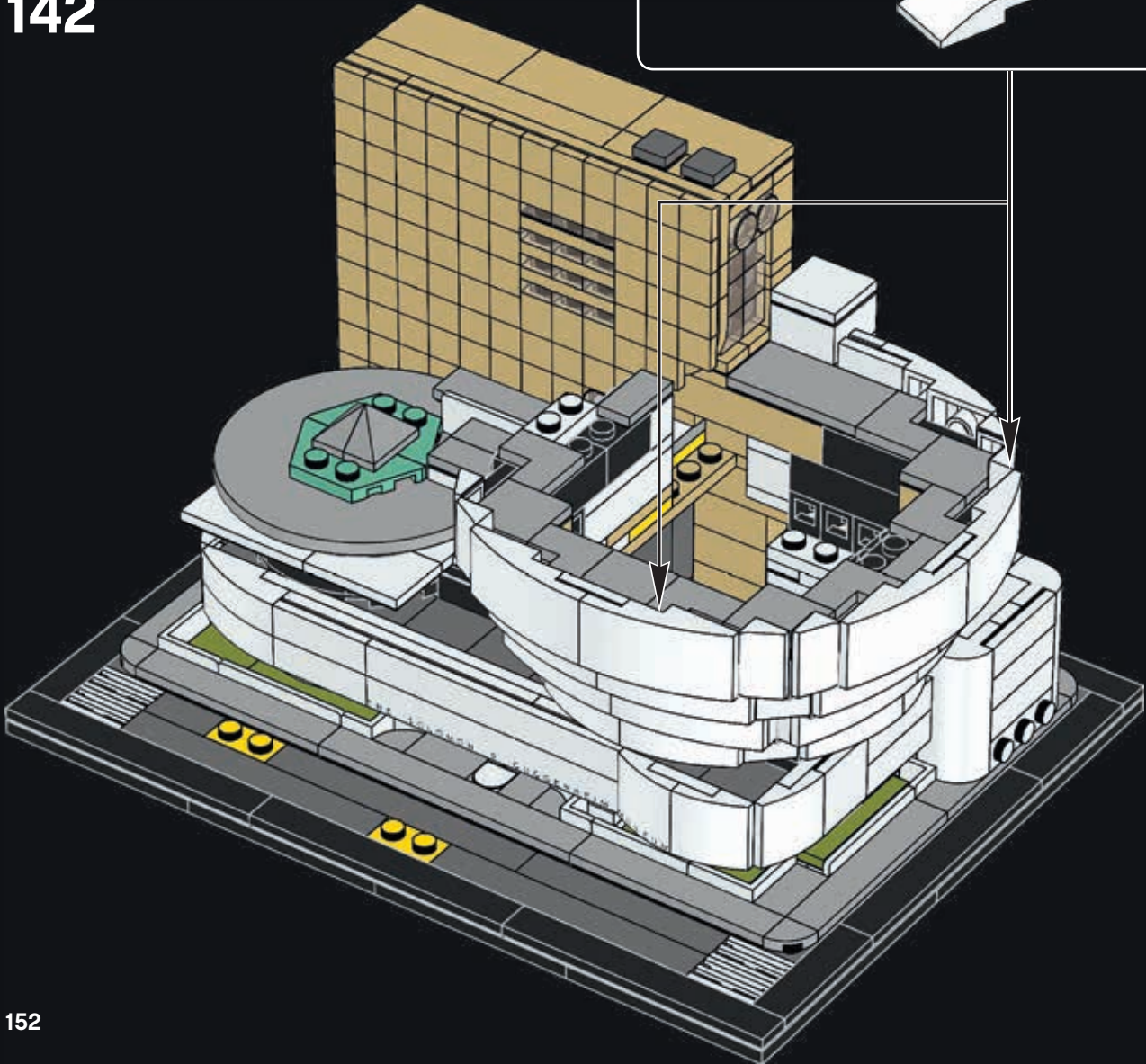





1x



1x

143

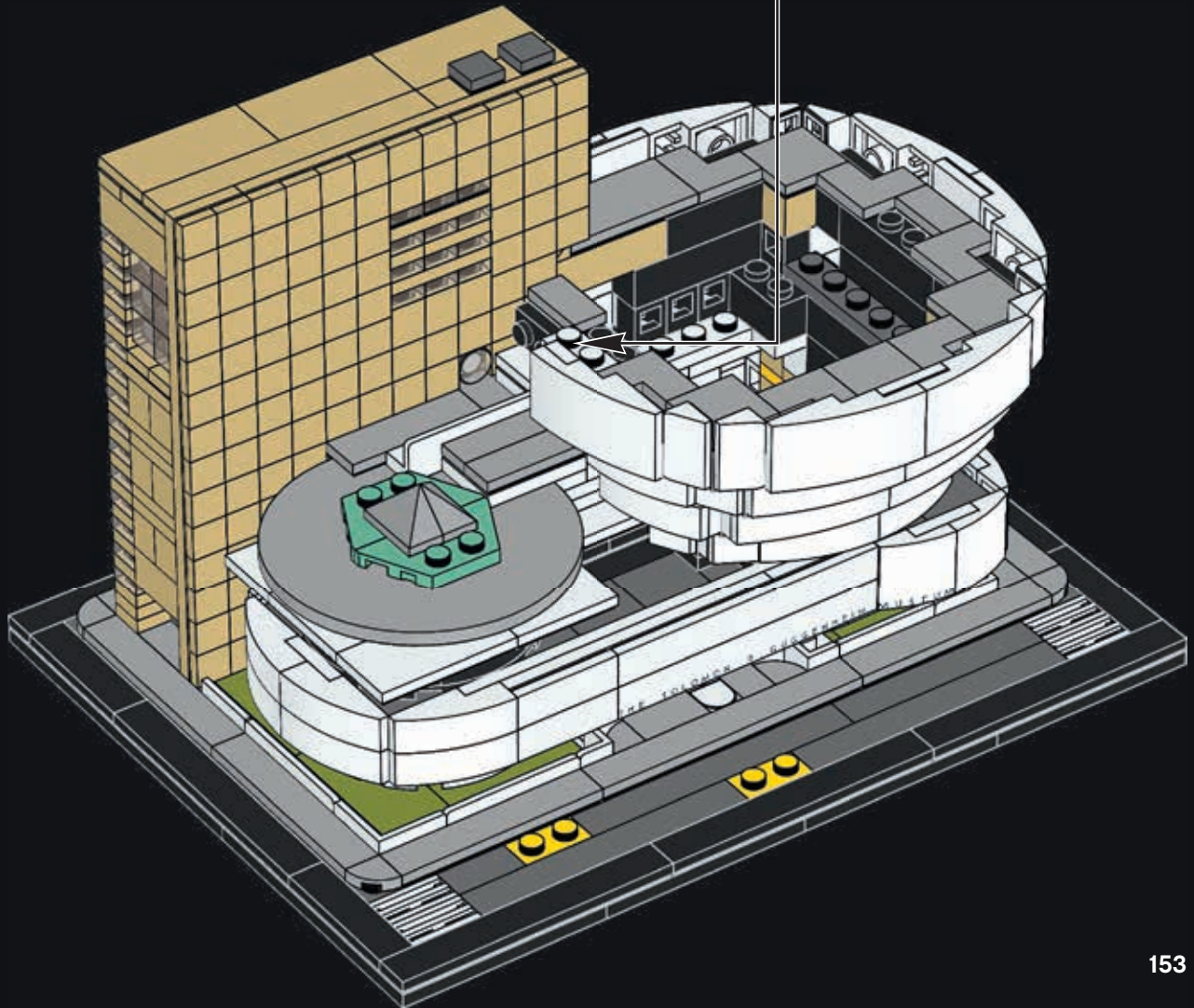
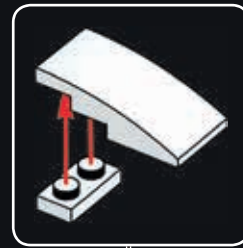



144

1



2



3

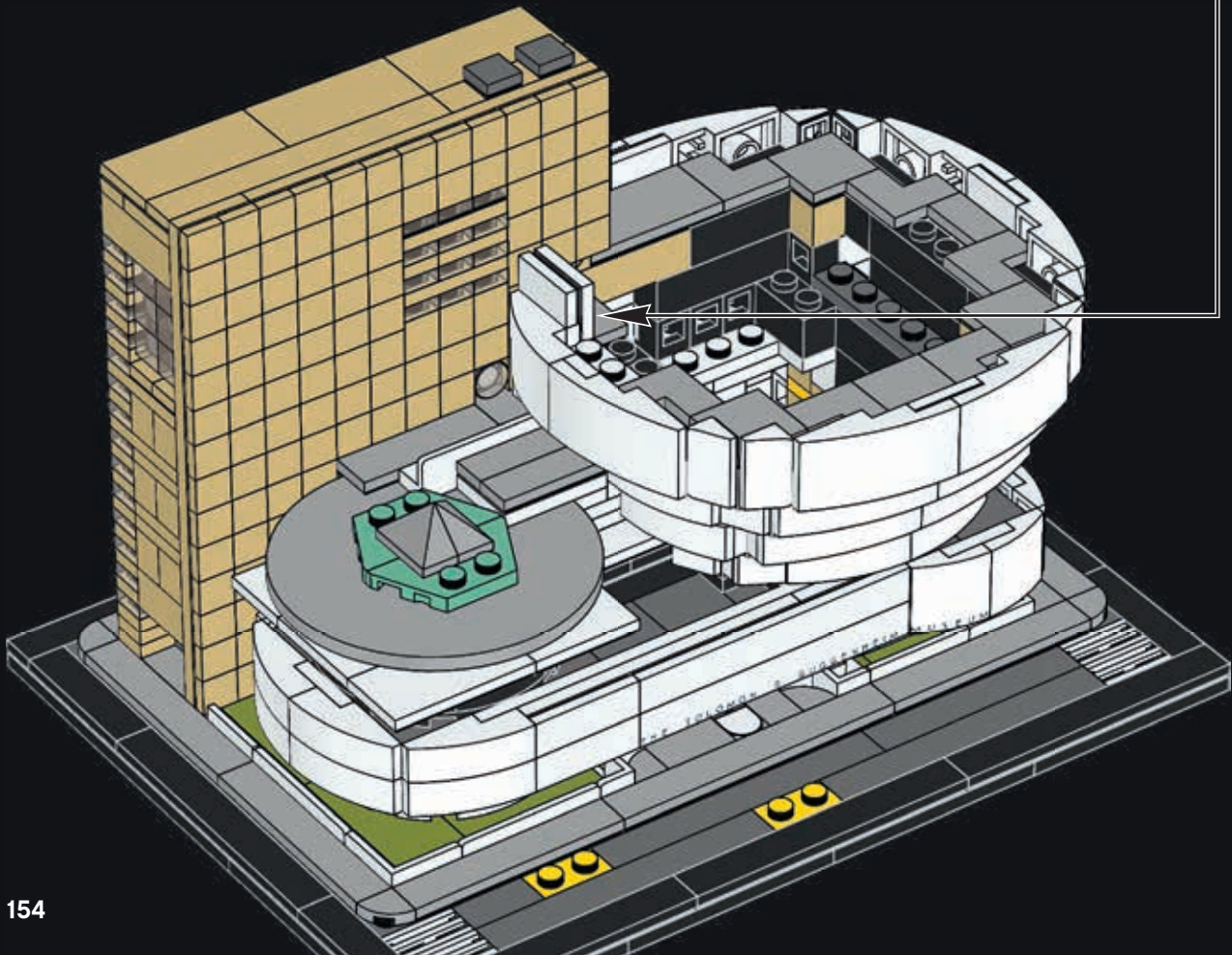

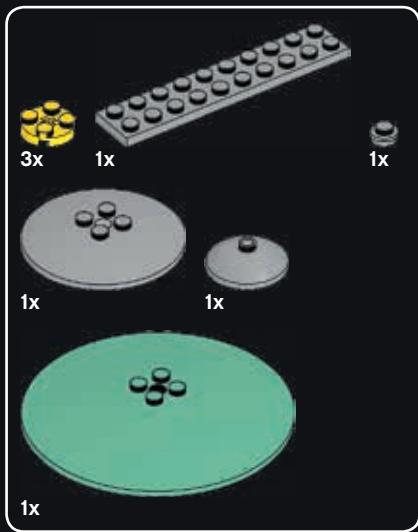

145

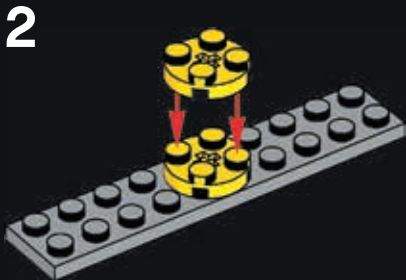

3



4



5

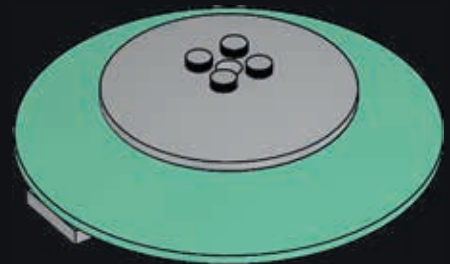

6



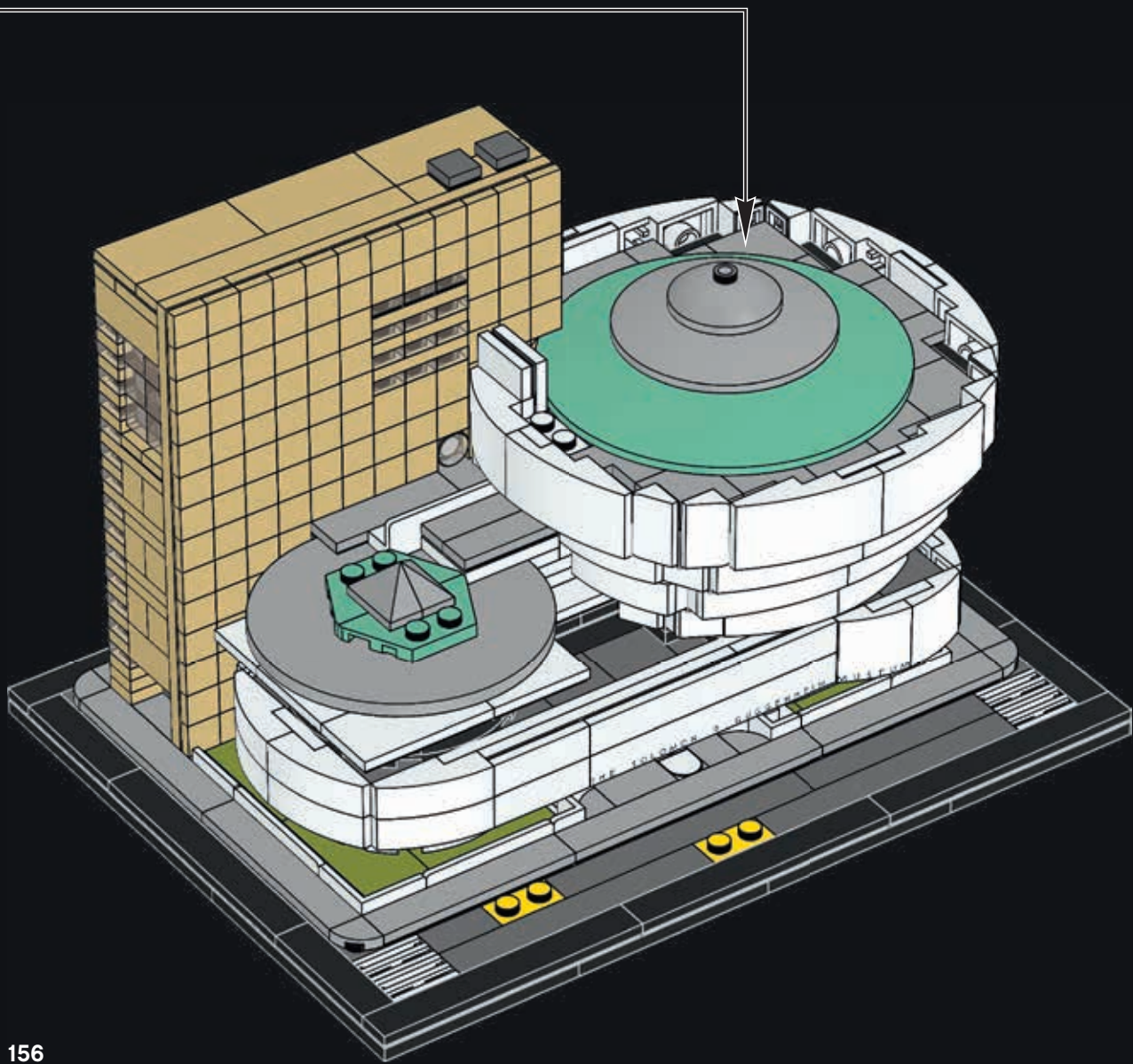



146

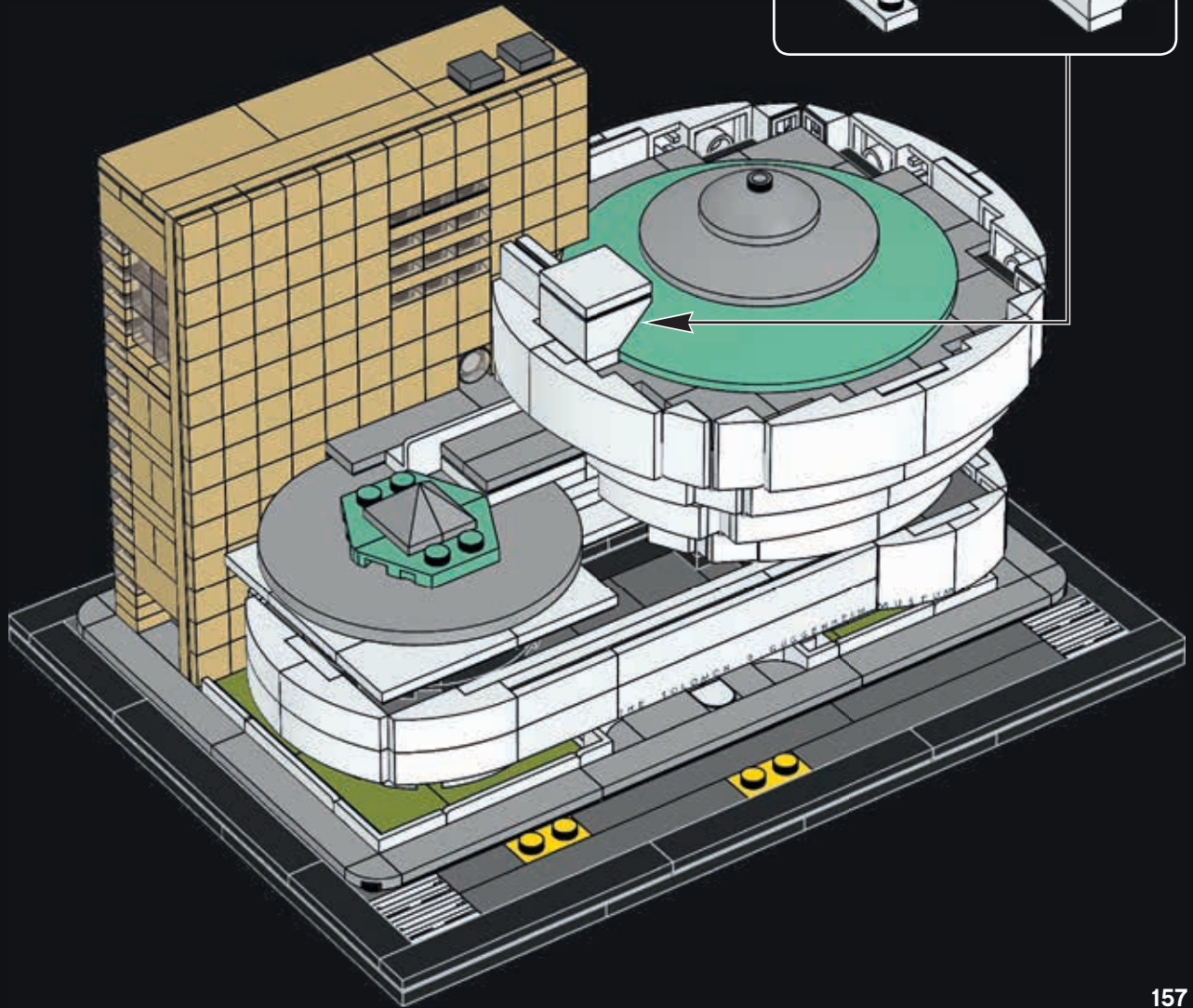

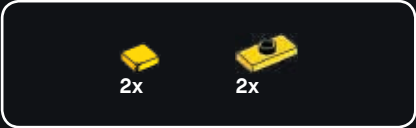

147

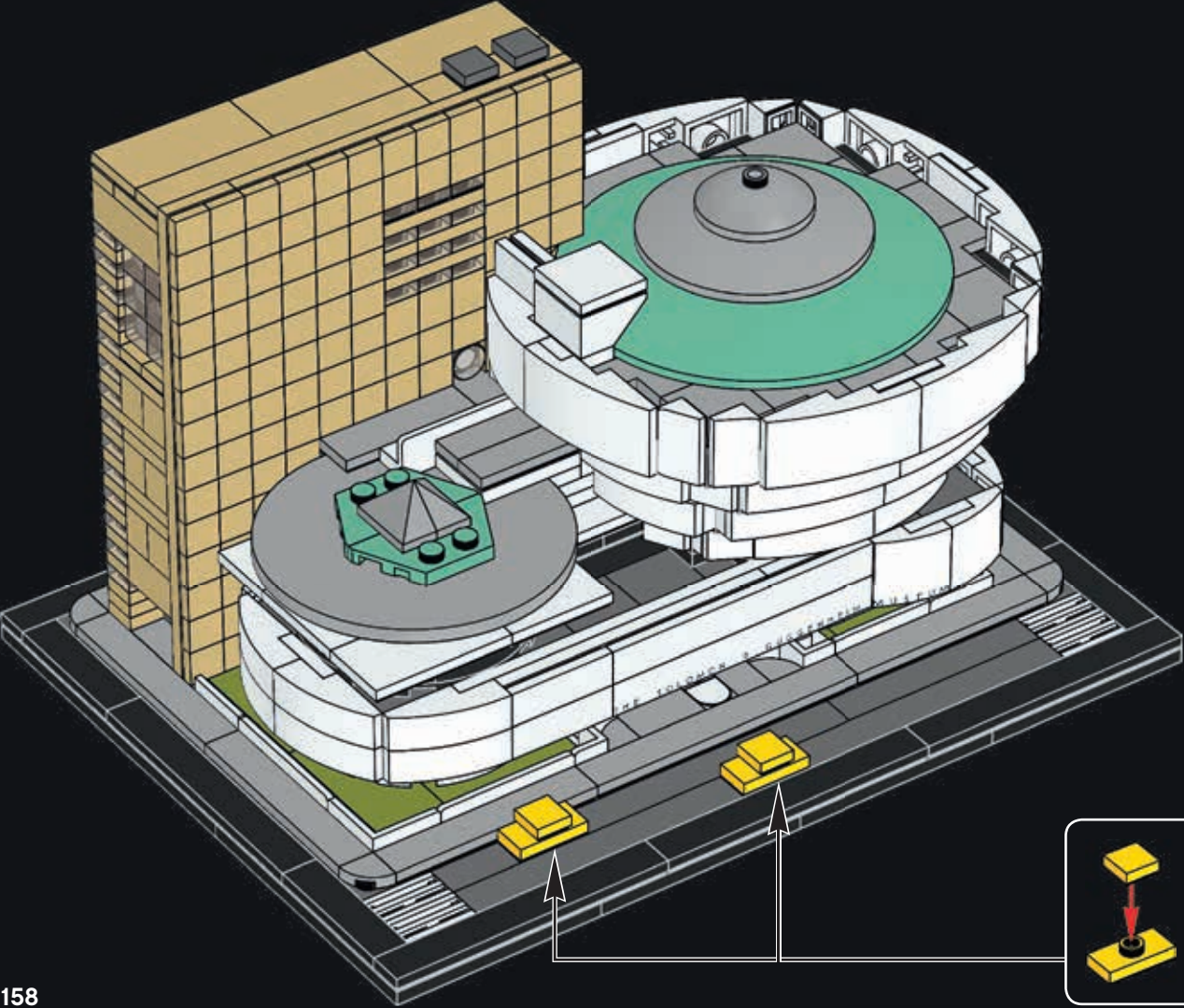

158



THE SOLOMON R. GUGGENHEIM MUSEUM

SPEED LIMIT 30

ONE WAY

ONE WAY

WALKWAY

# LEGO® Architecture – do you like it?

The LEGO Group would like your opinion on the new product you have just purchased. Your feedback will help shape the future development of this product series. Please visit:

[LEGO.com/productsurvey](https://www.lego.com/productsurvey)

By completing our short feedback survey, you will be automatically entered into a drawing to win a LEGO® prize.

See website for official rules and details. Open to all countries where not prohibited.

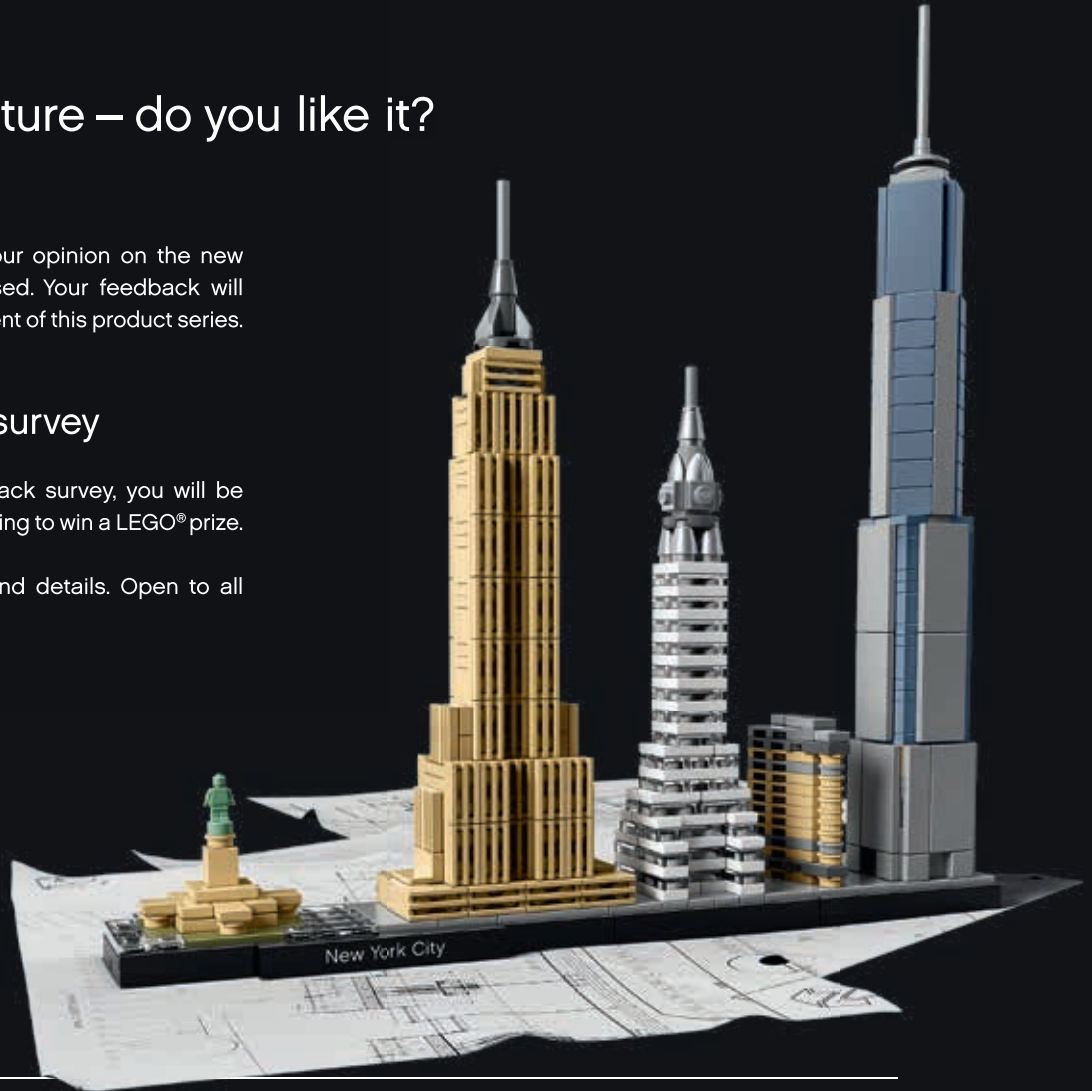

LEGO and the LEGO logo are trademarks of the/son des marques de commerce du/son marcas registradas de LEGO Group. ©2017 The LEGO Group.



## LEGO® Architecture – then and now

There has always been a natural connection between the LEGO® brick and the world of architecture. Fans who build with LEGO elements instinctively develop an interest in the form and function of the structures they create. At the same time, many architects have discovered that LEGO bricks are the perfect way of physically expressing their creative ideas.

This connection was confirmed in the early 1960s with the launch of the LEGO 'Scale Model' line. It matched the spirit of the age where modern architects were redefining how houses look and people were taking an active interest in the design of their new homes. These sets were designed to be different from the normal, brightly colored LEGO boxes; they also included a book on architecture as a source of inspiration.

Decades later, architect and LEGO fan Adam Reed Tucker revived the idea of expressing architecture using LEGO bricks and in partnership with the LEGO Group,

launched the LEGO Architecture line that we know today. His first models, and the original sets in the current LEGO Architecture series, were interpretations of famous skyscrapers from his hometown of Chicago. Since then LEGO Architecture has developed and evolved, first with well-known buildings from other cities in the United States, and now with iconic structures from Europe, the Middle East and Asia.

The introduction of our LEGO Architecture Studio set echoes the ambitions of the earlier LEGO 'Scale Model' line and widens the potential of the LEGO Architecture series. Now you can enjoy building and learning about specific landmark buildings, or create exciting architectural models from your own fantasy. An inspiring 270-page book, featuring a number of renowned architects from around the world, guides you through the principles of architecture and encourages you in your own creative building.



21050  
Studio

# References

Photo credits:

[www.shutterstock.com](http://www.shutterstock.com)

©The Solomon R. Guggenheim Foundation, New York p. 2, 7, 9, 10

For further information please visit:

[www.guggenheim.org](http://www.guggenheim.org)

Customer Service  
Kundenservice  
Service Consommateurs  
Servicio Al Consumidor  
[LEGO.com/service](http://LEGO.com/service) or dial



00800 5346 5555: 

1-800-422-5346: 

# Celebrate the world of architecture

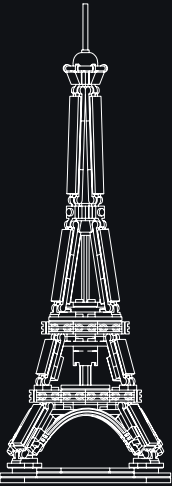

21019  
The Eiffel Tower

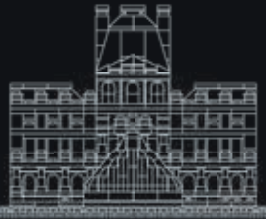

21024  
Louvre

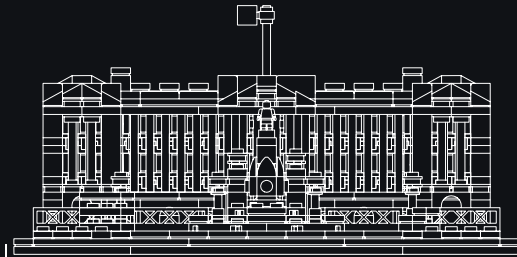

21029  
Buckingham Palace

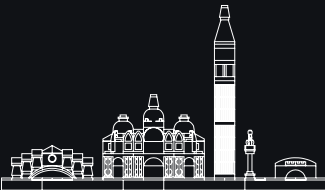

21026  
Venice



21027  
Berlin



21028  
New York City

and collect all the models



21030  
United States Capitol Building

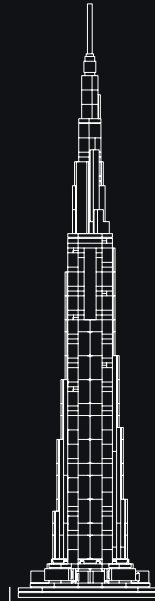

21031  
Burj Khalifa

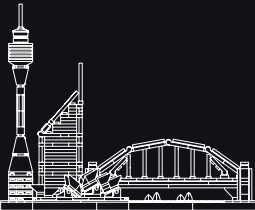

21032  
Sydney



21033  
Chicago

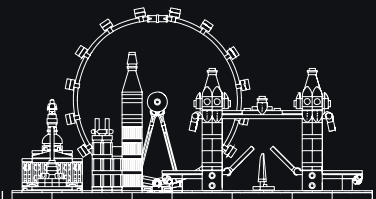

21034  
London

 3x  
6131655

 3x  
4504369

 7x  
4558952

 7x  
307001

 16x  
302401

 5x  
623101

 6x  
4547489

 4x  
241201

 3x  
306901

 16x  
302301

 2x  
6146215

 8x  
300401

 1x  
6034044

 3x  
4121932

 8x  
302201

 4x  
6013866

 4x  
306801

 3x  
6047220

 1x  
366001

 1x  
300301

 2x  
6181753

 7x  
6046979

 1x  
6139694

 7x  
362301

 11x  
4249112

 7x  
4558168

 4x  
362201

 1x  
6182352

 1x  
6132212

 3x  
6156667

 4x  
302101

 2x  
300201

 3x  
243101

 3x  
301001

 11x  
371001

 10x  
6045936

 4x  
6061047

 4x  
302001

 2x  
4560178

 6x  
6031947

 2x  
608101

 1x  
300101

 2x  
366601

 1x  
617901

 1x  
4215470

 3x  
6109817

 2x  
379501

 1x  
416201

 1x  
6182355

 2x  
303401

 3x  
244501

 1x  
4119227

 2x  
4118793

 19x  
4159553

 13x  
4113915

 103x  
4125253

 1x  
6029889

 5x  
6092587

 7x  
6024495

 4x  
4113917

 1x  
6061575

 9x  
4121921

 6x  
4162465

 8x  
4118790

 1x  
4159739

 4x  
4201062

 2x  
4113916

 1x  
4543858

 4x  
4114309

 3x  
6122047

 5x  
4114319

 3x  
4124067

 5x  
4112982

 3x  
4113993

 1x  
4544139

 6x  
4159774

 1x  
4114001

 1x  
4113988

 2x  
4249019



1x  
6036487



3x  
307024



4x  
403224



4x  
6092583



12x  
302324



1x  
4140587



4x  
302224



1x  
4243817



23x  
407026



12x  
302326



4x  
6092585



6x  
300426



7x  
6138173



2x  
300326



12x  
362326



4x  
6187587



4x  
6187572



7x  
4599499



4x  
243126



12x  
4162443



3x  
301026



1x  
4159550



1x  
379526



8x  
416226



4x  
303626



4x  
303626



4x  
303326



4x  
4565323



1x  
4654448



3x  
6079000



15x  
6038458



23x  
6030982



2x  
6187591



1x  
6187588



1x  
4211525



6x  
6176433



2x  
6075075



8x  
4211414



1x  
6123809



4x  
4211413



8x  
6065824



1x  
6070564



8x  
4211429



4x  
4558169



3x  
4560183



8x  
4211549



1x  
4160560



1x  
4211796



1x  
6102575



3x  
4211008



4x  
4210998



1x  
4211481



1x  
4625582



1x  
4211462



2x  
4210848



7x  
4210978



4x  
4211052



6x  
4211055



8x  
4211043



4x  
4211056



1x  
4210651



3x  
4211008



4x  
4210998



2x  
6133611



1x  
6047015

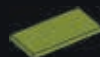

6x  
6016488



1x  
6016484

