



NINJAGO

LEGACY



71734





Check for compatibility
Kompatibilität prüfen
Vérifier la compatibilité
Controlla la compatibilità
Comprueba tu compatibilidad
Verificar a compatibilidade
Ellenőrizd a kompatibilitást
Pārbaudīt saderību
检查兼容性

乐高® 拼搭指引



LEGO® Building Instructions



Download on the
App Store



GET IT ON
Google Play



腾讯应用宝
安卓应用商店

Apple and the Apple logo are trademarks of Apple Inc.
Google Play and the Google Play logo are trademarks of Google LLC.
Tencent and the Tencent logo are trademarks of Tencent Inc.





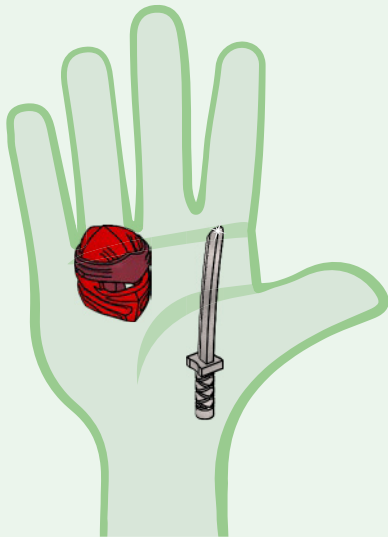
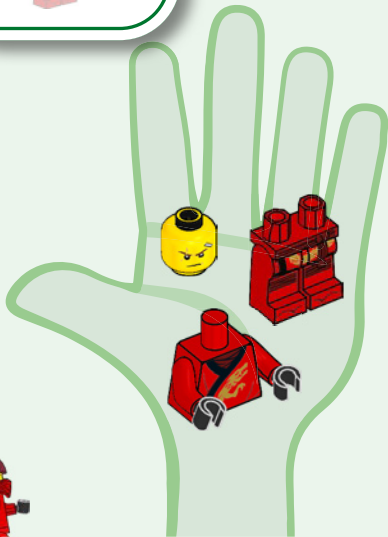

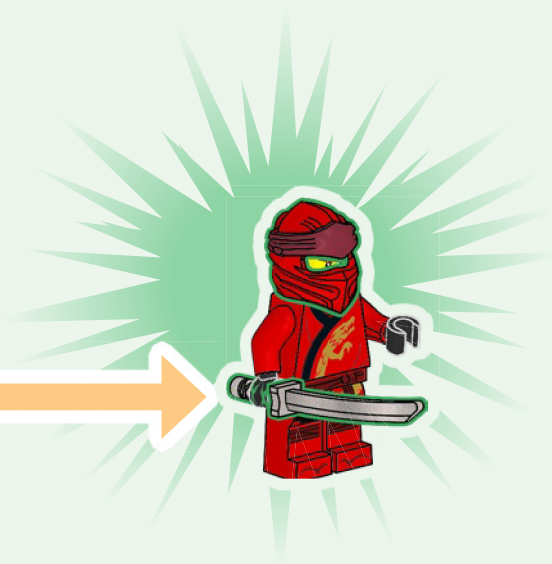
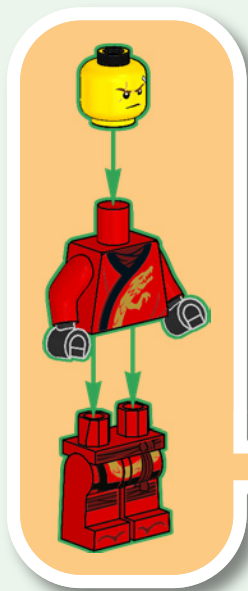

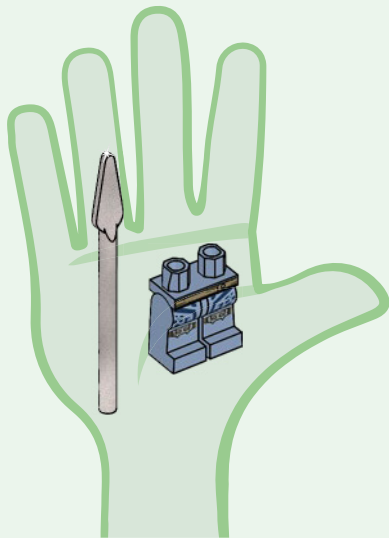
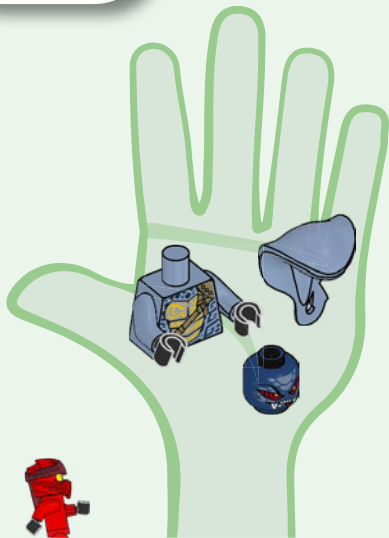

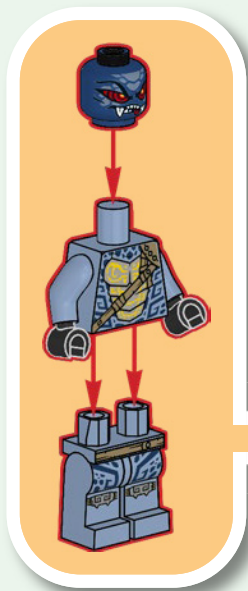

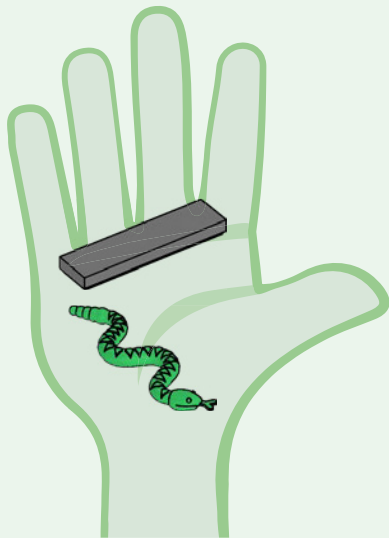
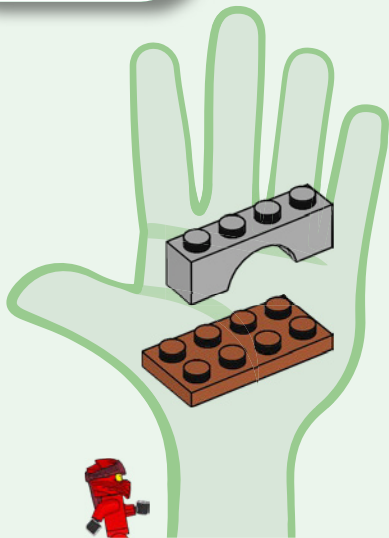
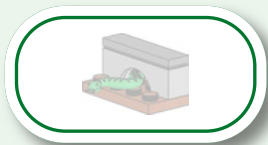

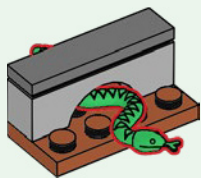
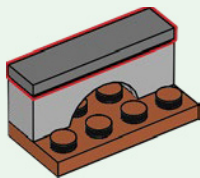
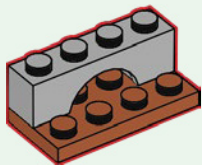

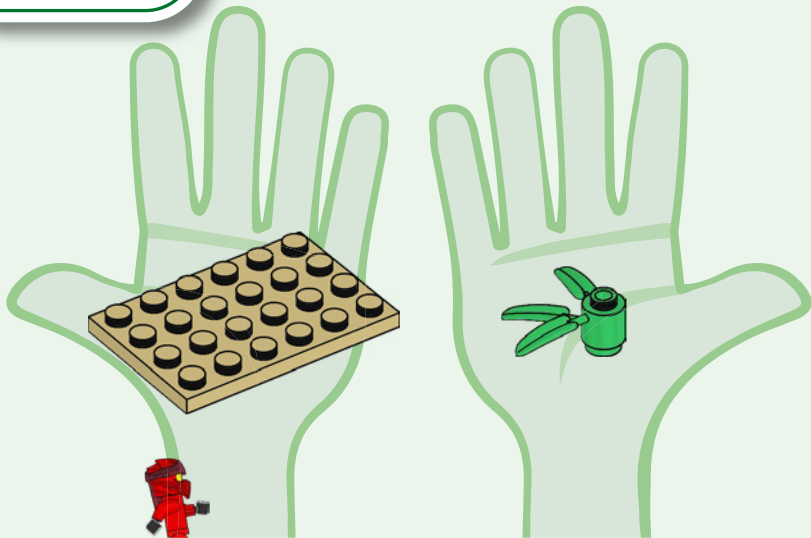
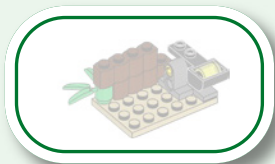

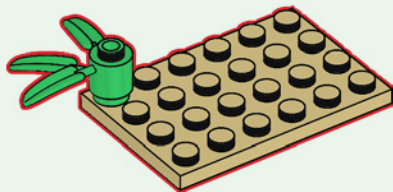

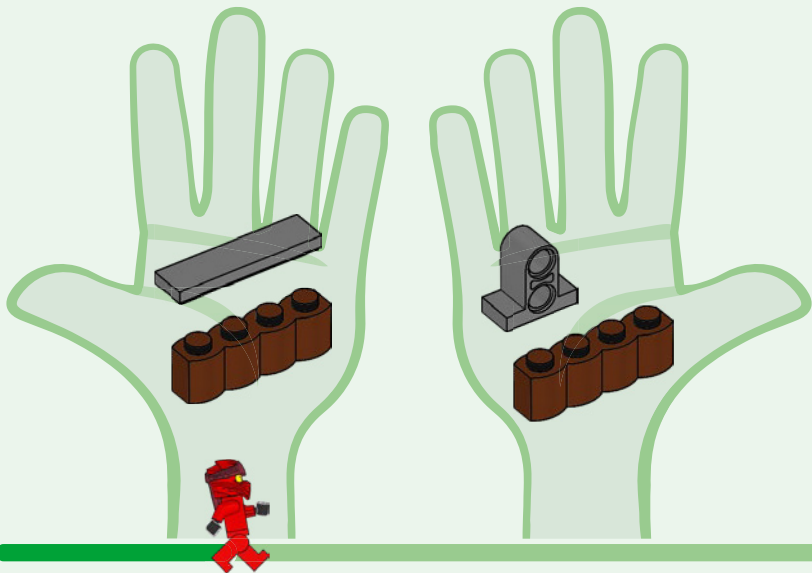

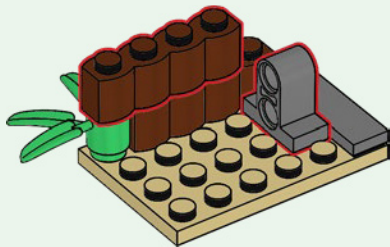
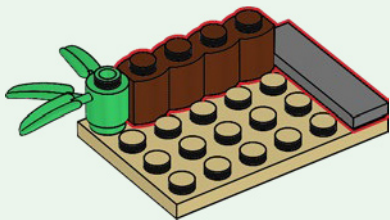

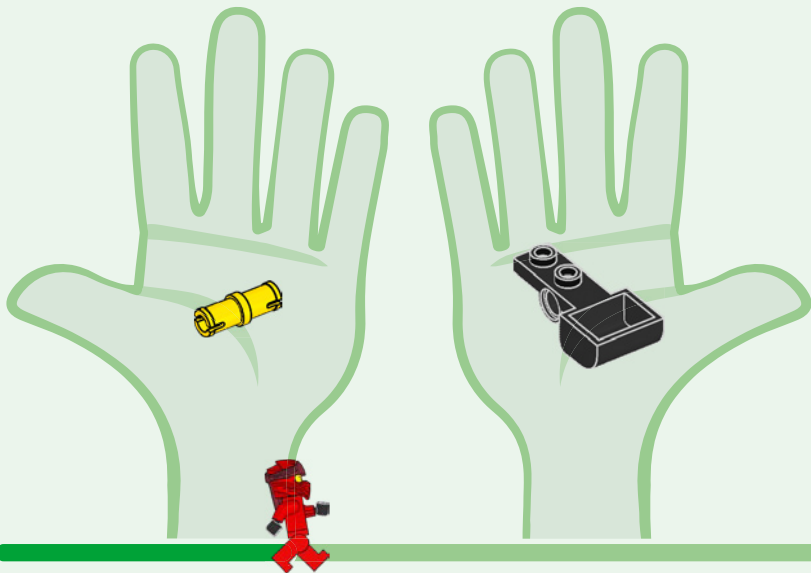

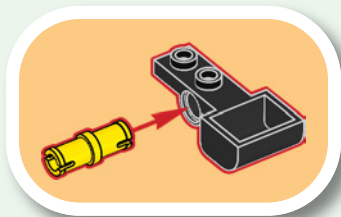
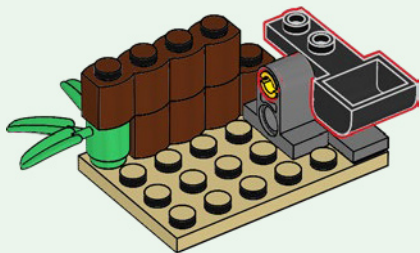

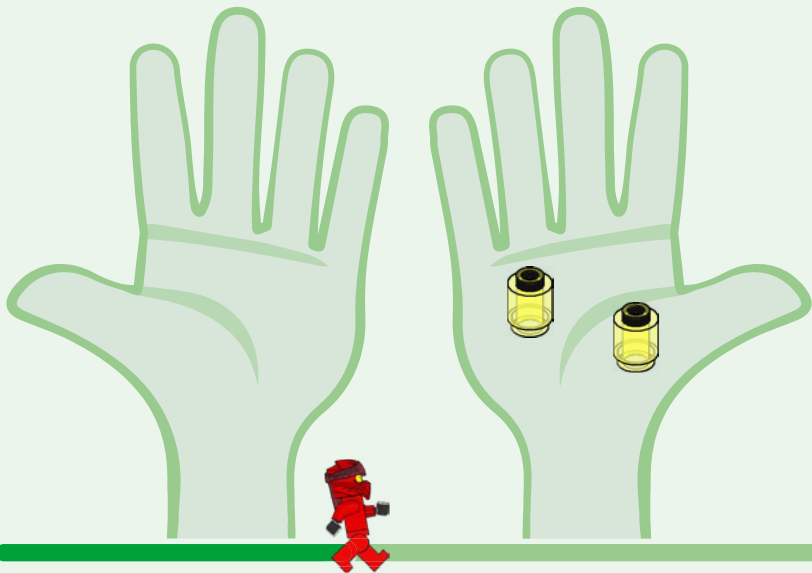

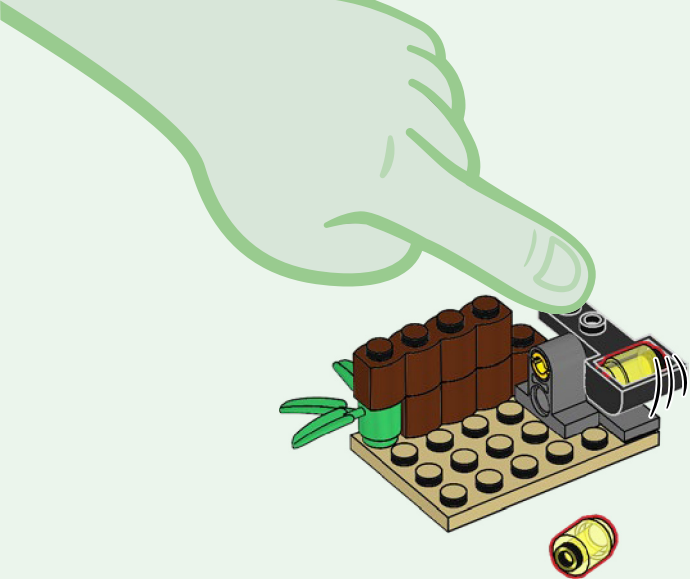

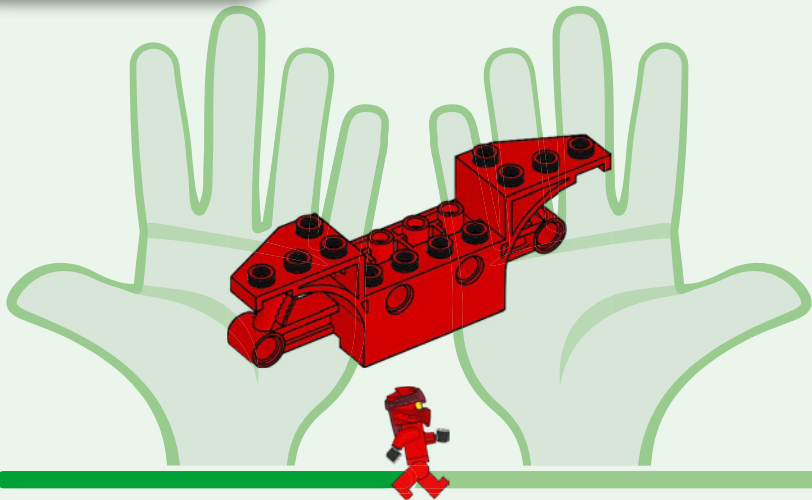

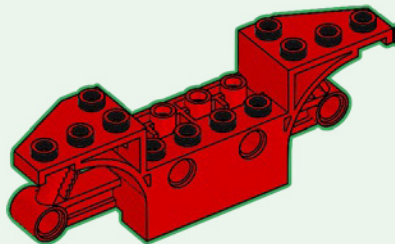

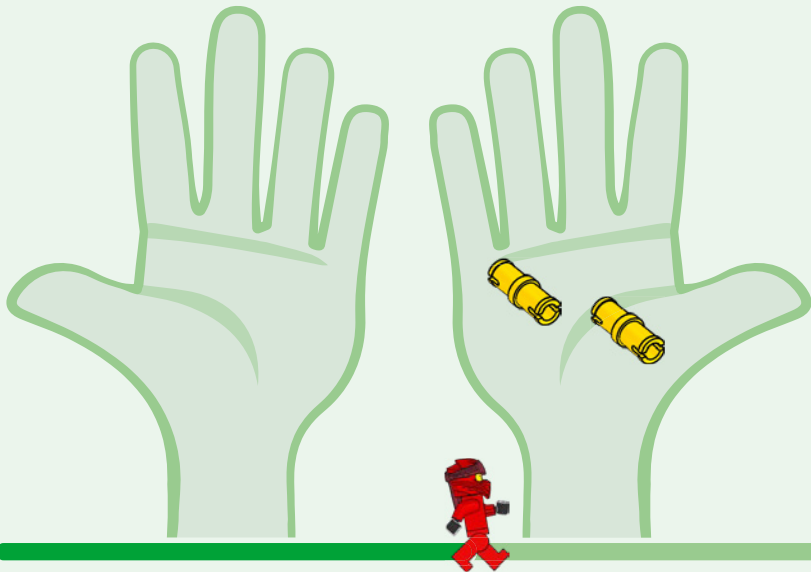

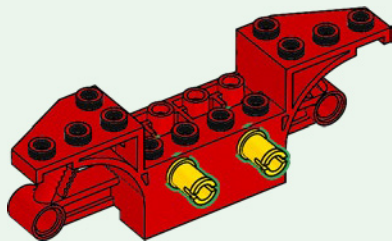

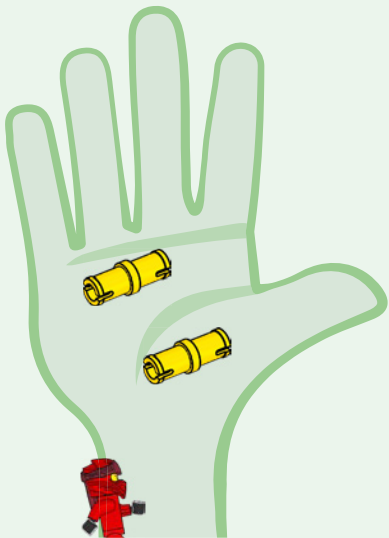

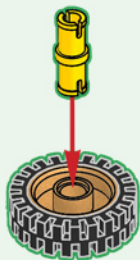

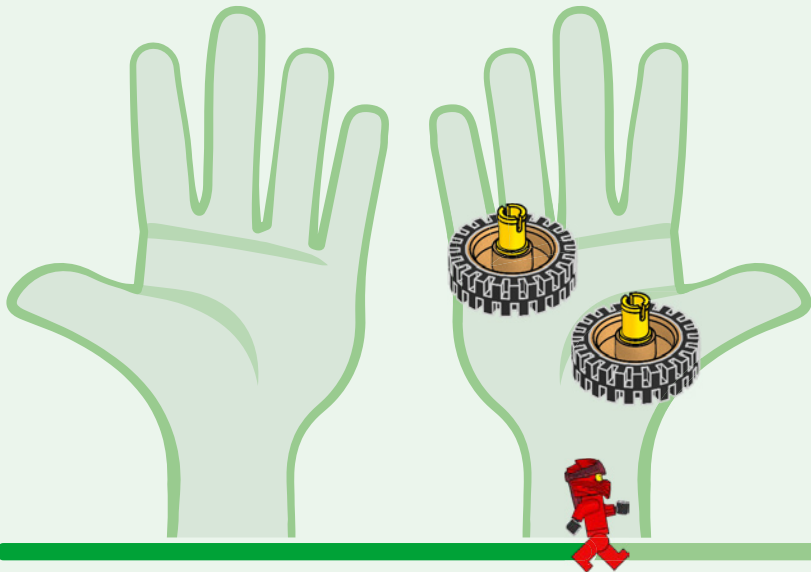

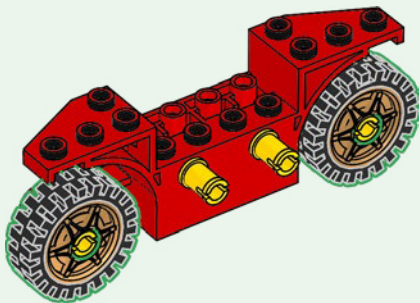

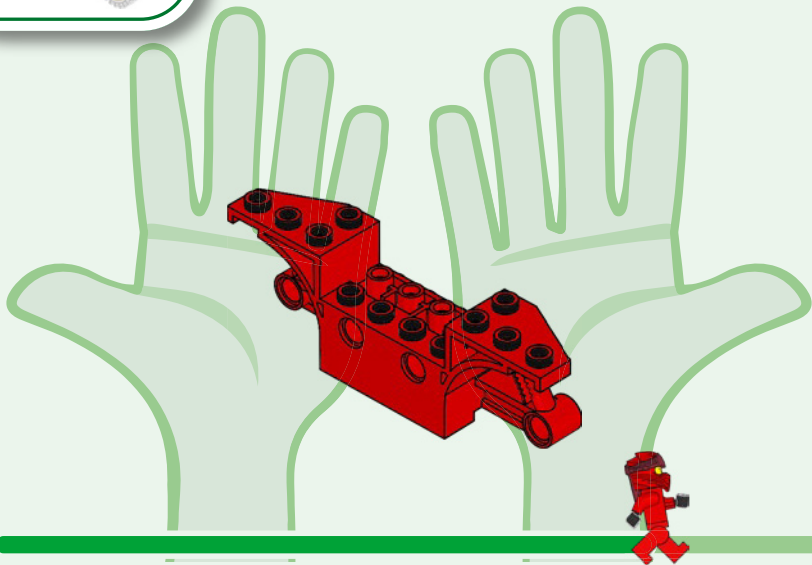
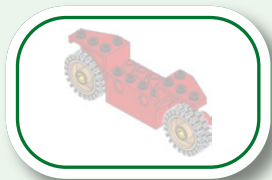

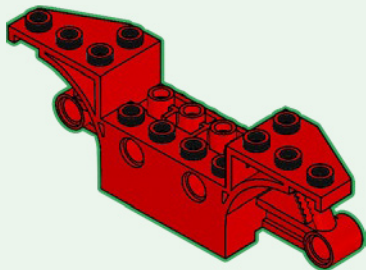

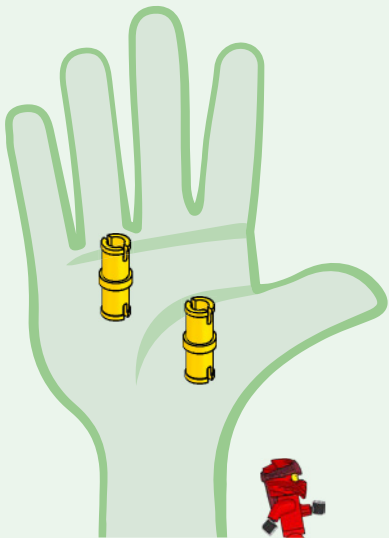

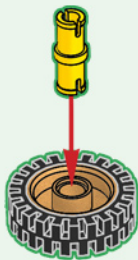

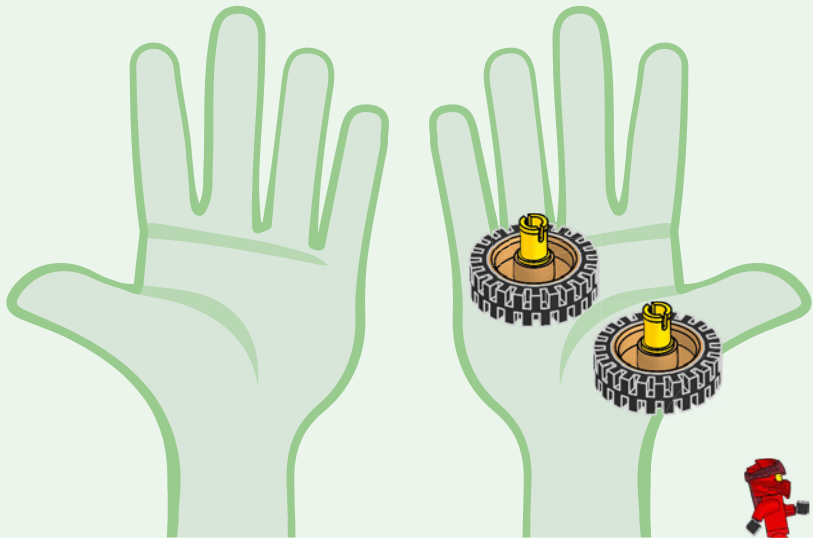

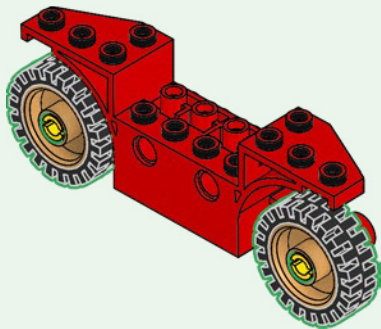

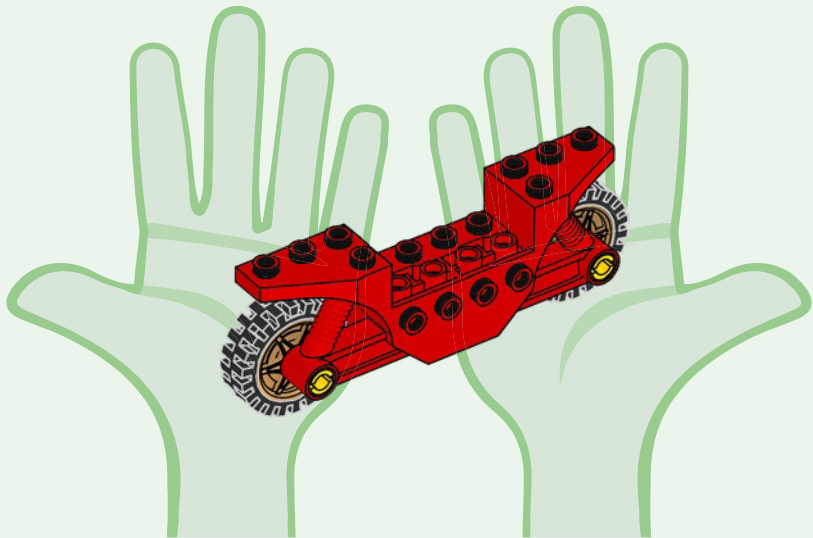

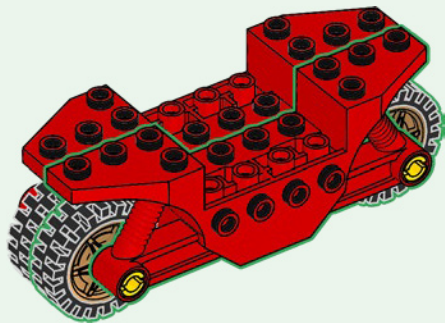

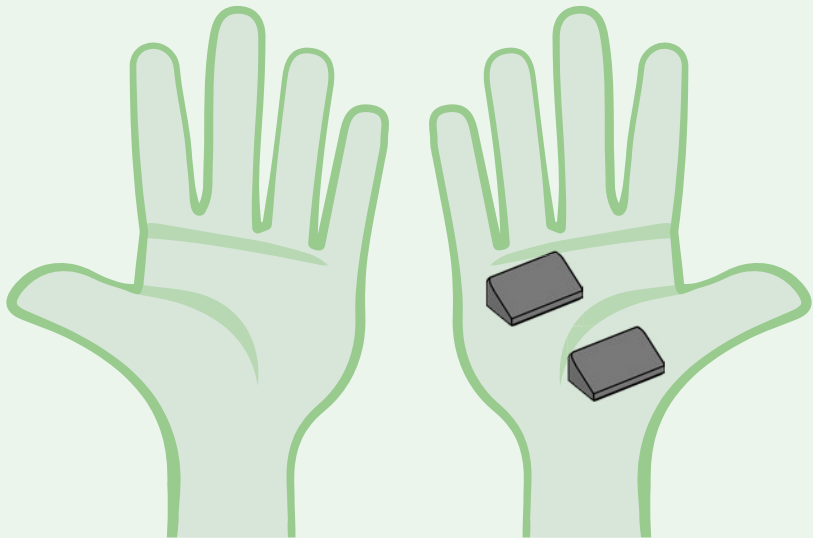

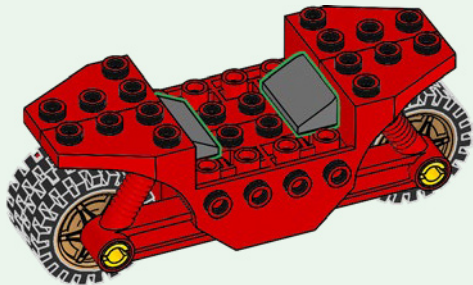

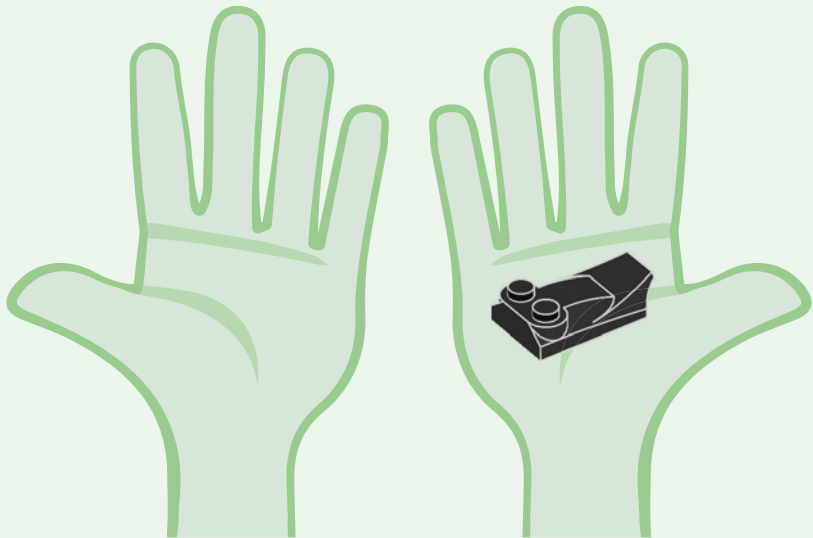

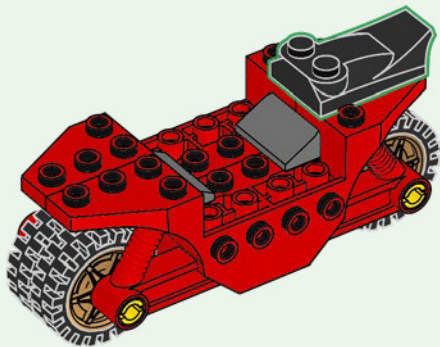

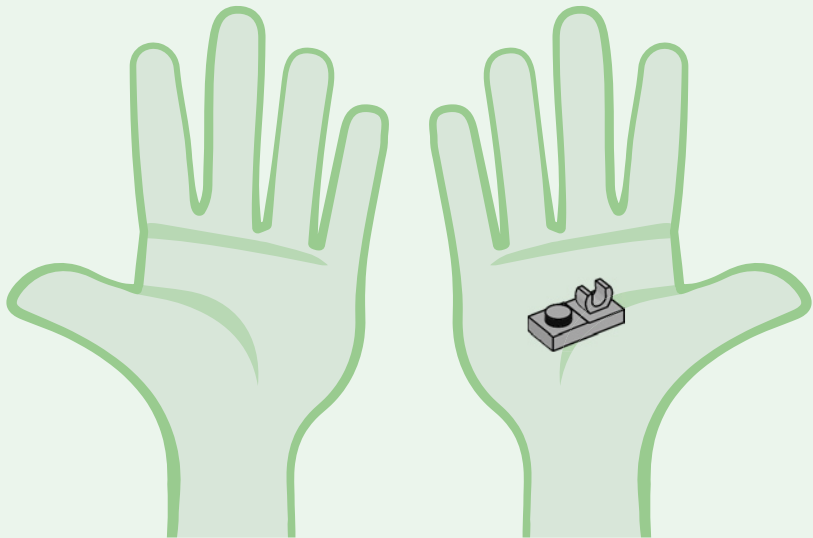

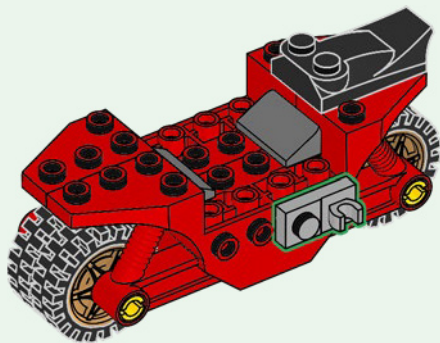

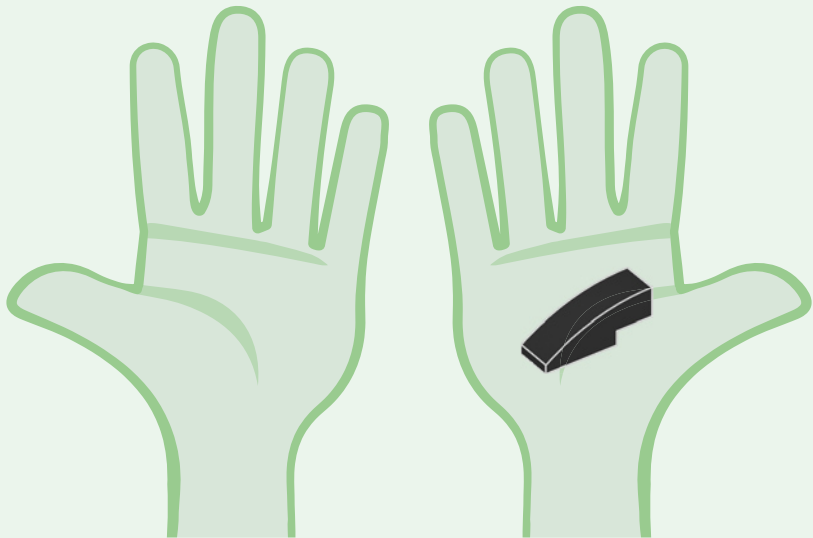

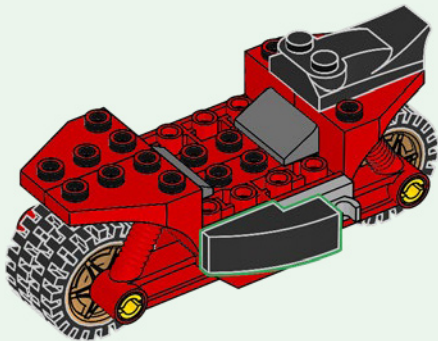



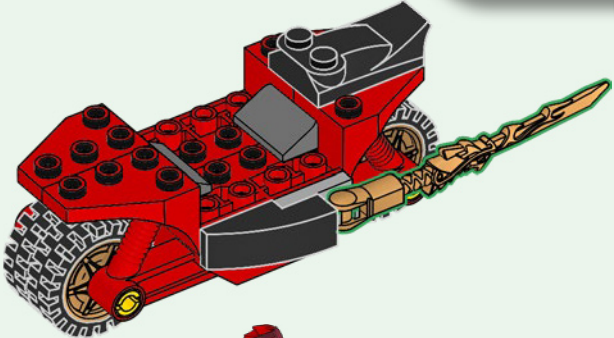
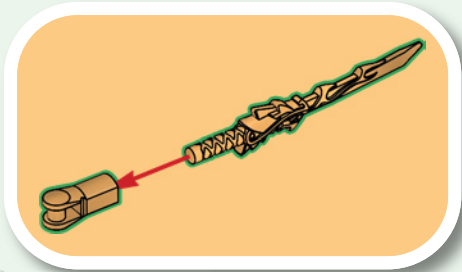

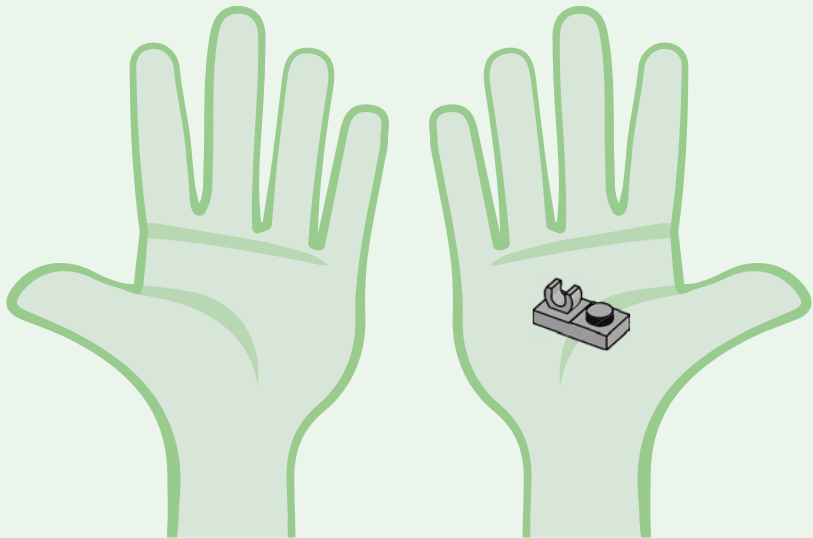

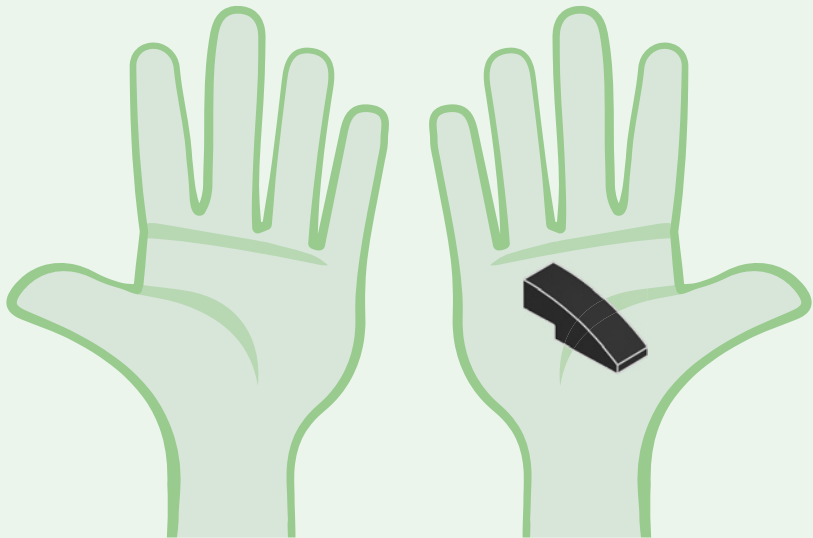

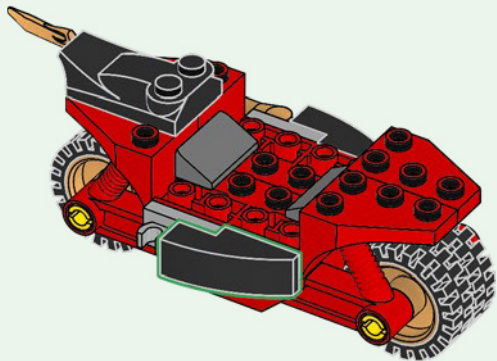



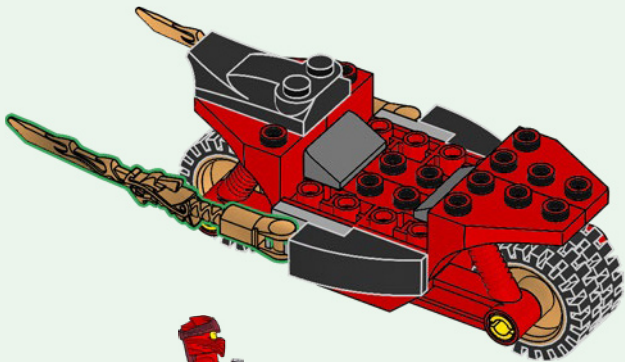
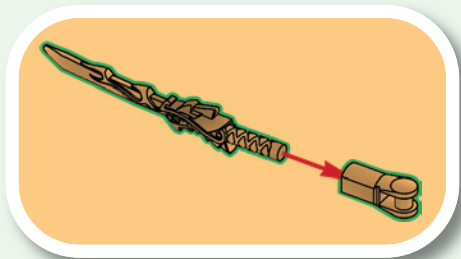



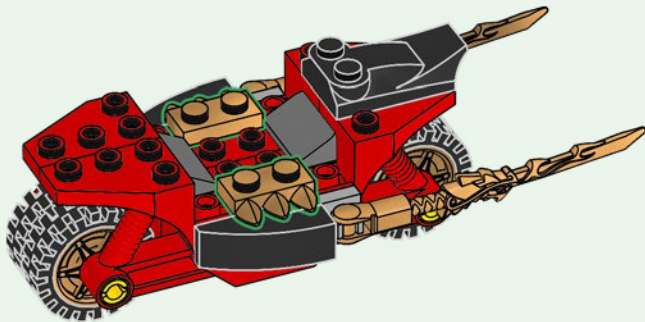

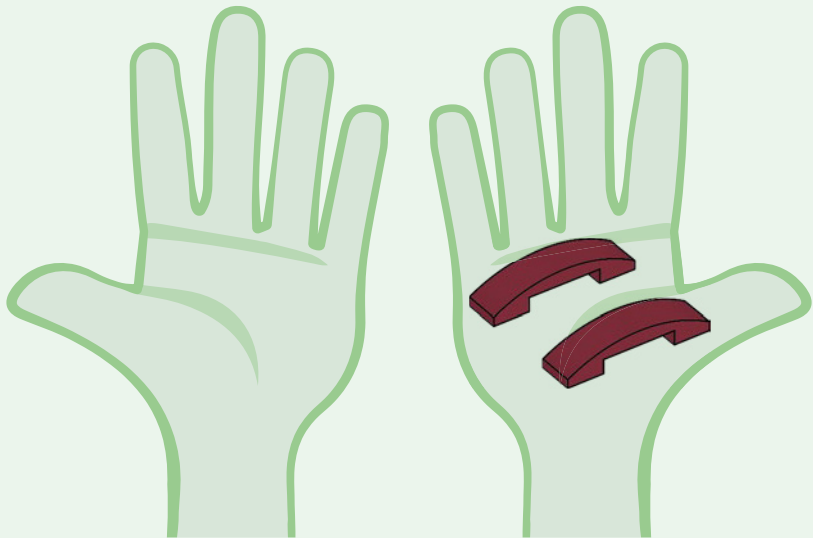

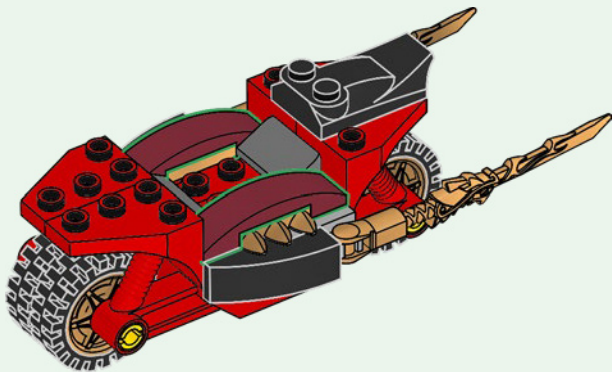

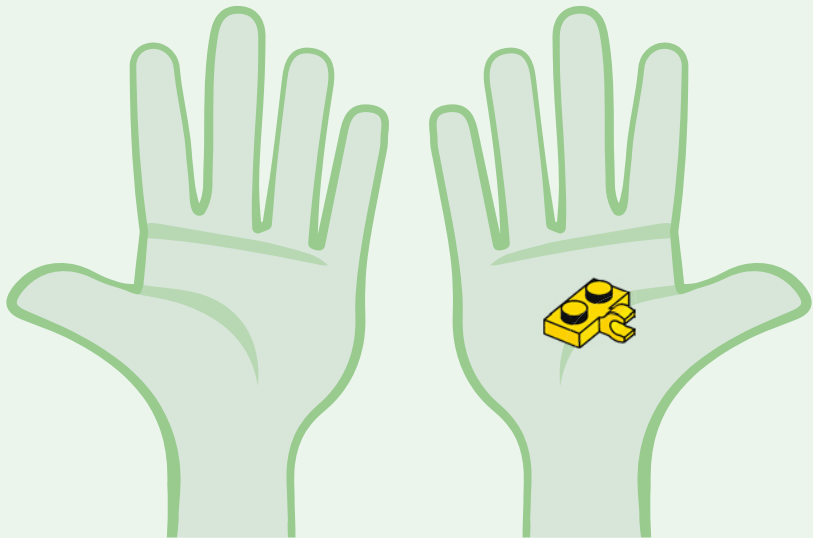

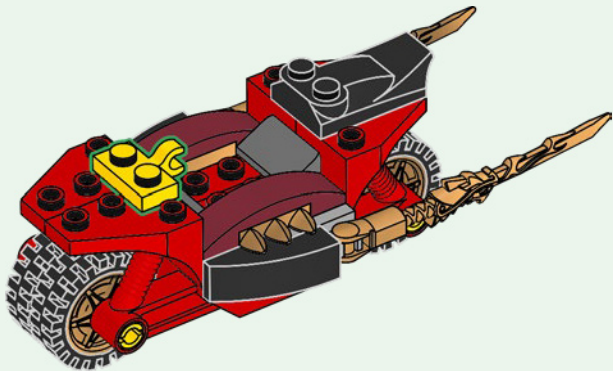



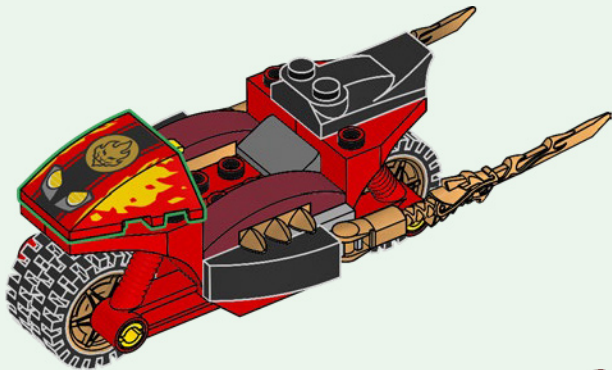



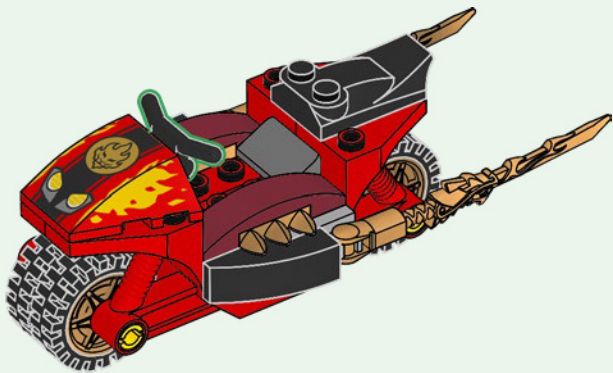

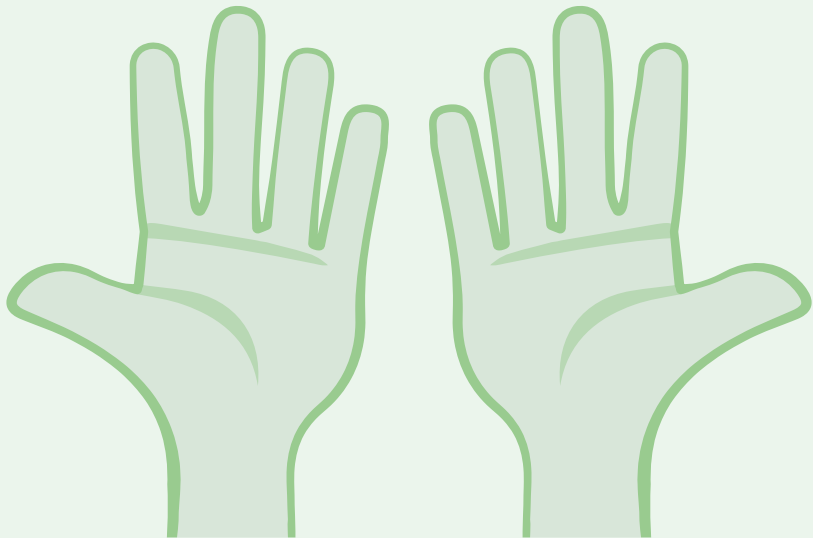





NINJAGO

LEGACY



71735



71736



71739



71737



71738



71753



71750



71754



71752



71755



71756



1x
6250874



1x
6251154



1x
6341730



1x
6190411



7x
6331822



1x
6313121



2x
4251161



1x
6251152



1x
3003126



1x
4285883



1x
6225386



1x
6270003



1x
6286433



1x
4535928



2x
6238675



1x
6335725



1x
6335715



1x
6329666



2x
6000752



2x
6326078



1x
4211435



1x
6329684



2x
4211181



2x
6296657



2x
6207764



4x
6344199



2x
6096099



1x
4210763



2x
4211053



1x
6116593



2x
4567887



1x
4611883

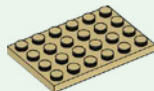

1x
4114001

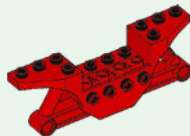

2x
6320082



Customer Service
Kundenservice
Service Consommateurs
Servicio Al Consumidor

LEGO.com/service or dial



: 00800 5346 5555

: 1-800-422-5346

WIN

GO TO WWW.LEGO.COM/PRODUCTFEEDBACK AND
GIVE US YOUR SHORT **FEEDBACK** ABOUT THIS
LEGO® SET FOR A CHANCE TO WIN
A COOL LEGO PRIZE.

Terms & Conditions apply



LEGO.com/productfeedback

GEWINNE

Erzähle uns auf
www.LEGO.com/productfeedback

etwas über die Erfahrungen, die du
mit diesem LEGO® Set gemacht hast,
und sichere dir die Chance auf einen
coolen LEGO Preis!

Es gelten die Teilnahmebedingungen

GAGNE

Rends-toi sur
www.LEGO.com/productfeedback

et donne-nous quelques commen-
taires sur ce produit LEGO® pour
avoir une chance de gagner un
prix LEGO !

Voir Conditions Générales

GANAN

Visita
www.LEGO.com/productfeedback

y envíanos tu opinión acerca de este
set LEGO®. ¡Participarás en el sorteo
de un premio LEGO!

Términos y Condiciones aplicables

获取奖品

登录
www.LEGO.com/productfeedback

给出关于此乐高®套装的简短反
馈，就有机会获得炫酷乐高奖品

《条款及条件》适用

LEGO, the LEGO logo and NINJAGO are trademarks of the LEGO Group. ©2021 The LEGO Group.

6371934