



MINECRAFT

21242





LEGO.com/sustainable-packaging



BUILDER



Apple and the Apple logo are trademarks of Apple Inc., registered in the U.S. and other countries and regions. App Store is a service mark of Apple Inc. Google Play and the Google Play logo are trademarks of Google LLC. Tencent and the Tencent logo are trademarks of Tencent Inc.

LEGO.com/devicecheck

EN Ask parents' permission before going online | DE Eltern um Erlaubnis bitten, bevor du online gehst | FR Demande l'autorisation d'un parent avant d'aller en ligne | IT Chiedi il permesso ai tuoi genitori prima di andare online | ES Pídeles permiso a tus papás antes de conectarte a Internet | PT pede autorização aos pais antes de acederes online | JA オンラインになる前に ほかの方のきよかをもらおう | ZH 上网前应先征得父母的同意 | KO 온라인 접속 전에 보호자 동의가 필요합니다 | RU Спроси разрешения у родителей, прежде чем заходить в интернет | PL Poproś rodziców o zgodę, zanim wejdiesz do Internetu | CS Než půjdeš na internet, požádej rodiče o svolení | SK Než pôjdeš na internet, vypýtaj si povolenie od rodičov | HU Kérj szülői engedélyt, mielőtt online csatlakoznál! | RO Cere permisiunea părinților înainte de a te conecta online | BG Поискайте разрешение от родител, преди да влезете онлайн | LV Pirms došanās tiešsaistē palūdz atļauju vecākiem | ET Enne Interneti kasutamist küsi vanematelt luba | LT Prieš prisijungdami prie interneto, atsiklauskite tėvų

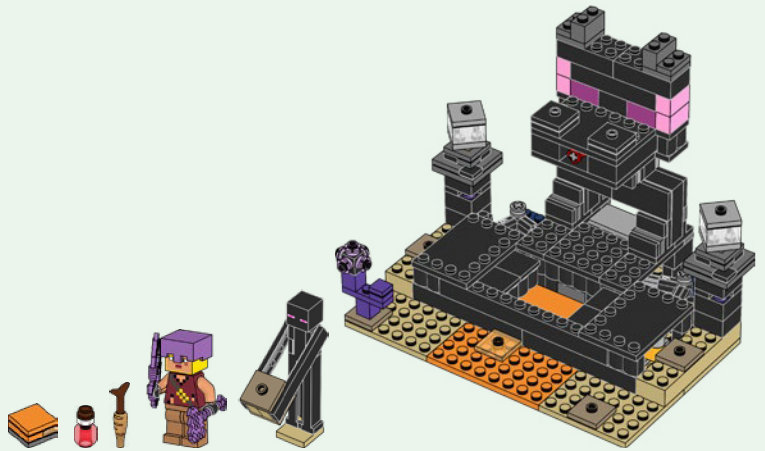
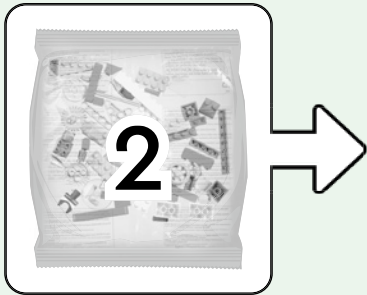
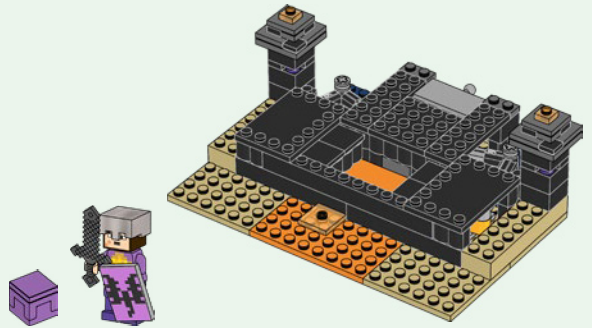
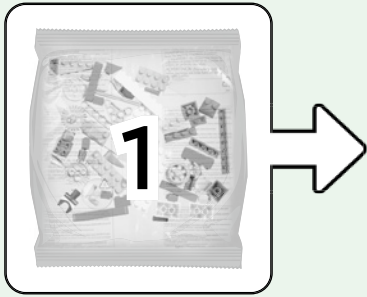

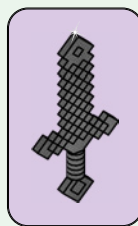
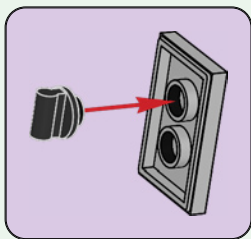
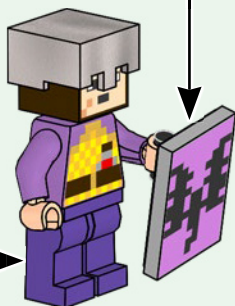
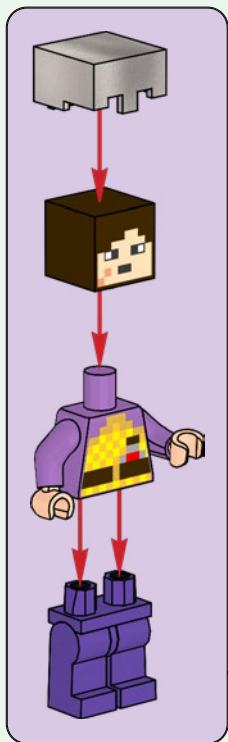

1

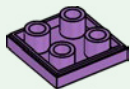

2

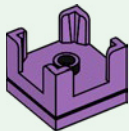

3

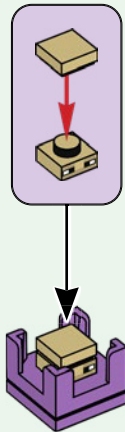

4

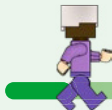
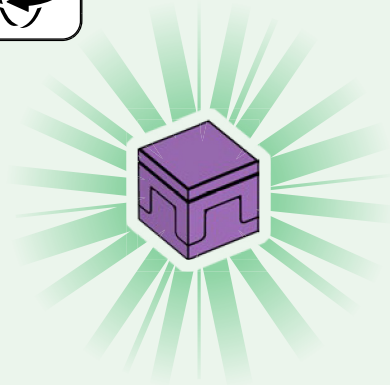
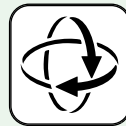
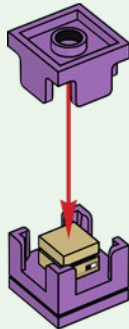

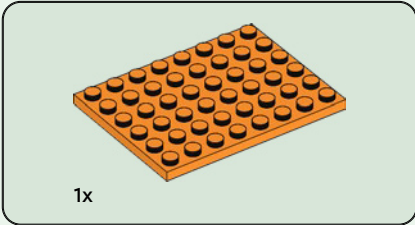
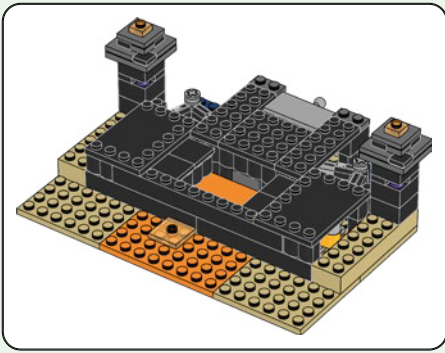

1

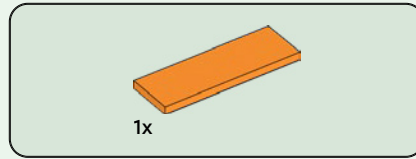
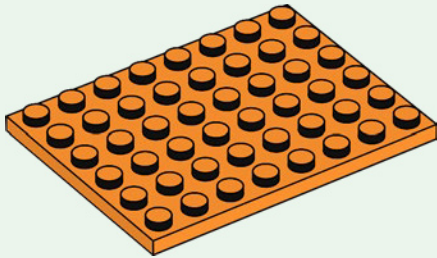

2

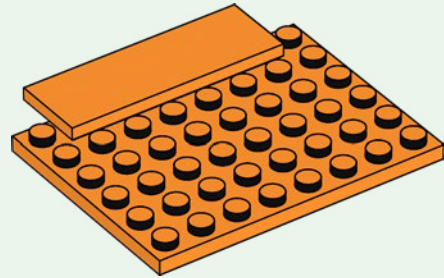

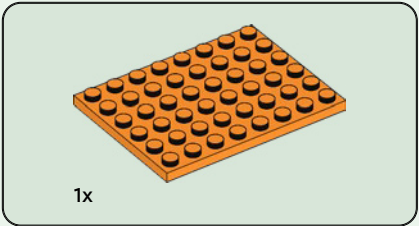

3

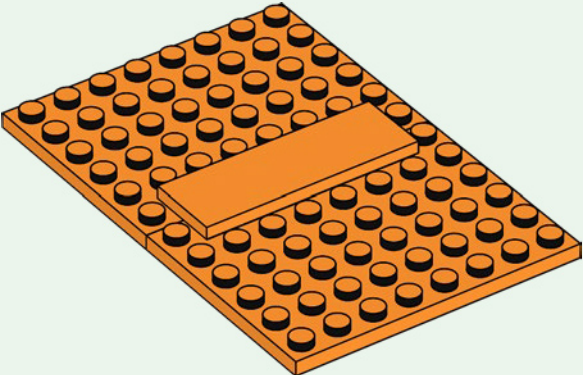

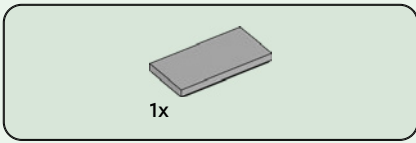

4

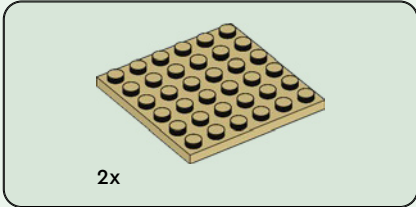
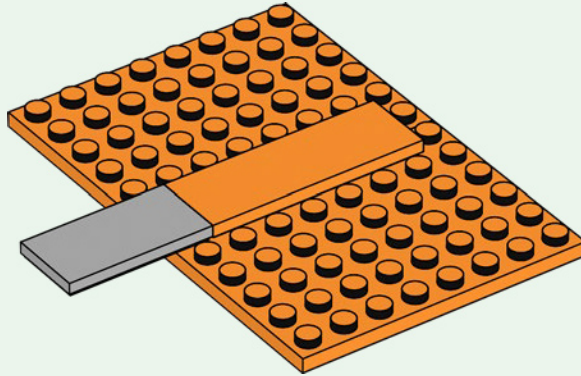

5

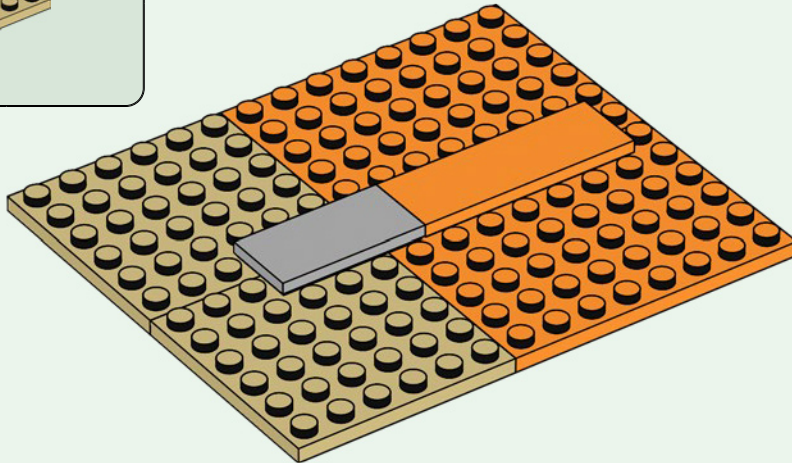

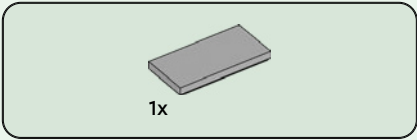

6

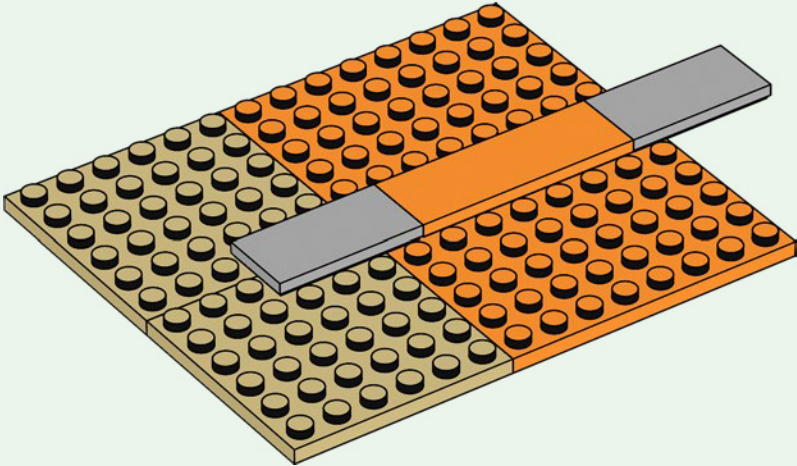

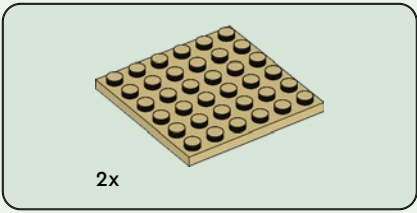

7

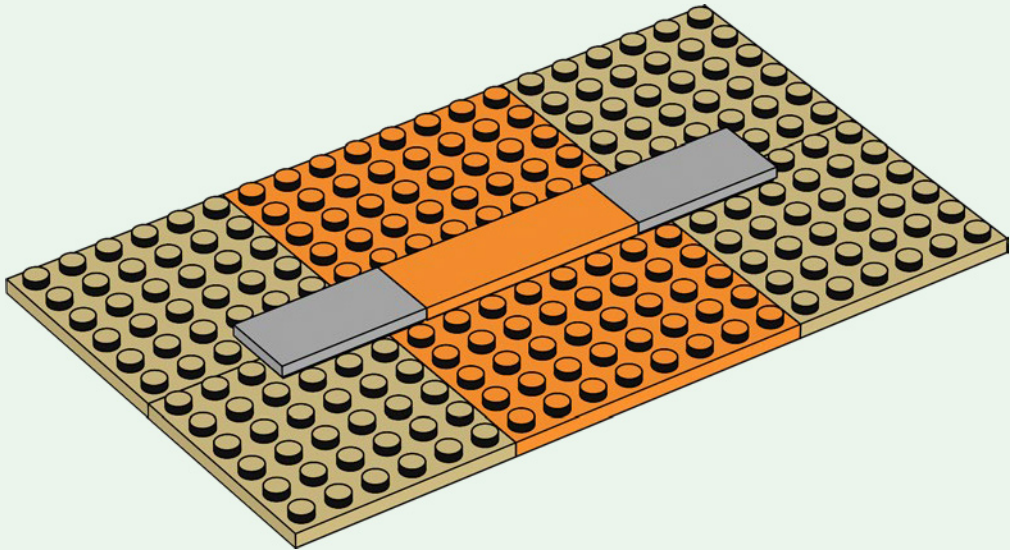

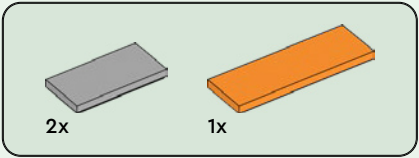

8

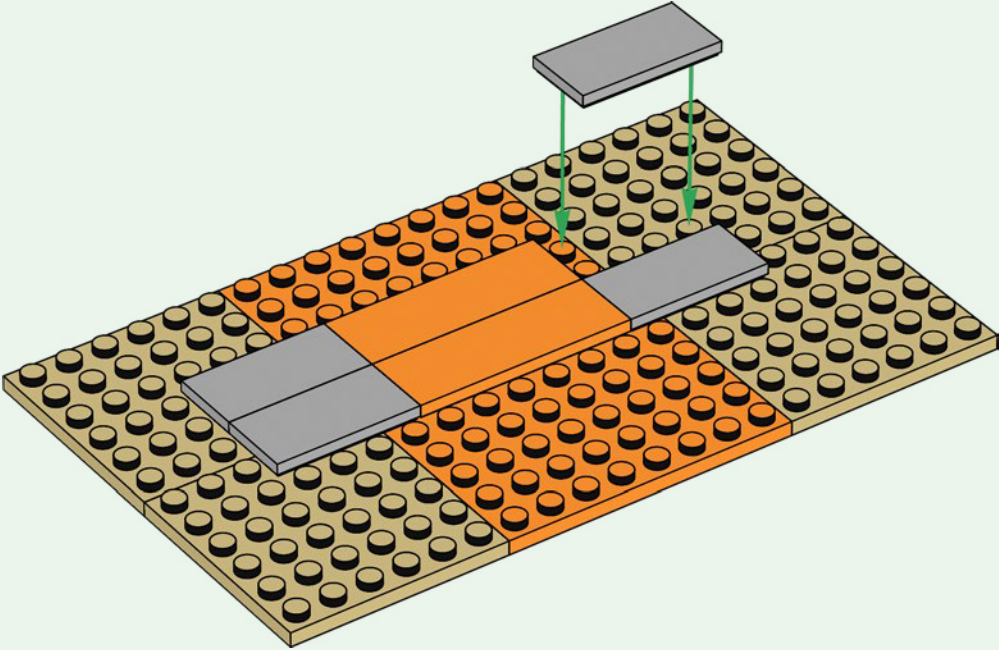

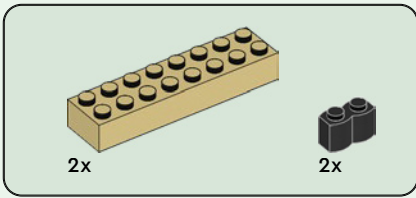

9

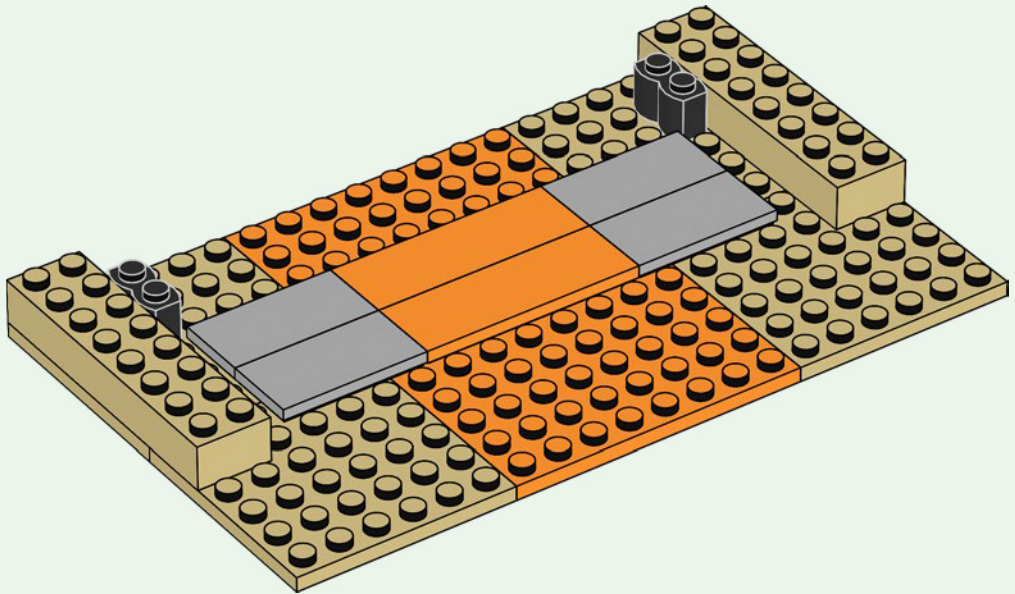

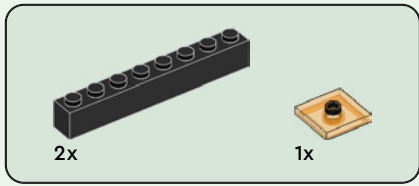

10

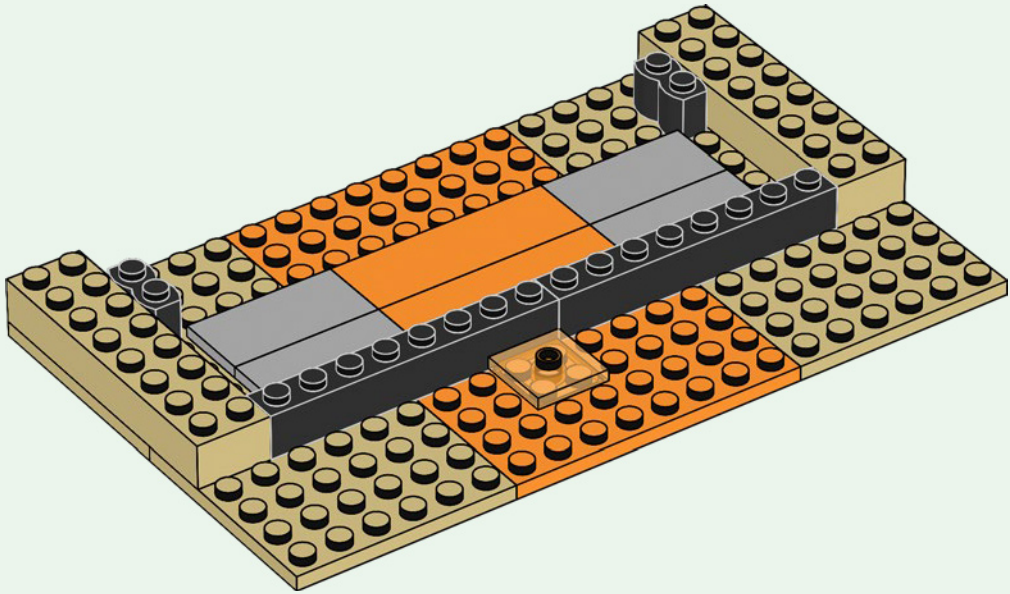

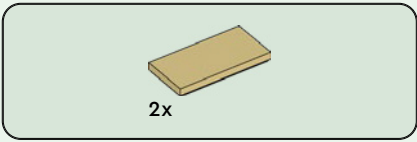

11

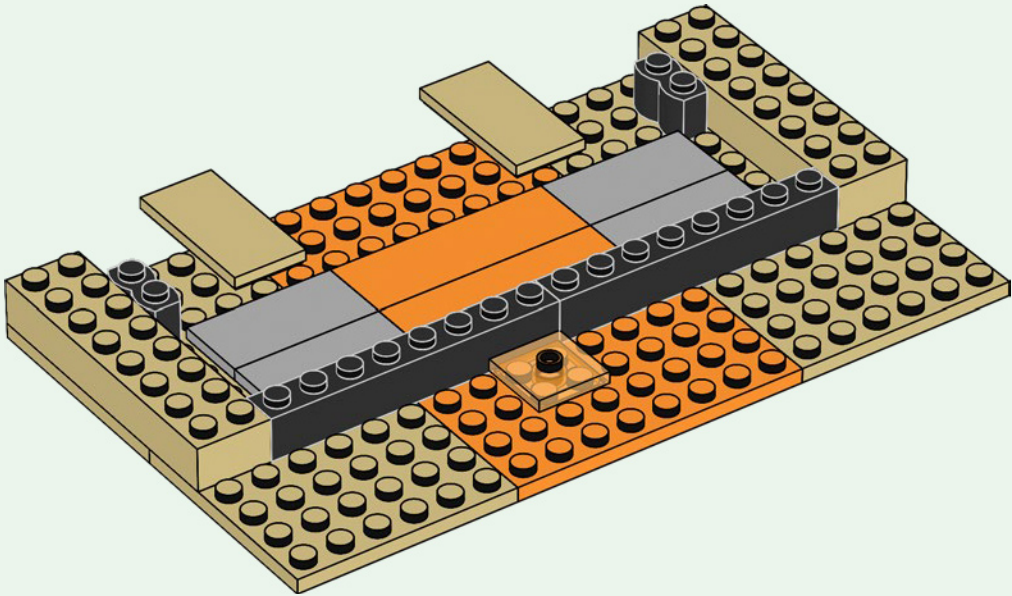

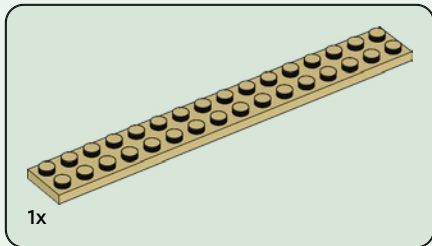

12

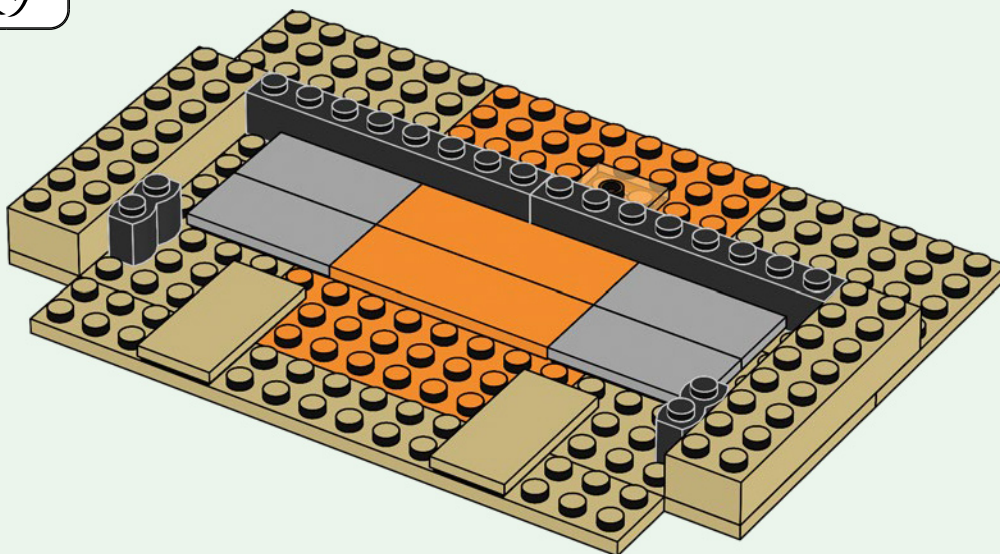

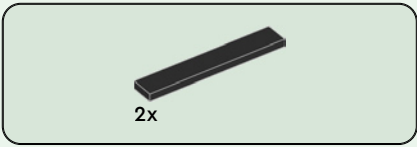

13

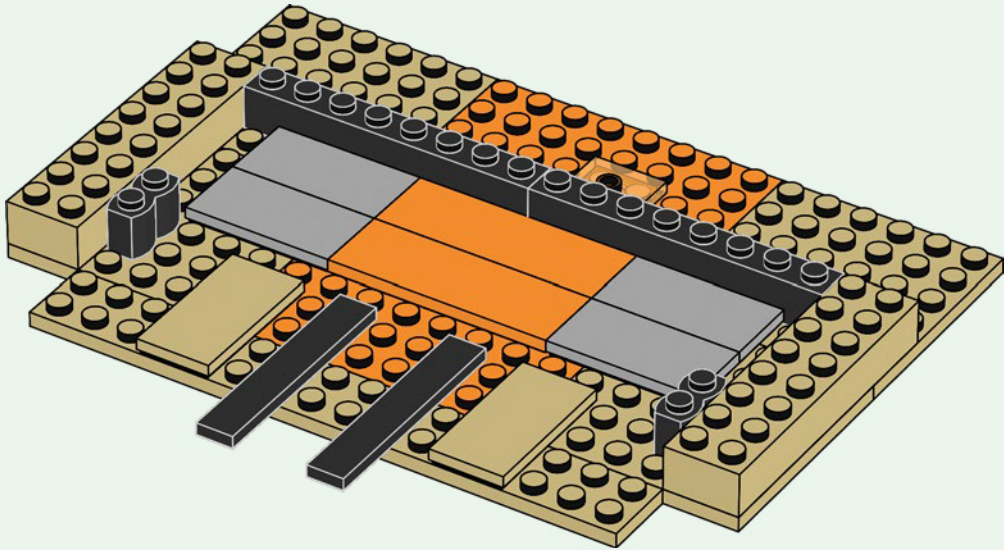

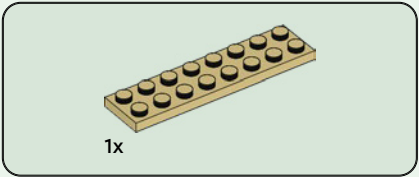

14

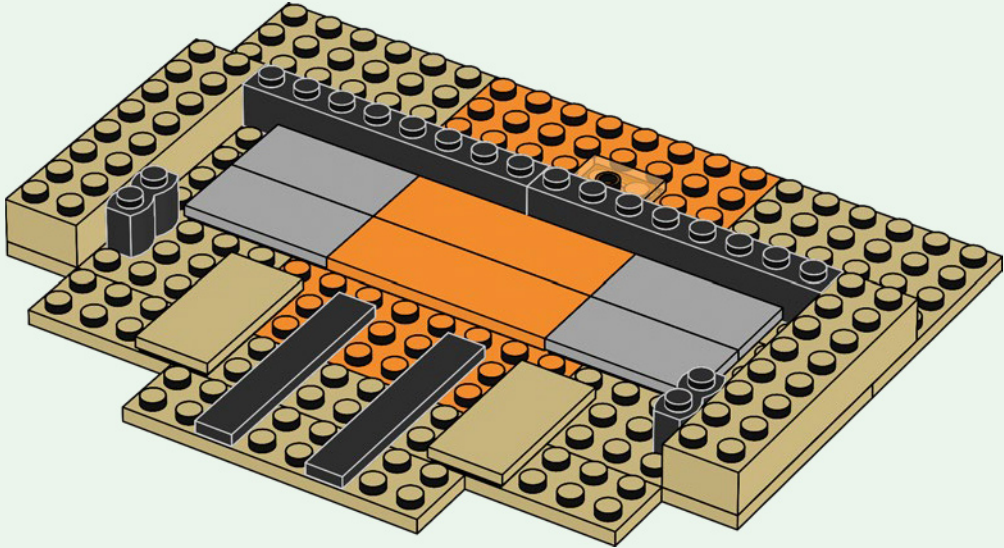



2x

15

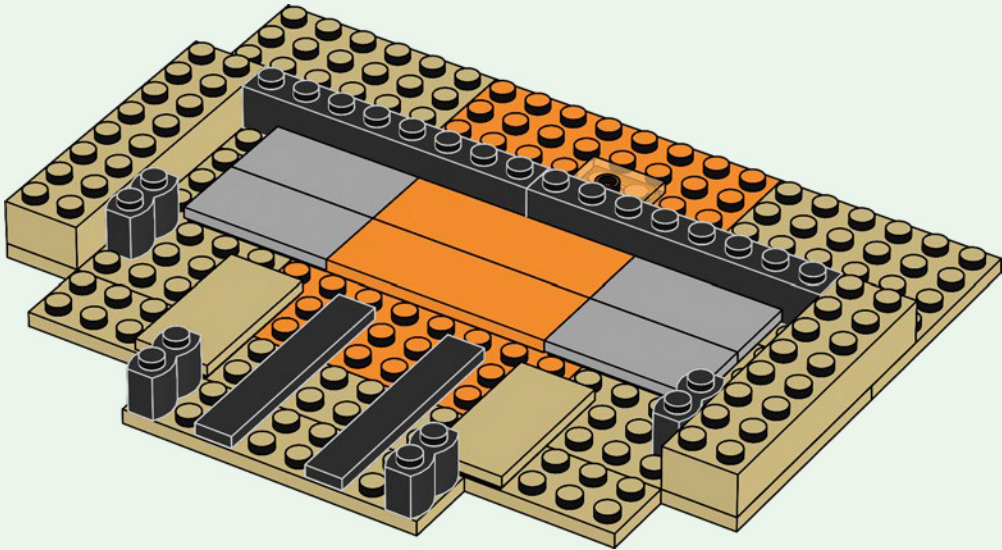



2x

16

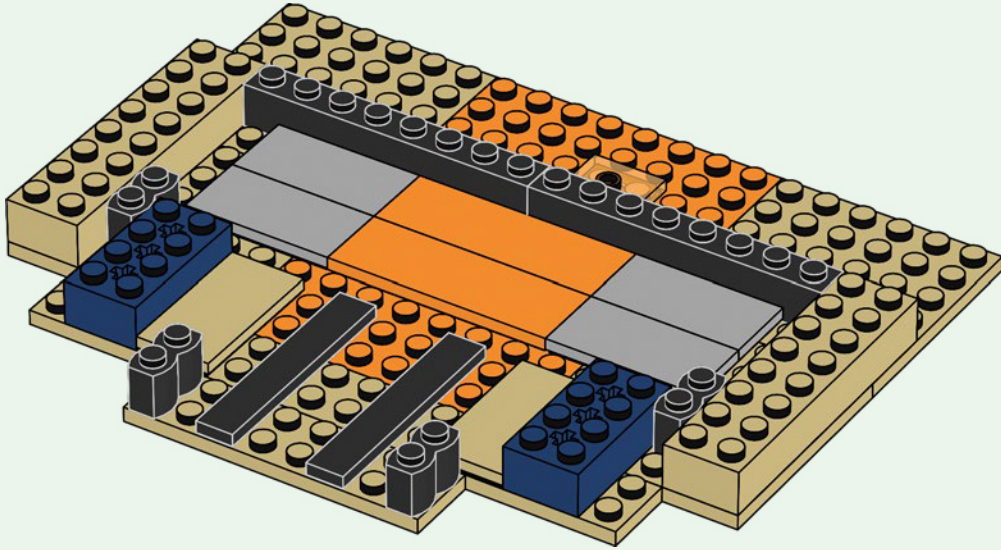



1x

17

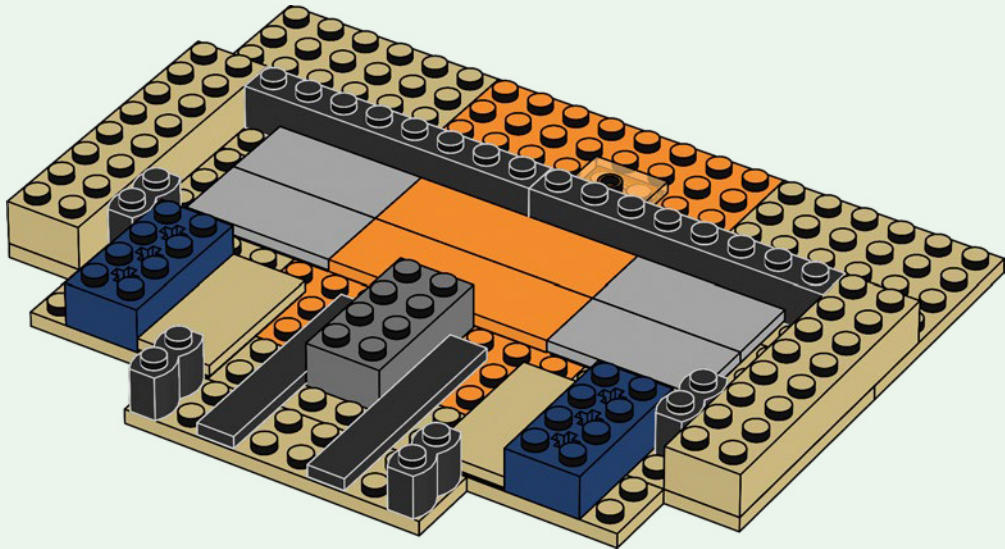



2x

18

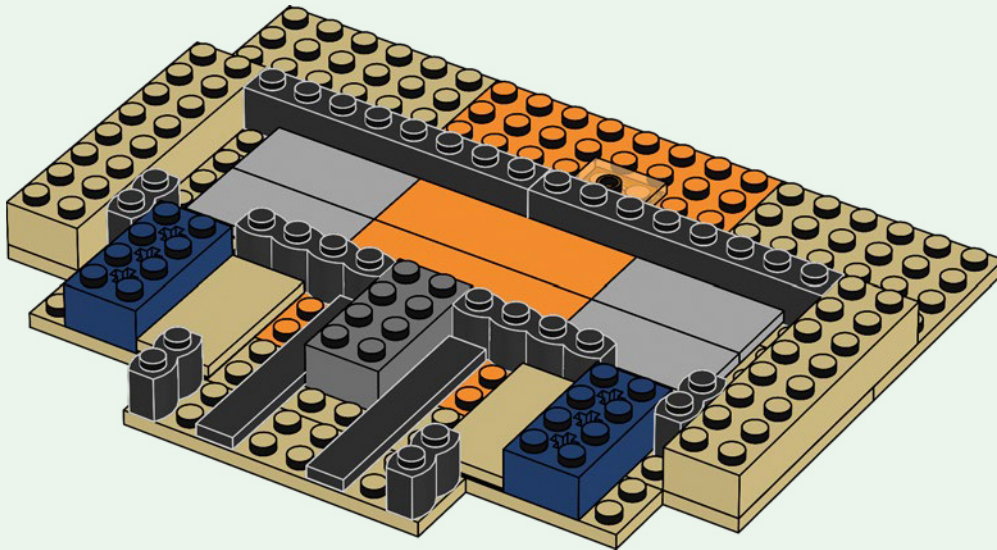



1x

19

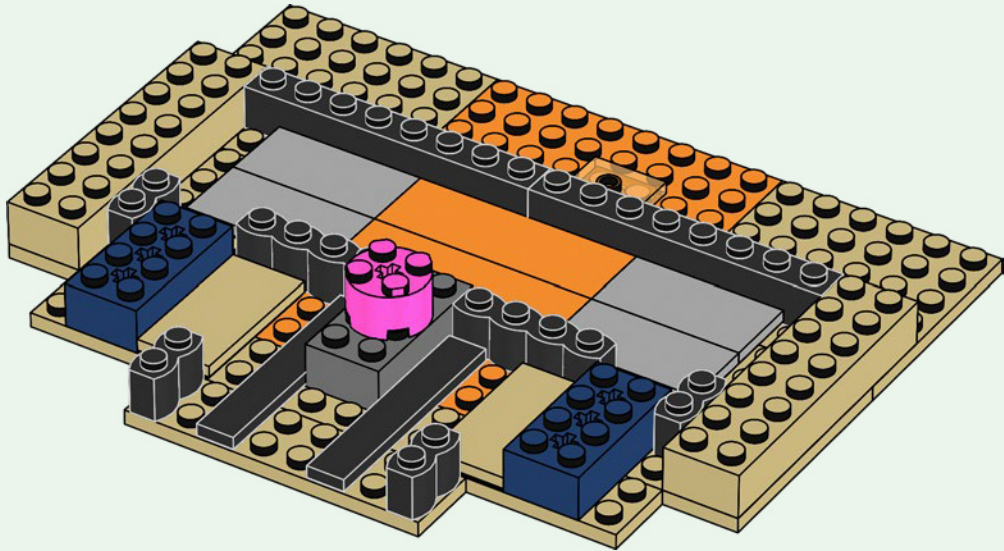

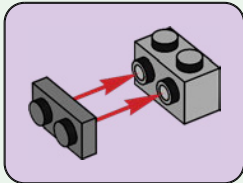
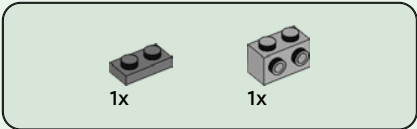

20

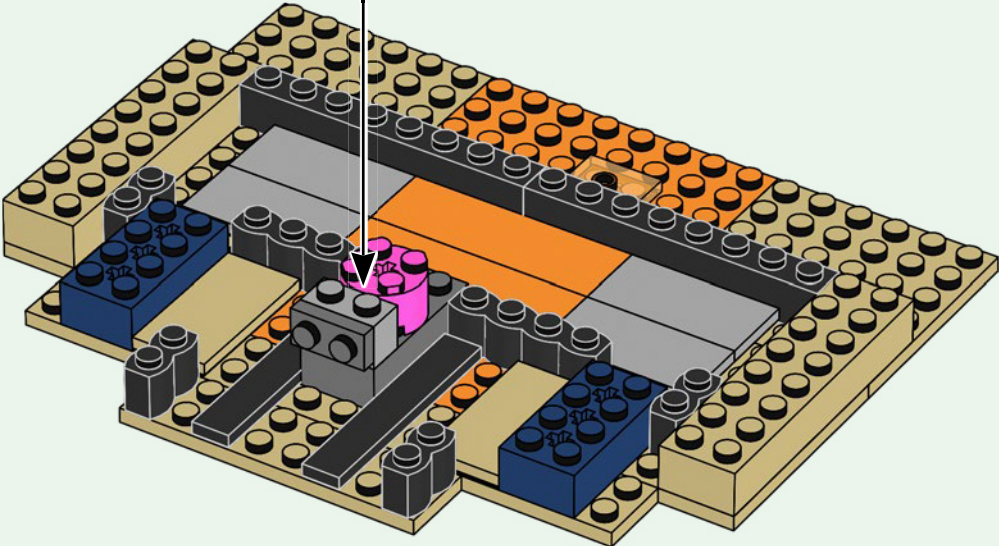

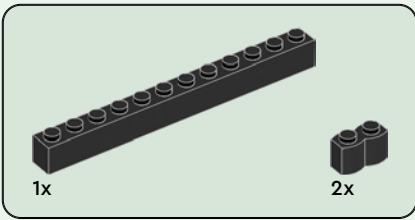

21

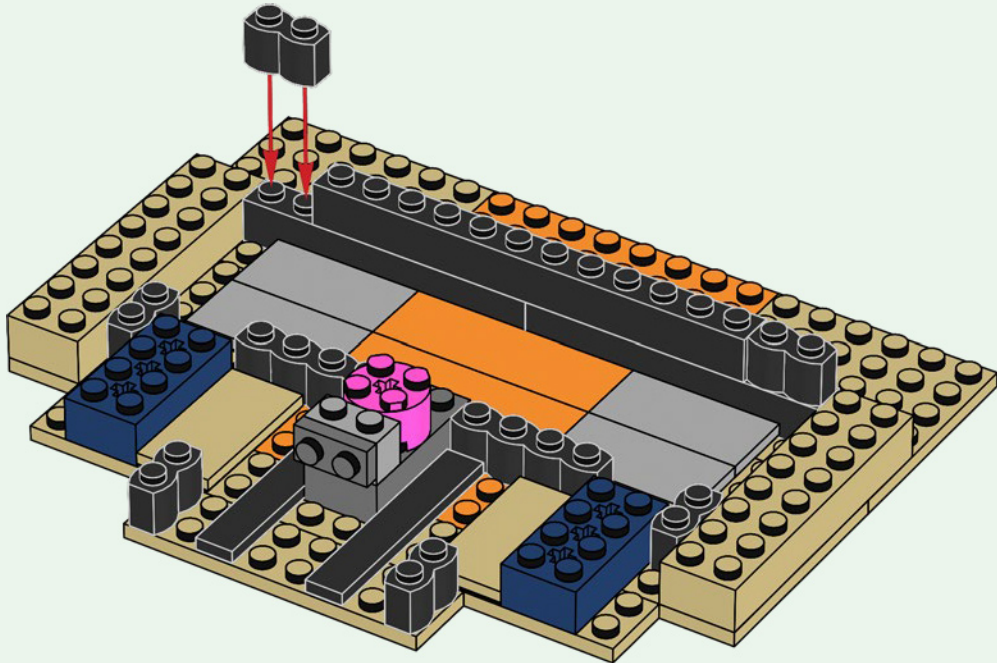

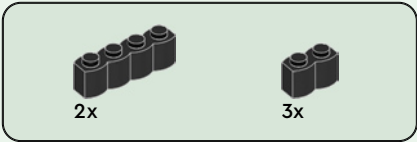

22

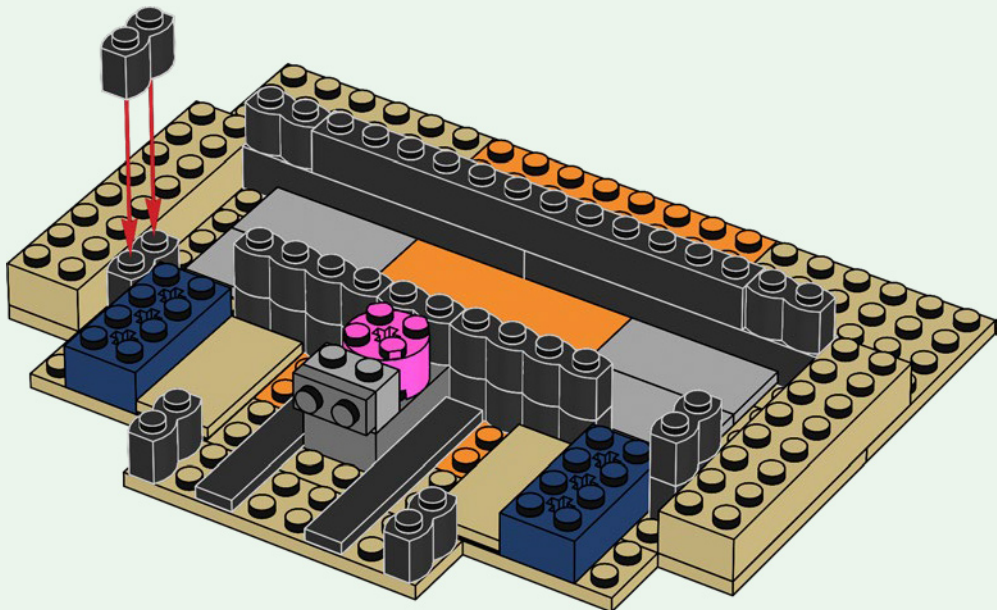

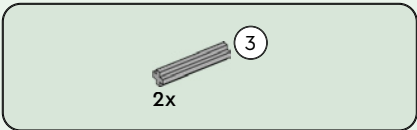

23

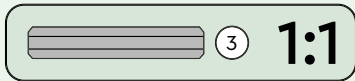
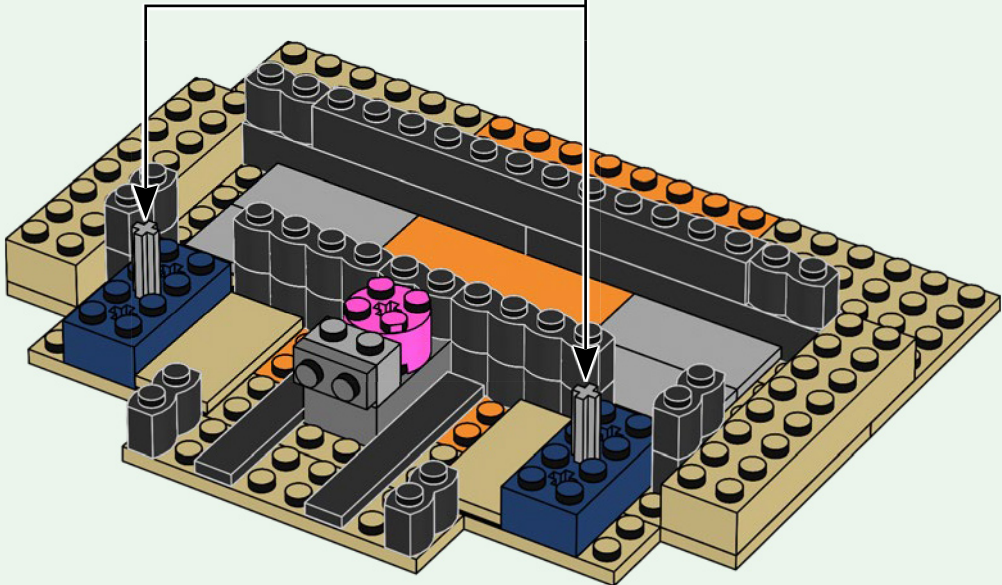
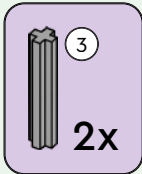

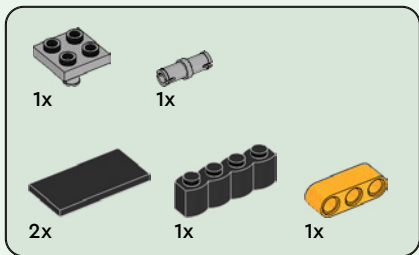

24

1

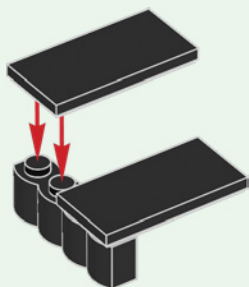

2

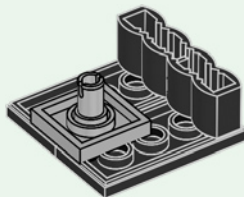

3

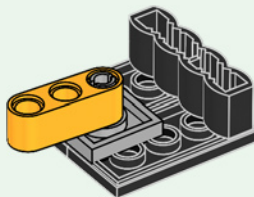

4

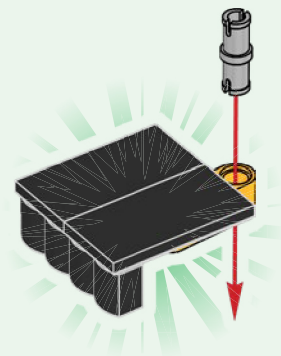

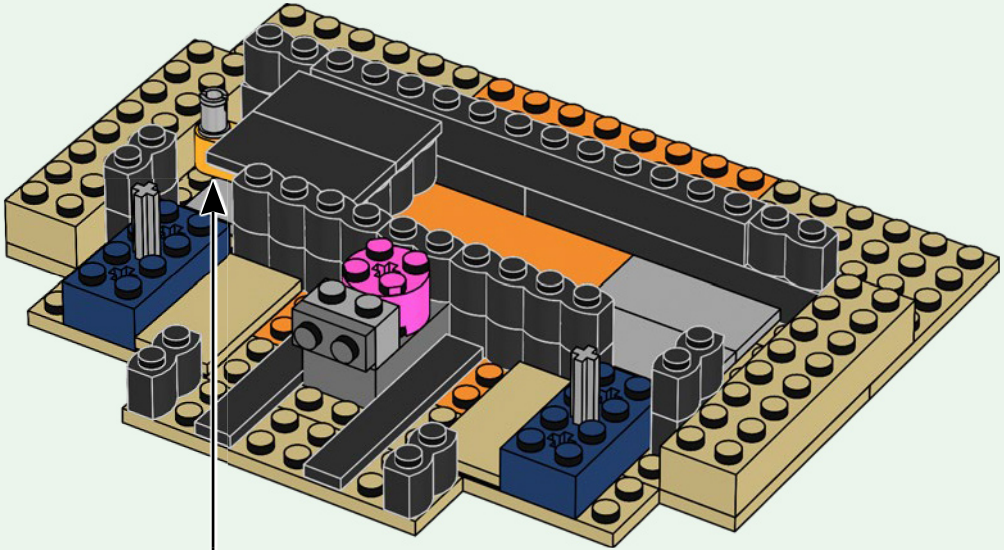

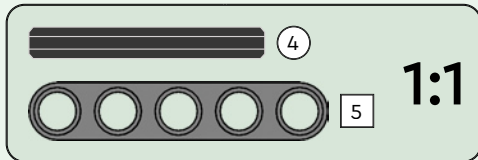
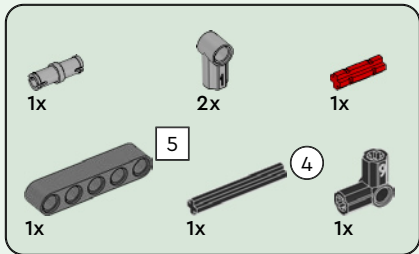

25

1

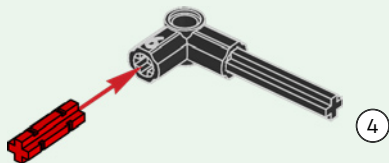

2

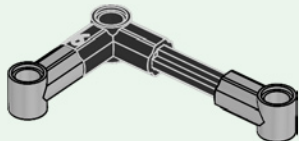

3

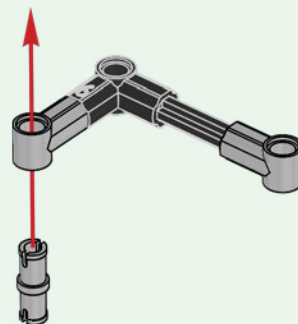

4

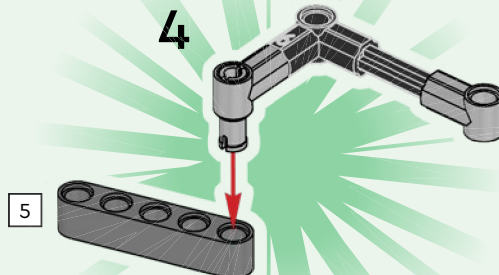

5



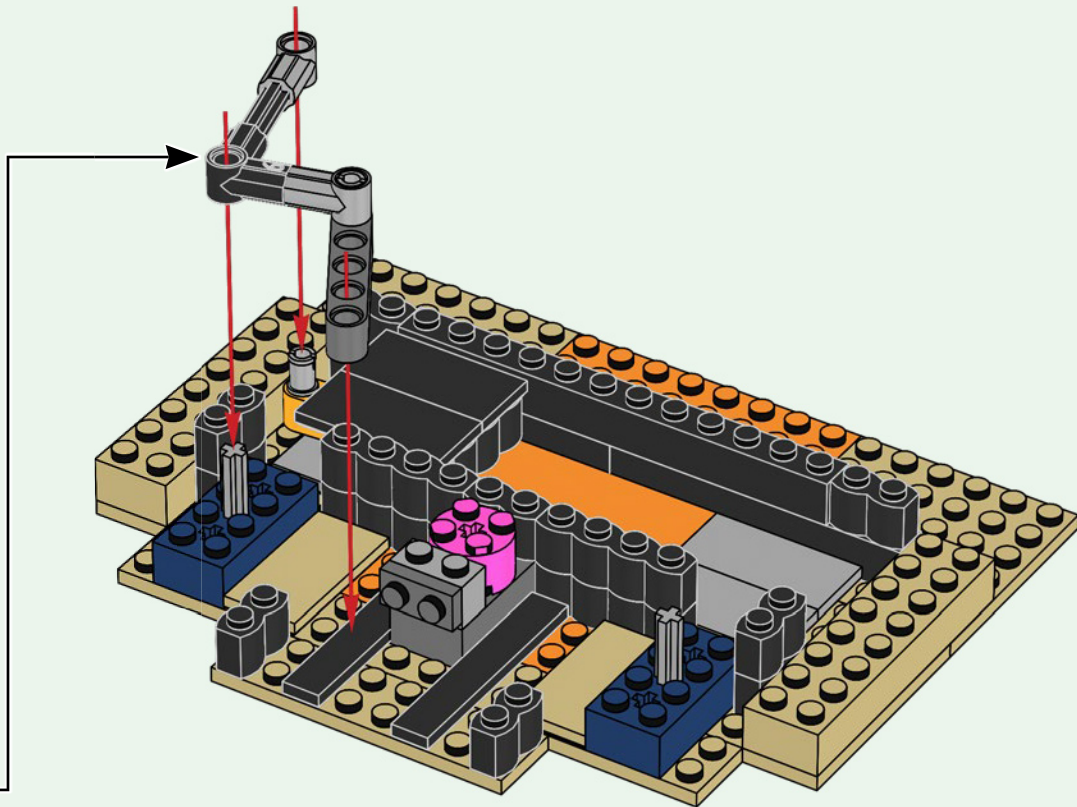



1x

26

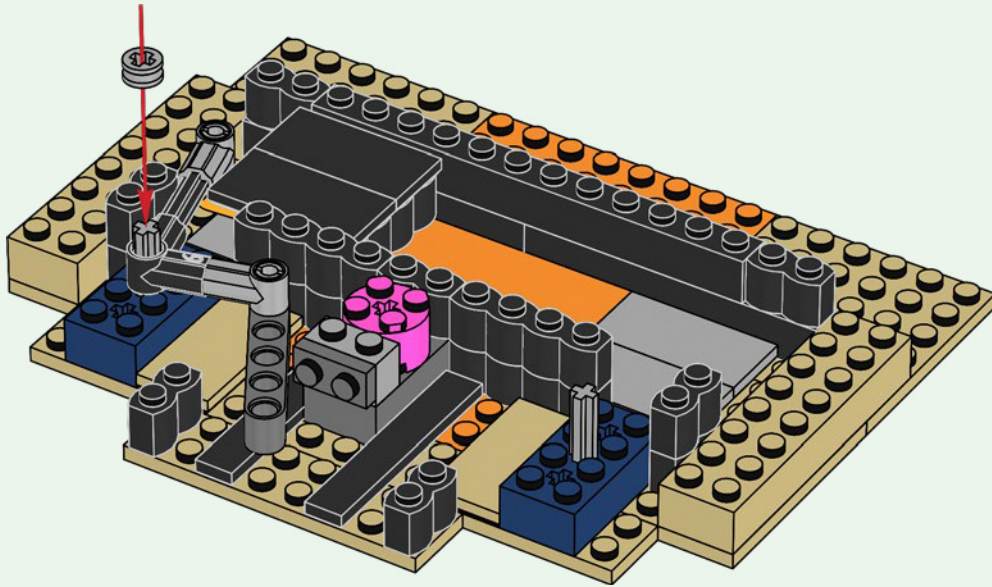

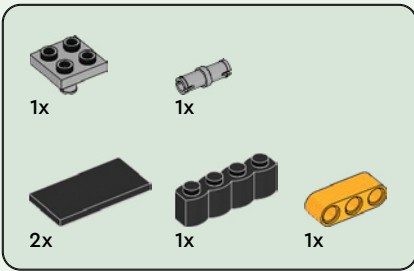

27

1

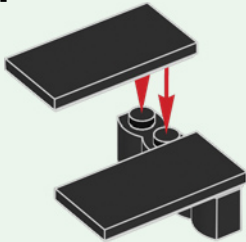

2

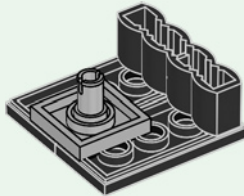

3

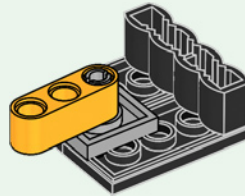

4

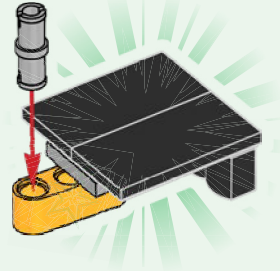

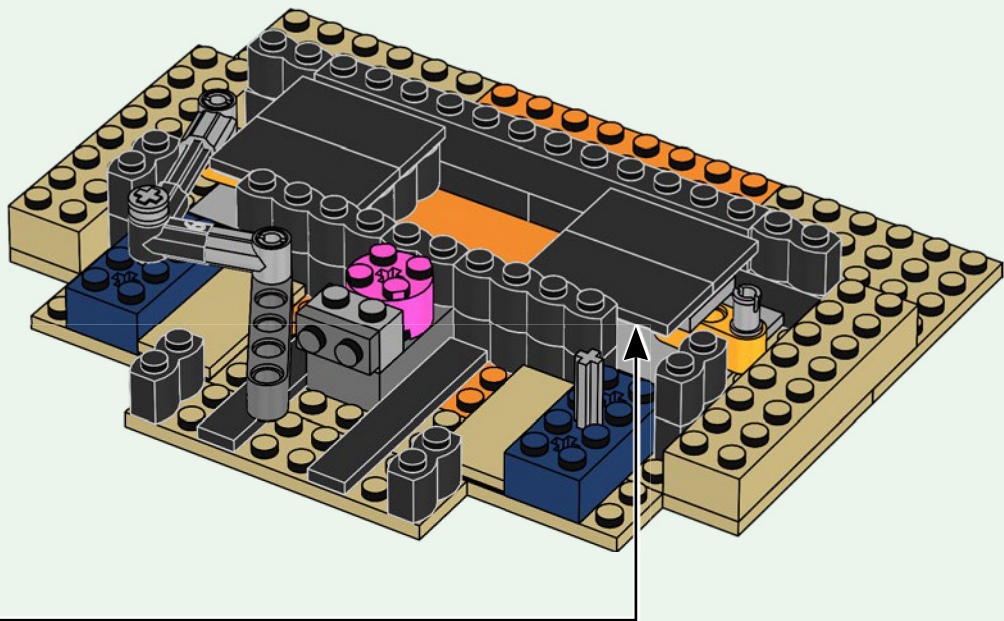

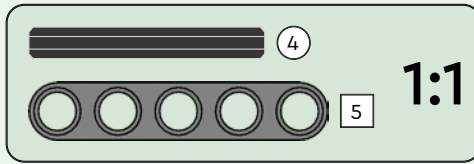
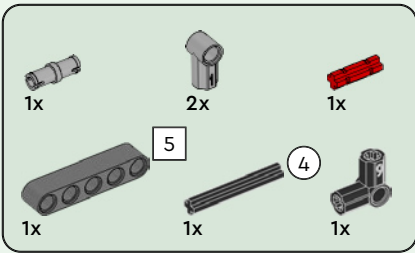

28

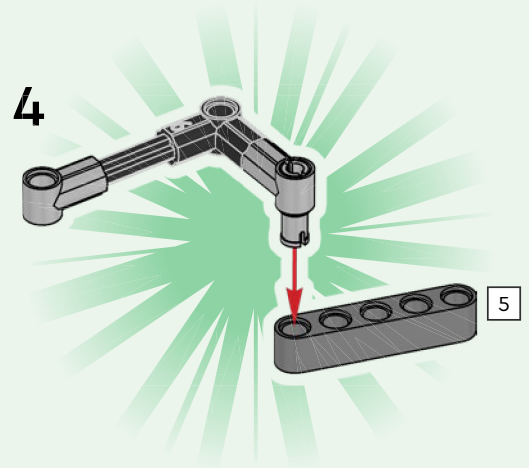
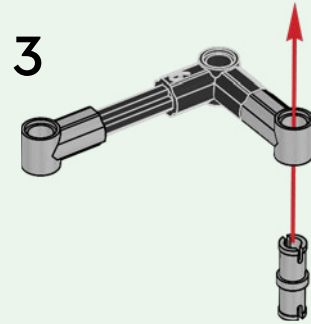
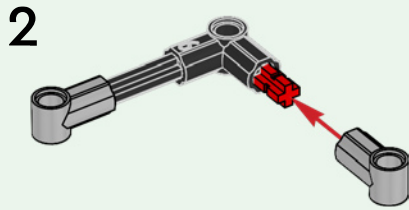

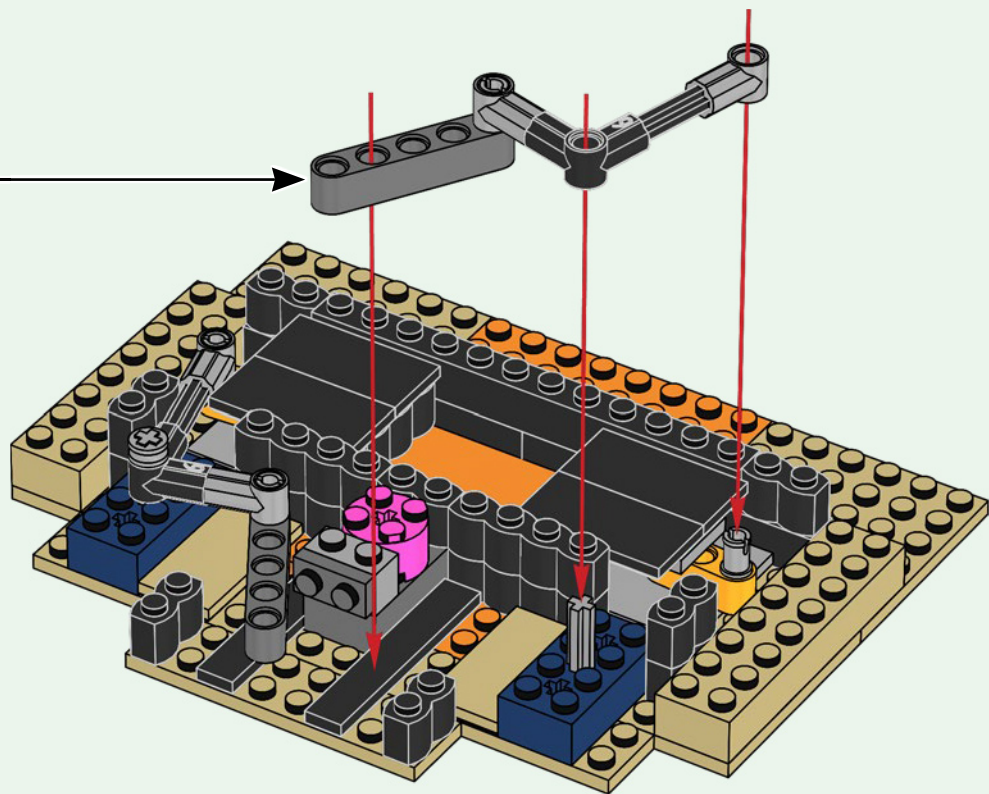



29

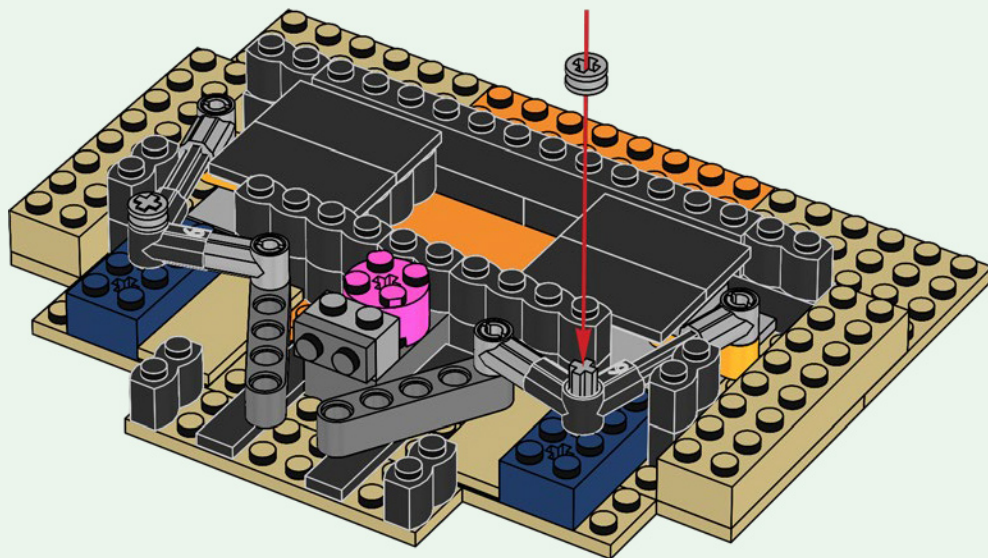

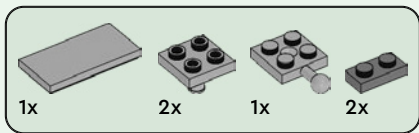

30

1

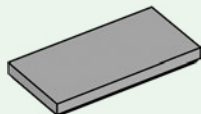

2

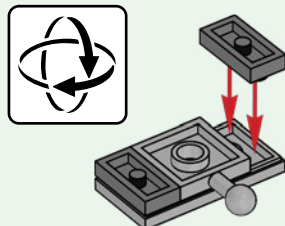

3

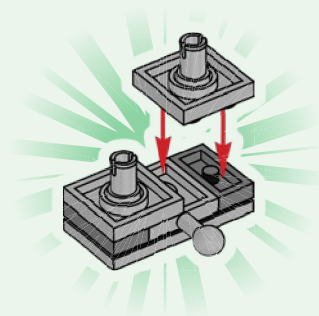

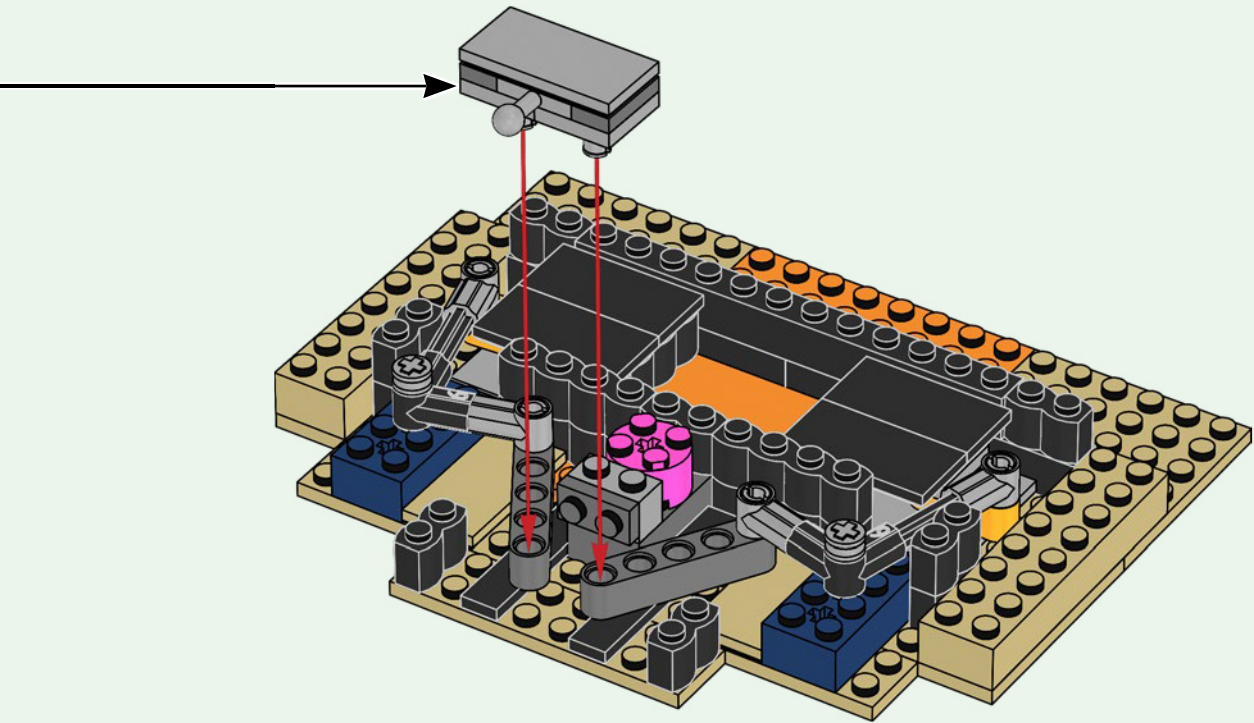



2x

31

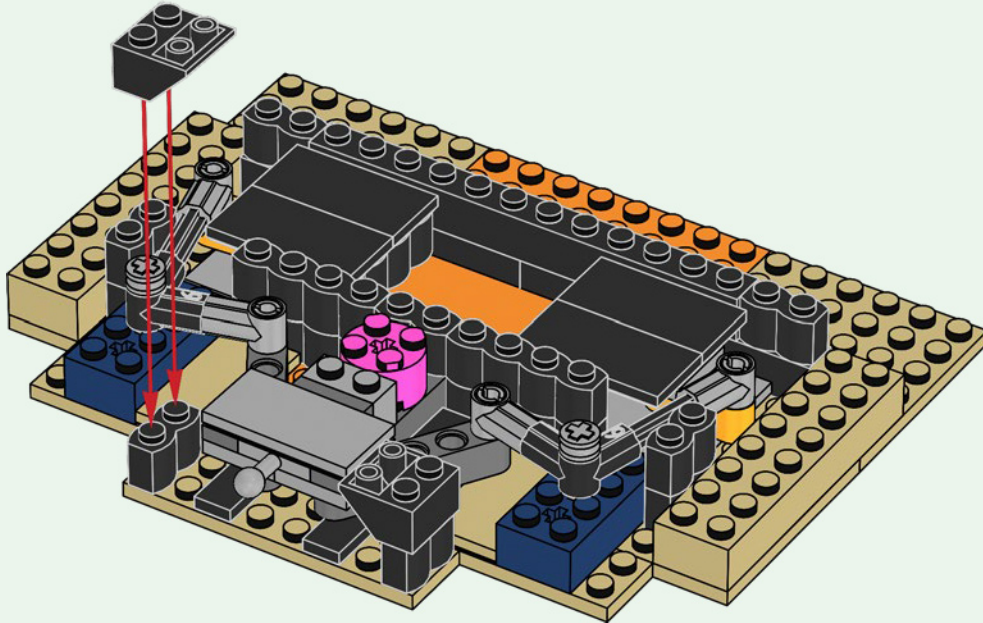

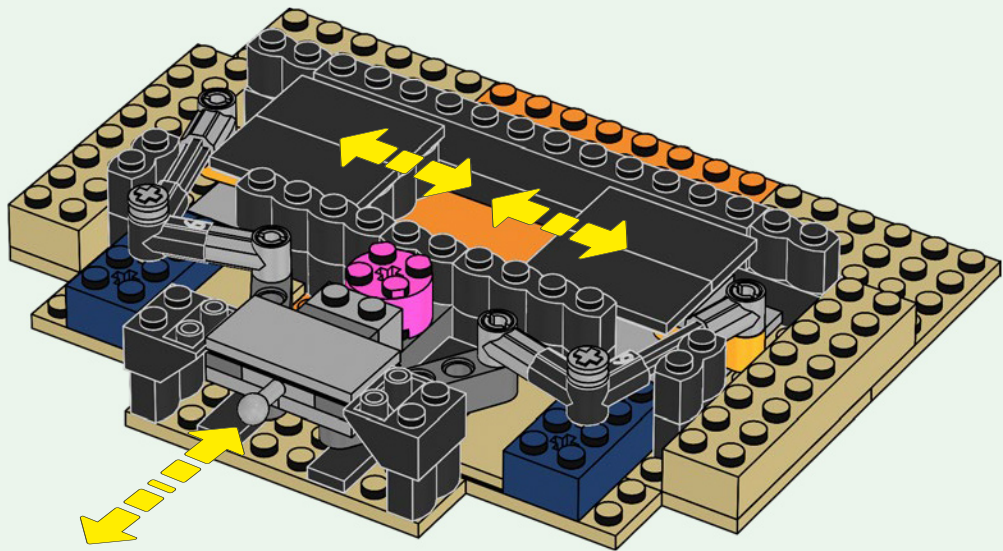

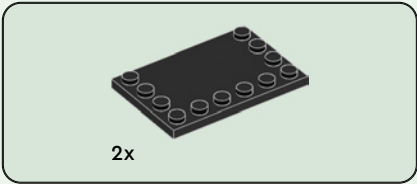

32

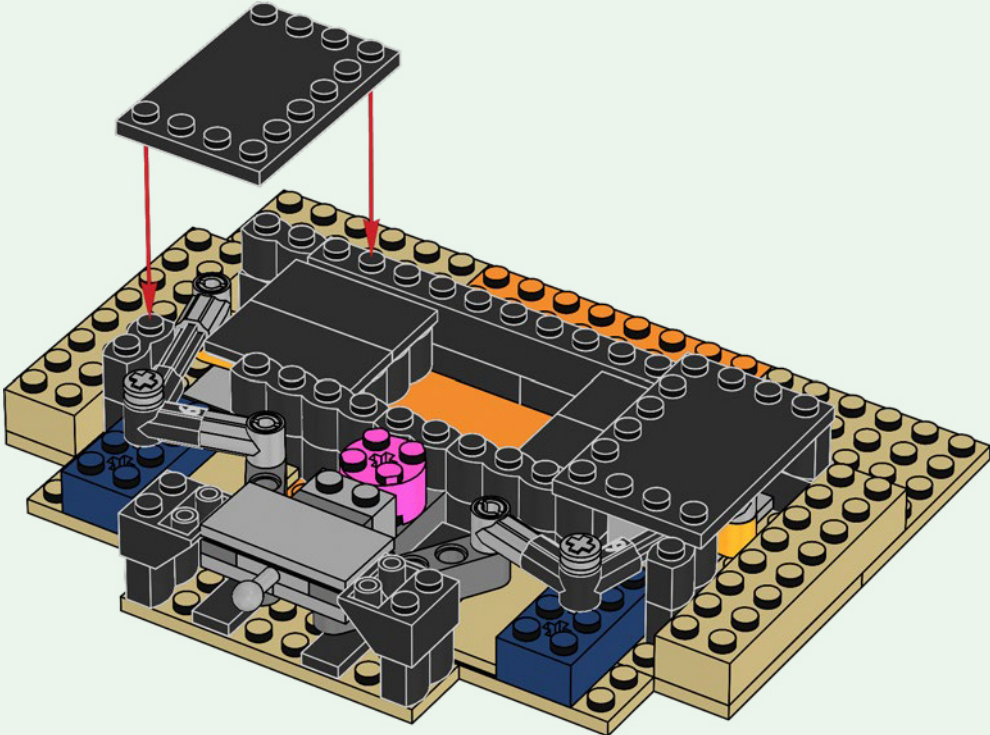

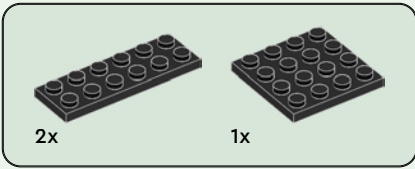

33

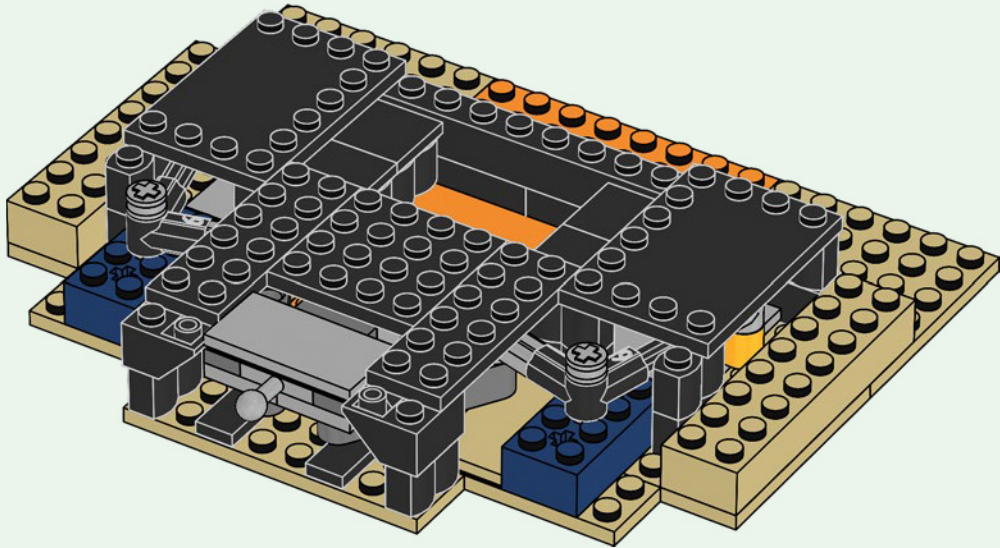



2x

34

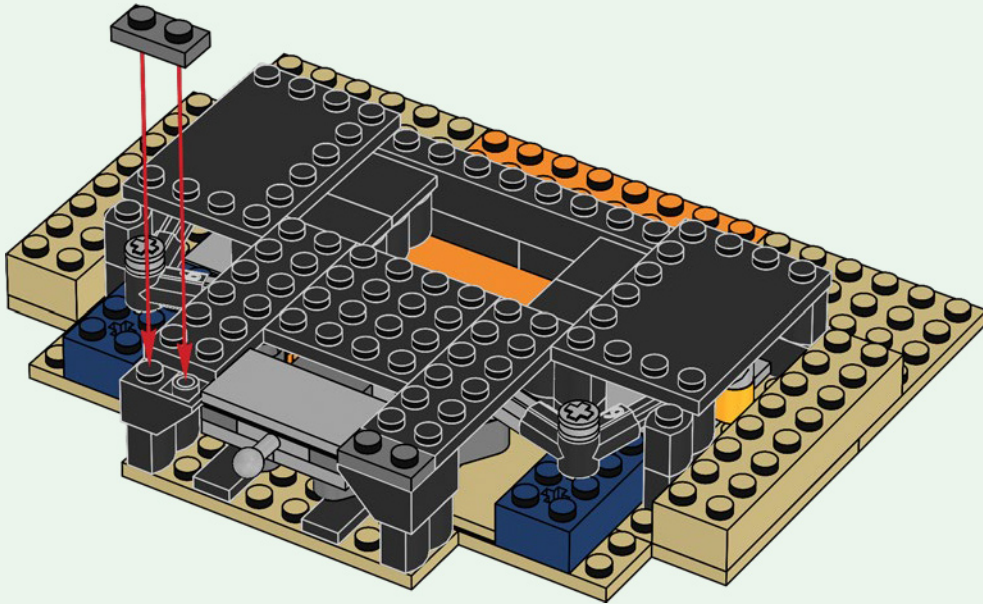



2x



2x

35

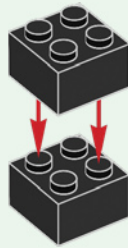



2x

36

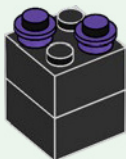

2x

37

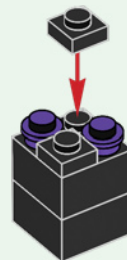



1x

38

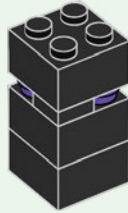

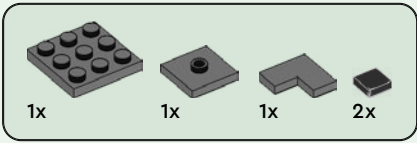

39

1

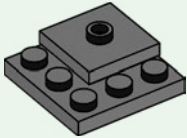

2

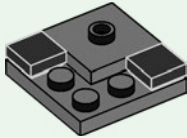

3

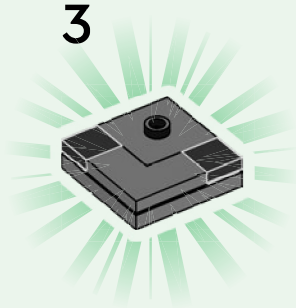



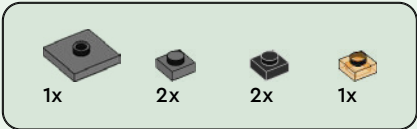

40

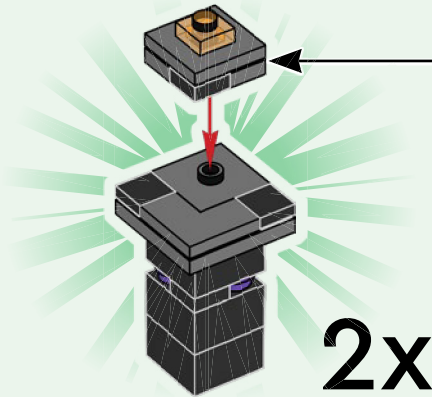
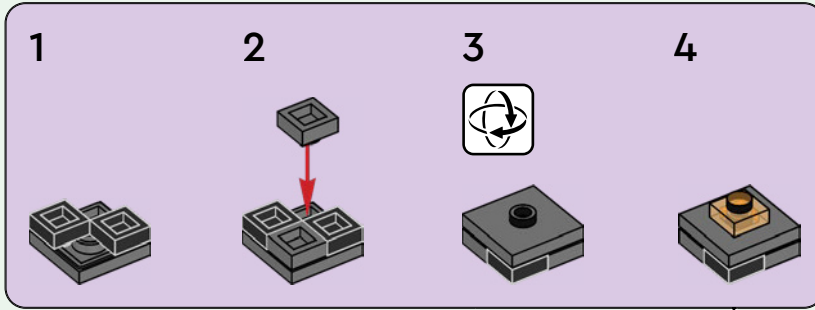

41

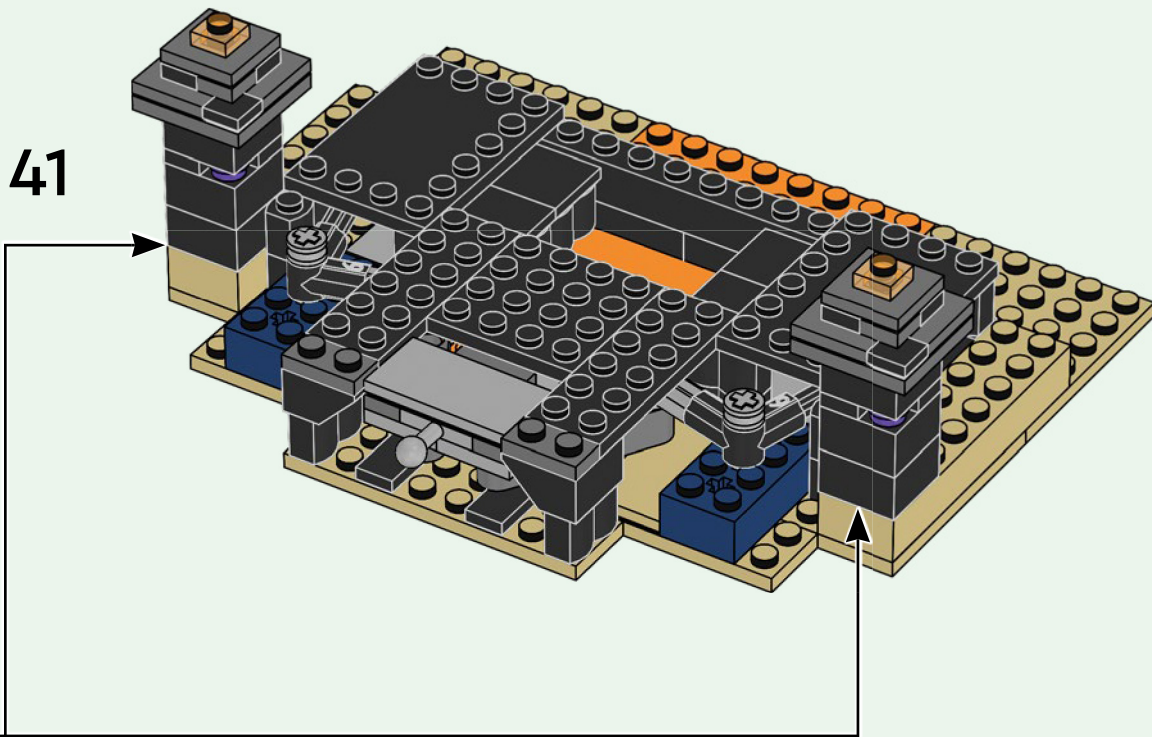

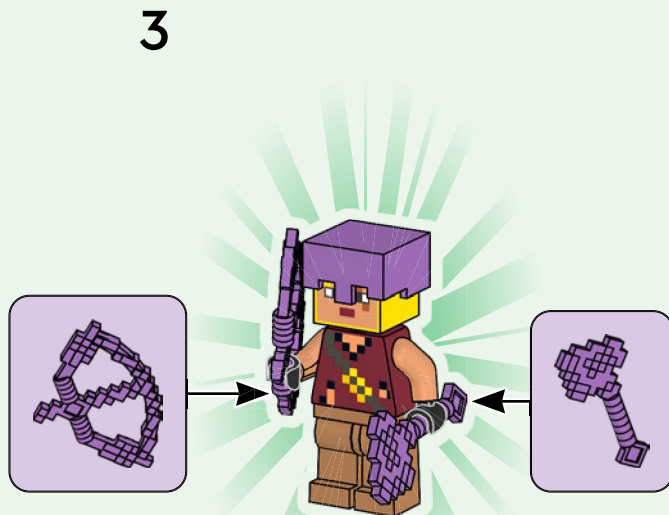

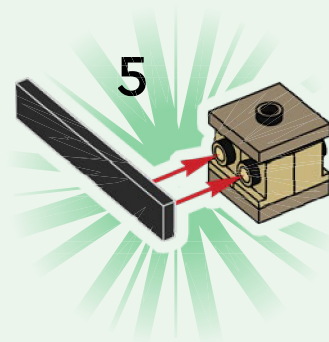
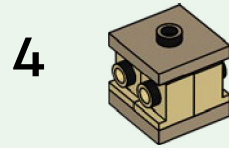
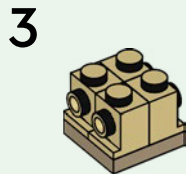
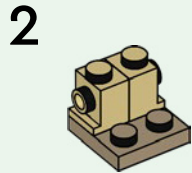
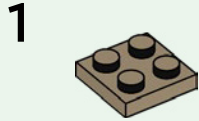
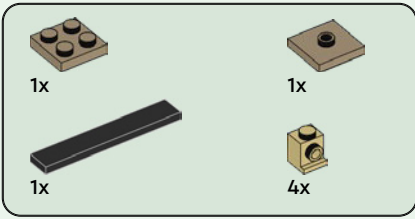

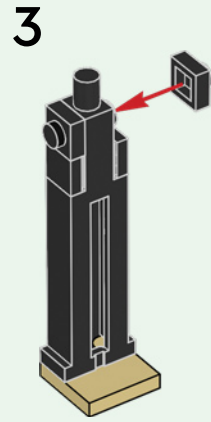
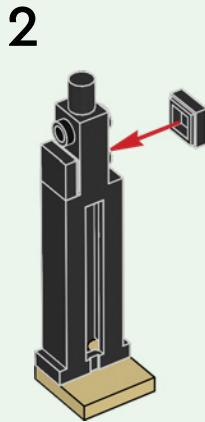
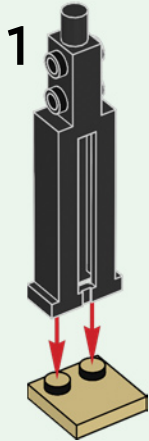
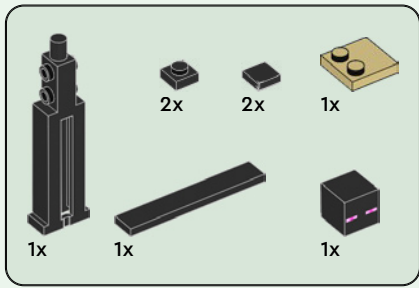

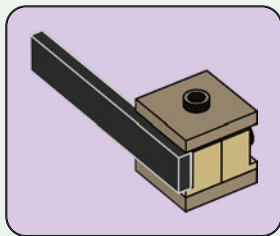

4

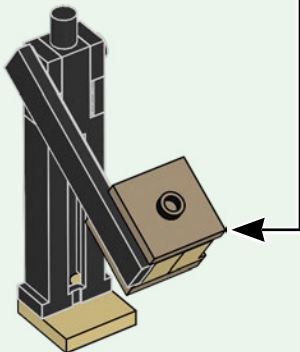

5

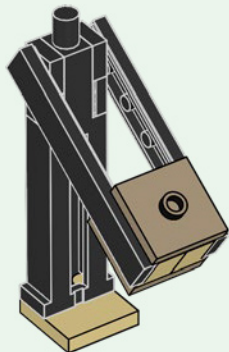

6

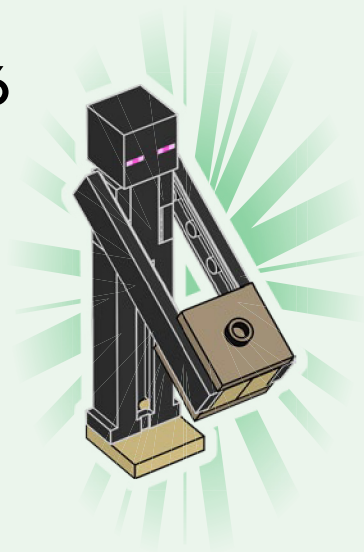

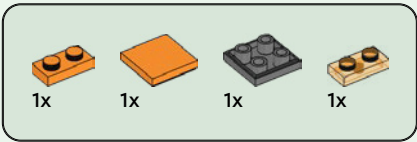
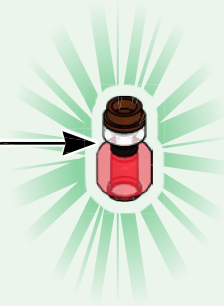
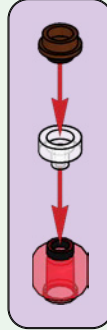
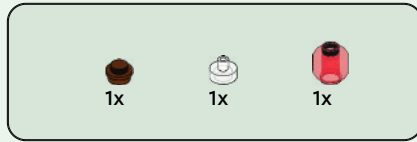
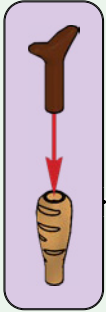
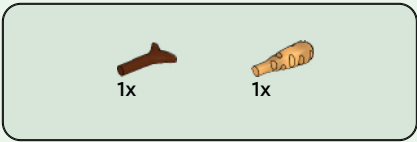

1

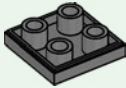

2

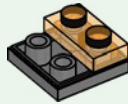

3

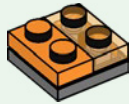

4



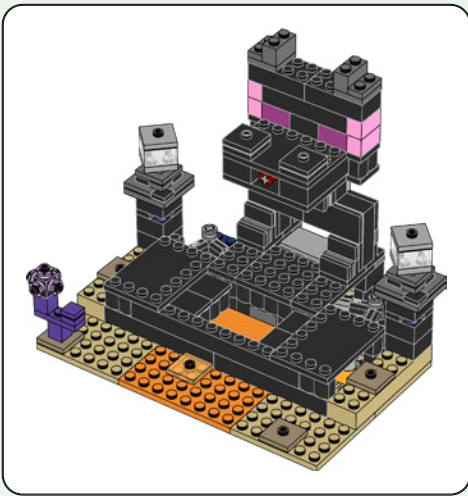

2x



2x



2x



2x

42

1

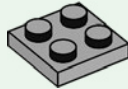

2

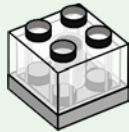

3



2x



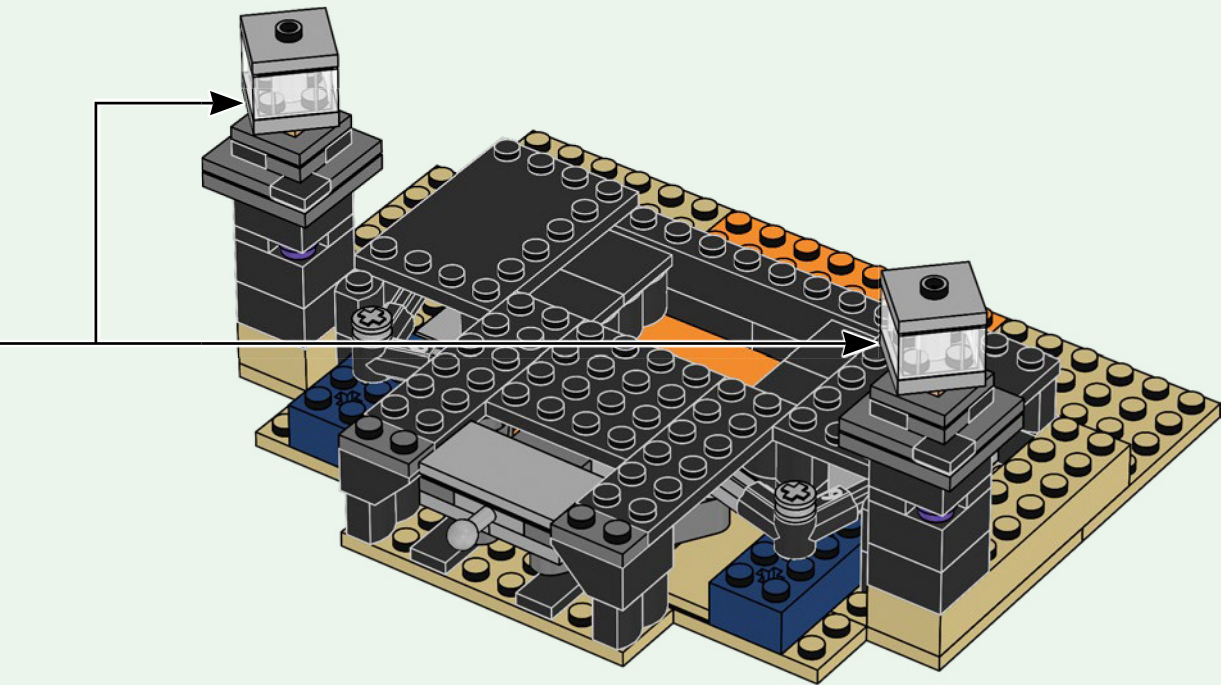

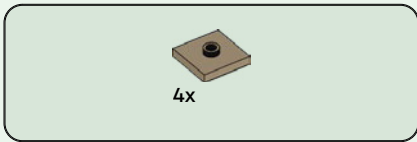

43

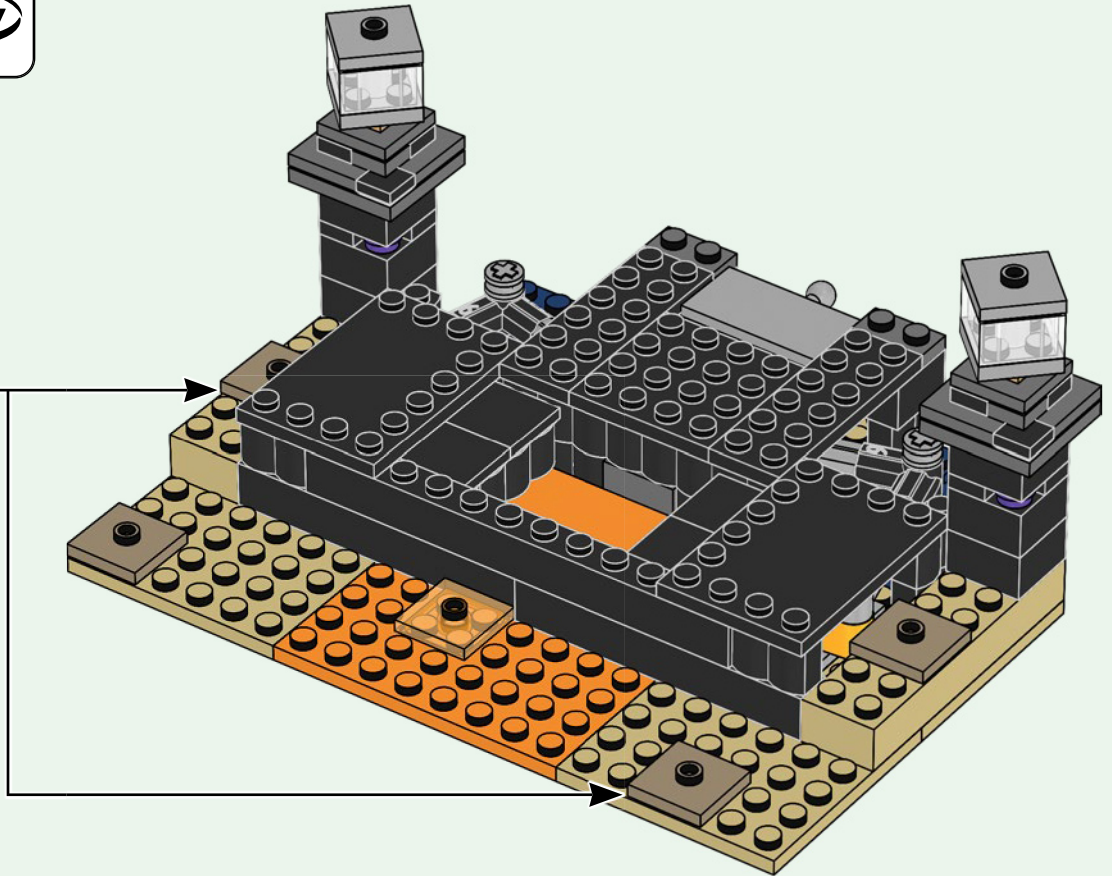
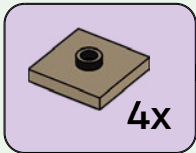

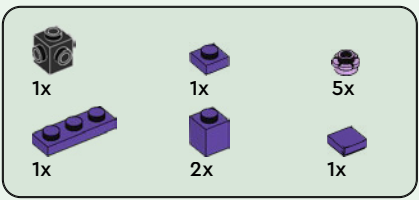

44

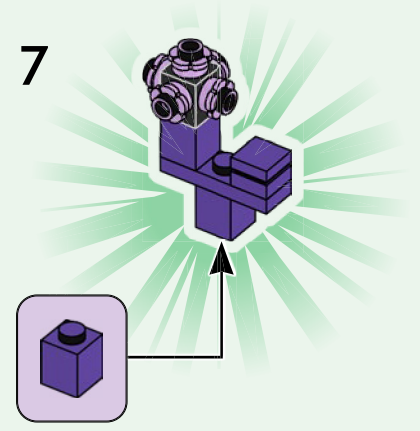
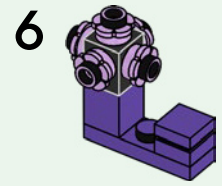
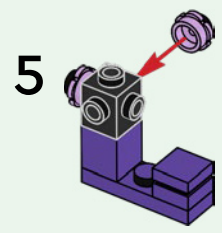
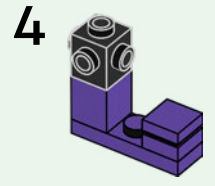
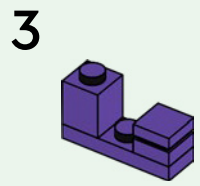
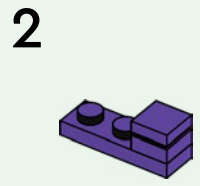
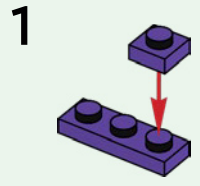

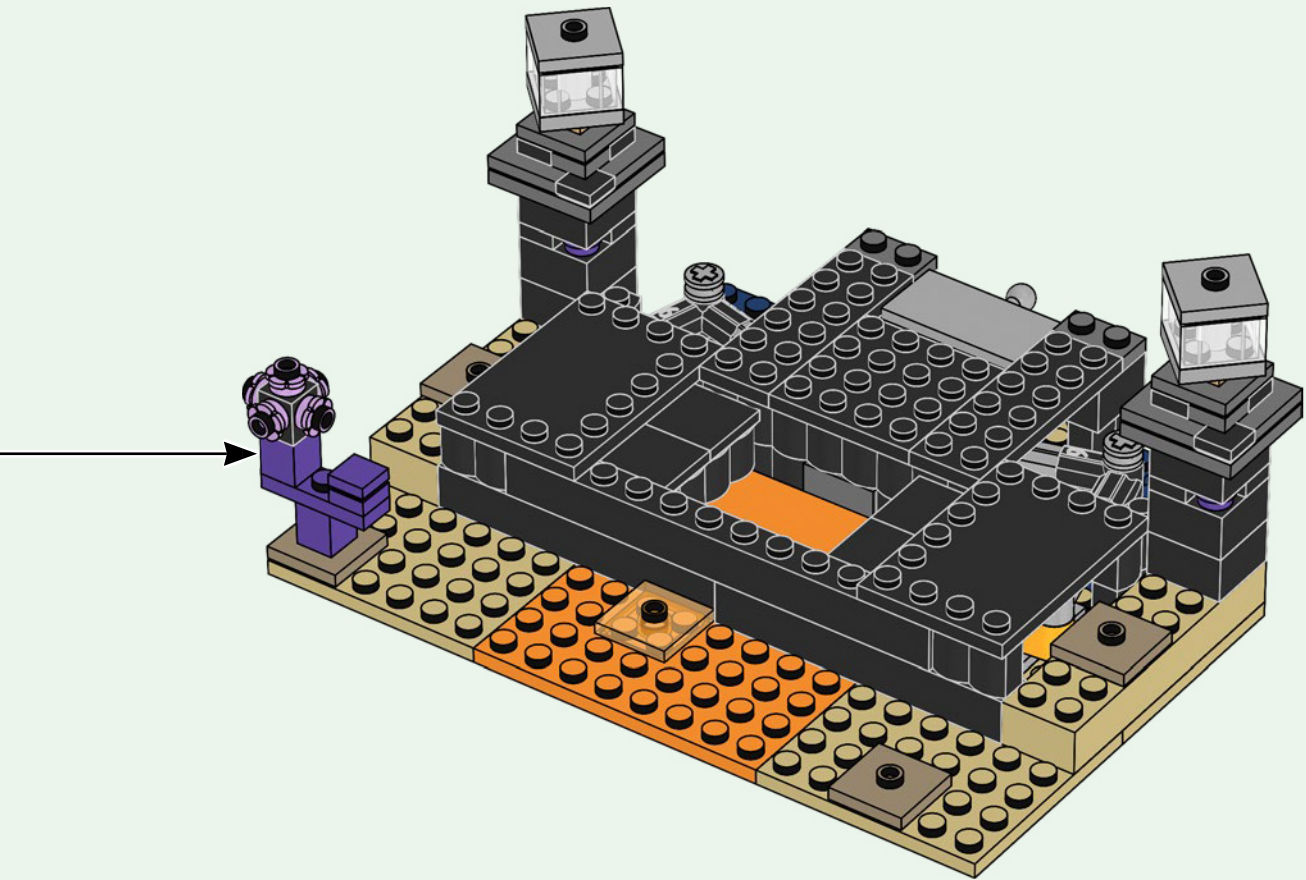

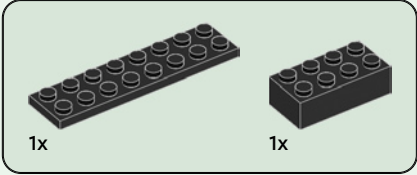
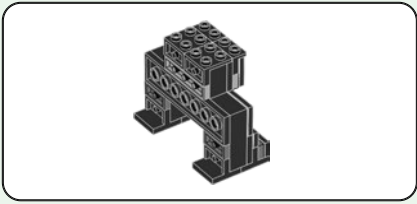

45

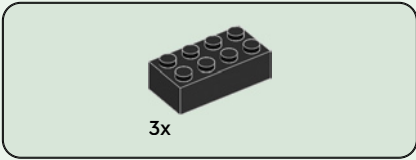
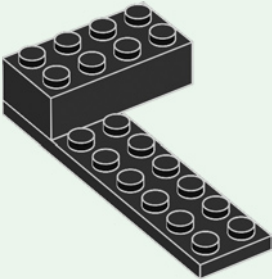

46

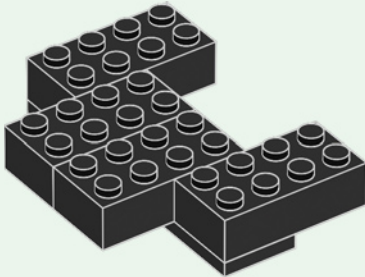

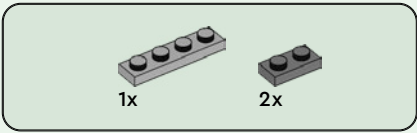

47

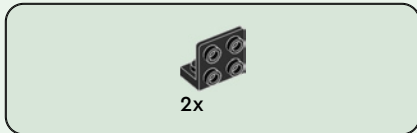
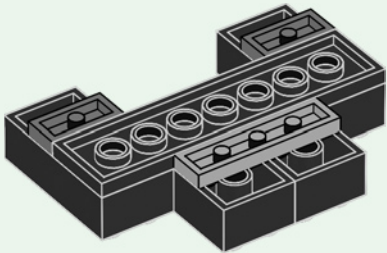

48

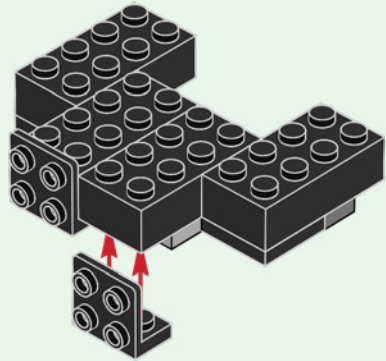

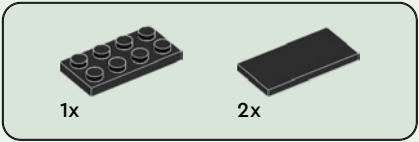

49

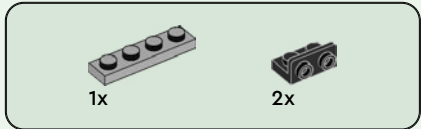
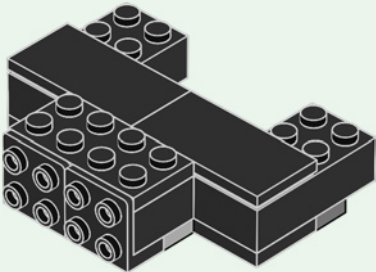

50

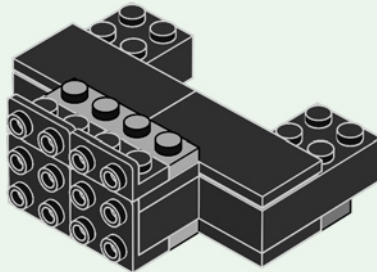

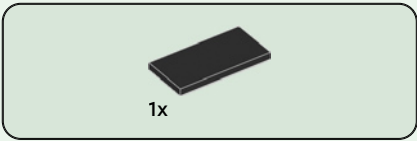

51

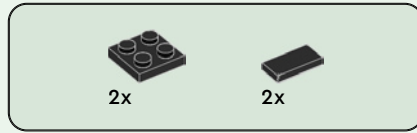
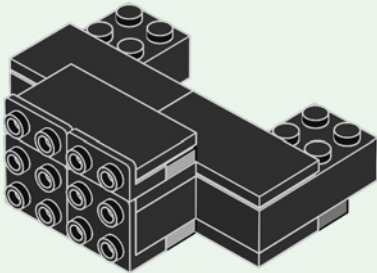

52

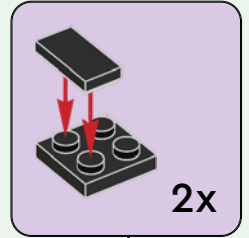
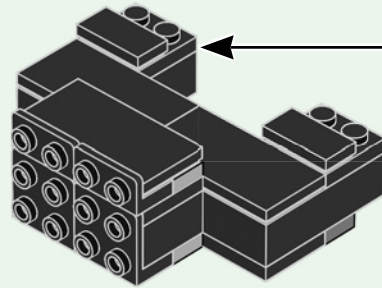

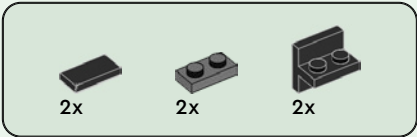

53

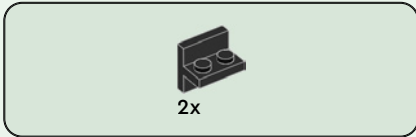
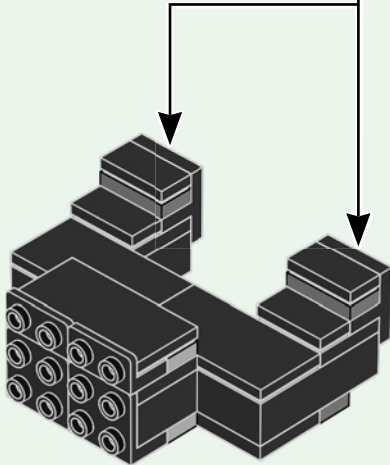
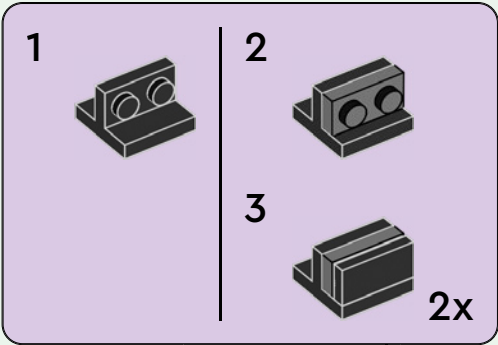

54

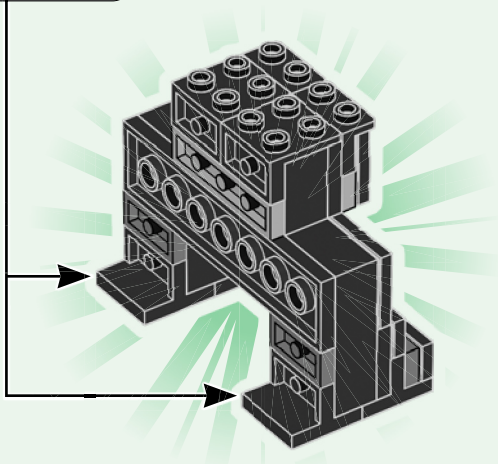
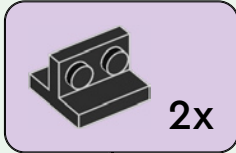

55

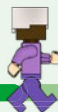
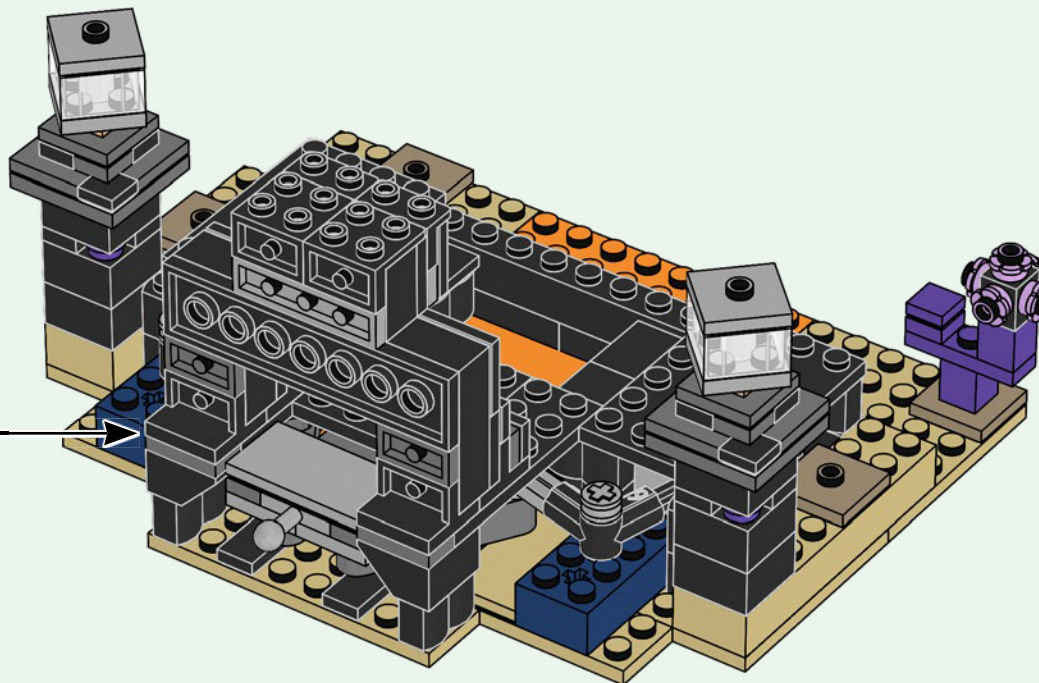

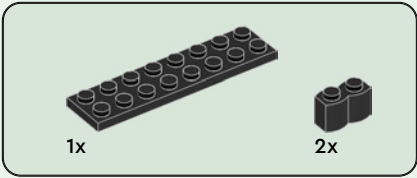
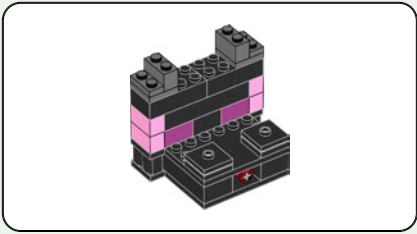

56

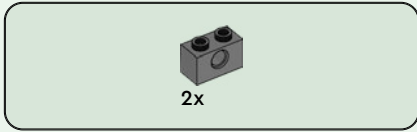
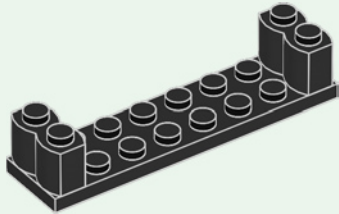

57

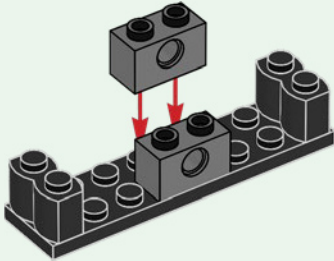

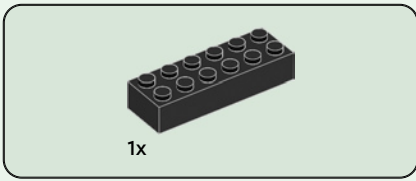

58

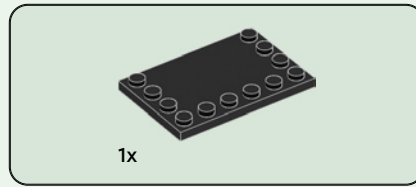
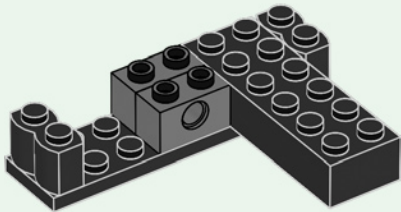

59

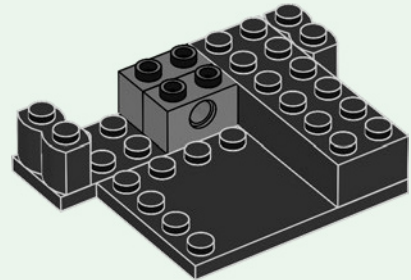

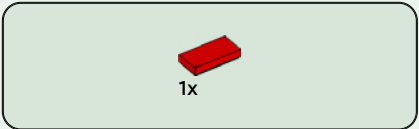

60

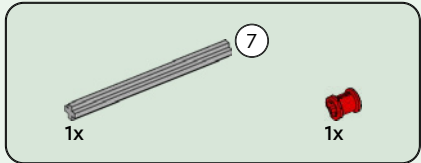
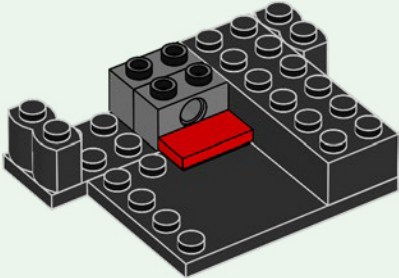

61

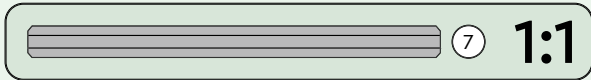
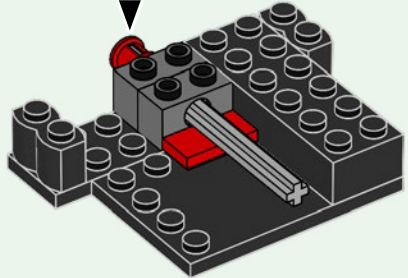
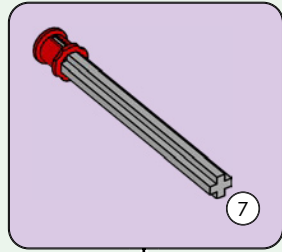



1x

62

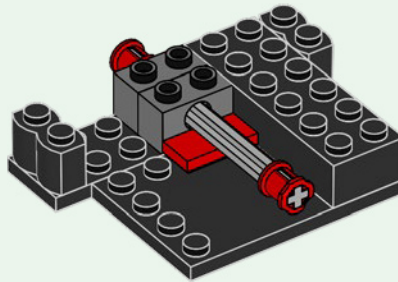

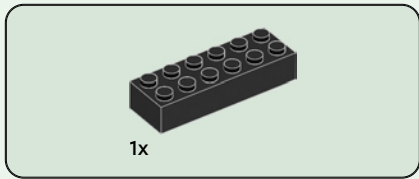

63

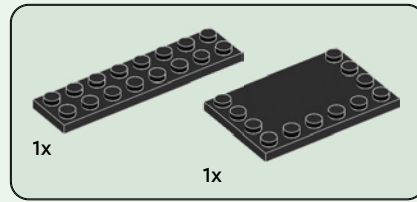
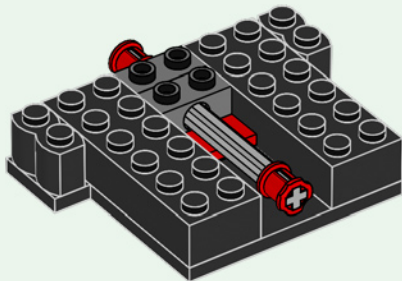

64

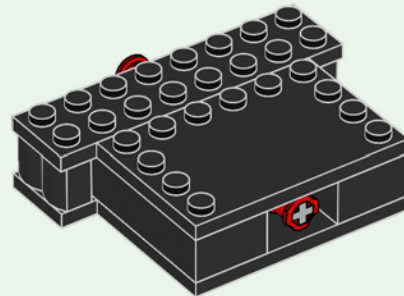

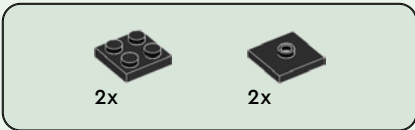

65

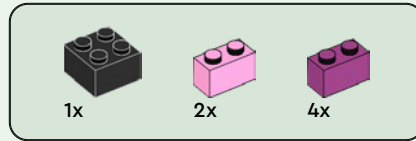
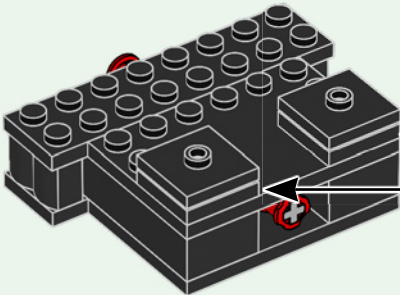
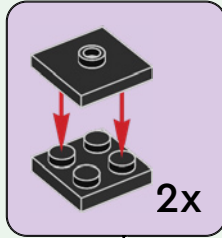

66

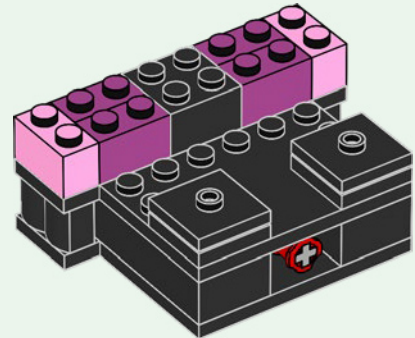

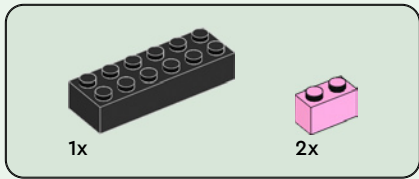

67

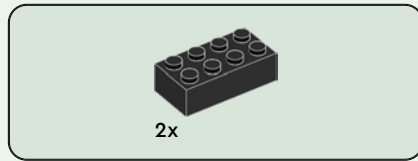
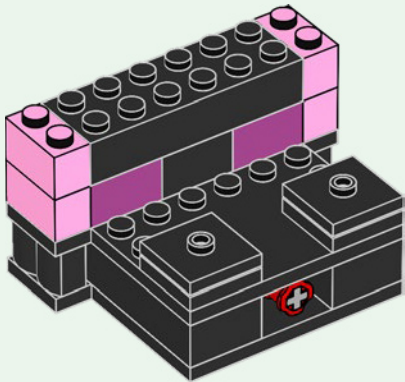

68

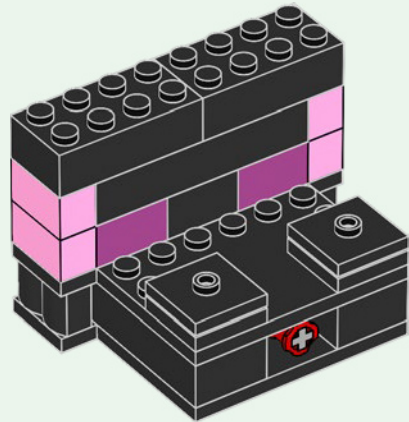



2x

69

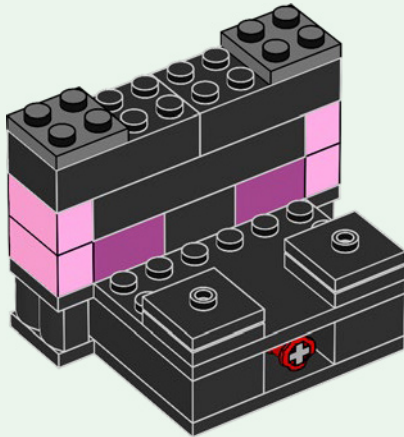

2x



2x

70

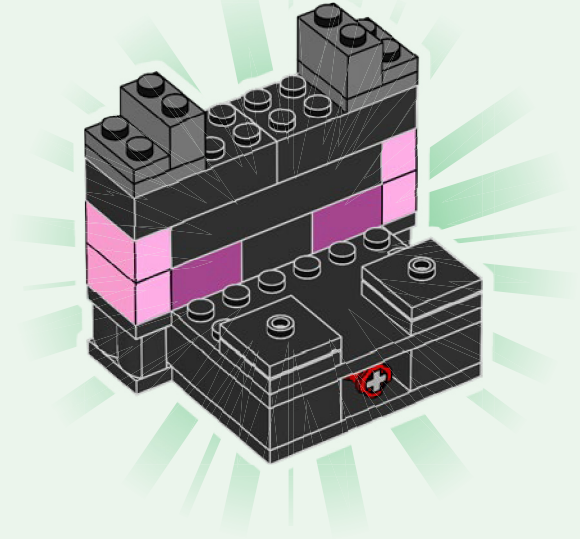

71

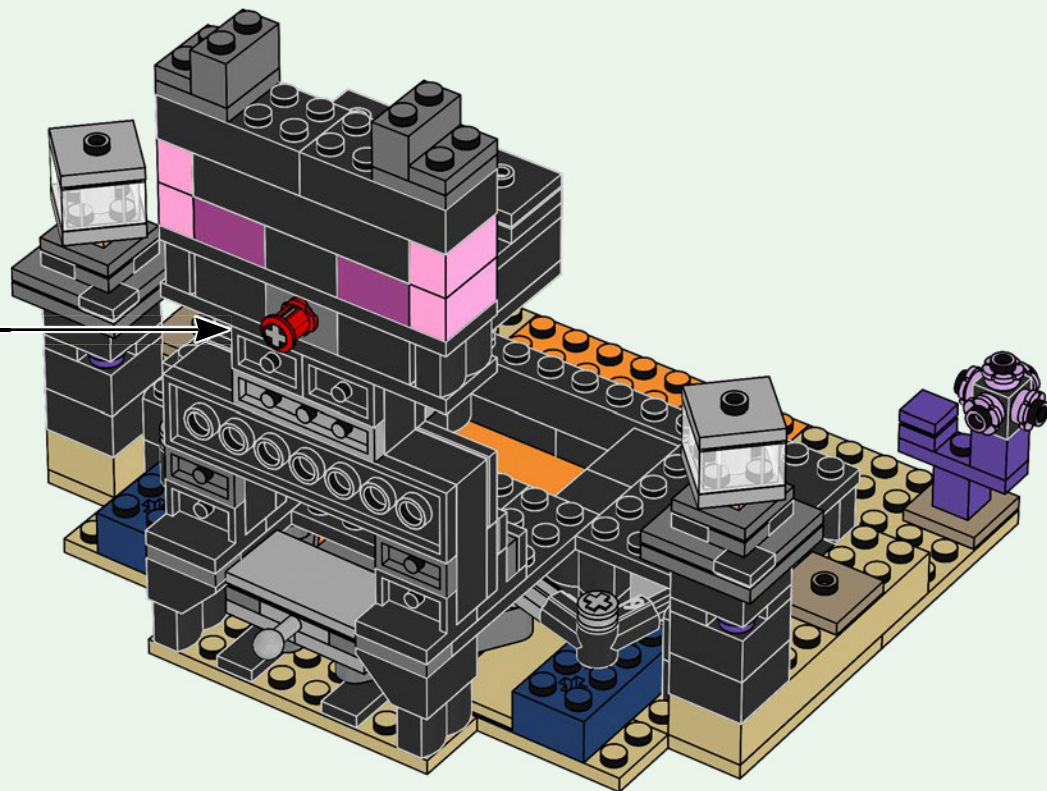

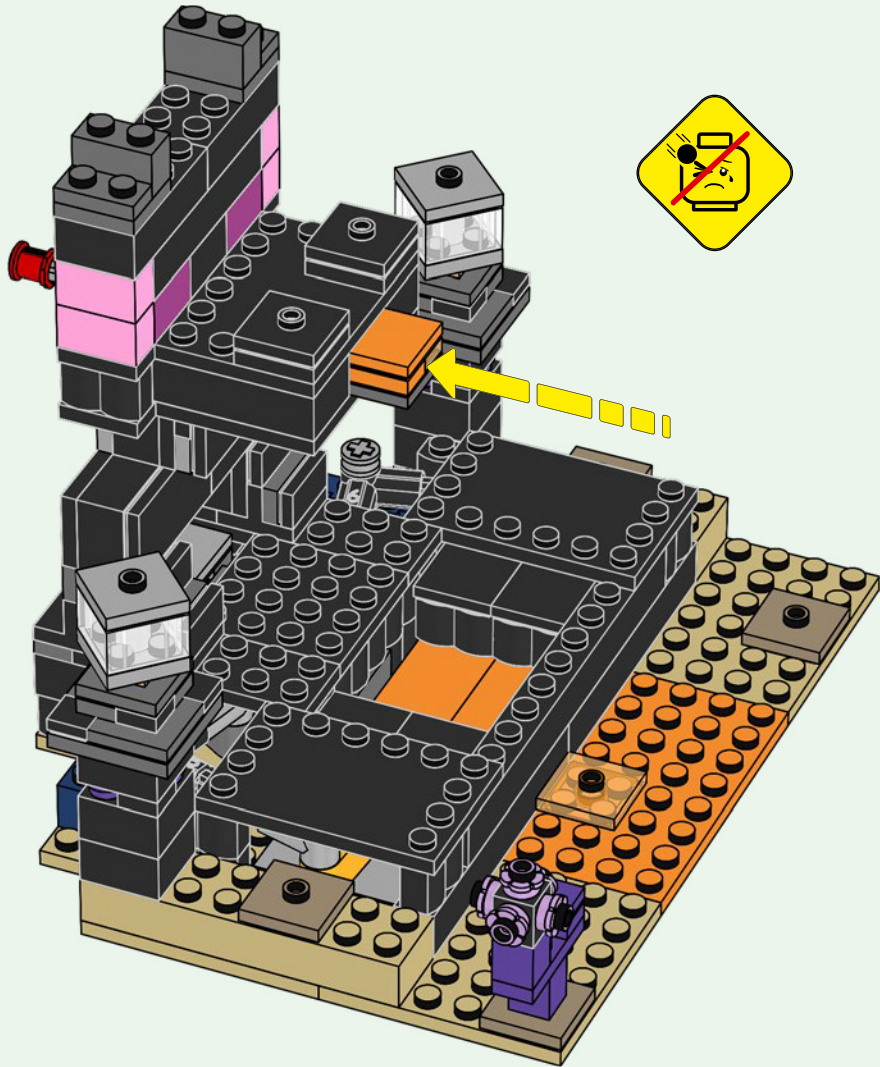

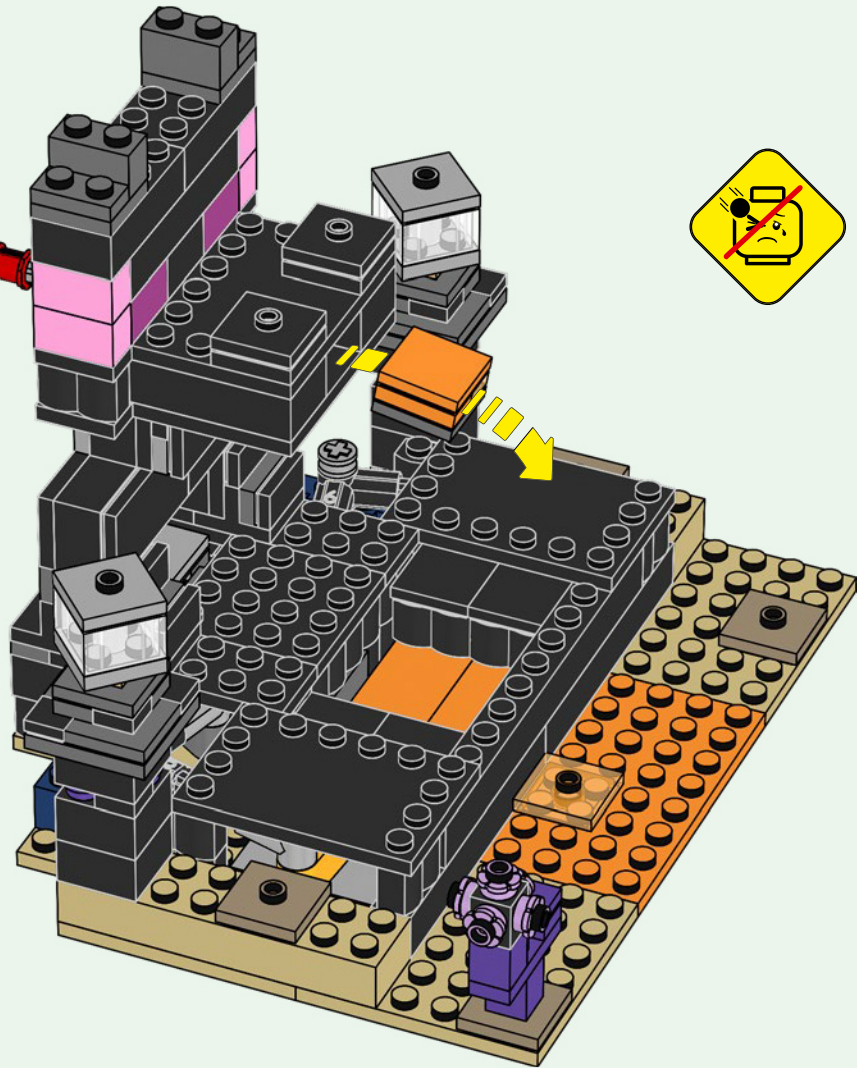
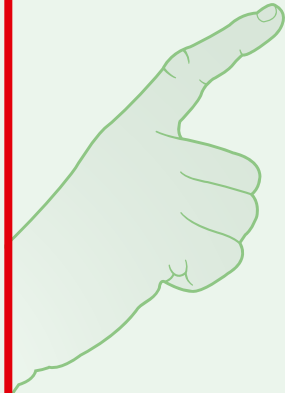





MINECRAFT

21243



21244



21241



21245





MINECRAFT

21242



21246



1x
4125253



1x
6422994



4x
4118793



1x
6221467



2x
6122047

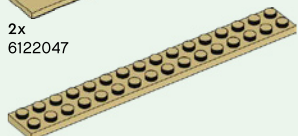

1x
6030980

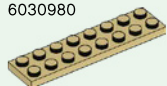

1x
4113988

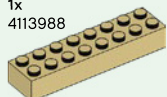

2x
6037398



4x
4125217



2x
6271820



2x
4142865



1x
306921



1x
6423958

82



1x
6356406



10x
302426



6x
307026



1x
473326



11x
4644456



1x
6162466



2x
6268905



4x
306926



1x
6101874



2x
6020193



2x
6000650



4x
6250020



7x
300326



1x
6101874



1x
6101874



2x
6425507



4x
302226



2x
4565323



2x
370526



6x
6230228



7x
4560182



6x
300126



1x
302026



4x
663626



1x
4243819



3x
4181144



2x
379526



2x
379526

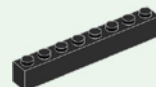

2x
300826



4x
4100378



3x
303426



1x
611226



1x
6186867



2x
6239418



1x
6276023



1x
4177932



1x
4542142



2x
6387565



2x
6387565



2x
6424454



4x
4519195



4x
4519195



4x
4519195

4



5x
6126075



1x
6047415



2x
6384912



1x
6411849



2x
6252040



1x
6240217



1x
6394956



2x
6418455



1x
4216581



1x
6078605



2x
6271165



4x
6296859



4x
4211807



1x
6015344



4x
6276848



2x
4211397



2x
6126082



2x
4211815



1x
6359225



1x
6430844



2x
4211445

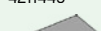

5x
4560183

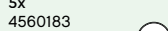

1x
4211805



4x
4210719



11x
4211063



2x
4211088



2x
4211111



1x
6013082



2x
4211094



4x
6126083



2x
6247784



2x
6039176

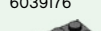

1x
4211085

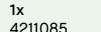

2x
4210686



1x
6422439



4x
4517993



4x
4566522



2x
6084028



1x
6231376



1x
6167457



1x
4586410



1x
6035470



1x
6424453



1x
6192830



1x
6167567



1x
6421063



1x
6426335



1x
6421062



1x
6430920



5x
6214235



1x
6186837



1x
6423956



1x
6262262



1x
6214216



1x
6350506



 [LEGO.com/service](https://www.LEGO.com/service)

YOU COULD **WIN**



Scan this QR code or go to **LEGO.COM/PRODUCTFEEDBACK** and give us your short feedback about this LEGO® set for a chance to win a cool LEGO prize.

Terms and Conditions apply*

DE: Du könntest GEWINNEN. Es gelten die Teilnahmebedingungen* **FR: Tu pourrais GAGNER.** Des conditions s'appliquent* **IT: Potresti VINCERE tu.** Termini e condizioni sono applicabili* **ES: Puedes GANAR.** Aplican términos y condiciones* **PT: Poderá GANHAR.** Aplicam-se termos e condições* **JA: プレゼント付き! 利用規約が適用されます*** **ZH: 轻松获奖. 条款和条件适用*** **KO: 상품의 주인이 되어보세요. 소정의 약관이 적용됩니다*** **RU: Вы можете ВЫИГРАТЬ.** Действуют положения и условия* **PL: Szansa na WYGRANĄ.** Obowiązują warunki korzystania* **CS: Máte šanci VYHRÁT.** Platí všeobecné smluvní podmínky* **SK: Máte šancu VYHRAŤ.** Platia všeobecné zmluvné podmienky* **HU: TE IS NYERHETSZ.** Felhasználási feltételek érvényesek* **RO: Ai putea CÂȘTIGA.** Se aplică termeni și condiții* **BG: Можете да СПЕЧЕЛИТЕ.** Има определени правила и условия* **LV: Tu vari LAIMĒT.** Ir spēkā noteikumi un nosacījumi.* **ET: Sul on võimalus VÕITA.** Kehtivad tingimused* **LT: Jūs galite LAIMĖTI.** Taikomos sąlygos*
*LEGO.com/productfeedback-terms

LEGO and the LEGO logo are trademarks of the LEGO Group. ©2023 The LEGO Group.



© 2023 Mojang AB. All Rights Reserved. Minecraft, the Minecraft logo, the Mojang Studios logo and the Creeper logo are trademarks of the Microsoft group of companies.

6487188