



Booklet available in English on  
Heft in deutscher Sprache erhältlich auf  
Livret disponible en français sur  
Libretto disponibile in italiano su  
Folleto en español disponible en  
如需中文版手册, 请访问



[LEGO.com/sustainable-packaging](https://LEGO.com/sustainable-packaging)

## DISPLAY YOUR WAY



Display your reconfigurable model as a table centrepiece or use the two mounting brackets to hang it on your wall.



Combine two sets to create a four-spoked centrepiece, or three sets for a large six-spoke centrepiece (for table decoration only).



**DISCLAIMER:**  
The mounting brackets can support one set. Combined sets should not be mounted on walls.



## EVERLASTING CREATIVITY

🌿 Florists, interior designers and flower enthusiasts everywhere love getting creative with dried flowers. From delicate grasses to majestic petals, dried foliage makes such versatile décor for centrepieces, vase arrangements and wall art that can last for months, even years. With this latest addition to our LEGO® Botanical Collection, we hope you will feel inspired to turn your own 'LEGO everlastings' into a lush centrepiece in warm autumn colours.

Enjoy building!



**CHRIS McVEIGH**  
*Designer at the LEGO Group*

## PLANTS FROM PLANTS

»»» 'Fresh flowers are nature's gifts. There is so much beauty in preserving them, giving them lasting life, and celebrating them as works of art. But did you know that your LEGO® dried flower art also has elements made from plant-based plastic?'

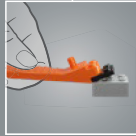
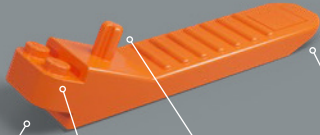

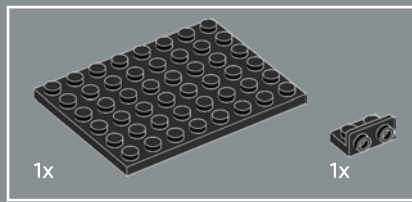

1

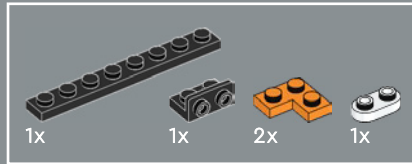
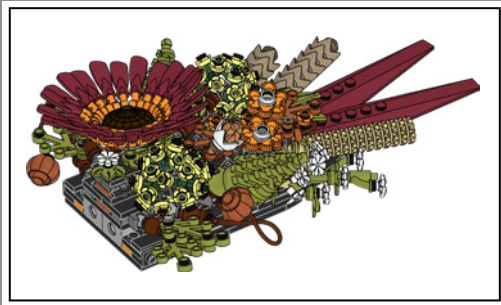
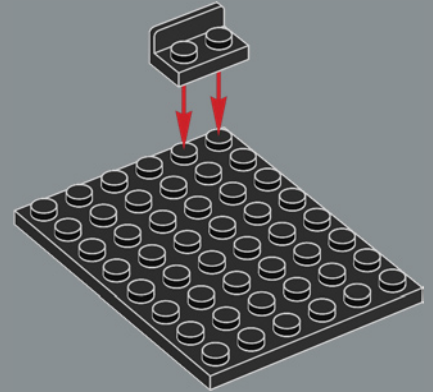

2

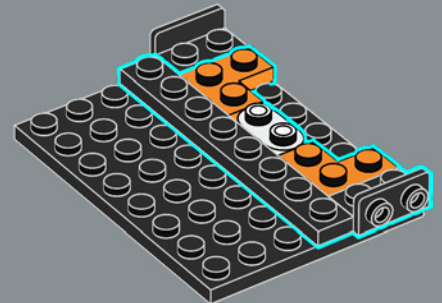

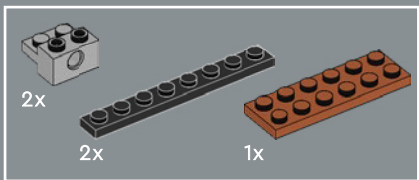

3

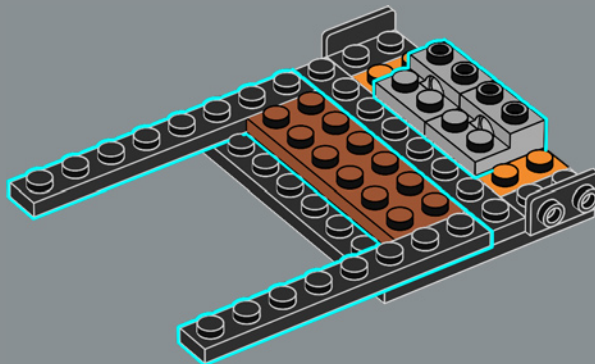

4

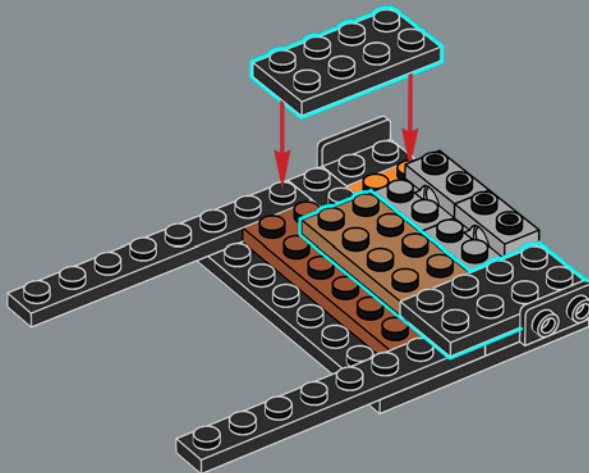



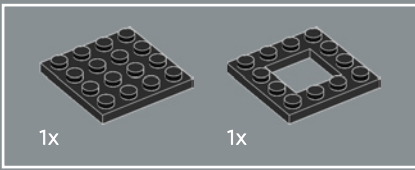

5

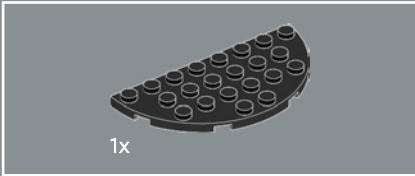
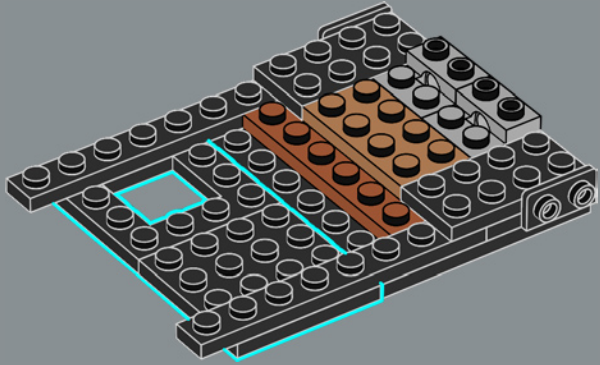

6

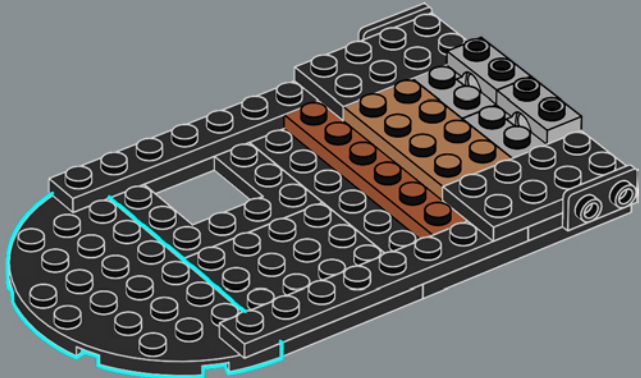

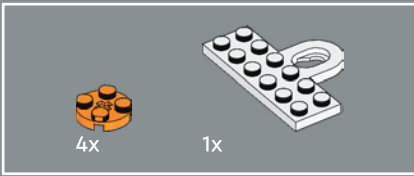

7



Built into each side of the model is a 2×6 plate with a mounting bracket so you can hang your decoration on a wall. This special element first appears in DOTS products.

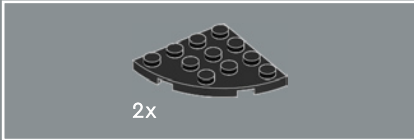
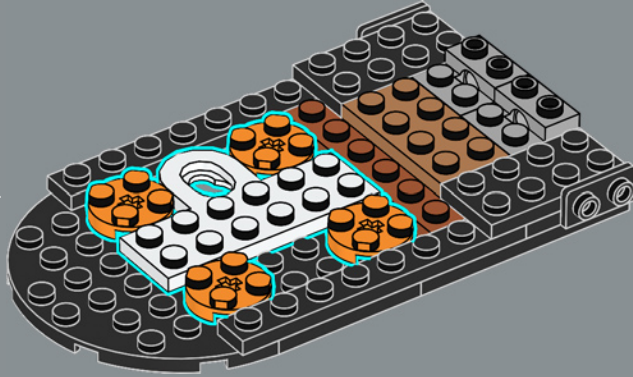

8

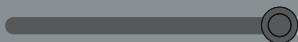
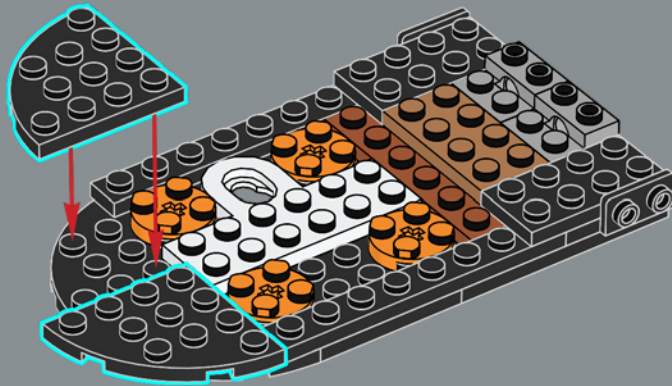

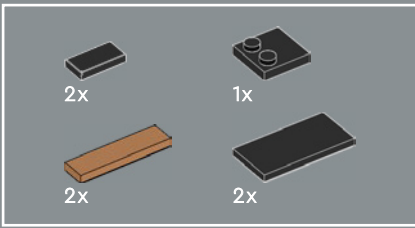

9

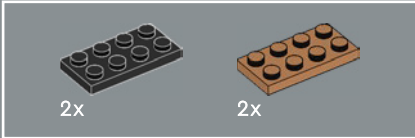
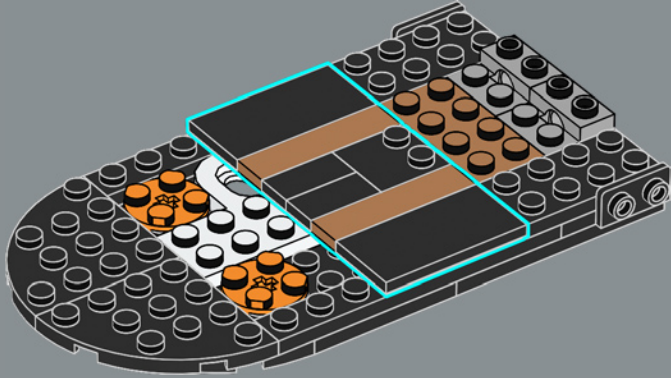

10

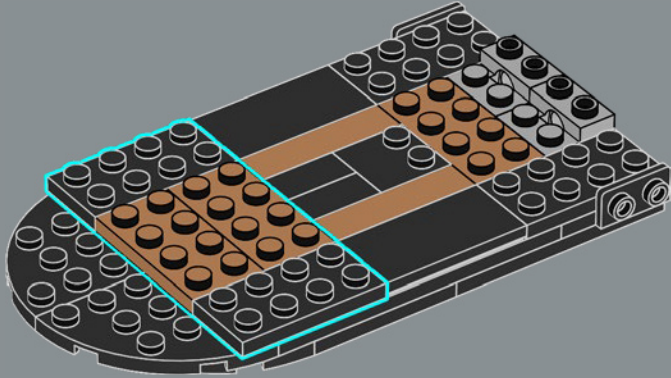

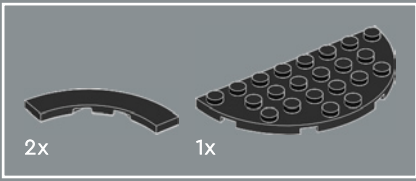

11

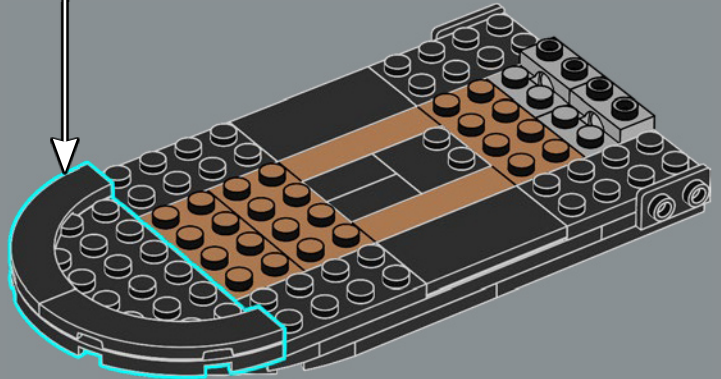
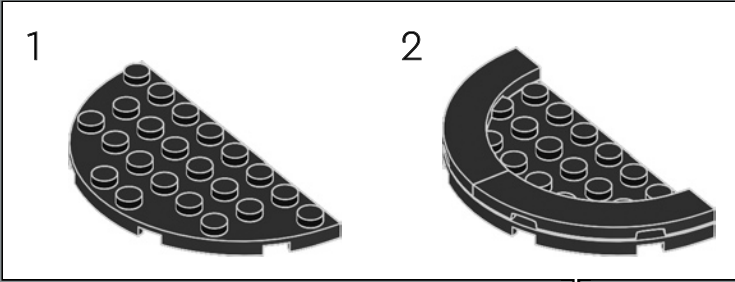

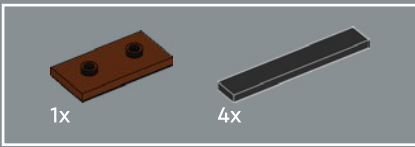

12

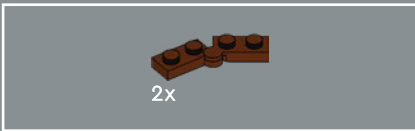
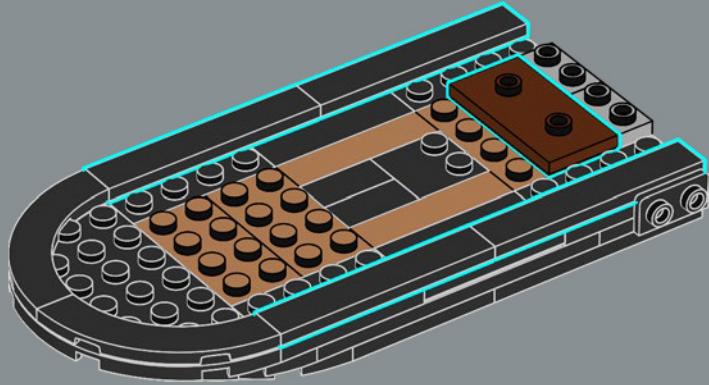

13

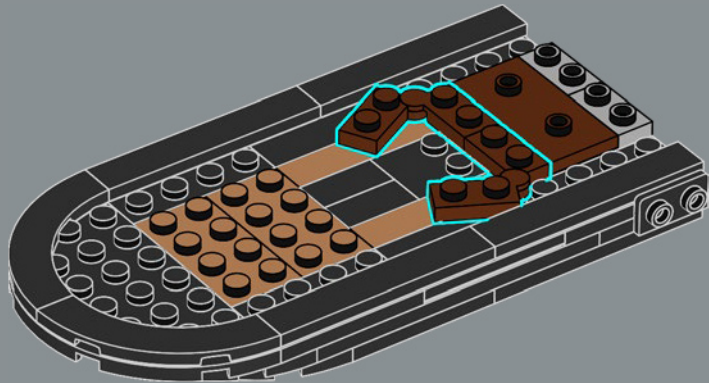

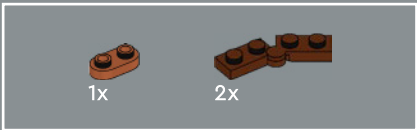

14

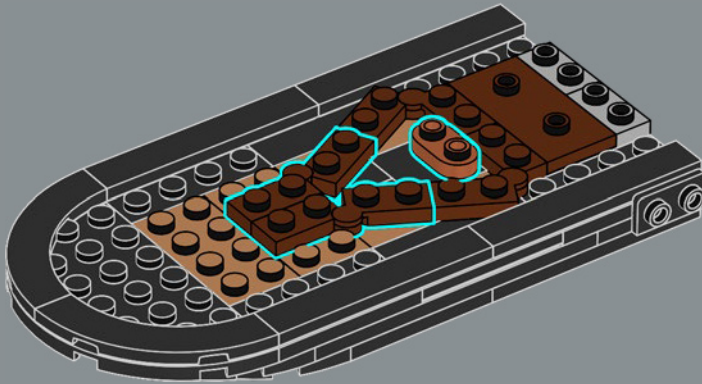

15



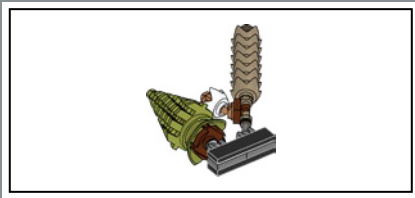

16

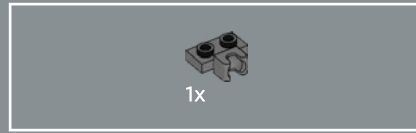
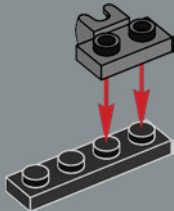

17

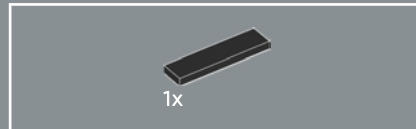
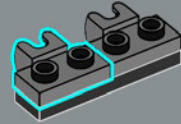

18

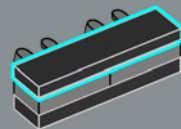



19

1



2



3

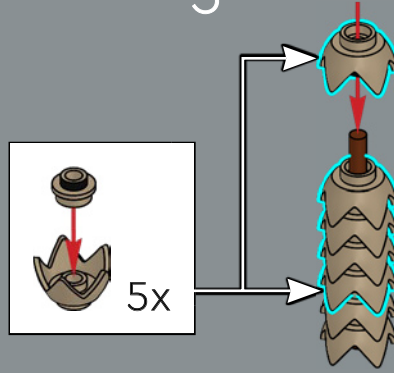

4







5

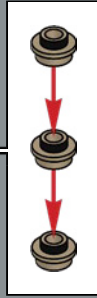

1x



1x



1x



1x

20

1



2



3

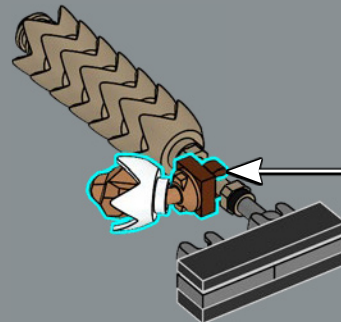
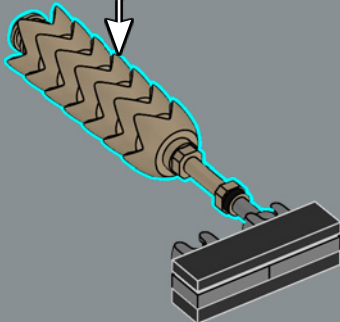

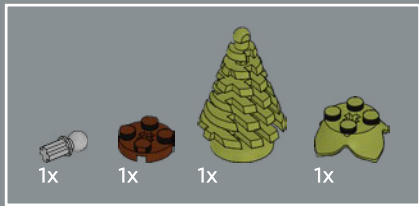

21

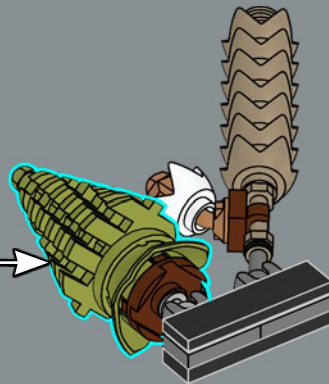
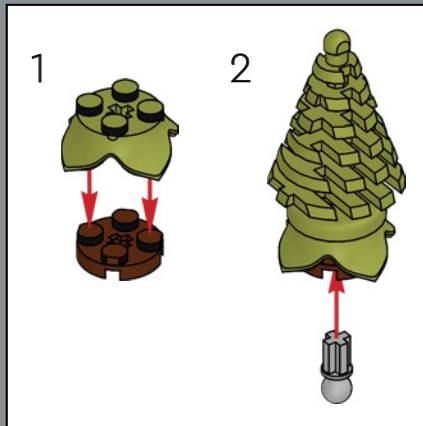

22

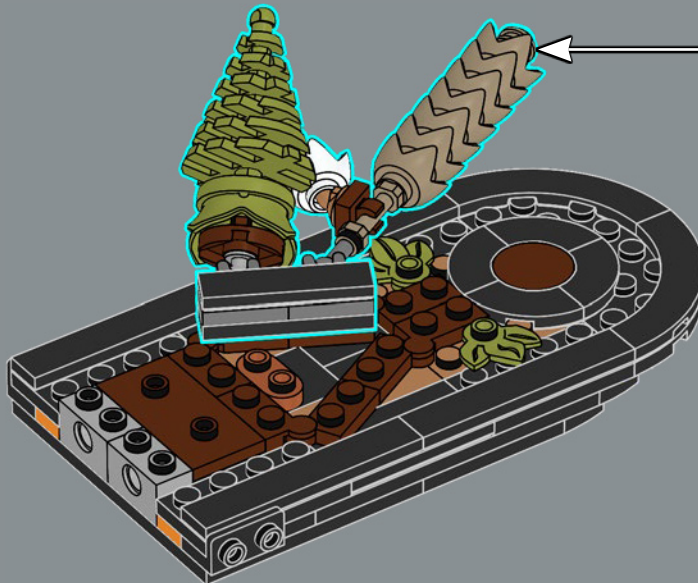

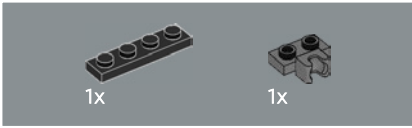
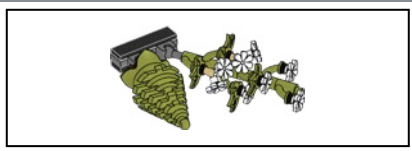

23

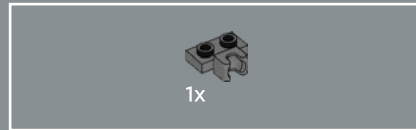
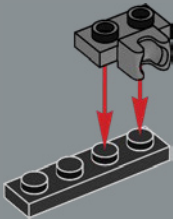

24

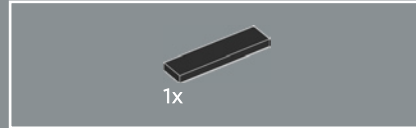
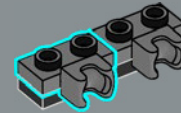

25

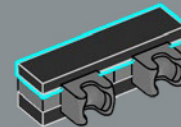



26



27

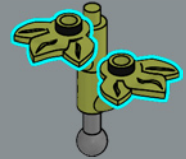

28

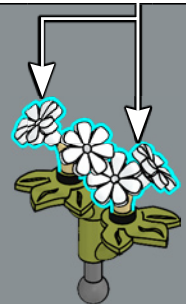
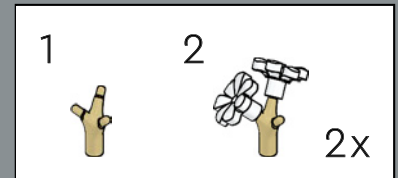



29

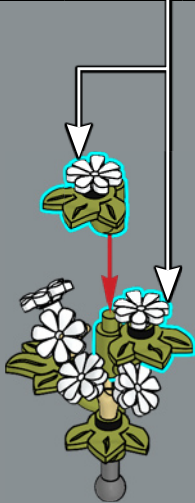
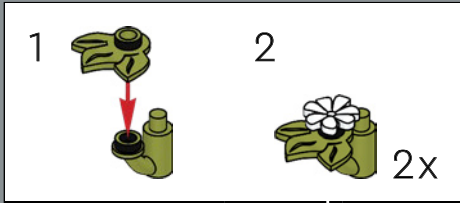

30

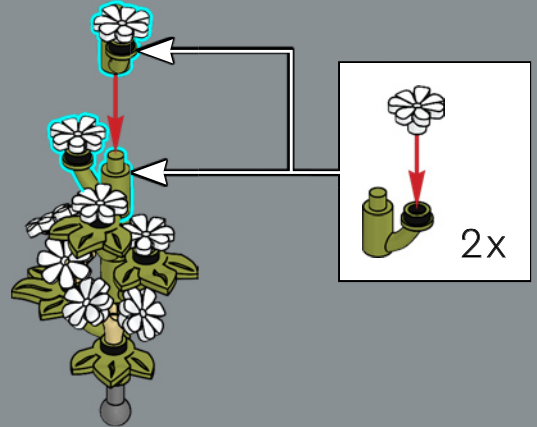

31

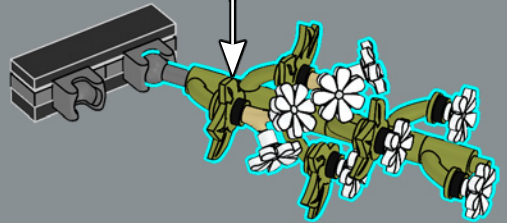

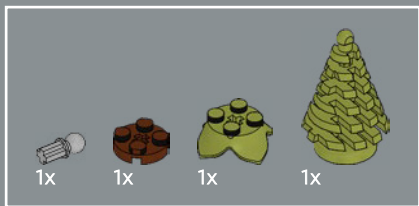

32

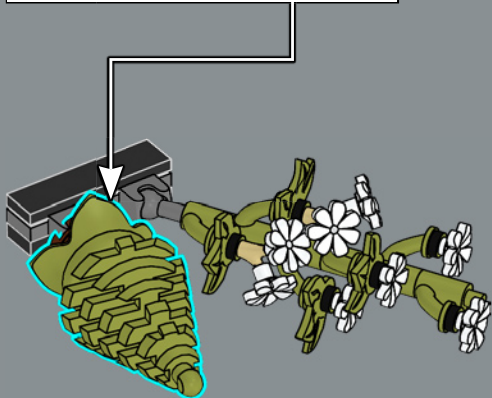
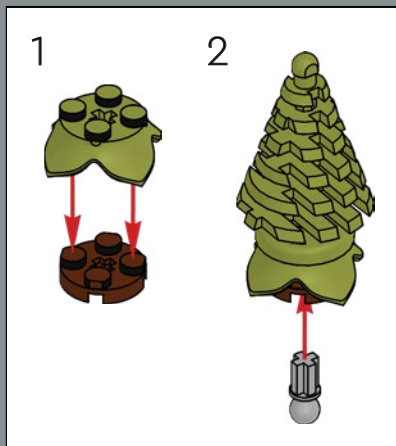

33

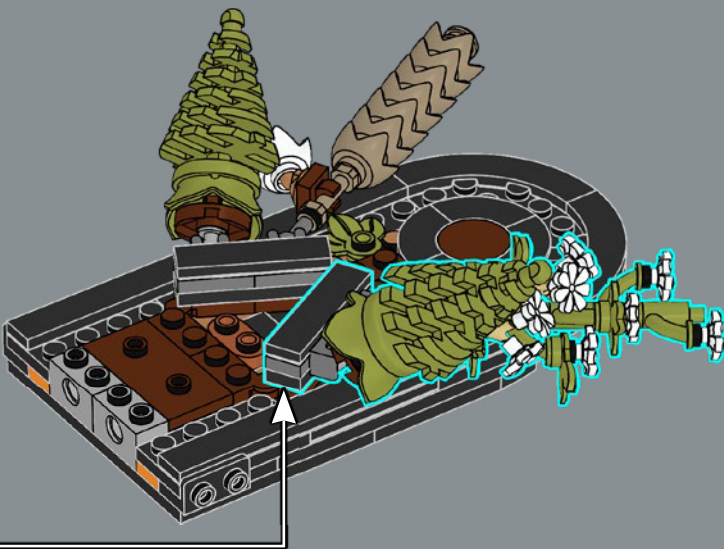

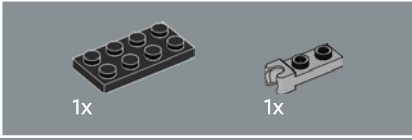
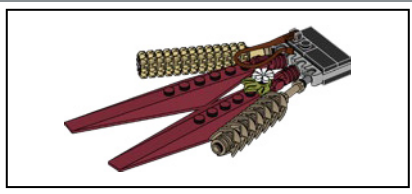

1x

1x

34

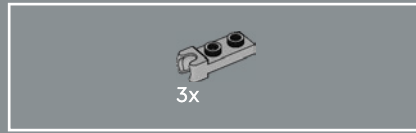
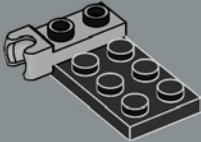

3x

35

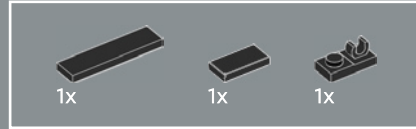
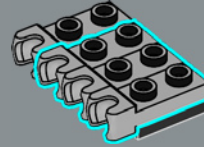

1x

1x

1x

36

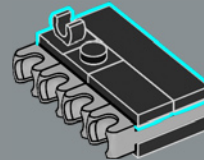

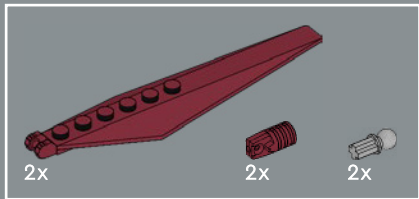

37

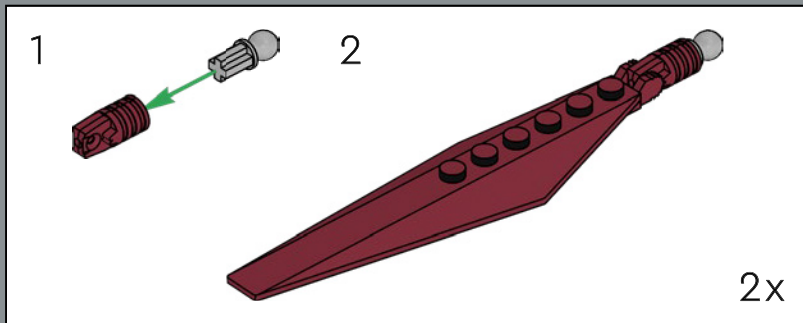

38

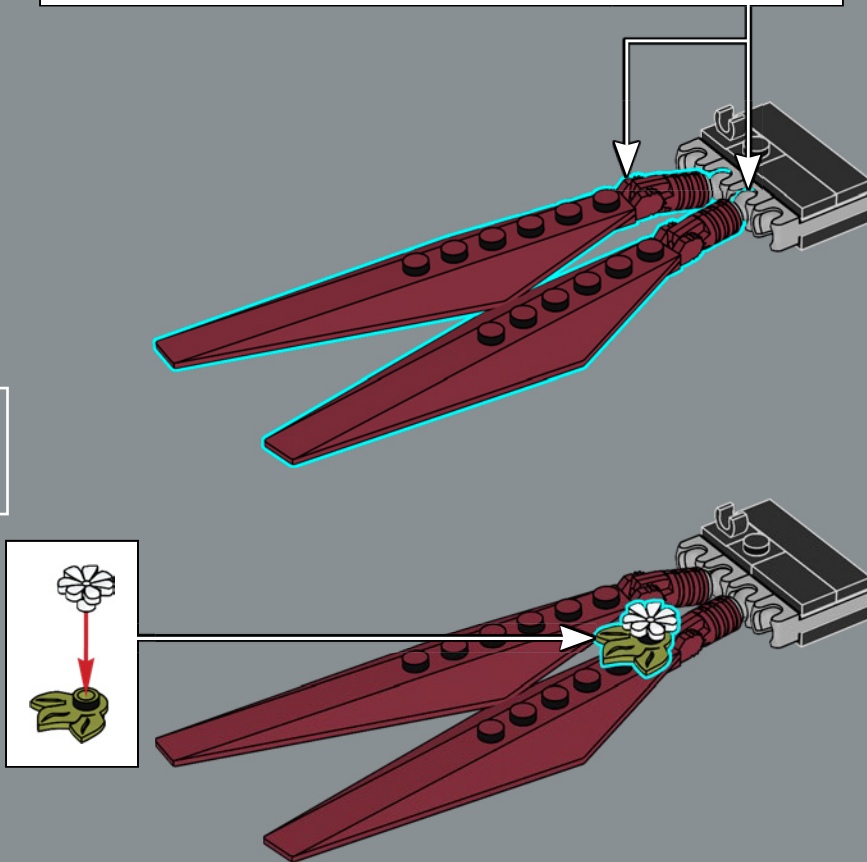



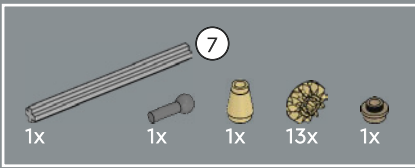

39

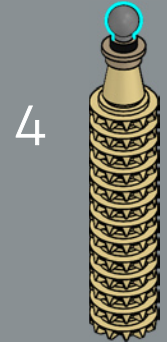
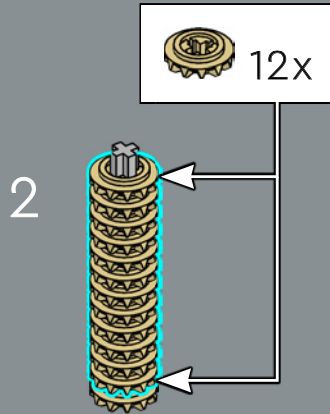
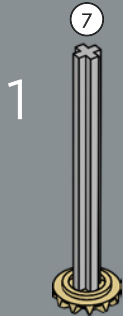

The detailed texture of the pearl millet stalks is created with a stack of conical wheels (gears).

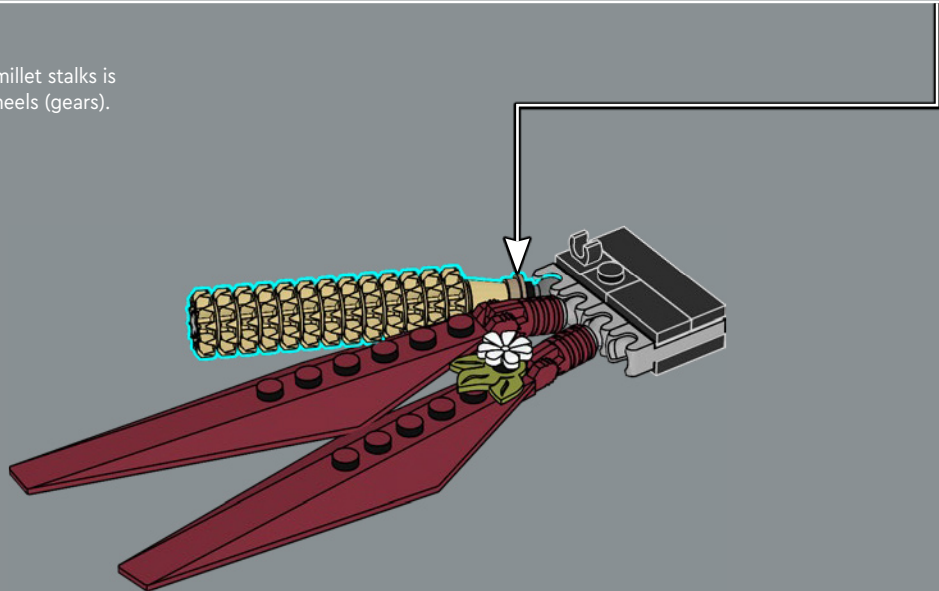



40

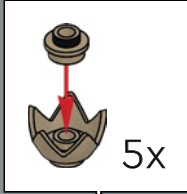
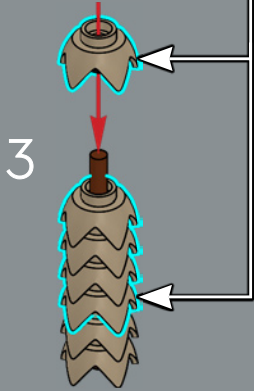
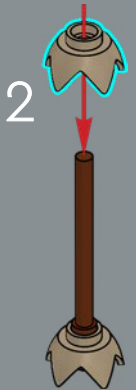
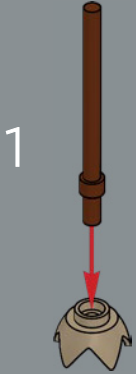

5

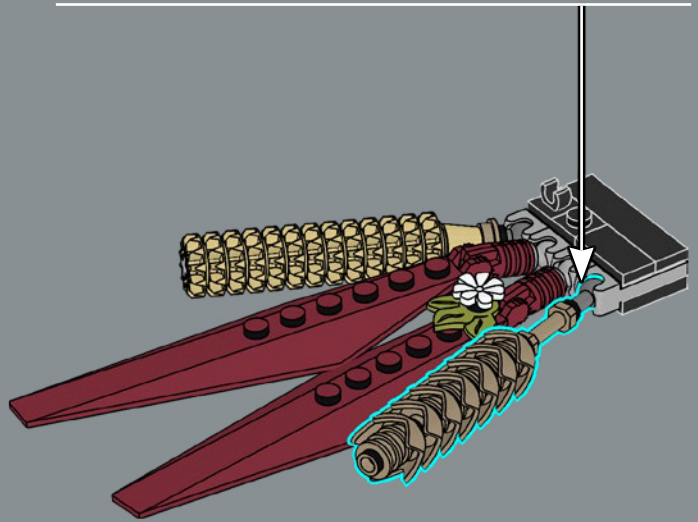
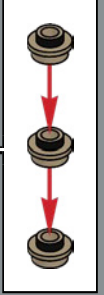



41

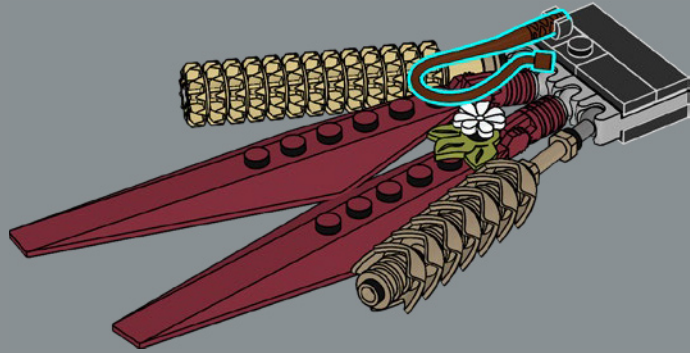

42

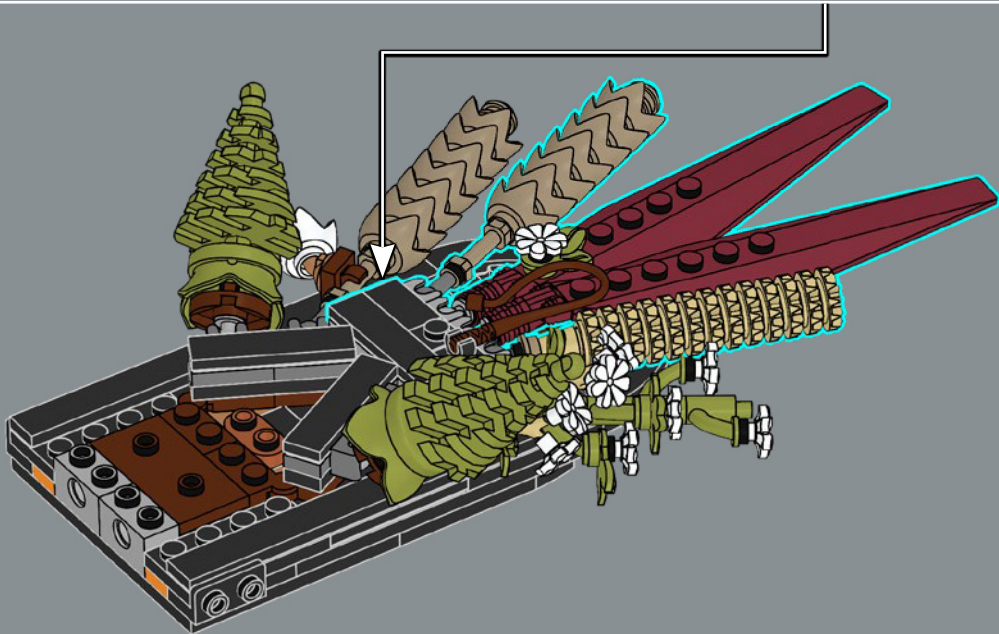

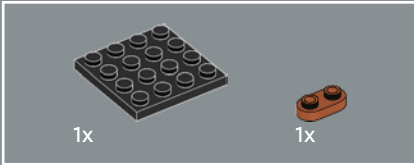
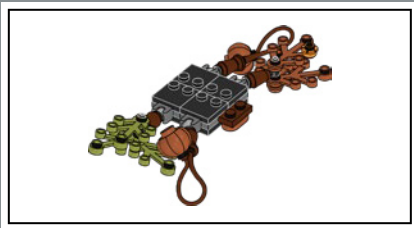

43

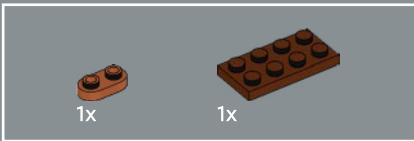
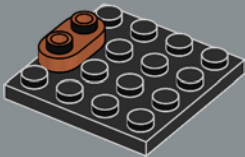

44

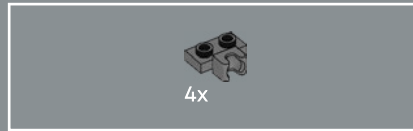
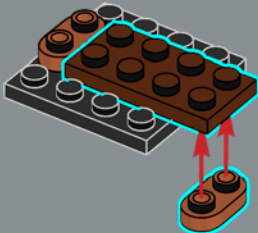

45

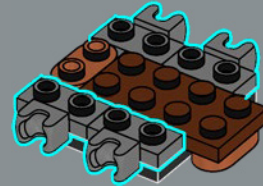

46

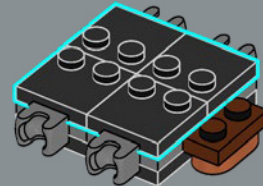



47

1

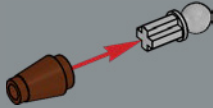

2

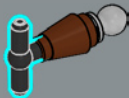

3

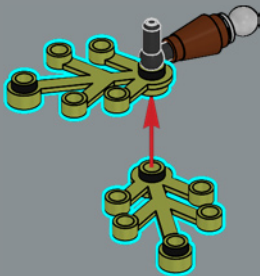

4

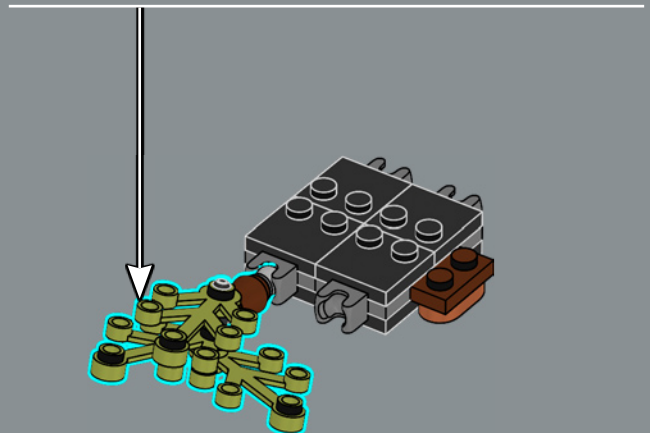
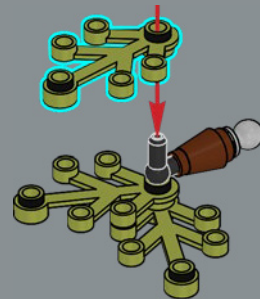

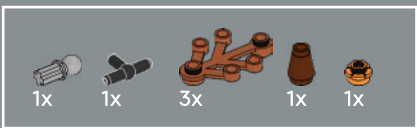

48

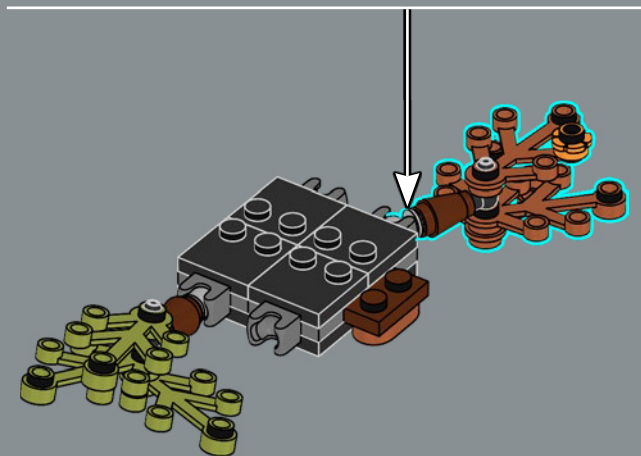
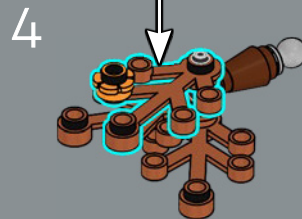
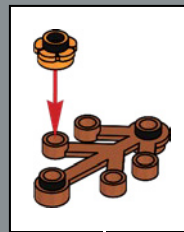
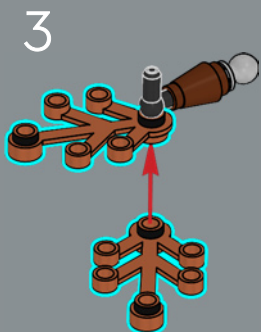
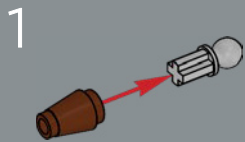



49

1

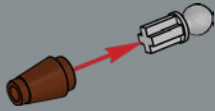

2

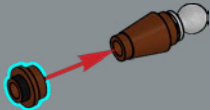

3



4



2x

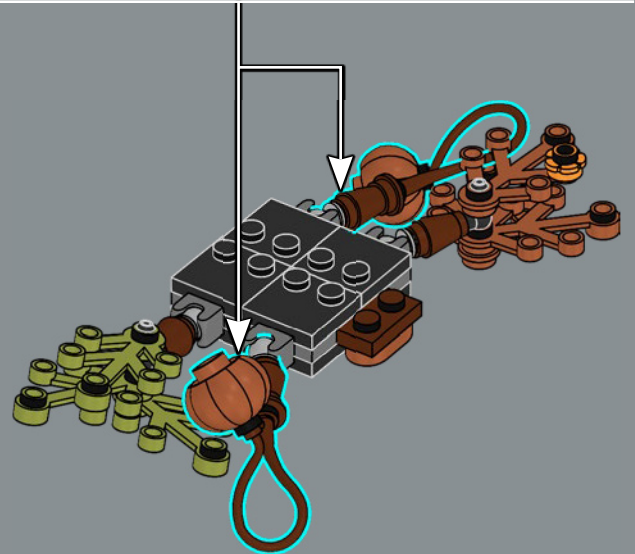

50

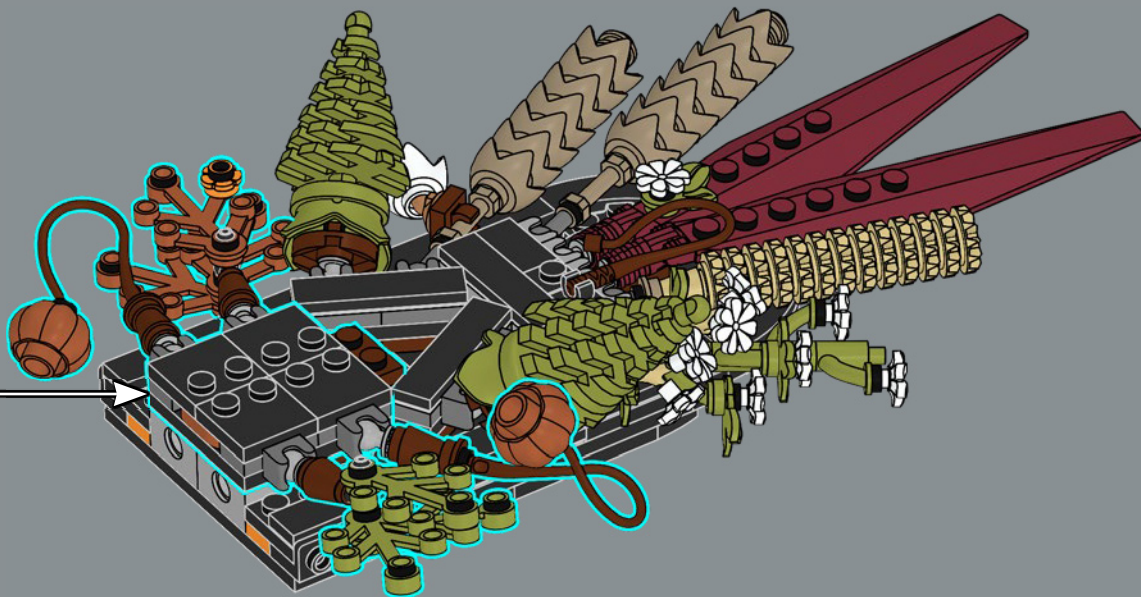



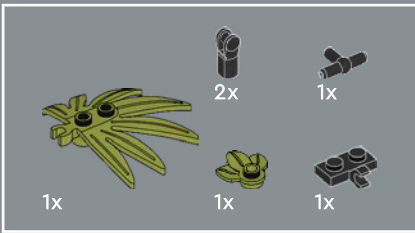

51

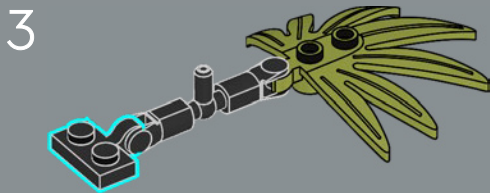
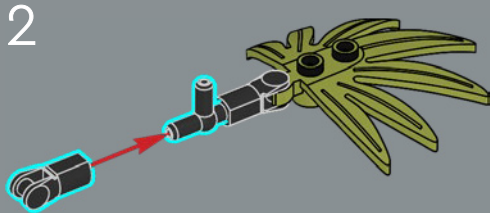
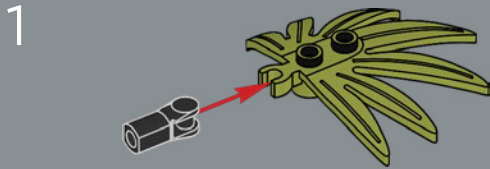

4

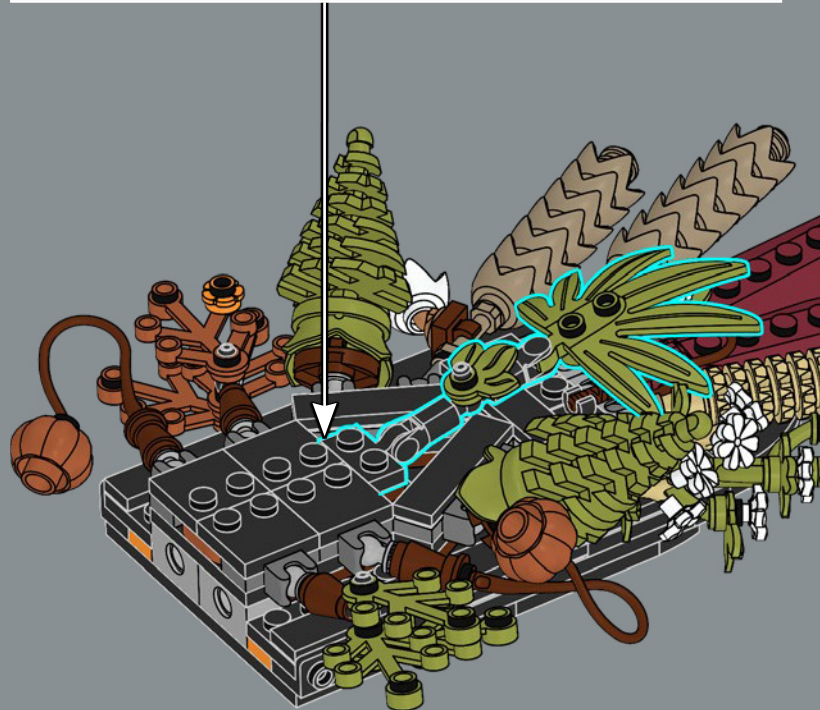
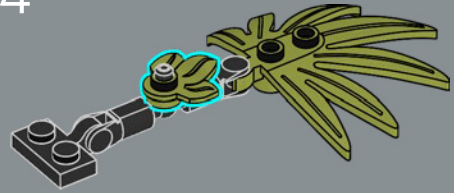



52

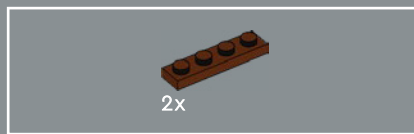
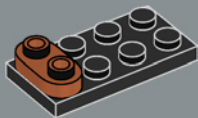

53

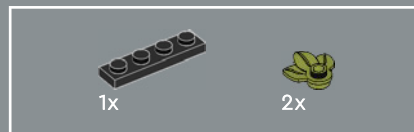
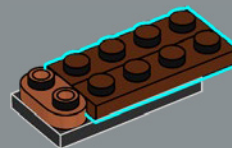

54

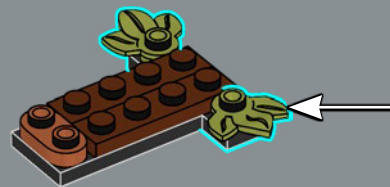
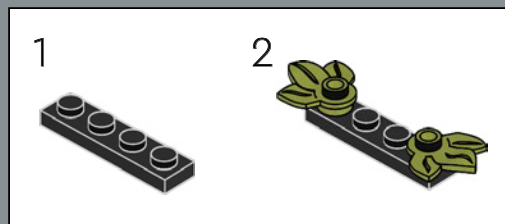

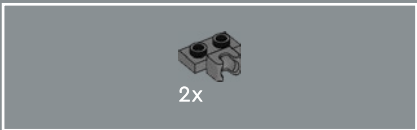

55

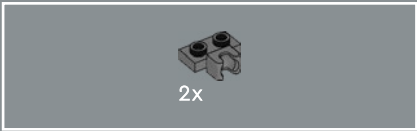
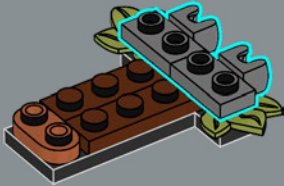

56

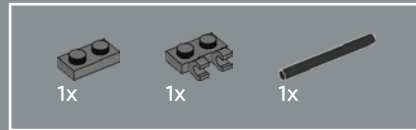
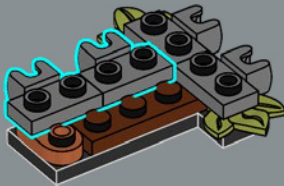

57

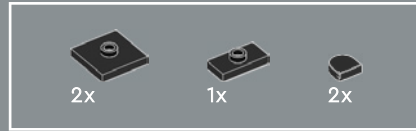
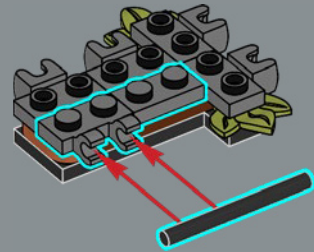

58

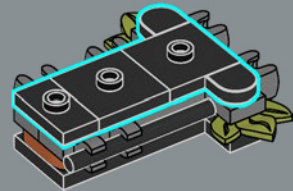

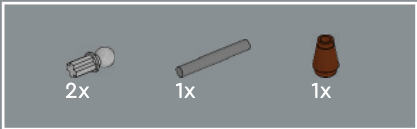

59

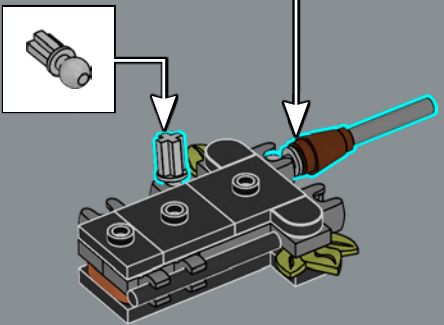
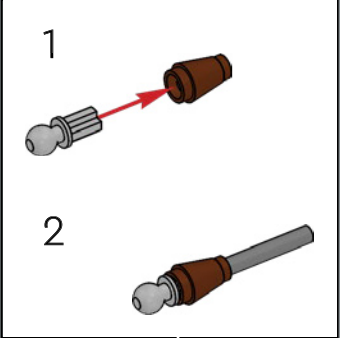

60

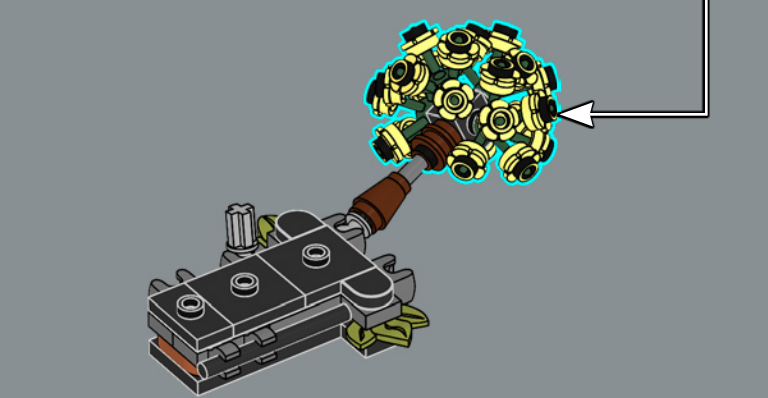
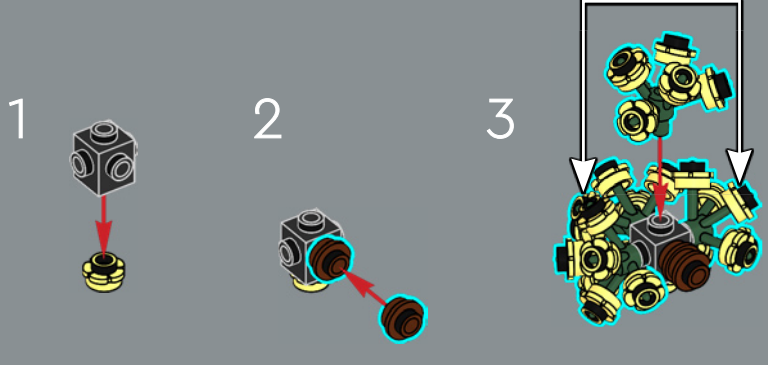
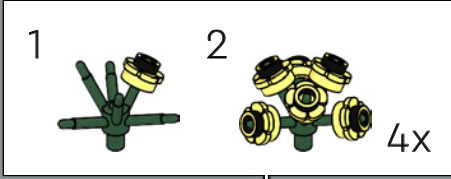

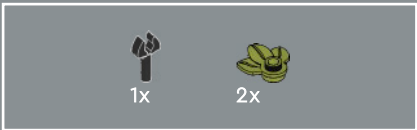

61

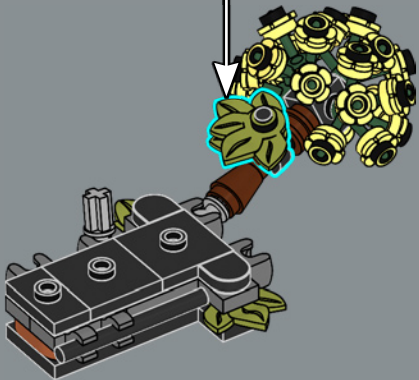
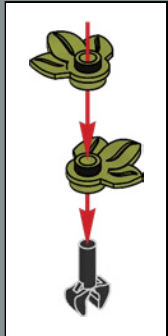

62

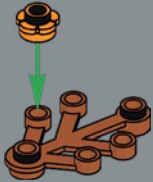

63





64

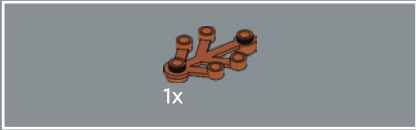
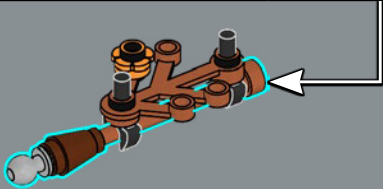
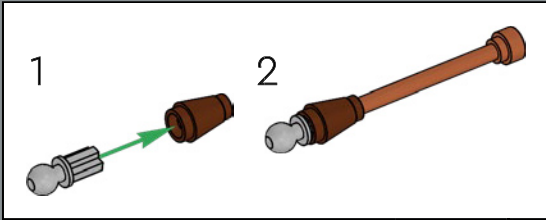

65

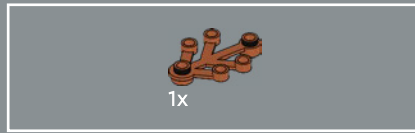
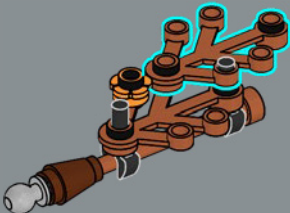

66

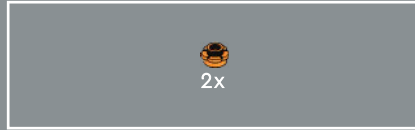
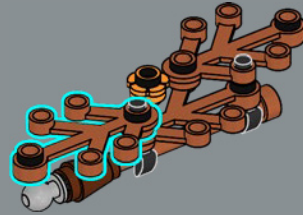

67

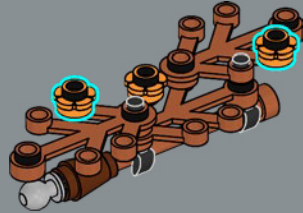



68

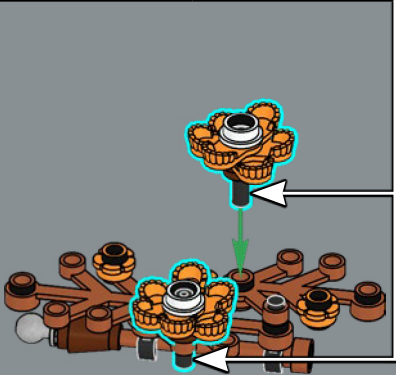
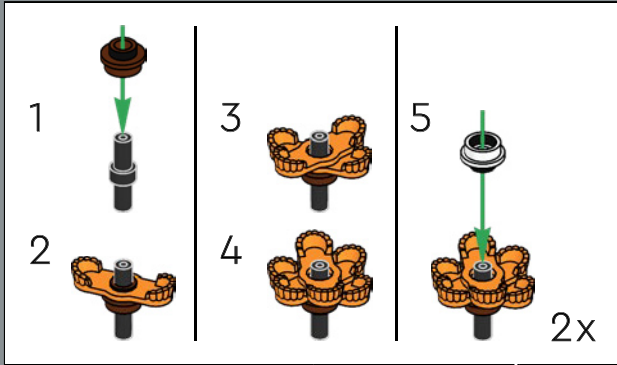

These small orange cosmos are made with a classic minifigure element: the epaulet, first used for Pirate theme Imperial Soldiers in 1989.



69

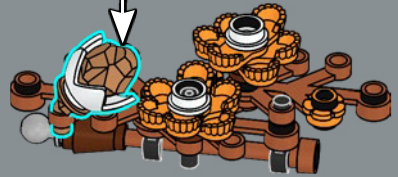
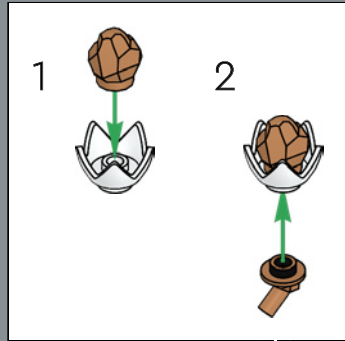

70

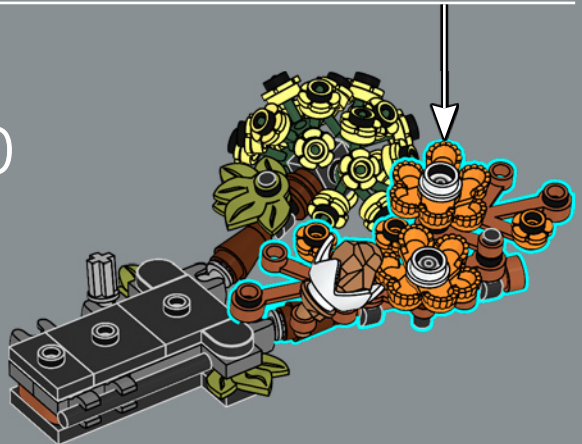



71

1

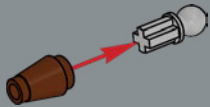

2



3

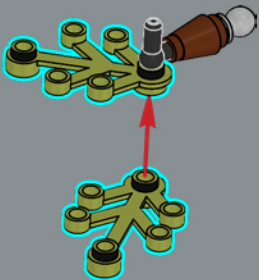

4

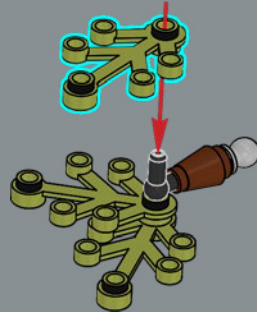



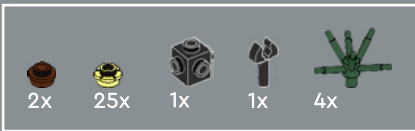

72

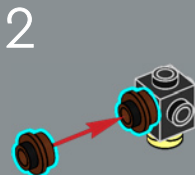
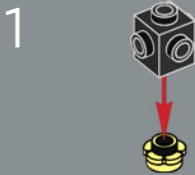

4

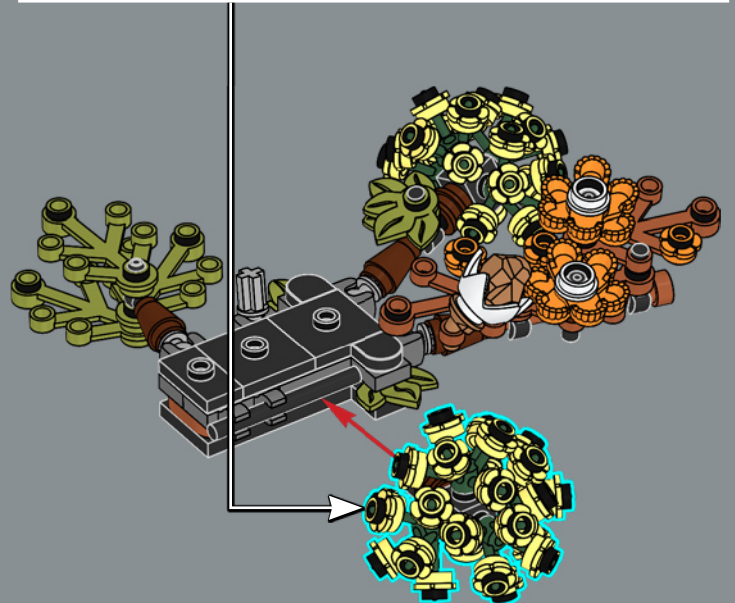
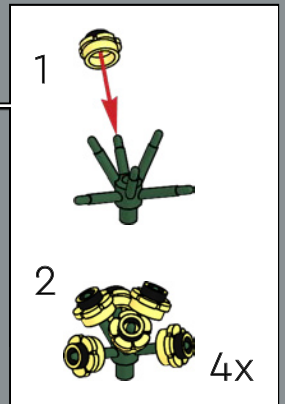
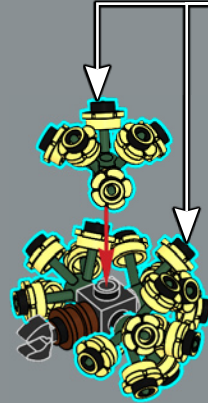

73





1x



3x

74

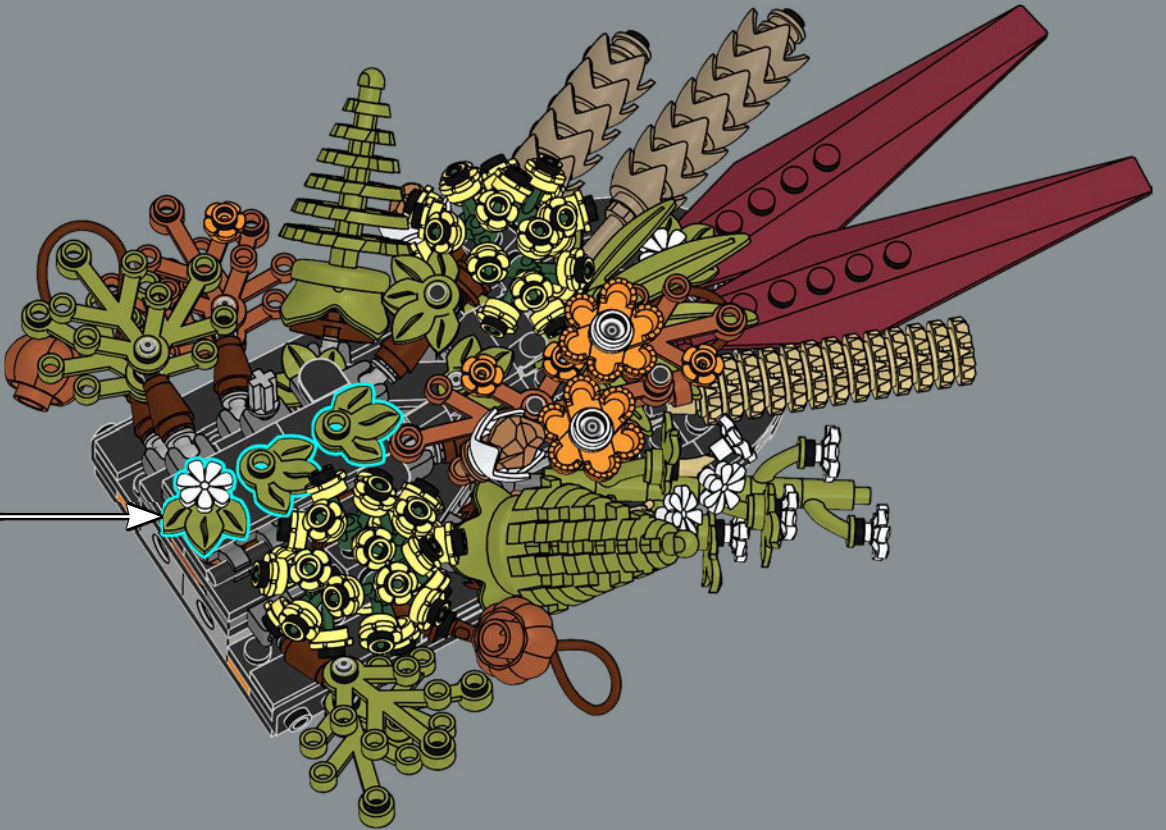
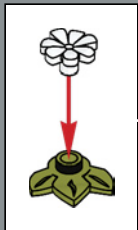

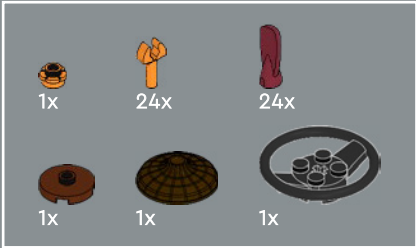
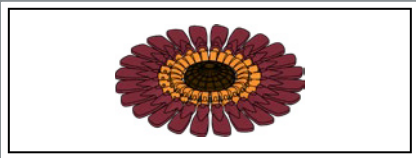

75

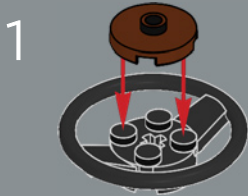

3

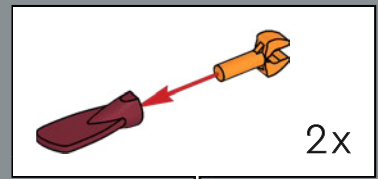
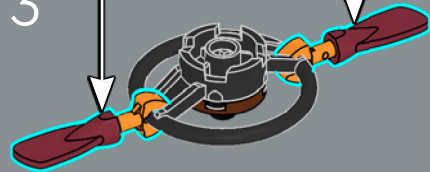

2x



4

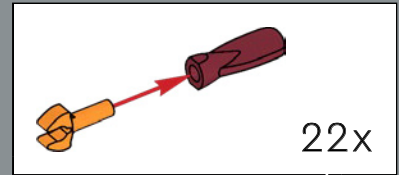
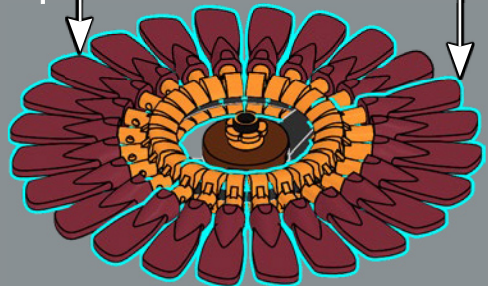

22x



5

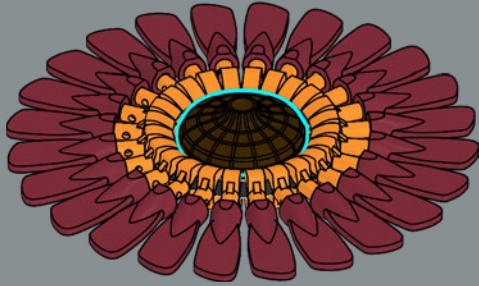

As you put together the dark red gerbera, notice that its petals are made of minifigure oar elements. It also uses a minifigure hat for the disc floret.

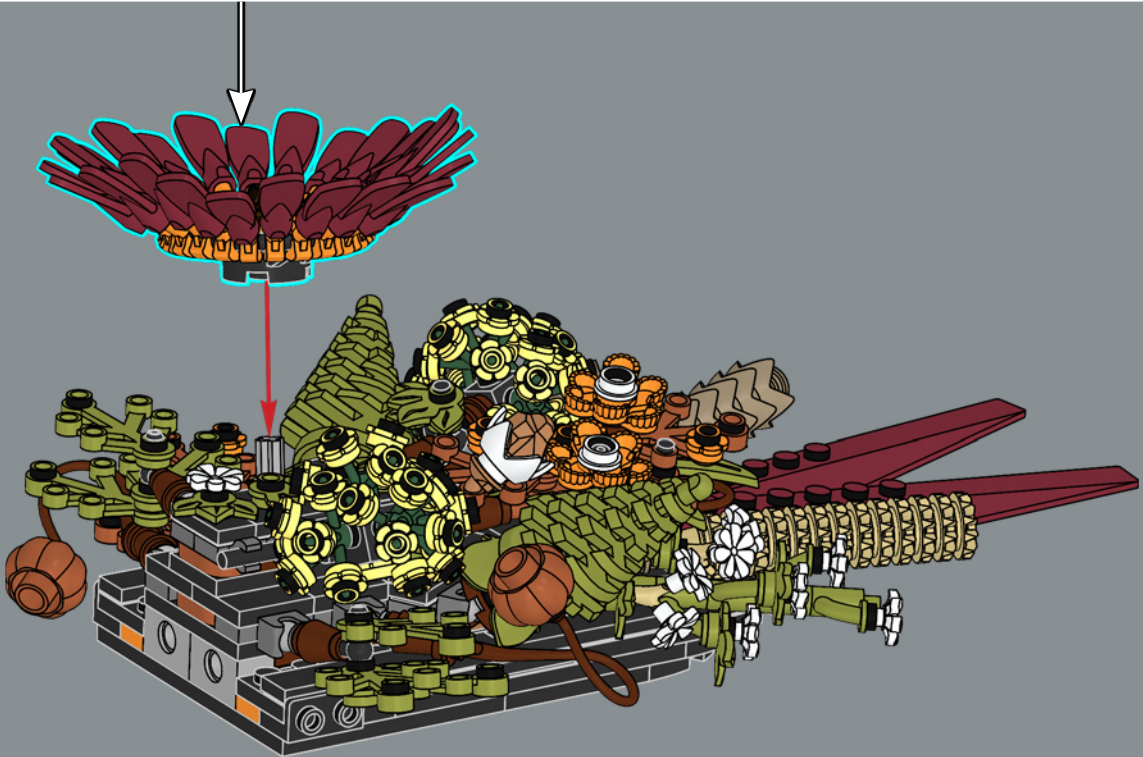

76

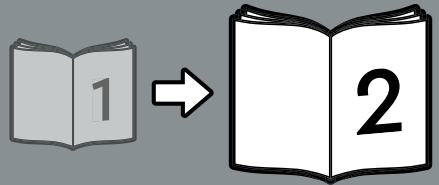
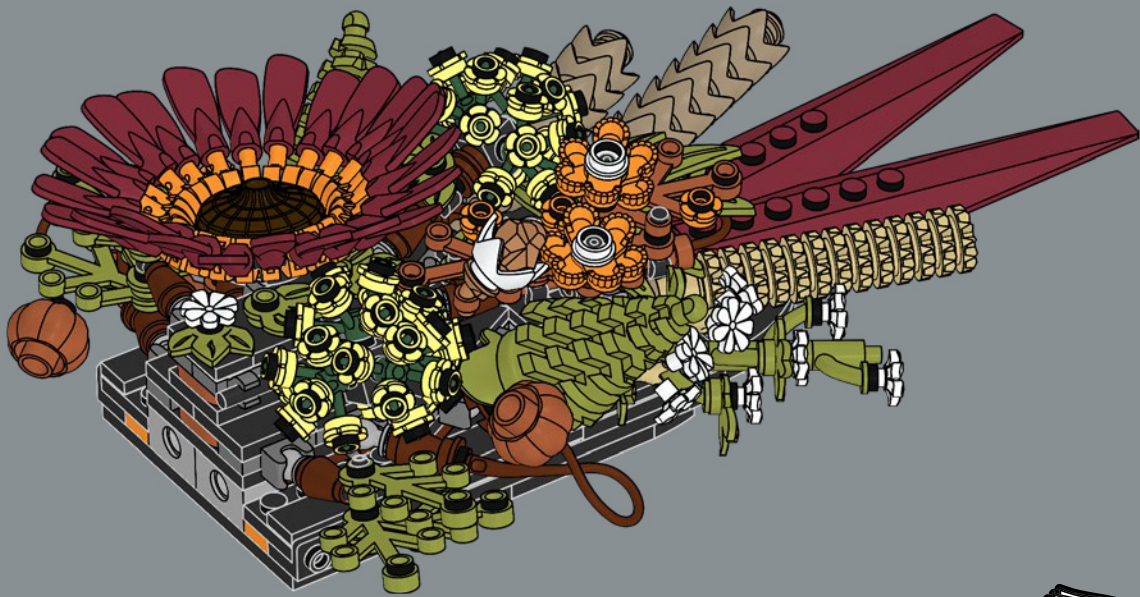



# YOU COULD WIN



## YOU COULD WIN

Your feedback will help shape the future development of this product series.

Visit:

## DU KÖNNTEST GEWINNEN

Dein Feedback trägt zur Weiterentwicklung dieser Produktreihe bei.

Geh auf:

## VOUS POURRIEZ GAGNER

Vos commentaires nous aideront à concevoir les futurs produits de cette gamme.

Visitez :

## POTRESTI VINCERE TU

La tua opinione ci aiuterà a migliorare la creazione futura di questa linea di prodotti.

Visita:

## PUEDES GANAR

Tu opinión contribuirá al futuro de esta serie de productos.

Visita:

## 轻松获奖

您的反馈将有助于我们在今后改进本产品系列。

请访问：

---

# LEGO.com/productfeedback

---

You also have the chance to win a LEGO® set.

Terms and conditions apply.\*

Außerdem hast du die Chance, ein LEGO® Set zu gewinnen.

Es gelten die Teilnahmebedingungen.\*

Vous pourriez également gagner un ensemble LEGO®.

Des conditions s'appliquent.\*

Hai anche la possibilità di vincere un set LEGO®.

Termini e condizioni sono applicabili.\*

También tienes la oportunidad de ganar un set LEGO®.

Aplican términos y condiciones.\*

您还有机会赢取乐高®套装。

条款和条件适用。\*

\*[LEGO.com/productfeedback-terms](https://www.lego.com/productfeedback-terms)

GROW YOUR  
COLLECTION  
OF LEGO®  
BOTANICAL  
MODELS



**10280**  
Flower Bouquet



**10311**  
Orchid



**10313**  
Wildflower Bouquet



**10281**  
Bonsai tree



6x  
6168642



2x  
6210272



24x  
6338913



4x  
6259700



2x  
6378415



2x  
4529237



4x  
6347292



6x  
6324176



26x  
4565452



4x  
6431730



4x  
6330588

50



1x  
6391341



2x  
370126



2x  
6267487



6x  
306926



2x  
302326



2x  
6092585



10x  
6192346



2x  
4565323



2x  
6133722



6x  
243126



6x  
371026



4x  
4560182



12x  
302026



2x  
6350415



4x  
6347310



2x  
6313116



4x  
6020193



1x  
6350725



4x  
6256435



4x  
6210270



12x  
663626

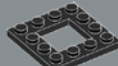

2x  
6058118

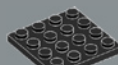

4x  
4243819



7x  
346026

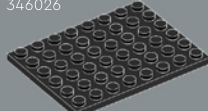

2x  
303626



2x  
4514845



4x  
287726



4x  
473326



6x  
6371584



2x  
6116604



6x  
6321194



8x  
6278152



4x  
6279875



8x  
6104209



8x  
6191630



3x  
6325190



1x  
6299938



4x  
6171264



4x  
6101857



4x  
6133200



8x  
6369194



13x  
6022079



2x  
6400293



3x  
6426472



1x  
6074892



2x  
6219673



2x  
4177932



4x  
6106027



8x  
6030521



8x  
6214234



18x  
6426228



24x  
6278159



1x  
6149656

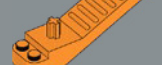

1x  
6240515

15x  
6426470

4x  
6285465

31x  
6398008

4x  
6426468

4x  
6426464

10x  
6268815

2x  
6313102

2x  
6348057

4x  
6313124

14x  
4529242

4x  
6172922

1x  
6257604

3x  
4211190

2x  
6307618

2x  
4211186

17x  
6215659

2x  
6075213

4x  
4211159

1x  
6102360

4x  
6170468

5x  
6359864

8x  
6416695

2x  
4211440

4x  
6326478

8x  
6043639

22x  
4211375

2x  
4211805

1x  
4211063

2x  
6388119

23x  
6146792

2x  
6350292

2x  
6310596

9x  
6364352

100x  
6426463

1x  
6384238

1x  
6384589

1x  
6416732

4x  
6431549

16x  
6398343

4x  
6102998

6x  
6093494

2x  
6347304

1x  
6177189

4x  
6400315

4x  
6432504

2x  
6299413

34x  
6300322

28x  
6431686

24x  
6426473

4x  
6431687

4x  
6426471

7

 [LEGO.com/service](https://www.LEGO.com/service)

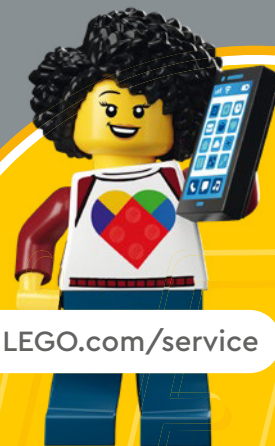



6487193



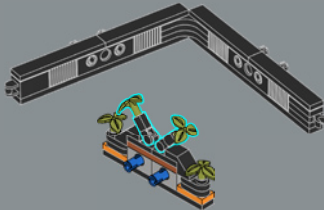
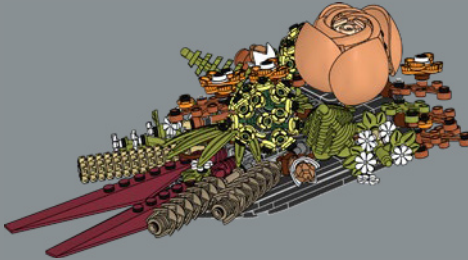
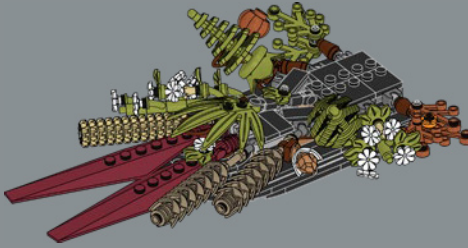

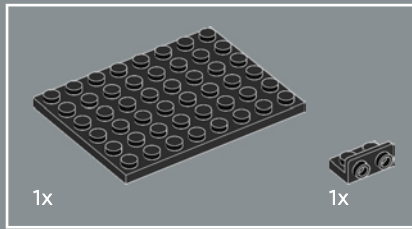

77

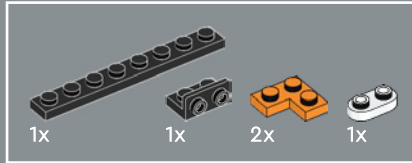
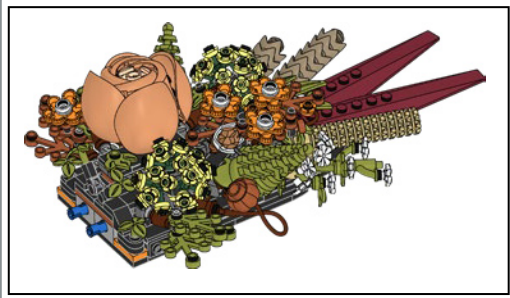
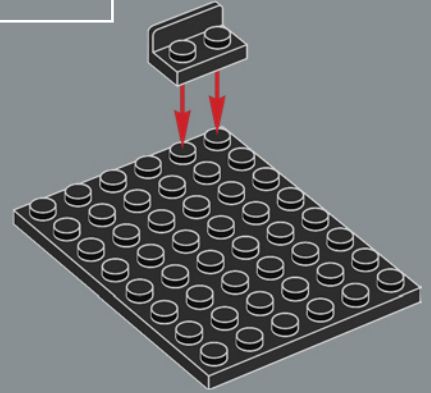

78

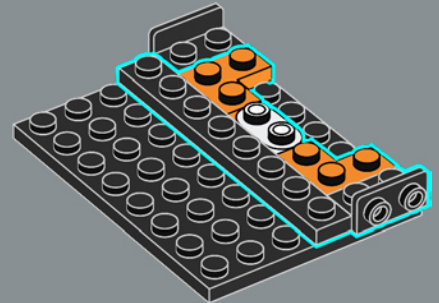

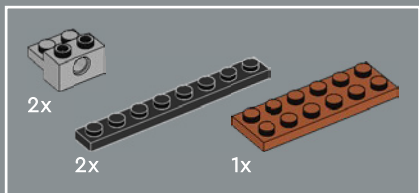

79

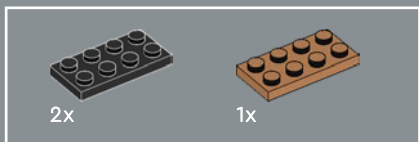
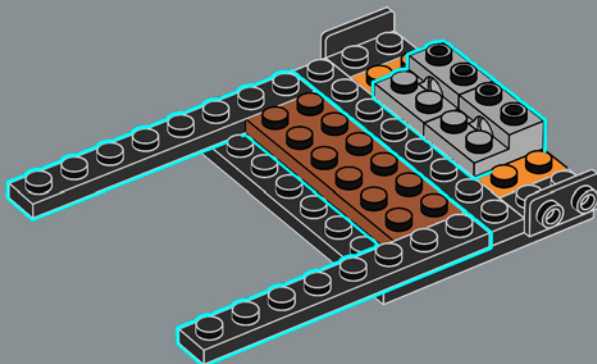

80

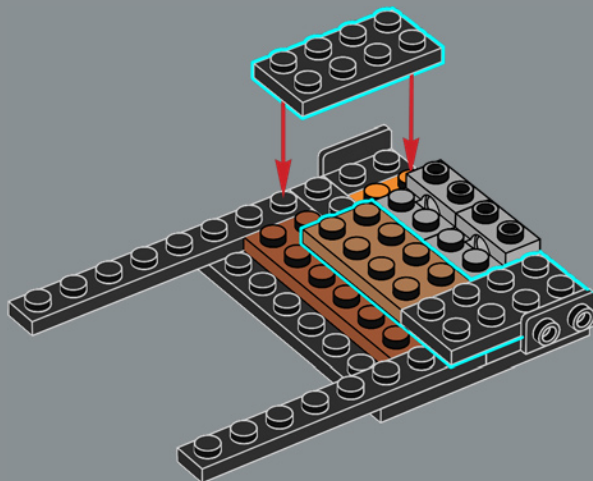



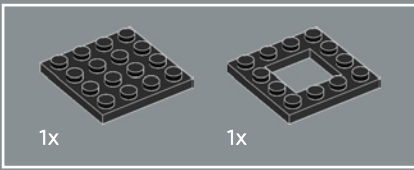

81

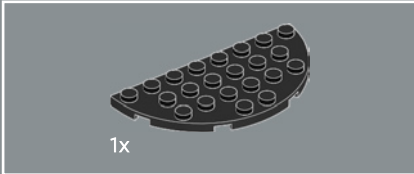
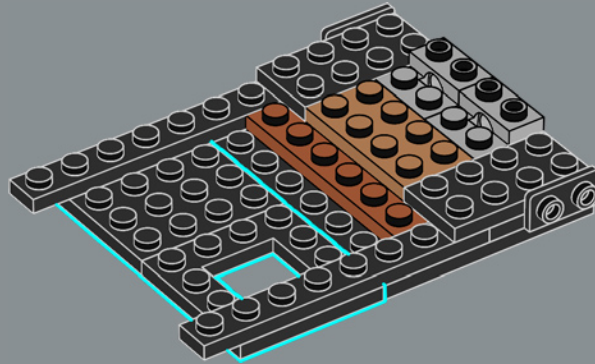

82

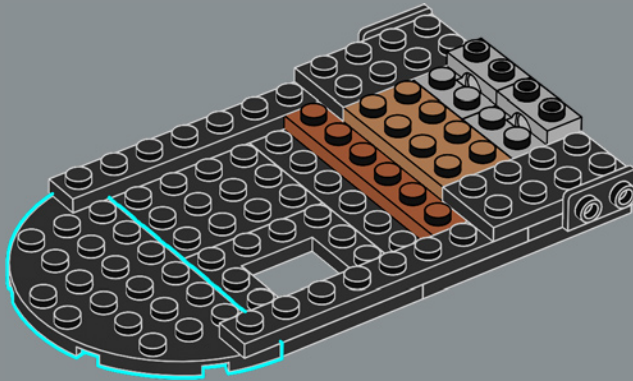

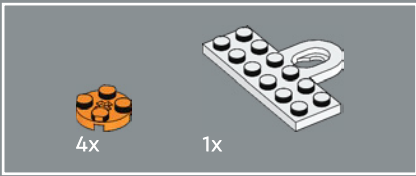

83

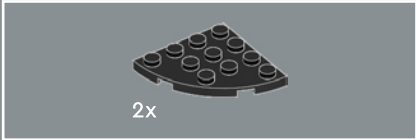
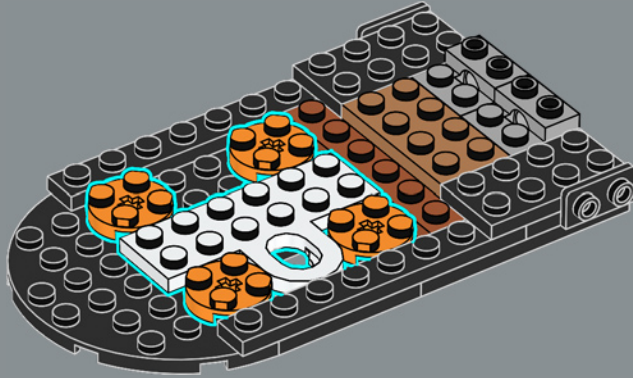

84

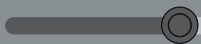
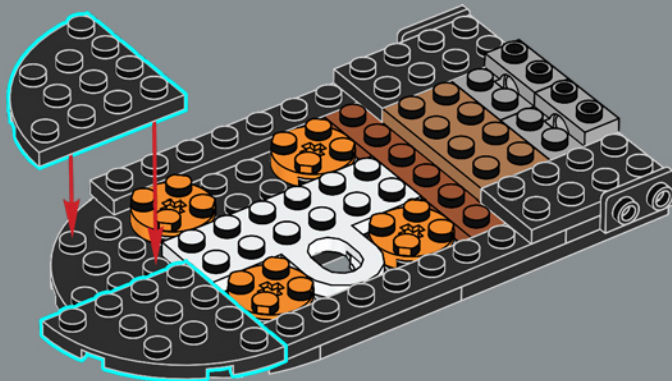

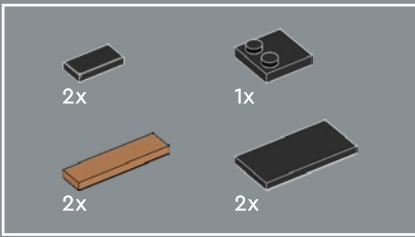

85

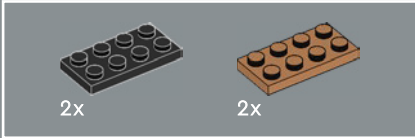
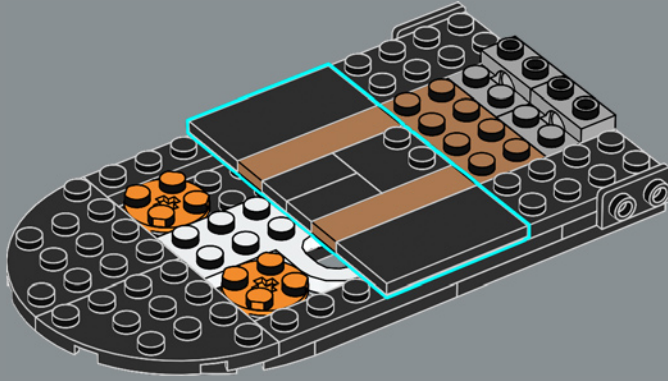

86

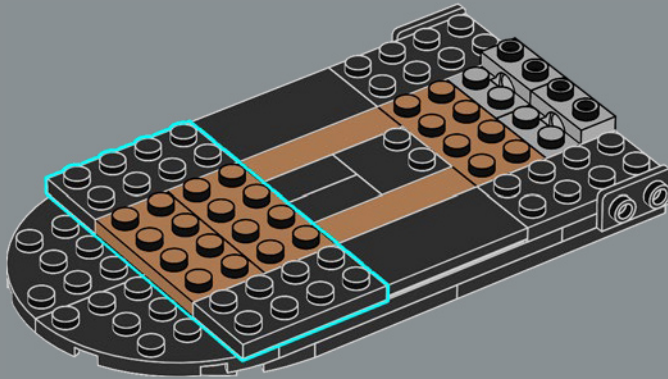

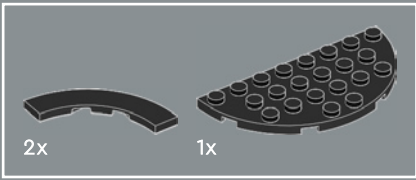

87

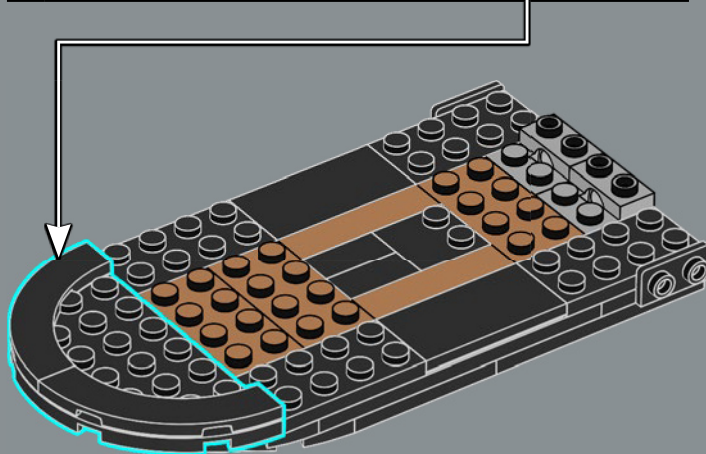
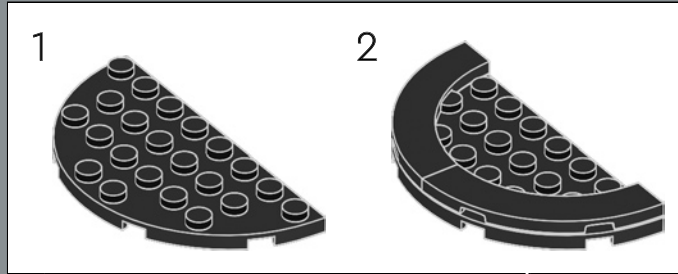

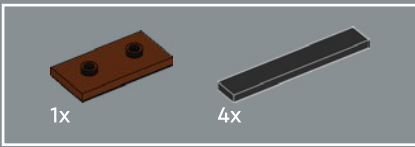

88

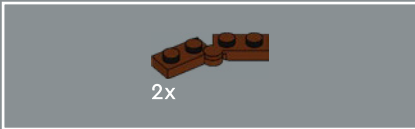
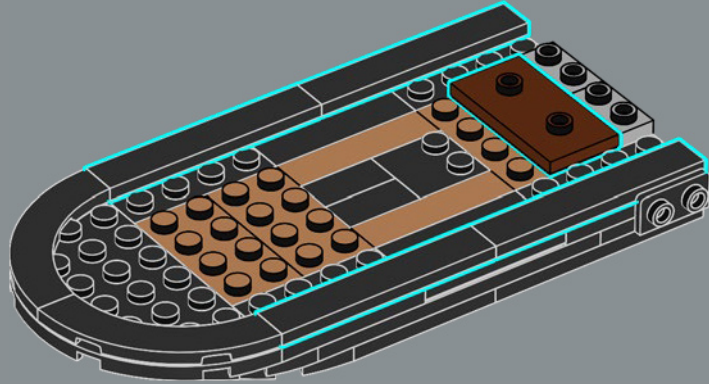

89

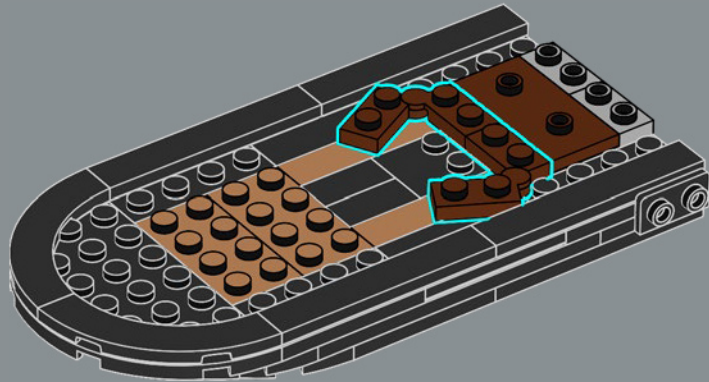

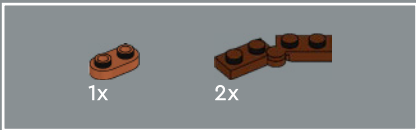

90

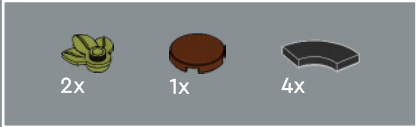
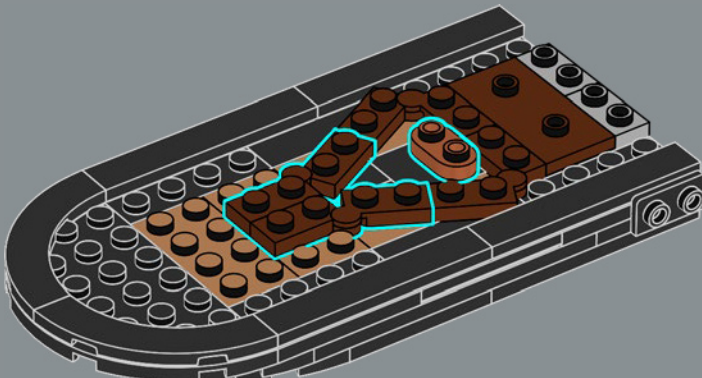

91



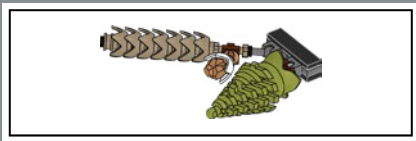

1x

1x

92

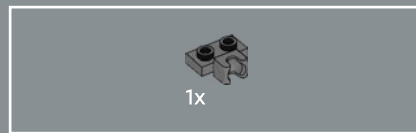
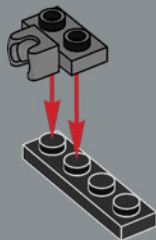

1x

93

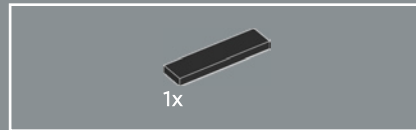
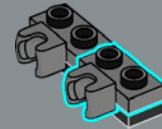

1x

94

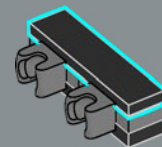



95

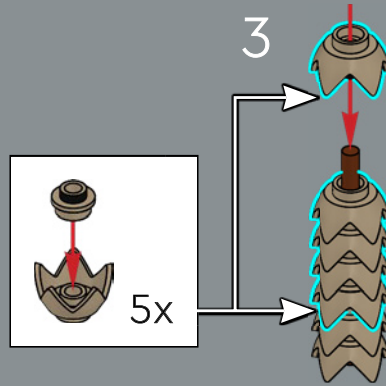
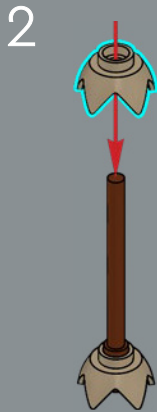
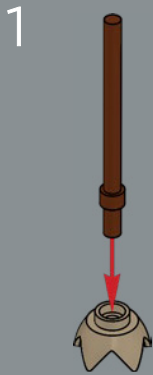





96

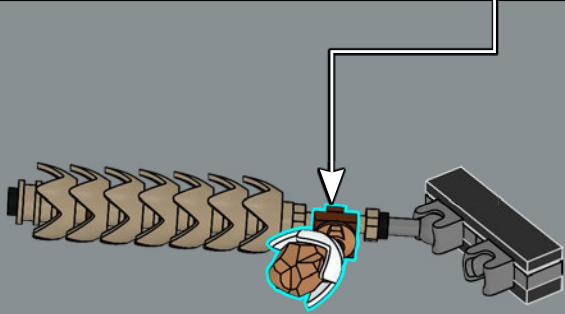
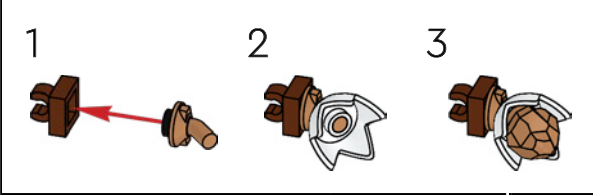

The stalks of wheat use nested crown elements to give the wheat its corrugated appearance.

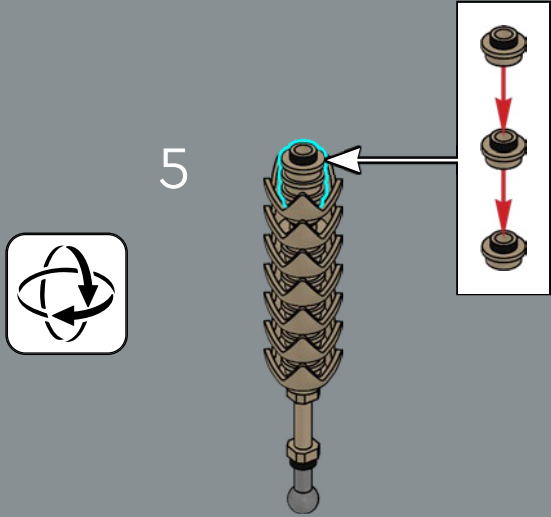

5

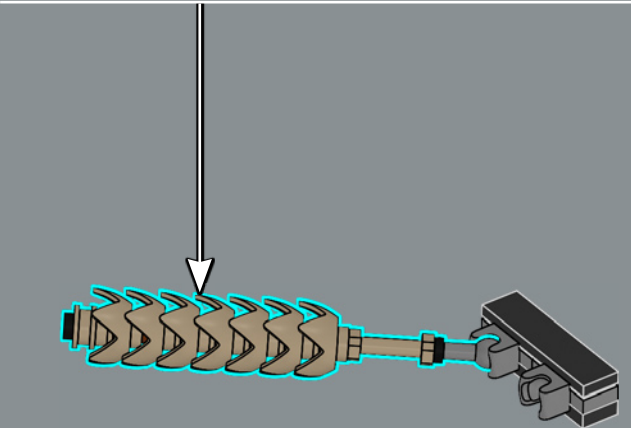

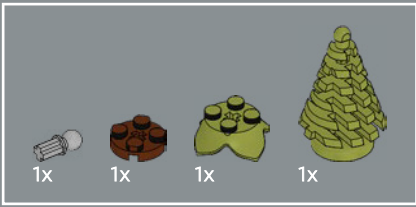

97

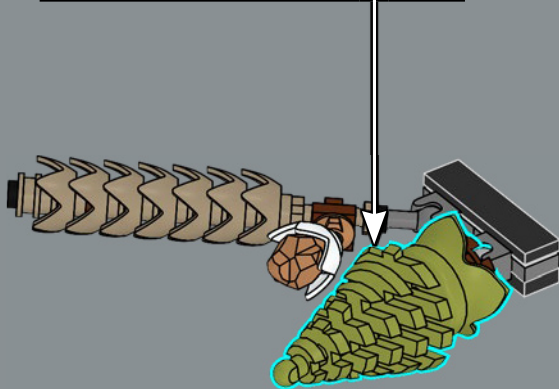
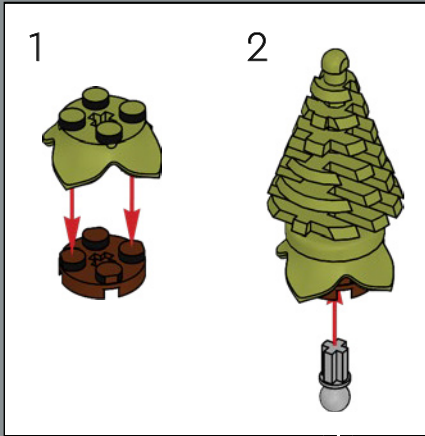

98

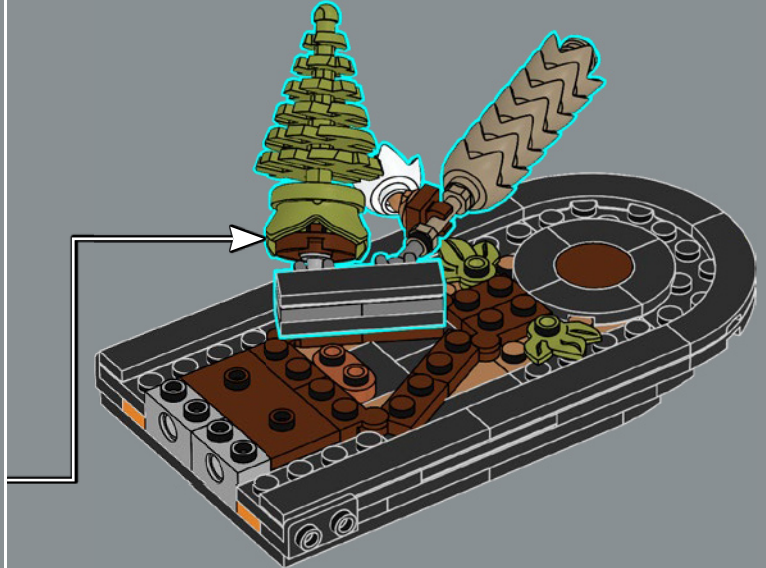

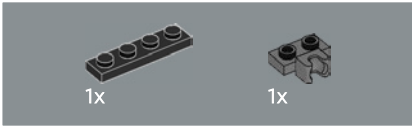
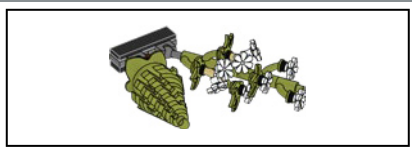

99

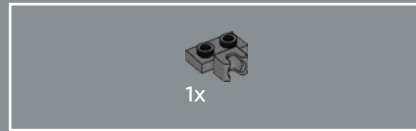
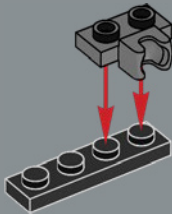

100

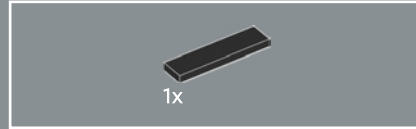
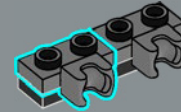

101

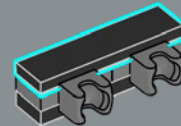

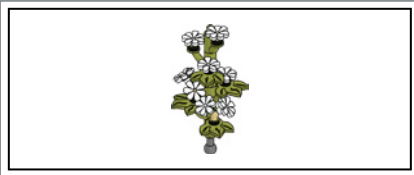

1x

2x

102



2x

103

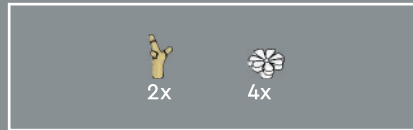
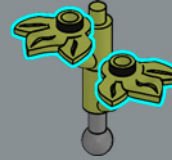

2x

4x

104

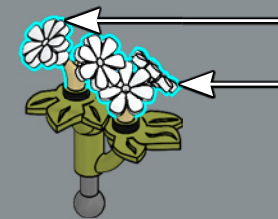
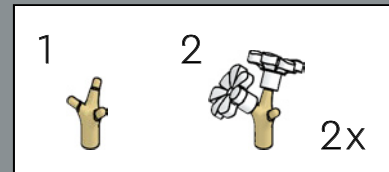



105

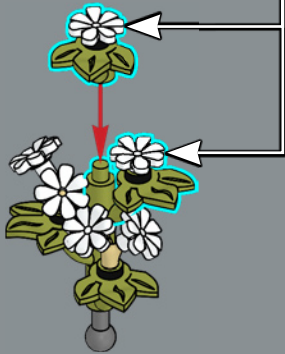
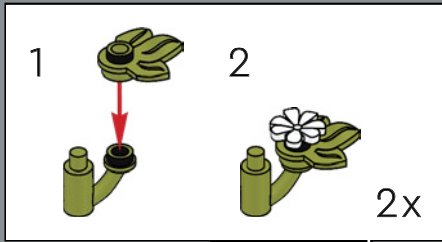

106

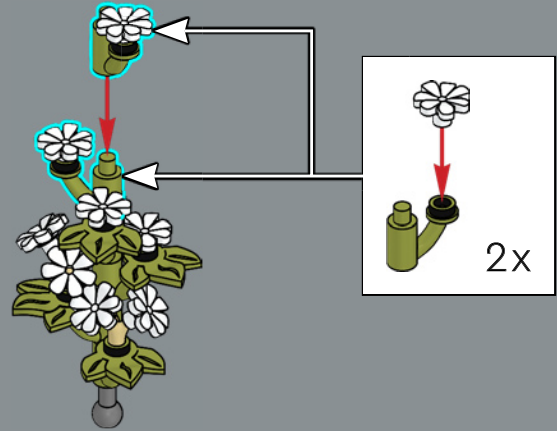

107

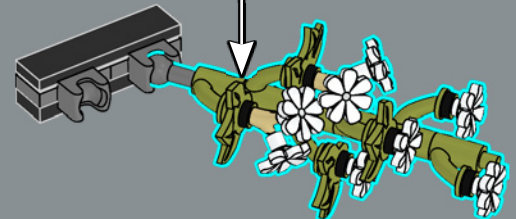

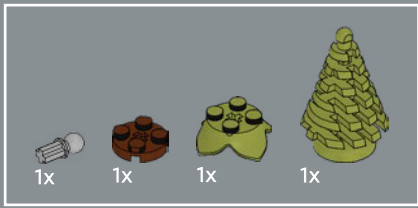

108

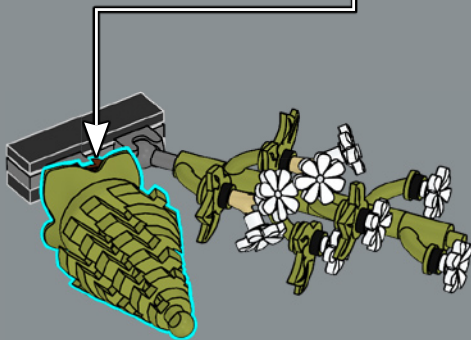
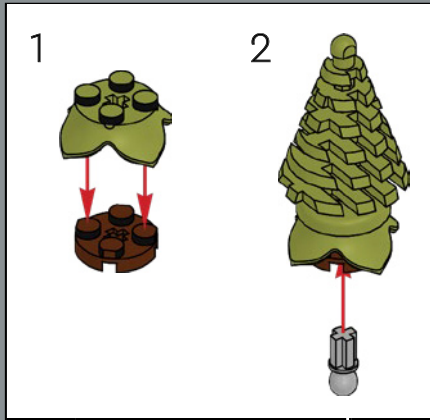

109

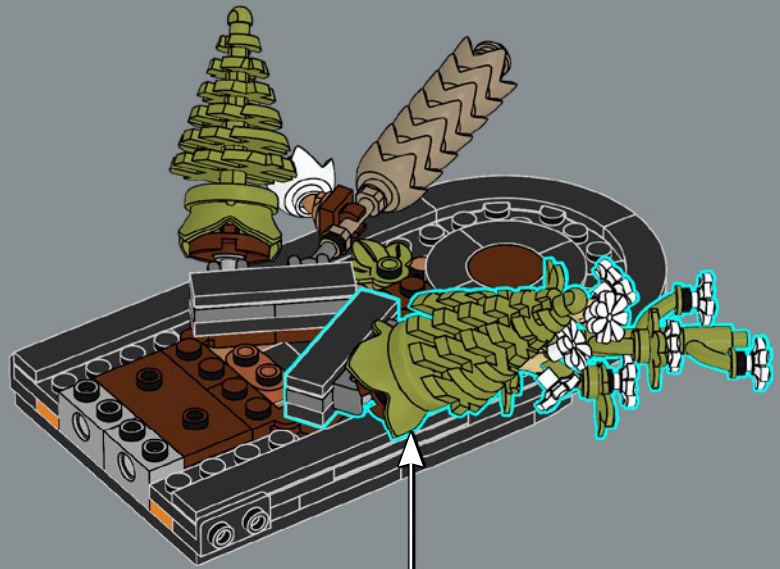

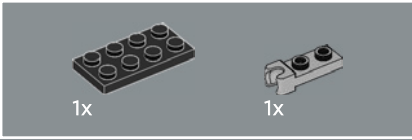
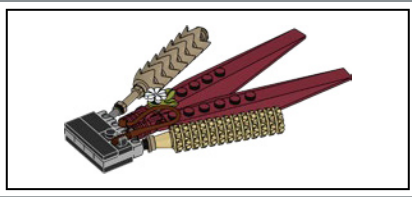

110

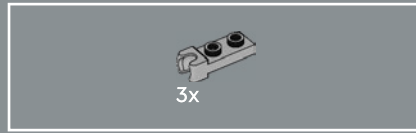
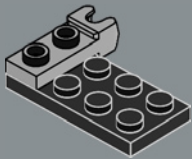

111

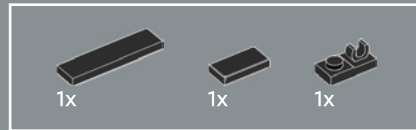
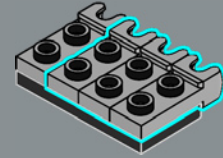

112

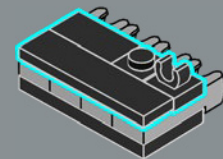

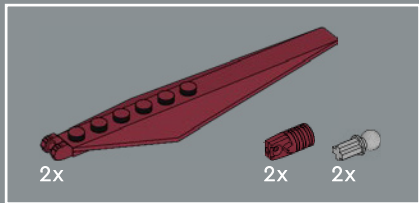

113

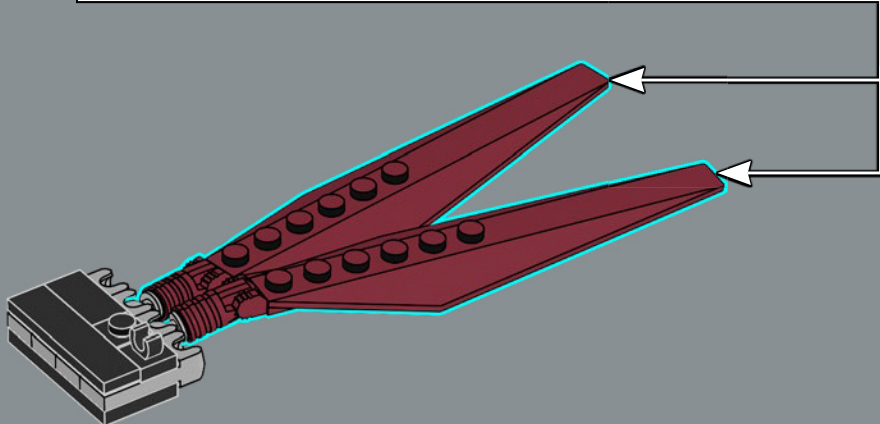
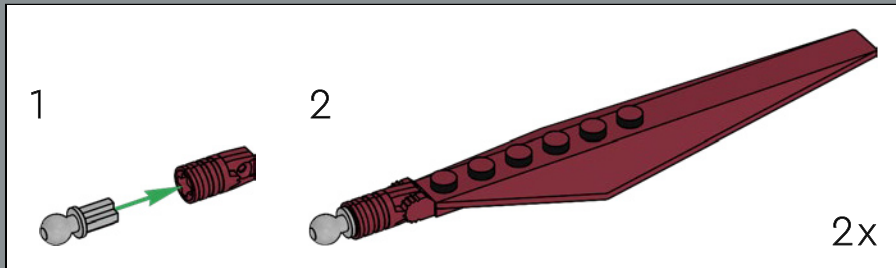

114

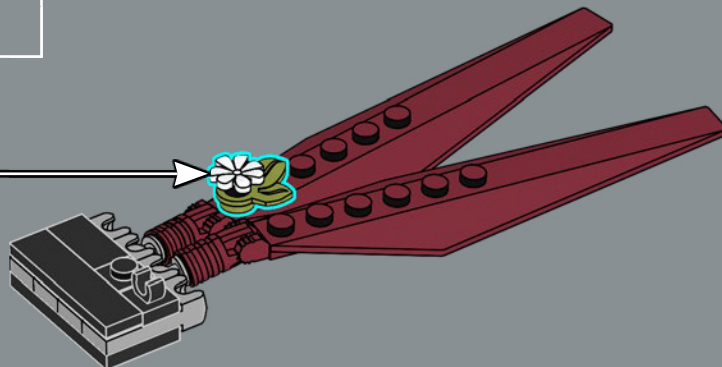
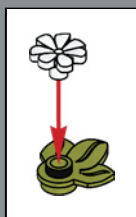





115

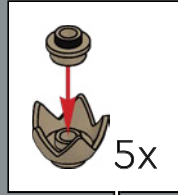
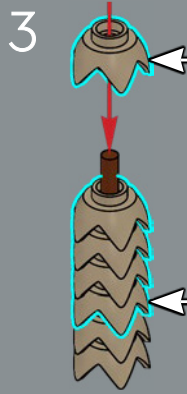
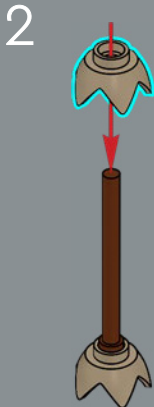
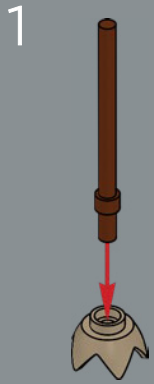

5

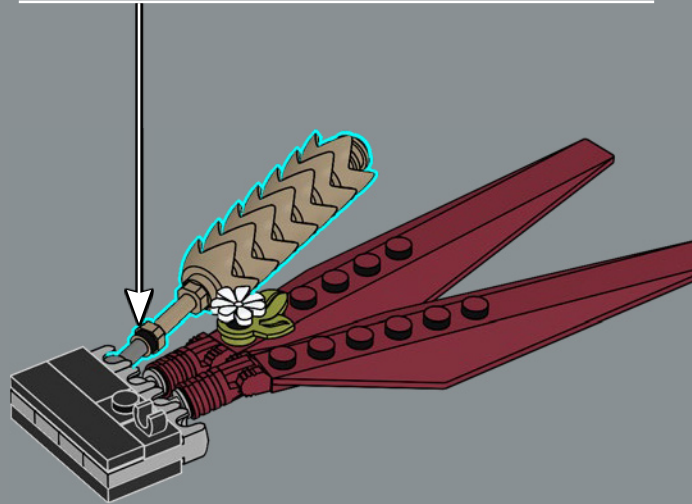
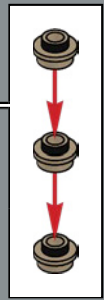

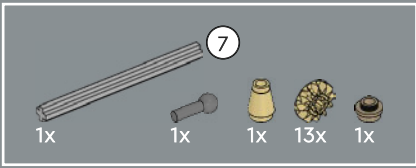

116

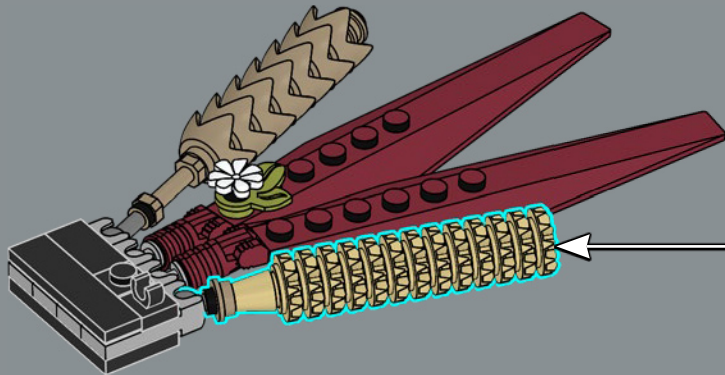
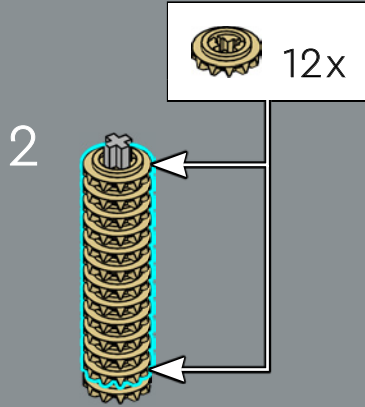



117

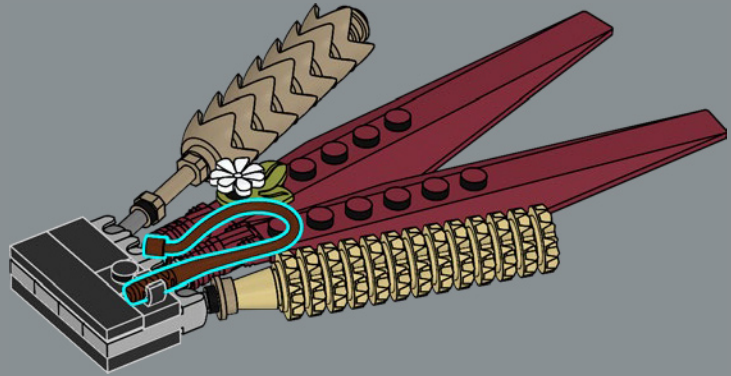

118

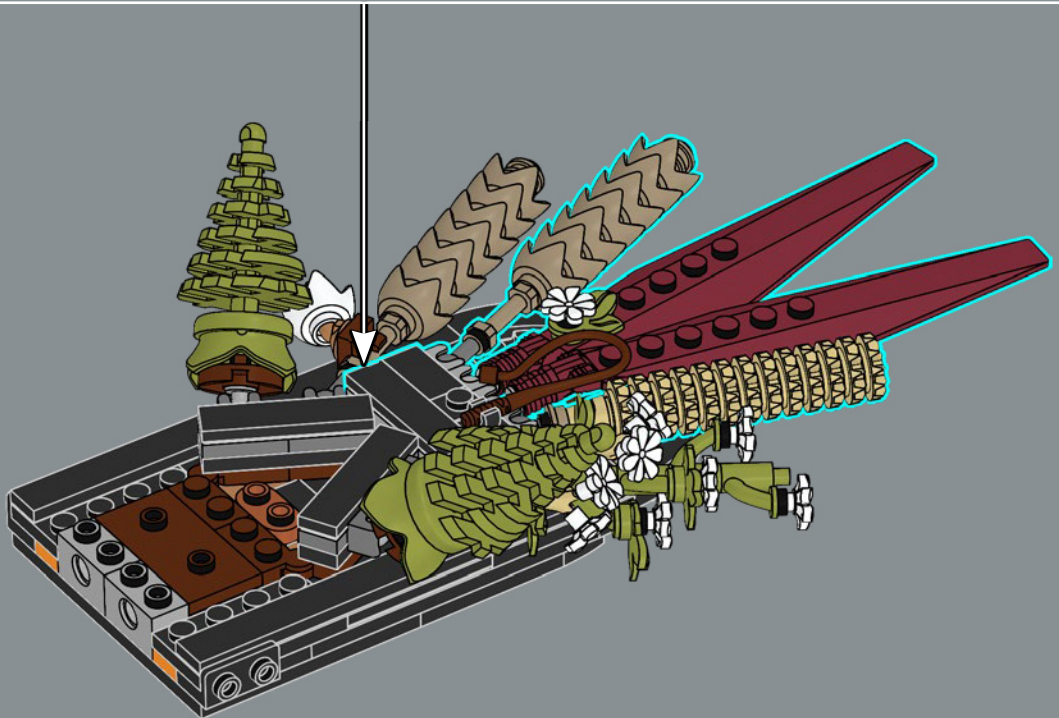

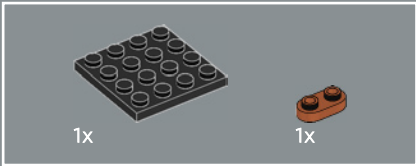
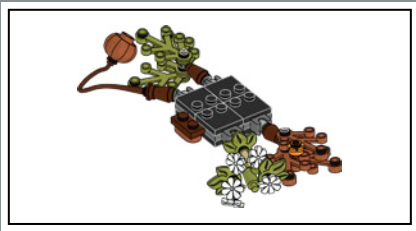

119

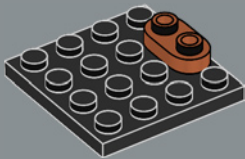

120

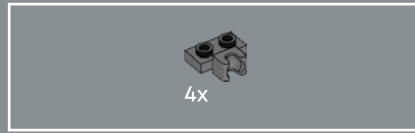
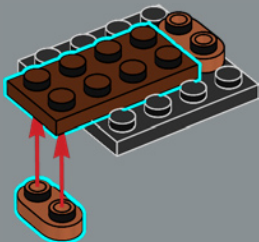

121



4x

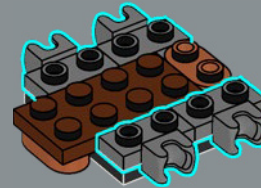

122



4x

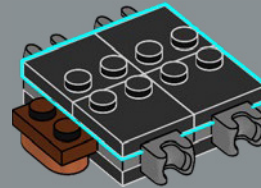



123

1

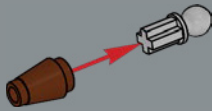

2

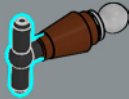

3

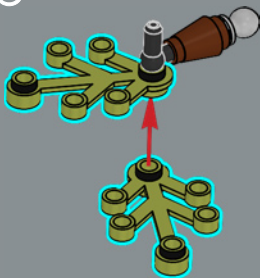

4

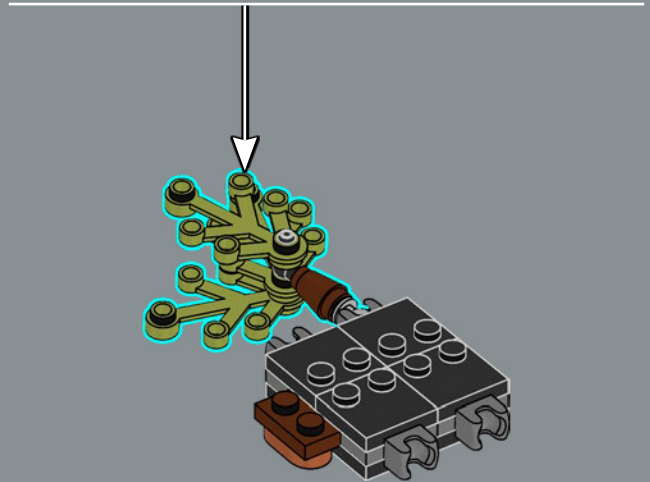
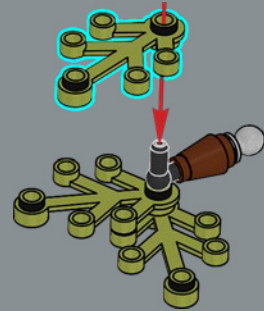



124

1

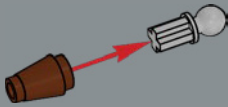

2

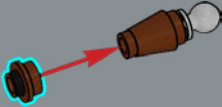

3



4

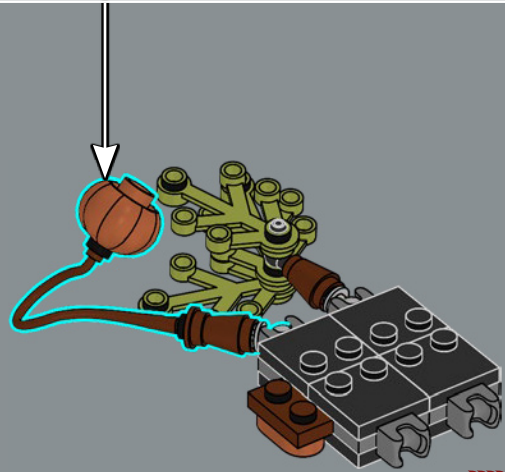

The peculiarly named bladder cherry is built with a LEGO® element that is usually used as vegetables, (like pumpkins or lanterns) and a flexible brown whip element.





125

1

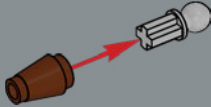

2

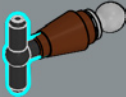

3

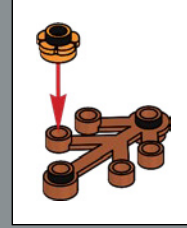
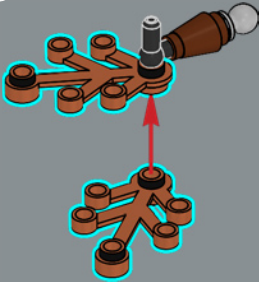

4

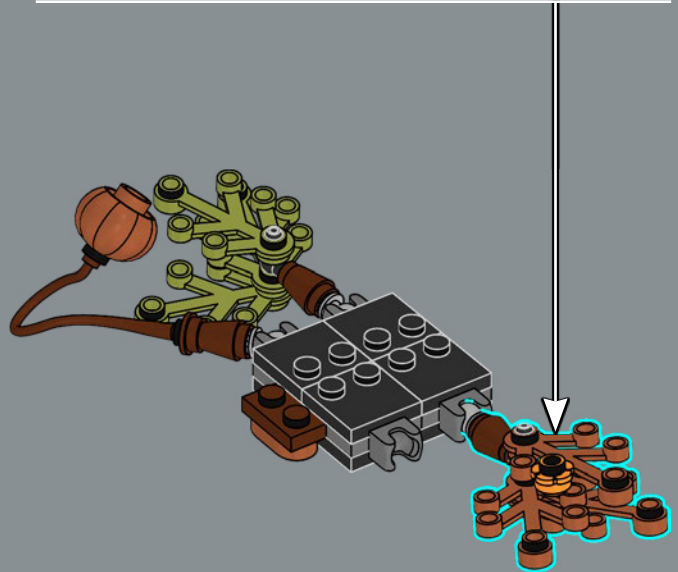
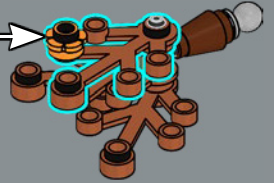

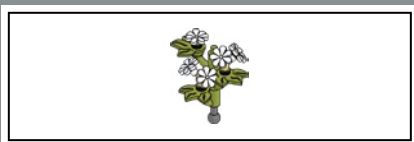

126



127



128

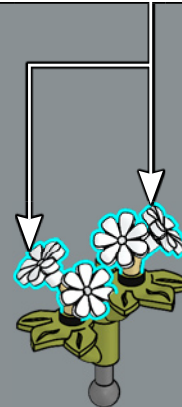
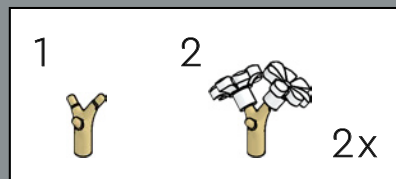



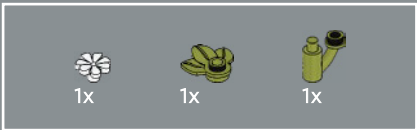

129

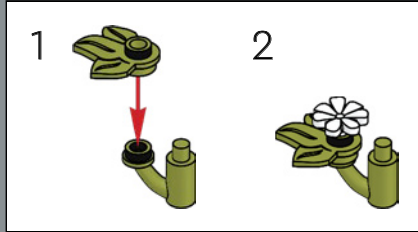

130

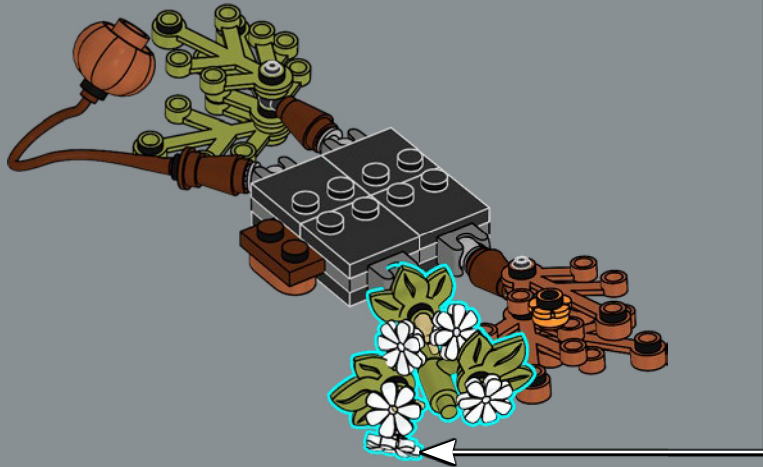

131

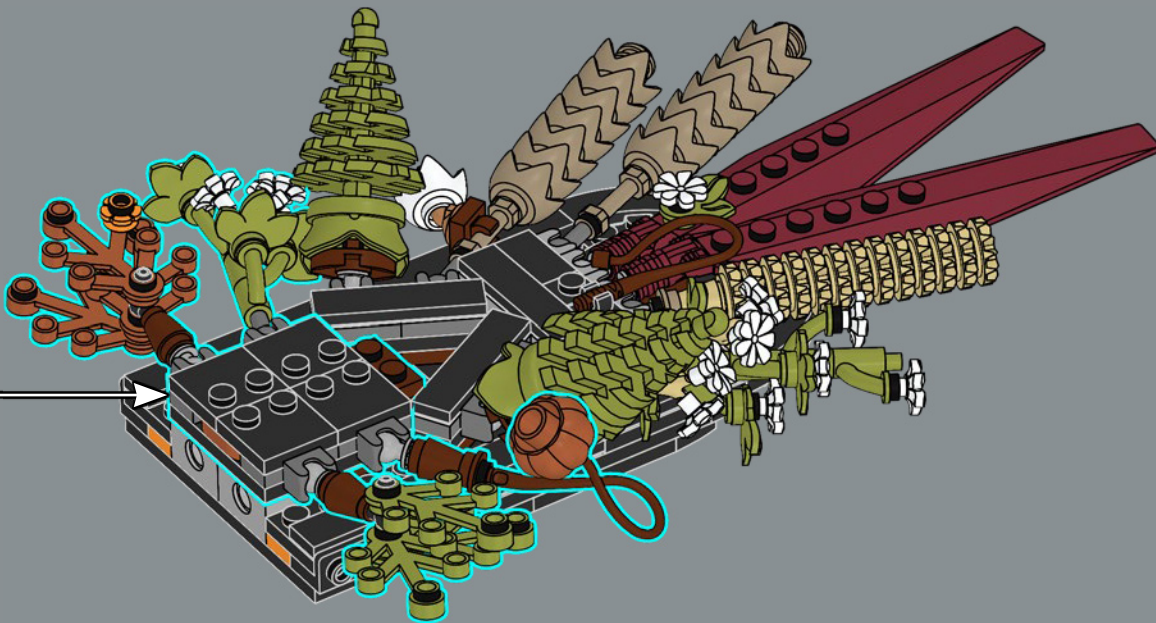

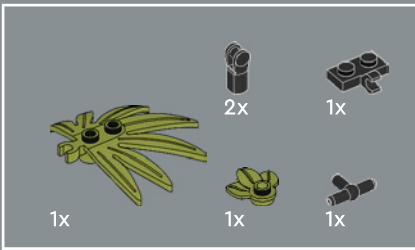

132

1

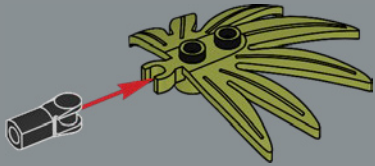

2

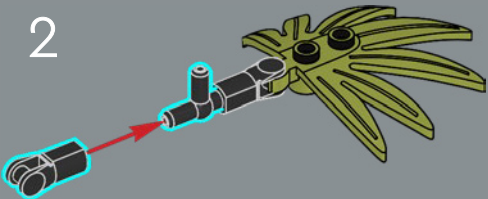

3

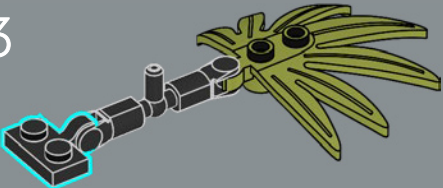

4

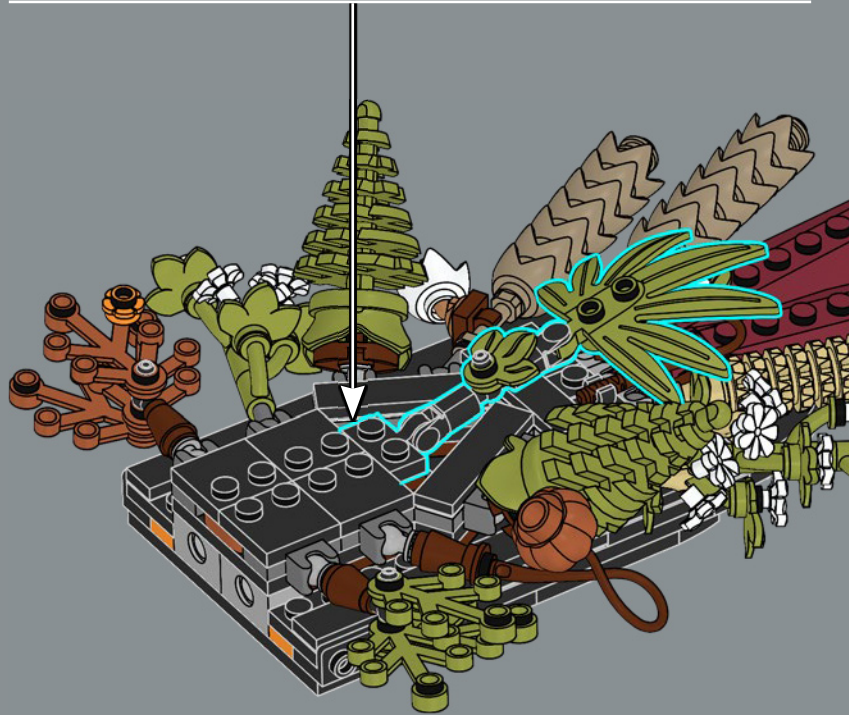
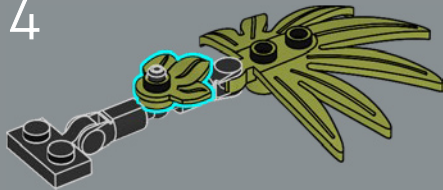

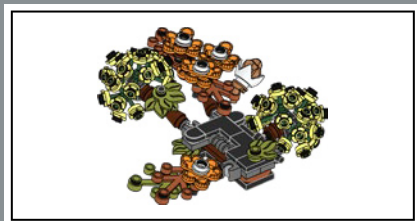

133

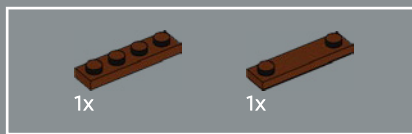
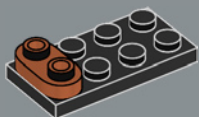

134

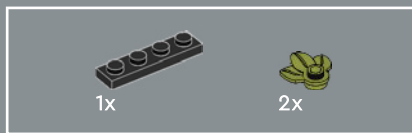
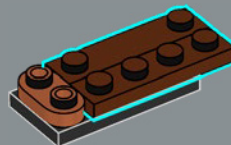

135

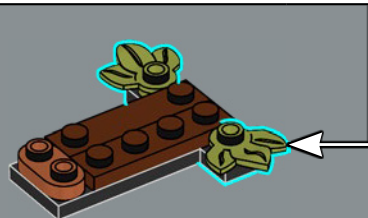
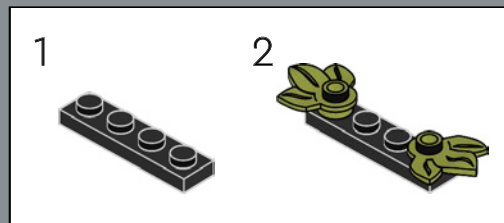

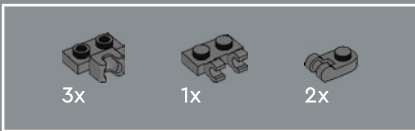

136

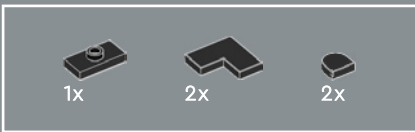
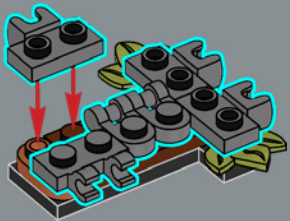

137

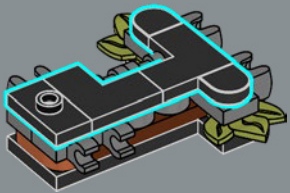

138

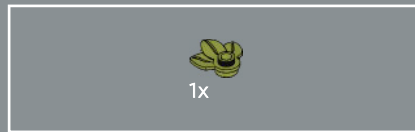
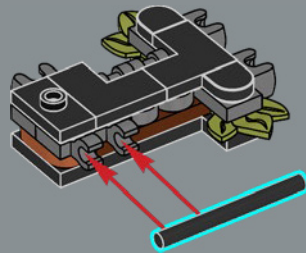

139

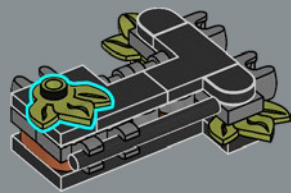

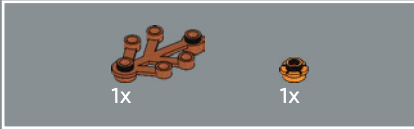

140

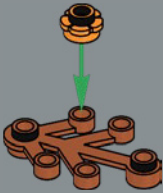

141

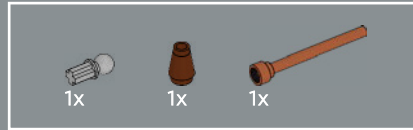
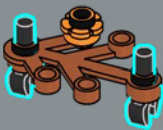

142

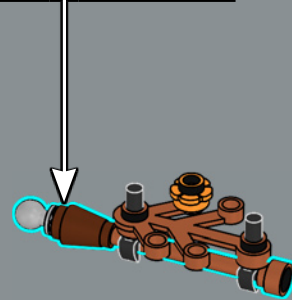
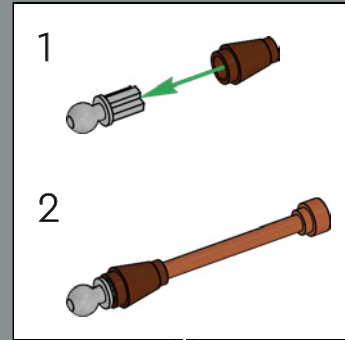

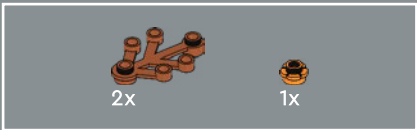

143

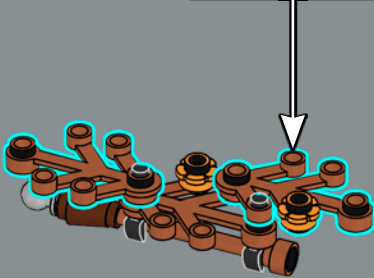
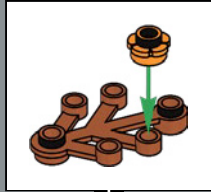

144

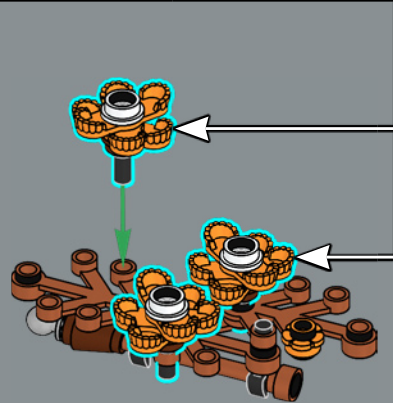
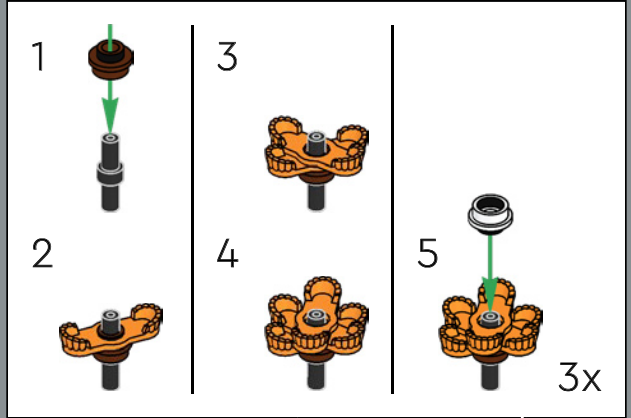



1x



1x



1x

# 145

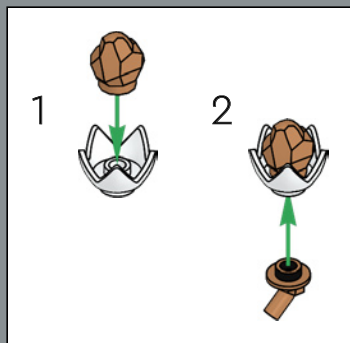

The dried daisy heads are constructed with a white crown element and a rare rock element first used as a gold nugget.

# 146

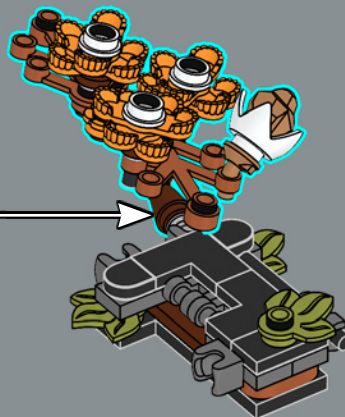



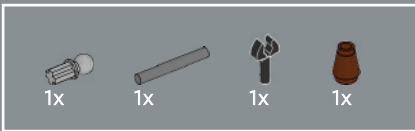

147

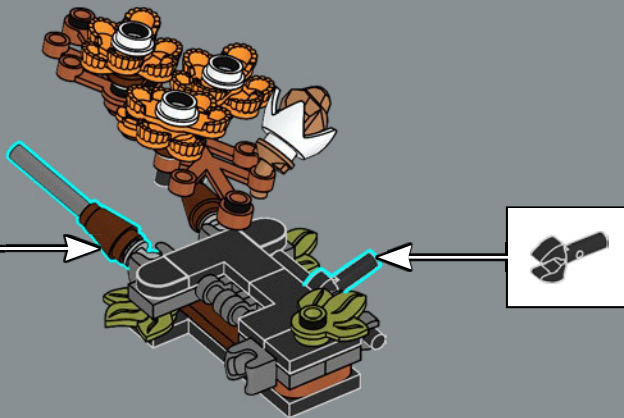
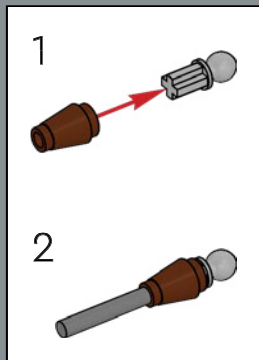



148

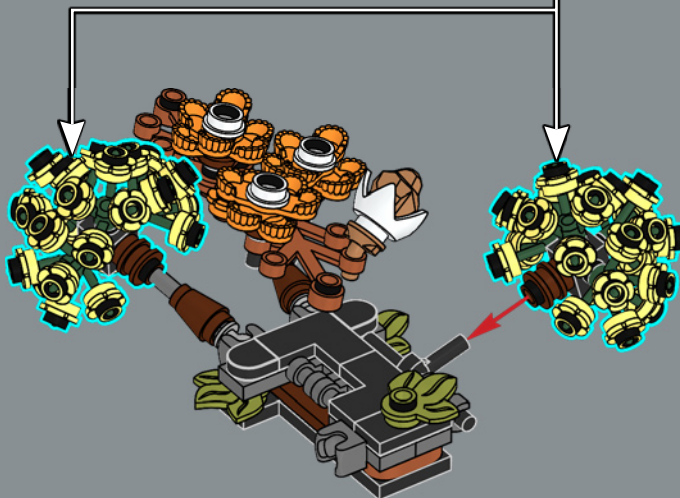
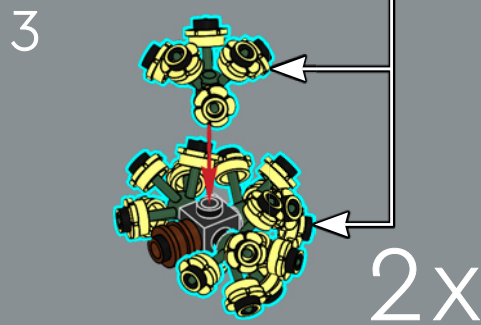
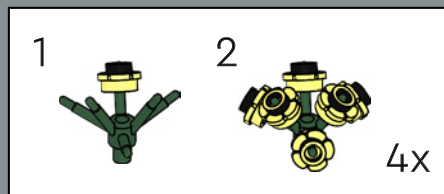
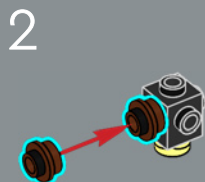
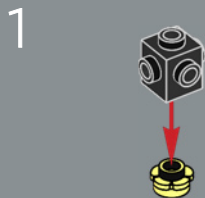



1x



2x

149

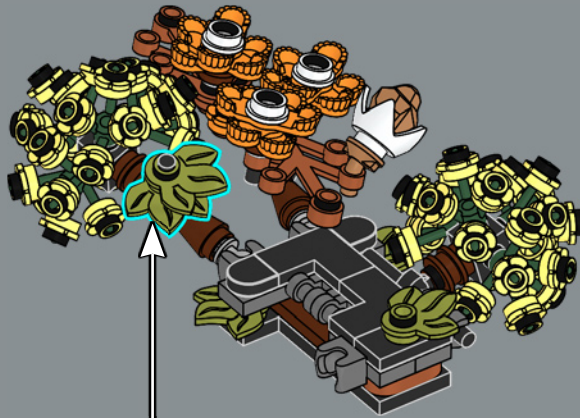

1

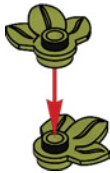

2





150

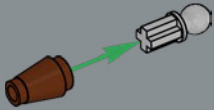

151

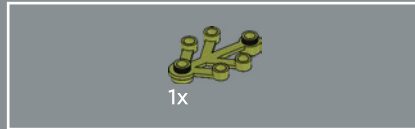
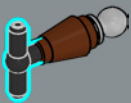

152

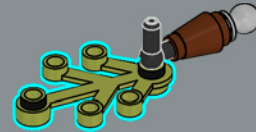

153





154

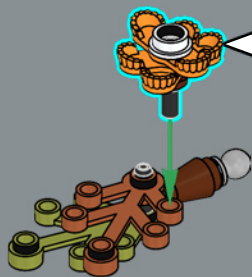
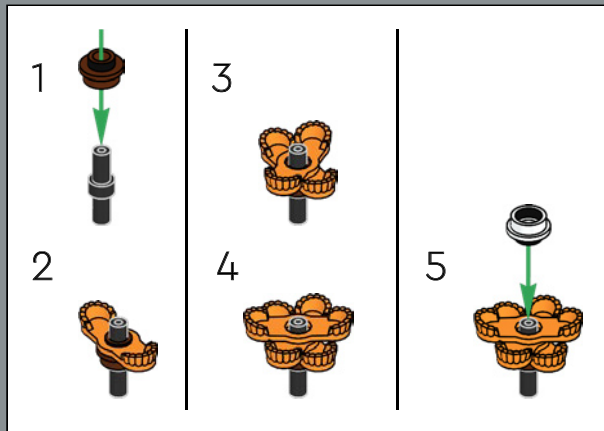

155

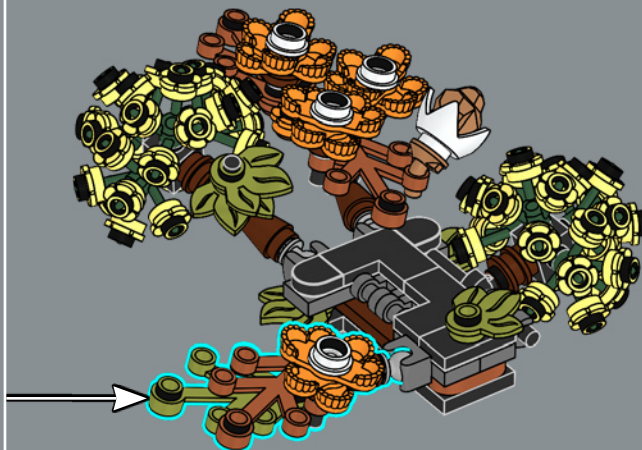

156

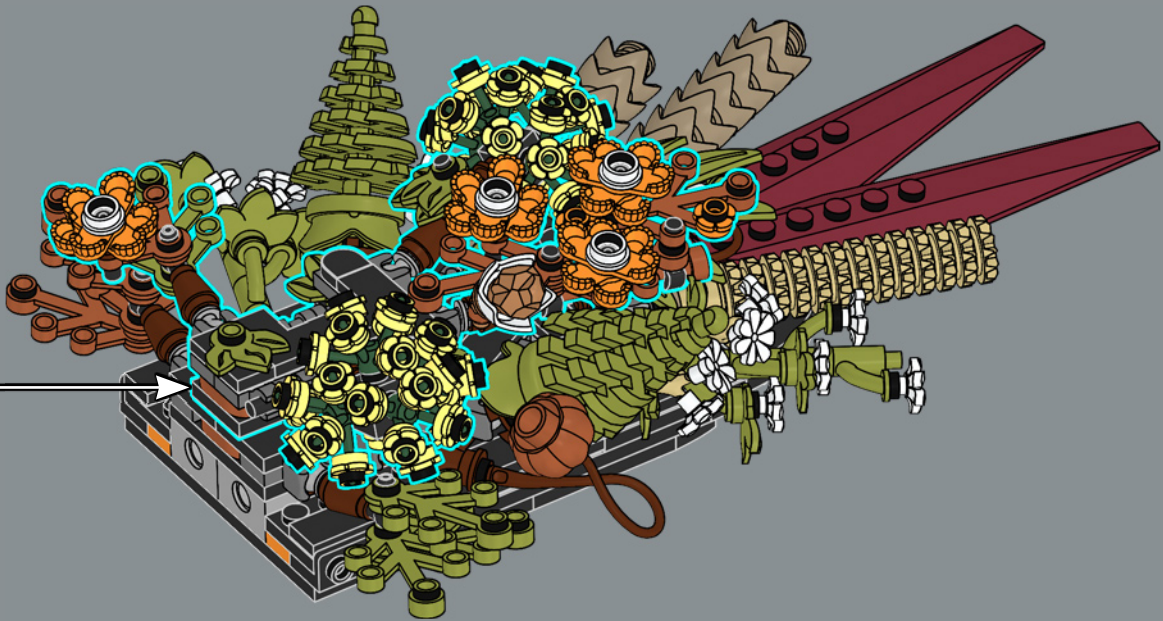

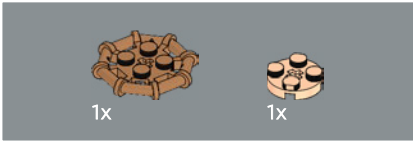
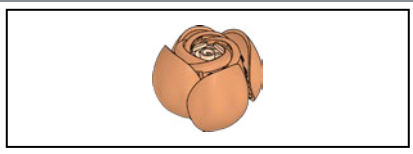

157

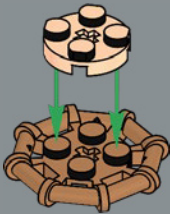

158



159

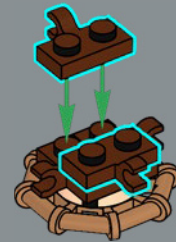

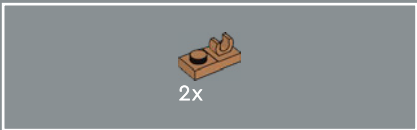

160

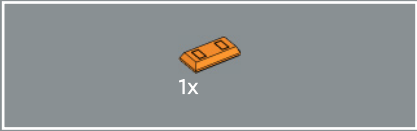
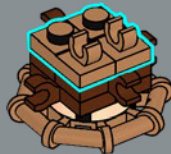

161

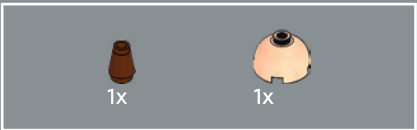

162

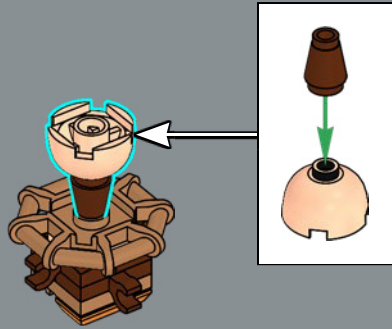



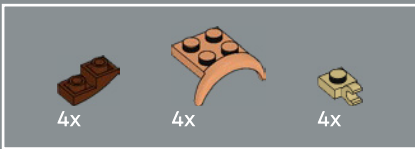

163

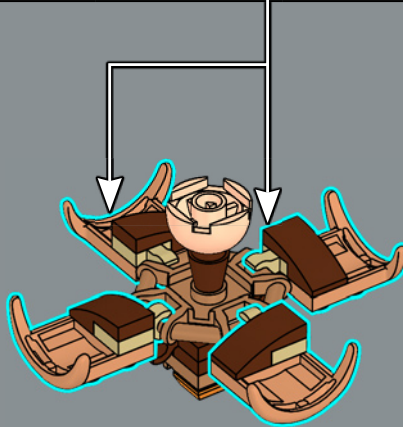
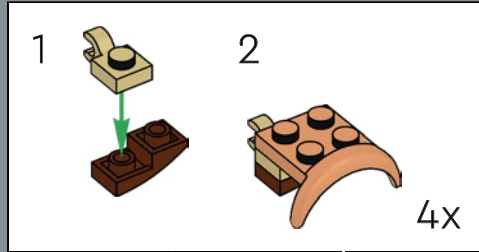

164

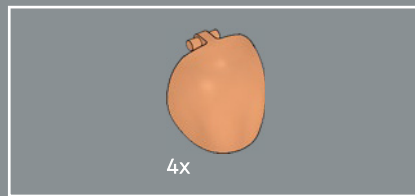
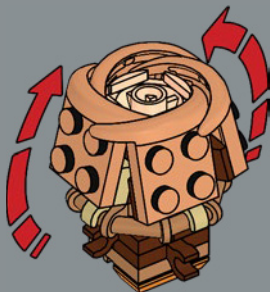

165

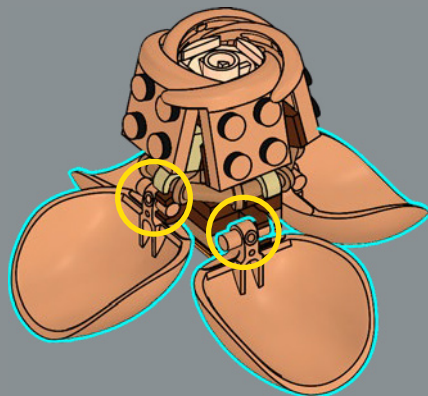

166

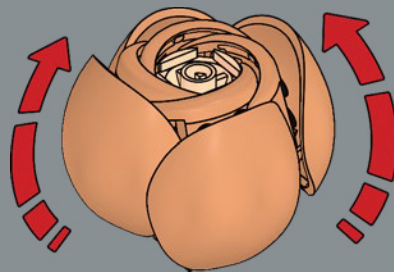



The intricate rose construction uses new mud guard elements for the inner petals and a new shell element for the outer petals.

167

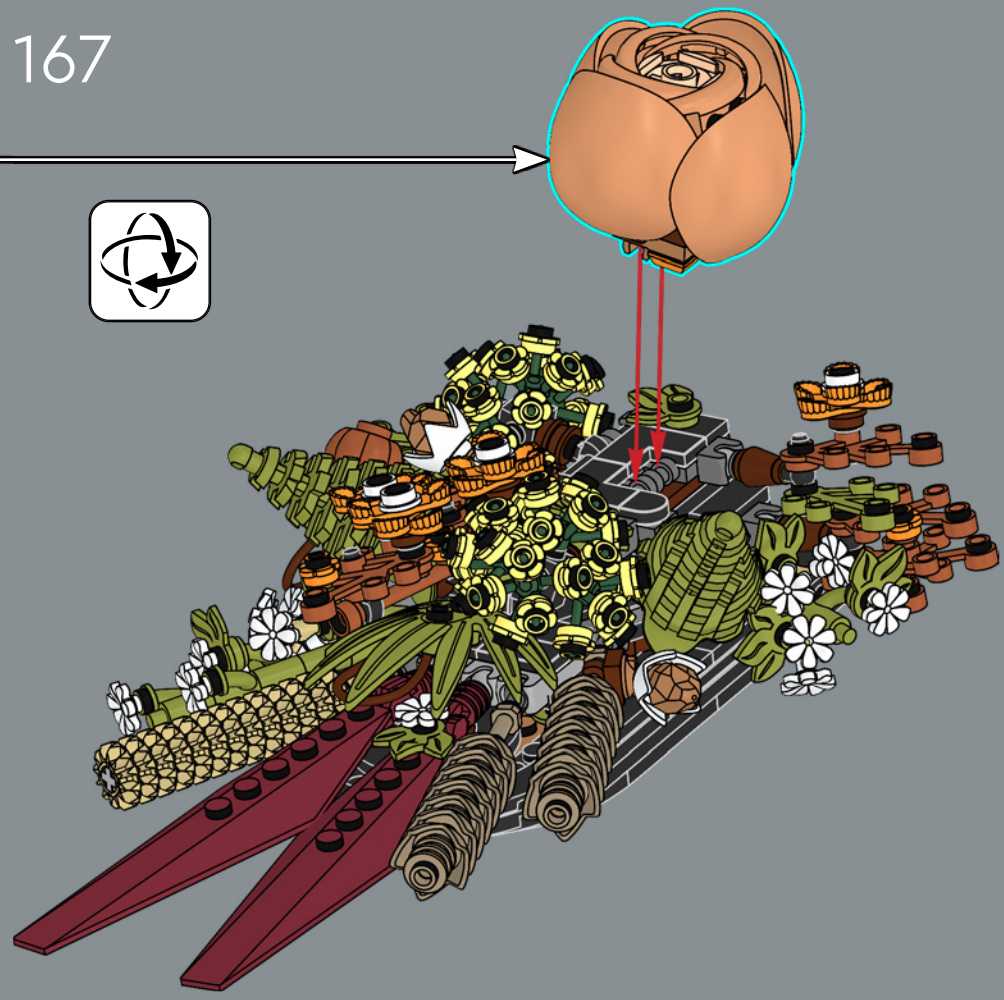



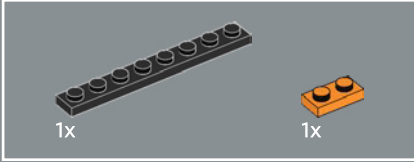
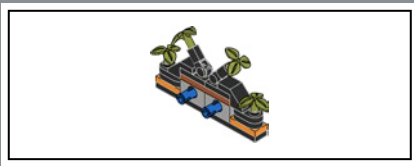

168

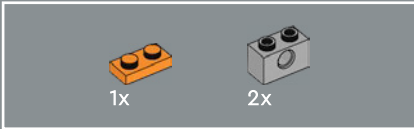
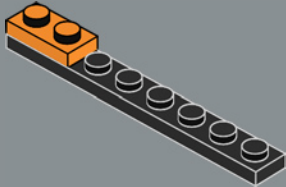

169

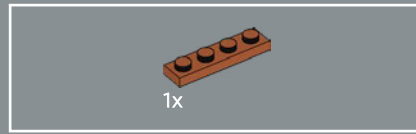
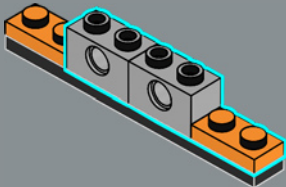

170

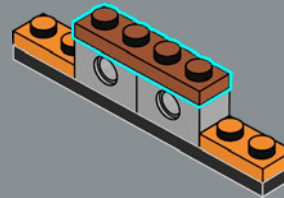

171

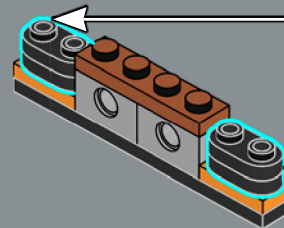
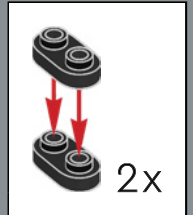



172

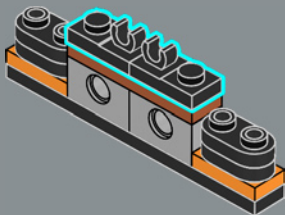

173

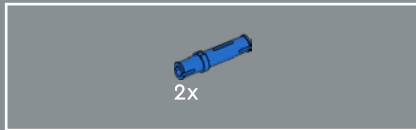
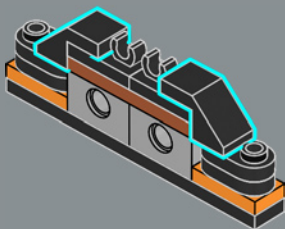

174

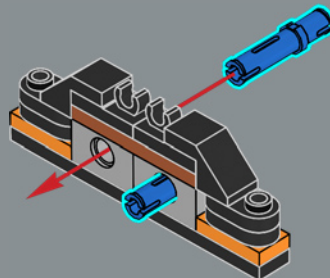



175

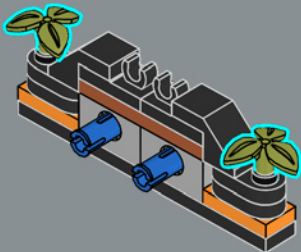

176

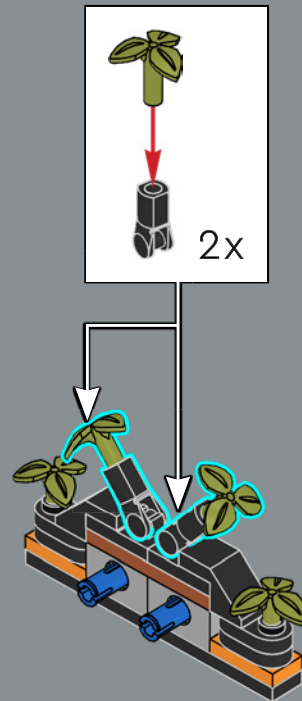

177

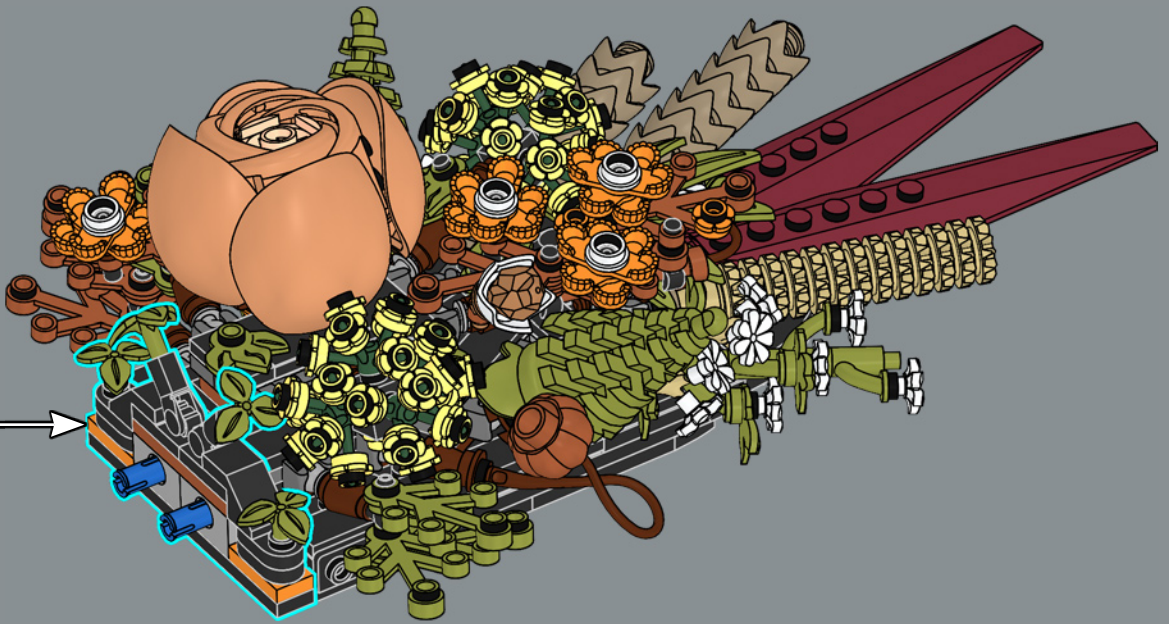





Dried flowers are sometimes preserved using a thin wax. The shiny elements in this set were chosen to replicate that wax look.

178

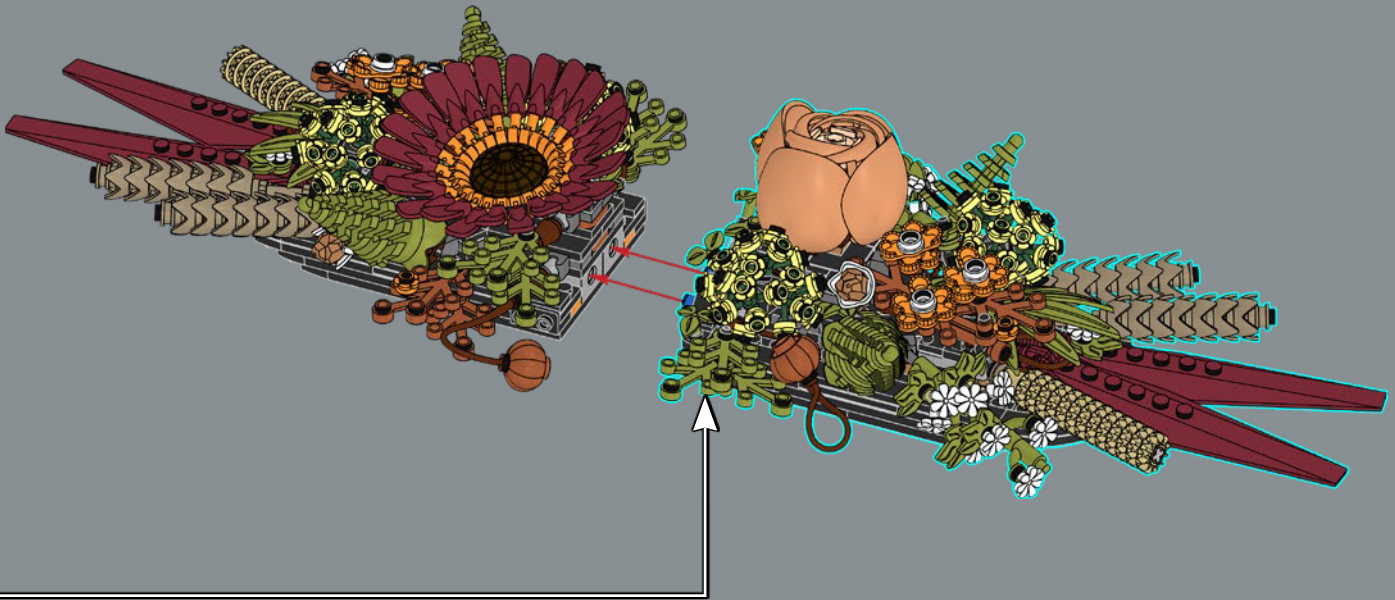

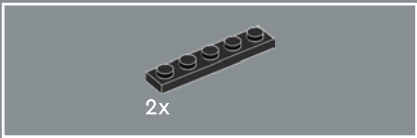

179

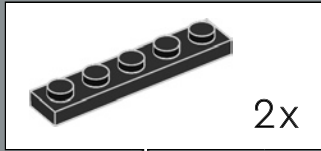

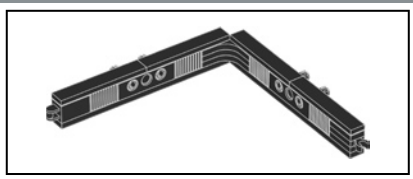

180

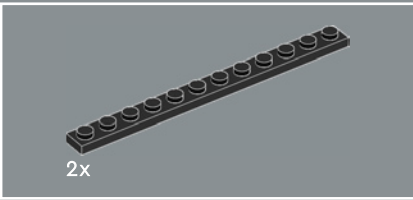
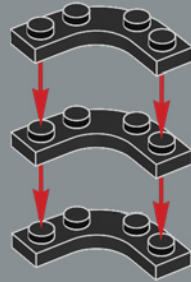

181

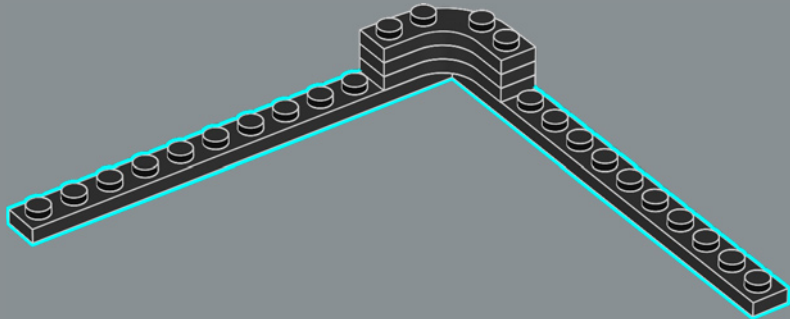

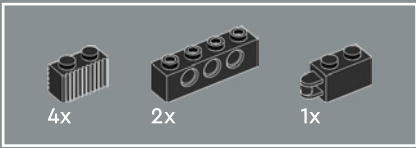

182

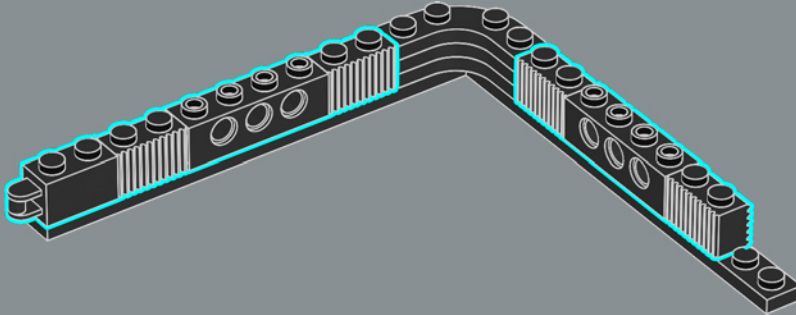

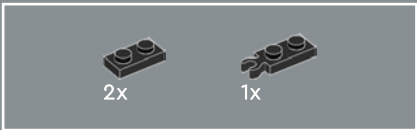

183

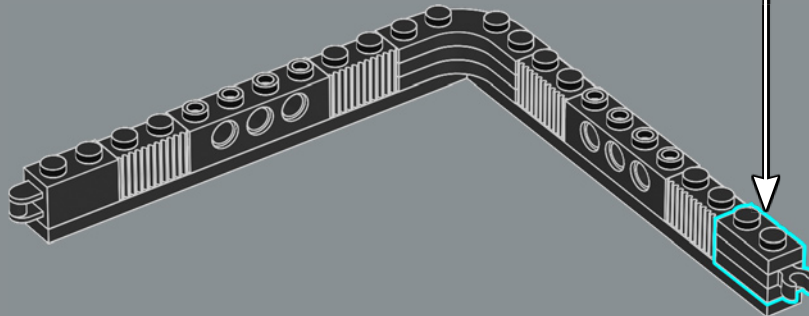
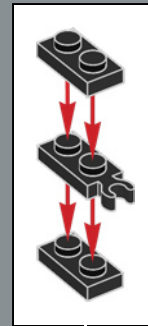

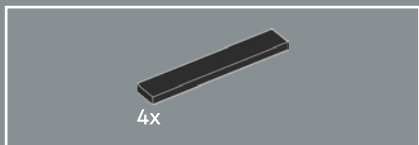

184

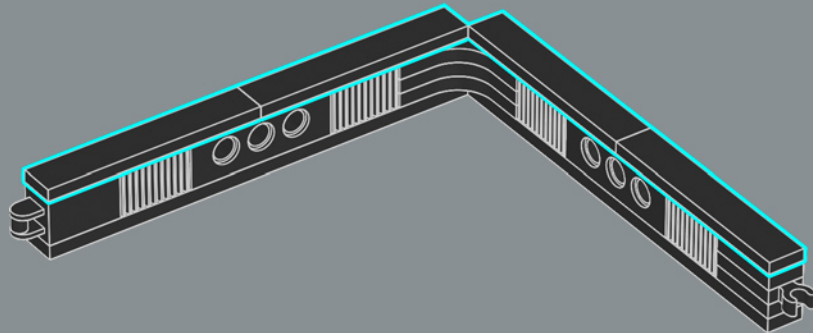

185

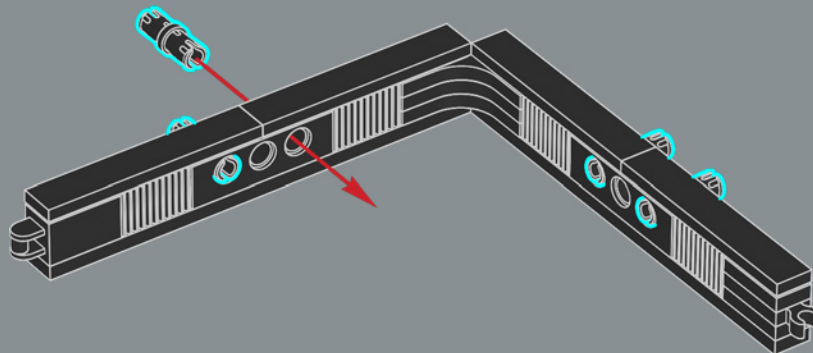

186

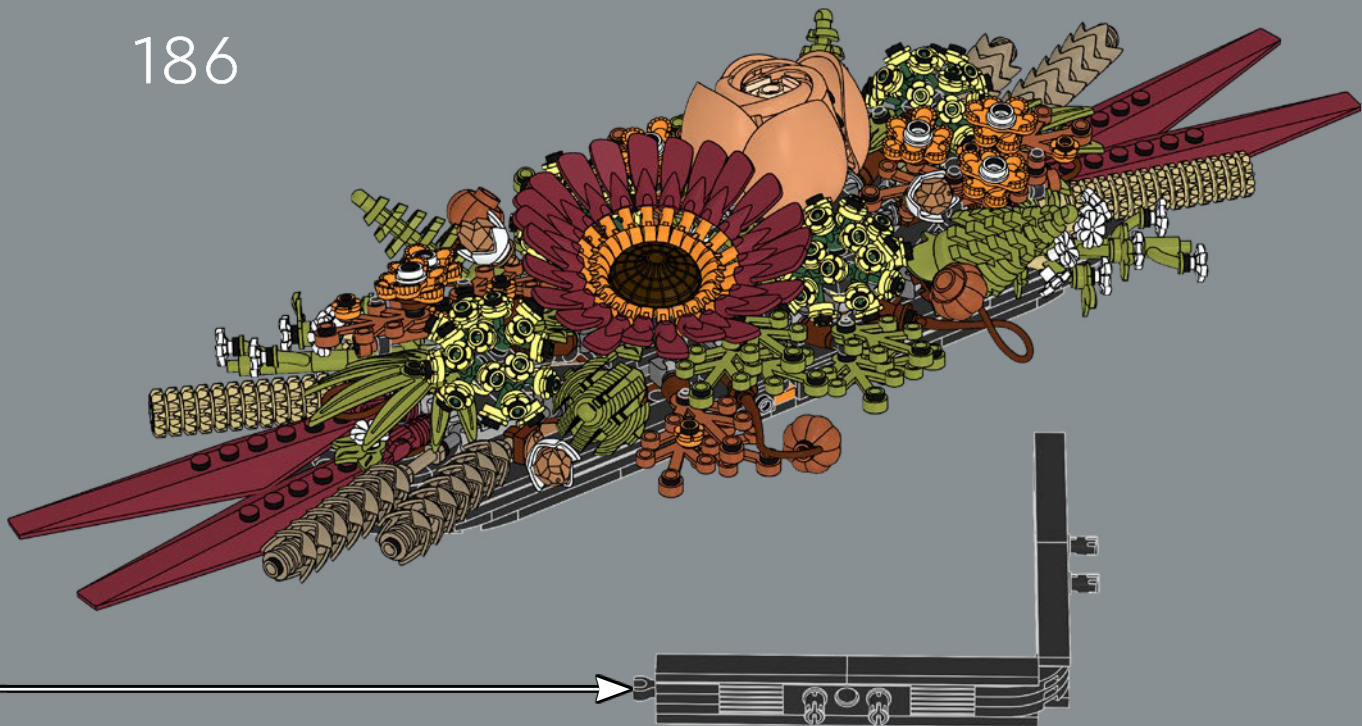







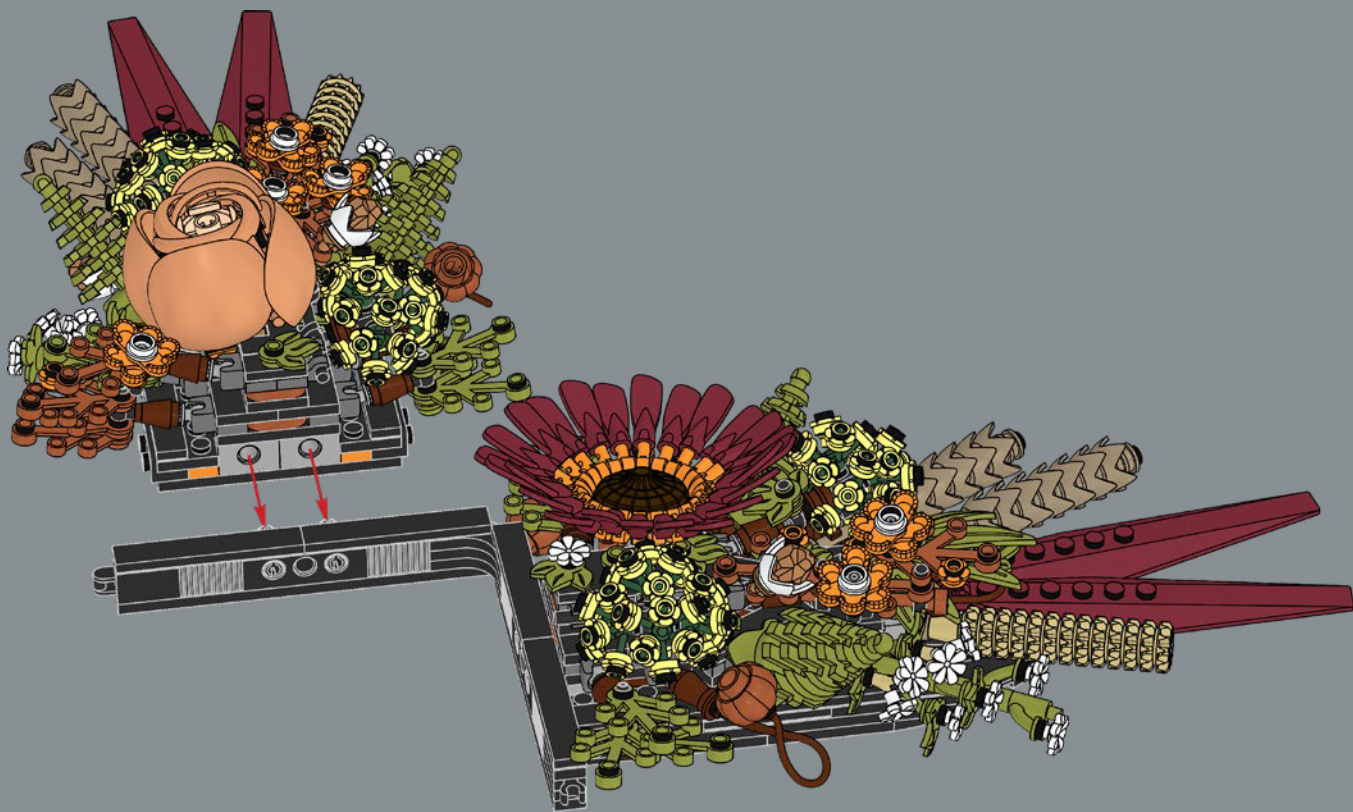



3 x 10314

