



SONIC™

THE HEDGEHOG

76991



1



 **FR**
DONNEZ
OU
RECYCLEZ

 OU  OU 

ASSOCIATION MAGASIN DÉCHÈTERIE

Adresses sur quefairedemesdechets.fr



LEGO.com/sustainable-packaging



BUILDER



Apple and the Apple logo are trademarks of Apple Inc., registered in the U.S. and other countries and regions. App Store is a service mark of Apple Inc. Google Play and the Google Play logo are trademarks of Google LLC. Tencent and the Tencent logo are trademarks of Tencent Inc.

Q [LEGO.com/devicecheck](https://www.lego.com/devicecheck)

EN Ask parents' permission before going online | **DE** Eltern um Erlaubnis bitten, bevor du online gehst | **FR** Demande l'autorisation d'un parent avant d'aller en ligne | **IT** Chiedi il permesso ai tuoi genitori prima di andare online | **ES** Pídeles permiso a tus papás antes de conectarte a Internet | **PT** Pede autorização aos pais antes de acederes online | **ZH** 上网前应先征得父母的同意 | **PL** Poproś rodziców o zgodę, zanim wejdiesz do Internetu | **CS** Než půjdeš na internet, požádej rodiče o svolení | **SK** Skôr než pôjdeš na internet, vypýtaj si povolenie od rodičov | **HU** Kérj szülői engedélyt, mielőtt online csatlakoznál! | **RO** Cere permisiunea părinților înainte de a te conecta online | **BG** Поискайте разрешение от родител, преди да влезете онлайн | **LV** Pirms došanās tiešsaistē palūdz atļauju vecākiem | **ET** Enne Interneti kasutamist küsi vanematelt luba | **LT** Prieš prisijungdami prie interneto, atsi klauskite tėvų

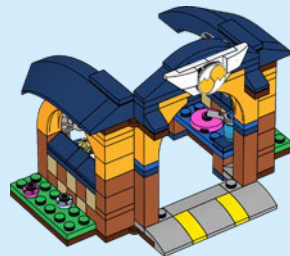
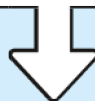
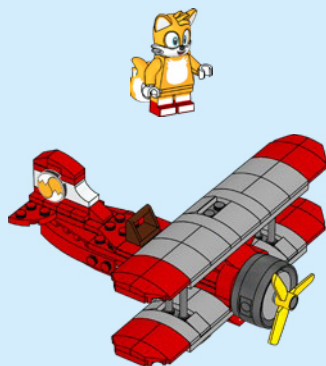
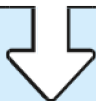
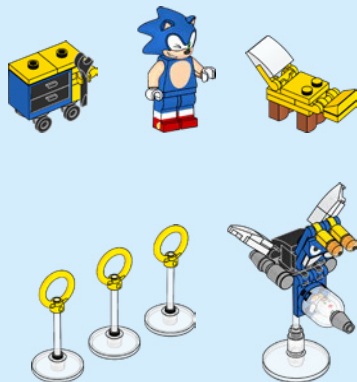
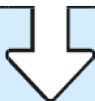

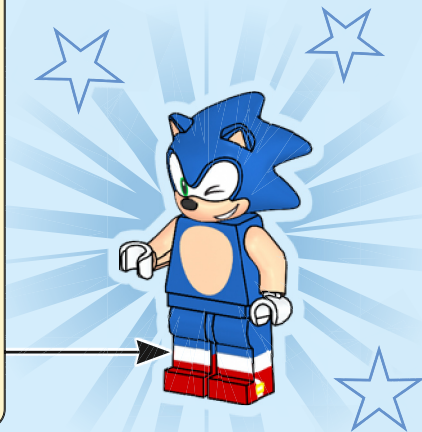
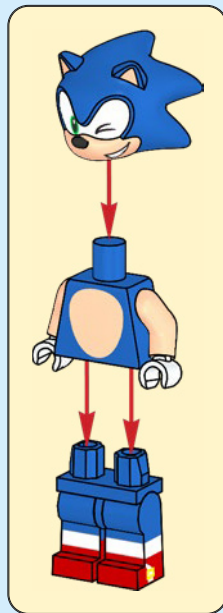

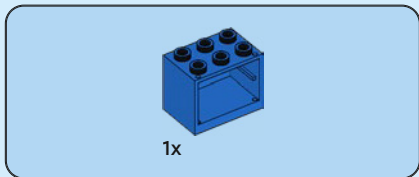

1

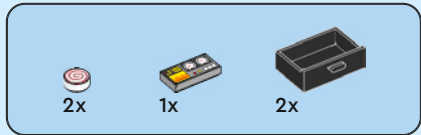
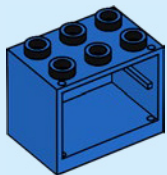

2

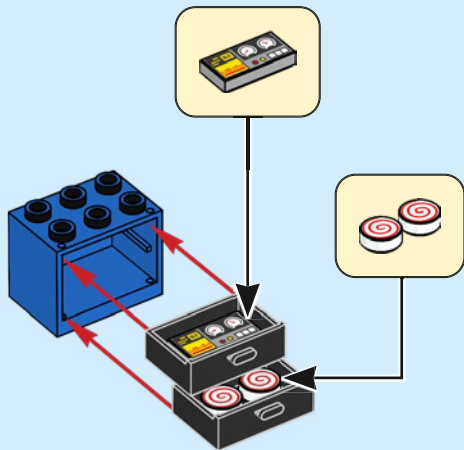

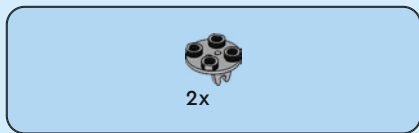

3

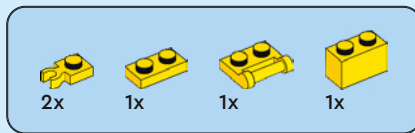
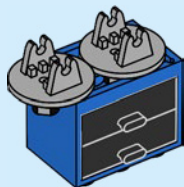

4

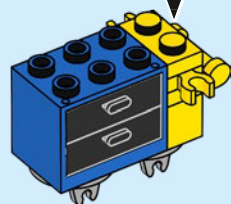
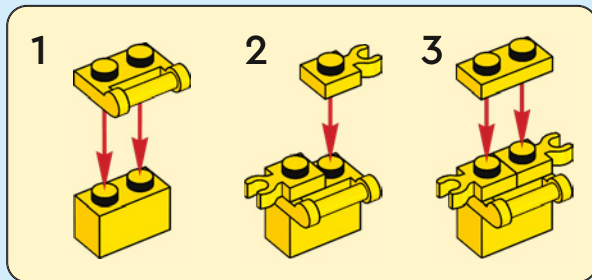



2x

5

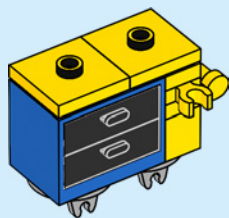

8





2x

6

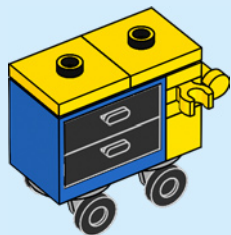

1x

7

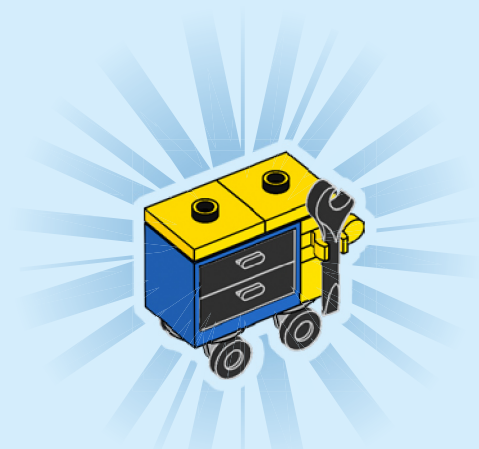

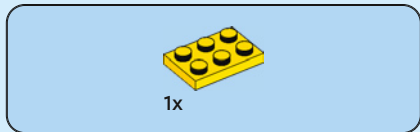
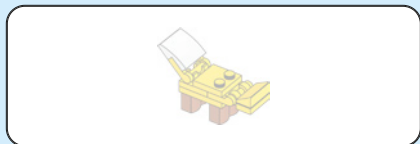

1



10

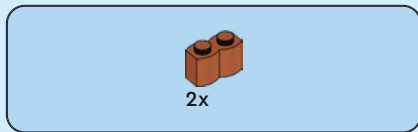

2

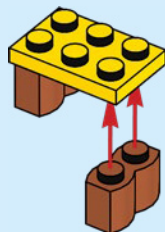



2x



1x

3

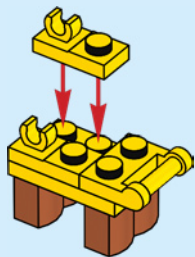

1x

4

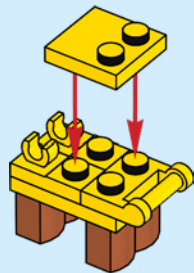



1x



1x

5

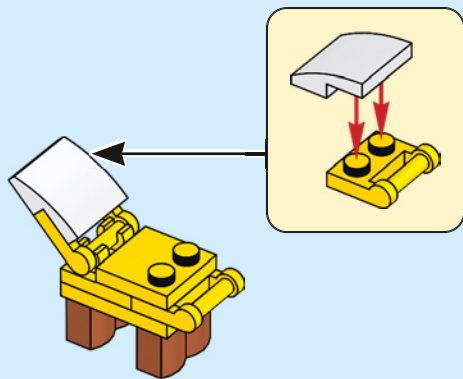

1x



1x

6

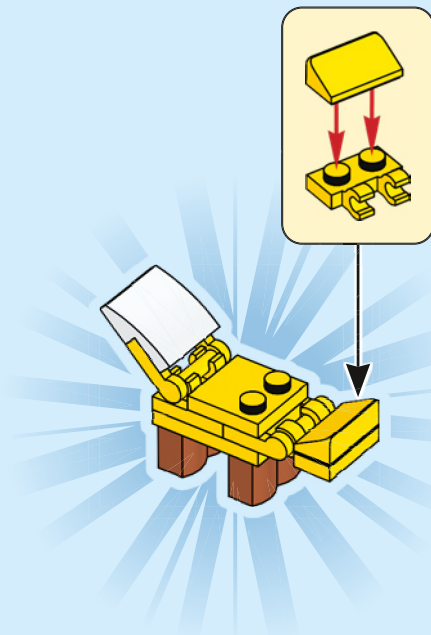

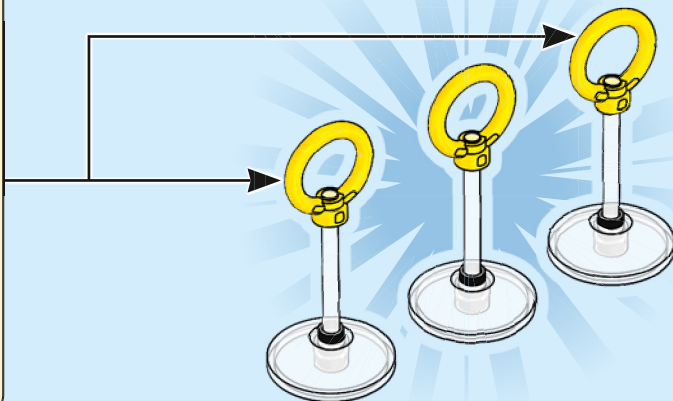
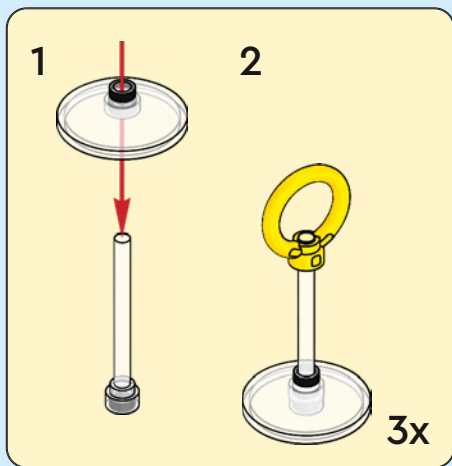
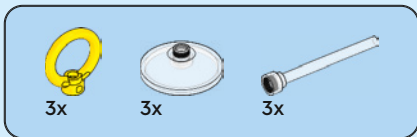

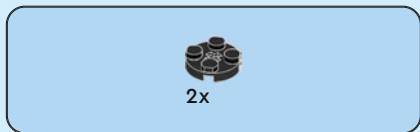

1

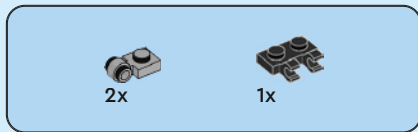
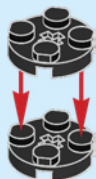

2

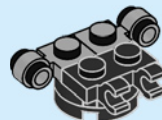



1x



1x

3

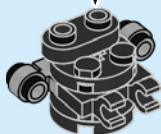
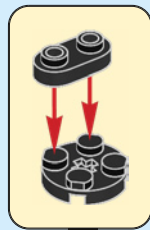

2x

4

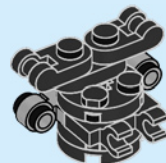



2x



1x

5

1

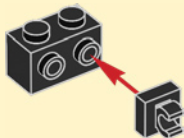

2

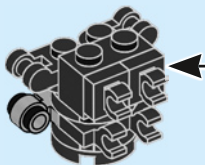
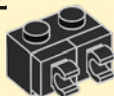

1x

6

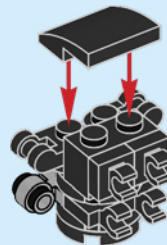



2x

7

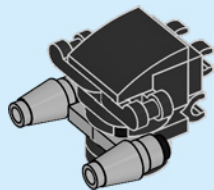

2x



2x

8

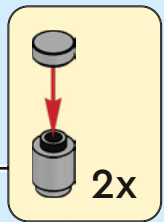
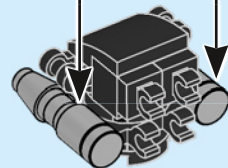

2x

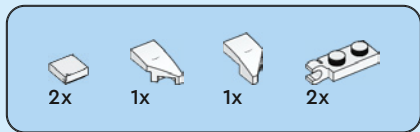

9

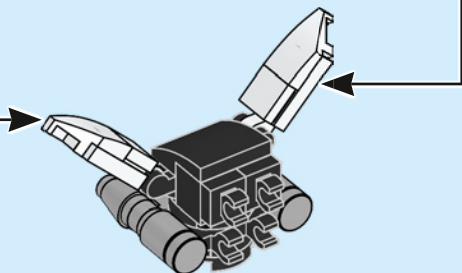
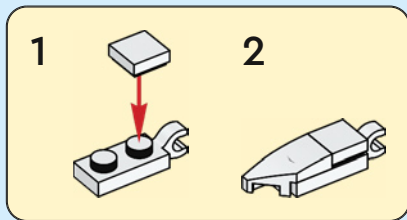
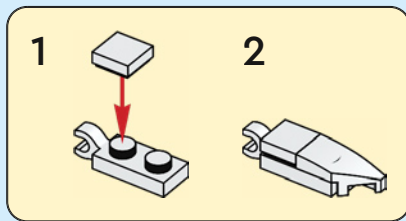

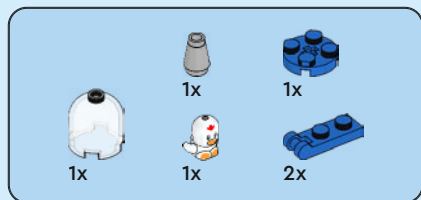

10

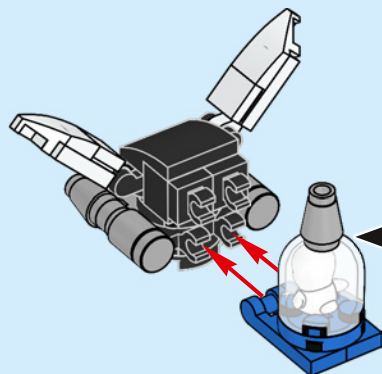
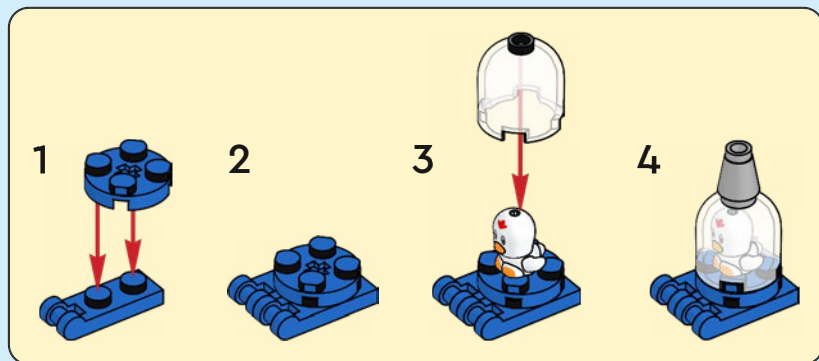



1x

11



2x

12

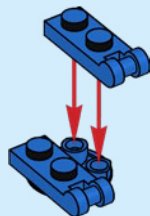



1x

13

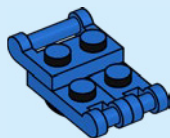

2x



1x

14





2x



2x

15

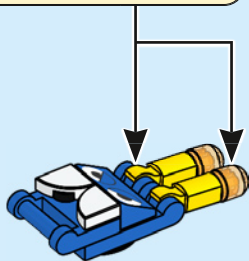
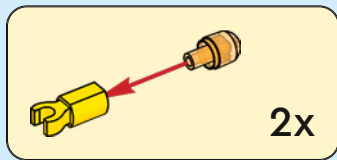

16

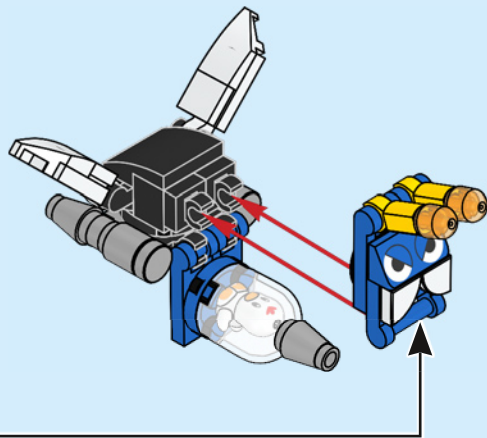

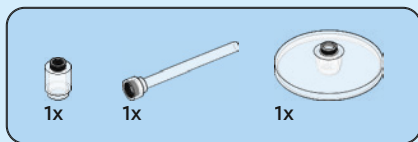

17

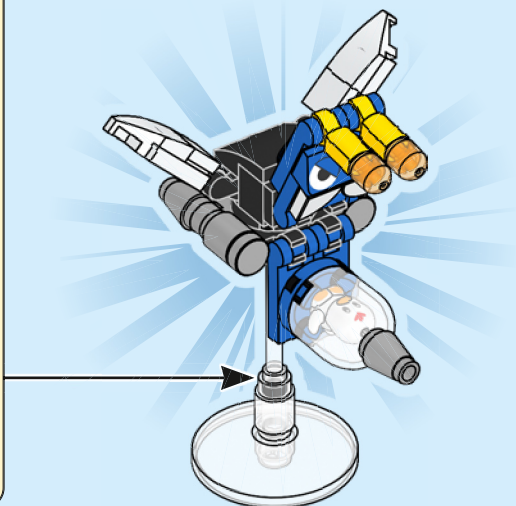
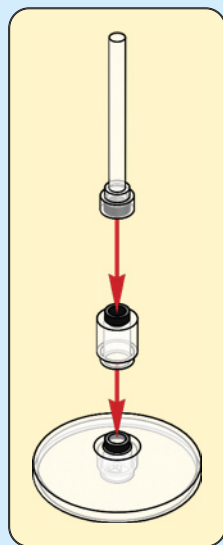



1

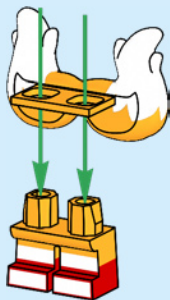

2

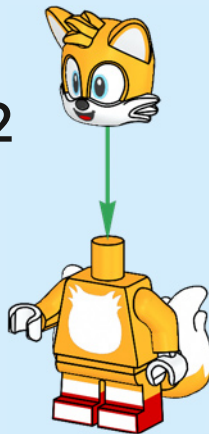

3



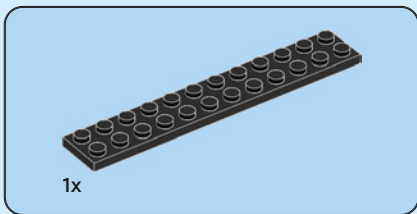
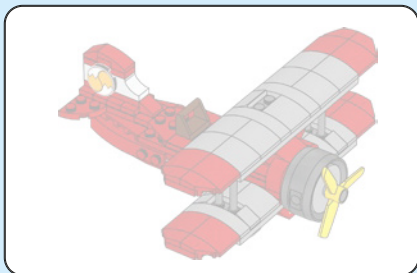

1

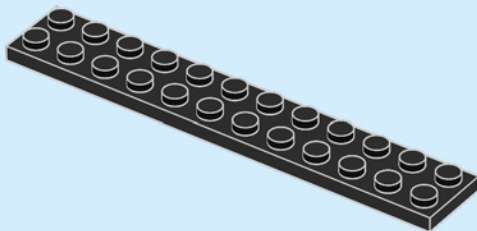

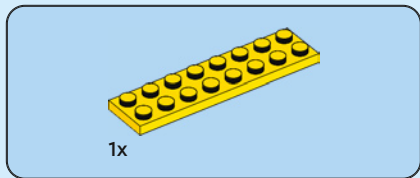

2

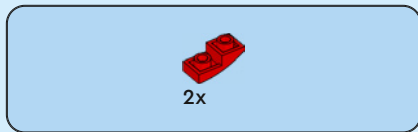
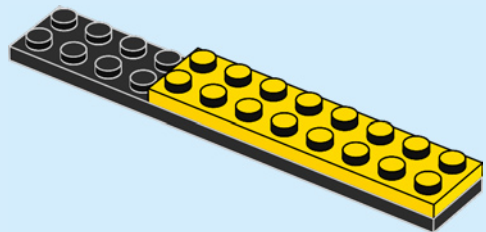

3

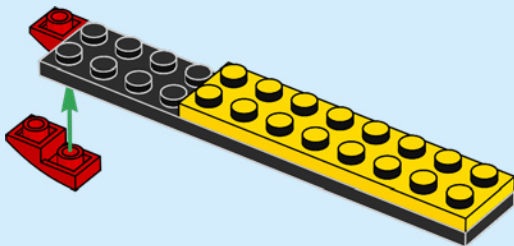



2x



1x

4

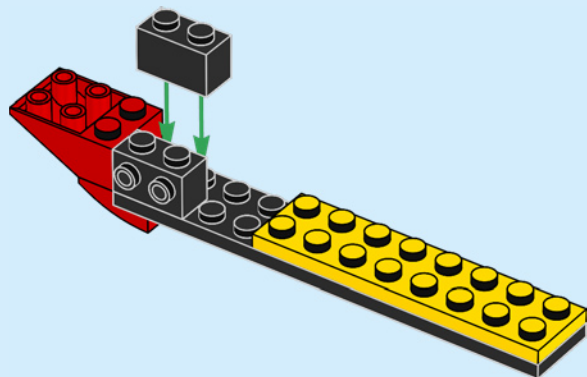

1x



2x

5

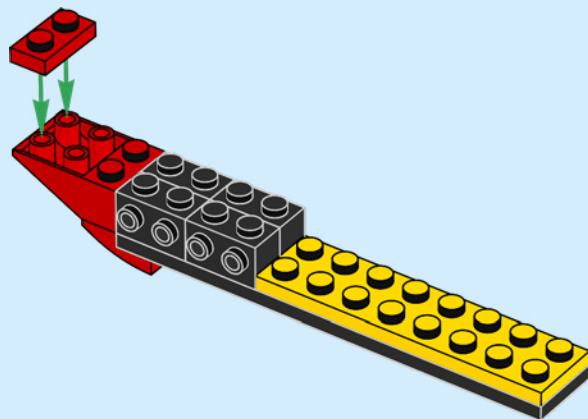

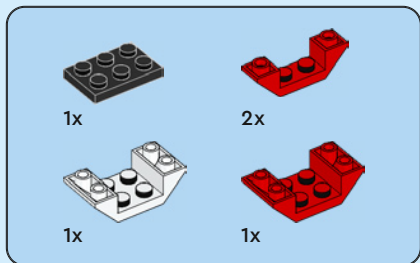

6

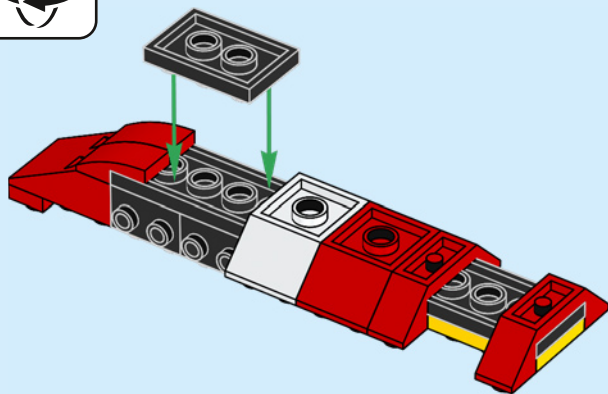

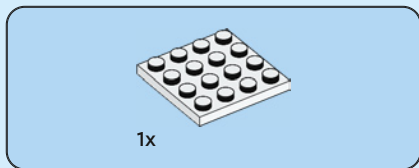

7

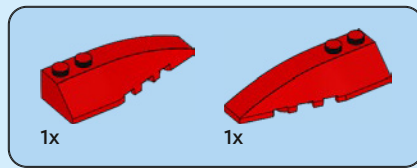
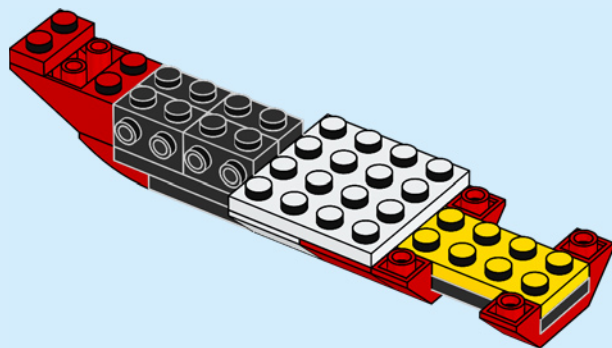

8

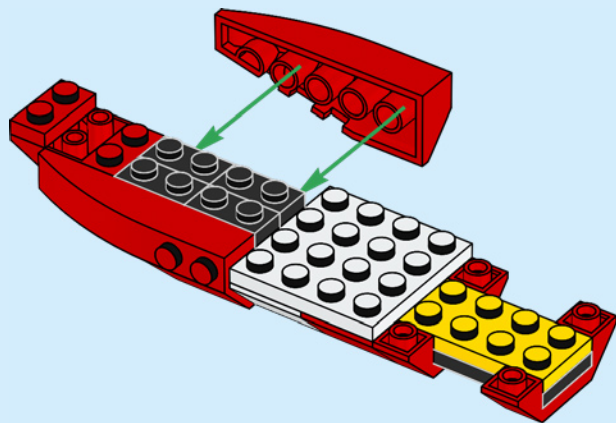

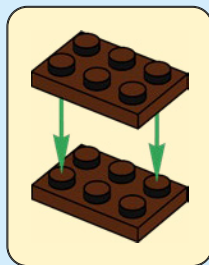
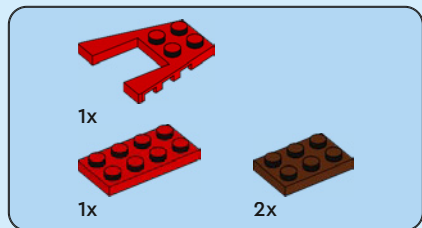

9

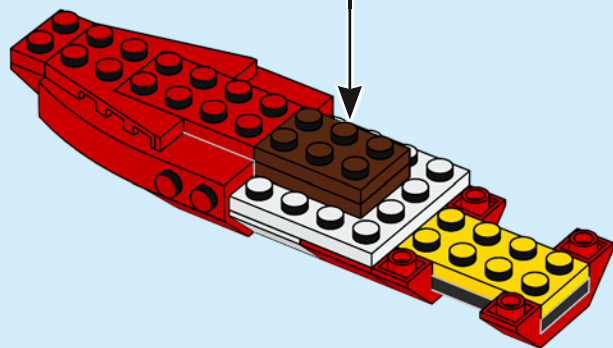

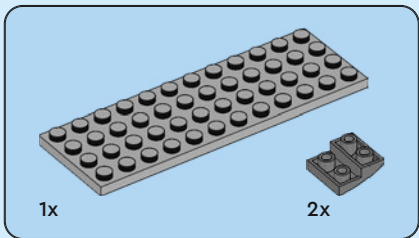
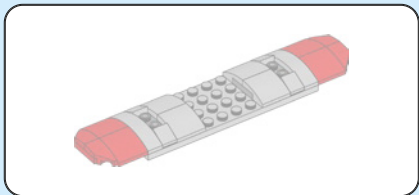

10

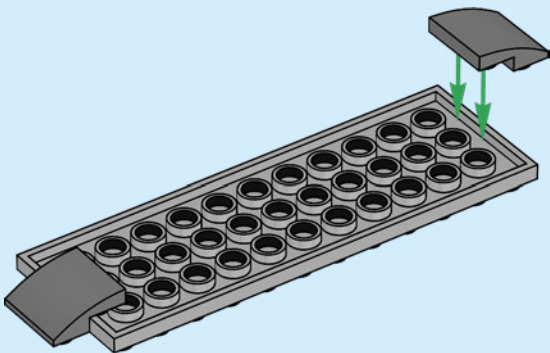



2x

11

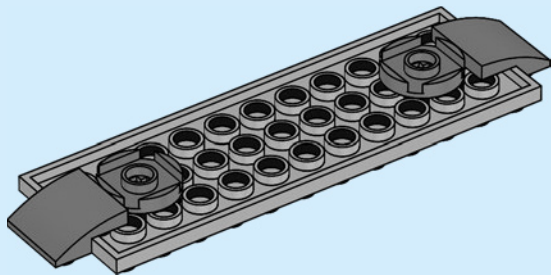

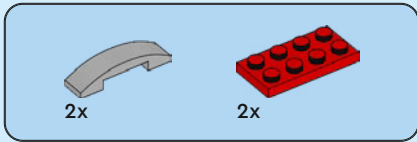

12

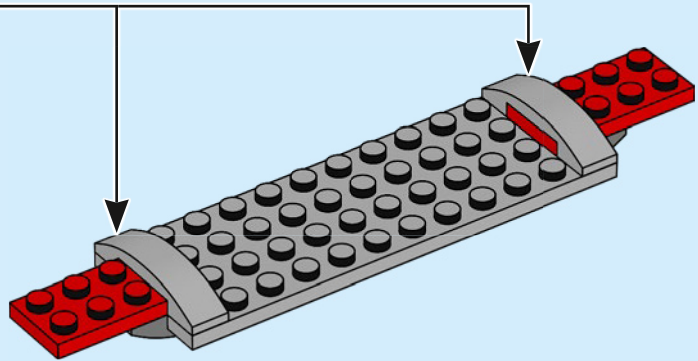
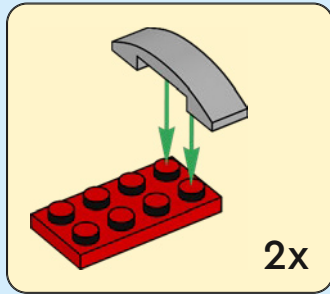



2x



2x



4x

13

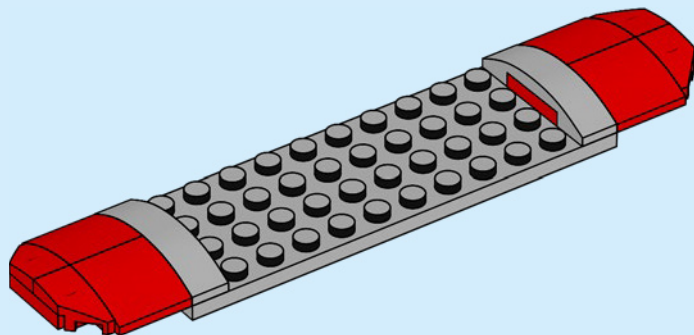



4x



2x

14

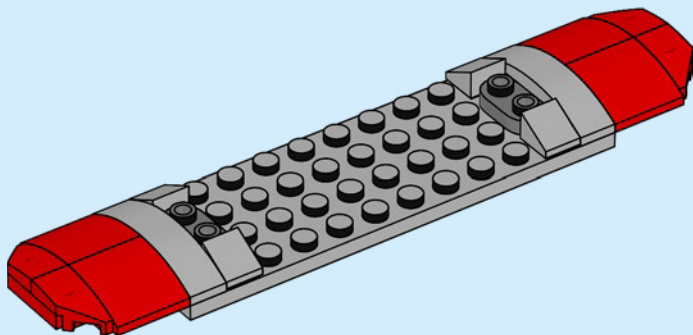



2x

15

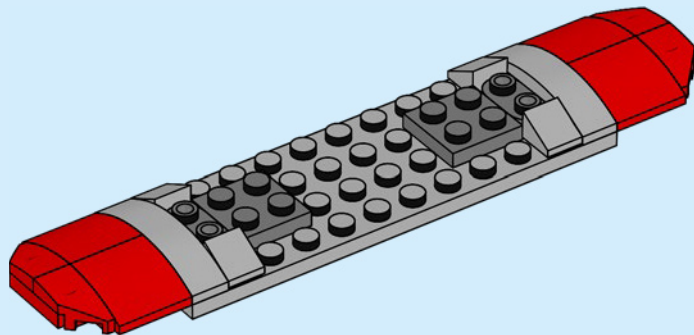



4x

16

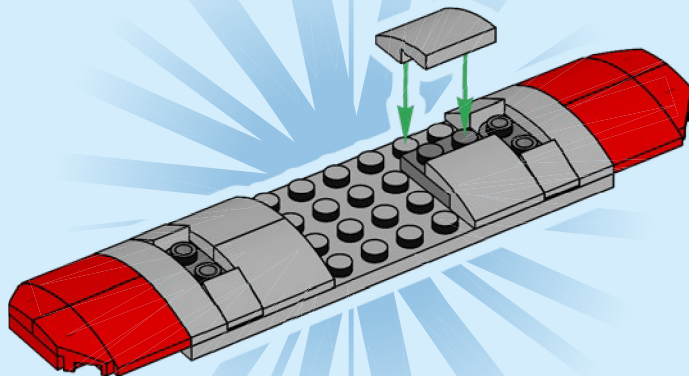

17

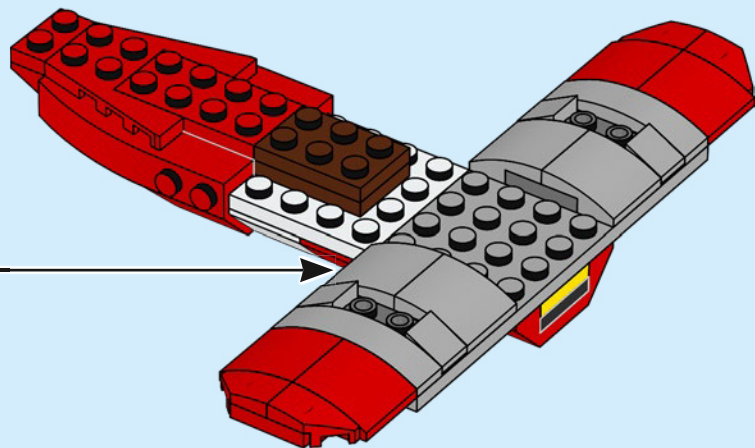

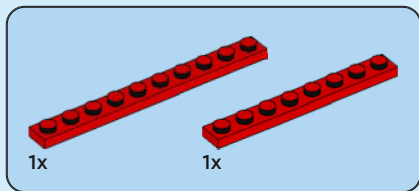

18

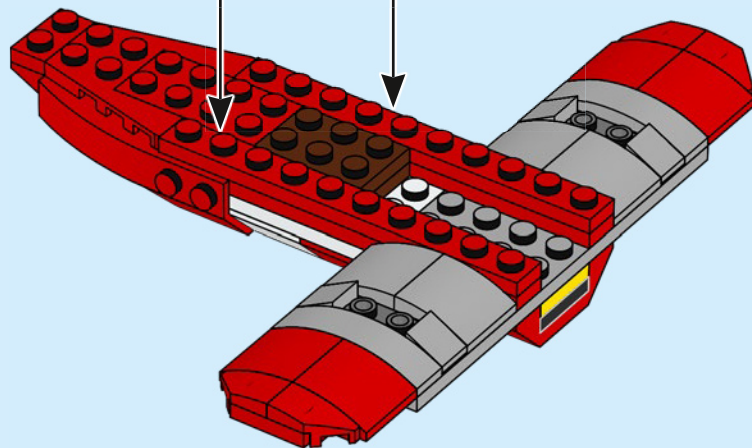
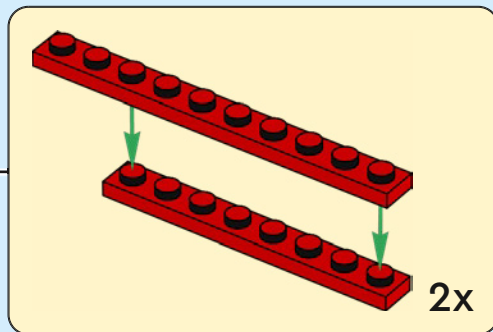

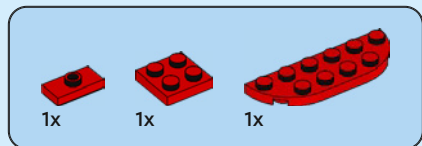

19

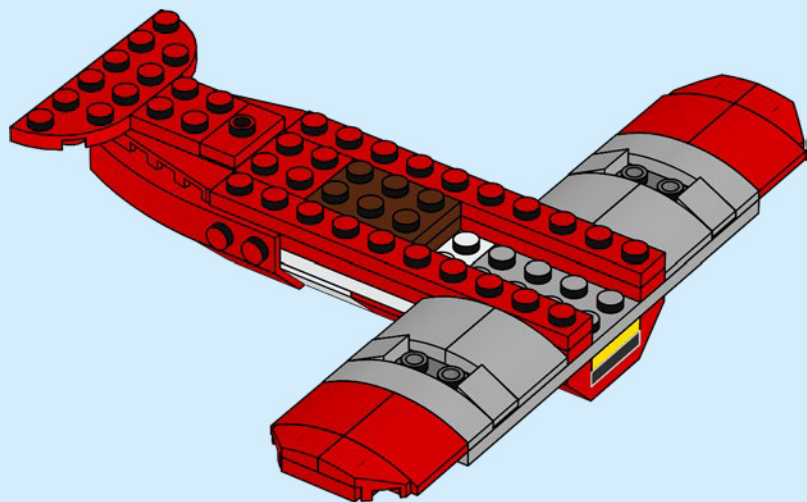



1x



1x

20

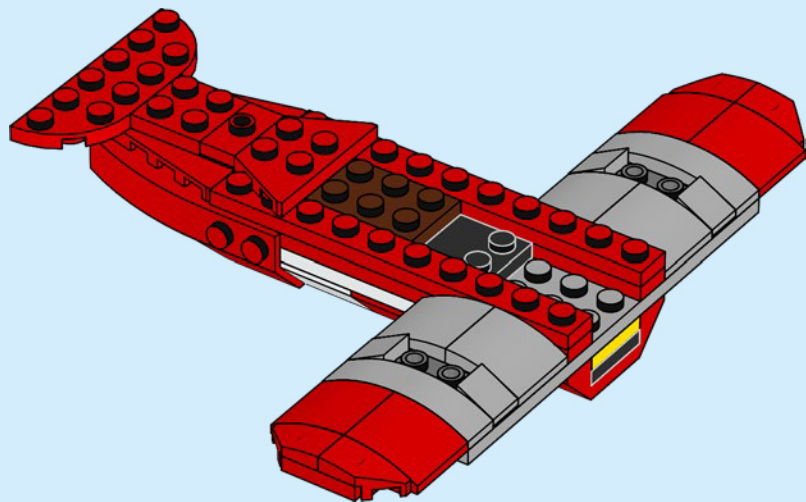

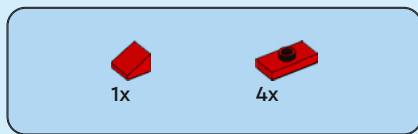

21

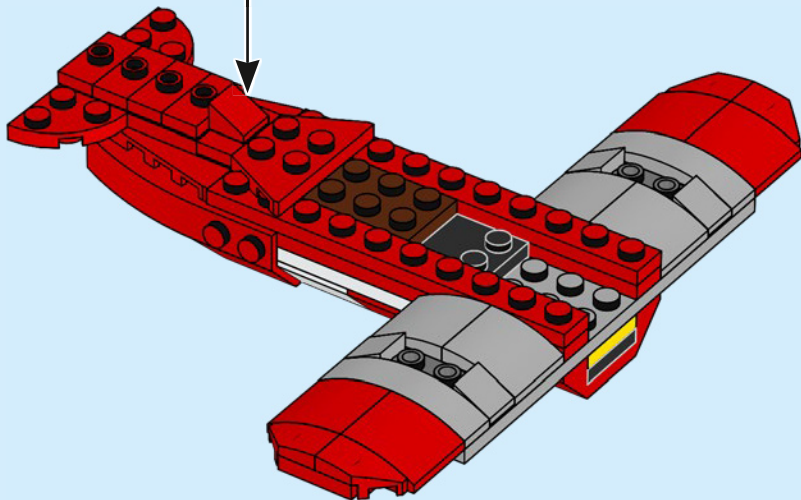
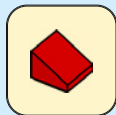



2x



1x

22

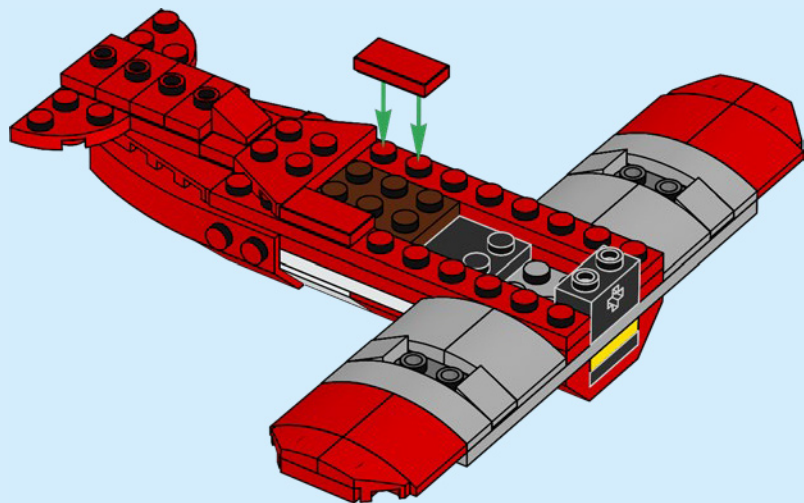



1x



2x

23

1



2

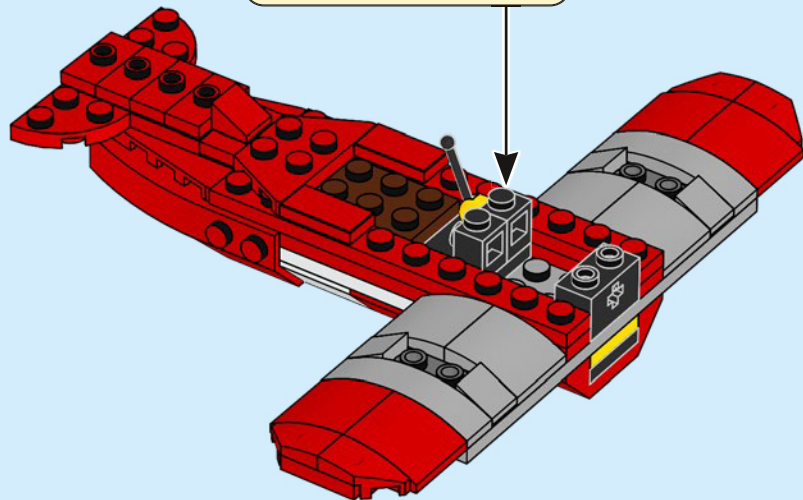

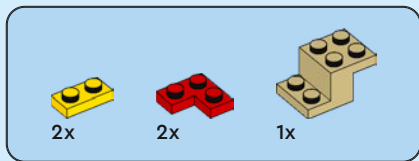

24

1

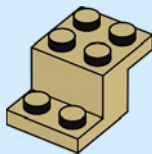

2

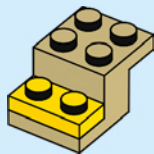

3

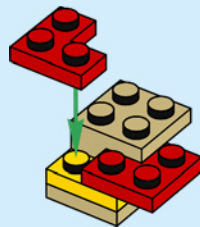

4

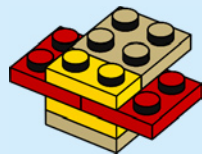

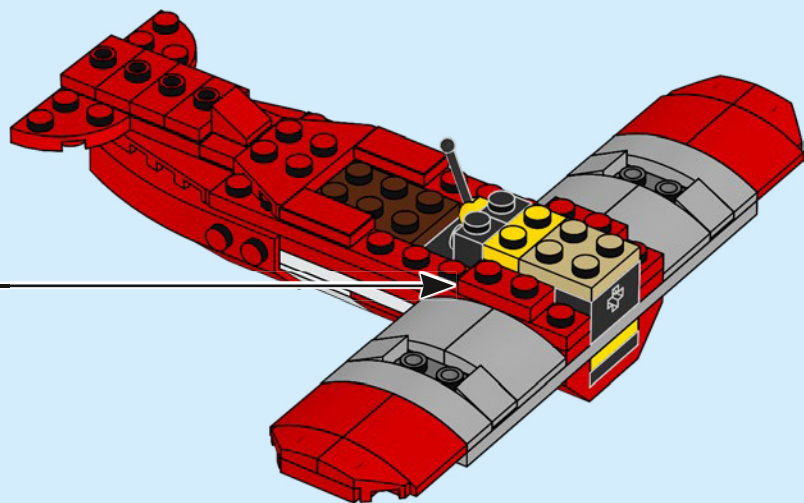



2x



1x

25

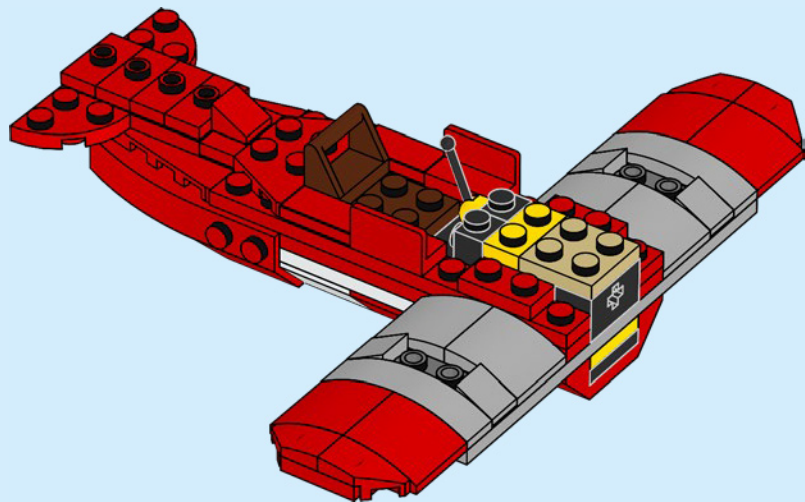



2x

26

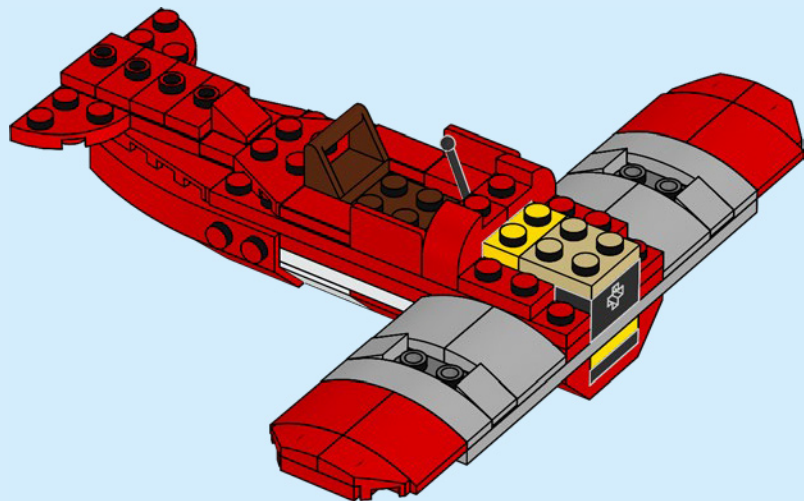



2x



2x

27

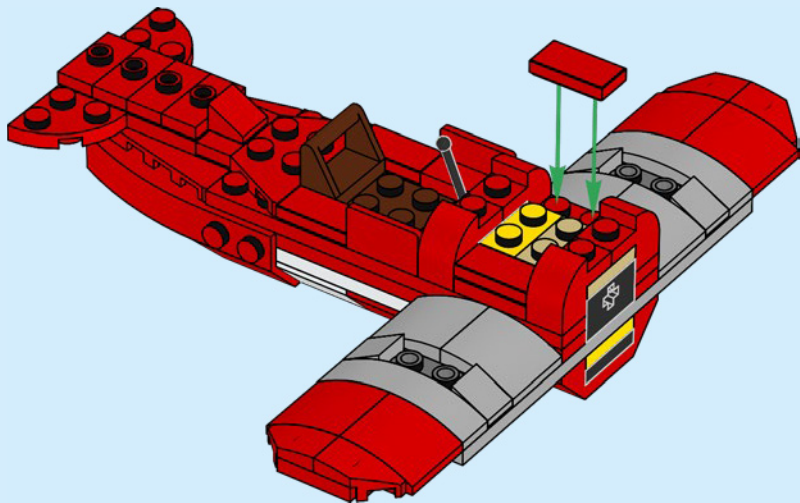

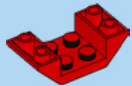

1x

28

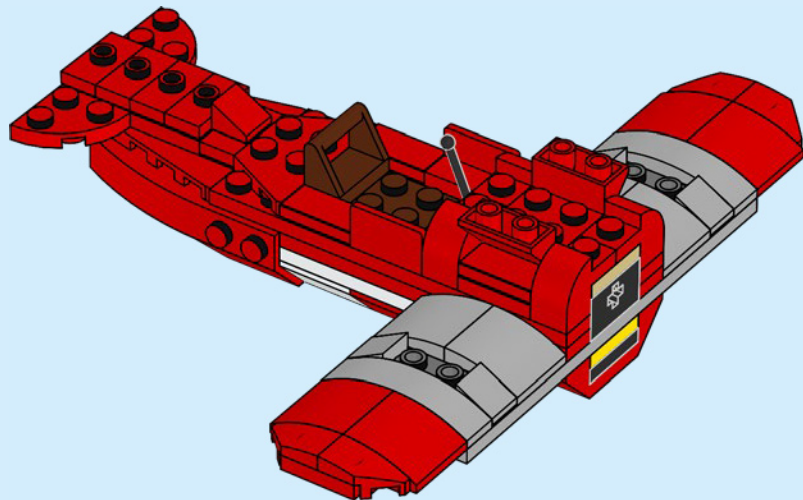



1x

29

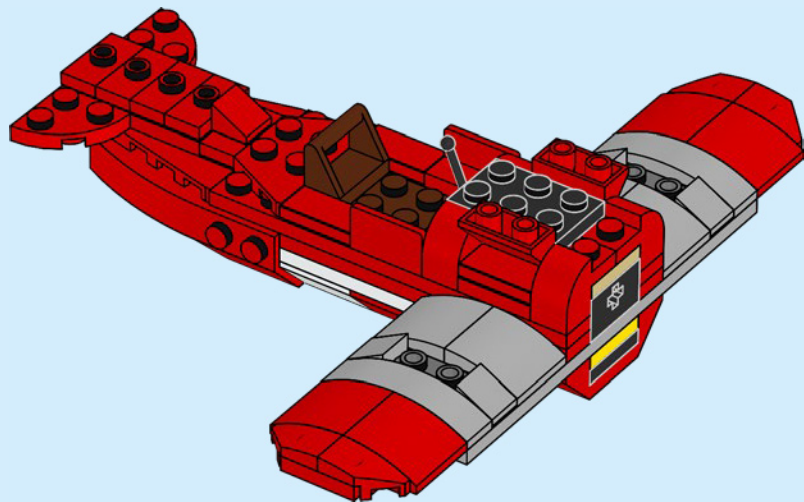



1x



1x



1x

30

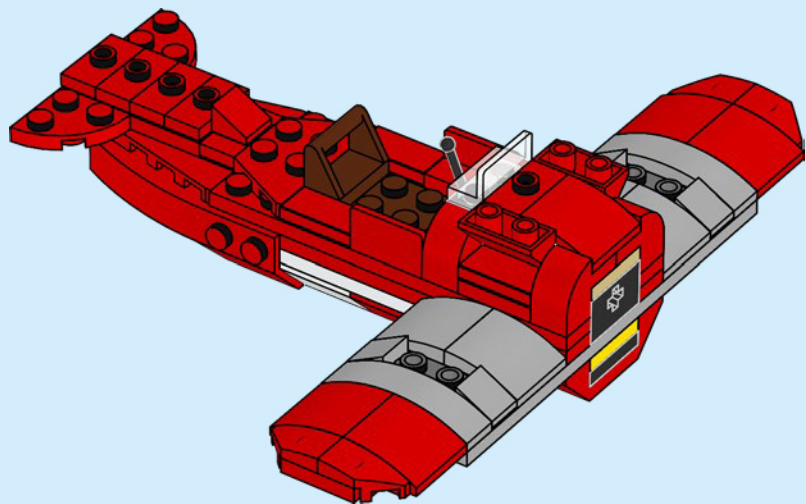



1x



1x

31

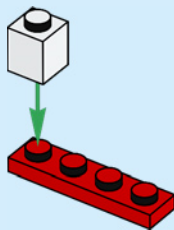



1x



1x

32

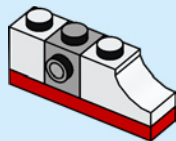

1x

33

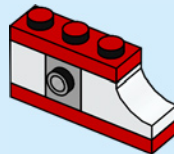



2x

34

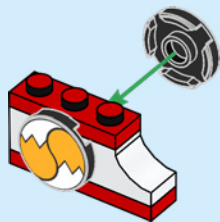

1x

35

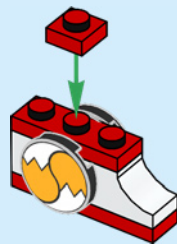



1x



1x

36



37

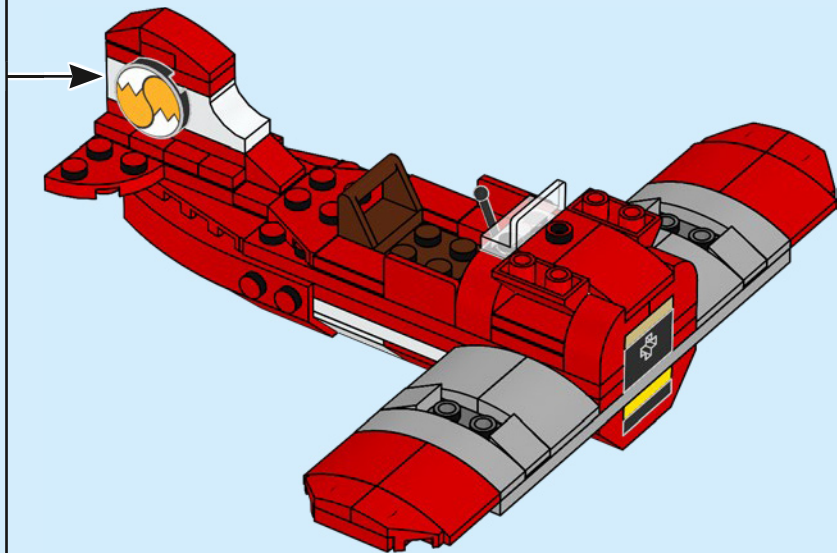



2x

38

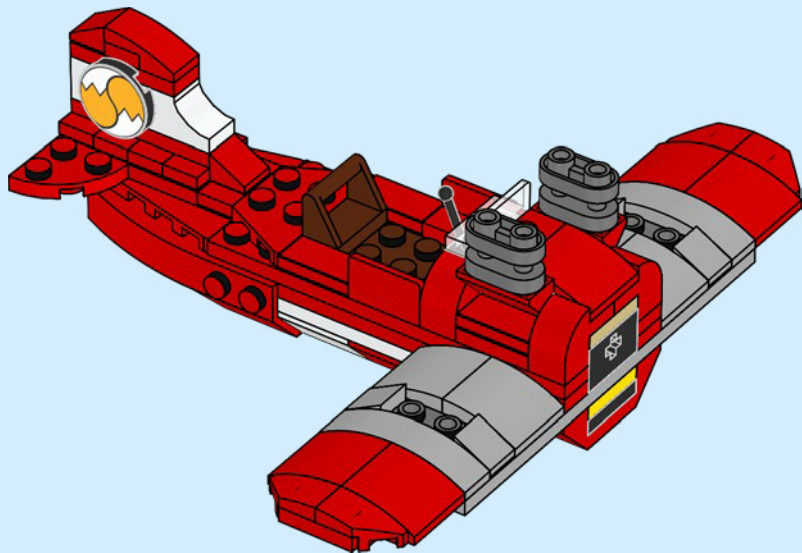

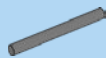

4x

39

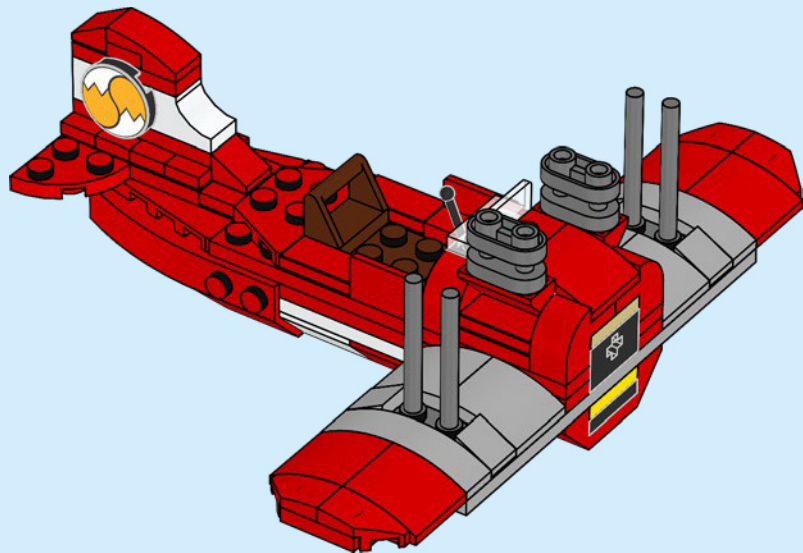

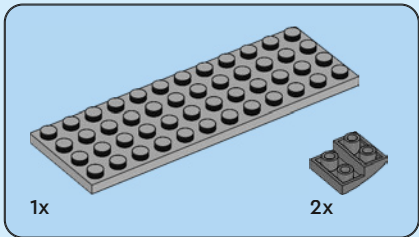
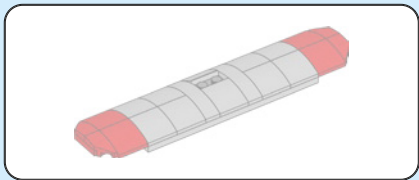

40

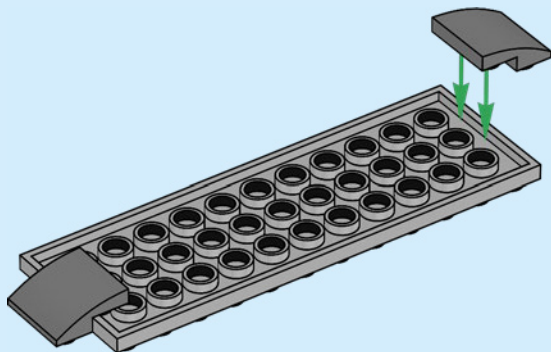



41

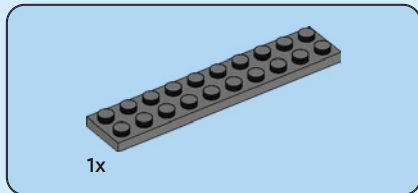
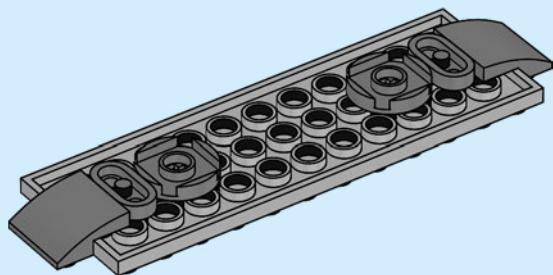

42

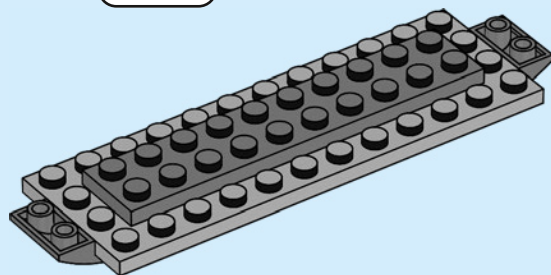

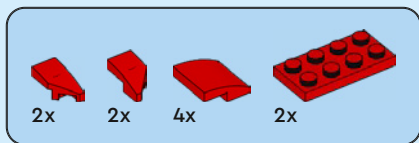

43

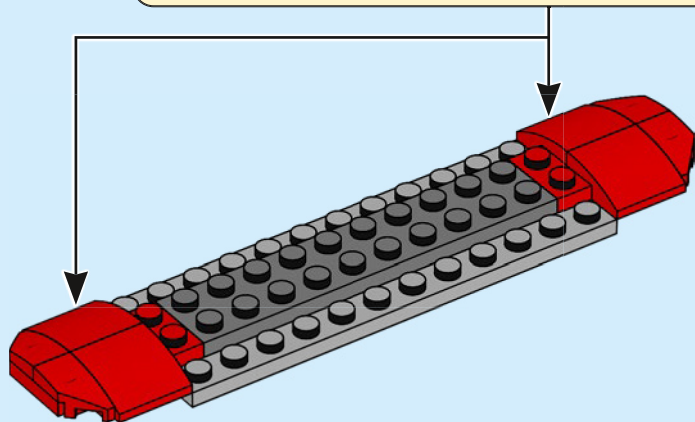
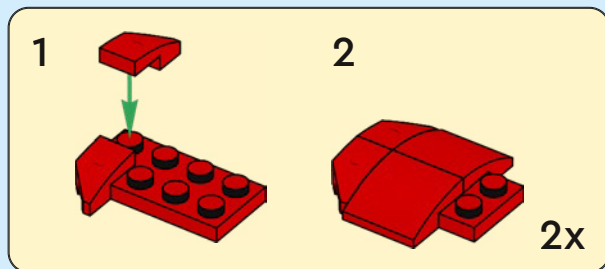



4x

44

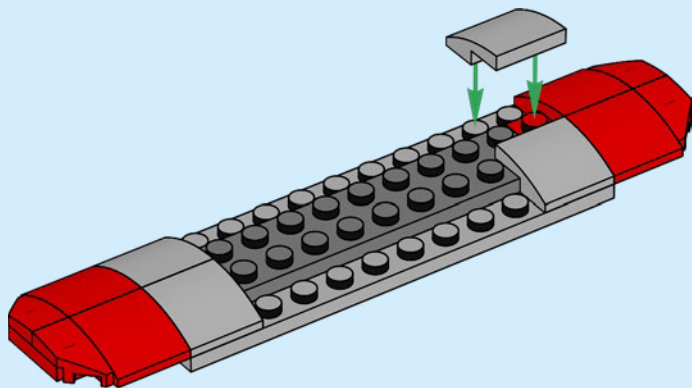



4x



2x

45

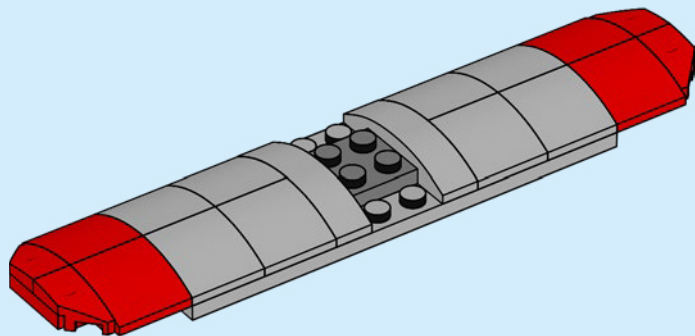



1x



1x

46

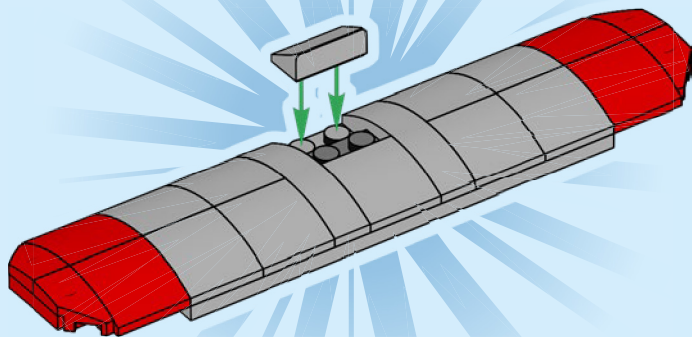

47

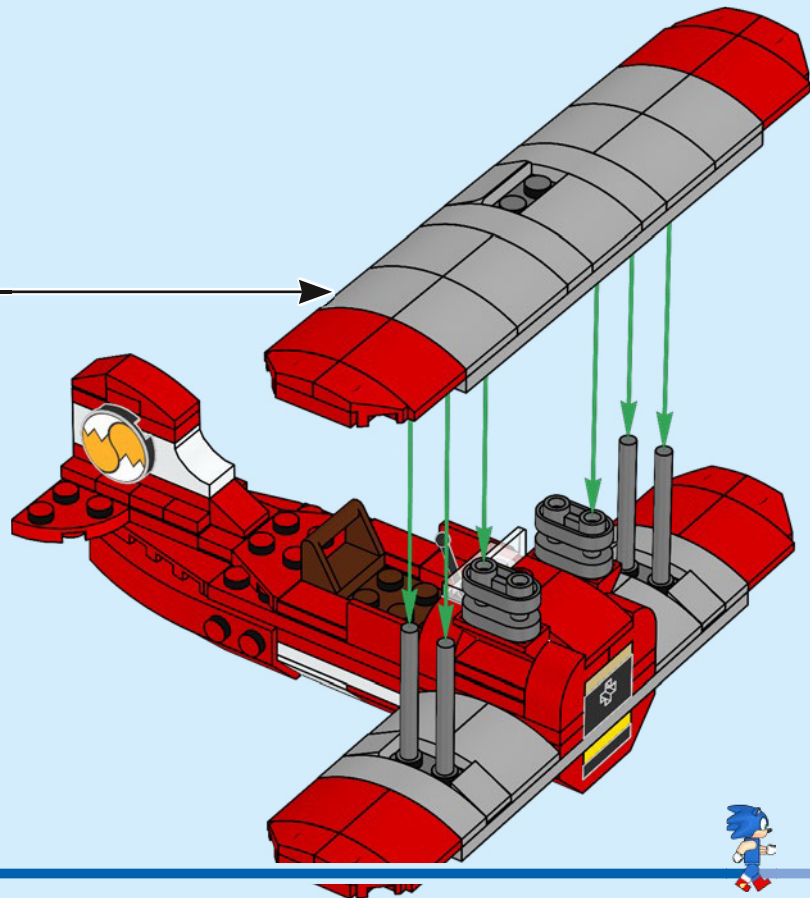

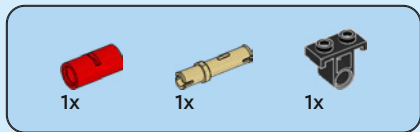

48

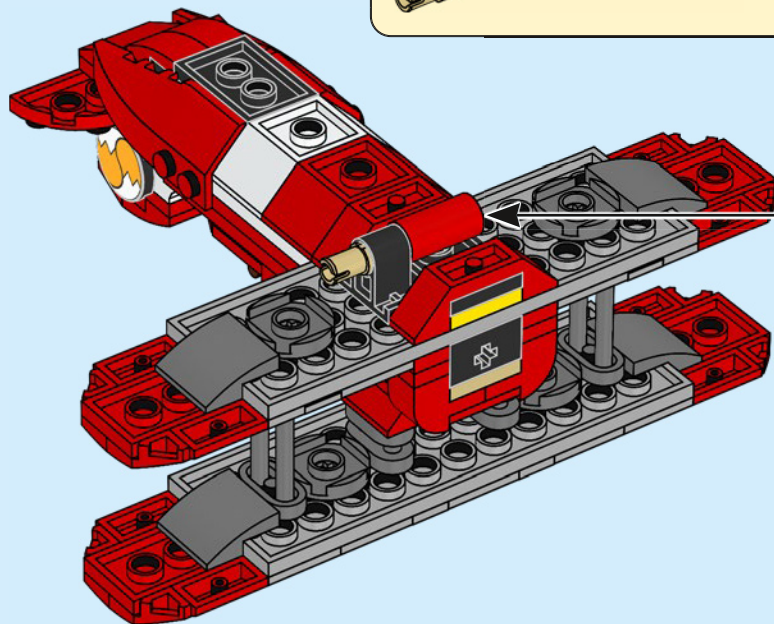
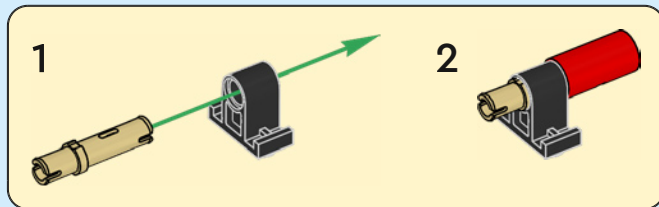



1x



1x

49

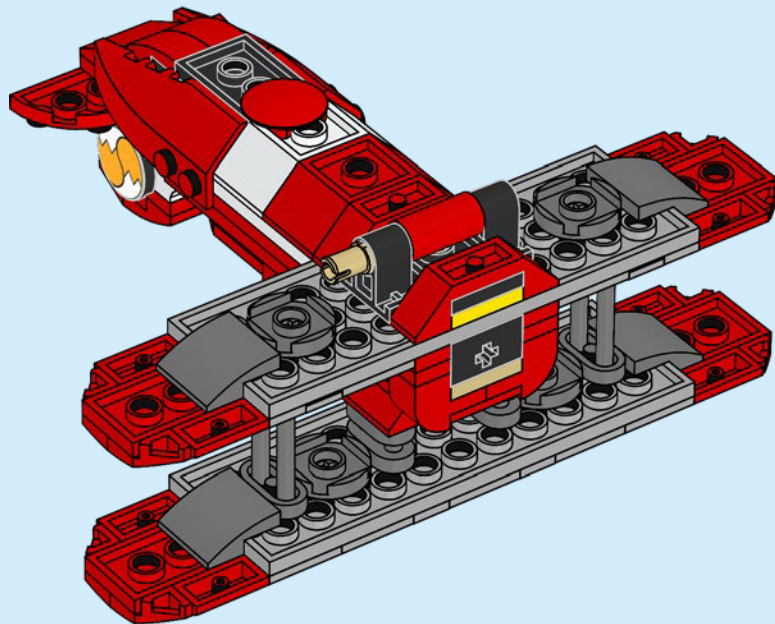



1x

50

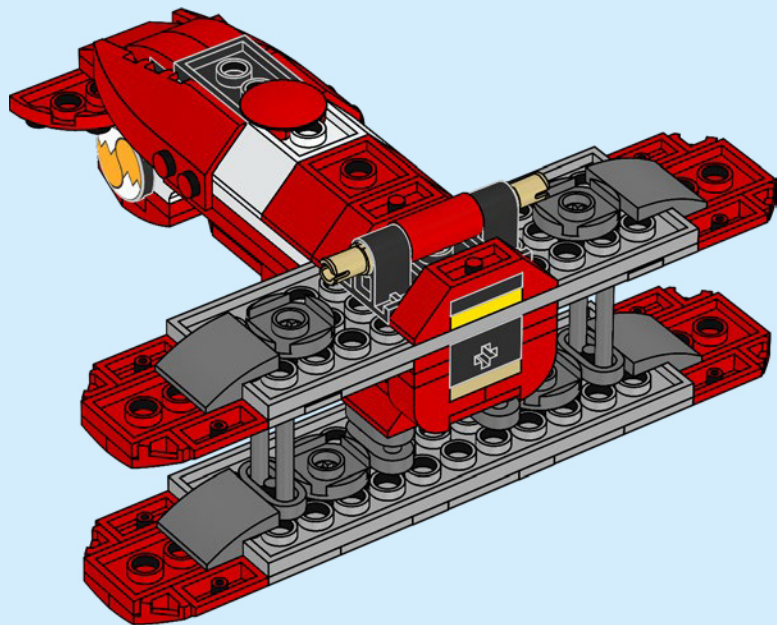



2x



2x

51



2x

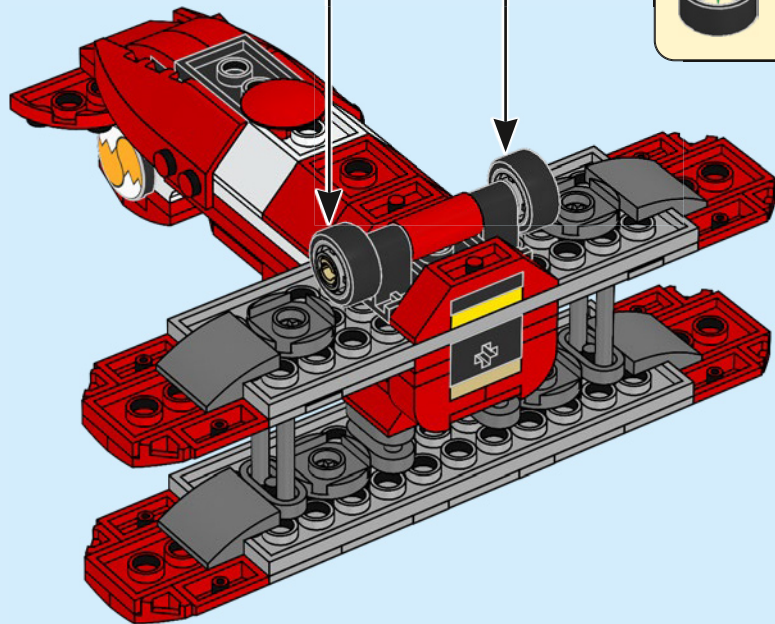

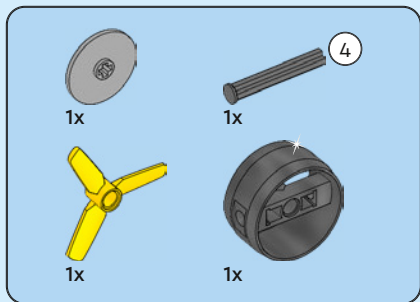

52

1

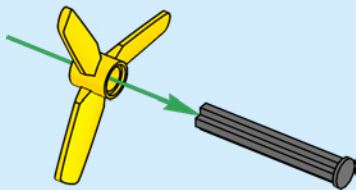

2

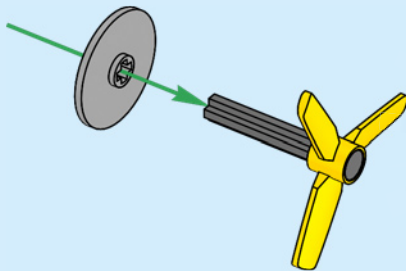

3

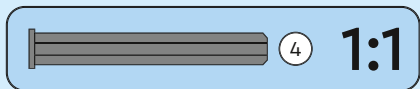

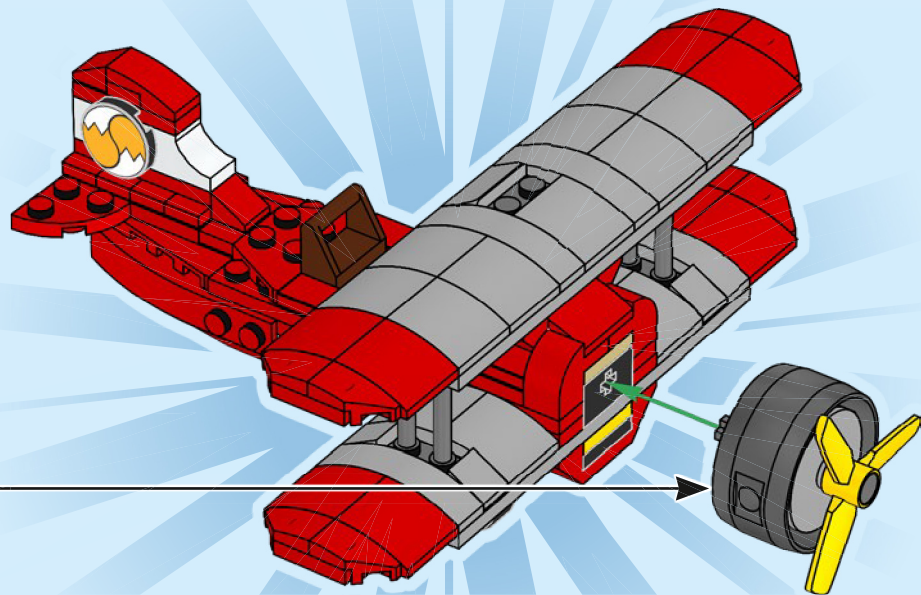



LEGO and the LEGO logo are trademarks of the LEGO Group. ©2023 The LEGO Group.
©SEGA. All rights reserved. SEGA is registered in the U.S. Patent and Trademark Office.
SEGA and SONIC THE HEDGEHOG are either registered trademarks or trademarks of
SEGA CORPORATION. 6493747

Rebuild
the
world™





SONIC™

THE HEDGEHOG

76991



2



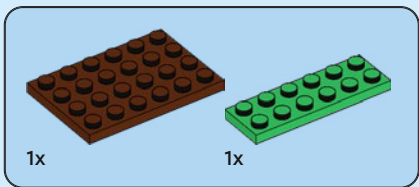
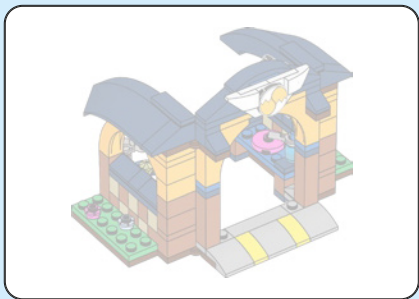

1

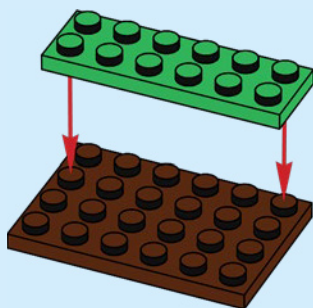

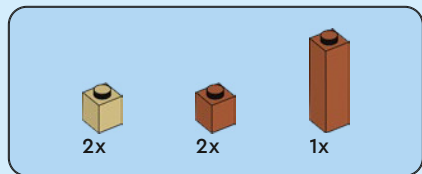

2

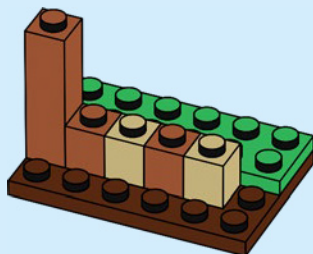



3

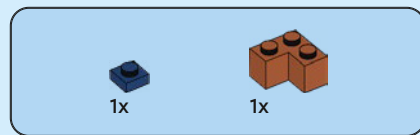
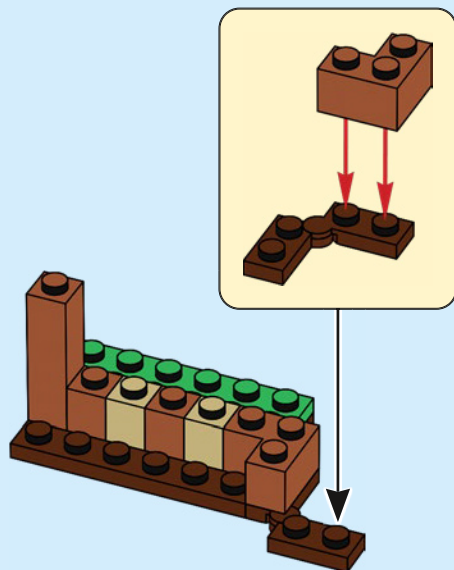

4

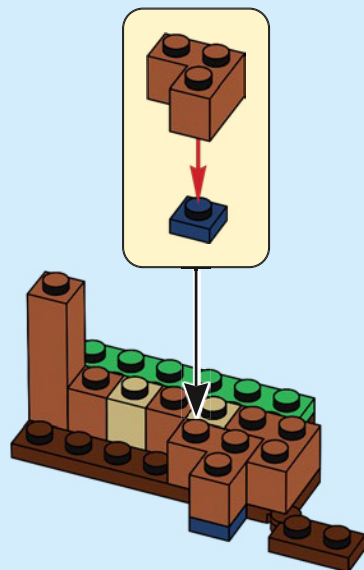



1x



1x

5

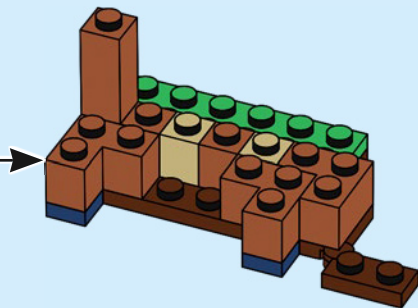
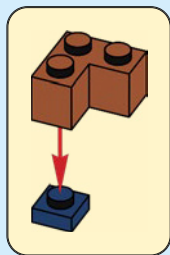

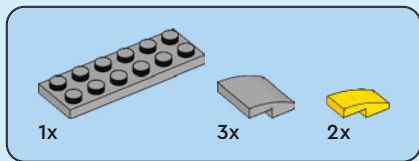

6

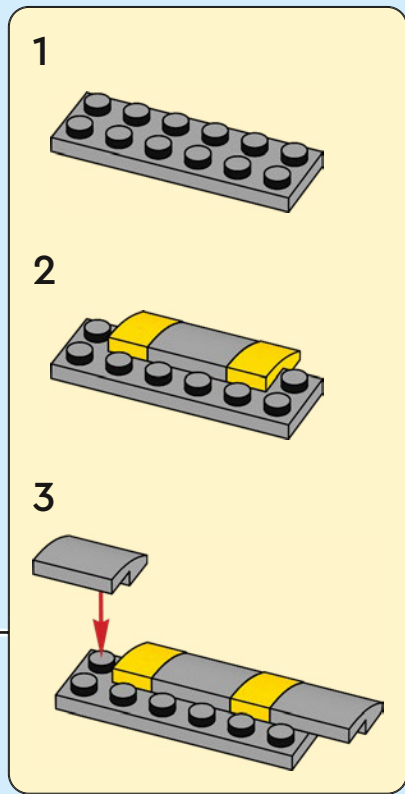
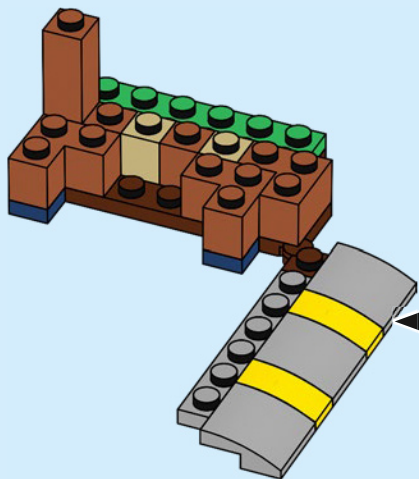

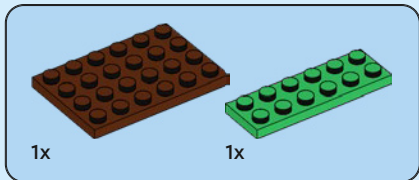
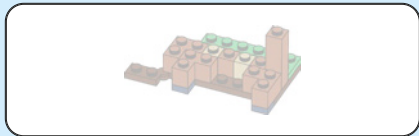

7

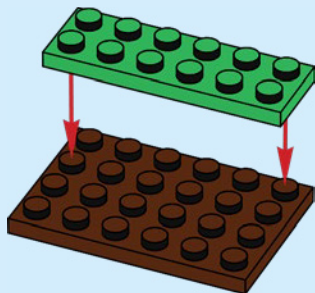

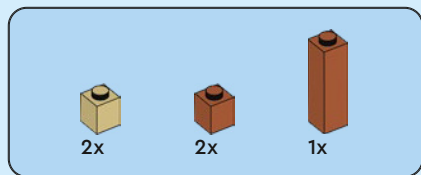

8

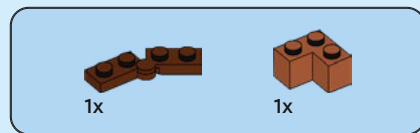
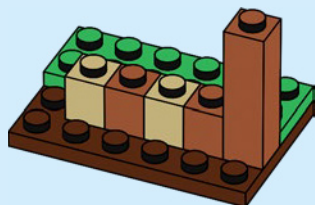

9

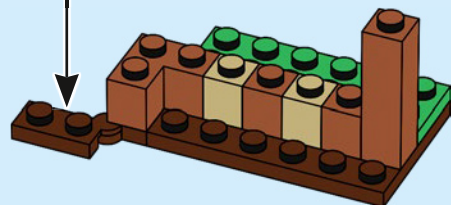
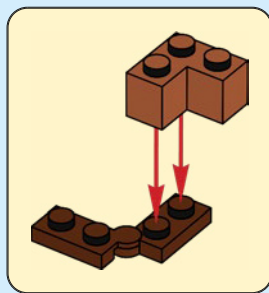



1x



1x

10

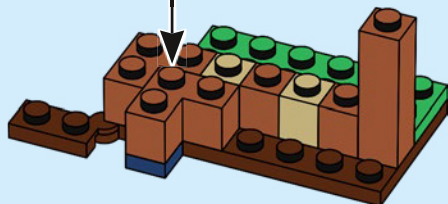
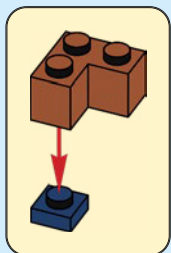

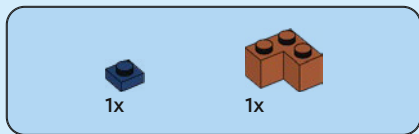

11

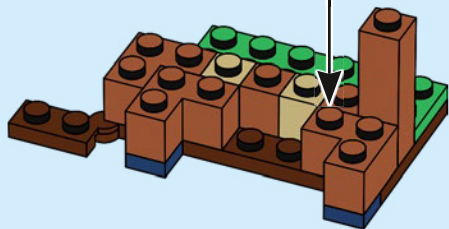
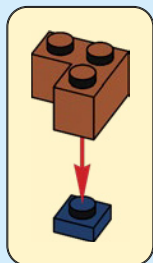

12

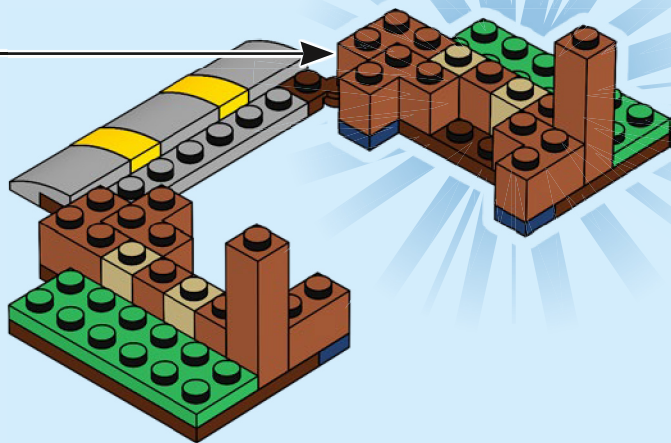

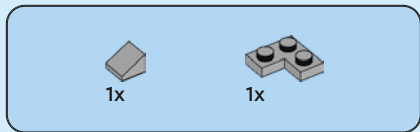

13

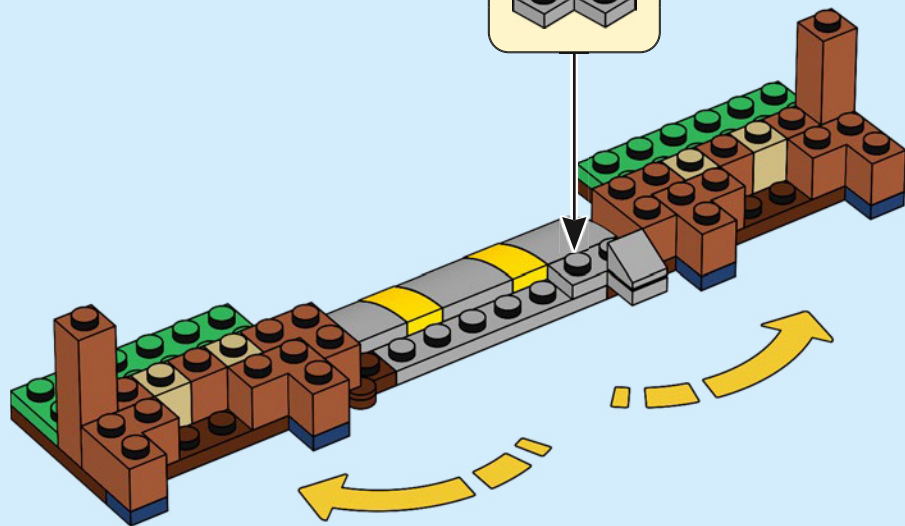
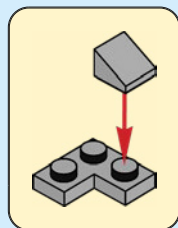

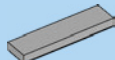

1x

14

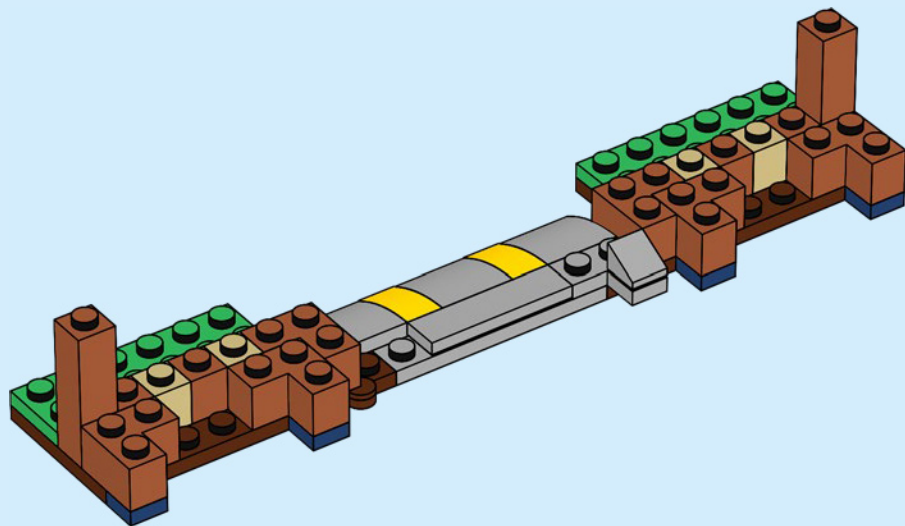

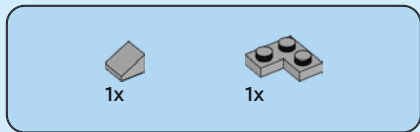

15

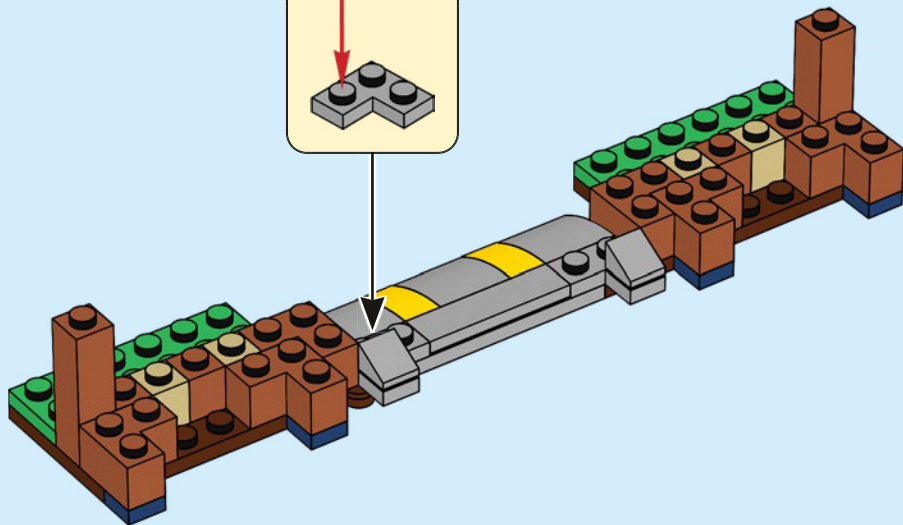
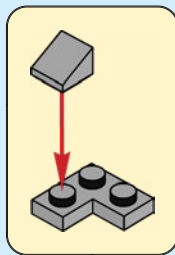



6x



4x

16

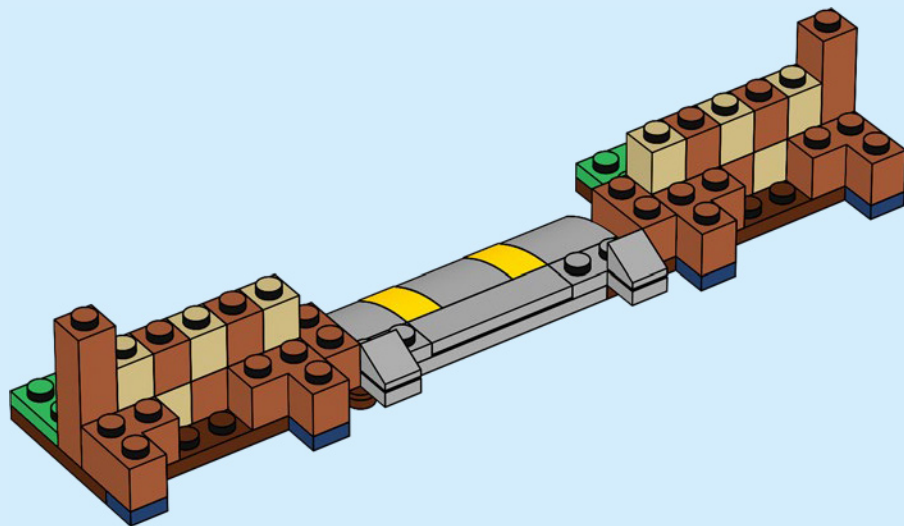

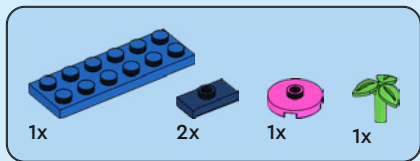

17

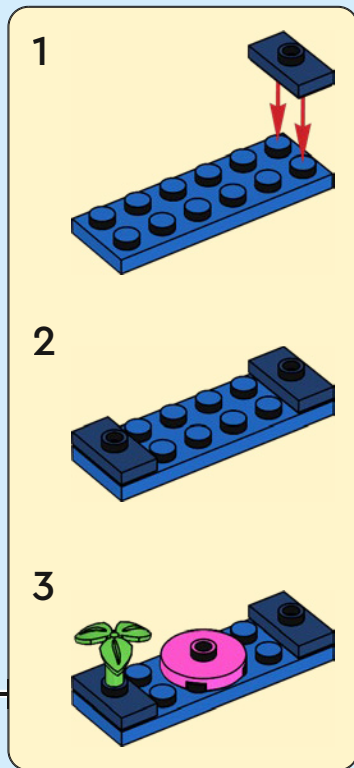
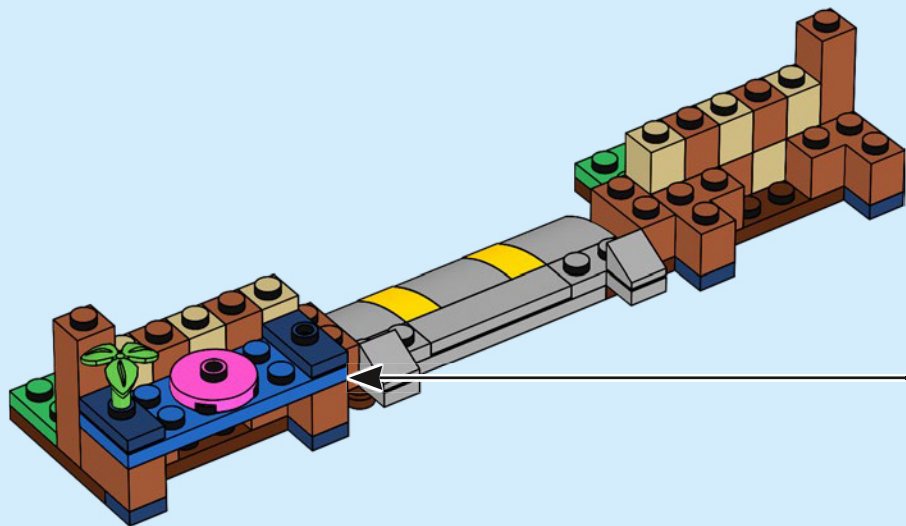

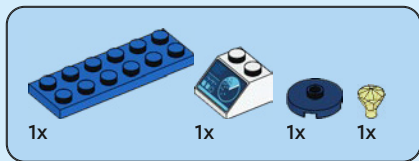

18

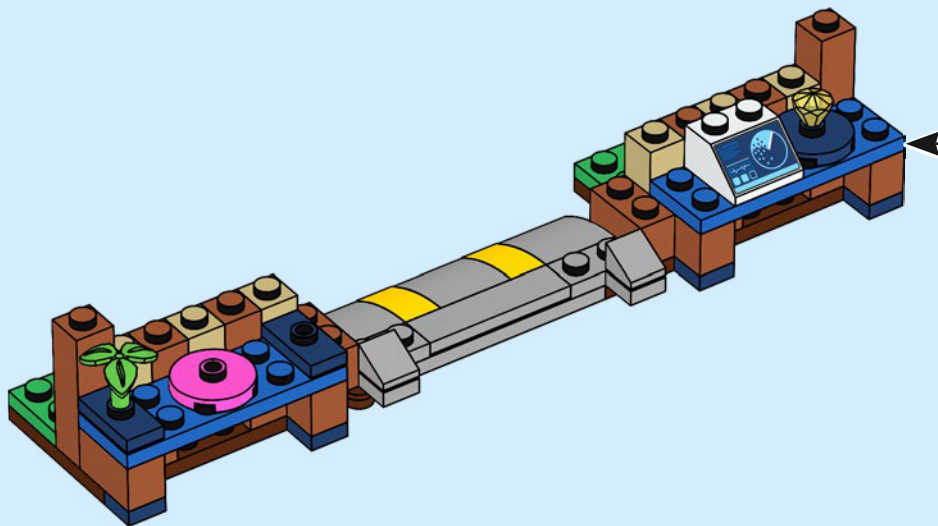
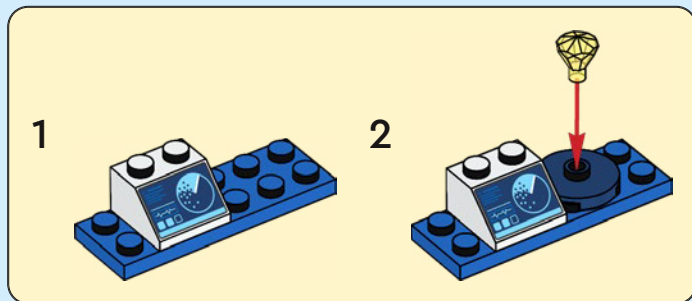



1x



1x

19

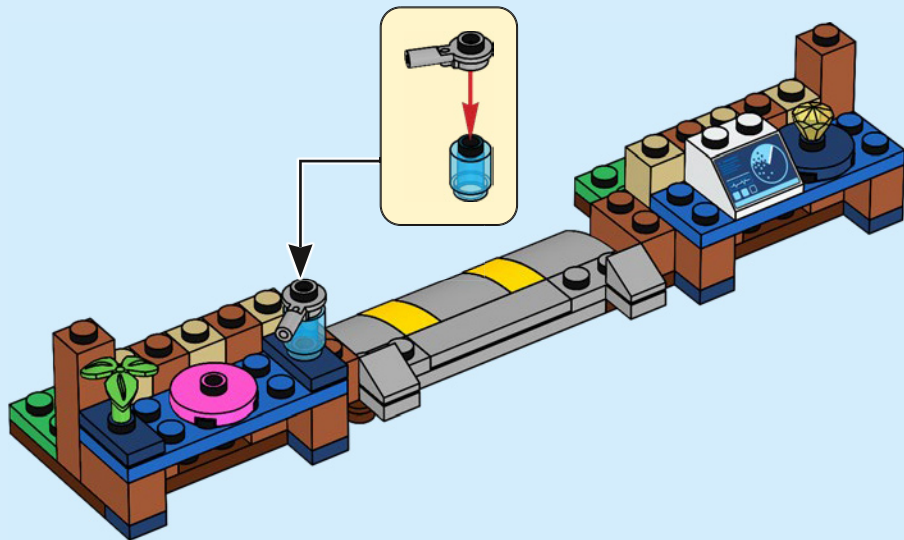

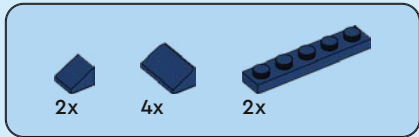

21

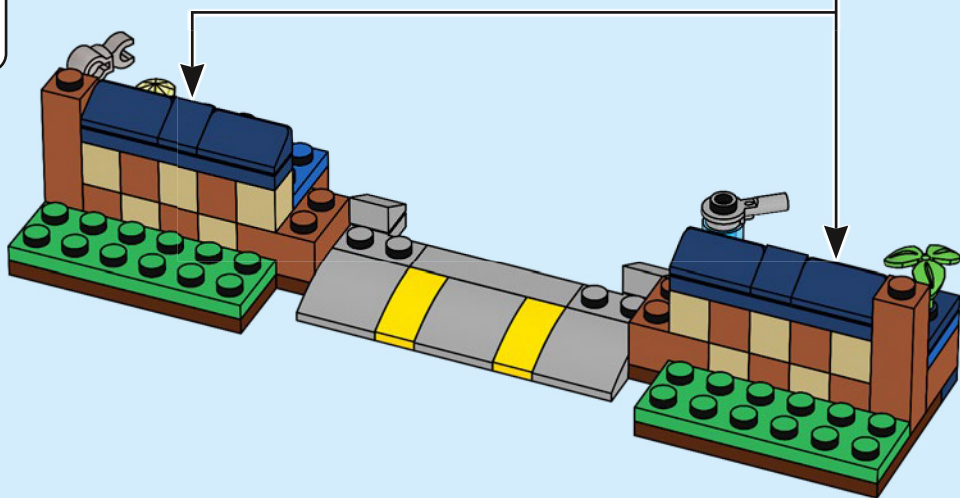
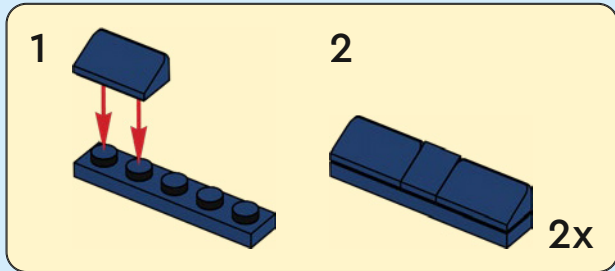



2x



2x

22

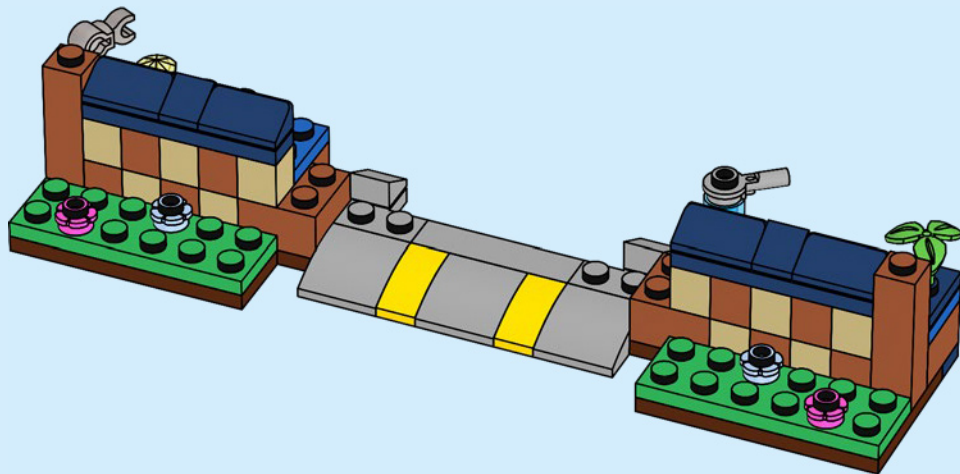

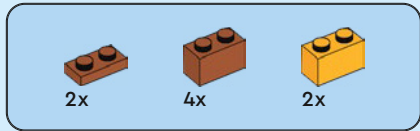

23

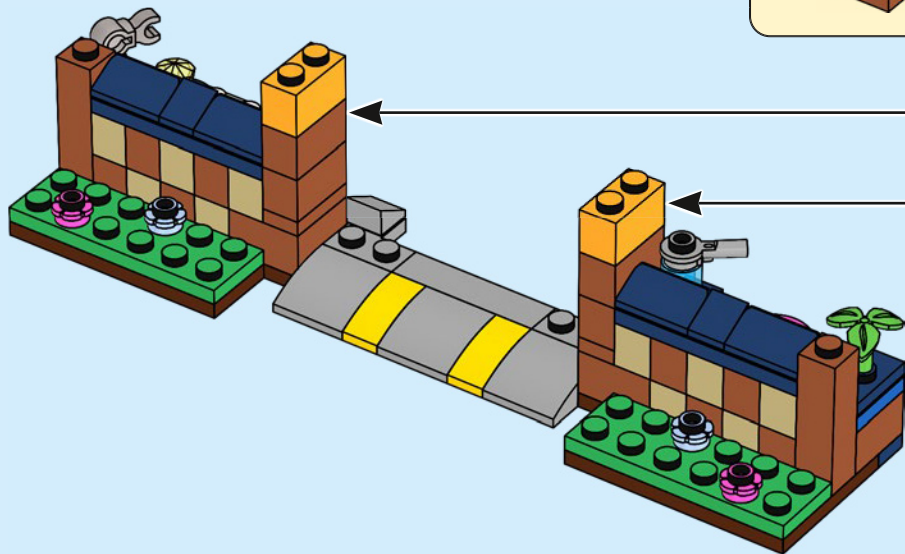
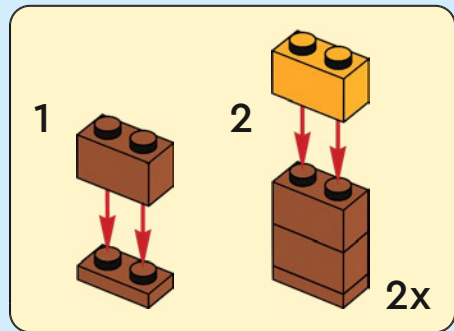

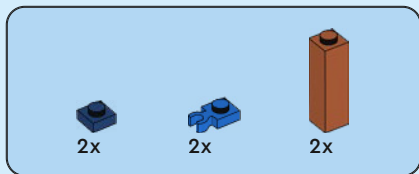

24

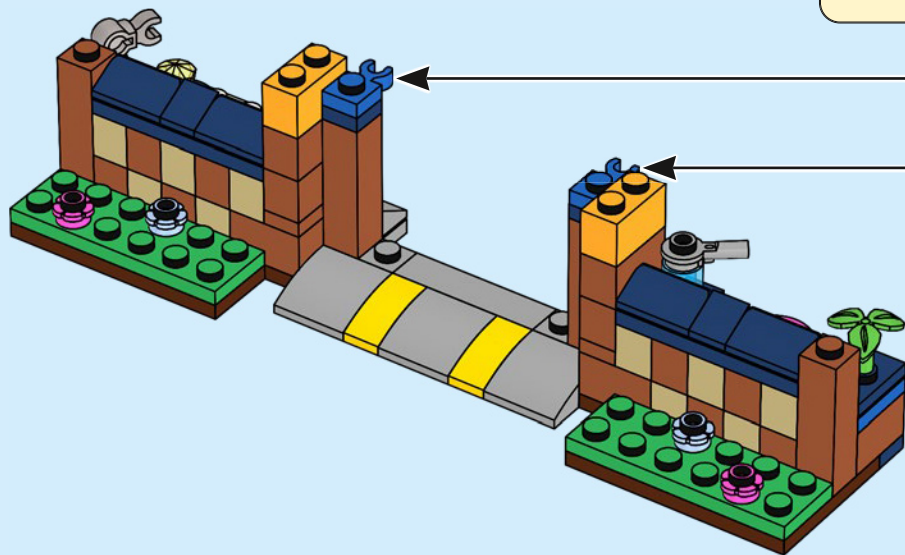
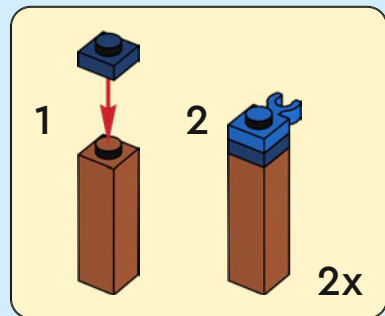

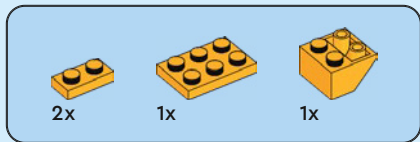

25

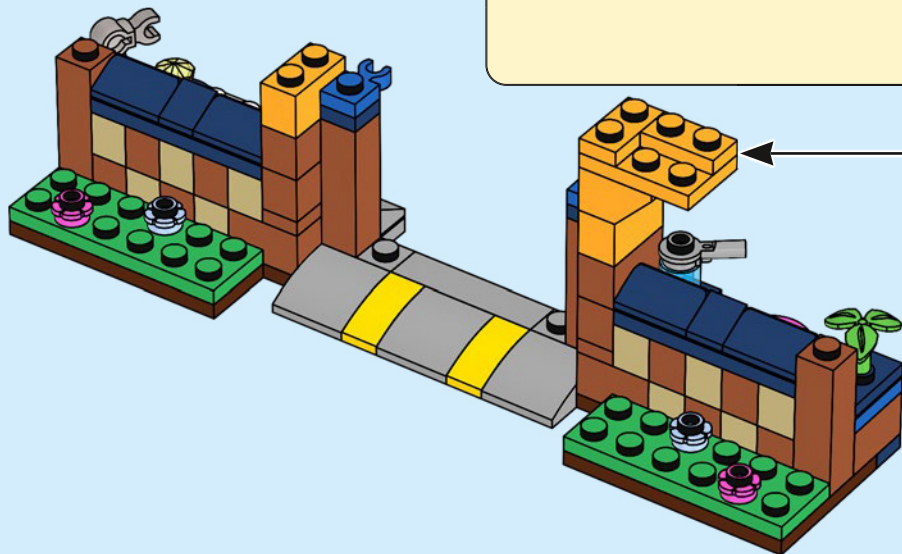
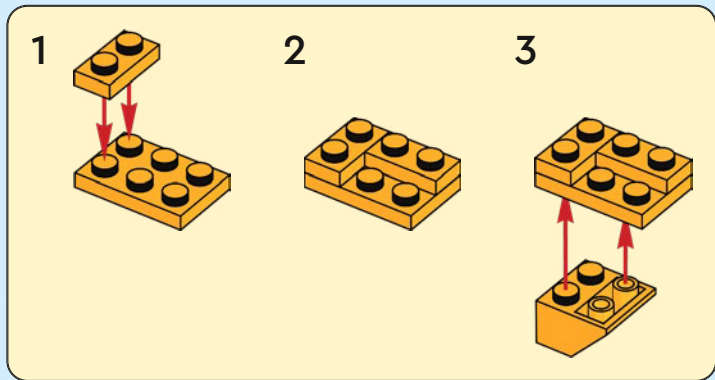

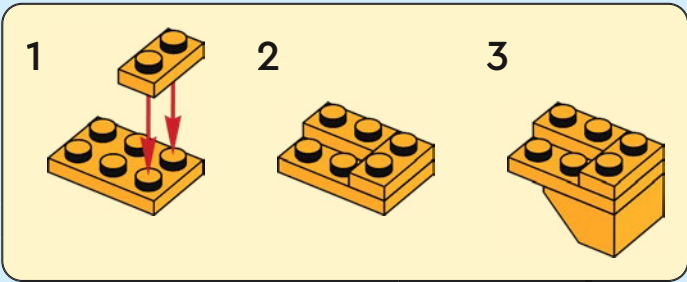

26

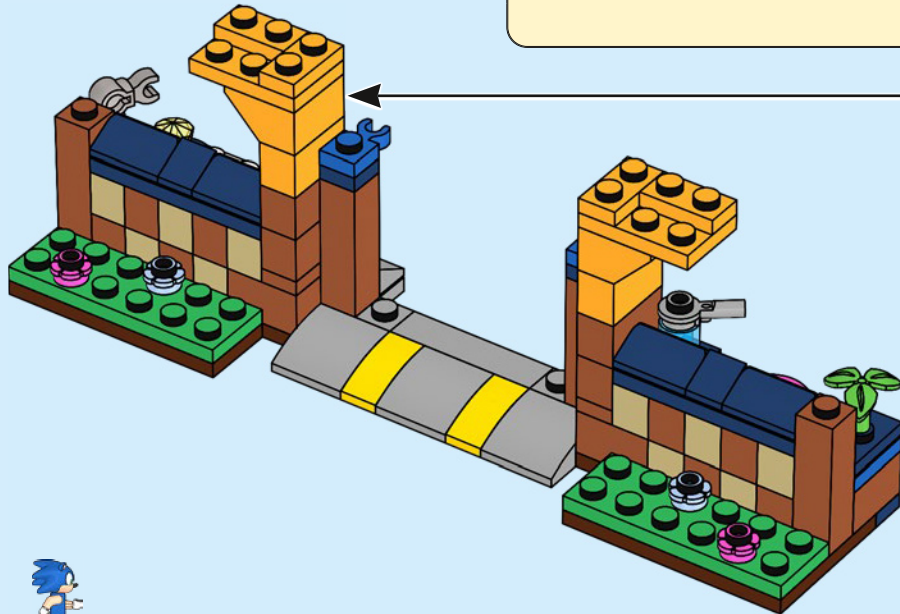

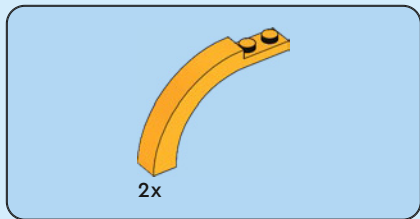

27

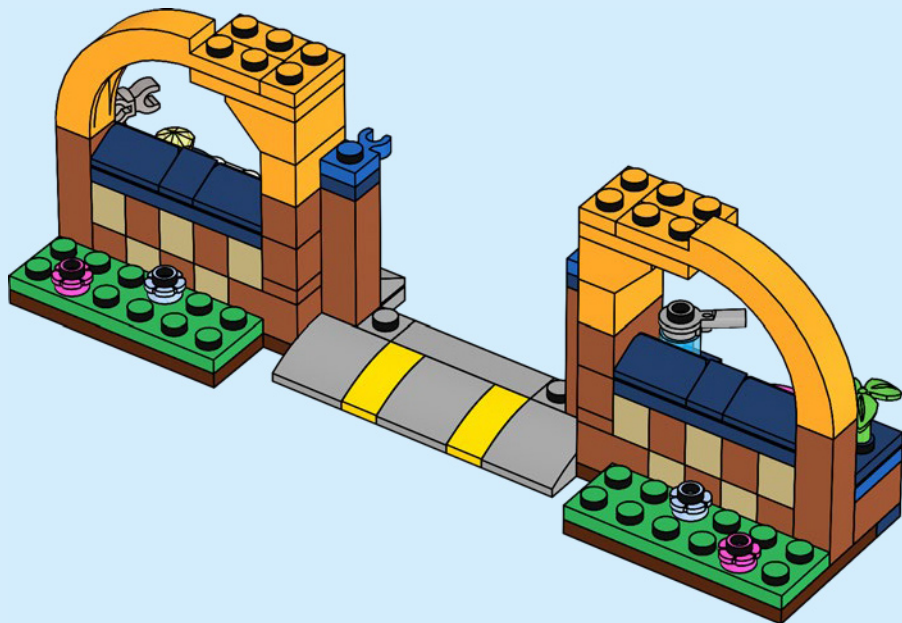



2x

28

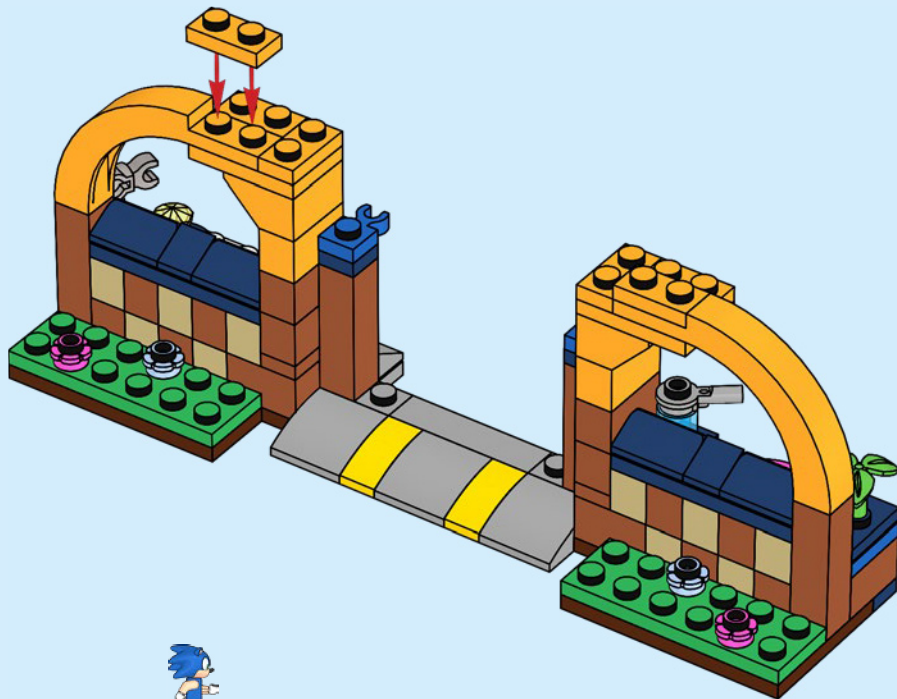



2x

29

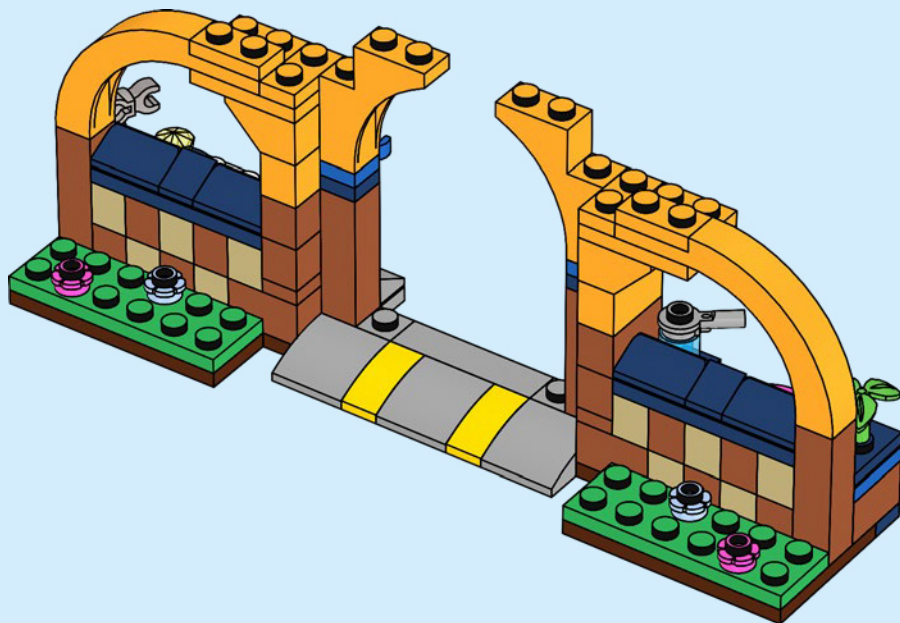

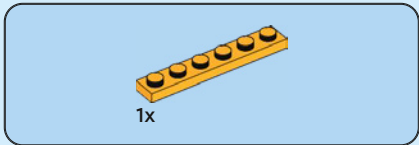

30

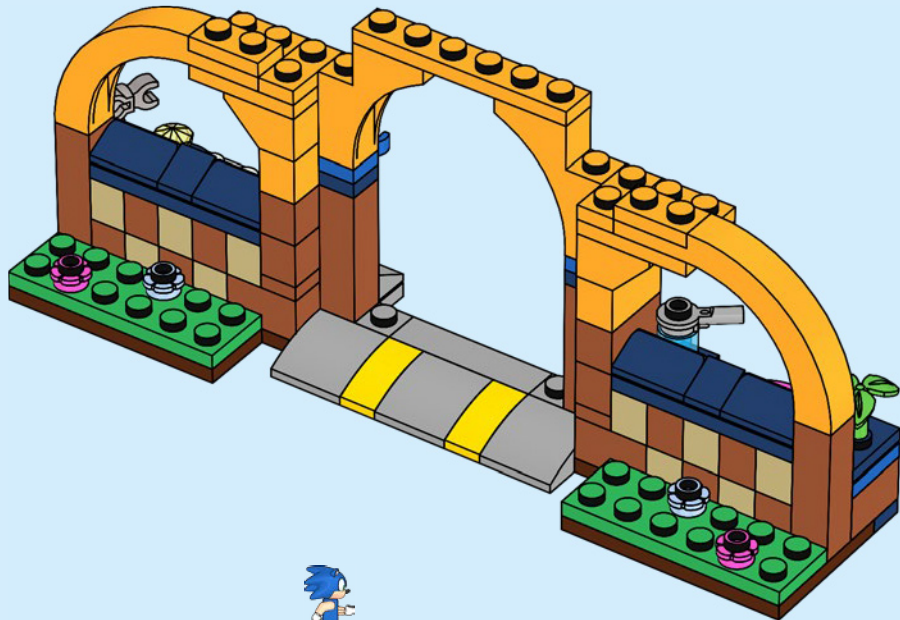



2x



2x

31

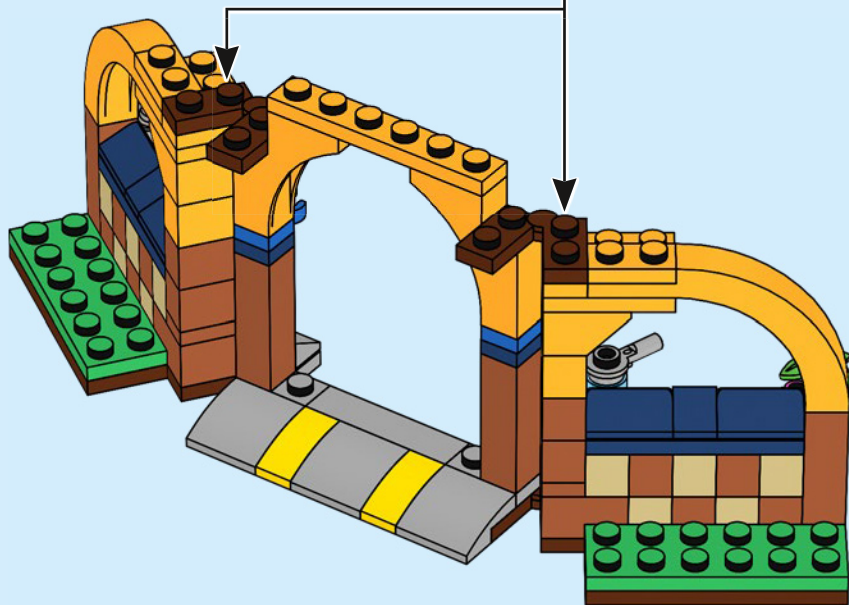



2X

32

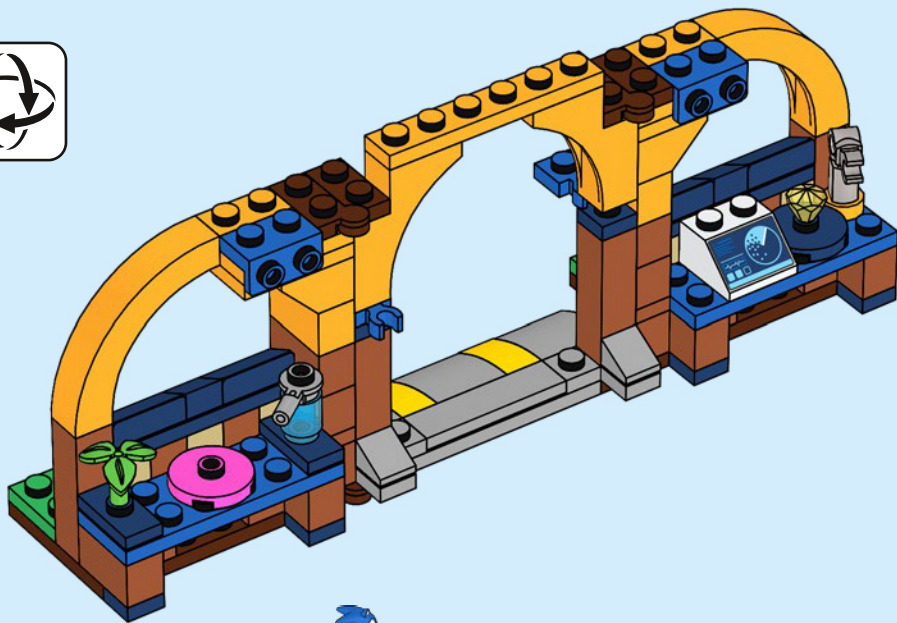



2x



2x

33

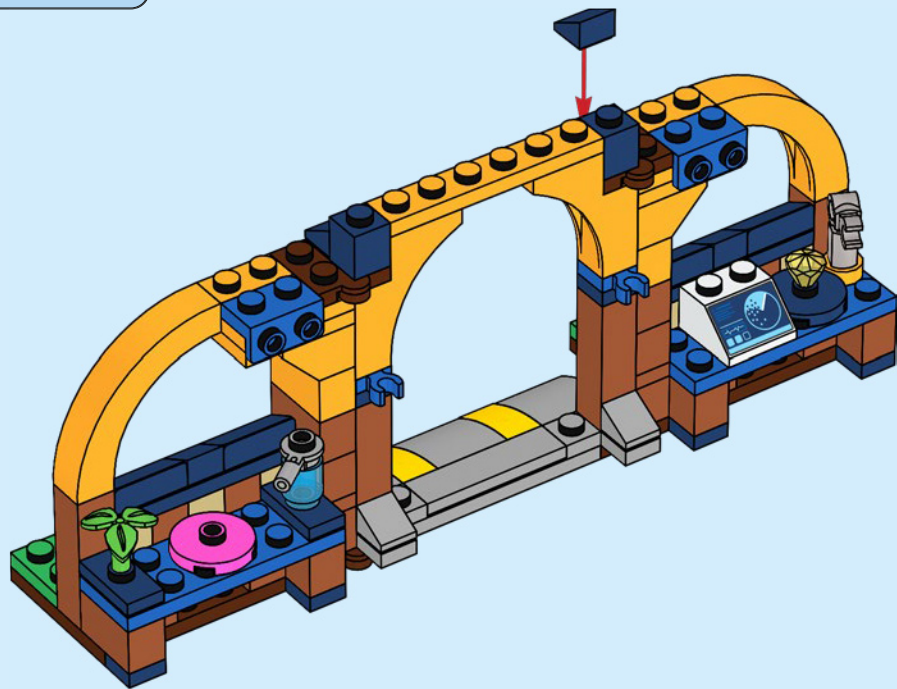



2x

34

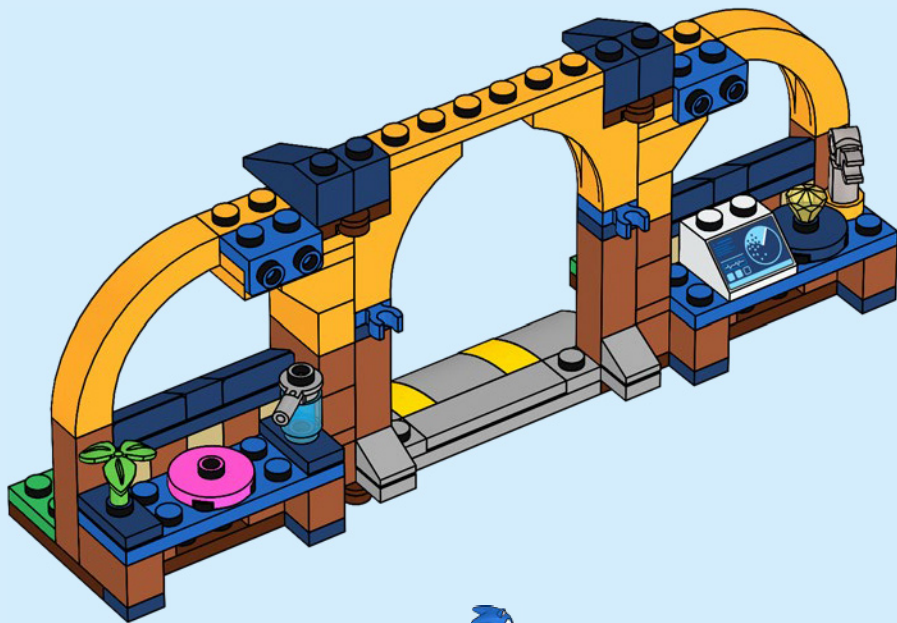

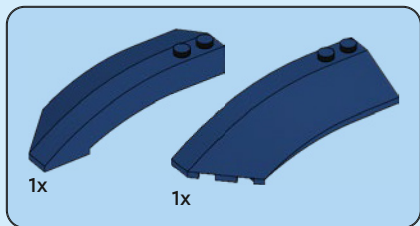

35

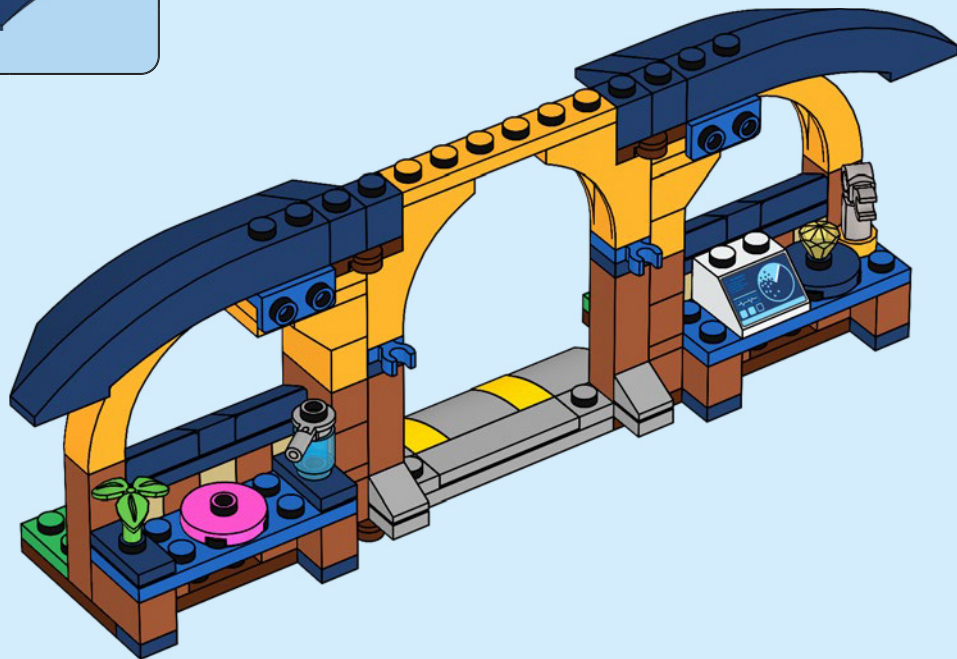

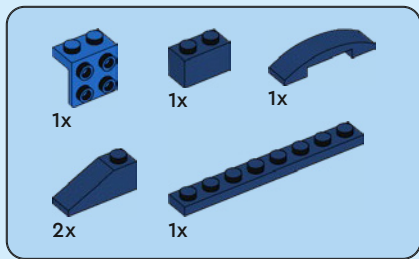

36

1

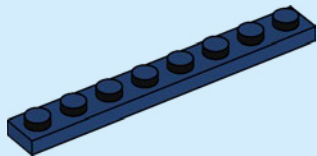

2

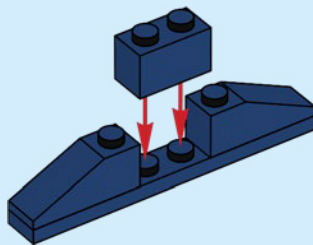

3

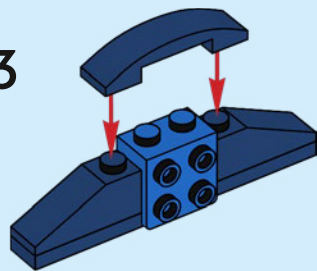

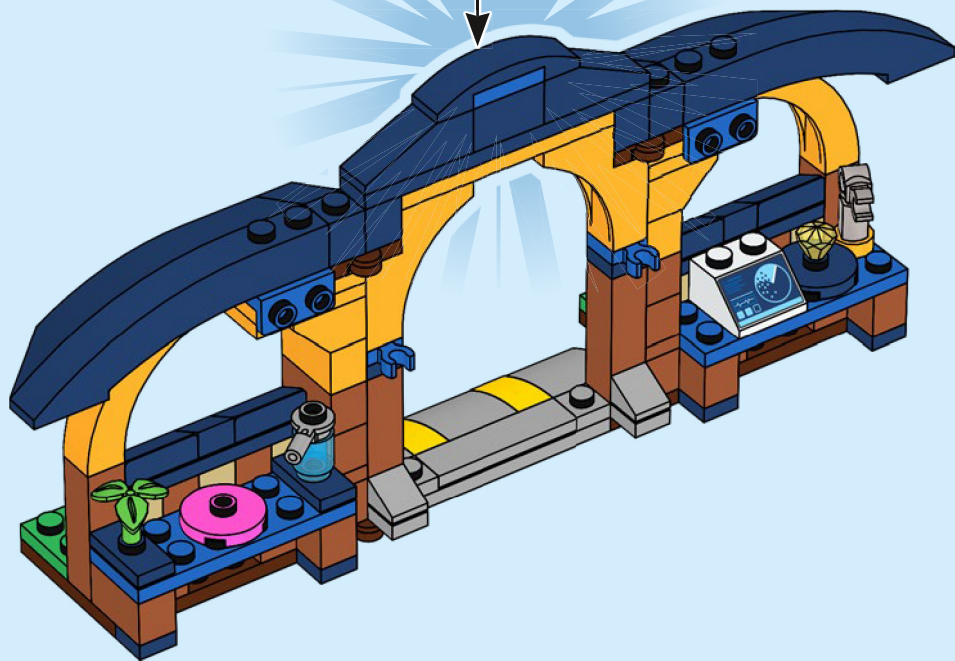



2x



2x

37



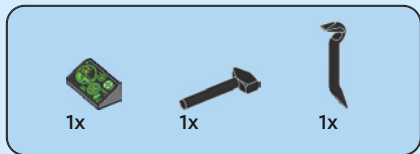

38

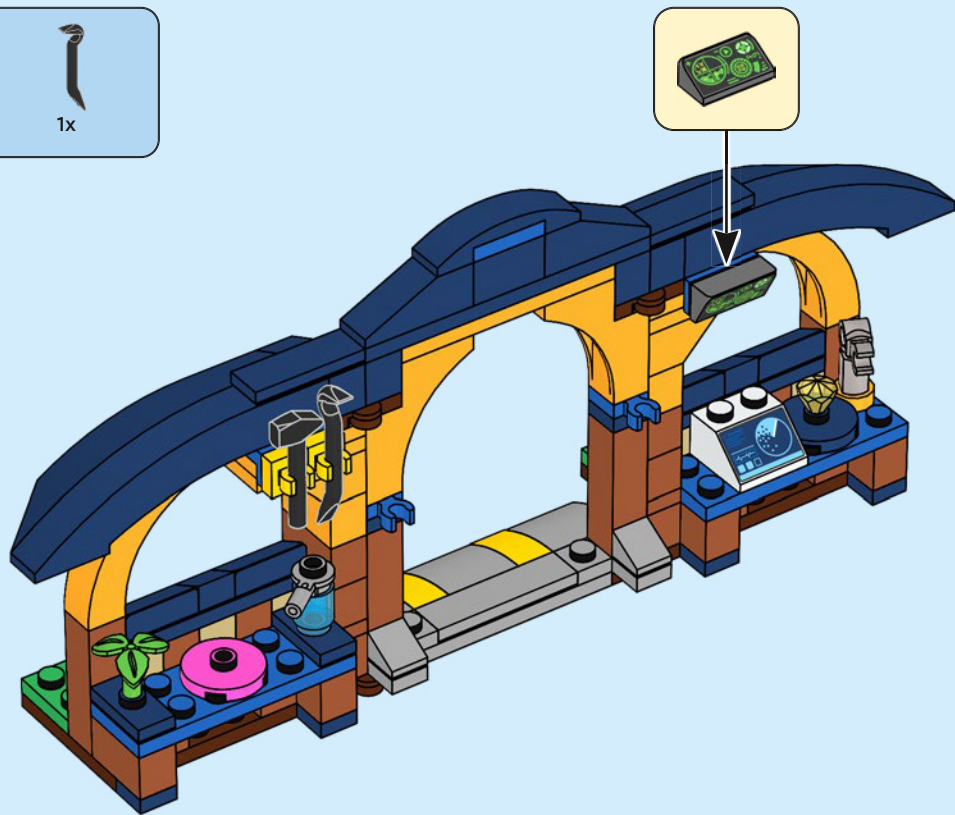



39

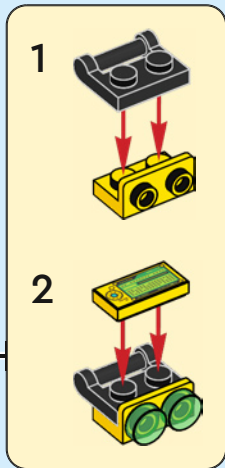
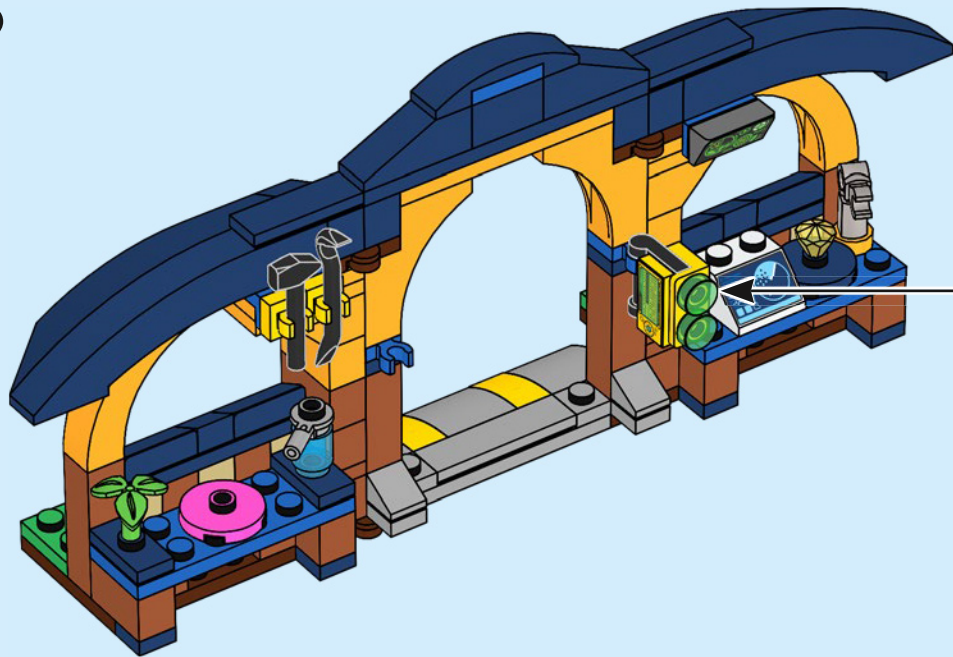

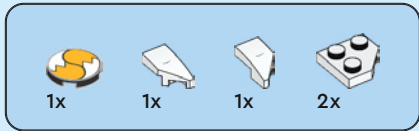

40

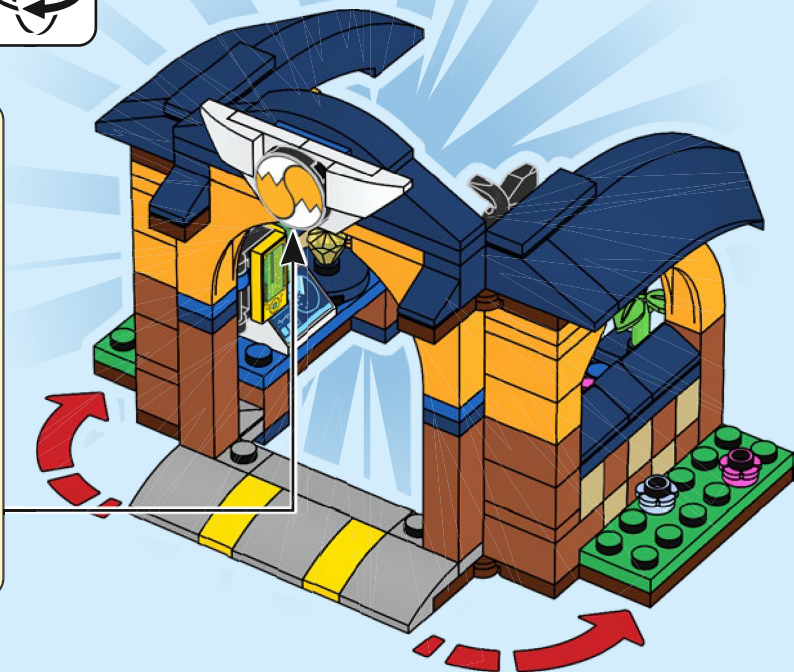
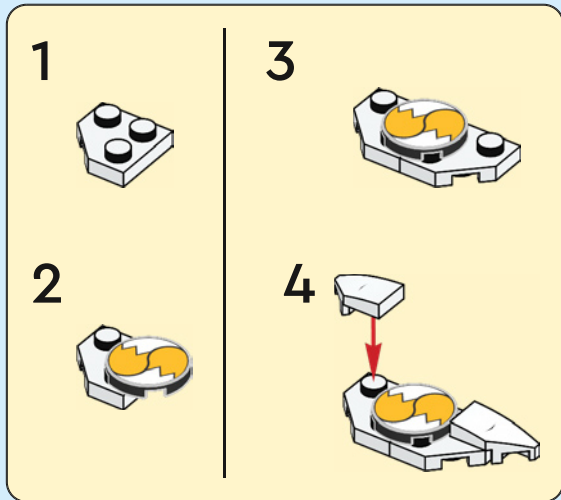





SONIC™

THE HEDGEHOG



Combine sets to
expand your play!



76990

























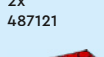















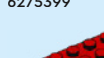

































Combine sets to expand your play!
Kombiniere Sets für noch mehr Spielspaß!
Combine les niveaux pour étendre ton expérience de jeu !
Combina i set per espandere il tuo gioco!
¡Combina sets para jugar mucho más!
Combina sets para expandir os teus momentos de diversão!
组合系列套装, 增强玩乐体验!
Łącz zestawy i baw się jeszcze lepiej!
Kombinujte stavebnice a rozšiřujte svou hru!
Kombinujte stavebnice a rozšiřujte herné možnosti!
A készletek egyesítésével bővítsd a játékot!
Combina seturi pentru a-ți extinde joaca!
Комбинируйте комплекты за по-интригуваща игра!
Arvieno komplektus, lai pilnveidotu savas rotaļas!
Kombineeri komplekte, et māņu laiendada!
Derinkite rinkinius ir išplėskite žaidimą!





Rebuild
the
world™



 2x 6411552	 1x 6309297	 4x 6177507	 2x 242021	 2x 487121	 2x 6352221	 1x 6117968	 3x 302324
 1x 6443188	 1x 4173943	 4x 6177505	 9x 6105976	 1x 6275399	 1x 6443151	 1x 6313992	 1x 300424
 2x 6172366	 1x 4243812	 4x 306921	 1x 302221	 1x 6108802	 1x 4278276	 2x 379523	 2x 6360077
 2x 307001	 1x 4243812	 6x 6092565	 1x 362321	 1x 6108802	 1x 403223	 1x 6443187	
 2x 6213880	 10x 4113915	 1x 302321	 2x 6431120	 1x 6268534	 2x 6163471	 2x 6029947	
 1x 300501	 2x 6321305	 2x 6146217	 1x 4500462	 1x 6191993	 1x 4514398	 1x 6057458	
 2x 6213881	 1x 6395373	 2x 6186398	 1x 6023770	 2x 346021	 4x 6073890	 2x 6348056	
 1x 6346616	 2x 4504379	 1x 6029946	 1x 371021	 2x 447721	 1x 6452519	 2x 6348065	
 2x 6176240	 1x 302421	 4x 6184782	 1x 5x 302021	 1x 6372164	 1x 6372164	 3x 6441692	
 2x 6361170	 1x 4278275	 1x 6173126				 2x 6126050	
 1x 6047220						 1x 6224666	



1x
6441325



1x
302124

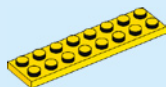

1x
303424



2x
6335388



2x
6157554



1x
6210270



2x
407026



2x
4144023



1x
6310268

46



3x
403226



3x
6443186



5x
6138173



1x
6178922



1x
6053077



1x
6192346



2x
6346248



2x
302126

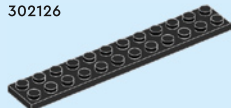

1x
244526



1x
4225201



2x
249626



2x
4246901



1x
452226



1x
400626



1x
6186698



8x
6254484



2x
4666352



4x
4579659



2x
4570877



6x
6253417



4x
6397875



1x
6246888



1x
6223655



1x
6286876



3x
6244730



1x
6252205



4x
6166111



2x
6274742



1x
6247795



1x
6238044



4x
4504374



6x
4184108



2x
4255413



1x
6253885



4x
6216905



2x
6092588



1x
4249891



2x
6132566



4x
6103774



1x
6037886



2x
6384913



1x
6250216



1x
6392164



1x
6392163

2x
6209683

2x
6209679

1x
6223767

2x
6171764

1x
6223719

1x
6443192

1x
6452547

1x
6443193

1x
6443191

6x
6028736

2x
6003003

2x
6170916

2x
6097503

1x
6020074

2x
6380016

2x
6328126

3x
4529241

2x
4211412

2x
6284071

6x
4521921

1x
4213567

2x
4211758

1x
6227897

2x
6281998

1x
6329585

1x
4568637

2x
6152344

16x
6102357

2x
4211353

1x
4667578

4x
4622803

1x
4211356

1x
4211452

2x
4211401

1x
6443217

1x
6338570

1x
6235080

2x
379528

1x
4211219

2x
4211189

4x
6416695

2x
4271874

1x
6194290

4x
6221607

2x
6390673

4x
4211042

2x
4211094

4x
6344820

4x
6378143

1x
6083620

1x
6074417

1x
4210678

 [LEGO.com/service](https://www.LEGO.com/service)



YOU COULD
WIN



Scan this QR code or go to
LEGO.COM/PRODUCTFEEDBACK and give
us your short feedback about this LEGO® set
for a chance to win a cool LEGO prize.

Terms and Conditions apply*



EN: YOU COULD WIN. Terms and Conditions apply* **DE: Du könntest GEWINNEN.** Es gelten die Teilnahmebedingungen* **FR: Tu pourrais GAGNER.** Des conditions s'appliquent* **IT: Potresti VINCERE tu.** Termini e condizioni sono applicabili* **ES: Puedes GANAR.** Aplican términos y condiciones* **PT: Poderá GANHAR.** Aplicam-se termos e condições* **ZH: 轻松获奖. 条款和条件适用*** **PL: Szansa na WYGRANĄ.** Obowiązują warunki korzystania* **CS: Máte šanci VYHRÁT.** Platí všeobecné smluvní podmínky* **SK: Máte šancu VYHRAŤ.** Platia všeobecné zmluvné podmienky* **HU: TE IS NYERHETSZ.** Felhasználási feltételek érvényesek* **RO: Ai putea CÂȘTIGA.** Se aplică termenii și condiții* **BG: Можете да СПЕЧЕЛИТЕ.** Има определени правила и условия* **LV: Tu vari LAIMĒT.** Ir spēkā noteikumi un nosacījumi.* **ET: Sul on võimalus VÕITA.** Kehtivad tingimused* **LT: Jūs galite LAIMĖTI.** Taikomos sąlygos*

*[LEGO.com/productfeedback-terms](https://www.lego.com/productfeedback-terms)

LEGO and the LEGO logo are trademarks of the LEGO Group. ©2023 The LEGO Group.

©SEGA. All rights reserved. SEGA is registered in the U.S. Patent and Trademark Office.

SEGA and SONIC THE HEDGEHOG are either registered trademarks or trademarks of SEGA CORPORATION.

6475193