

ZNA

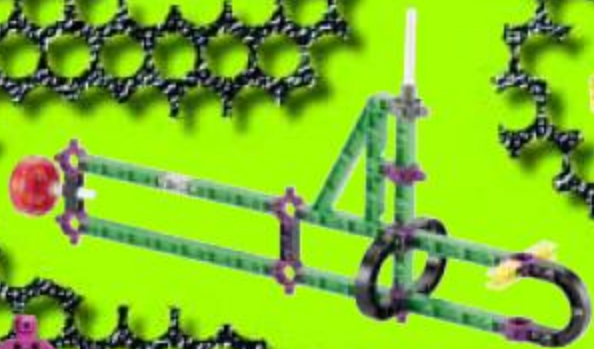

LEGO





52



70



84

108



3



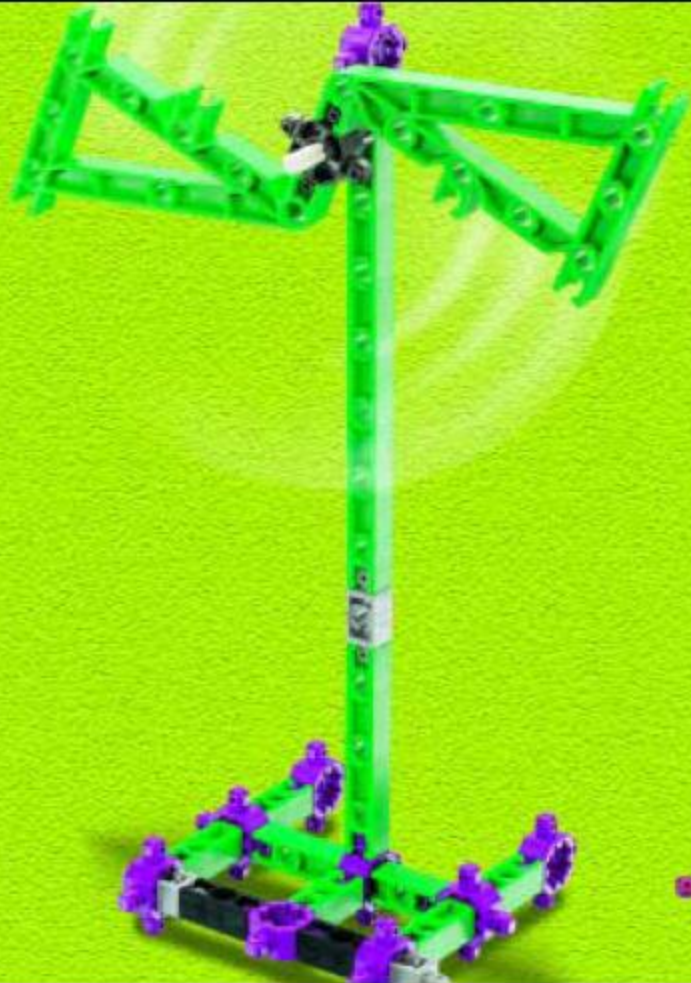

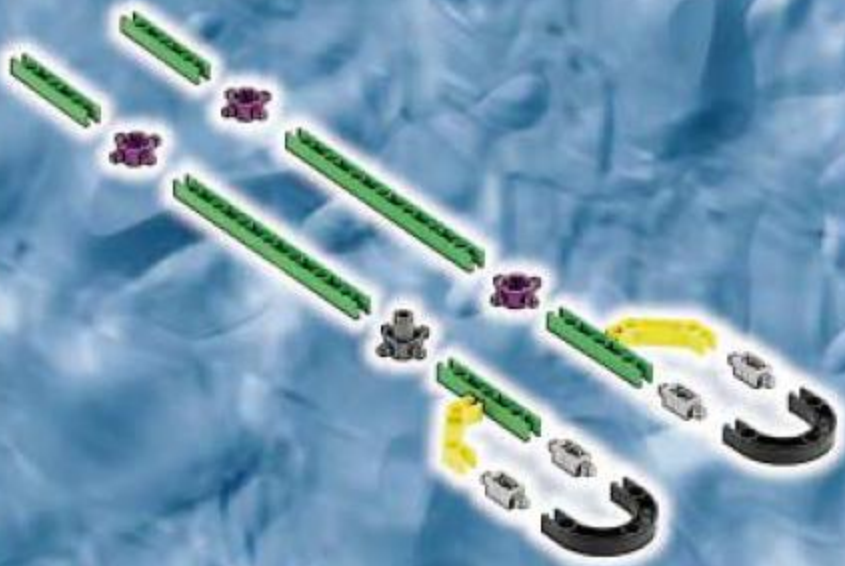

2

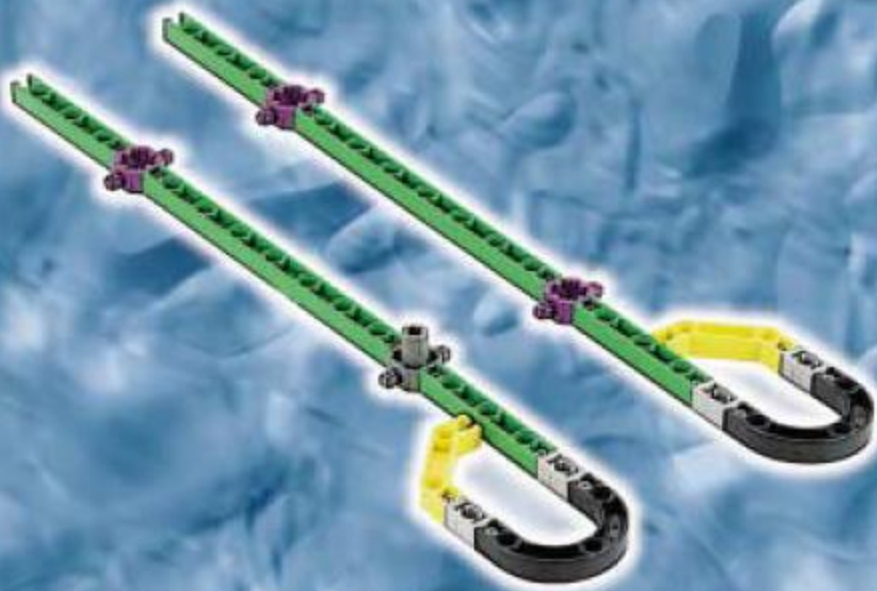

3

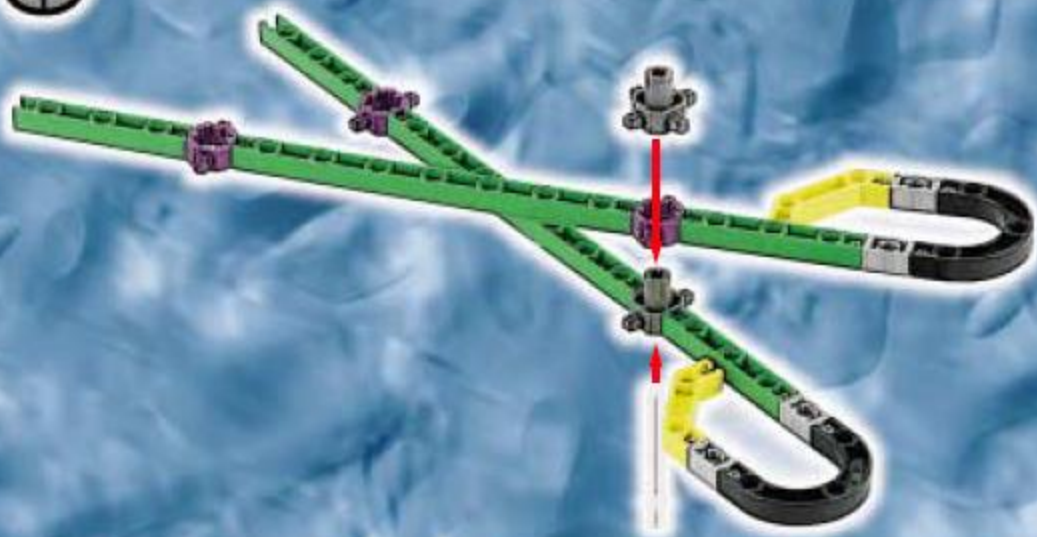

4

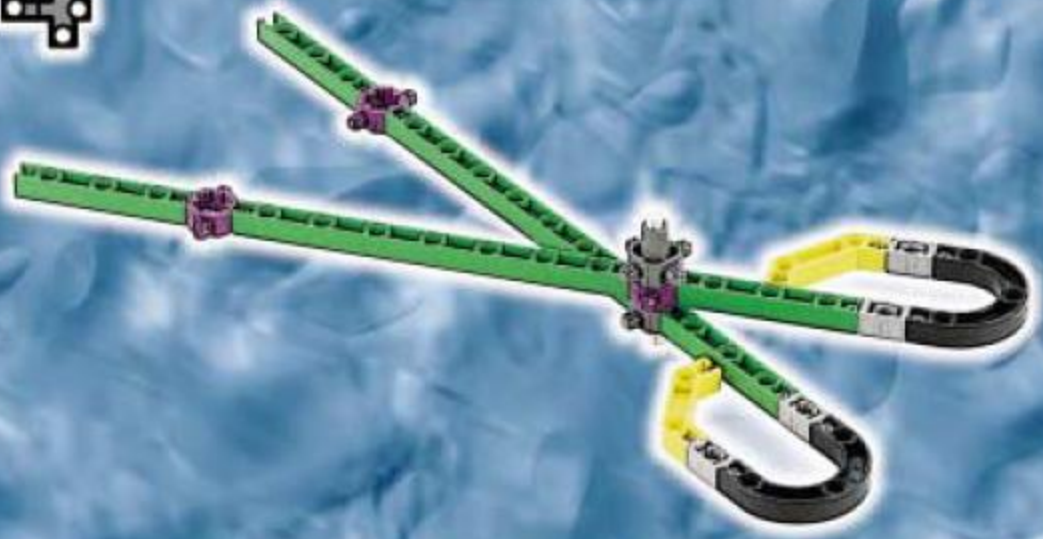



1



2



3



4



5



6



7



8



9



10



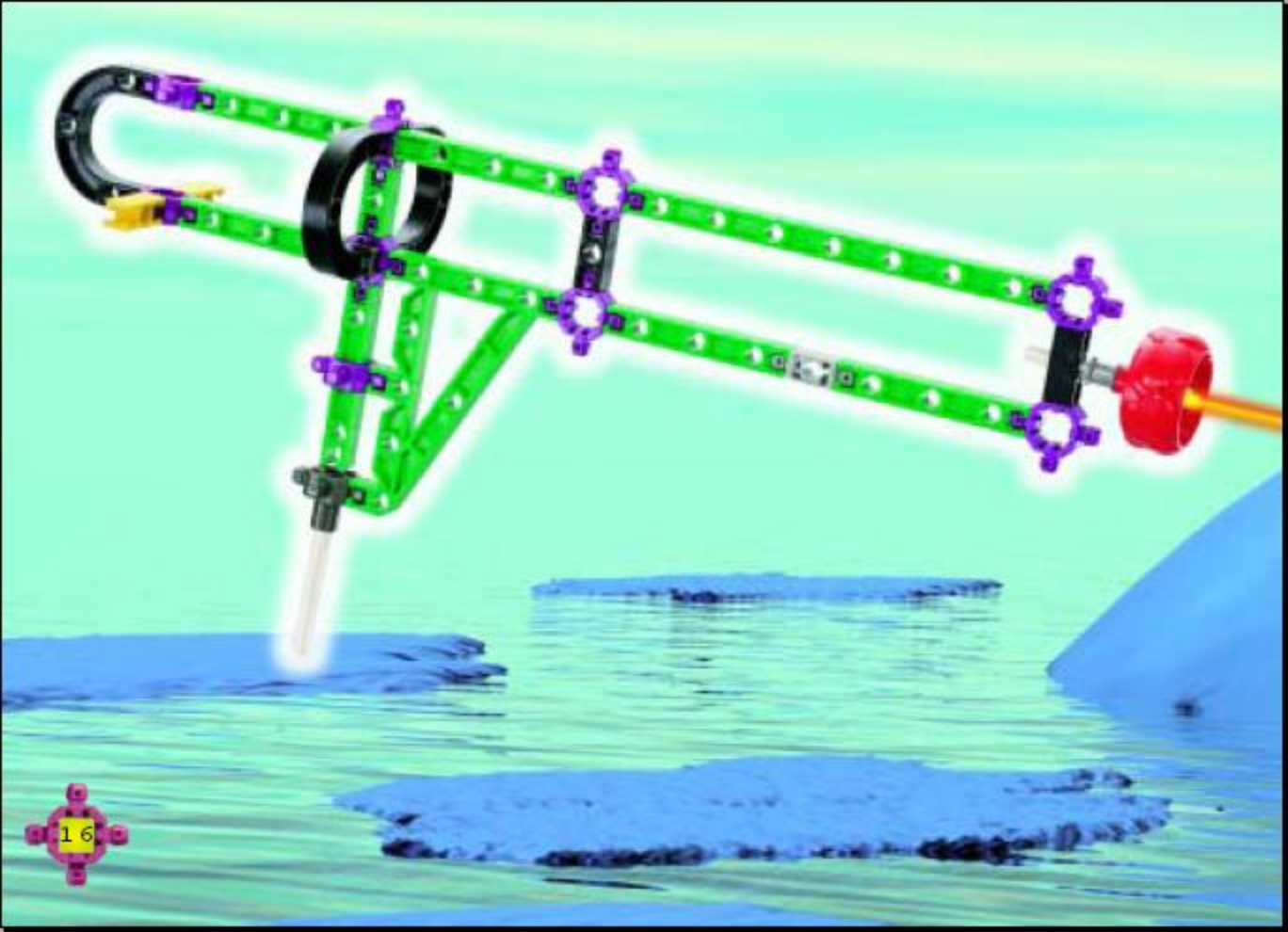

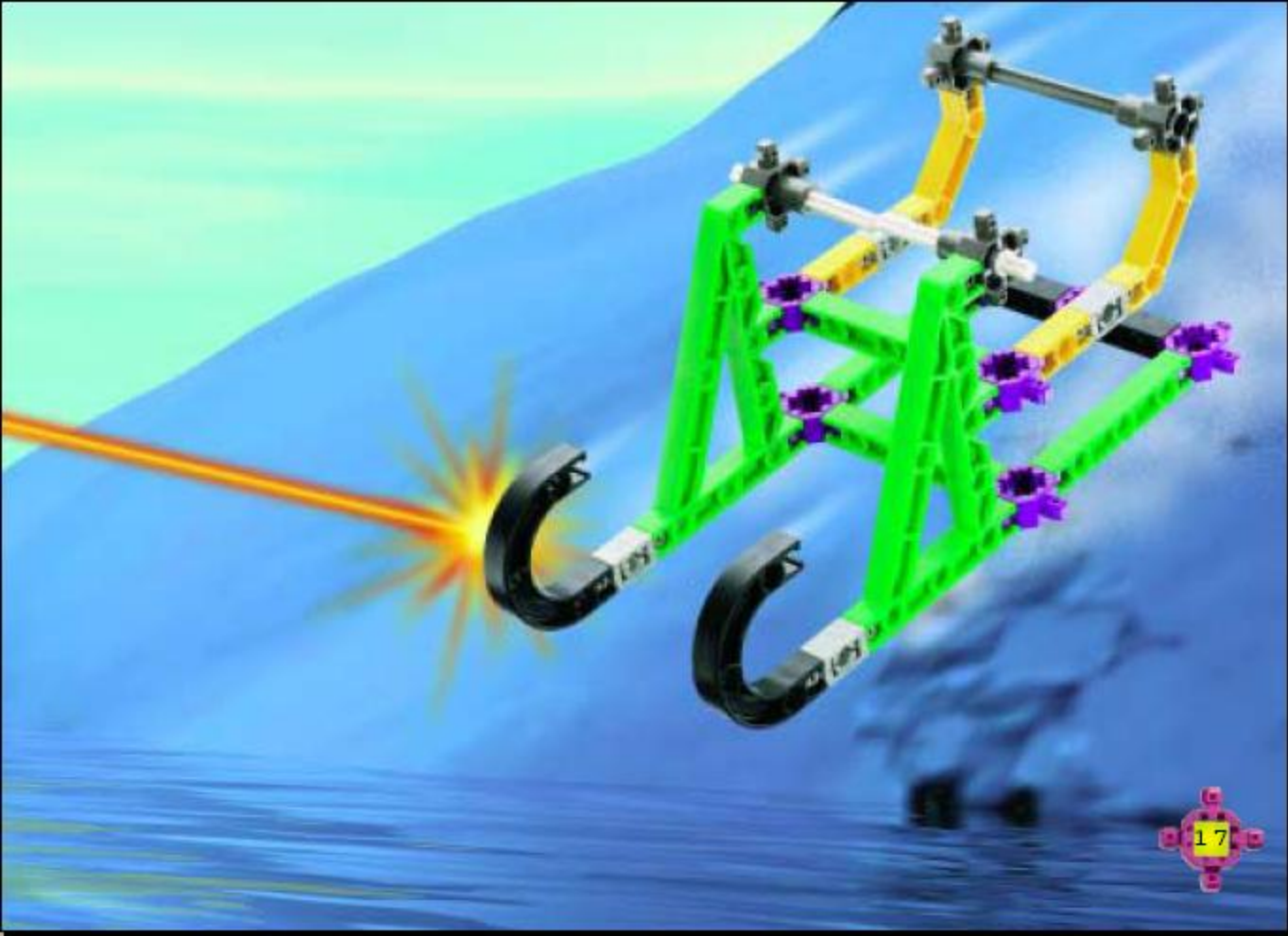



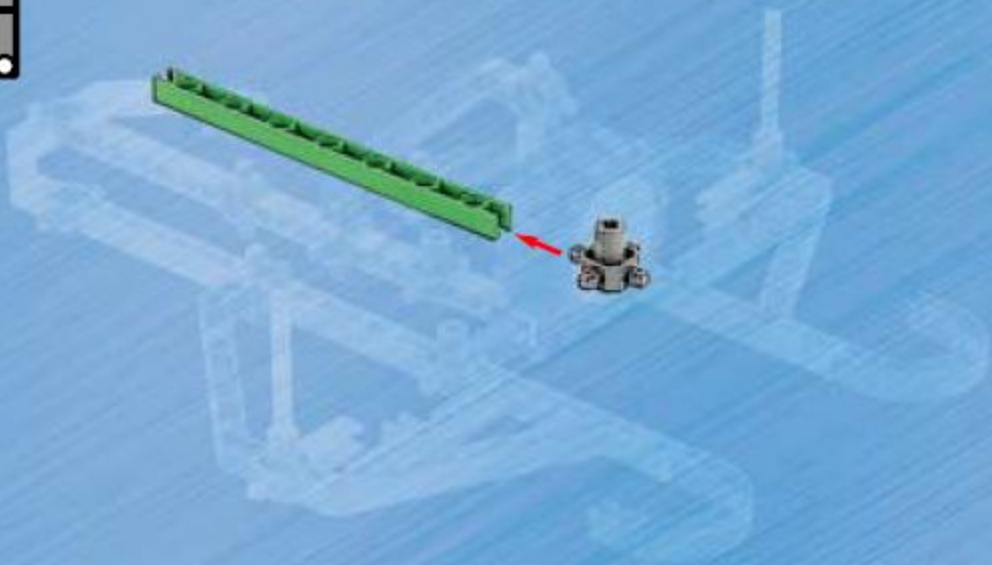
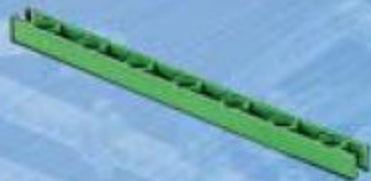

2

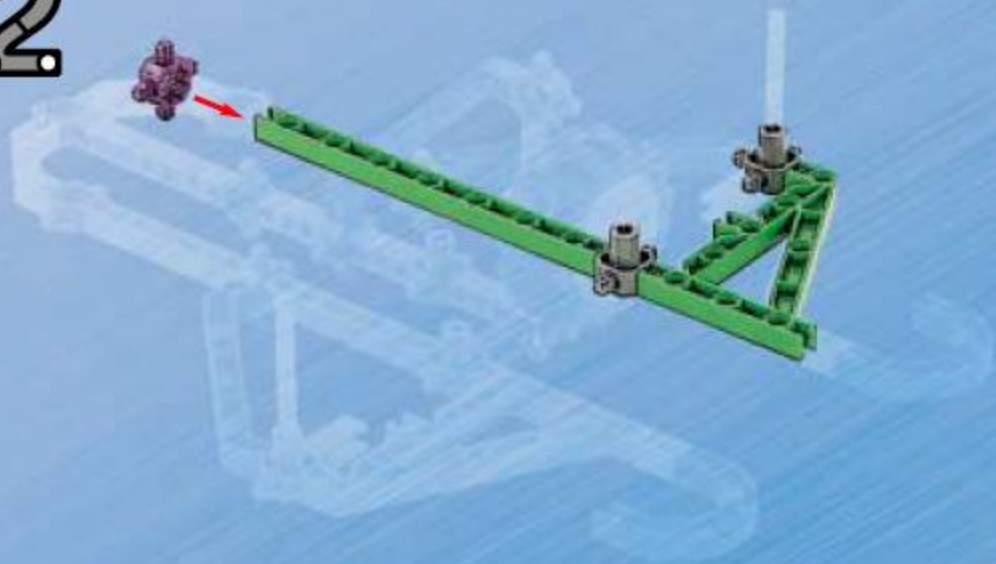

3

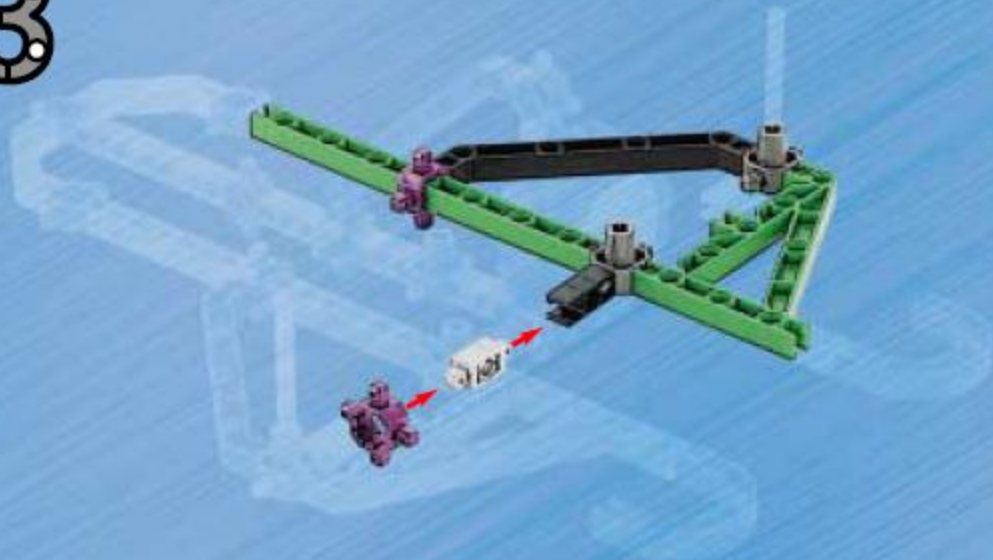

4

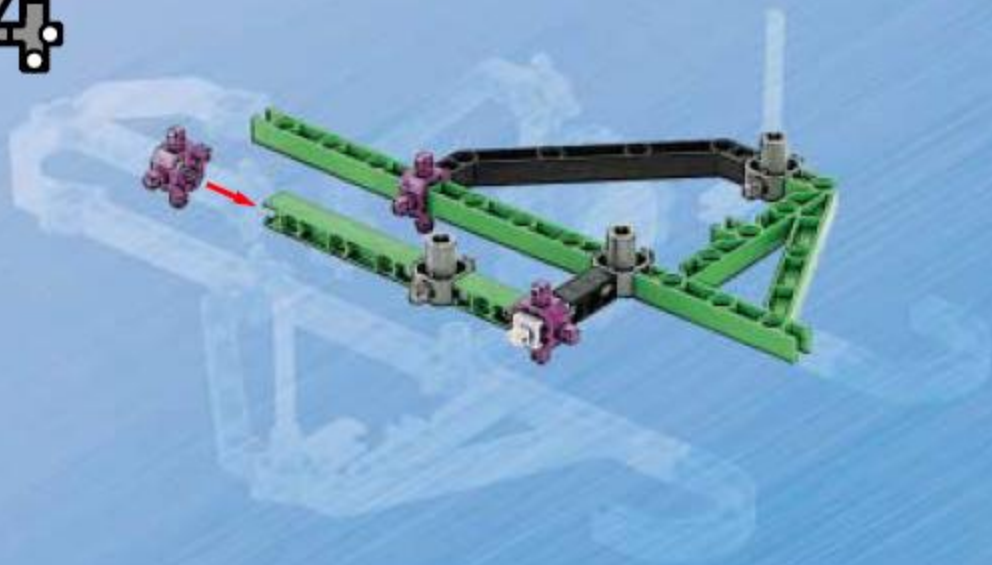

5



6

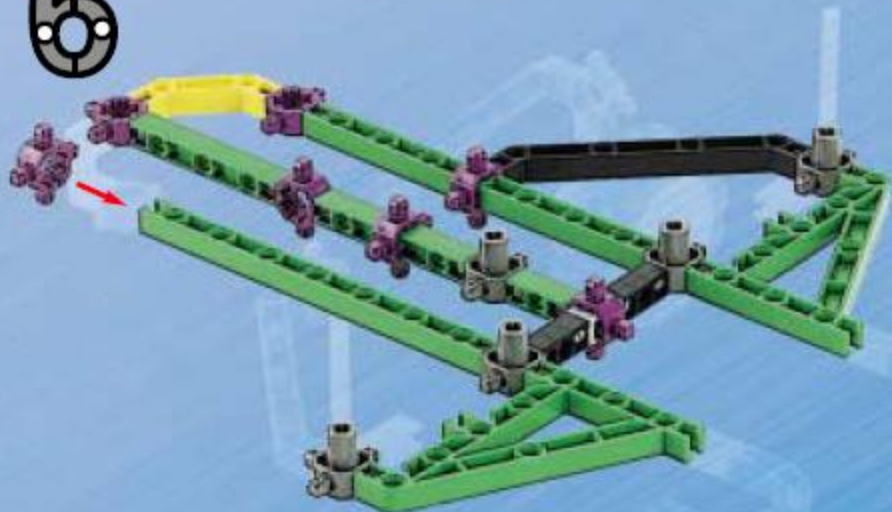

7

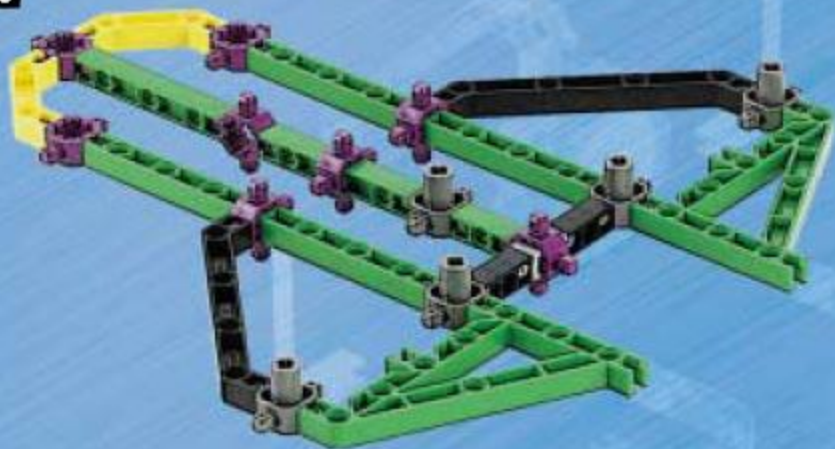

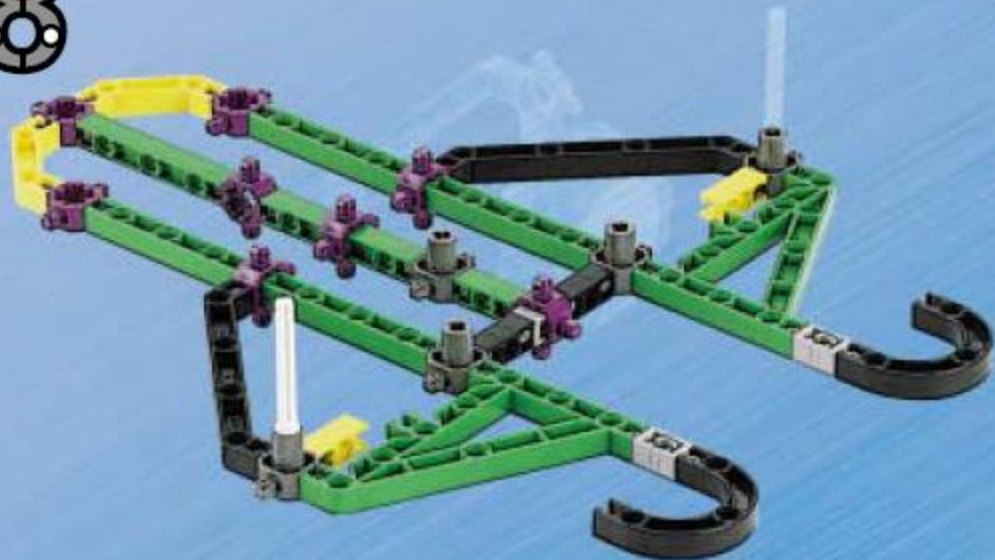

9



10

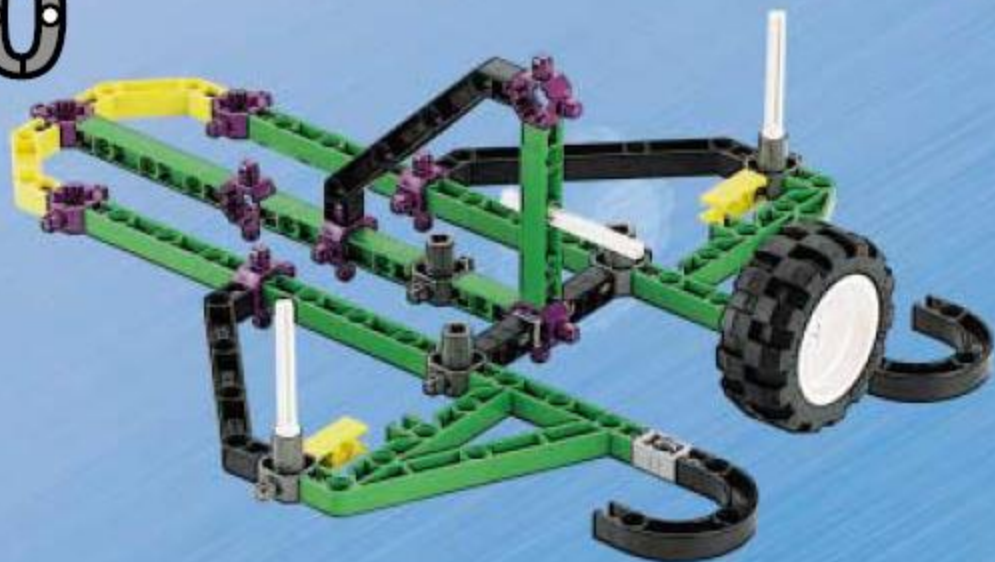

11



TRANS  FORM



2



3

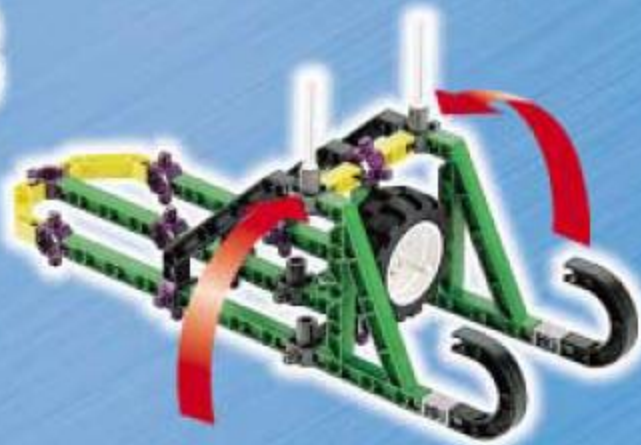

TRANS

FORM





2

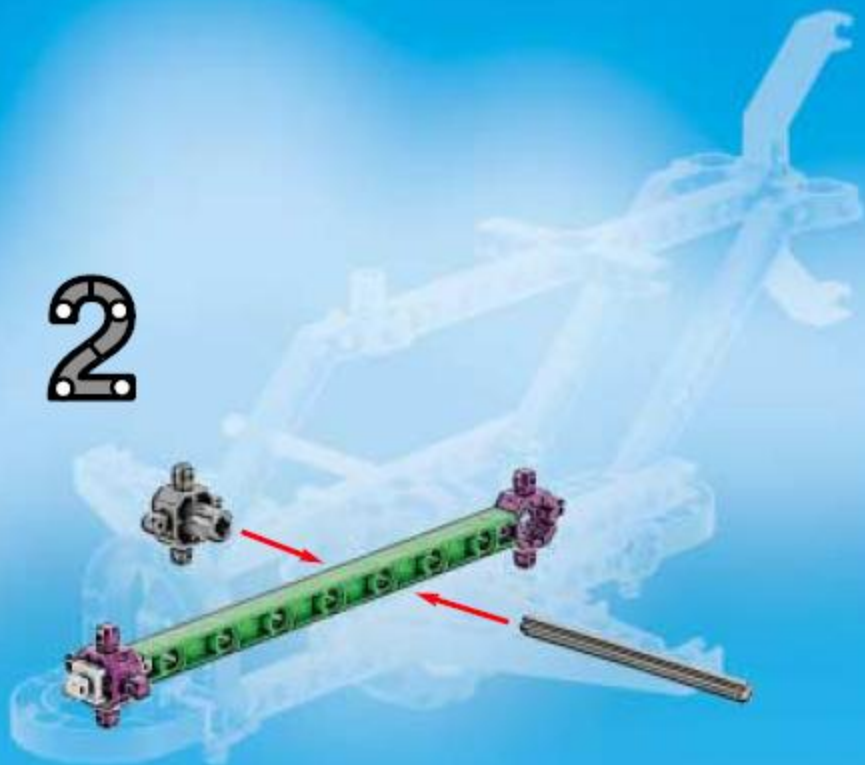

3

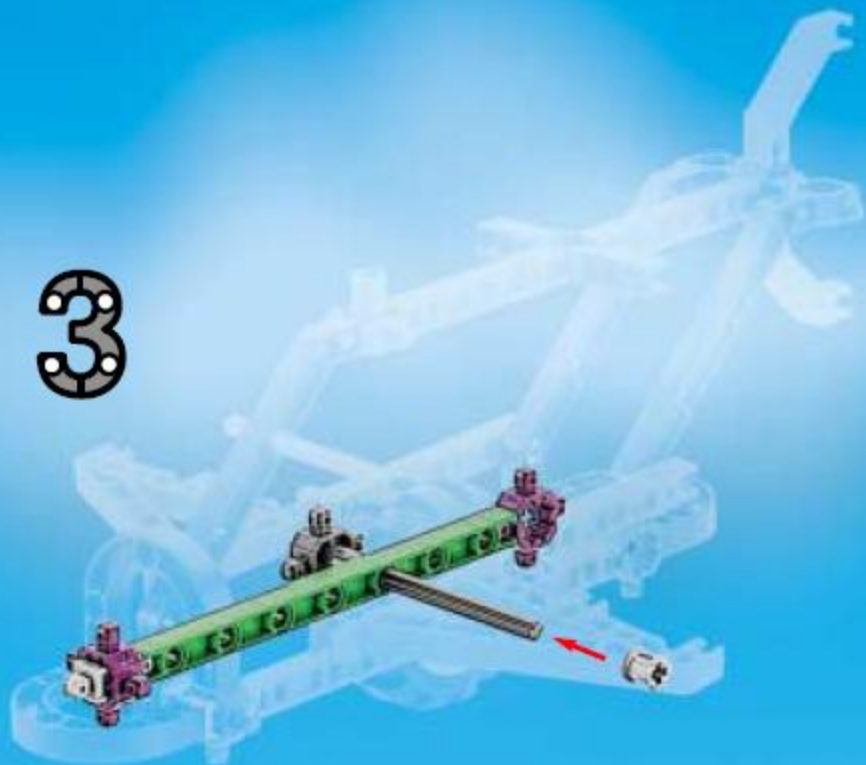

4



5



6



7





9



10



11



12



13



14



15



16



17





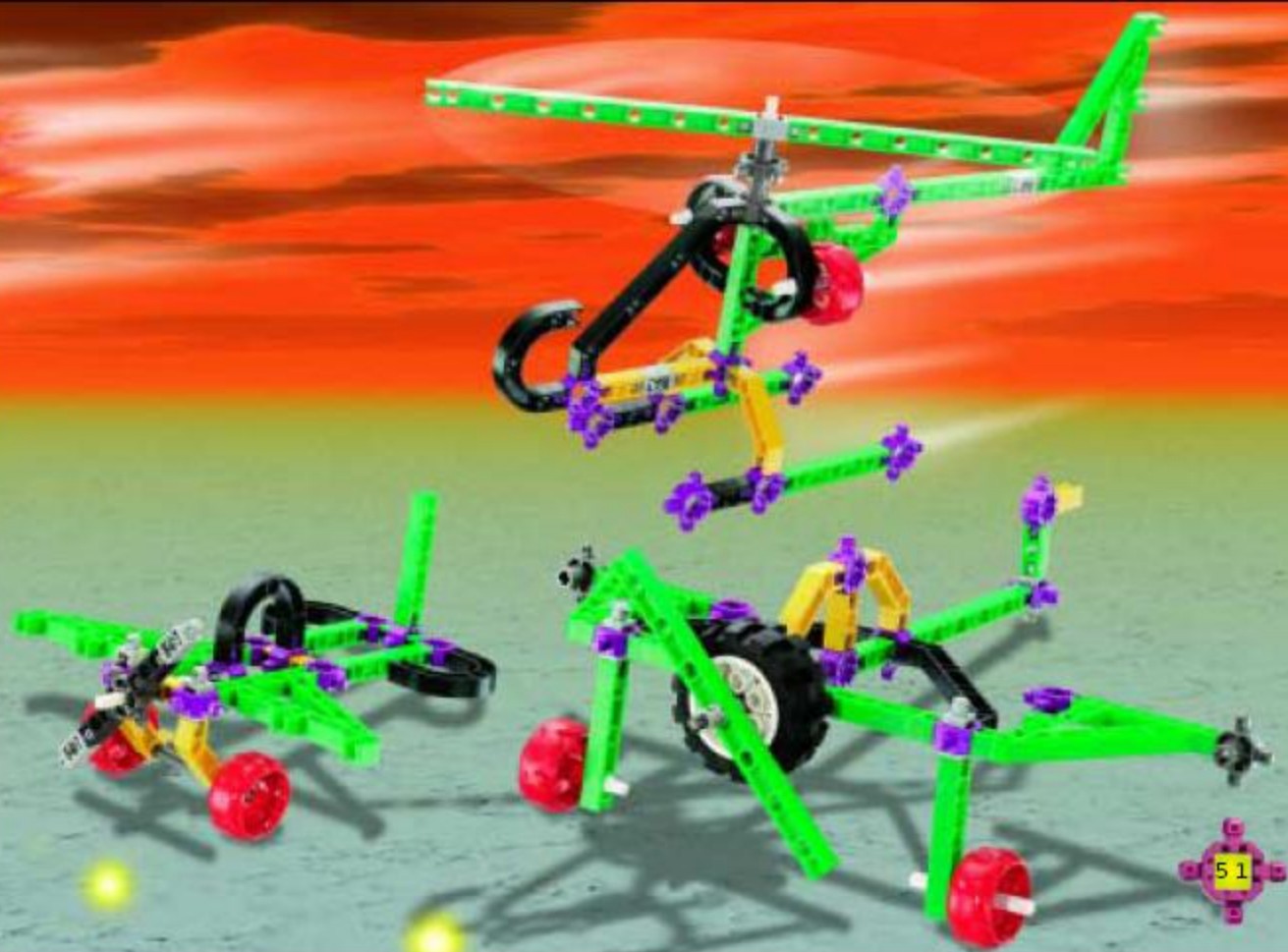



2



3



4



5



6



7





10



11



12



13



14



15



16









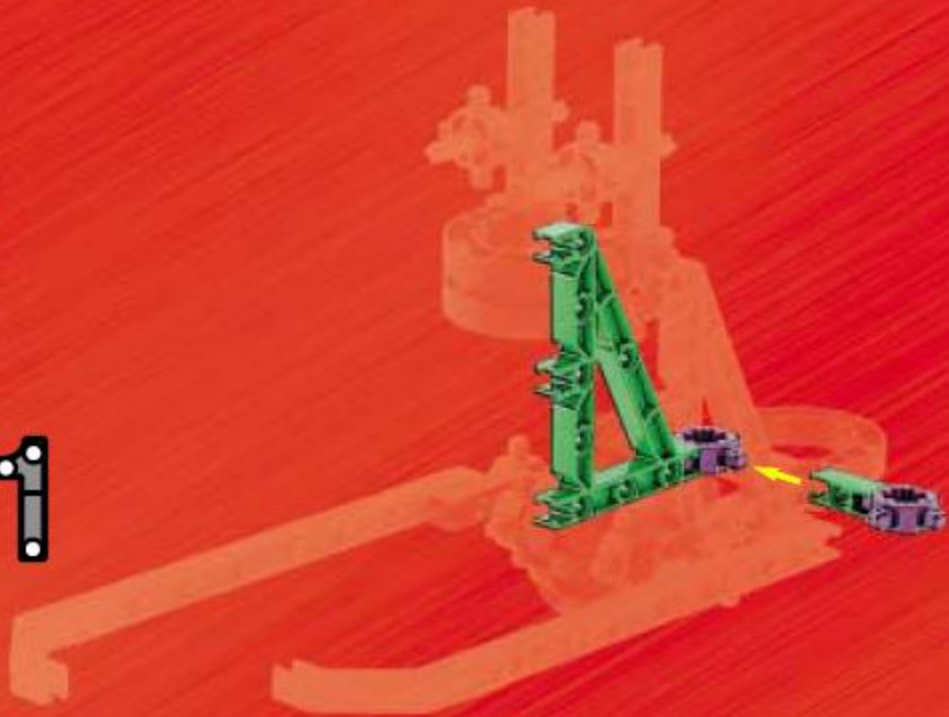

2

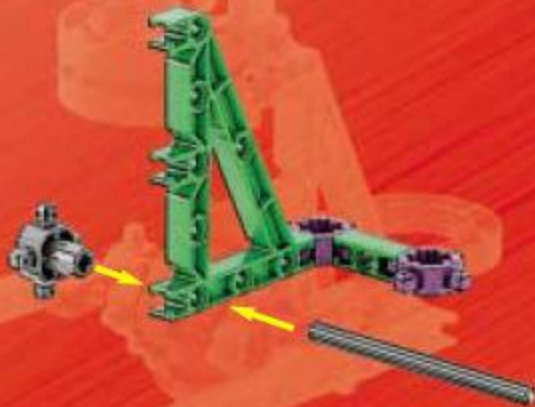

3

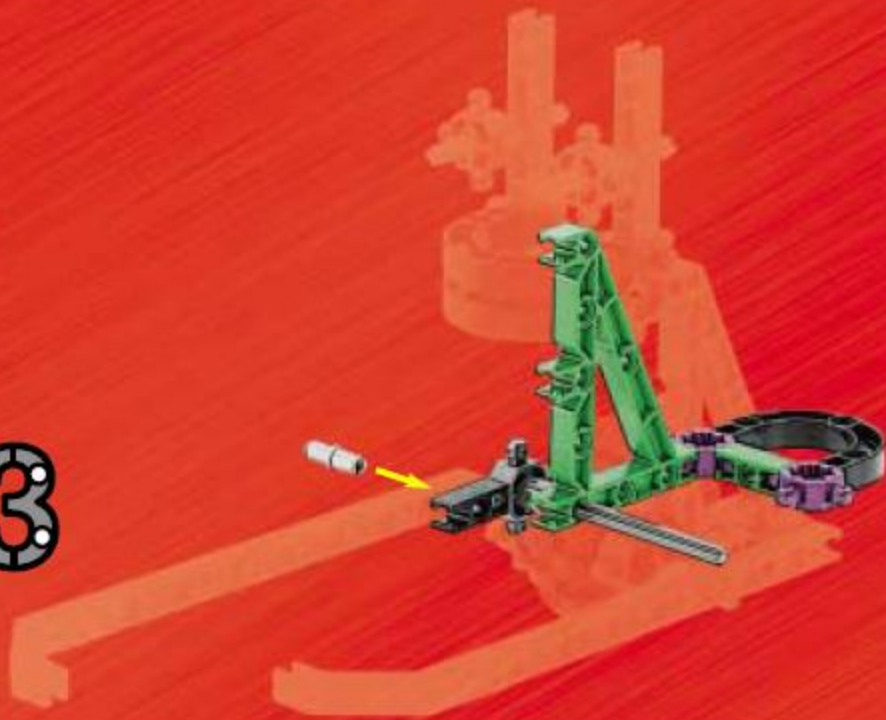

4



5



6



7



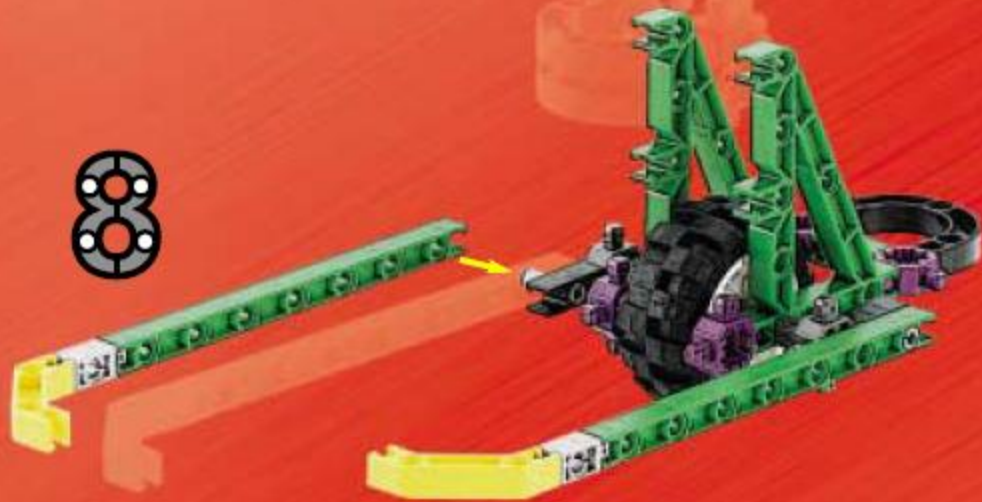

9



10



11



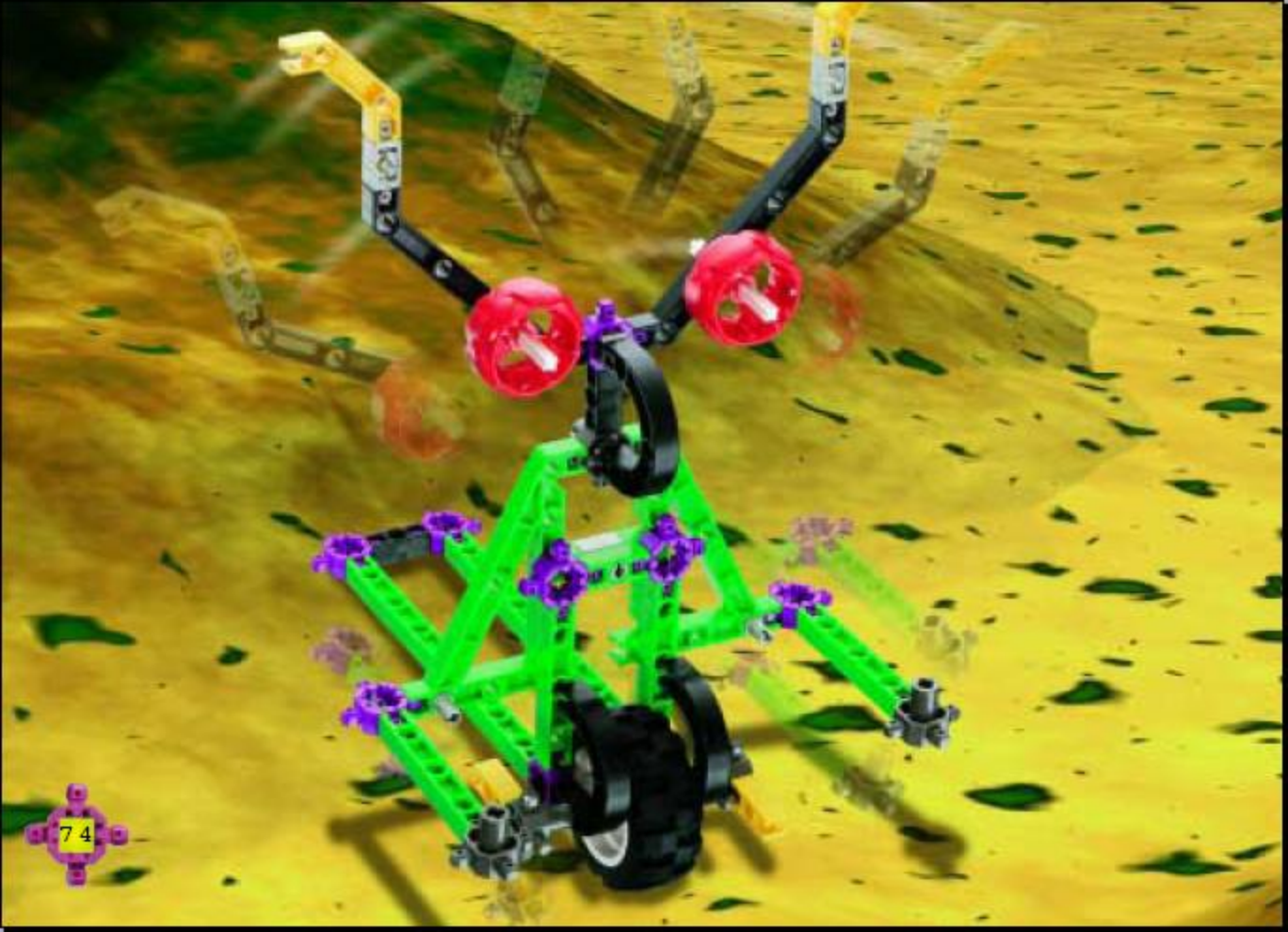





1

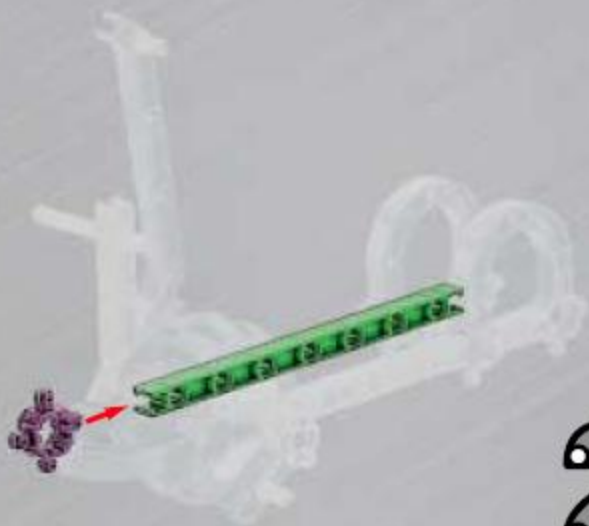

2

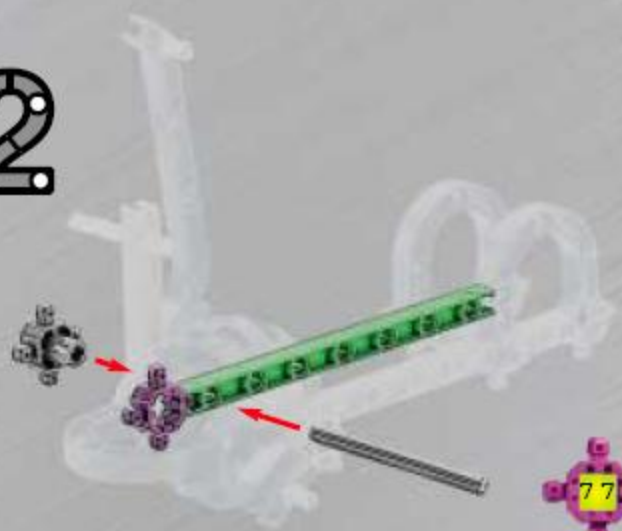

3



4

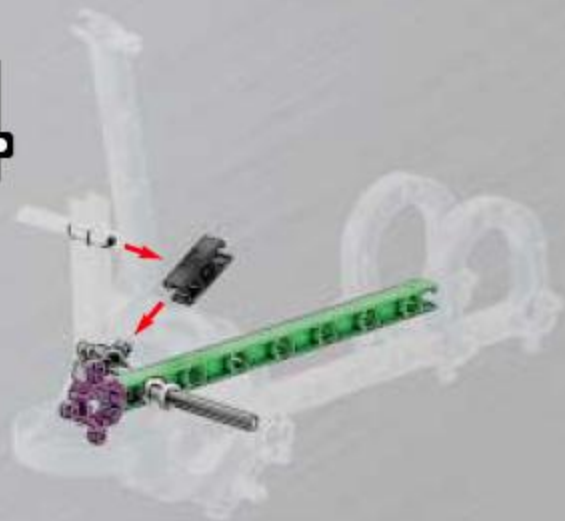

5

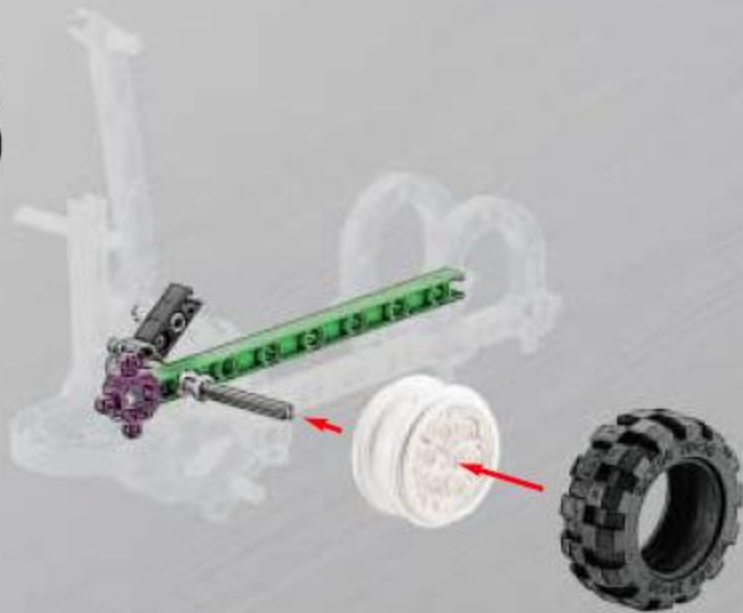

6



7

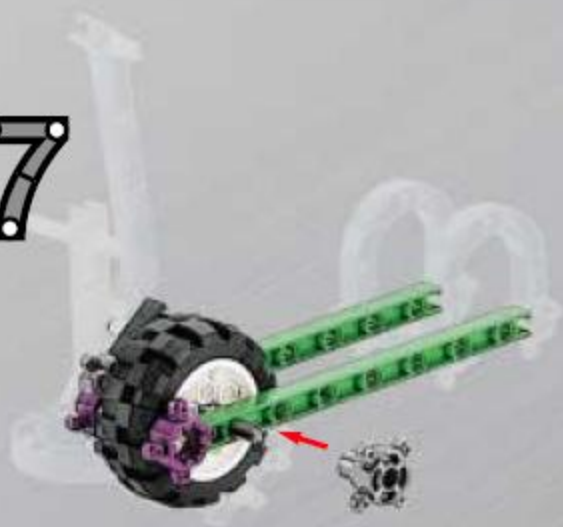



9

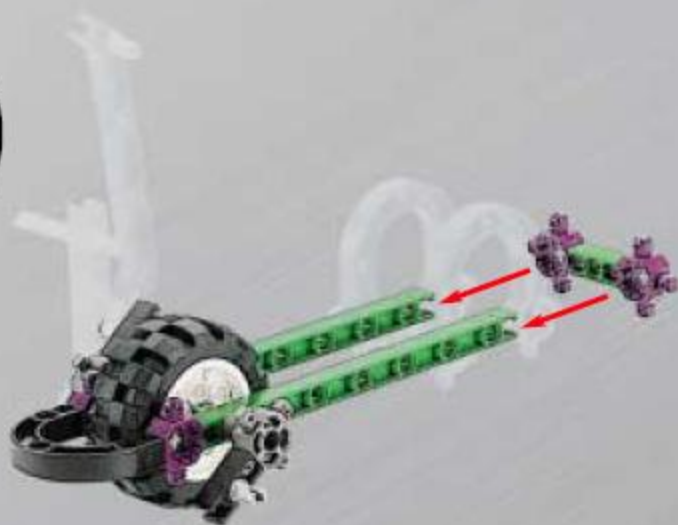

10



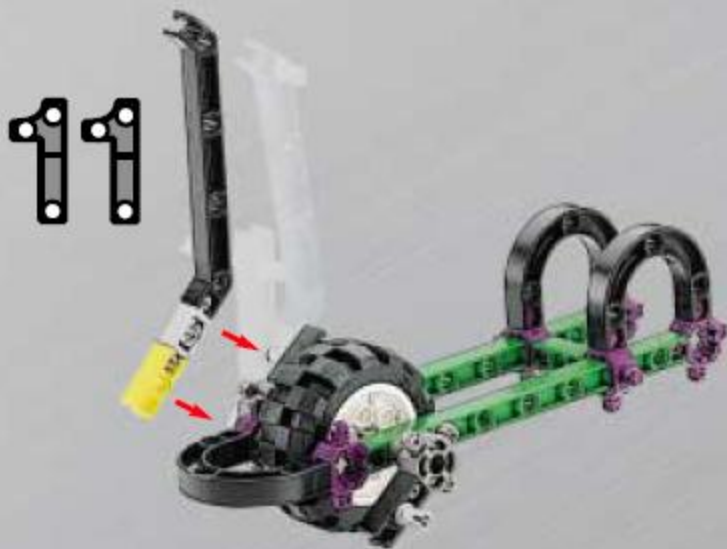

12



13



14



15



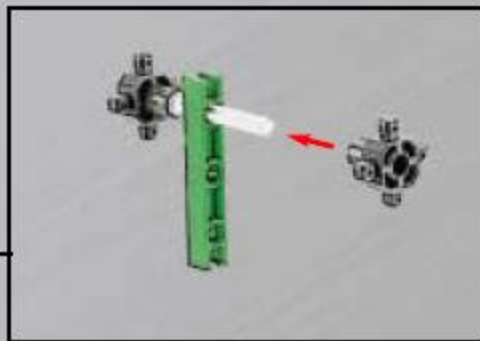

16



17

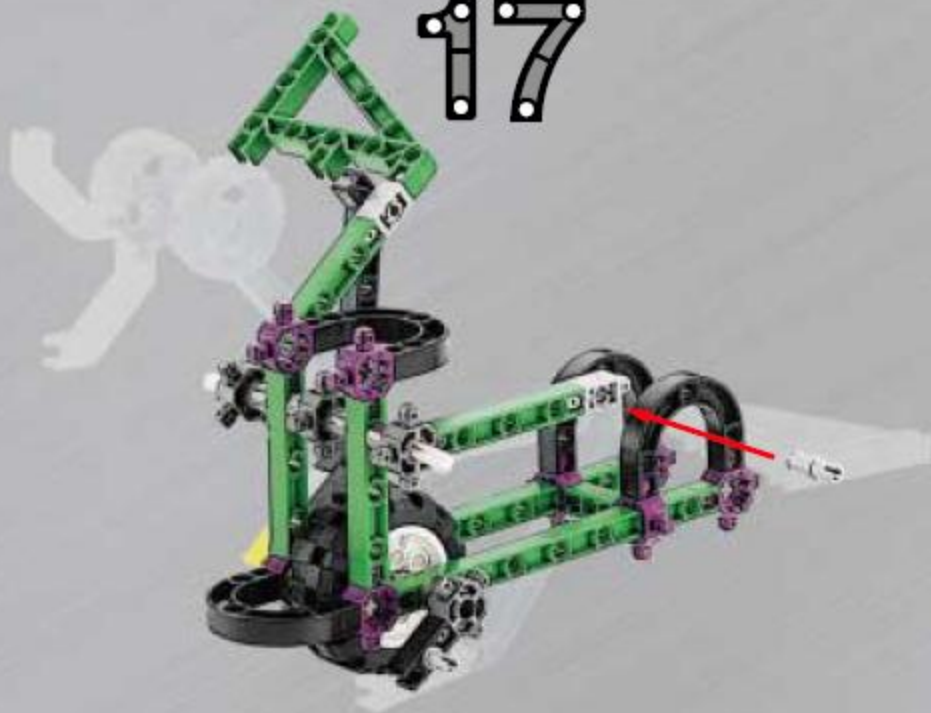

18



19



20



21



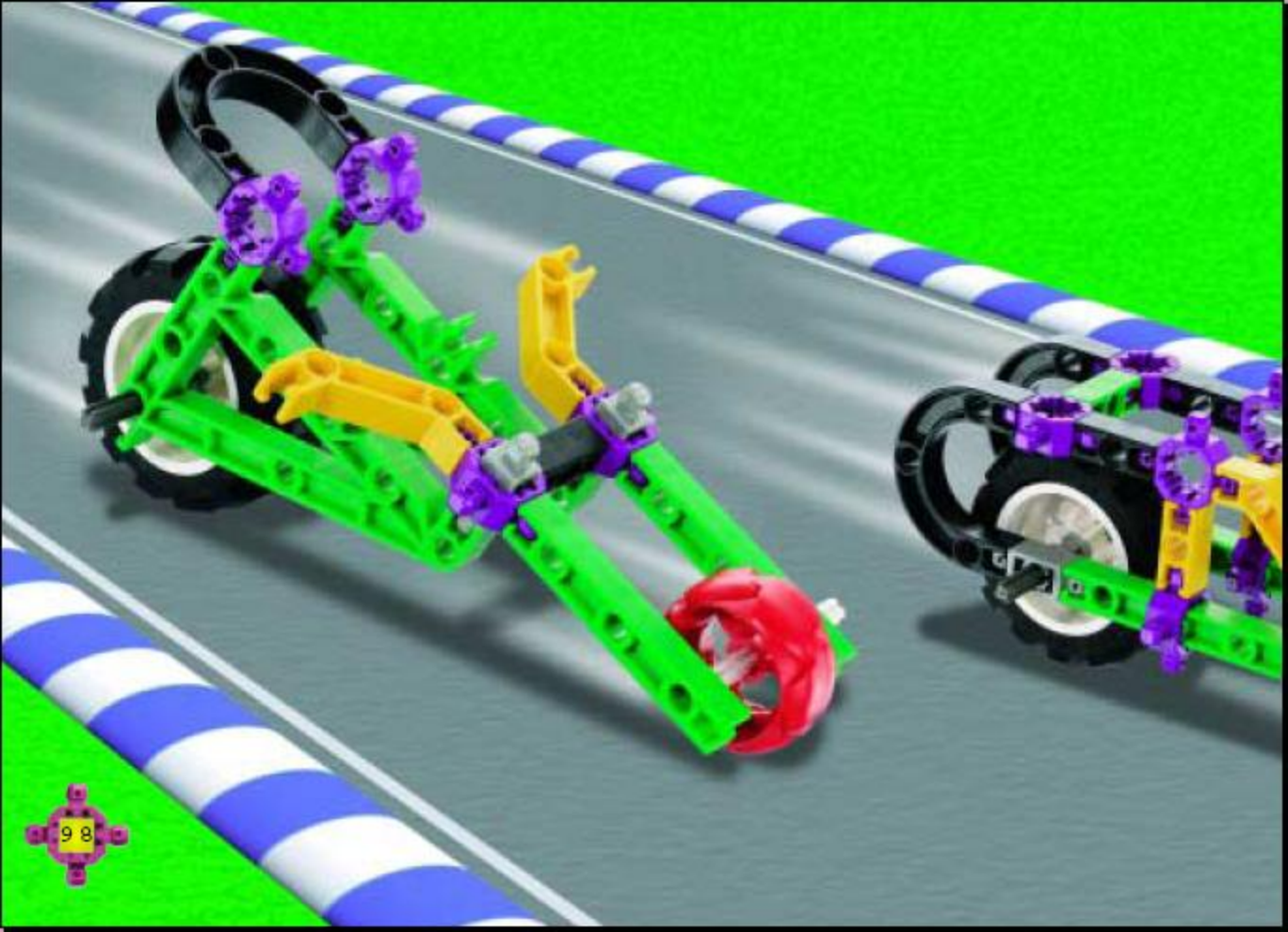





2



3



4



5



6



7







10



11



12

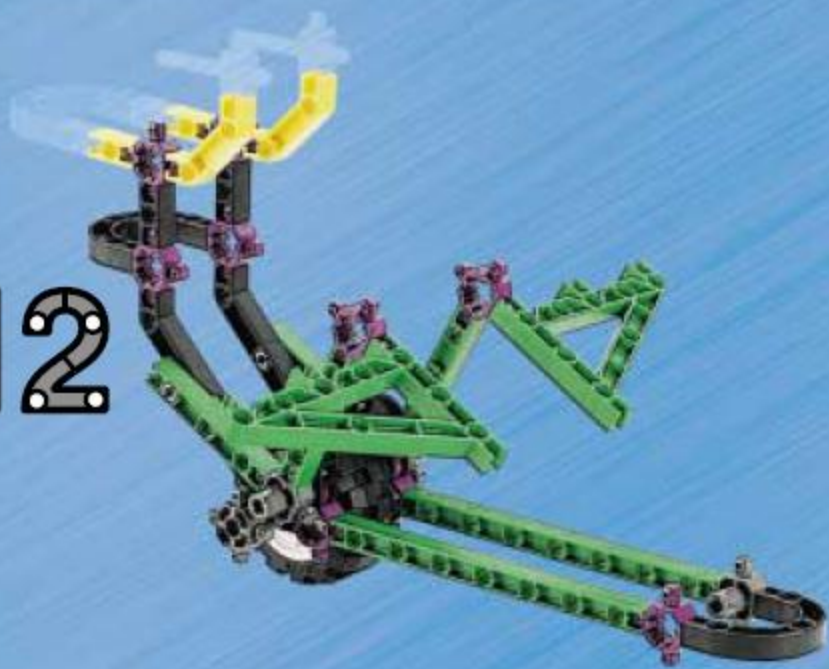

13



14







The LEGO logo is displayed in its characteristic white, bold, sans-serif font with a thick black outline, set against a solid red square background.

4123873

® LEGO is a registered trademark

© 1999 LEGO Group.

<http://www.LEGO.com>

