

LEGO MINDSTORMS™

ROBOTICS INVENTION

SYSTEM™

2.0

3804

CONSTRUCTOPEEDIA™

Introduction

The Constructopedia™ is a building guide for the Robotics Invention System™ 2.0. It offers suggestions, hints, and tips that help you get started with the Challenges in the software, as well as your own inventions.

To master a Challenge, follow these steps:

1. BUILD

Review the Design Brief on the CD-ROM and start building your robot. You can use the Constructopedia, or your imagination.



2. PROGRAM

You program your robot with RCX Code (included in the software). RCX Code determines how your robot reacts to its environment.



3. TEST

After downloading the program from your PC, your robot can move in and react to its environment. Now, let your creation loose and watch what happens.



With LEGO MINDSTORMS™, You Get The Power of Robotics @ Your Command™!

CONTENTS

Introduction	<i>page 2</i>
Getting Started	<i>page 4</i>
Building Instructions	
Project Ideas	<i>page 8</i>
Roverbot Section	<i>page 10</i>
Acrobot Section	<i>page 36</i>
Inventorbot Section	<i>page 56</i>
Special Features	<i>page 88</i>
Tips & Tricks	<i>page 98</i>
Light Sensor/Test Pad	<i>page 102</i>
Parts ID	<i>page 103</i>



GETTING STARTED

The following steps will help you set up your Robotics Invention System™.

Installing Batteries

For the RCX to work, 6 new AA/LR6 batteries are required. Alkaline are recommended. Rechargeable batteries can be used, but power may be reduced.



Instructions for use of battery box:

Never mix different types of batteries in one battery box. Always remove the batteries from the battery box for long-term storage or if they have reached the end of their life. Liquid leaking from dead batteries will damage the RCX. Rechargeable batteries should be recharged under adults supervision.

When the RCX's batteries are low, this icon  will appear in the RCX's display window.

RCX: THE BRICK

The RCX (Robotics Command System) is a programmable LEGO® brick. It has three sensor (input) ports, three output ports, four control buttons, an LCD display, and an infrared transmitter. It also has a microprocessor to process programs, internal memory to store firmware and programs, and a built-in speaker to produce beeps and tones.

Being a LEGO brick, it has LEGO studs and holes to allow the connection of other LEGO bricks and pegs.

The sensor ports are used for attaching Light and Touch Sensors (as well as Rotation and Temperature Sensors, not included in this set).



Install batteries as shown.



The output ports are used for attaching motors (as well as lights and other output devices, not included in this set).

In addition, it has three internal sensors: a timer (to keep track of time), an RCX message holder (to receive messages sent from other RCX units), and user defined variables.

By programming the RCX to react to sensors, you create behaviors for your inventions... You make your robots smart.

Connecting Motors

To connect a motor to the RCX, you need to use the black wires with connector plates.

Attach one end of the wire to the motor and the other end to a black output port.

The side you attach the wire to can affect the direction of the motor. When building models in this book it is important to attach the wires as shown.

Connecting Sensors

To connect the Touch Sensor to the RCX, you need to attach one end of the wire to the sensor and the other to a gray sensor port.

The Light Sensor already has a wire connected to it. Attach its plate to a gray sensor port.

When building the models in this book, it is important to connect the sensors to the ports shown in the building instructions.

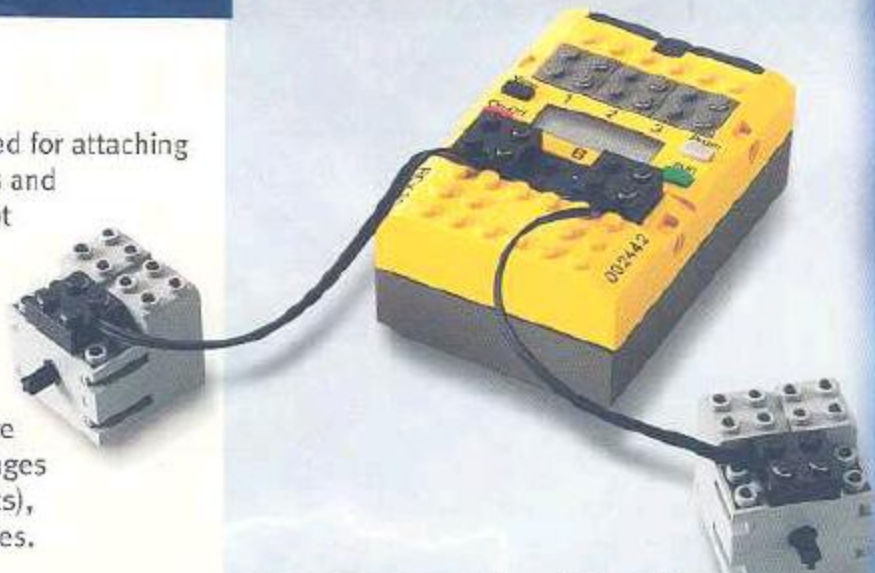

With the wire attached this way, the motor turns one direction.



With the wire attached this way, the motor turns the other direction.





RCX: THE BUTTONS

The buttons are used to control your RCX and its programs.

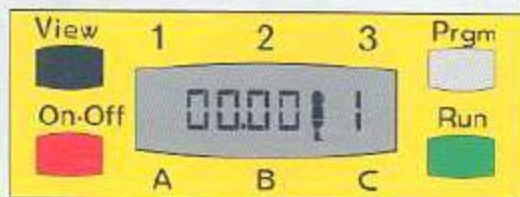

On-Off turns the RCX on and off. The other three buttons only work when the RCX is on.

Run starts and stops the selected program. In the "Run" mode, the "little person" in the display window appears to be running.

Prgm (which stands for Program) allows you to switch between the five program slots in the RCX. The number of the selected program appears to the right of the "little person" in the display window.

View (only active after firmware downloaded) allows you to get information on sensors and motors. You can see sensor readings at input ports 1, 2, or 3, and motor direction at output ports A, B, or C.

To use the **View** button to check a Touch (or Light) Sensor's reading:

1. Make sure you have downloaded a program that uses a Touch (or Light) Sensor and have run it at least once.
2. Make sure the Touch (or Light) Sensor is attached to a sensor port on your RCX.
3. Make sure the RCX is on.
4. Press the **View** button, so the arrow in the display window points to the port where the Touch (or Light) Sensor is attached.

For the Touch Sensor

5. Press and release the Touch Sensor while looking in the display window. When the Touch Sensor is pressed, the number should be 1. When it is released, it should be 0.

For the Light Sensor

5. While looking at the display window, move the Light Sensor's eye back and forth over the black line on the Test Pad. The number will be low when it sees the black line, and high when it sees the white paper.

RCX: THE DISPLAY WINDOW

The display window shows you information about the RCX and your programs.

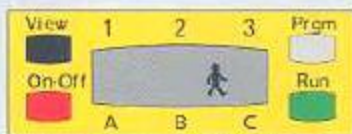

The "little person" running indicates that the RCX is executing a program. The person starts running when the Run button is pressed.

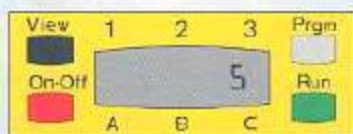

The number (1-5) appears to the right of the "little person." It indicates which of the 5 programs will be activated when the Run button is pressed.

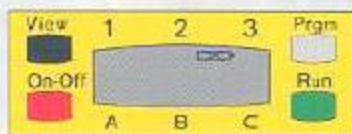

The battery low indicator lights up when battery charge is low. It flashes and the RCX beeps when the battery charge is very low.



A short or long range infrared communication cone lights up when communication between the IR Transmitter and the RCX is taking place.

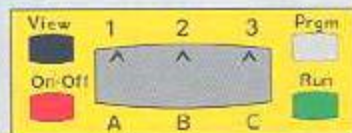
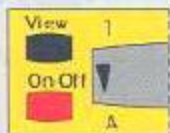

An arrow displayed below a sensor port indicates that the sensor port is being used by the view button.

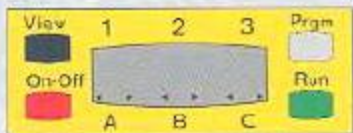

An arrow displayed above an output port indicates that the output port is active. The direction of the arrow shows the direction of a motor connected to the port.

THE FIRMWARE

The first time your RCX is turned on, or after batteries have been switched (and it took you longer than one minute to change them), your RCX is in "Boot Mode."

You can see if your RCX is in Boot Mode by looking at the display window. If there is no Software Watch, it is.

Boot Mode

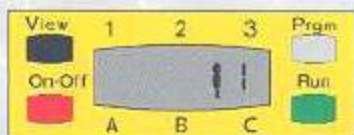

Full Function Mode

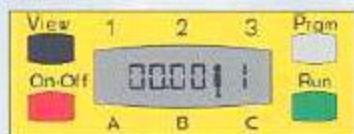

In Boot Mode, you cannot download programs to your robot because your RCX needs firmware. Firmware is special software that allows communication between your computer and the RCX to occur. It acts as the RCX's operating system.

However, if you are in Boot Mode and do not have access to a PC, or if you just want to play with your RCX right now, you can use any of your RCX's five built-in programs.

IR TOWER

The IR Tower establishes a wireless link between your computer and the RCX. With the IR Tower, programs can be downloaded from your computer to the RCX. These programs can then be executed (run) by the RCX.

The IR Tower uses infrared signals to send messages.

For communication to occur, the RCX and IR Tower must be able to see each other. Even though 4-6 inches (10-12 cm) works best for downloading, in optimal lighting conditions, communication is still possible at distances up to 90 feet (30 meters) away.



To Download firmware to your RCX:

Make sure your tower is plugged in and your RCX is turned on. Run the Robotics Invention System™ software and click the Settings button on the Main Menu. Click the button for downloading firmware.

Downloading takes approximately 4 minutes. The Software Watch counts as the firmware is downloading and will beep when it is done. Do not switch off or move your RCX while downloading.

For more information about setting up your RCX to work with your PC, go to Settings.





PROJECT IDEAS

Below are the three robots used in the Challenges. You can also design your own robots for the Challenges.

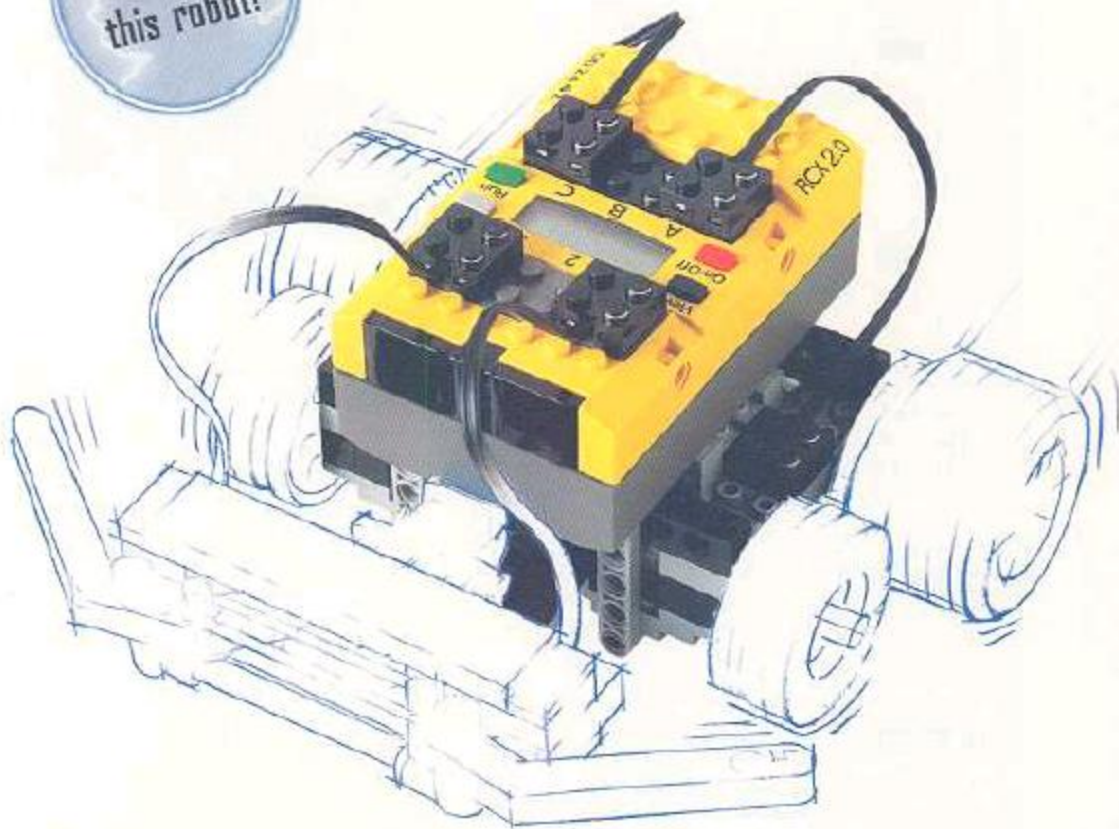

The Roverbot

is a sturdy and steady-going little robot that explores your house. It is able to move around obstacles, as well as follow a bright light and a black line.

Go to page 10 for building instructions.

The Acrobat

is a fast, wild robot that darts all over the place. It is a little clown that can do acrobatic stunts, and, by avoiding obstacles, it can do them safely.

Go to page 36 for building instructions.

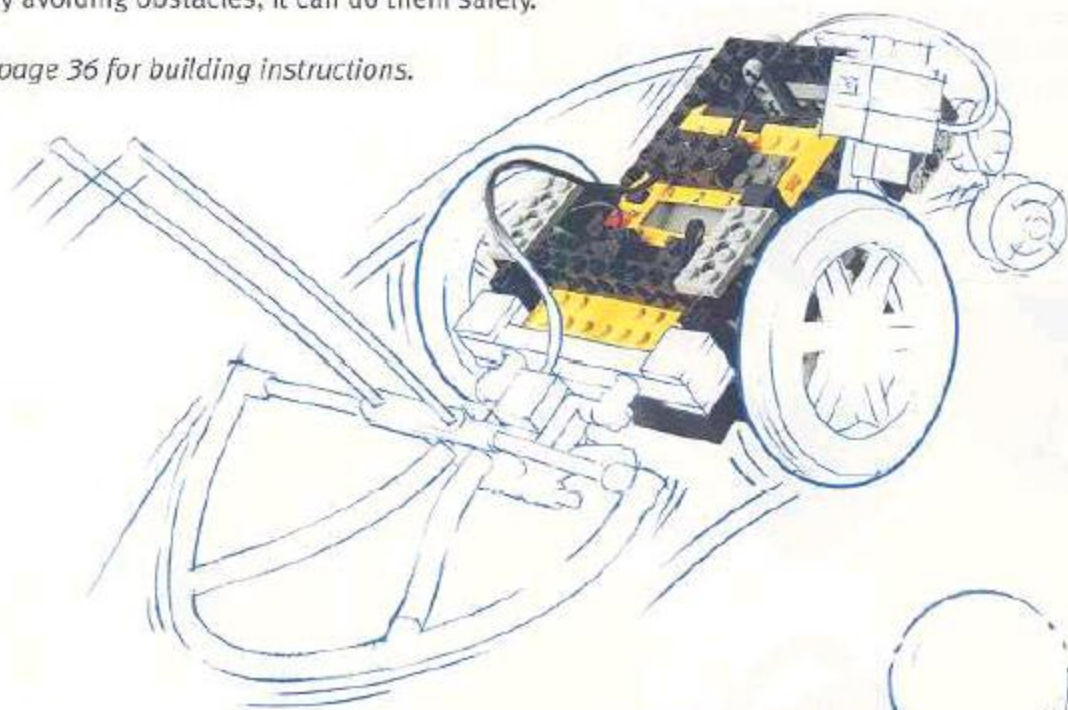

The Inventorbot

is a smart and attentive standing robot. It can greet you, throw an object, and act as an intruder alarm. It will do your bidding, after you program it to.

Go to page 56 for building instructions.

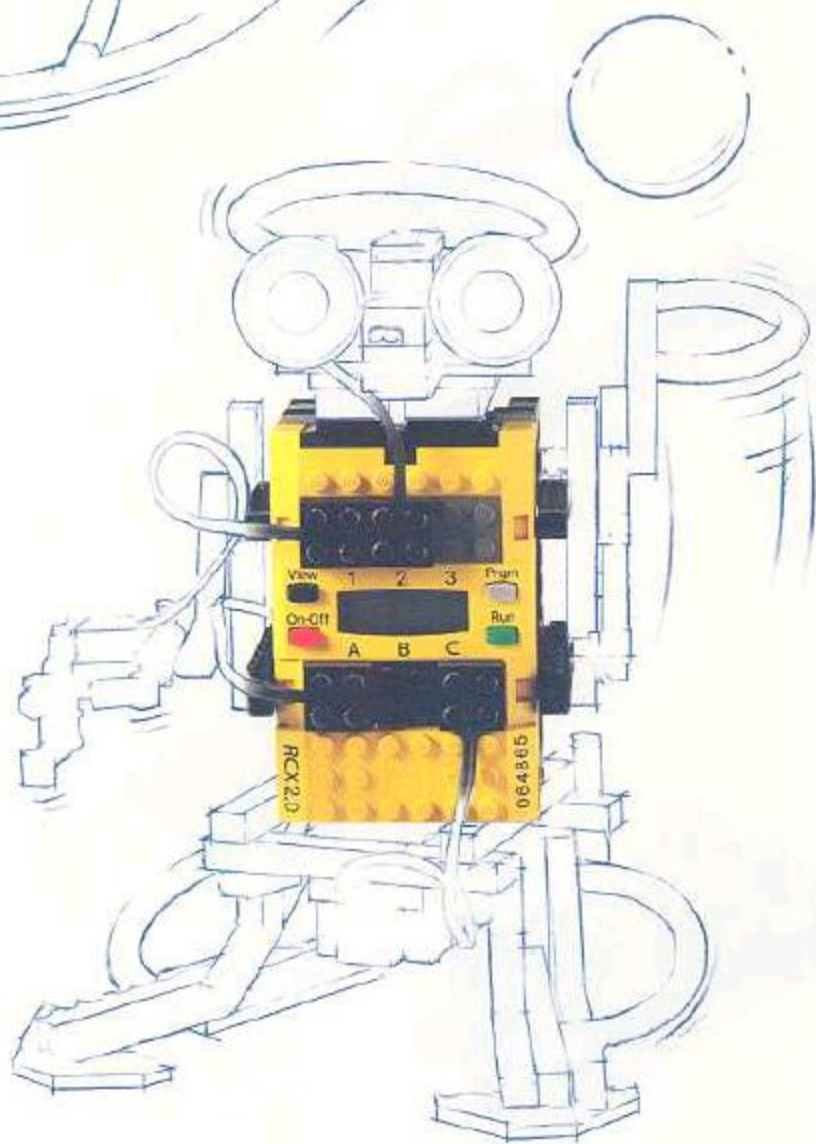



ROVERBOT SECTION

Here is an overview of the Roverbot.

The following pages show building instructions for each part.

Start by building the Driving Base, then choose which attachments you want to add.



The Wheel Sets
page 17



The Legs
page 18



The Driving Base
page 12

The Driving Base, together with the RCX forms the Roverbot.

Note: For additional attachments, as well as design suggestions, go to **Special Features** on *page 88*.

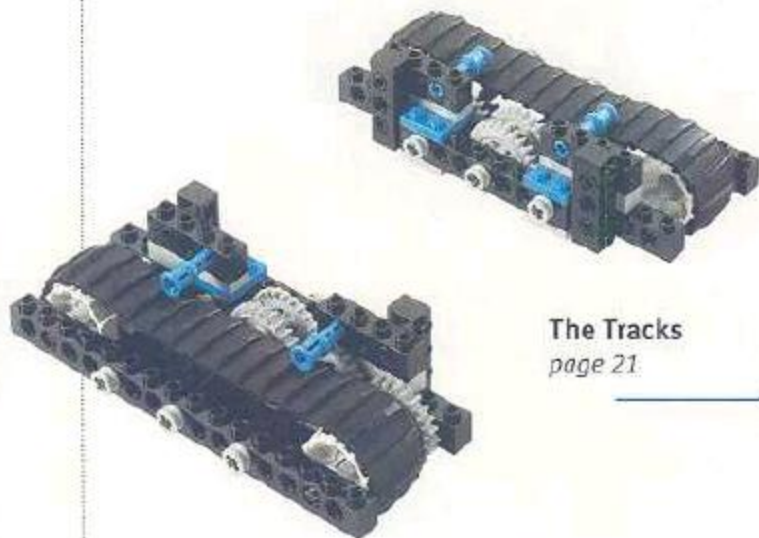

The Tracks
page 21

Examples of a Roverbot.



The Single Bumper
page 26



The Double Bumper
page 30



The Light Sensor
page 34



Driving Base

Check that your RCX has working batteries before starting.

1

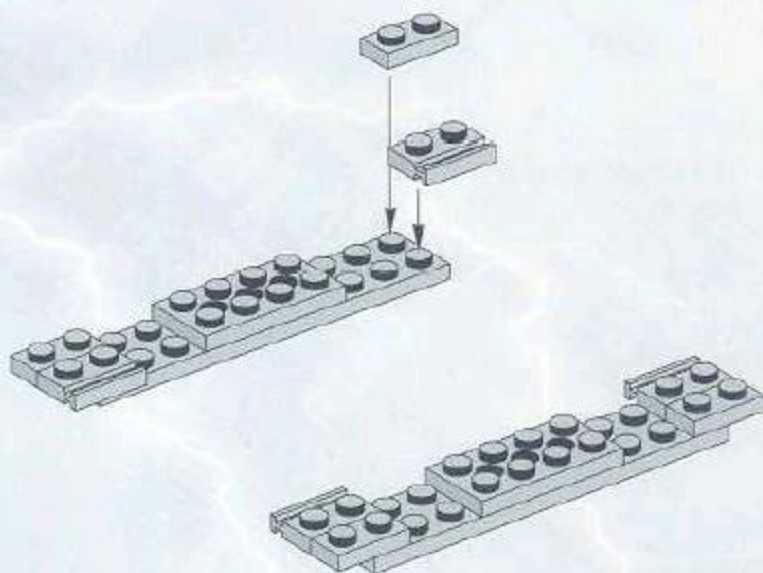
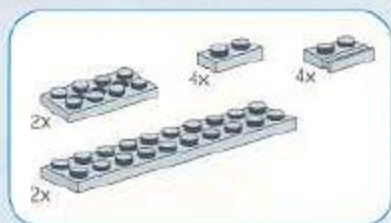

2

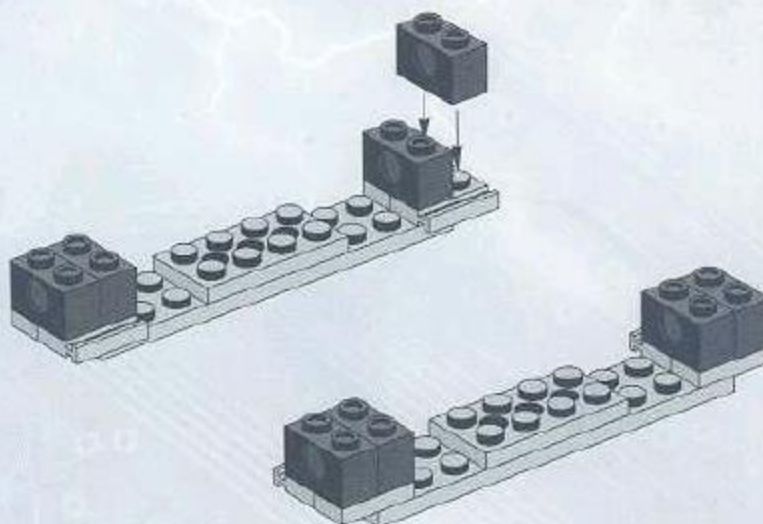



3

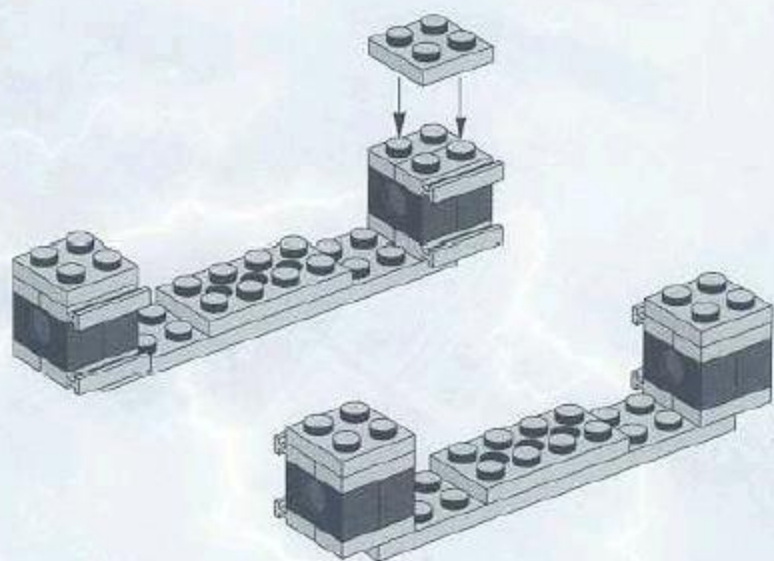

4

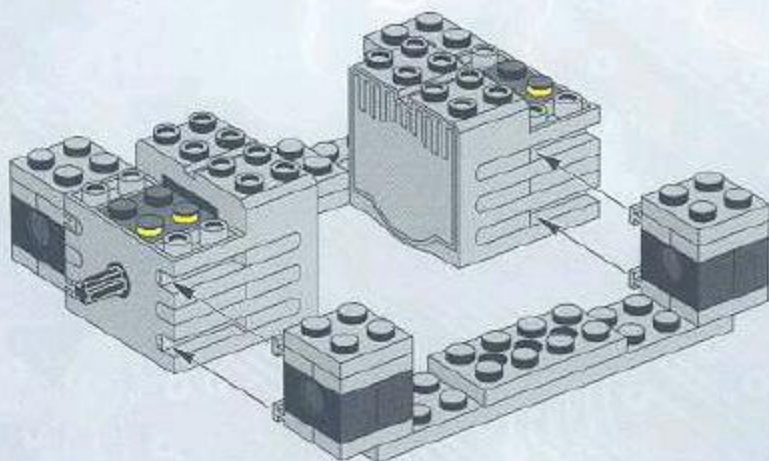



5

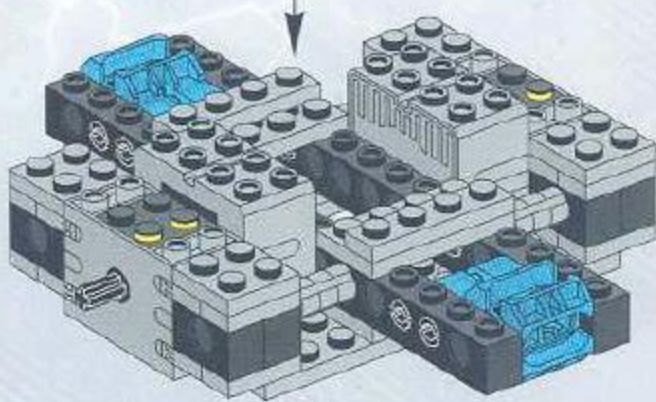
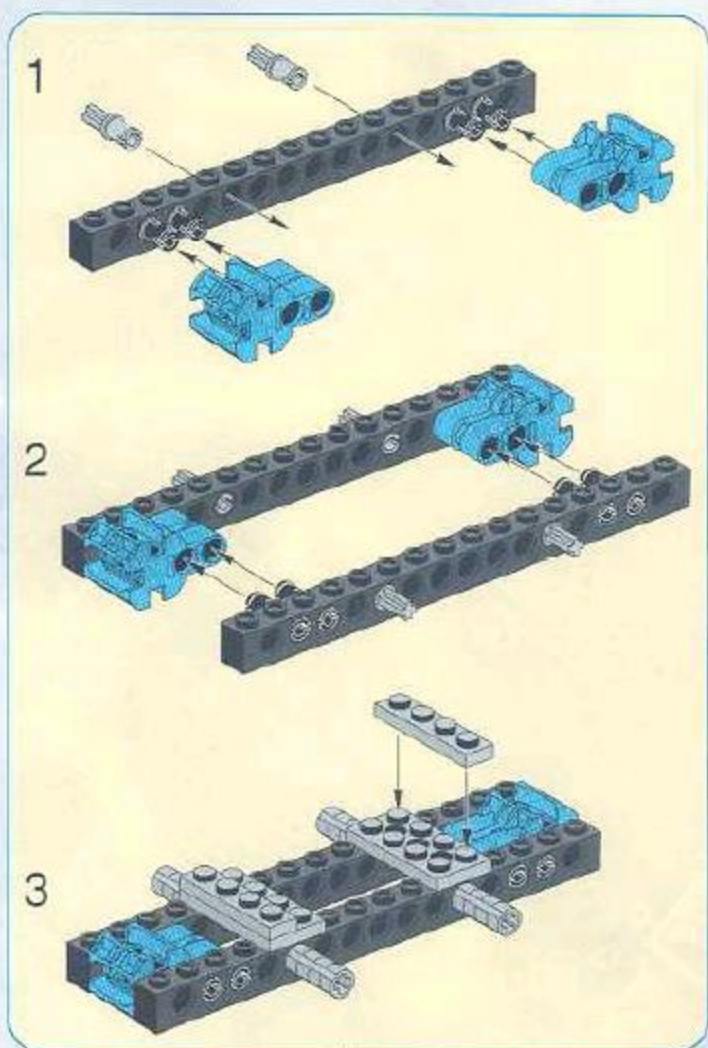
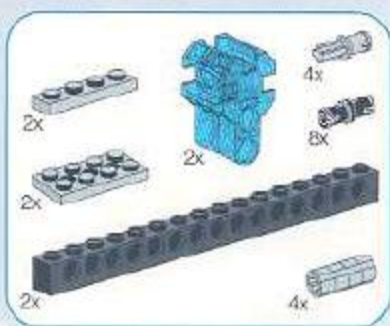

6

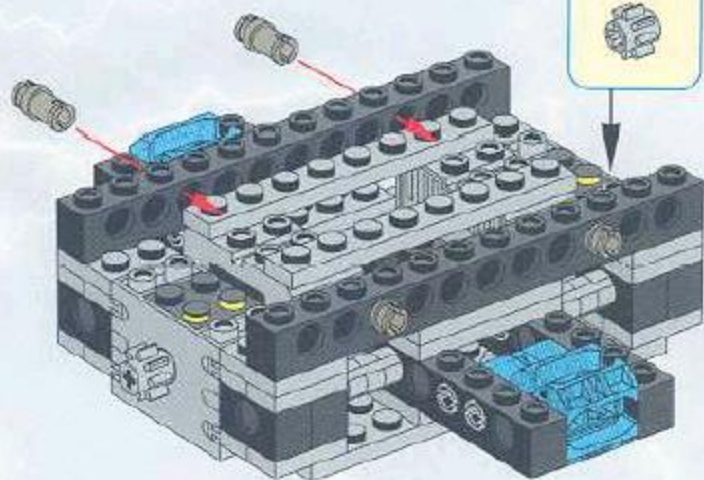
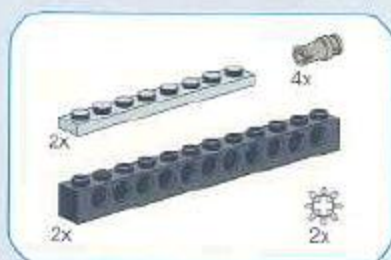

7

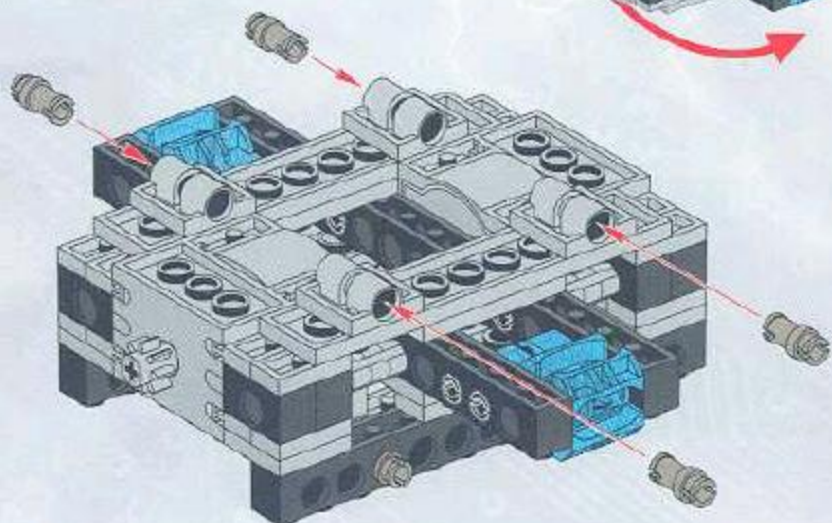
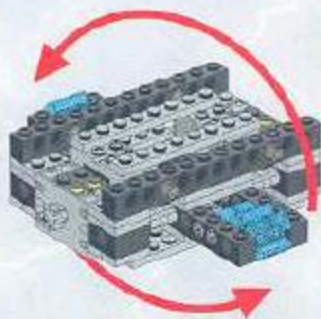



8

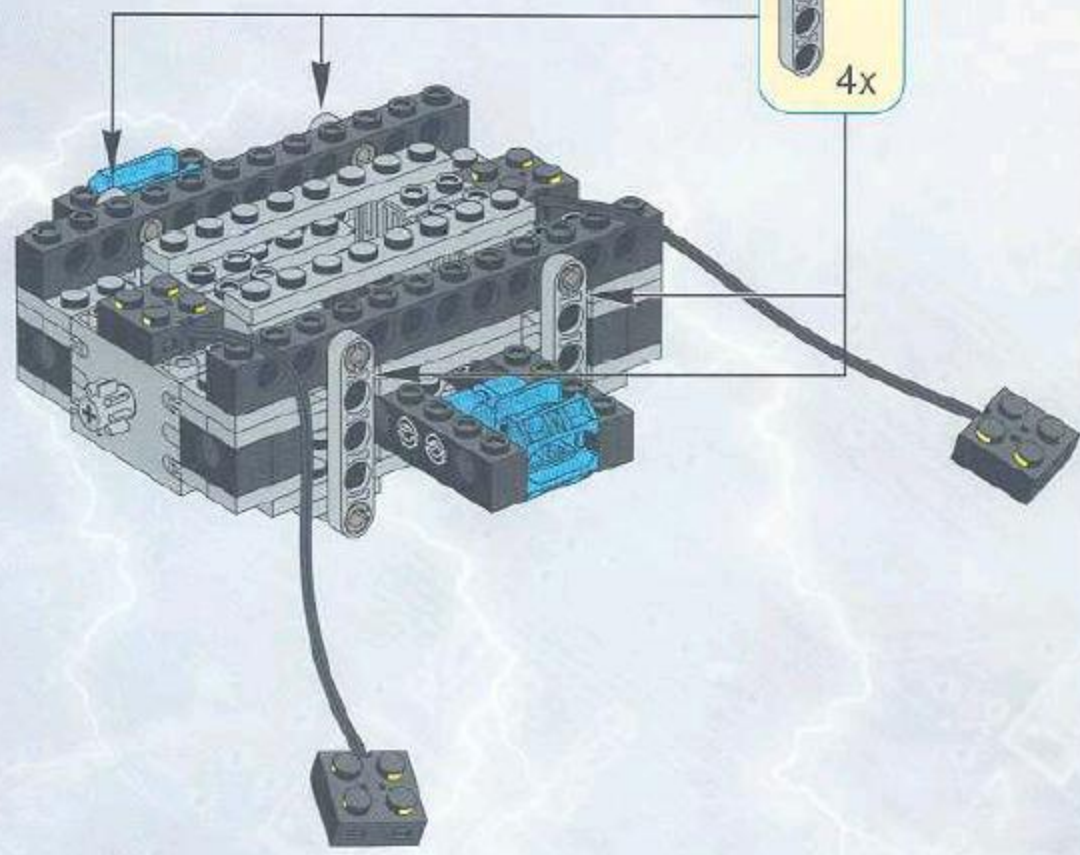
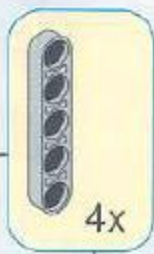

9

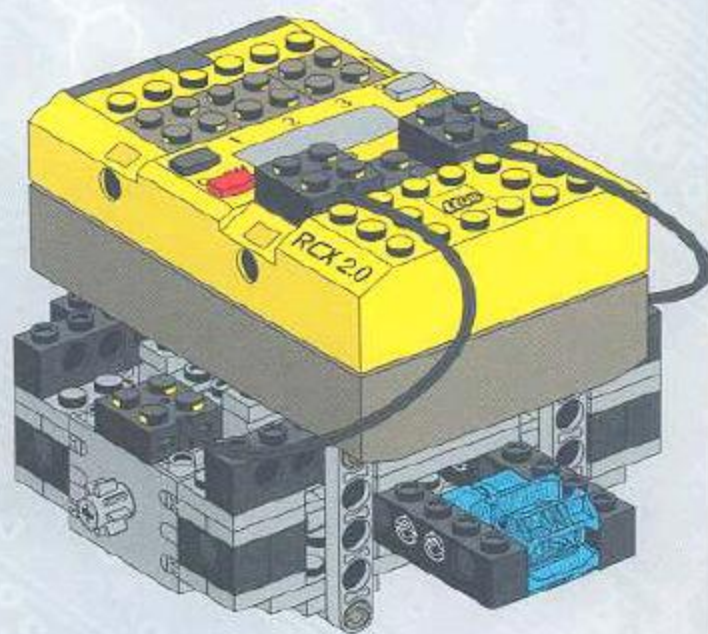
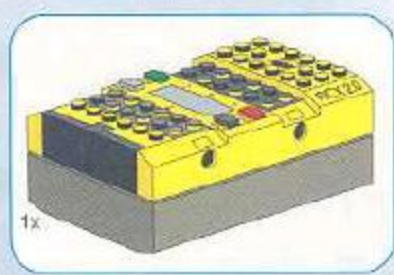

This is the Driving Base for the Roverbot. Be sure to attach the wires as shown.

Wheel Sets

1



2

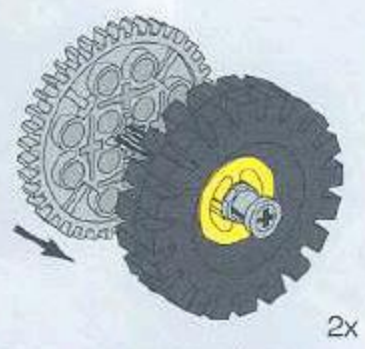

1

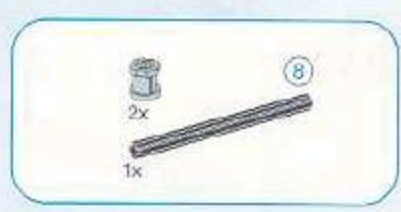

2



3

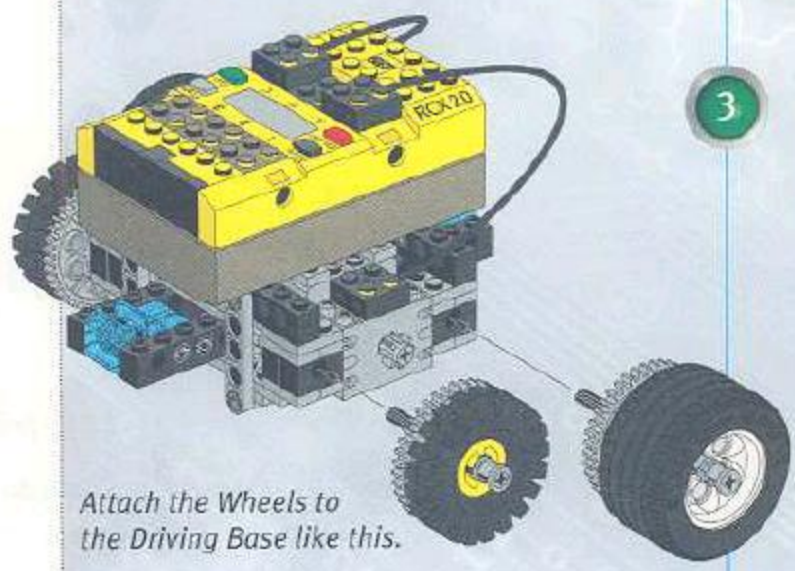
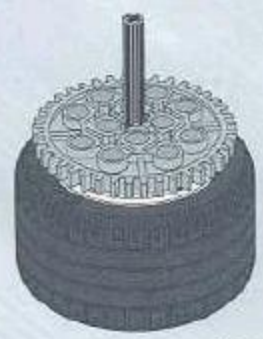

Attach the Wheels to the Driving Base like this.

If you have not yet built the Driving Base, go to page 12.

Legs

1

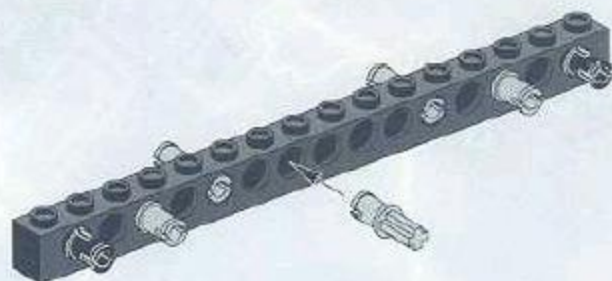

2

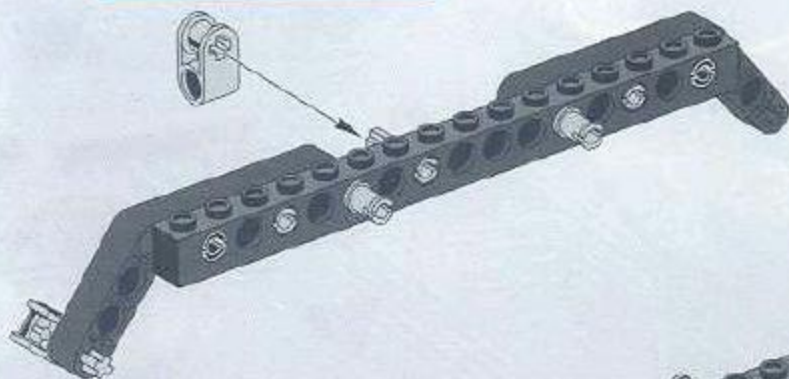
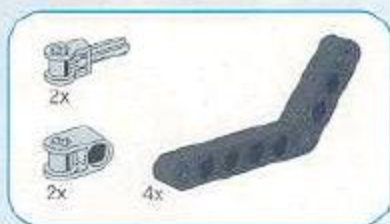

3

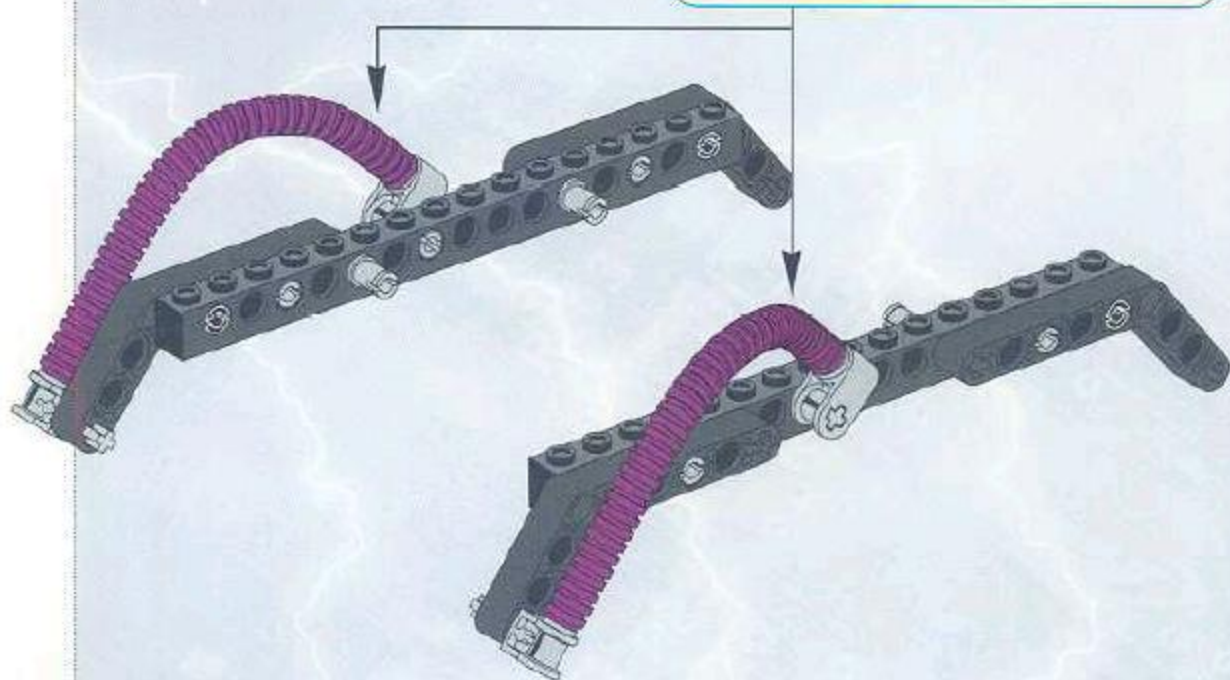

4

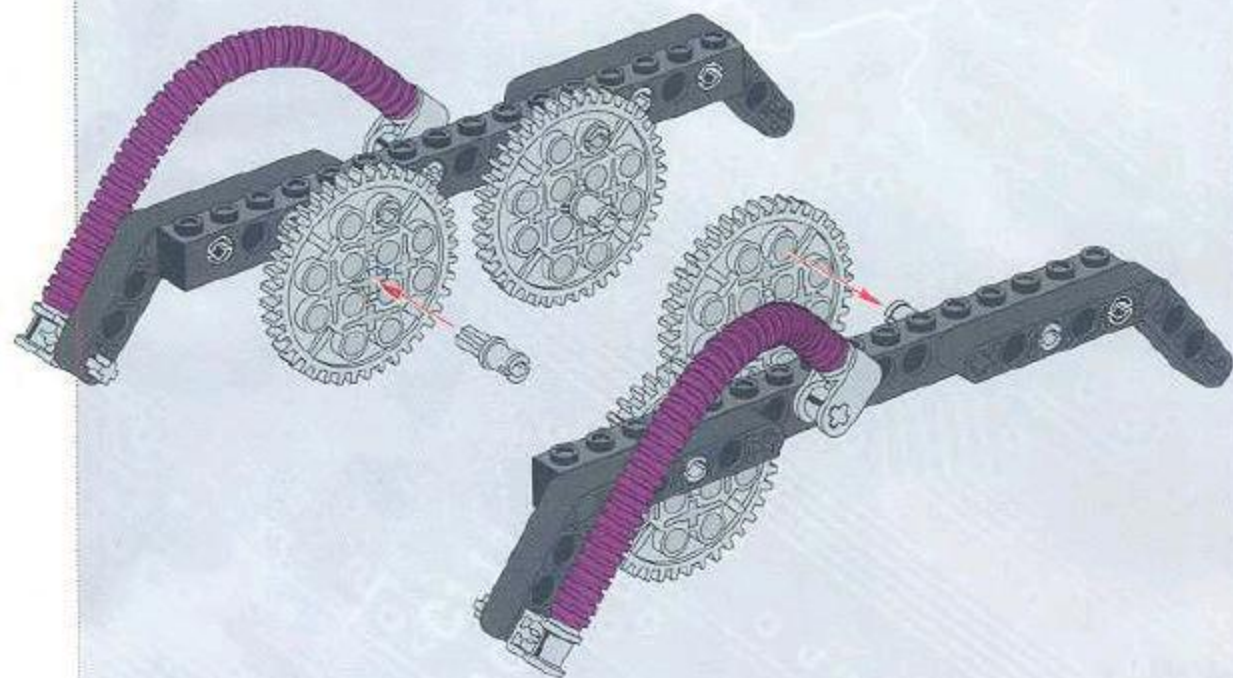



5

Attach the Legs to the Driving Base like this.

*If you have not yet built the Driving Base,
go to page 12.*

Tracks

These building instructions show you how to make one of the two tracks. As you need two, do these building steps twice.

1

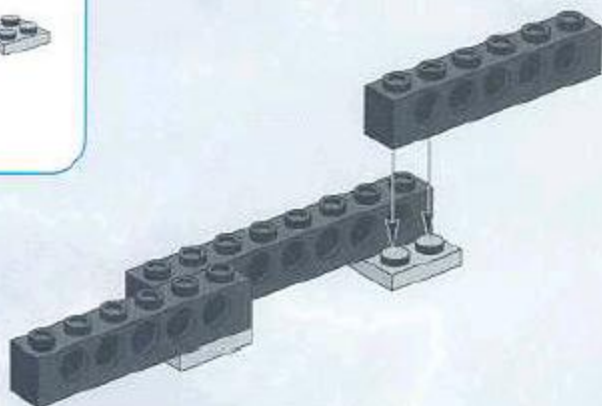
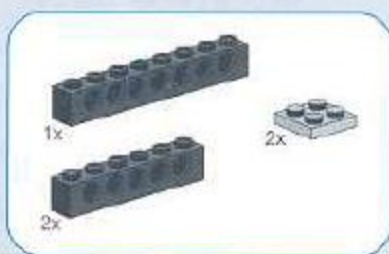

2

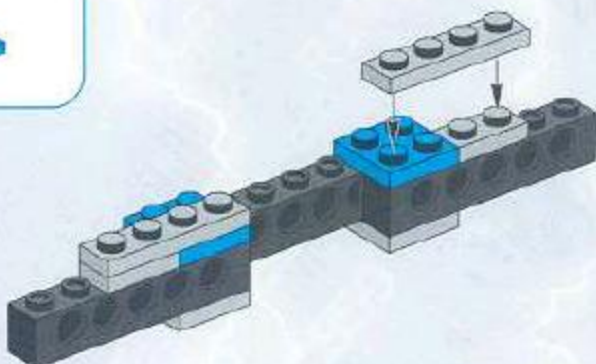
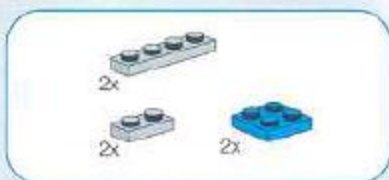

3

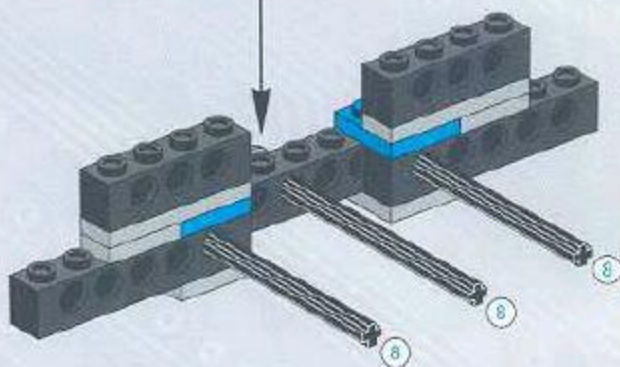
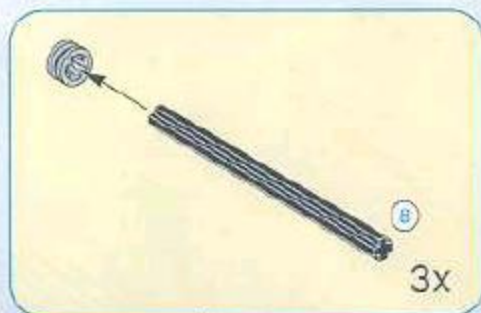

4



2x



1x

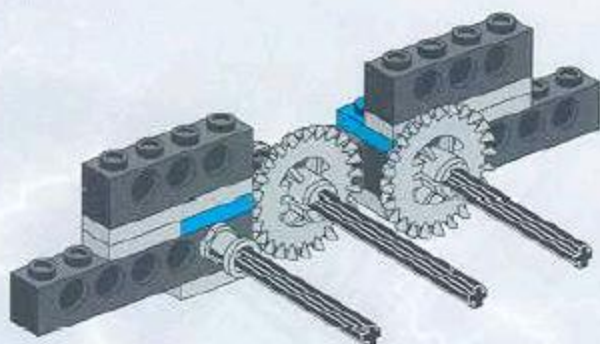

5



4x



2x



1x

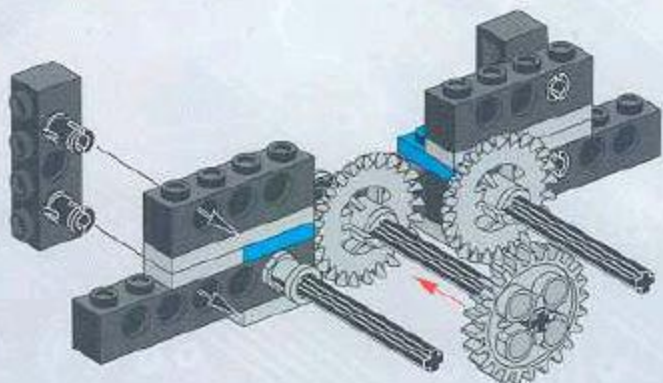

6

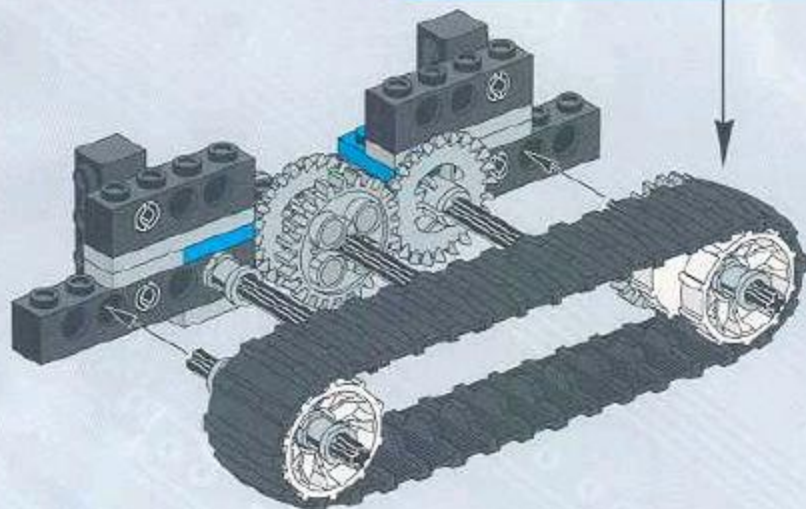
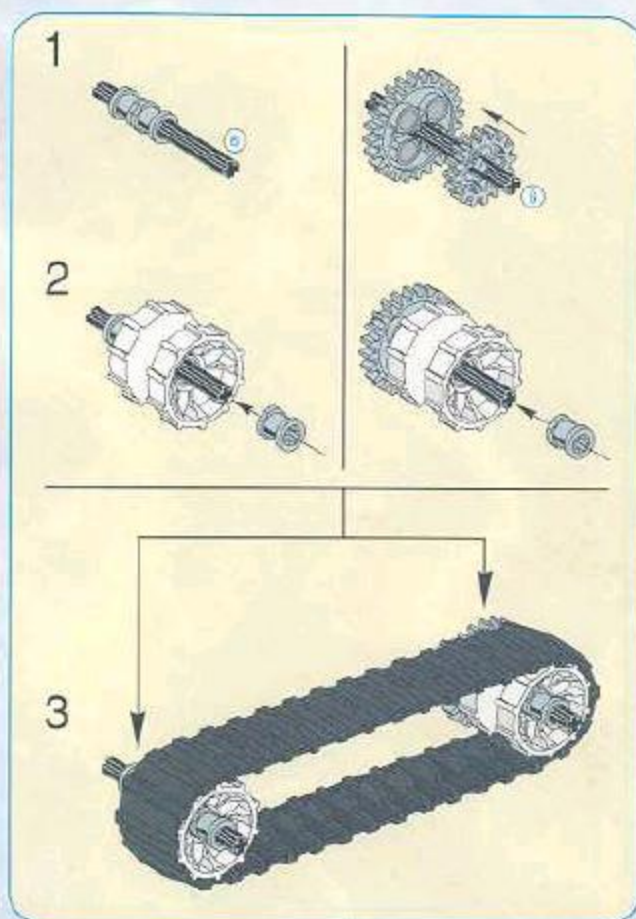

7

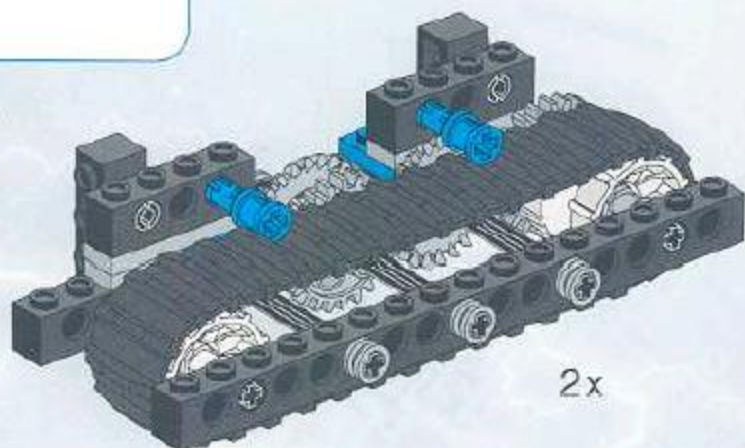

8

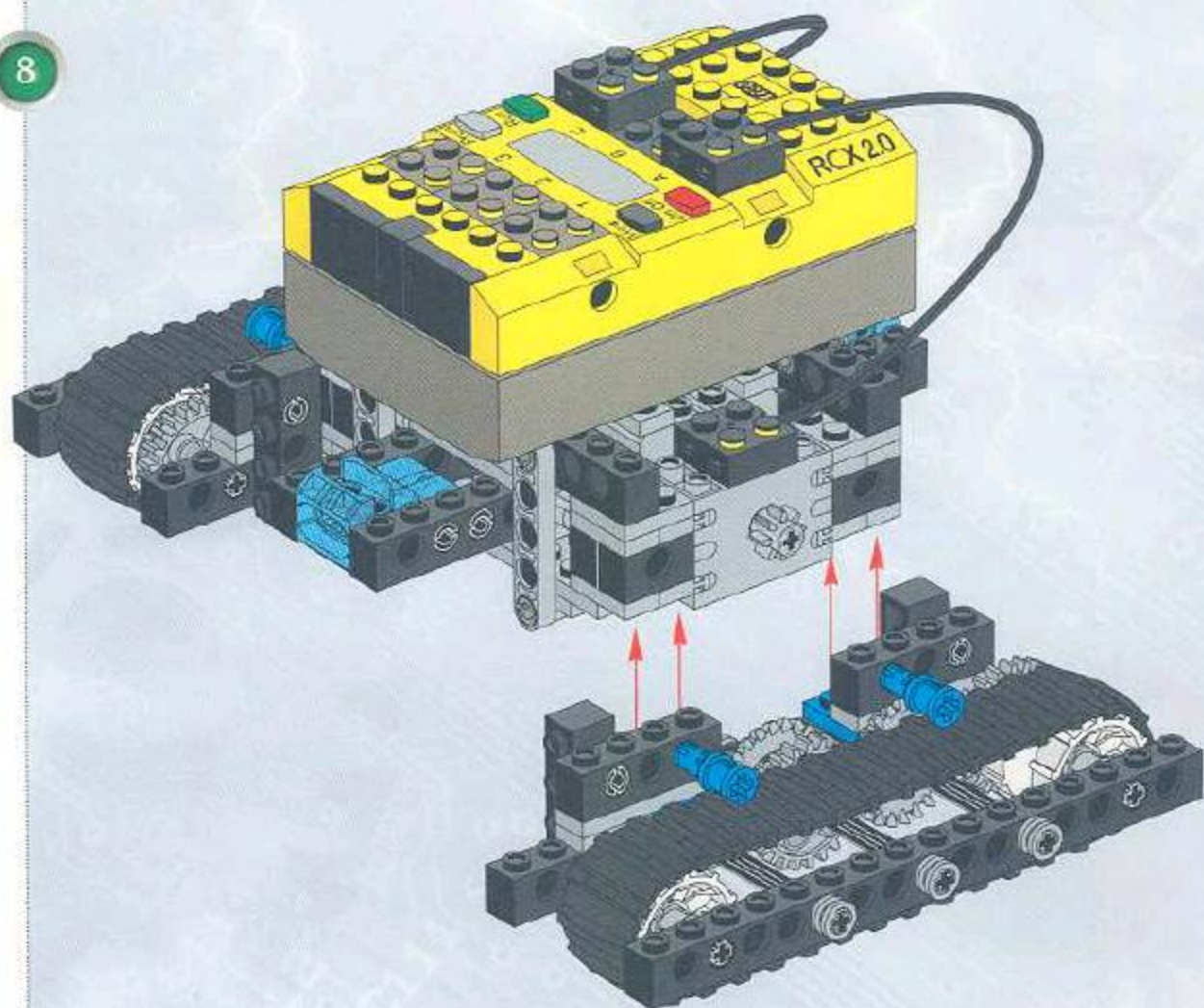

9

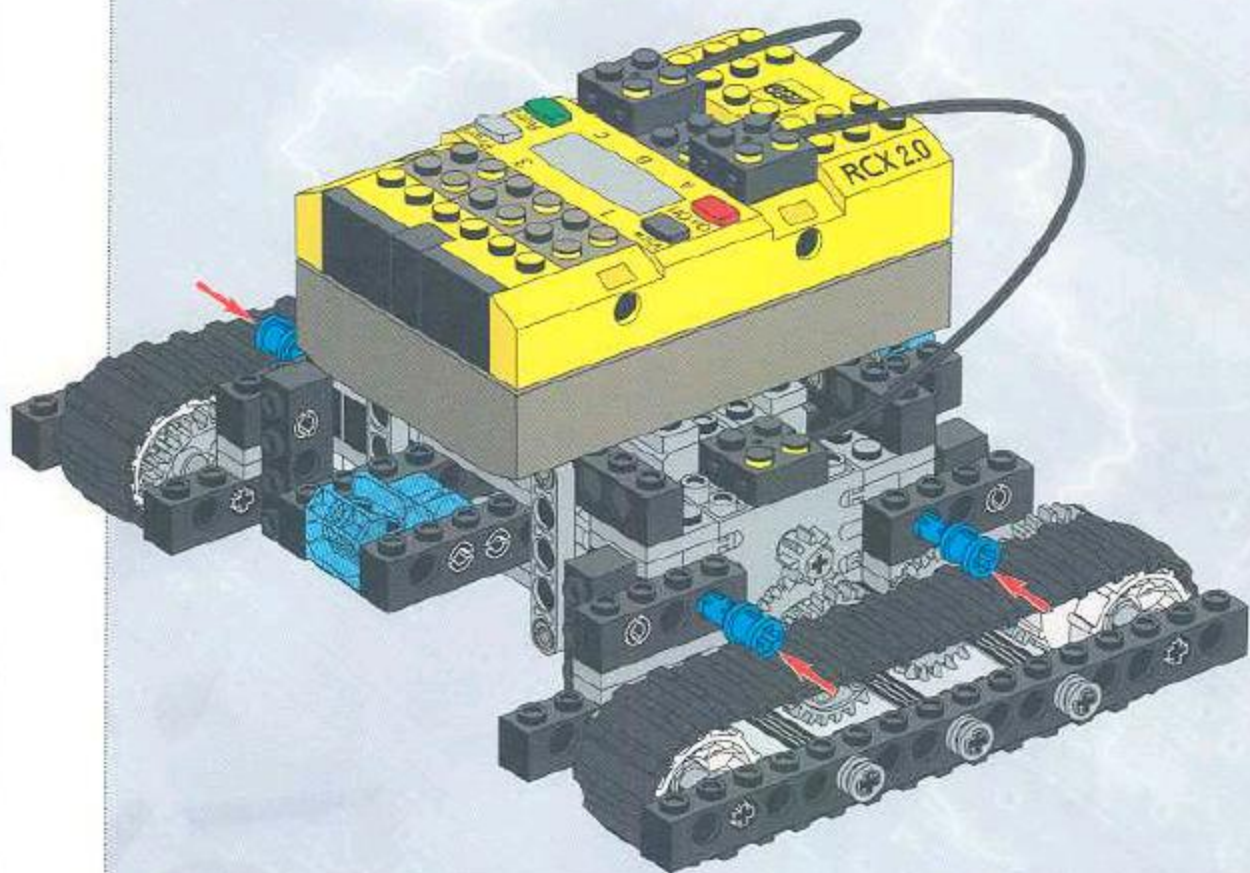

Attach the Tracks to the Driving Base like this.

*If you have not yet built the Driving Base,
go to page 12.*

Single Bumper

1



2

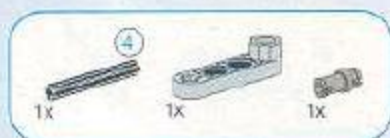

3

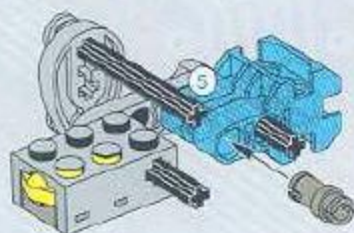
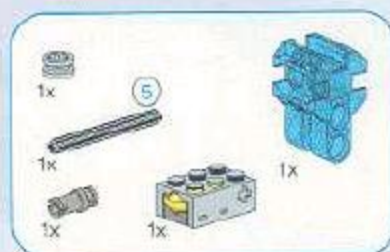

4

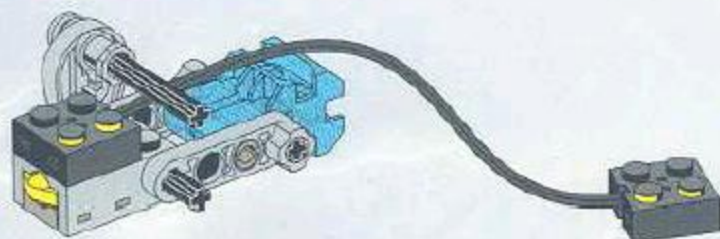
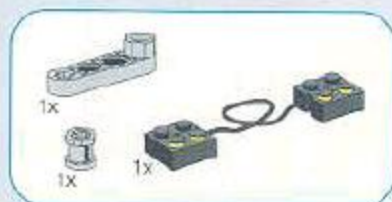

5

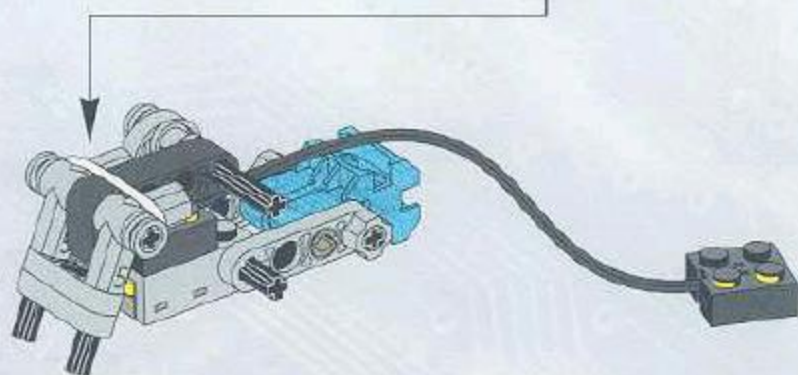
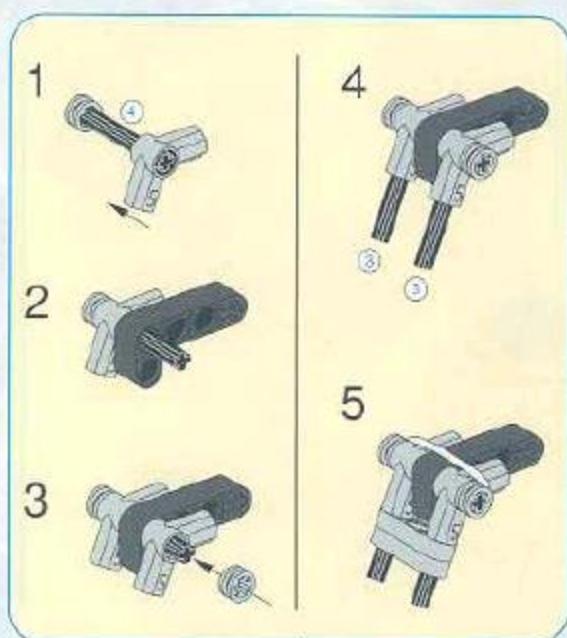



6



1x



1x

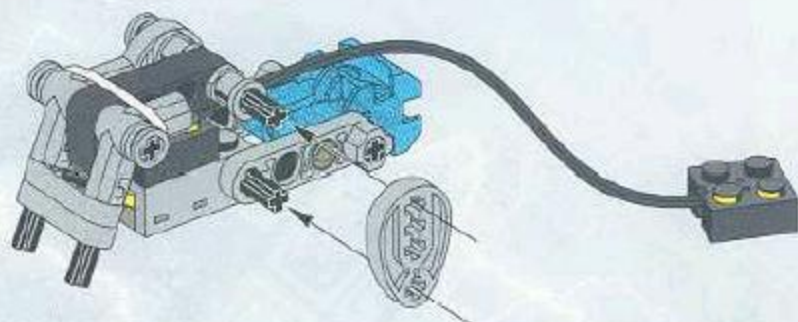

7



2x

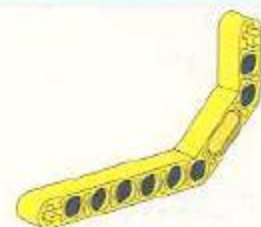

2x

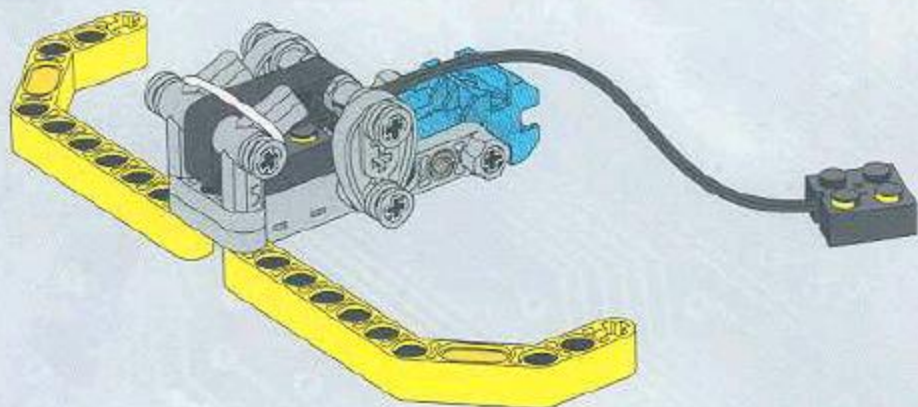

8



1x

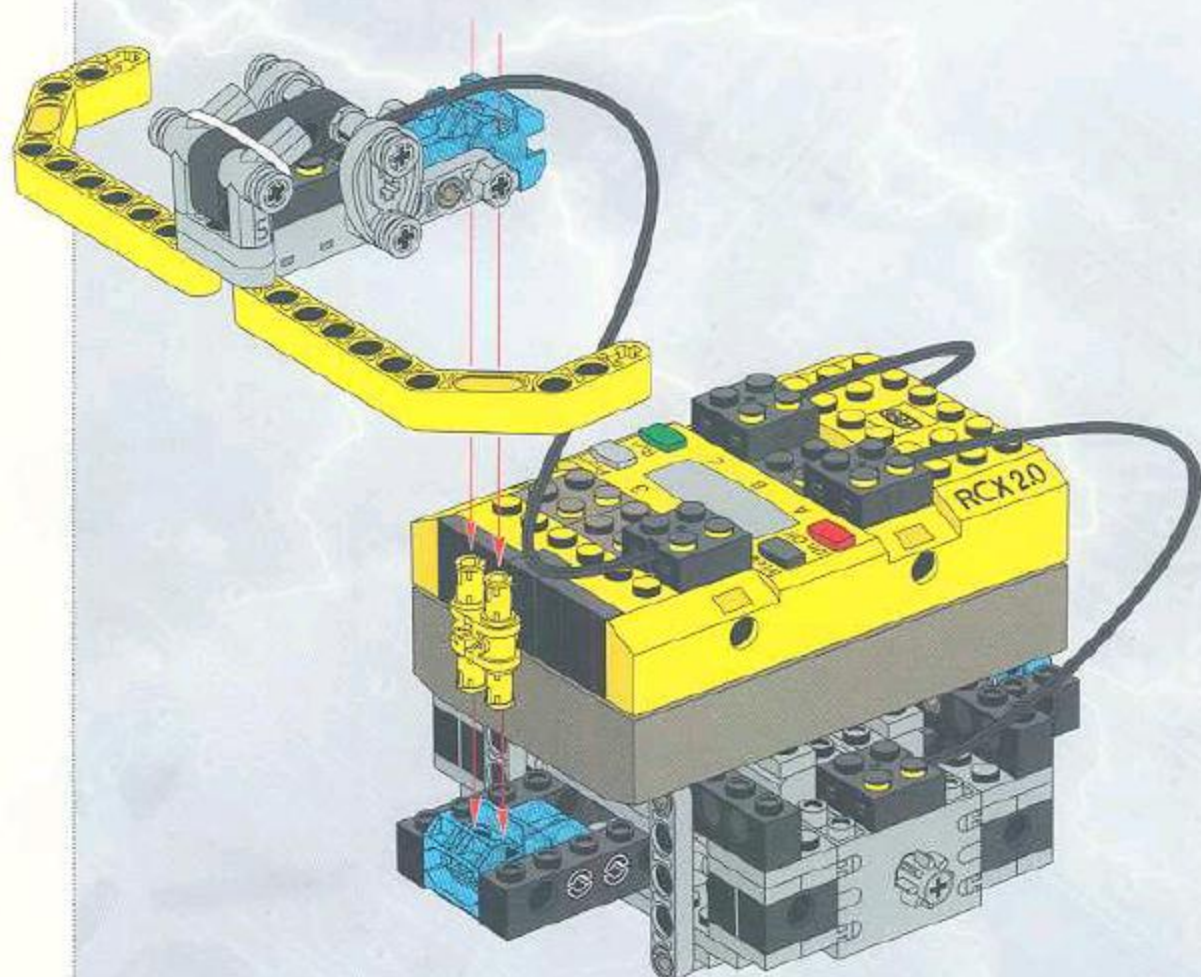

Attach the Single Bumper to the Driving Base like this.

If you have not yet built the Driving Base, go to page 12.

Double Bumper

1

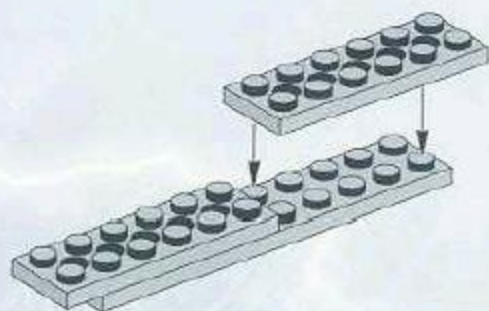

2

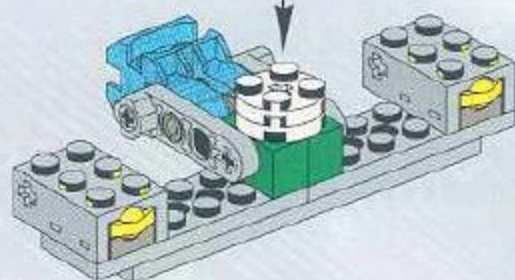
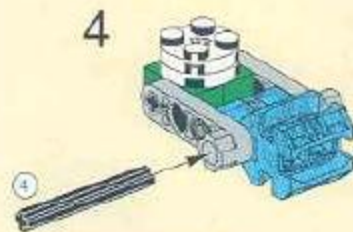
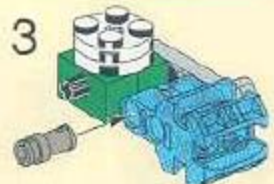
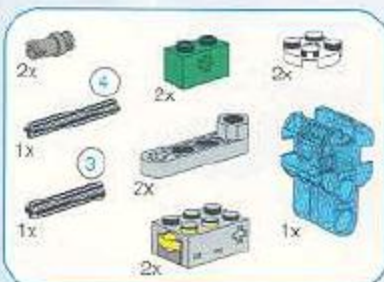

3

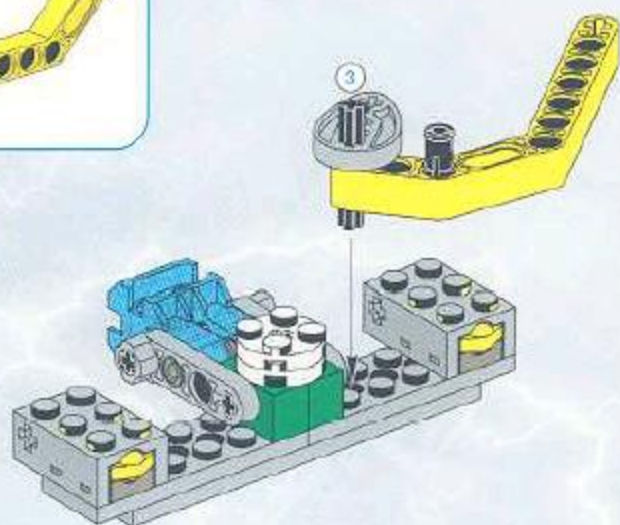
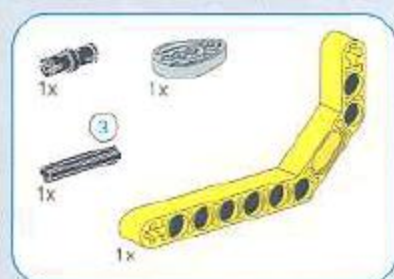

4

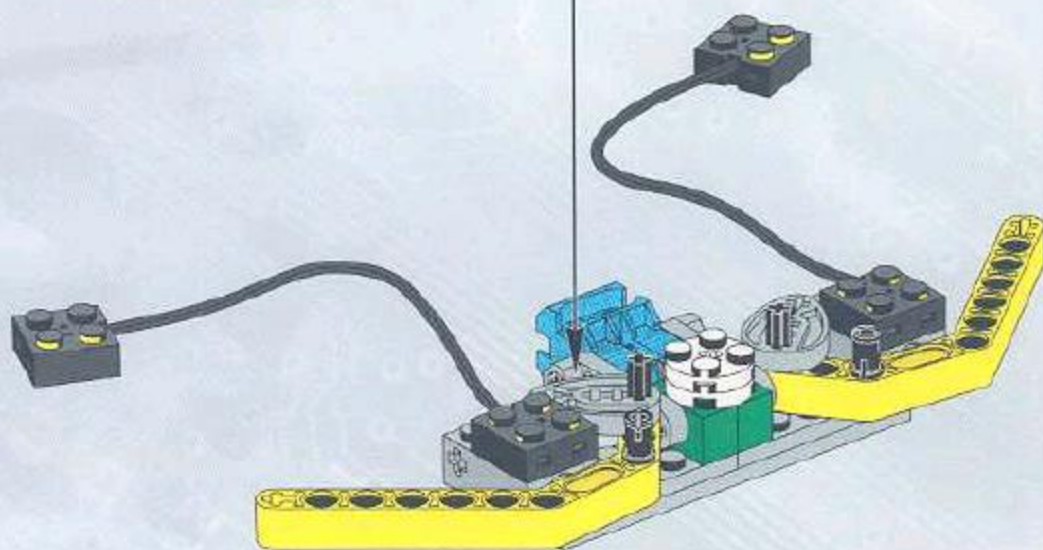
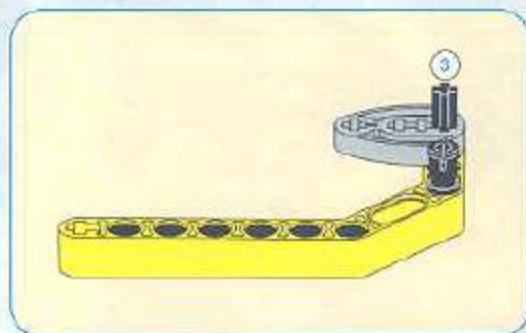



5

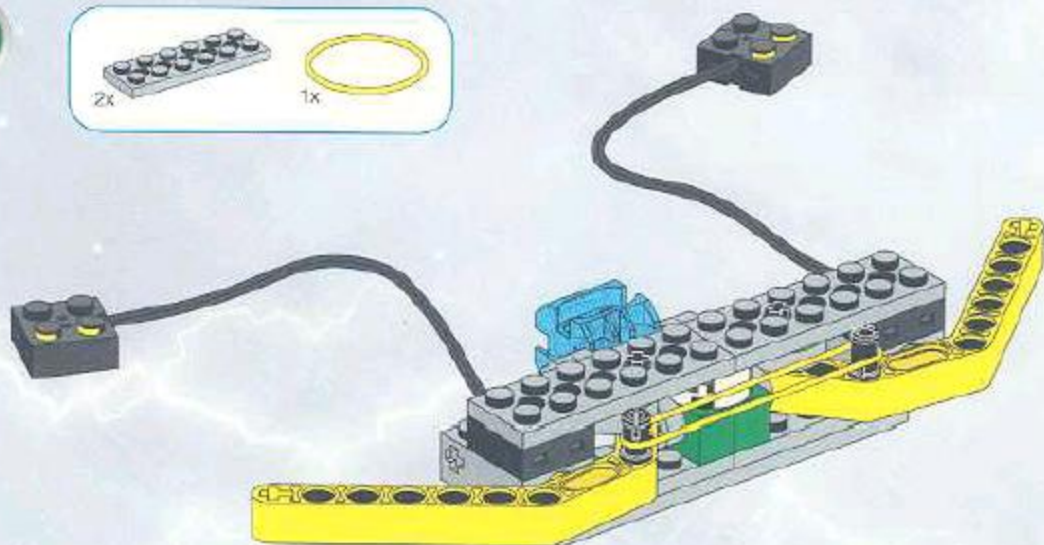

6

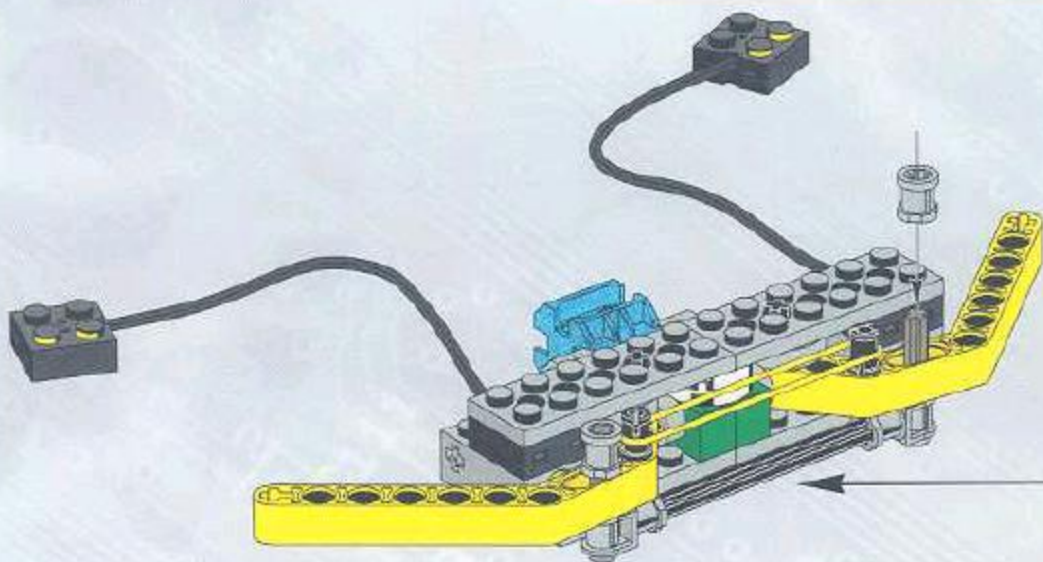
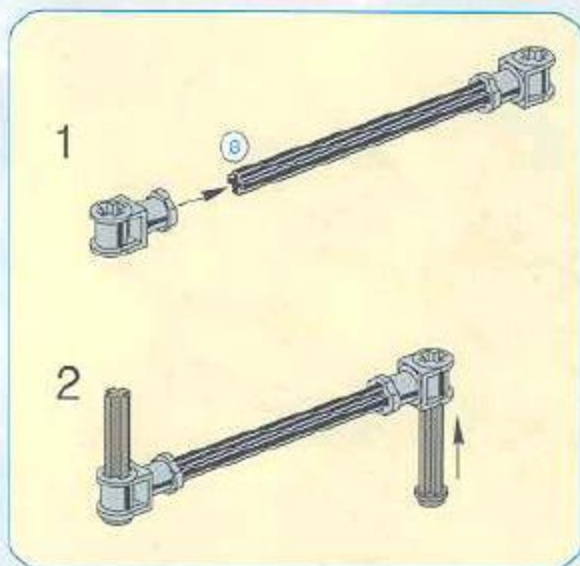
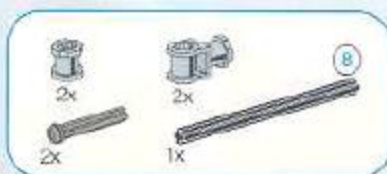

7

1x

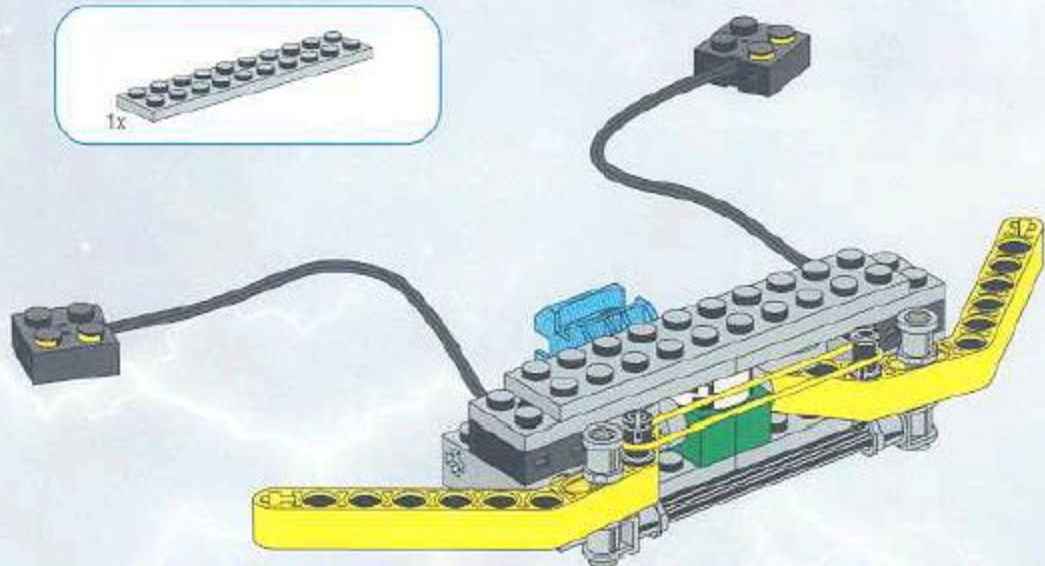

8

1x

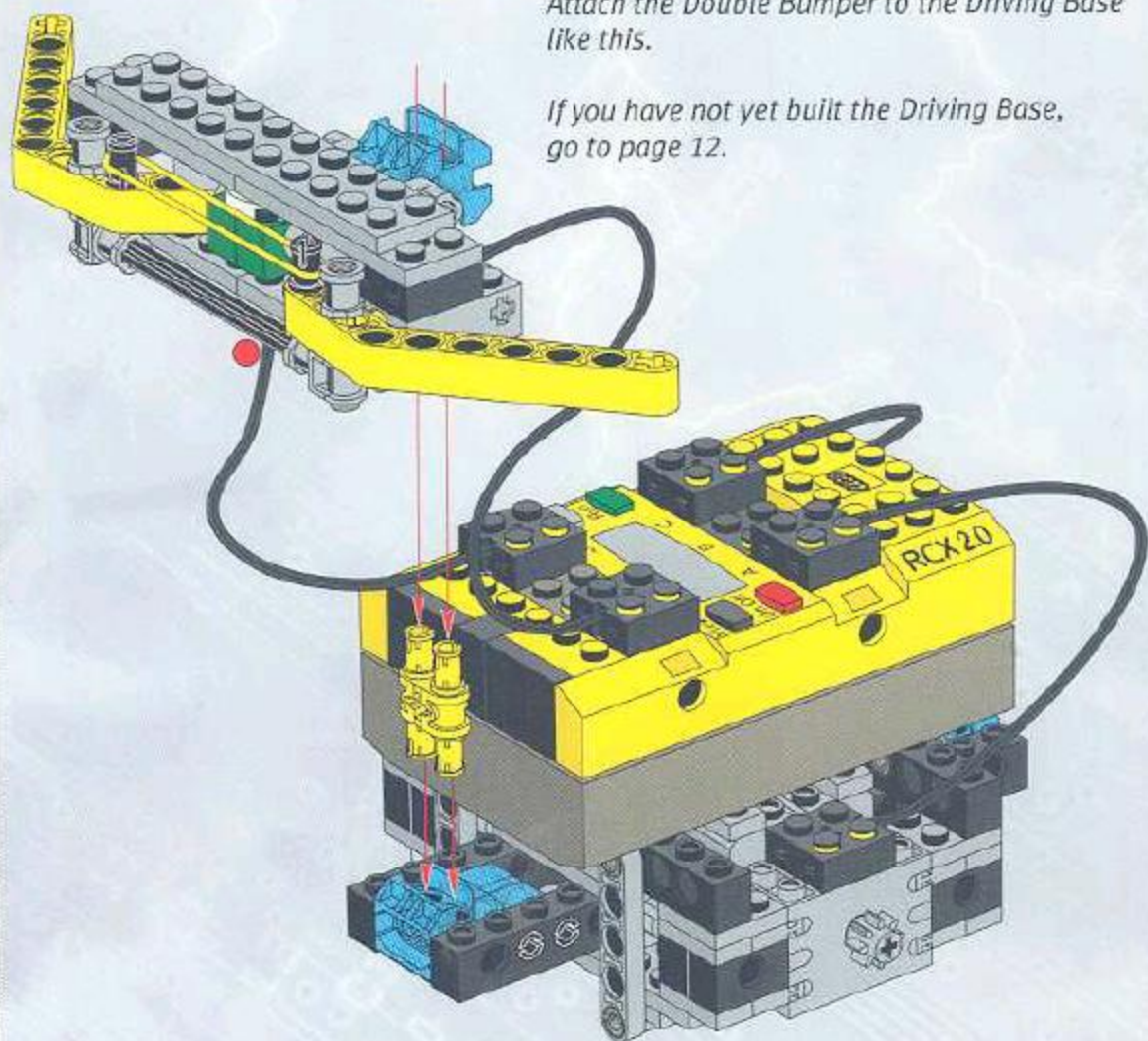

Attach the Double Bumper to the Driving Base like this.

If you have not yet built the Driving Base, go to page 12.

Light Sensor

1



2

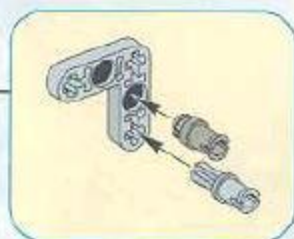

3

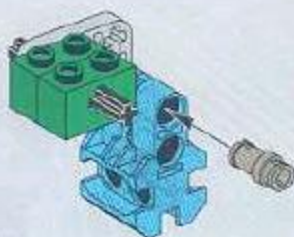

4

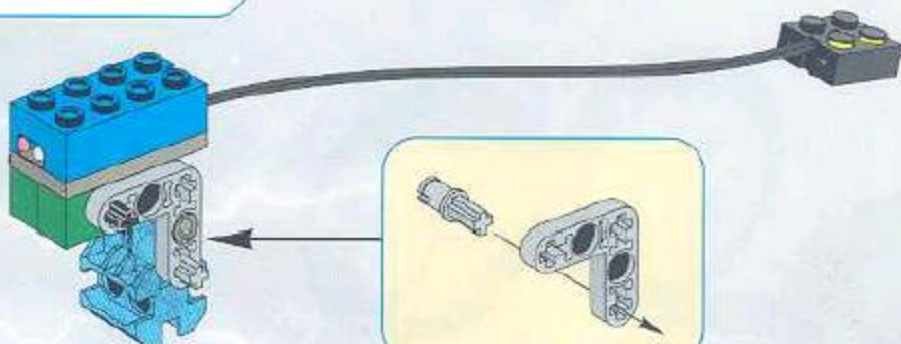
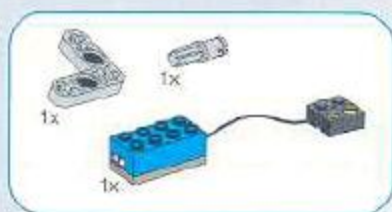

5

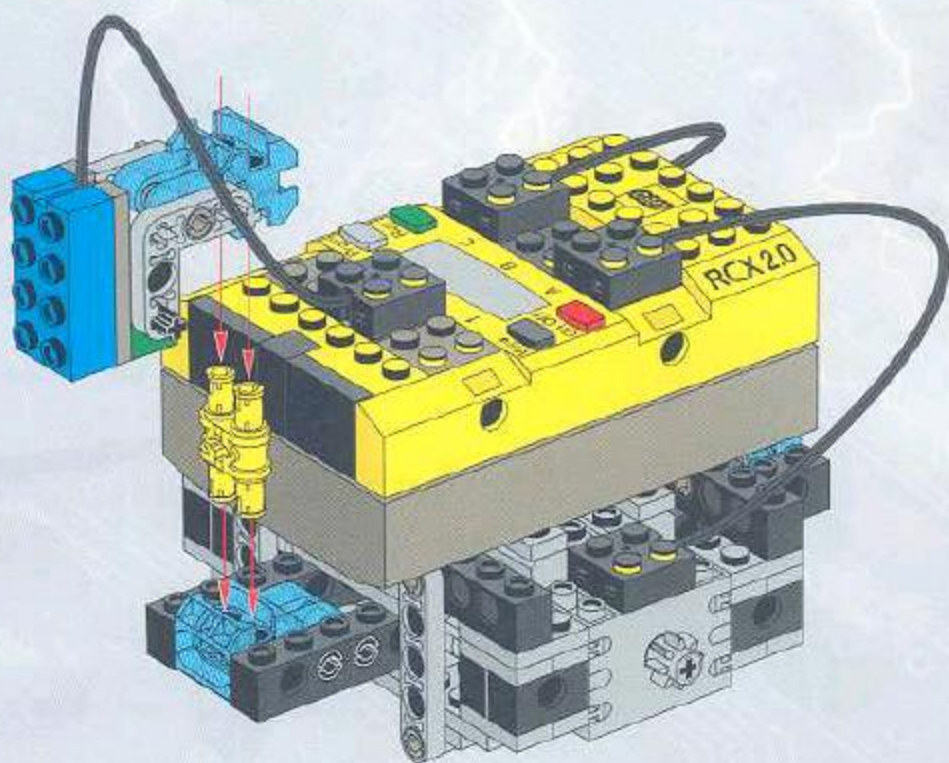

Attach the Light Sensor to the Driving Base like this.

If you have not yet built the Driving Base, go to page 12.



ACROBOT SECTION

Here is an overview of the Acrobot.
The following pages show building instructions for each part.
Start by building the Driving Base, then choose which attachments you want to add.



The Big Wheels
page 45



The Pivot Wheel
page 46

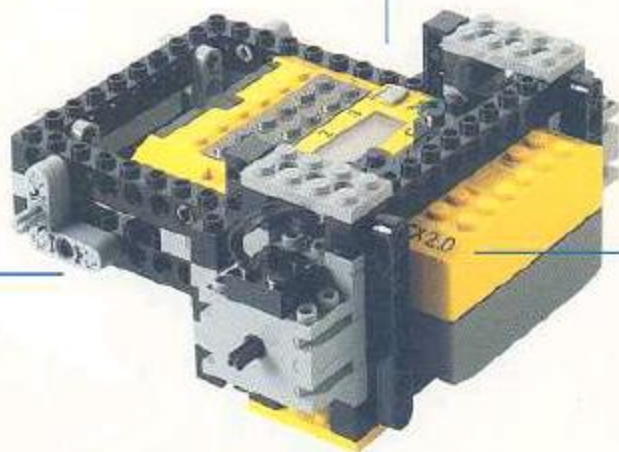

The Driving Base
page 38

The Driving Base, together with the RCX forms the Acrobot.

Note: For additional attachments, as well as design suggestions, go to **Special Features** on *page 92*.

The Light Sensor
page 55

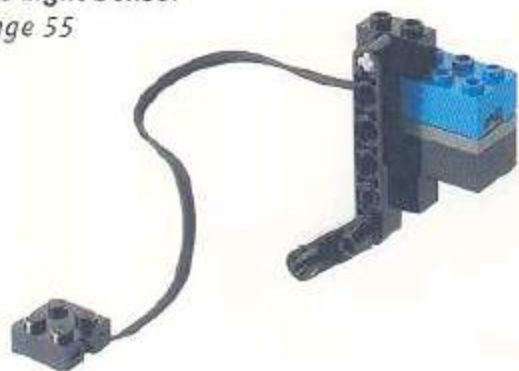

The Single Bumper
page 49

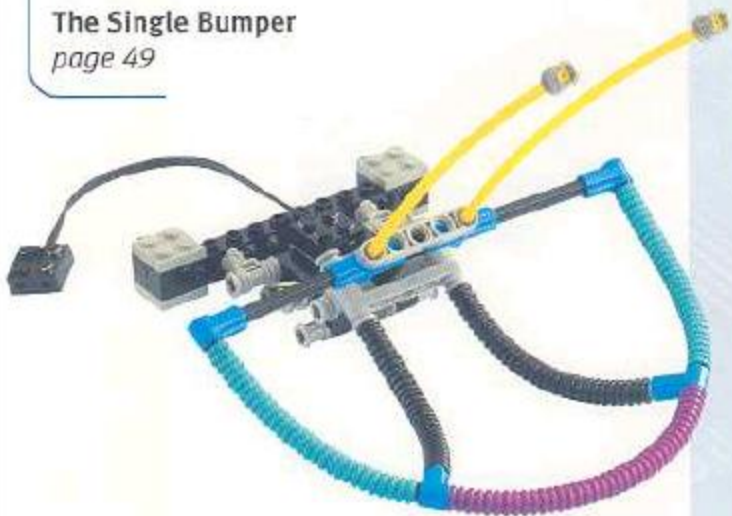

Examples of an Acrobot.



Driving Base

Check that your RCX has working batteries before starting.

1

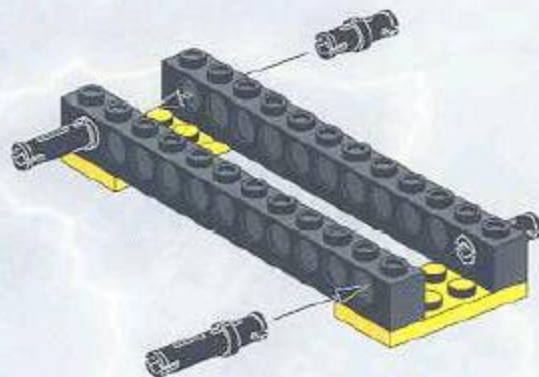

2

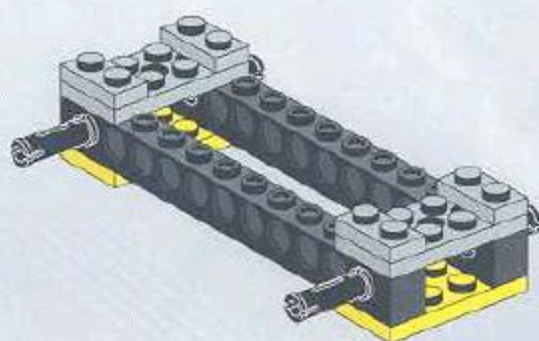

3

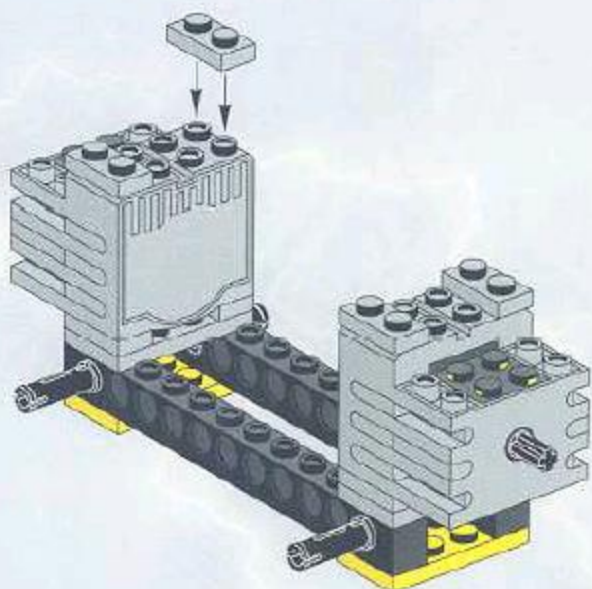
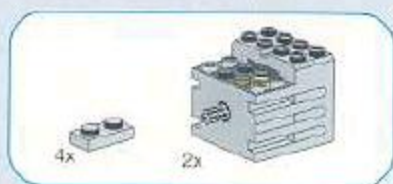

4

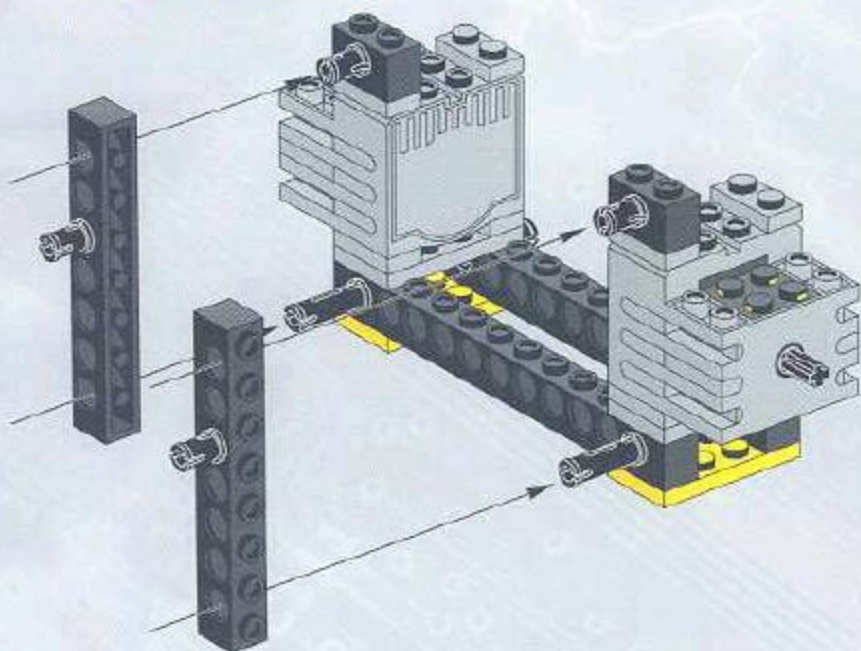



5



5.1



5.2

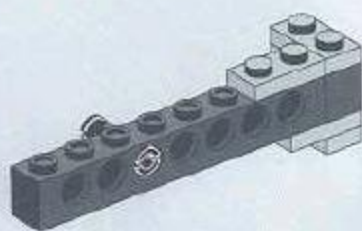

5.3

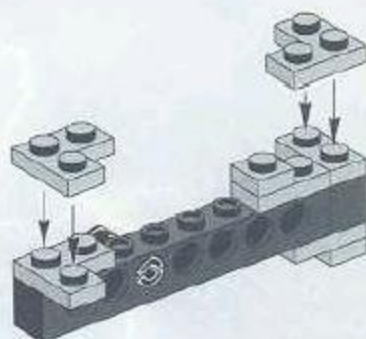

5.4

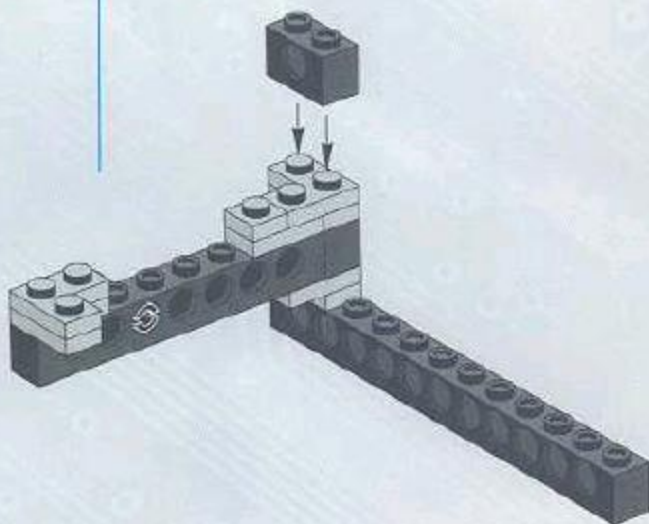



6



6.1

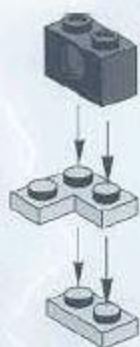

6.2

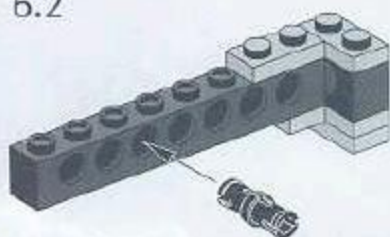

6.3

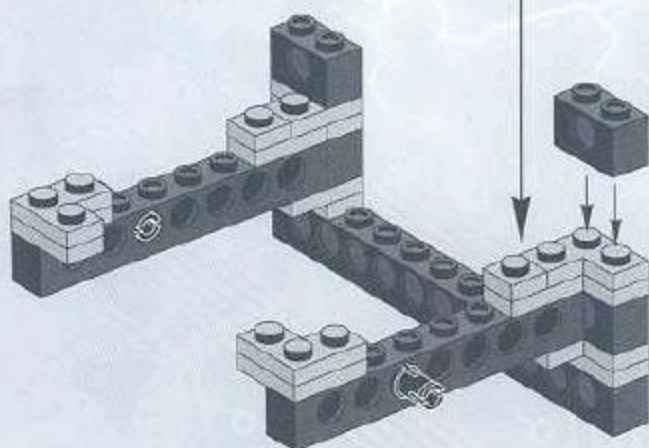
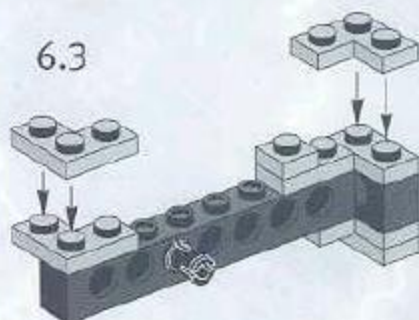



7

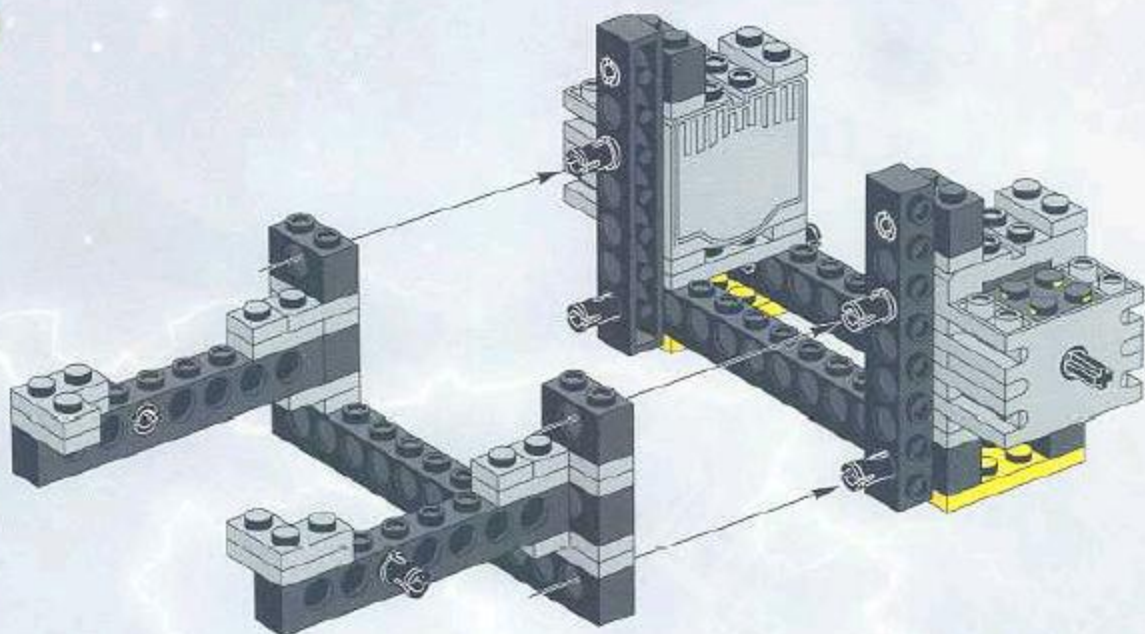

8

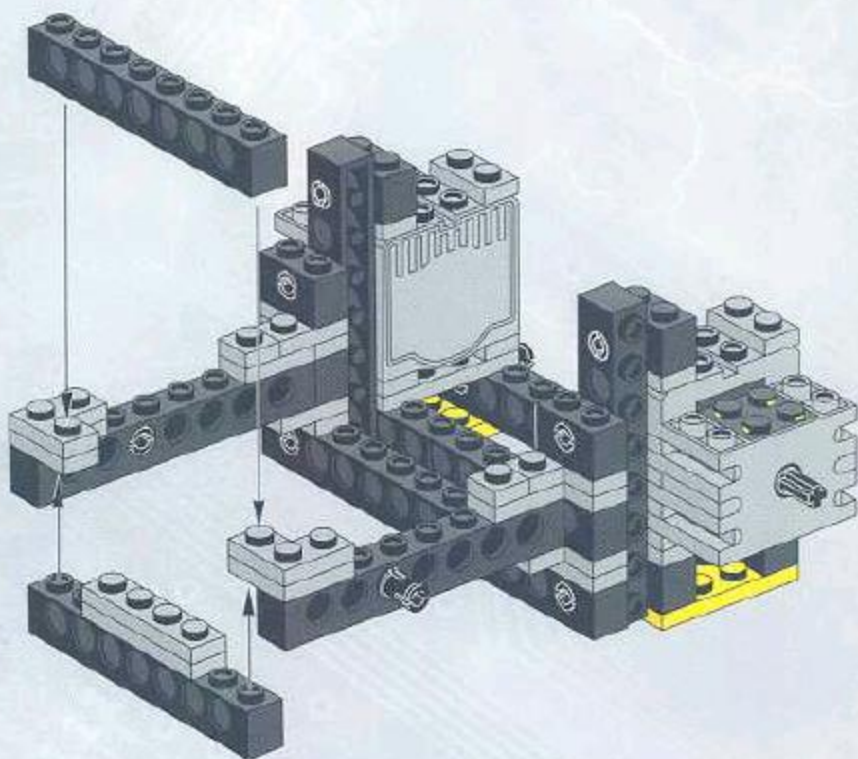



9

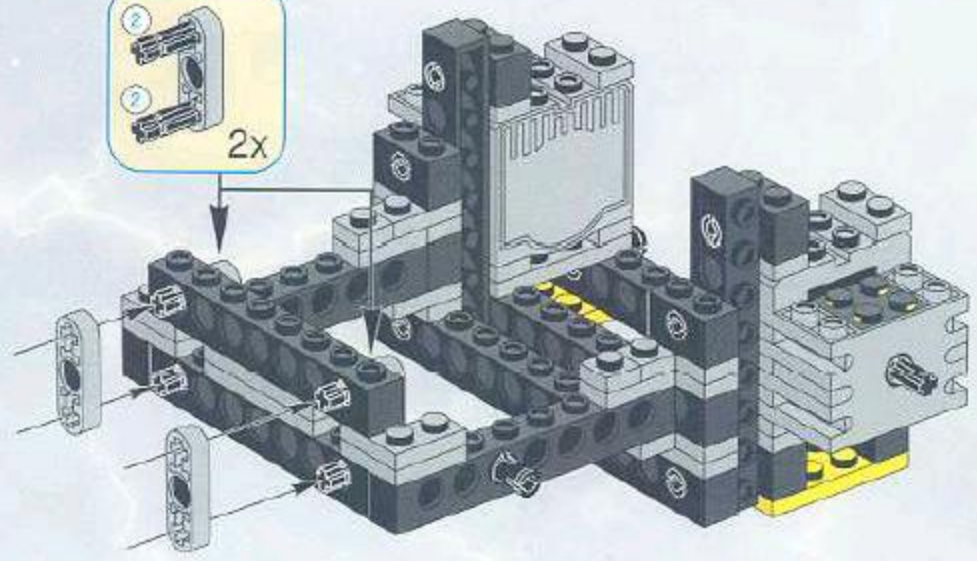

10

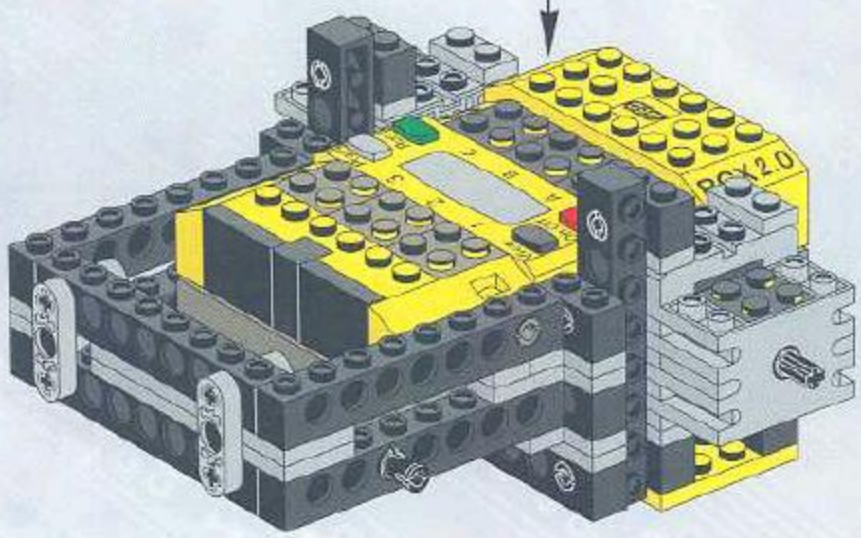
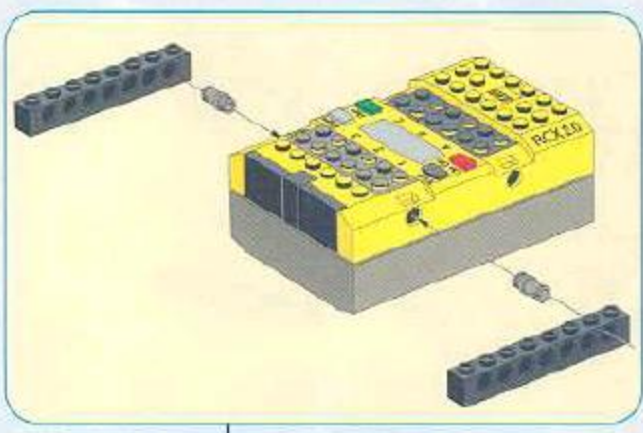
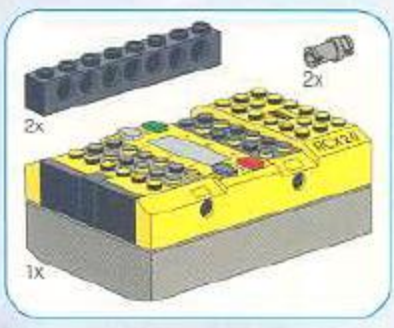

11

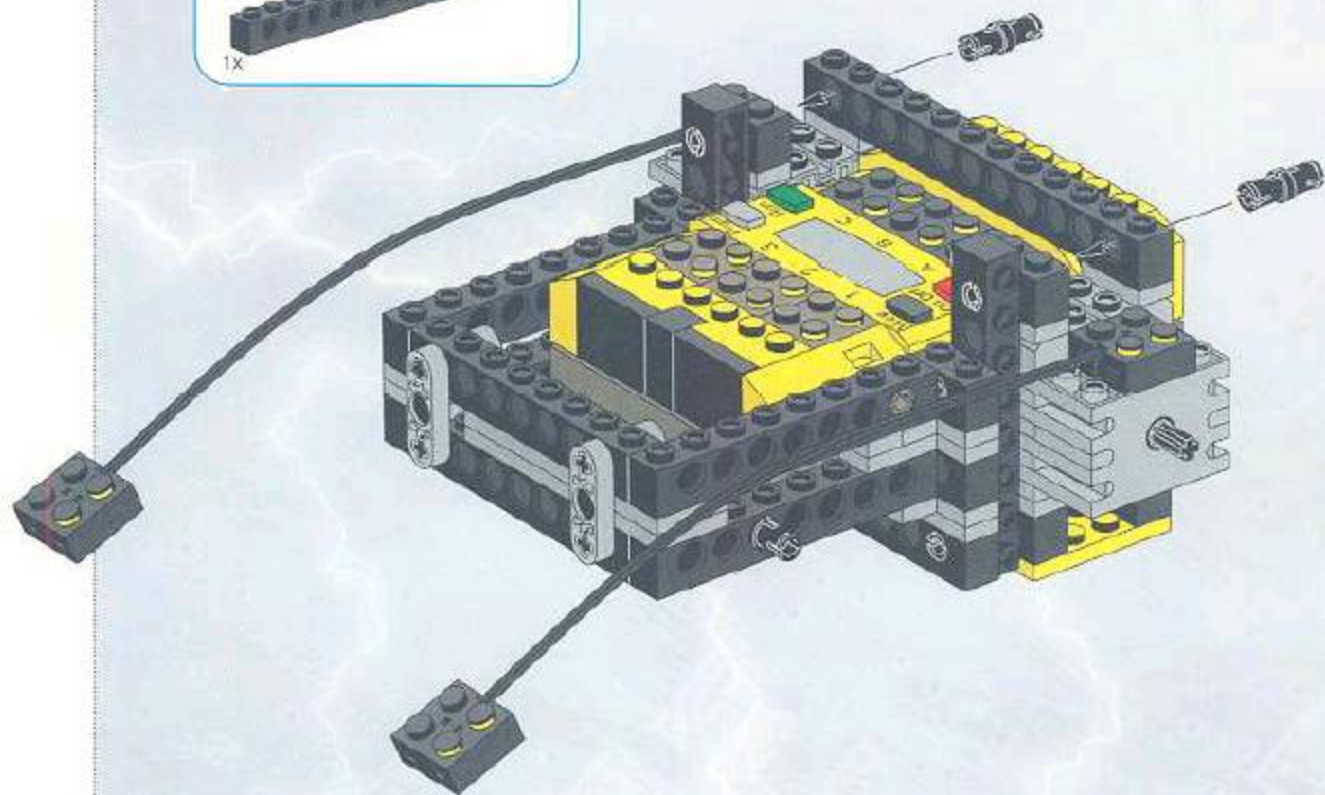

12

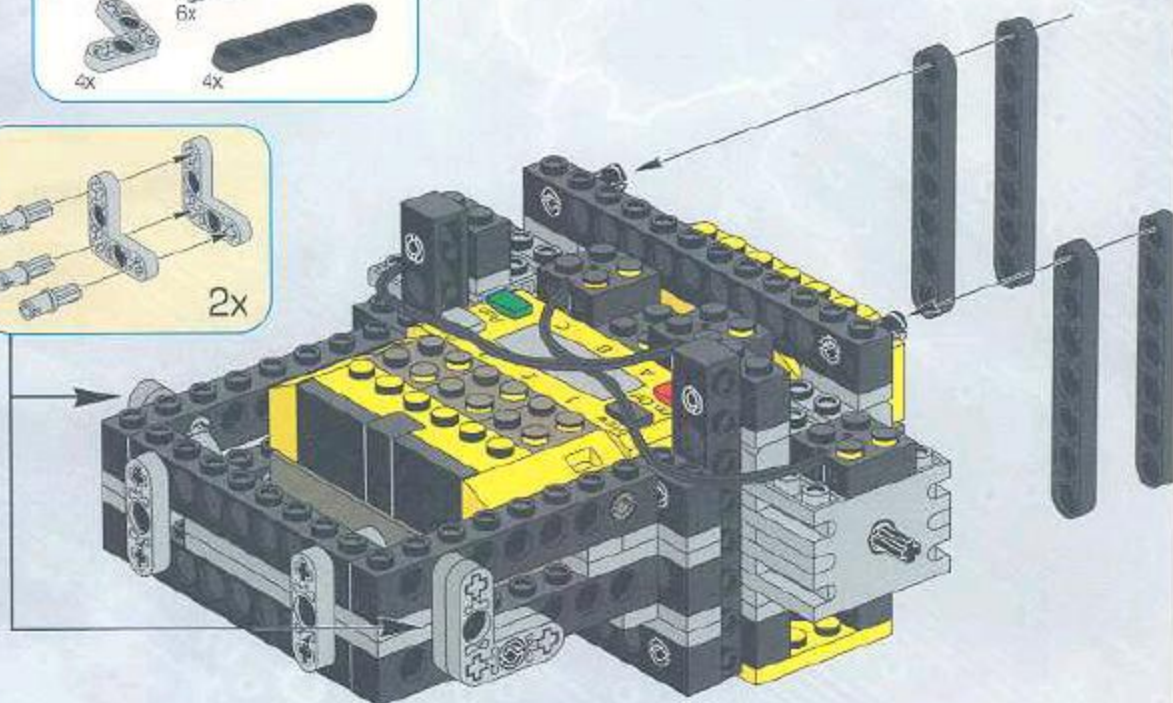
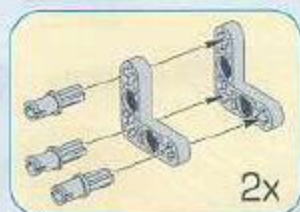

13

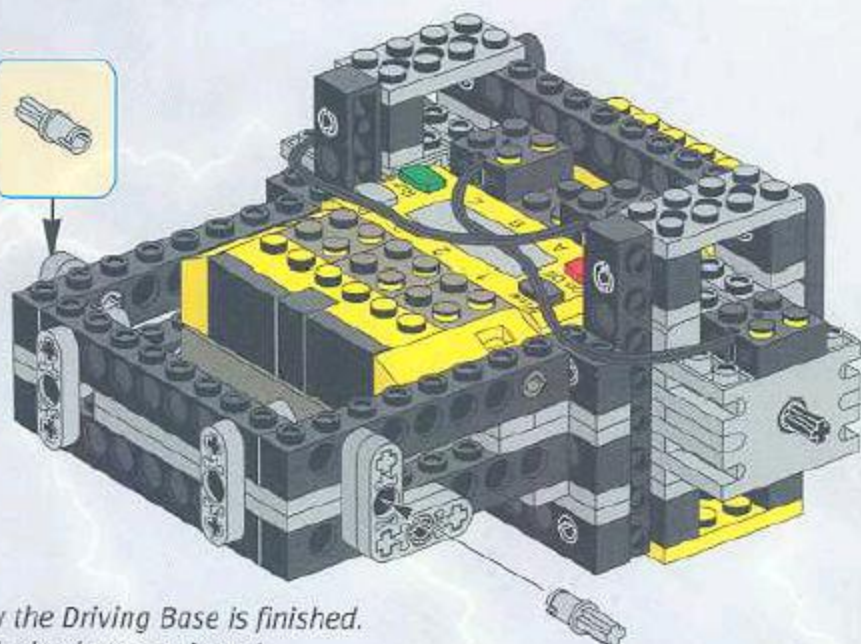

Now the Driving Base is finished.
Add wheels to see it run!

1

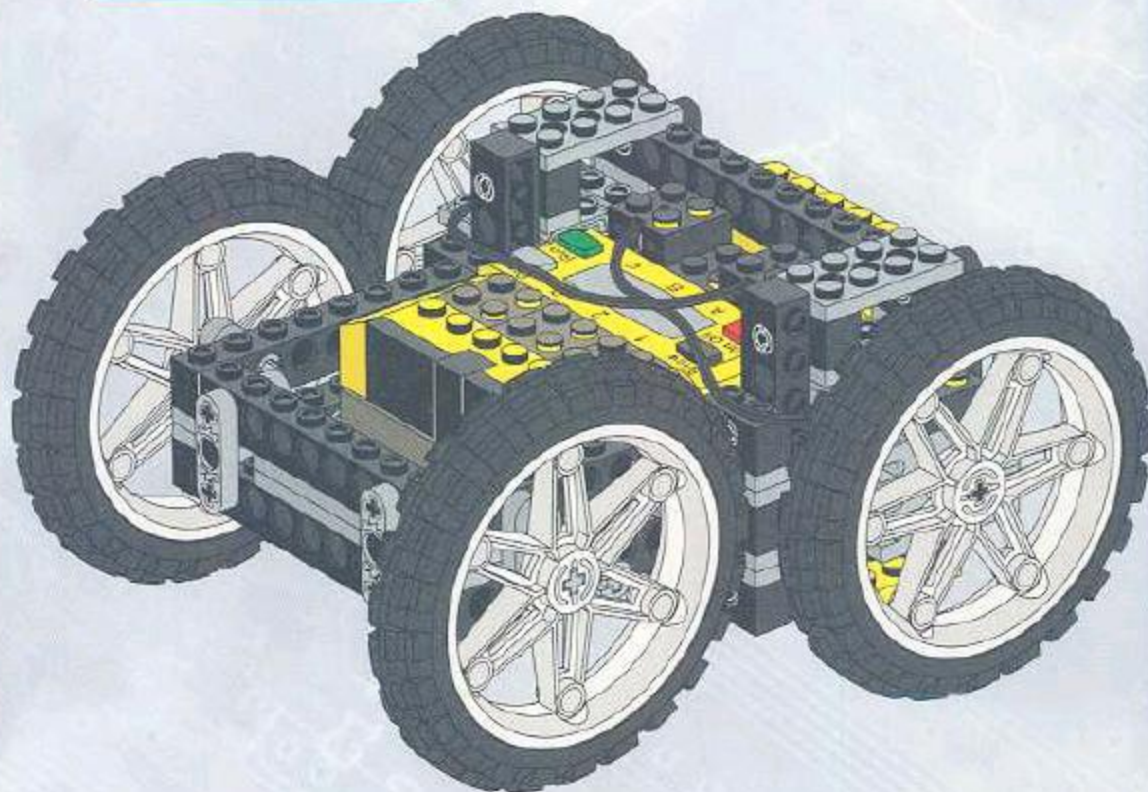
**Big Wheels**

Pivot Wheel



1

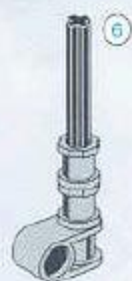
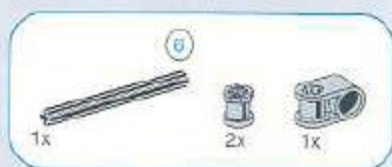

2

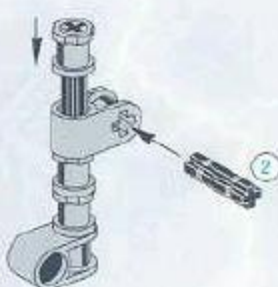

3

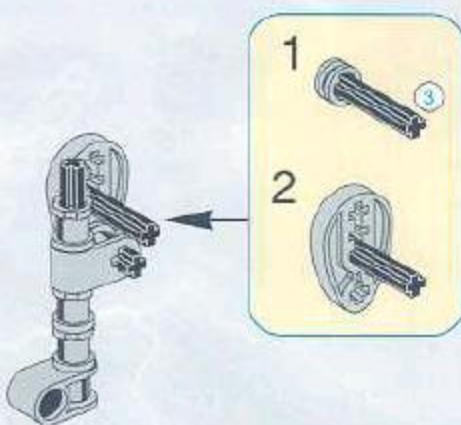

4

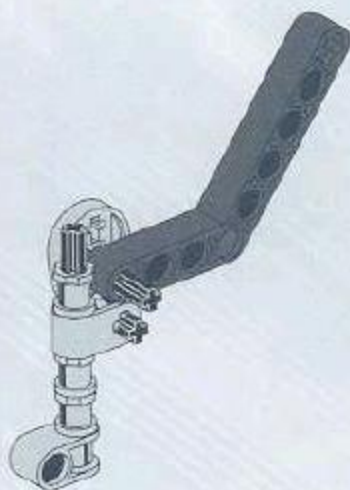

5

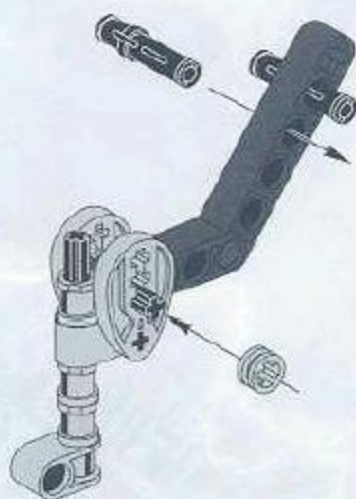

6

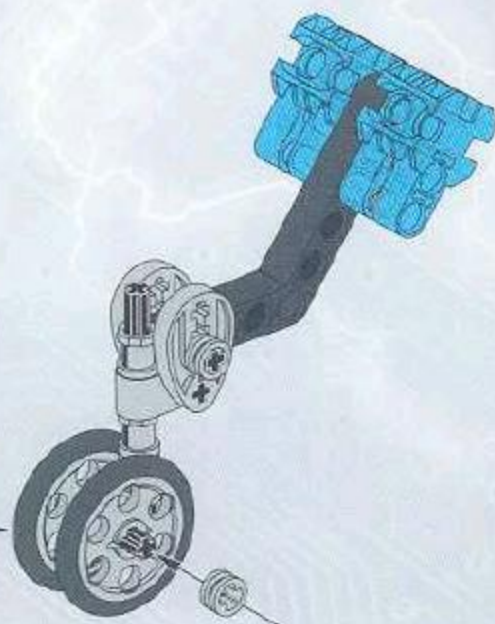
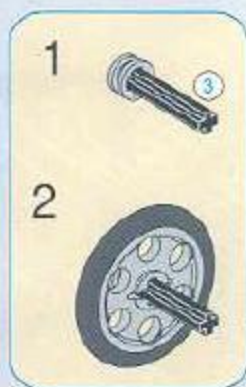
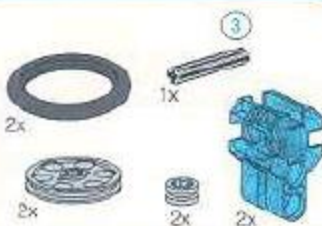

5

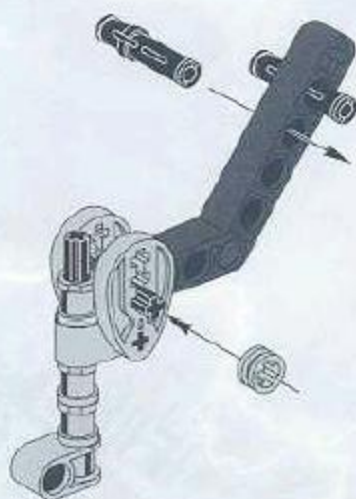

6

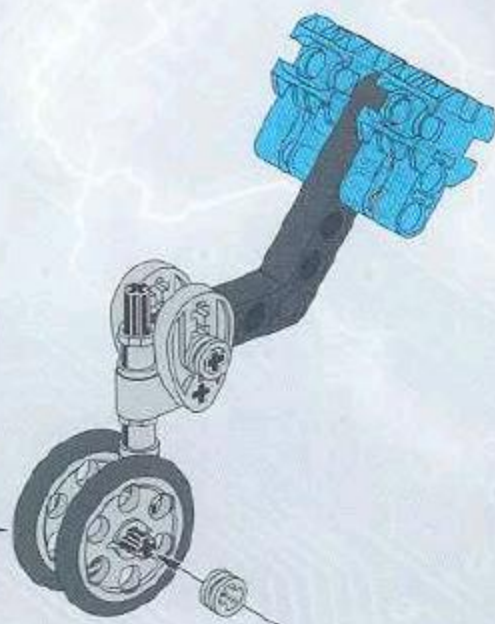
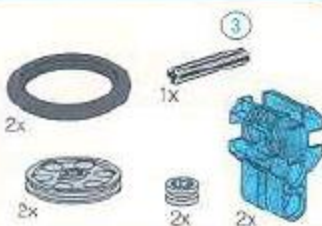

Single Bumper

1

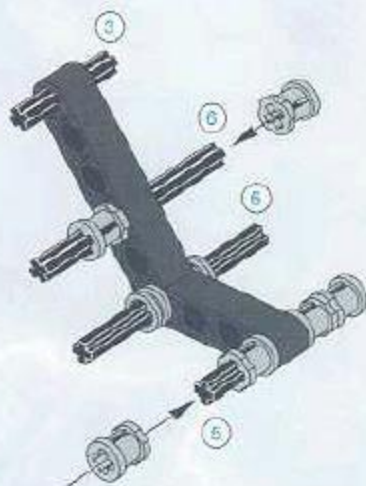
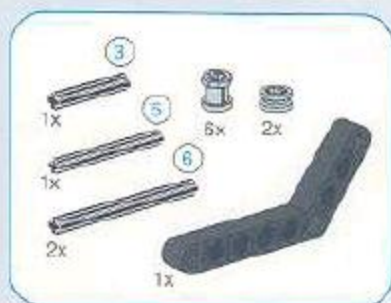

2

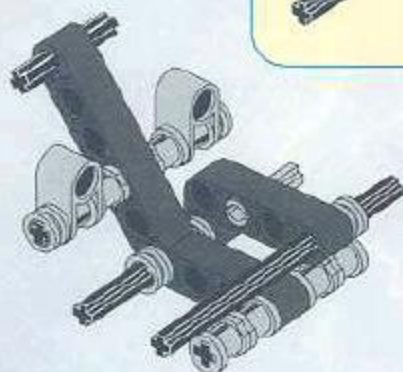
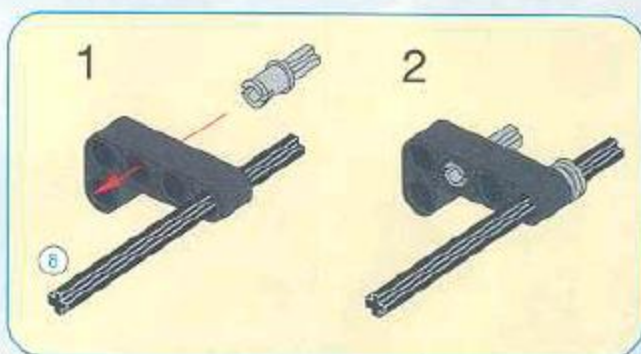
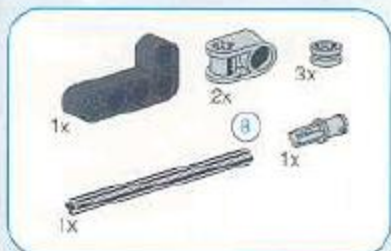

3

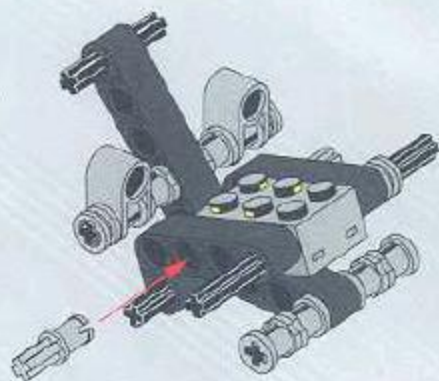



4

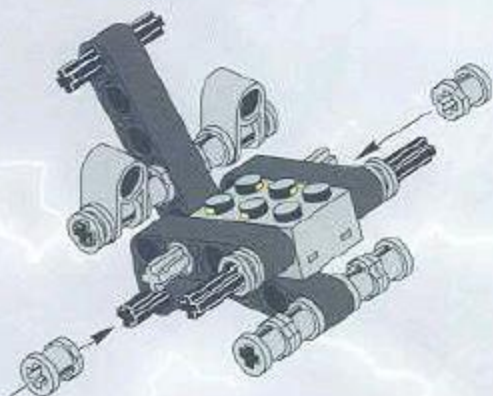

5

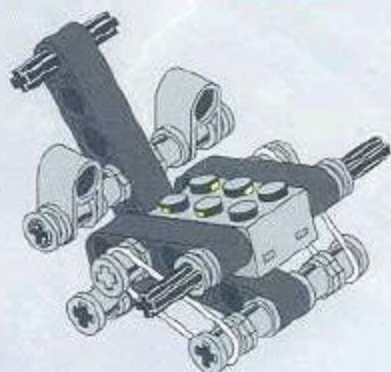

6

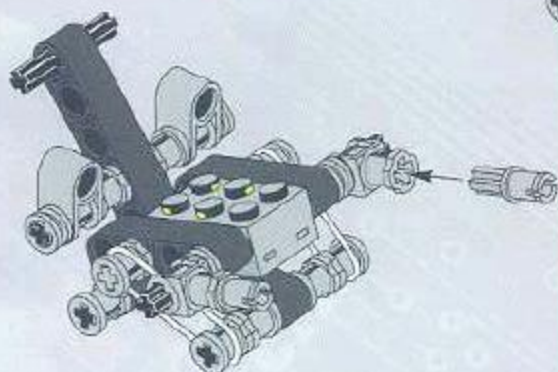

7

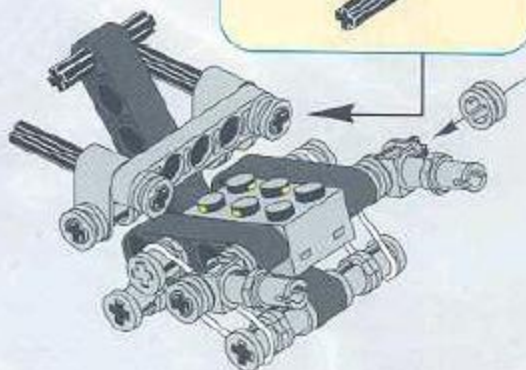
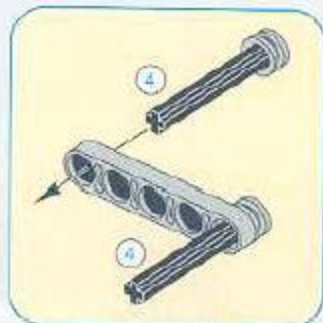
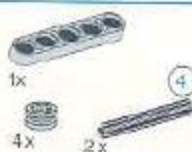

8

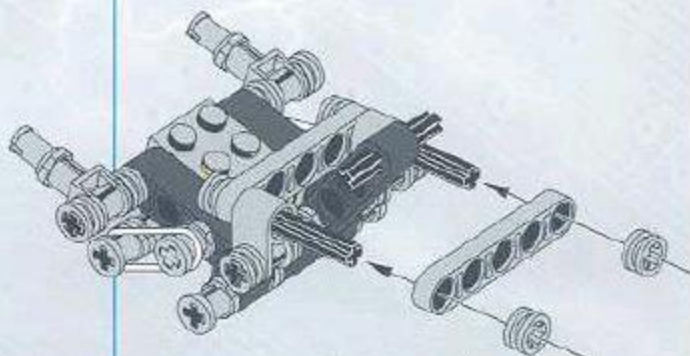

9

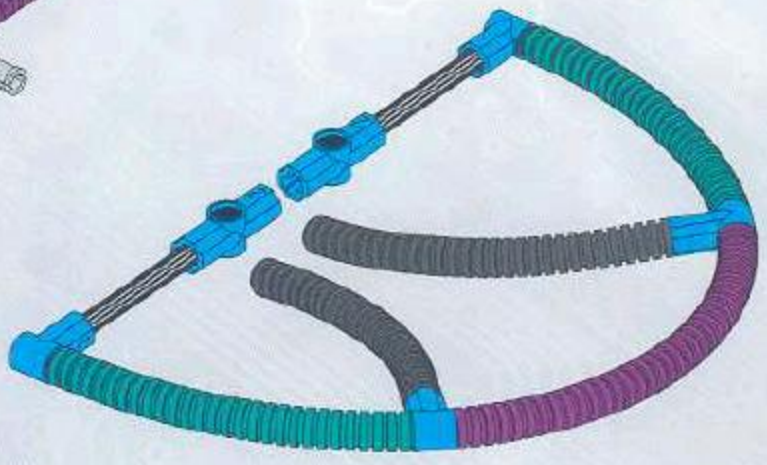
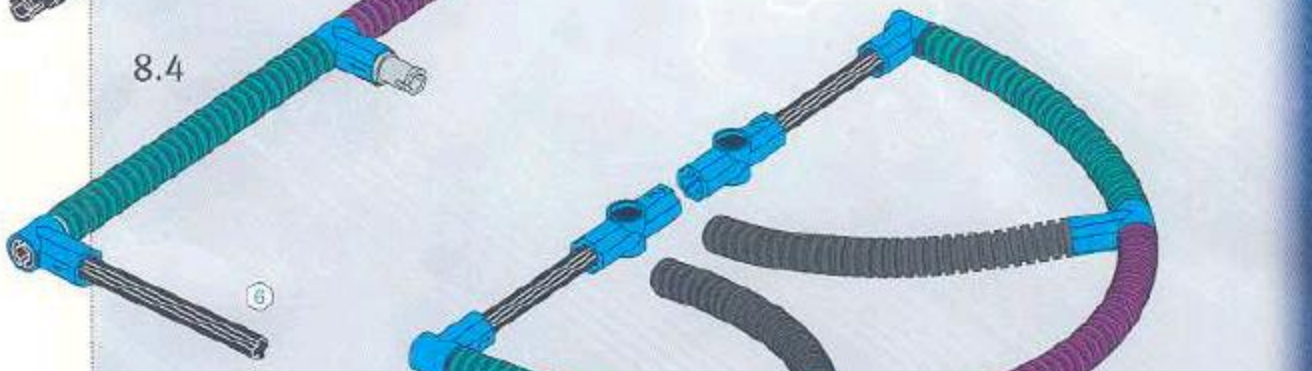
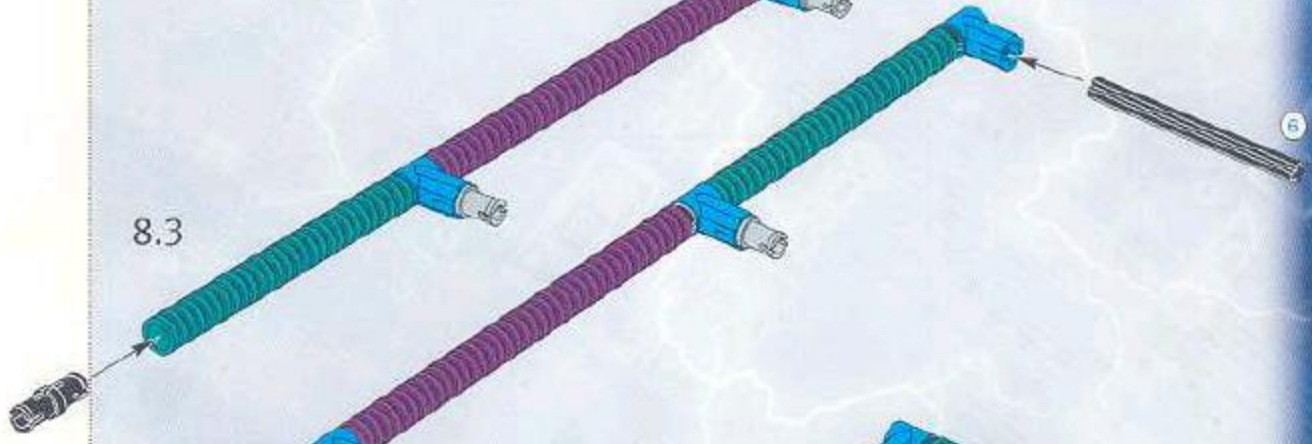

6

6

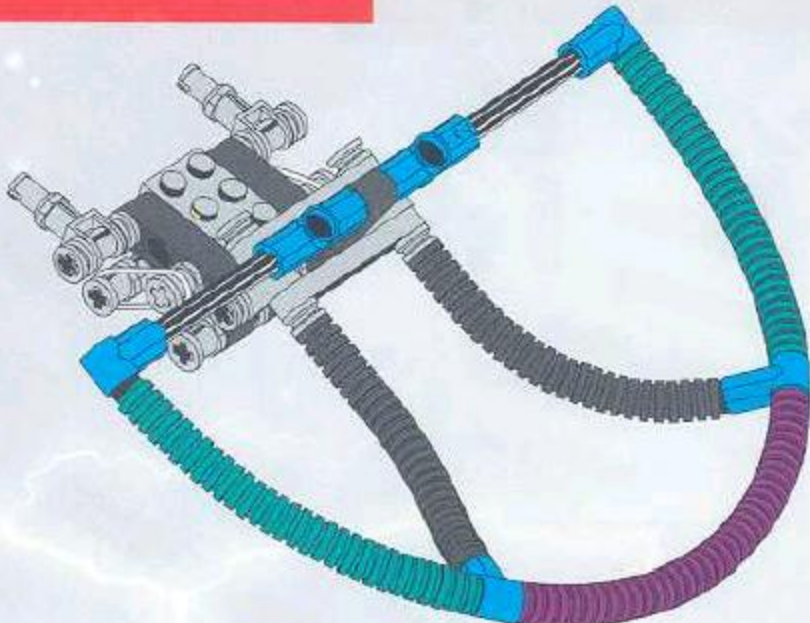

10

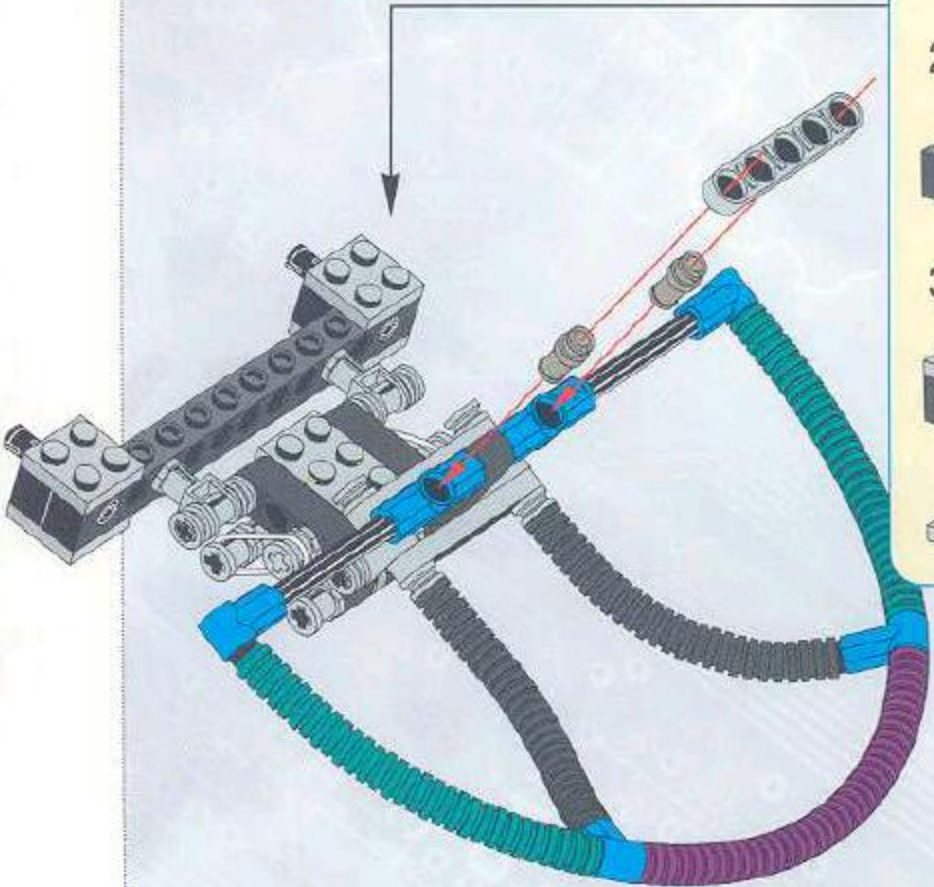
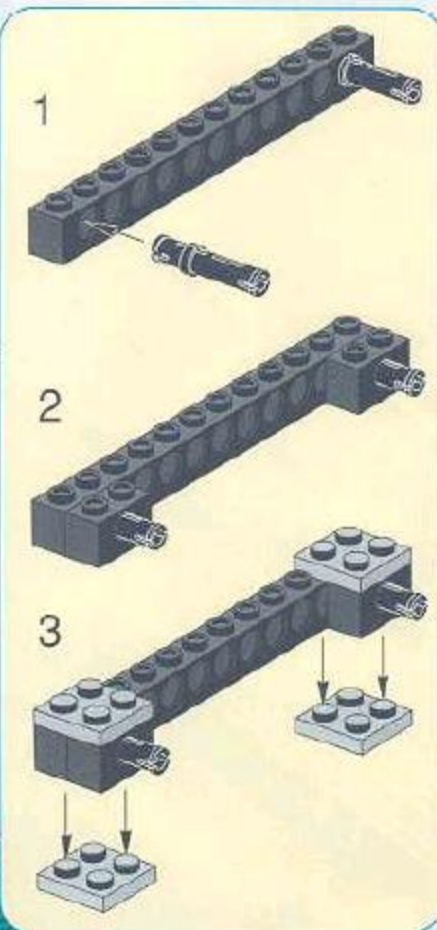
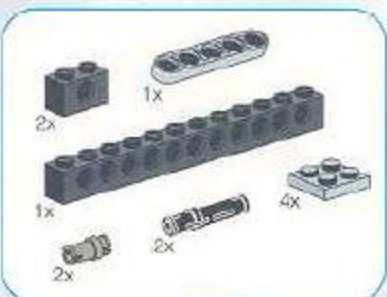

11

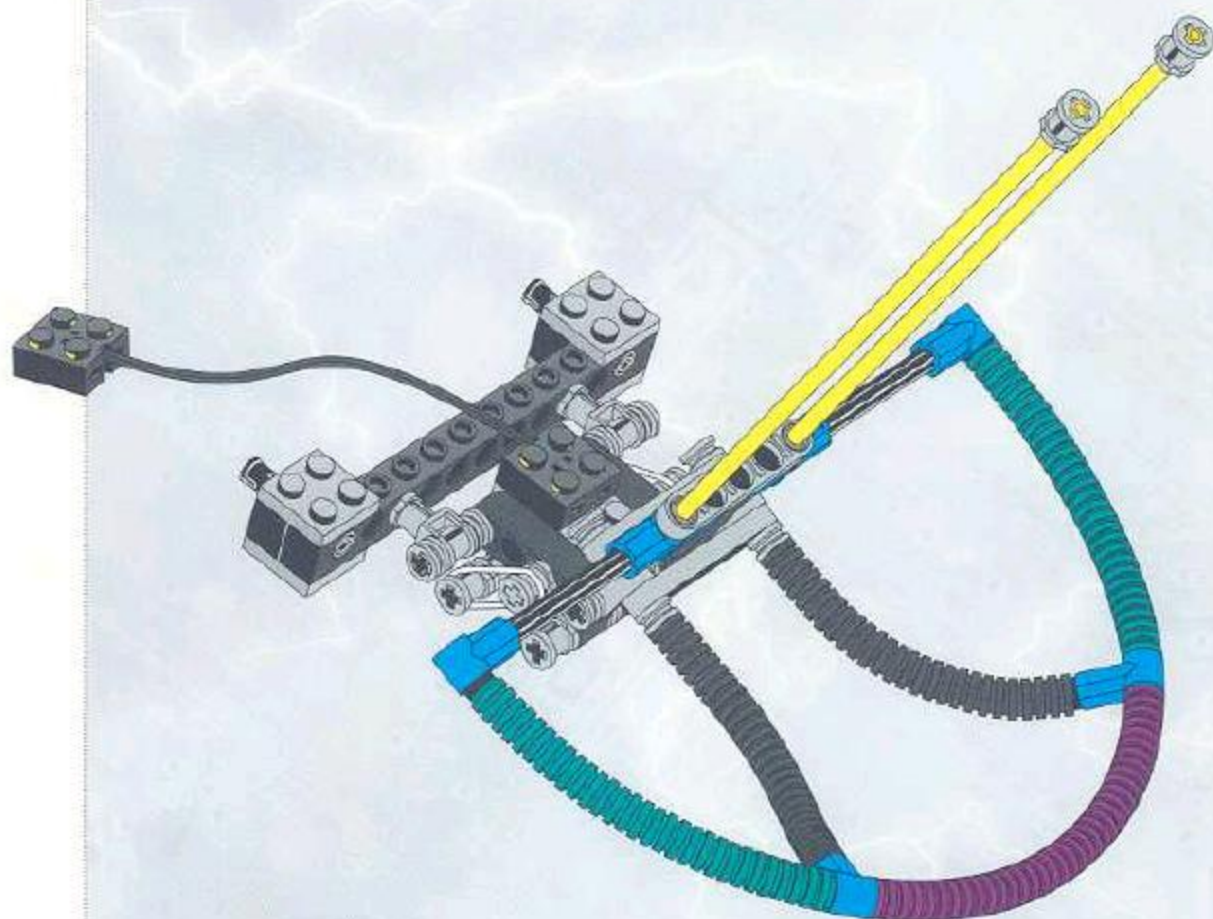
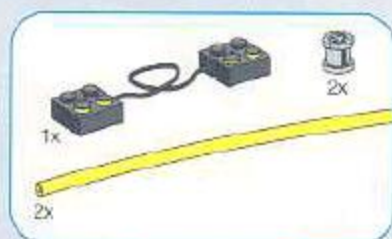



12

Attach the Single Bumper to the Driving Base like this.

If you have not yet built the Driving Base, go to page 38.

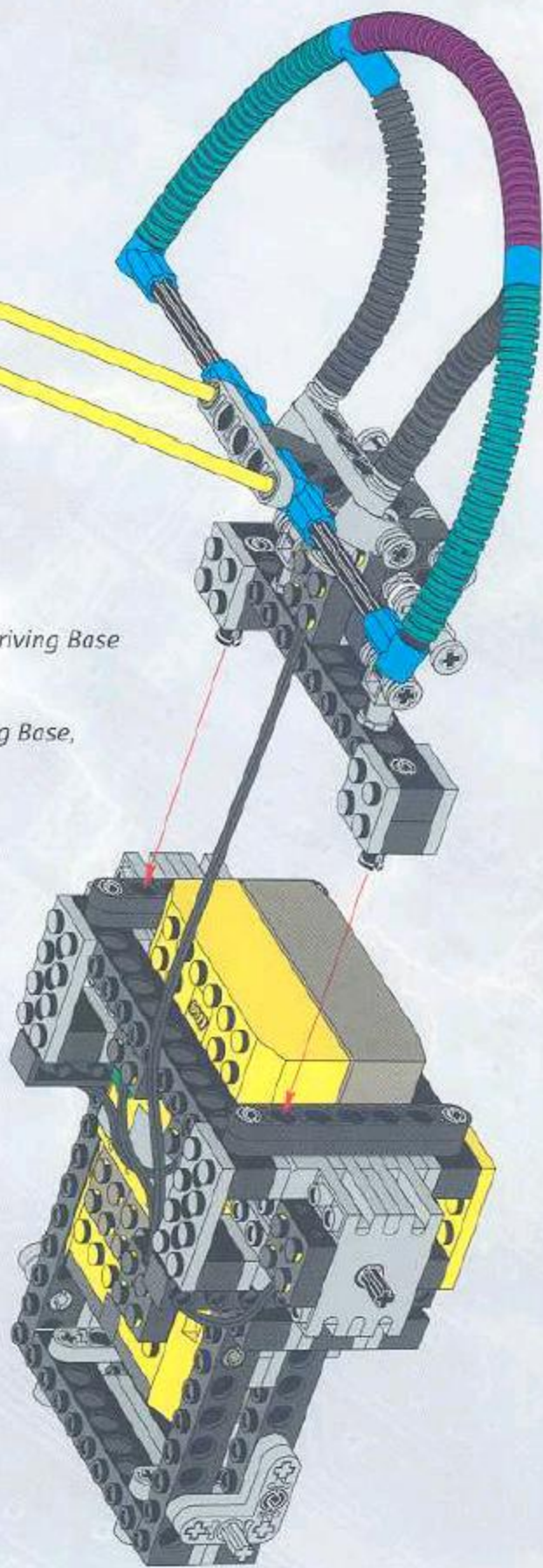

Light Sensor

1

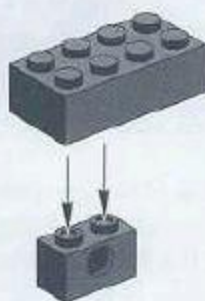

2

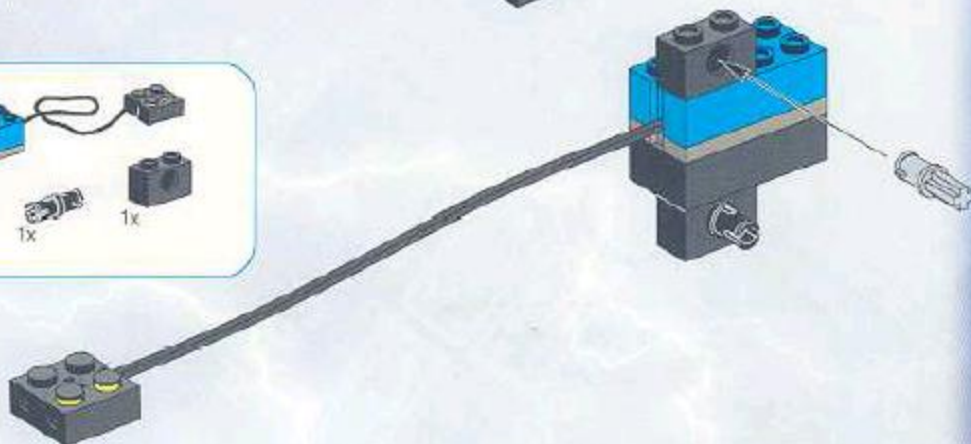
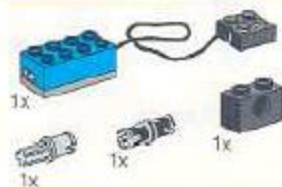

3



4

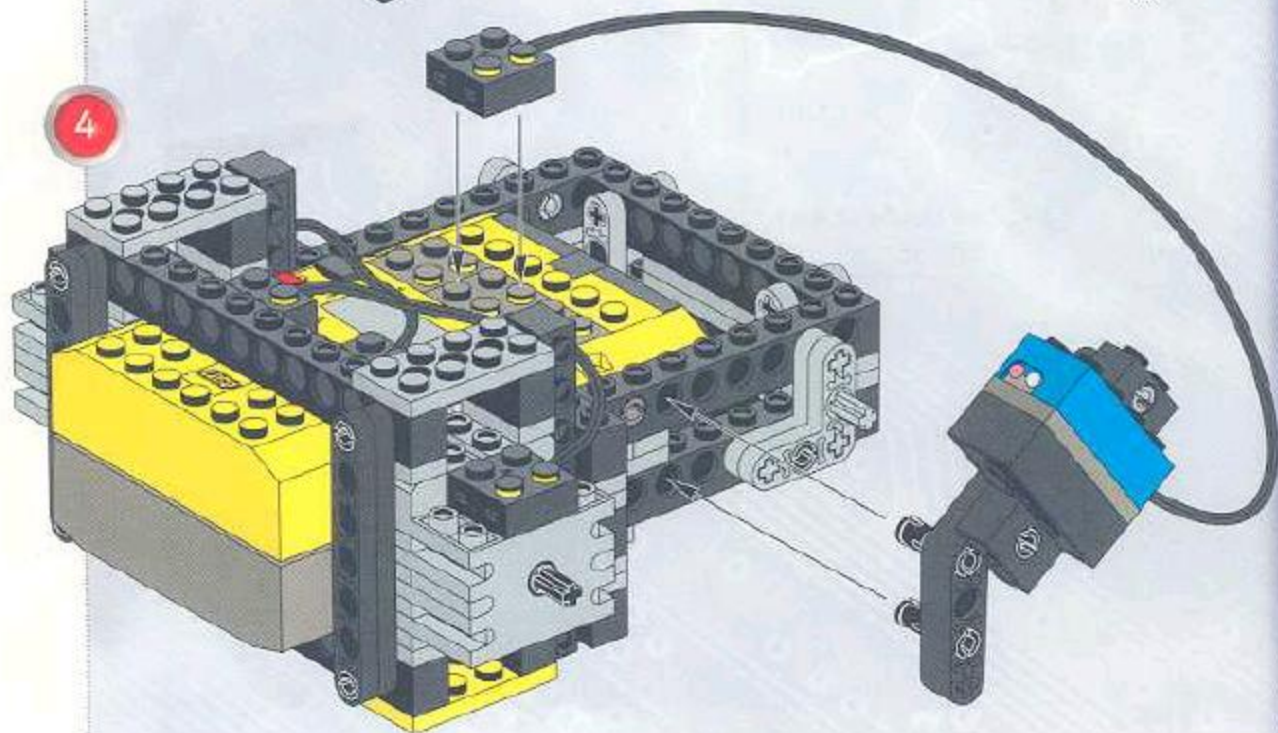



INVENTORBOT SECTION

Here is an overview of the Inventorbot.

The following pages show building instructions for each part.

Start by building the Body and the Standing Base, then choose which attachments you want to add.



The Slap Arm
page 78



The Squeeze Arm
page 81



The Head page 70



The Body
page 58



The Standing Base
page 64

The Body, the Standing Base, and the Head fit together to form the Inventorbot.

Note: For additional attachments, as well as design suggestions, go to **Special Features** on page 96.

The Light Sensor
page 86



The Hat Arm
page 74



The Thrower Arm
page 84



Examples of an Inventorbot.

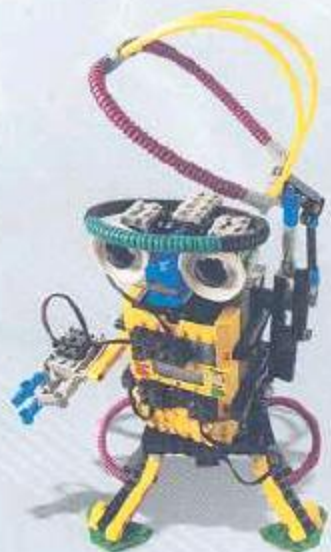



Body

Check that your RCX has working batteries before starting.

1



2

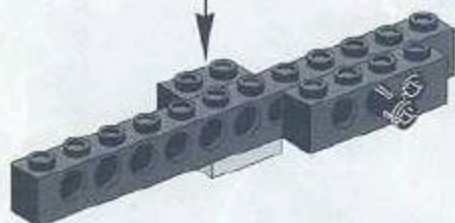
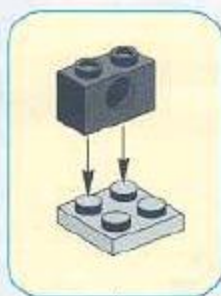

3

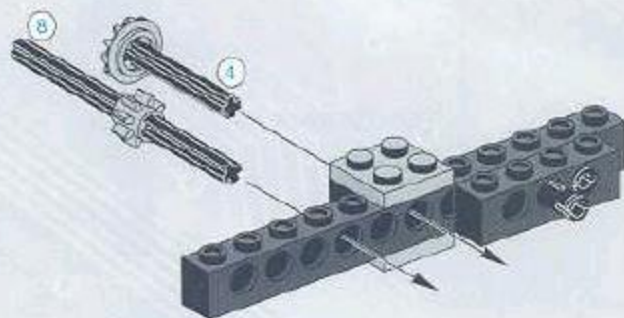
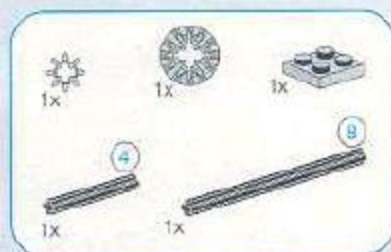



4

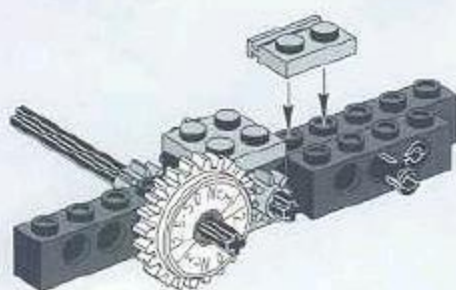

5

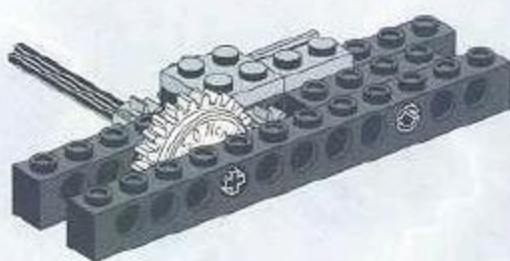

6

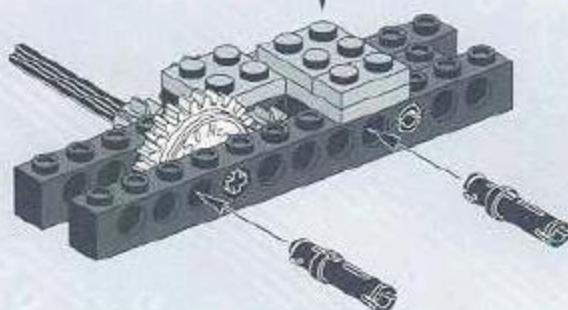
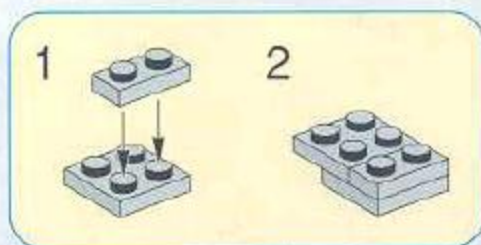



9

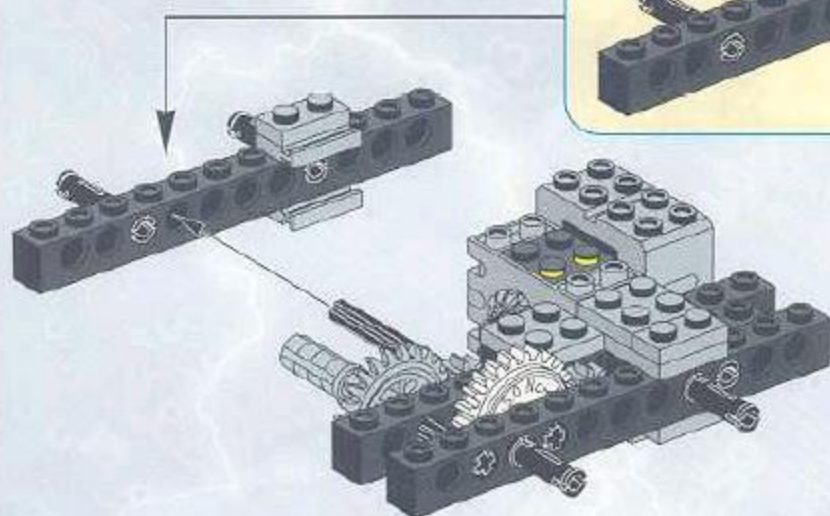
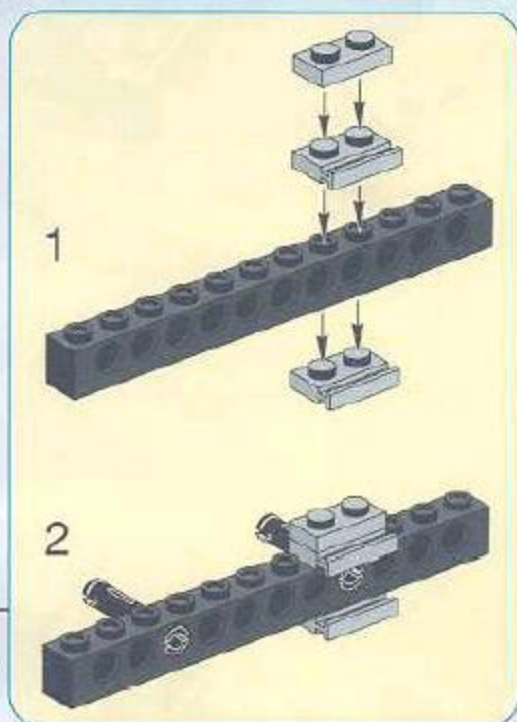

10

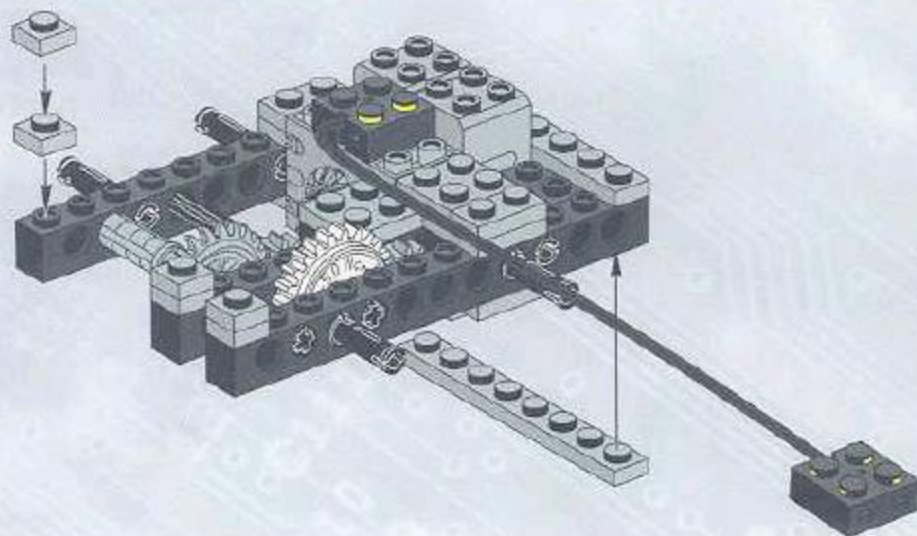
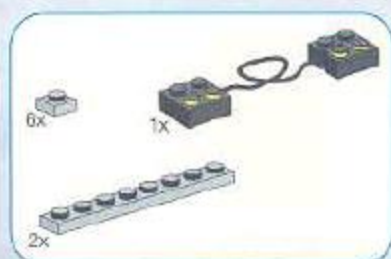



11

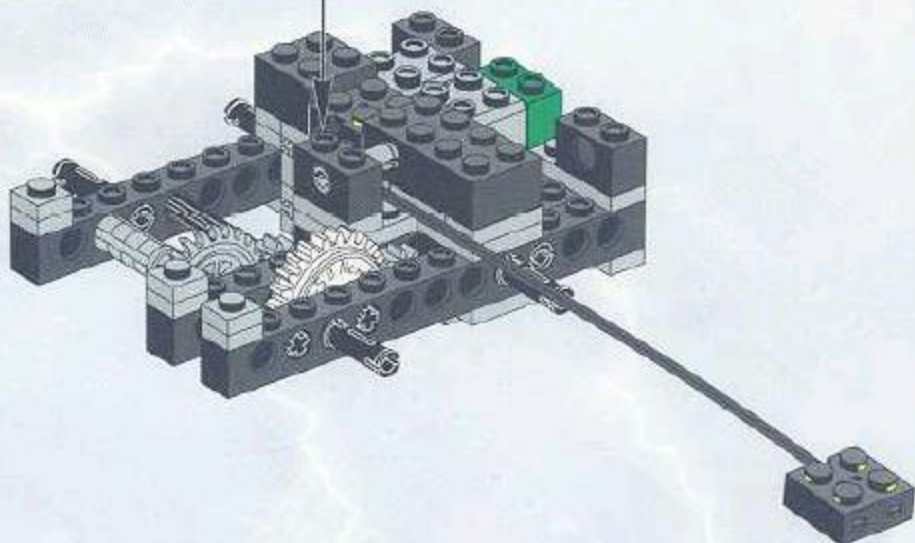
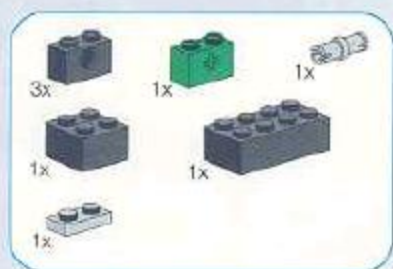

12

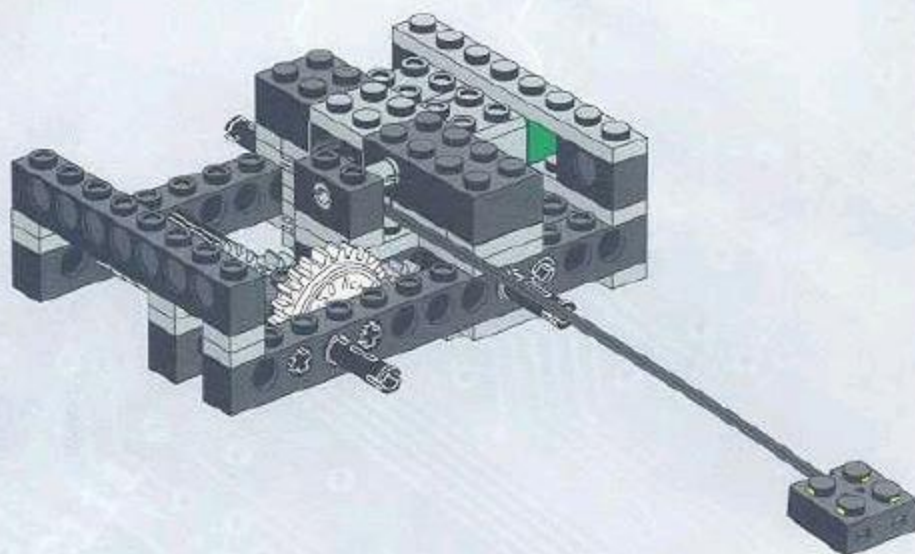

13

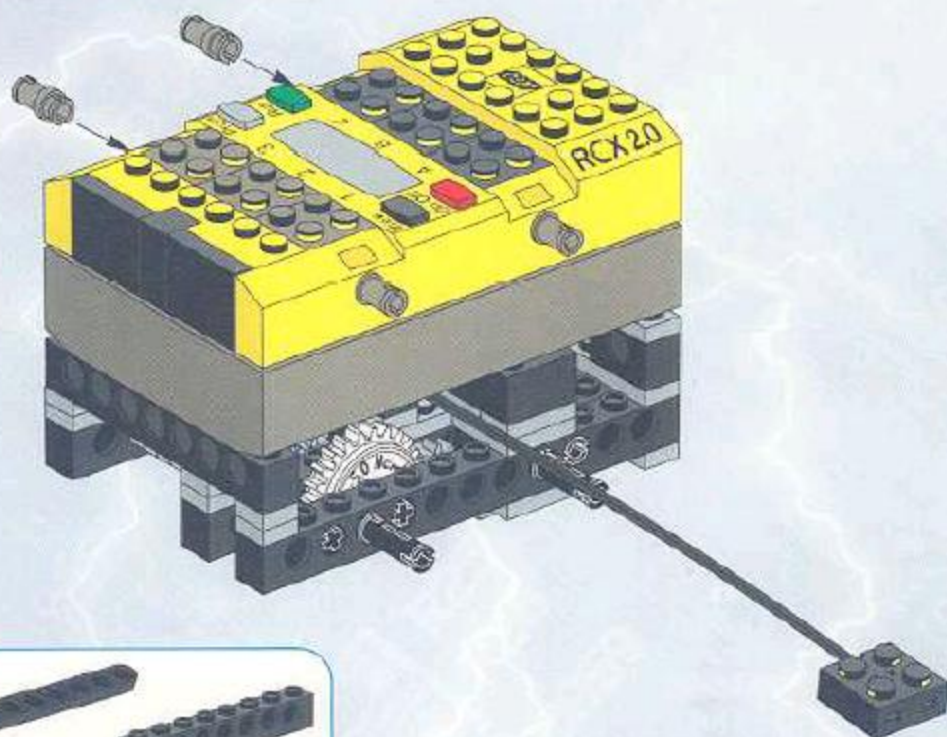
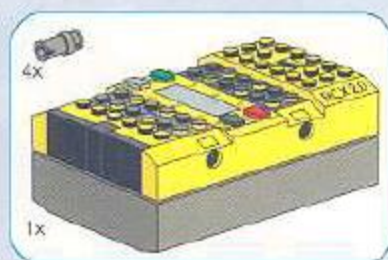

14

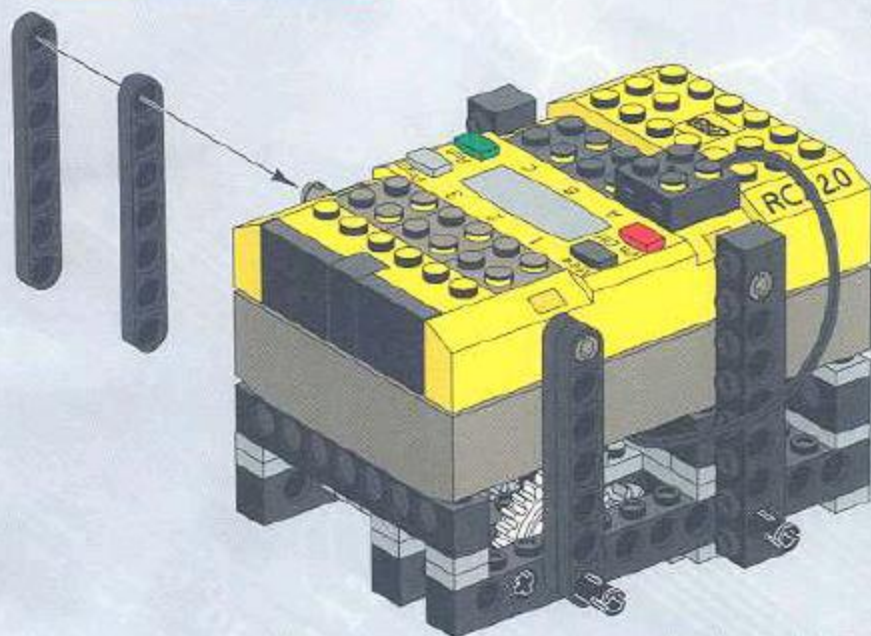

Now the Body for your Inventorbot is finished.

Standing Base

1

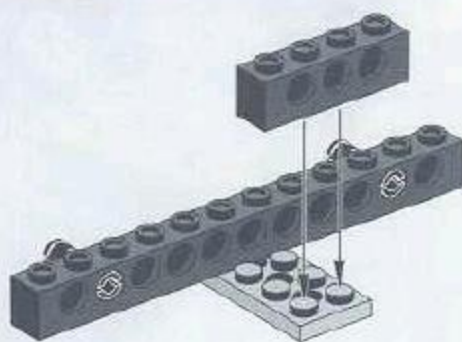
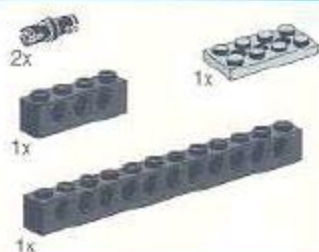

2

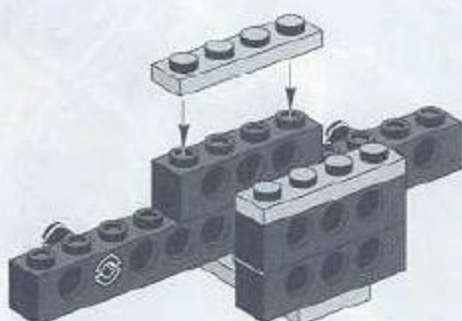

3

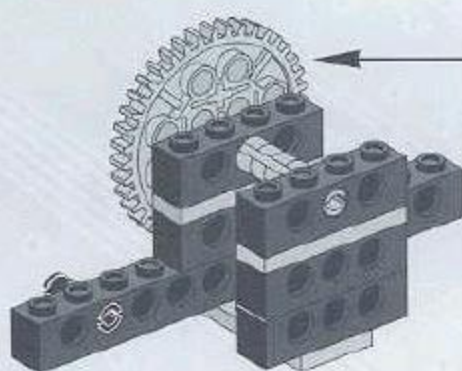
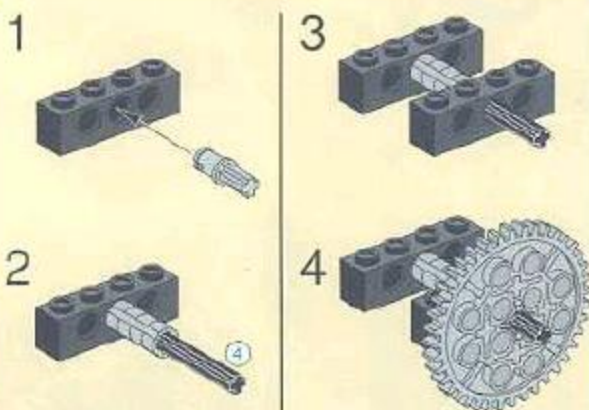
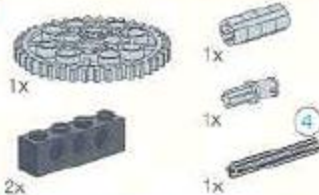

4

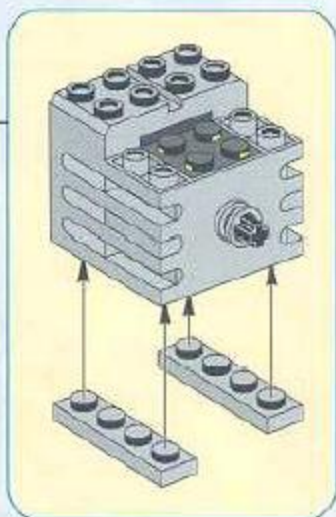
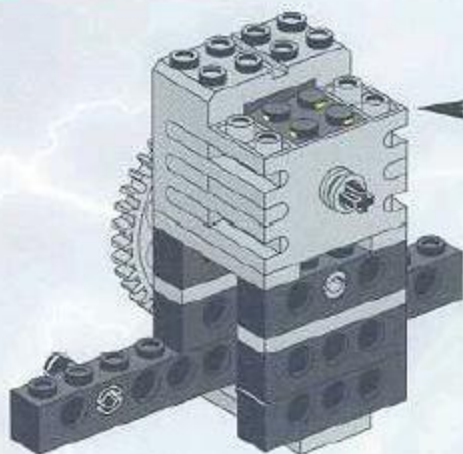
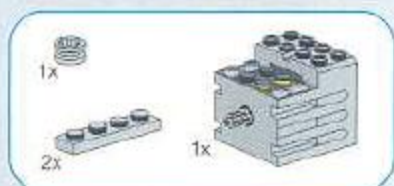

5

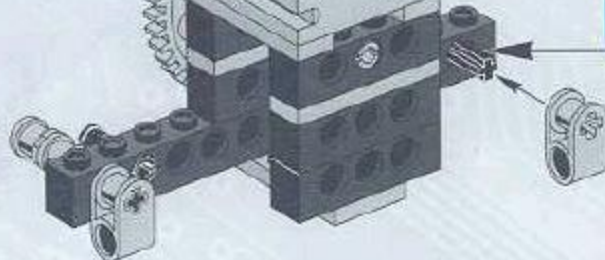
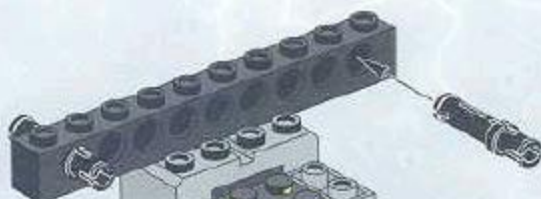

6

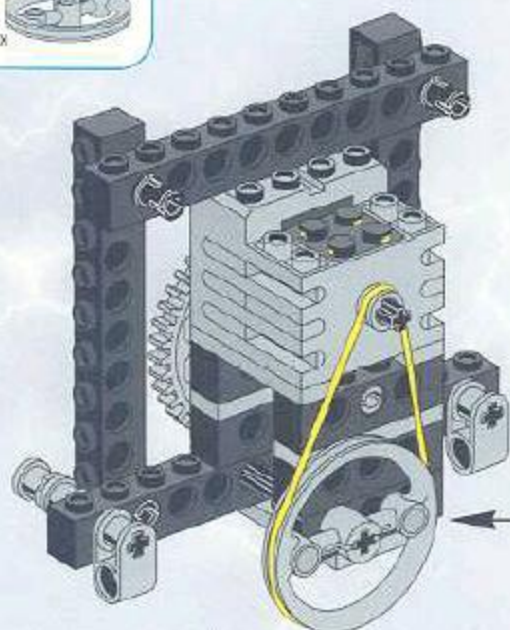
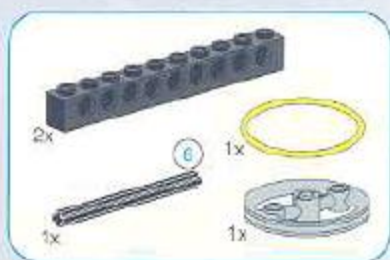

7

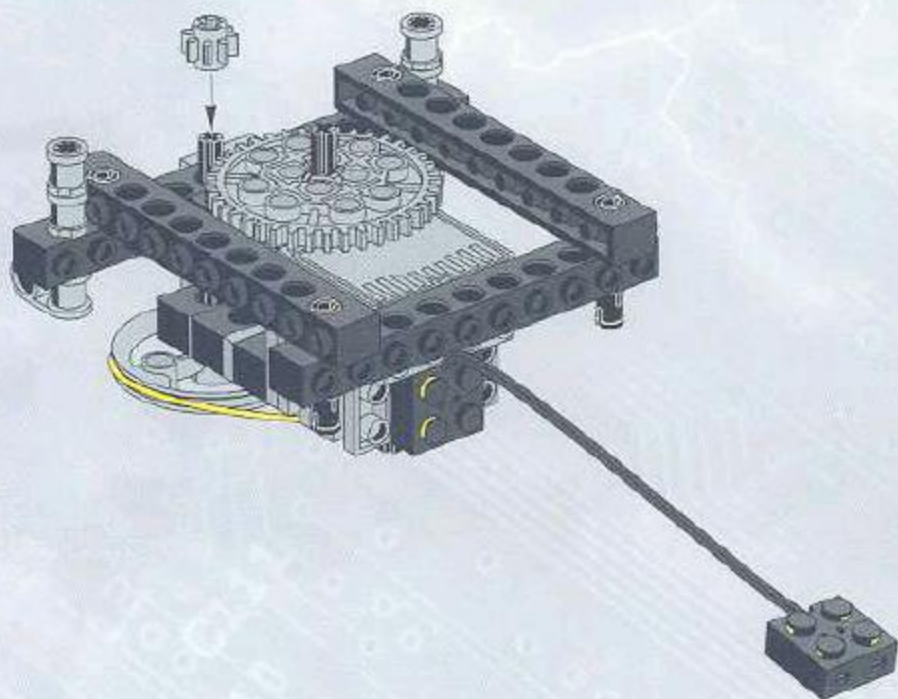

1

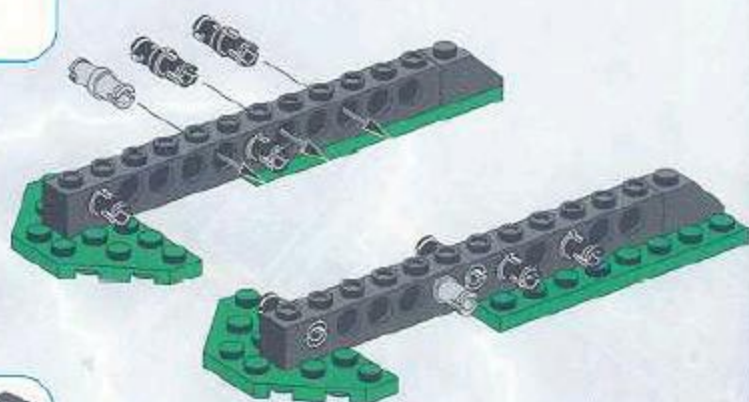
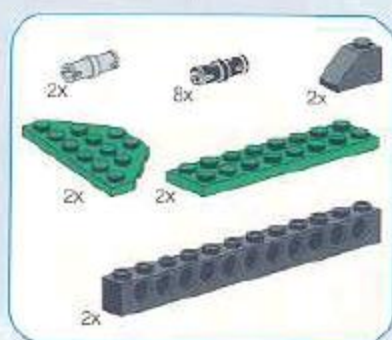

2

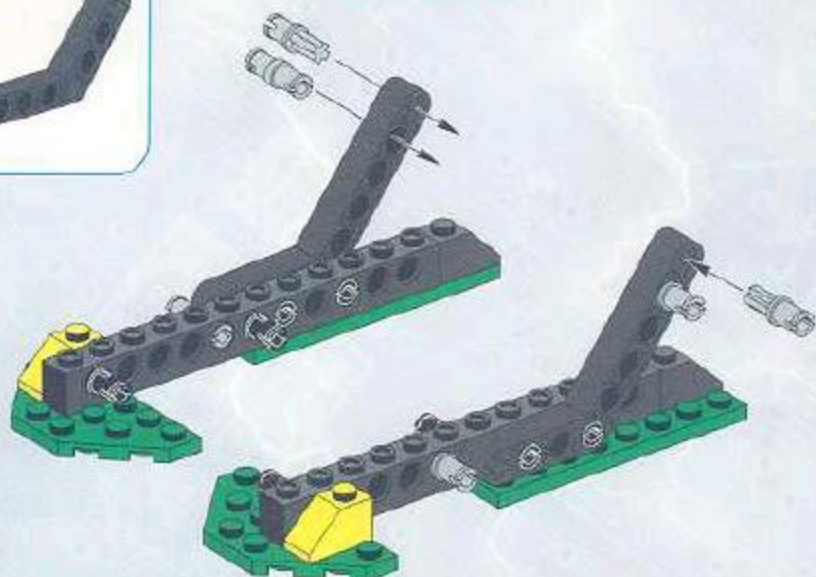

3

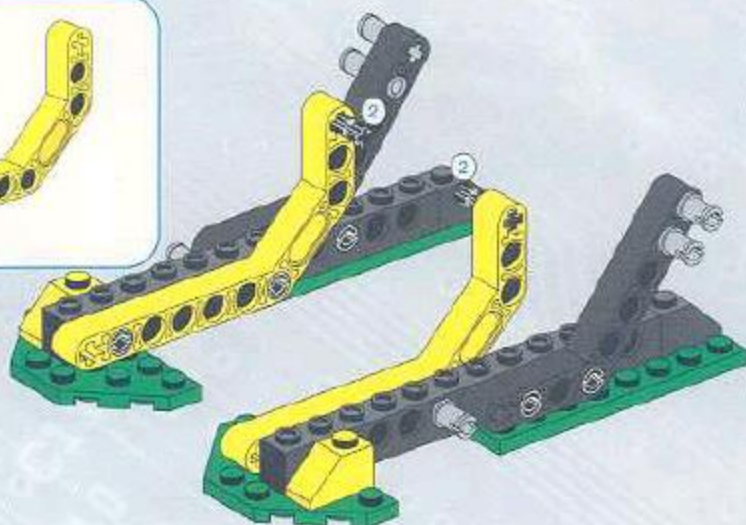
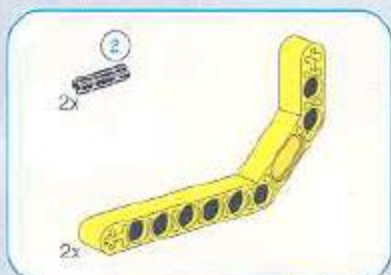



4

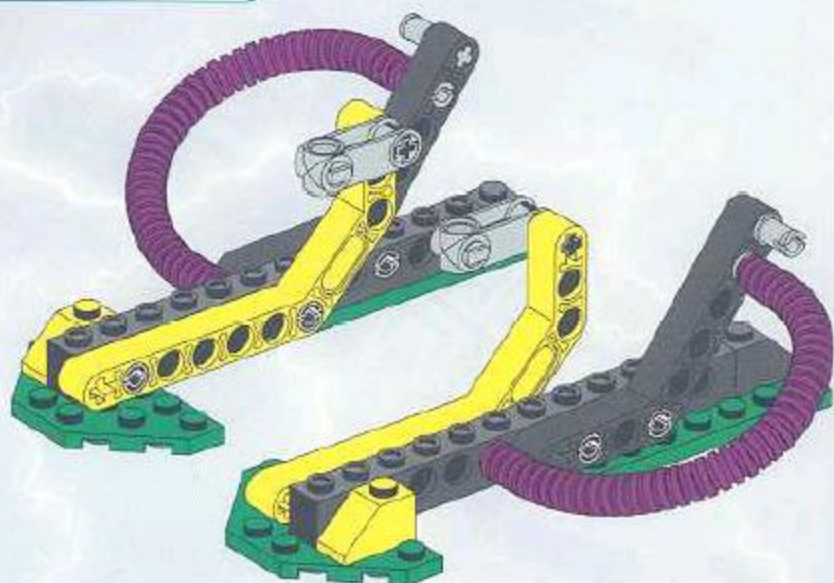
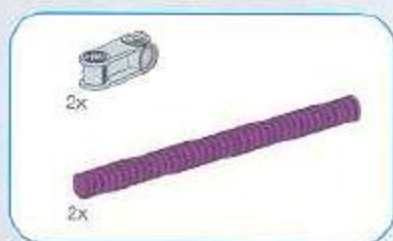

5

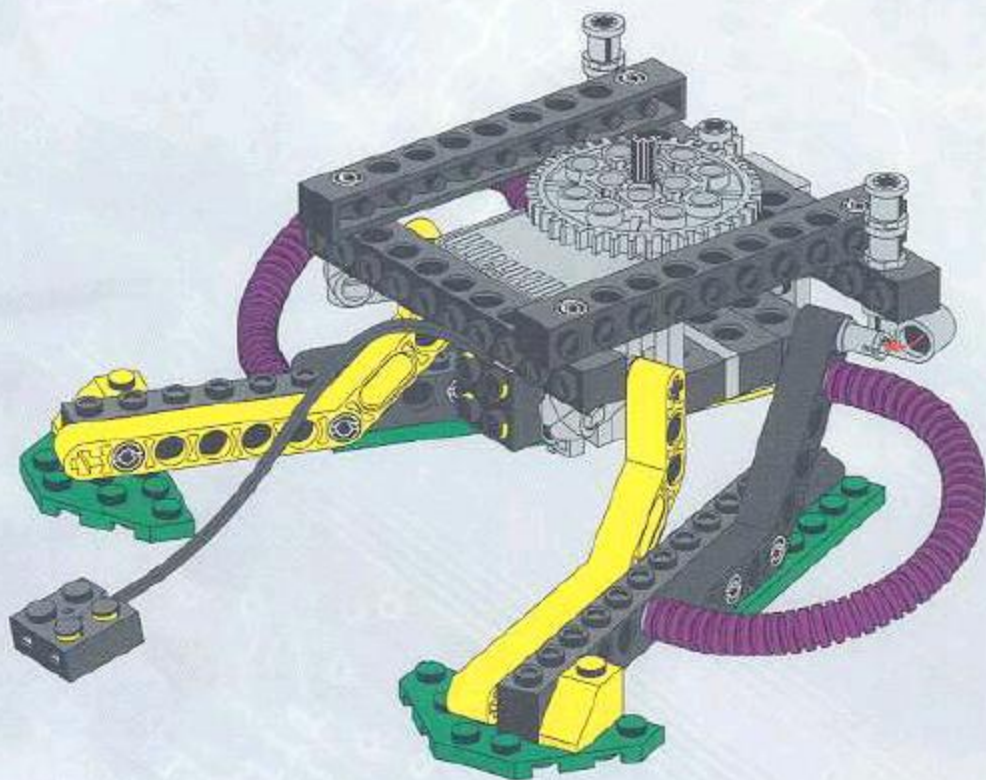

6

Attach the Standing Base to the Body like this.

If you have not yet built the Body, go to page 58.

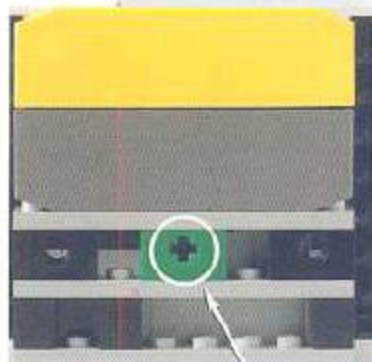

This is where you connect the Standing Base to the Body.

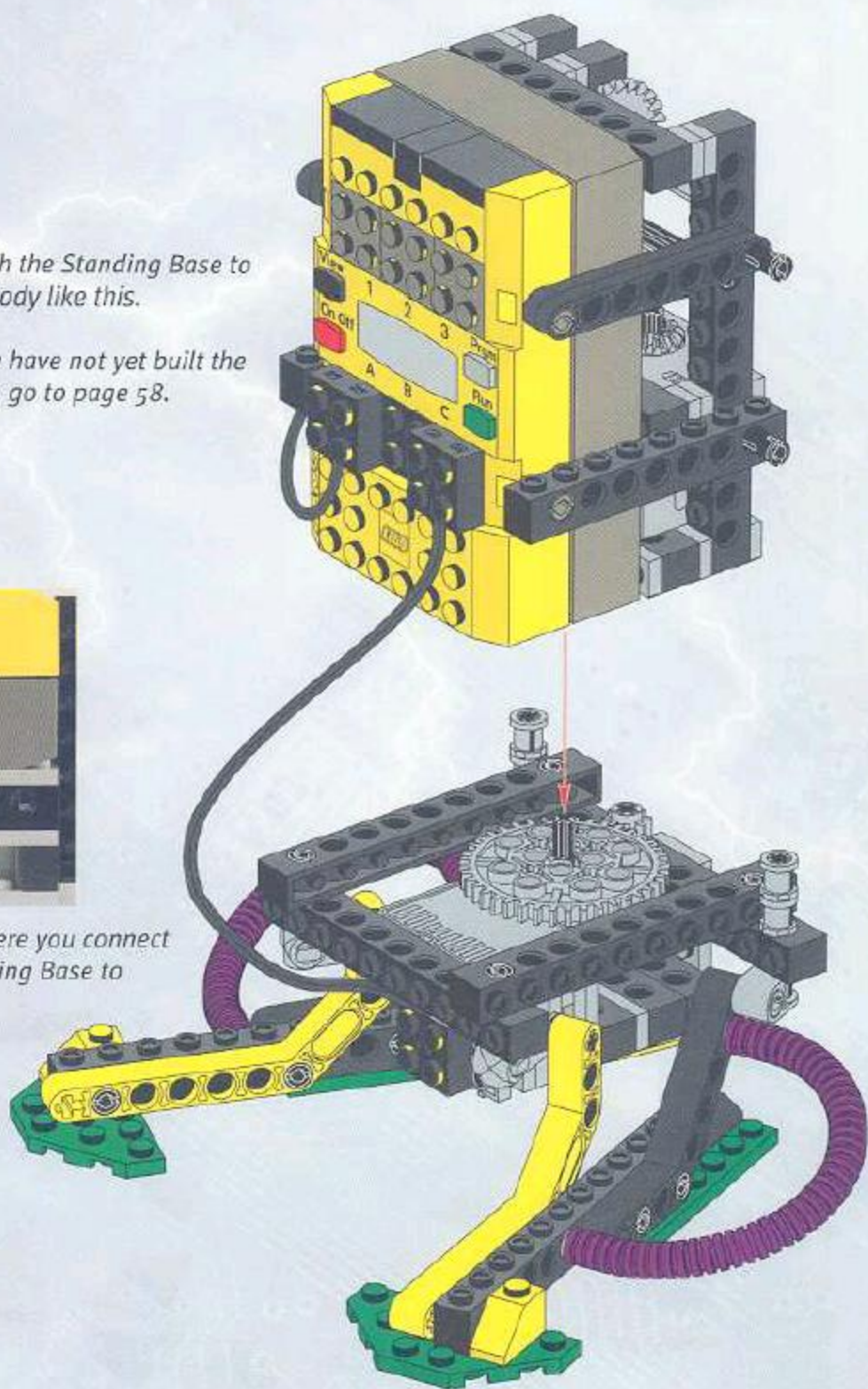



1

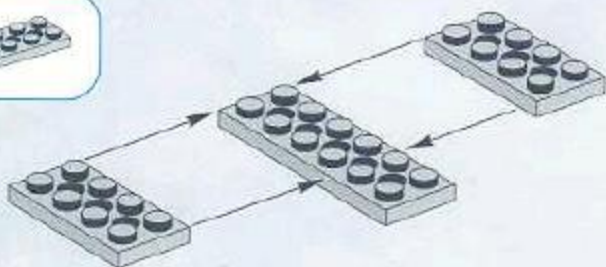

2

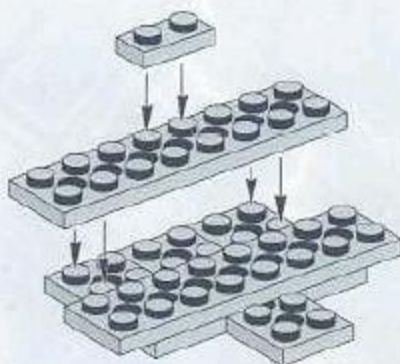

3

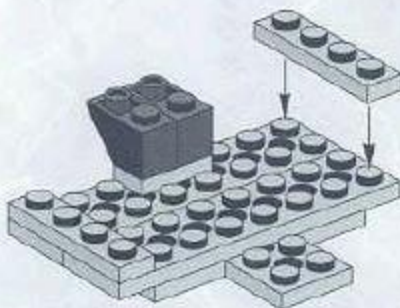

4

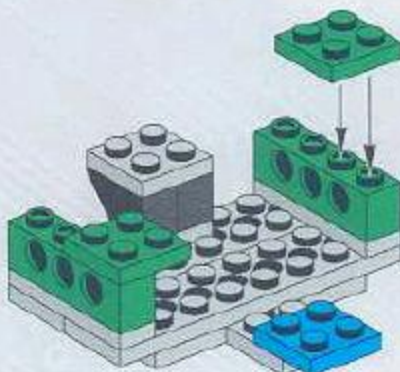
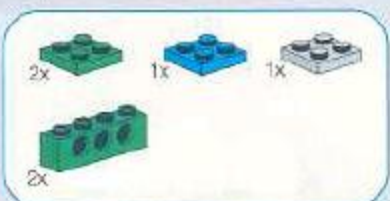

5

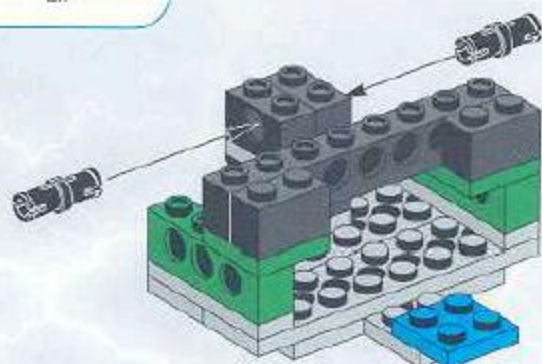
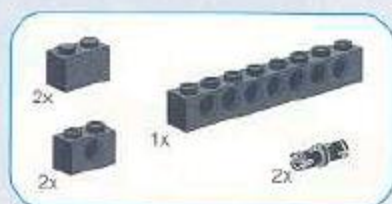

6

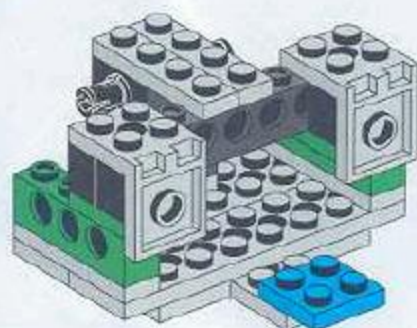

7

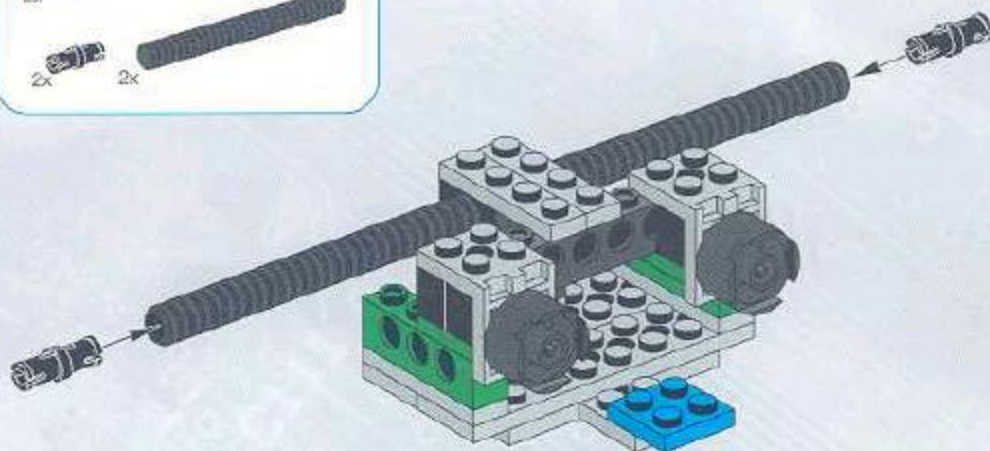



8

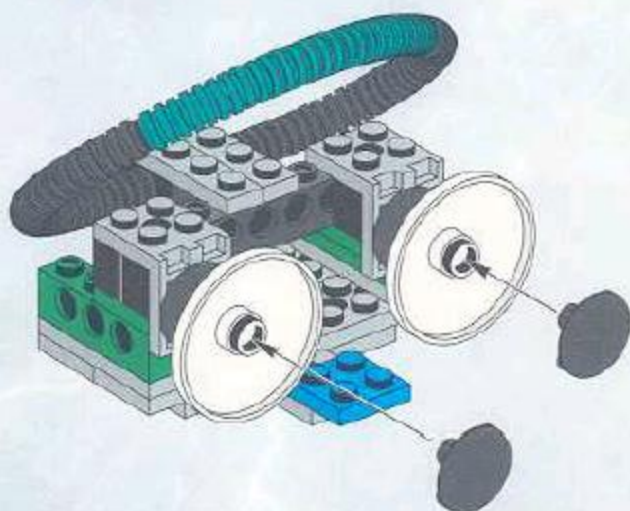
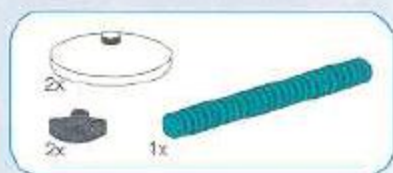

9

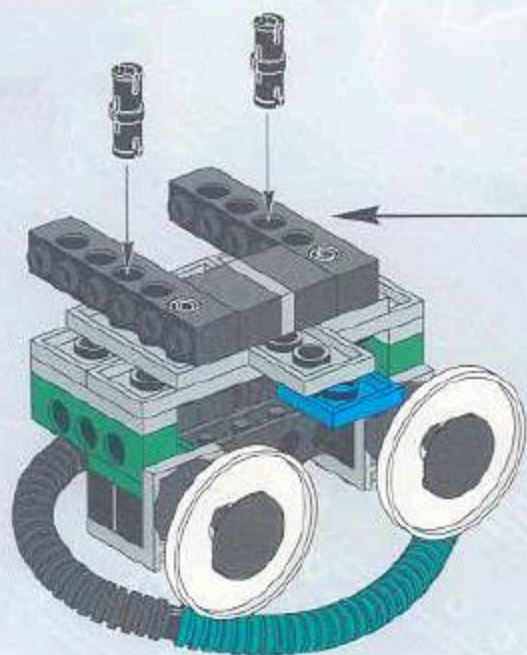
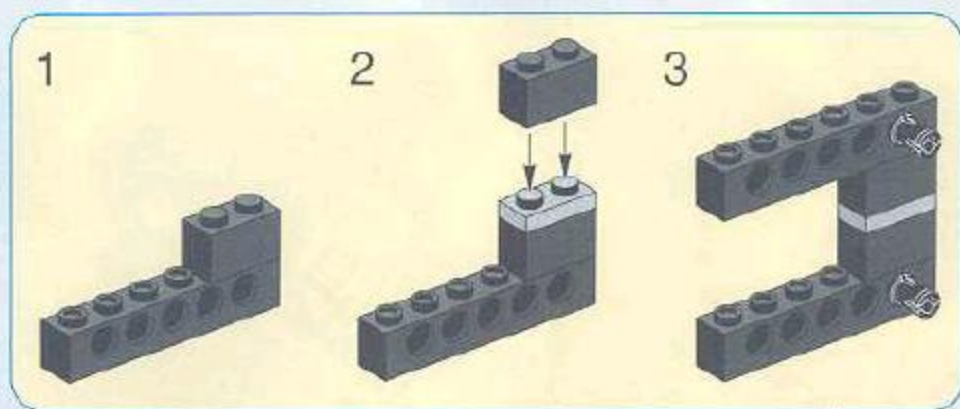

10

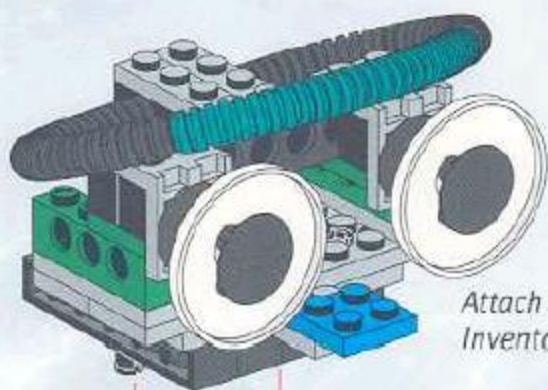

Attach the Head to the Inventorbot's Body like this.

If you have not yet built the Body and the Standing Base, go to page 58.



Now you are ready to build some arms for your Inventorbot.

Hat Arm

1

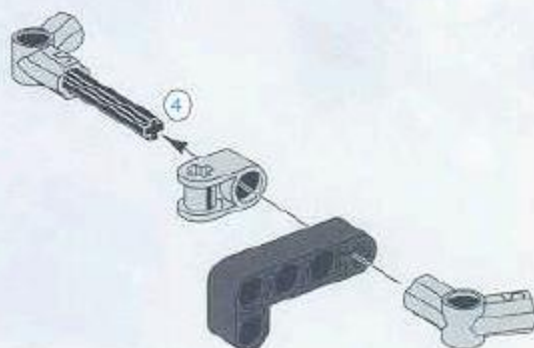
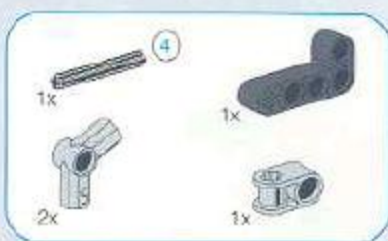

2

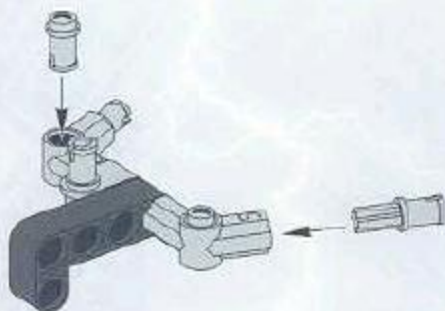

3

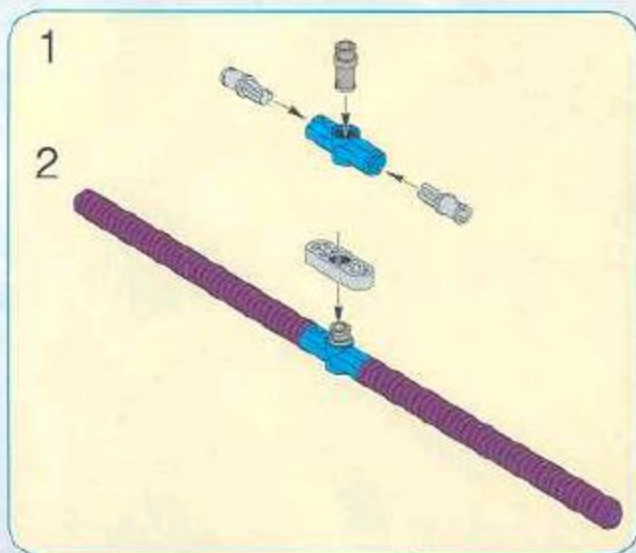
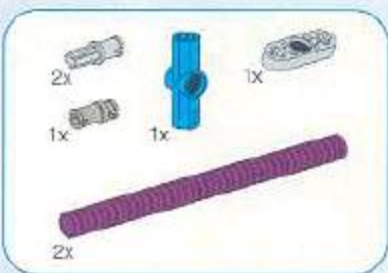

4

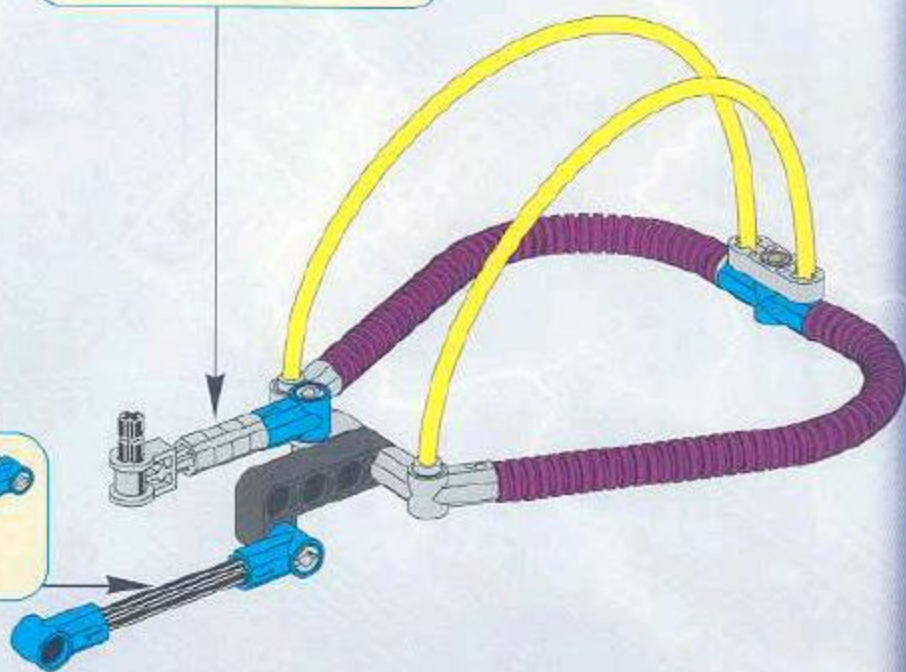
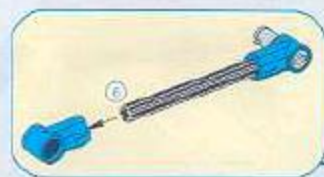
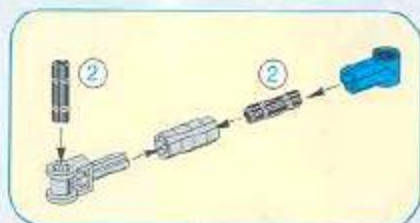
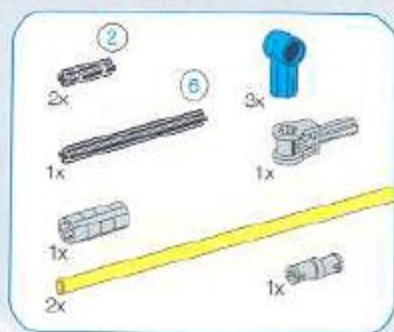

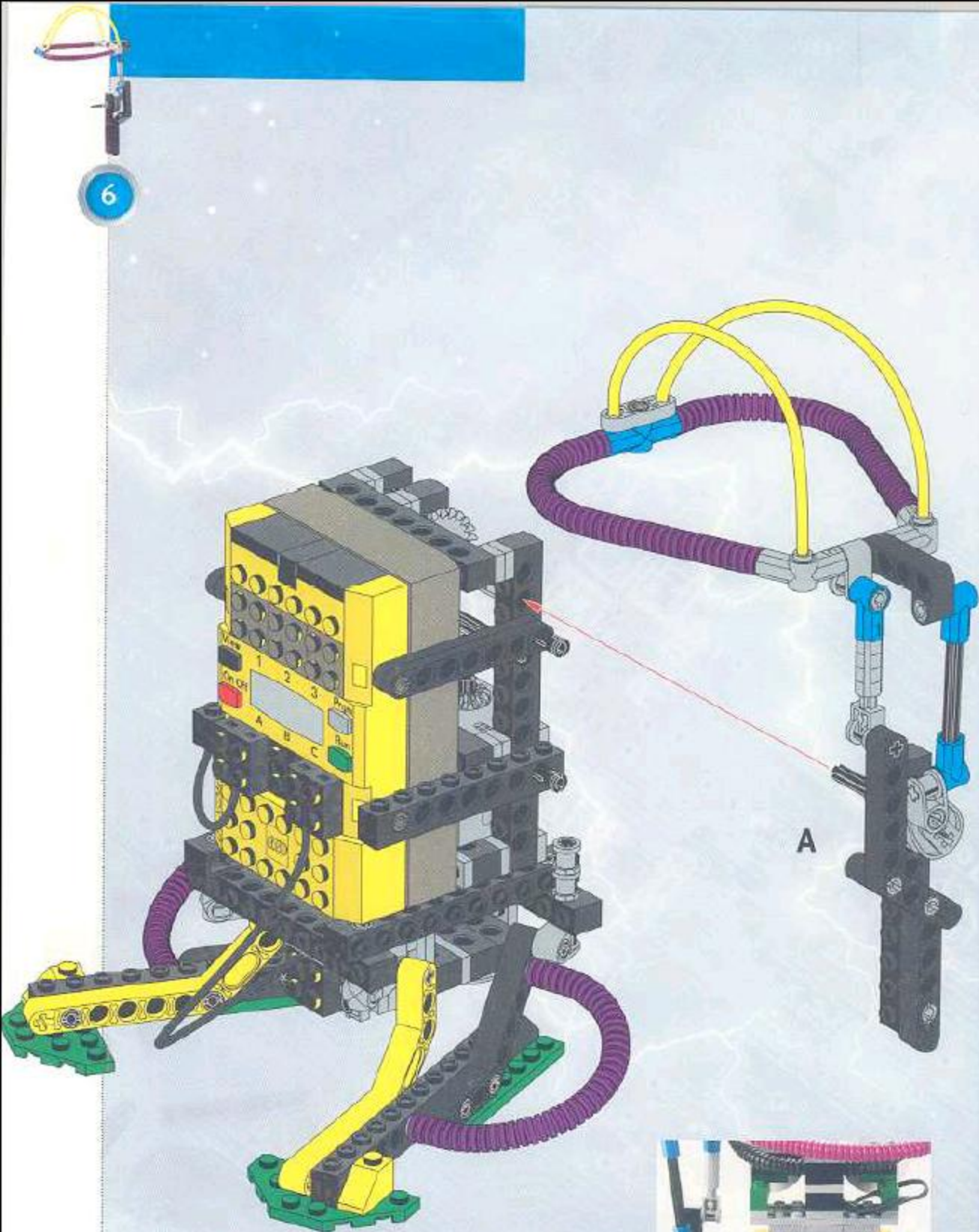

Attach the Hat Arm to the Inventorbot like this.

Make sure piece A fits into piece B.

If you have not yet built the Body and the Standing Base, go to page 58.

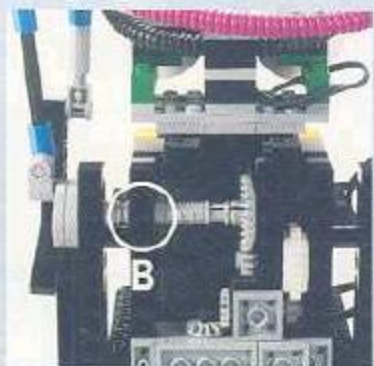

Slap Arm



1

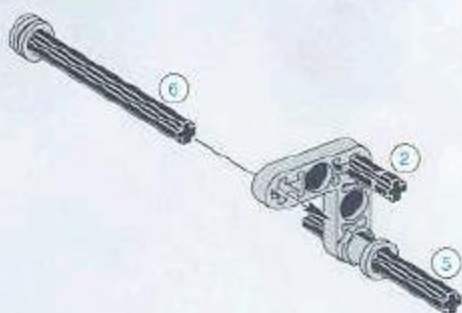
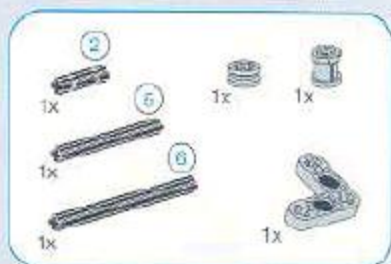

2

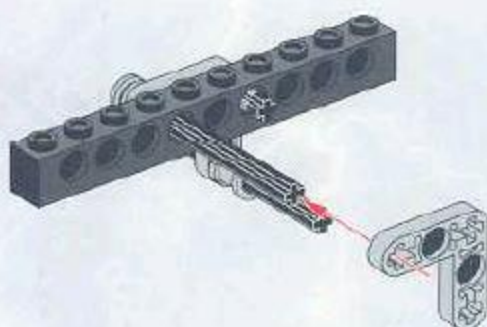

3

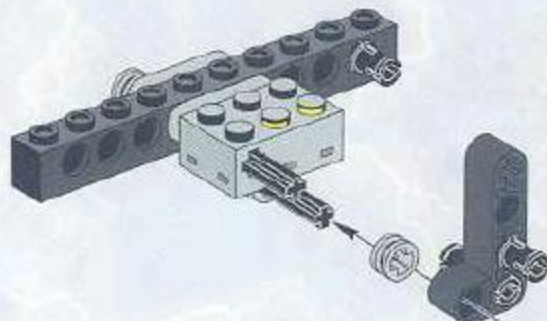

4

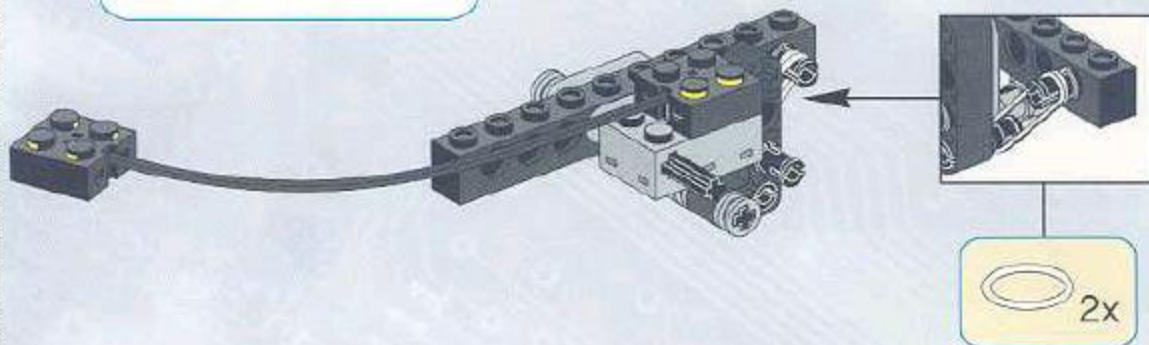



6

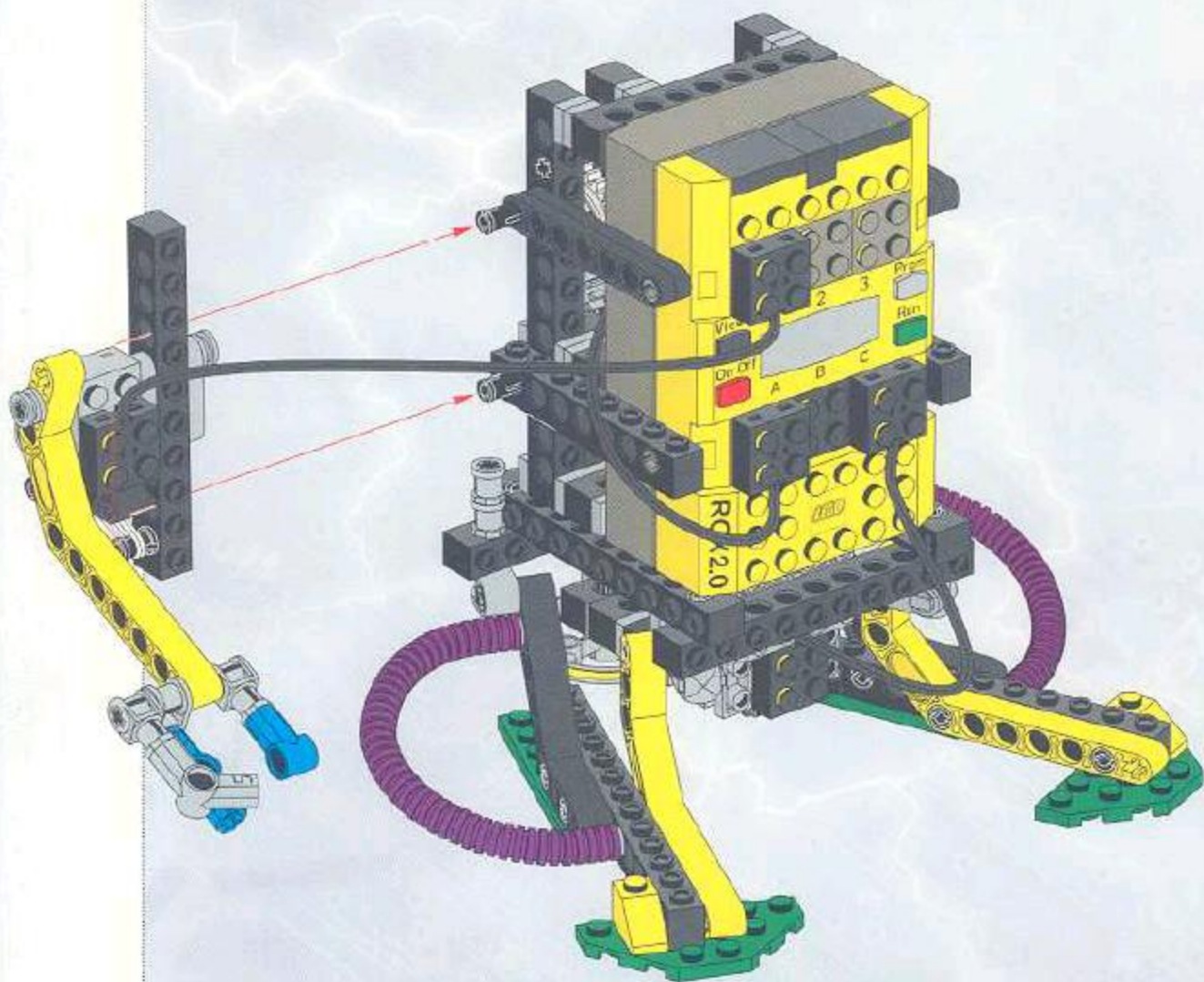

Attach the Slap Arm to the Inventorbot like this.

If you have not yet built the Body and the Standing Base, go to page 58.

Squeeze Arm

1

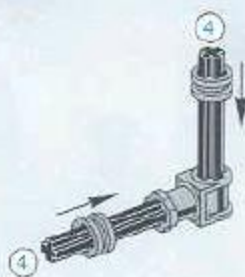

2

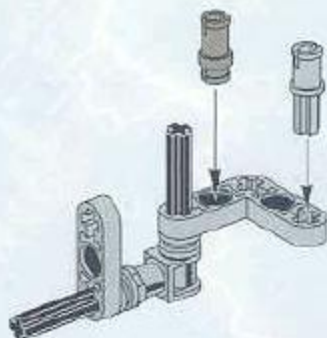

3

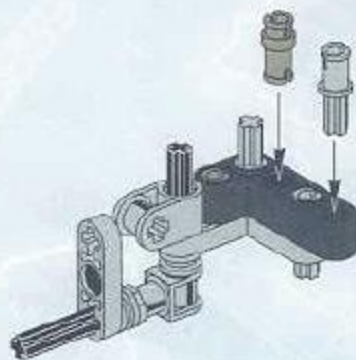

4

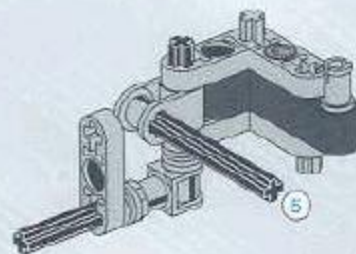

8

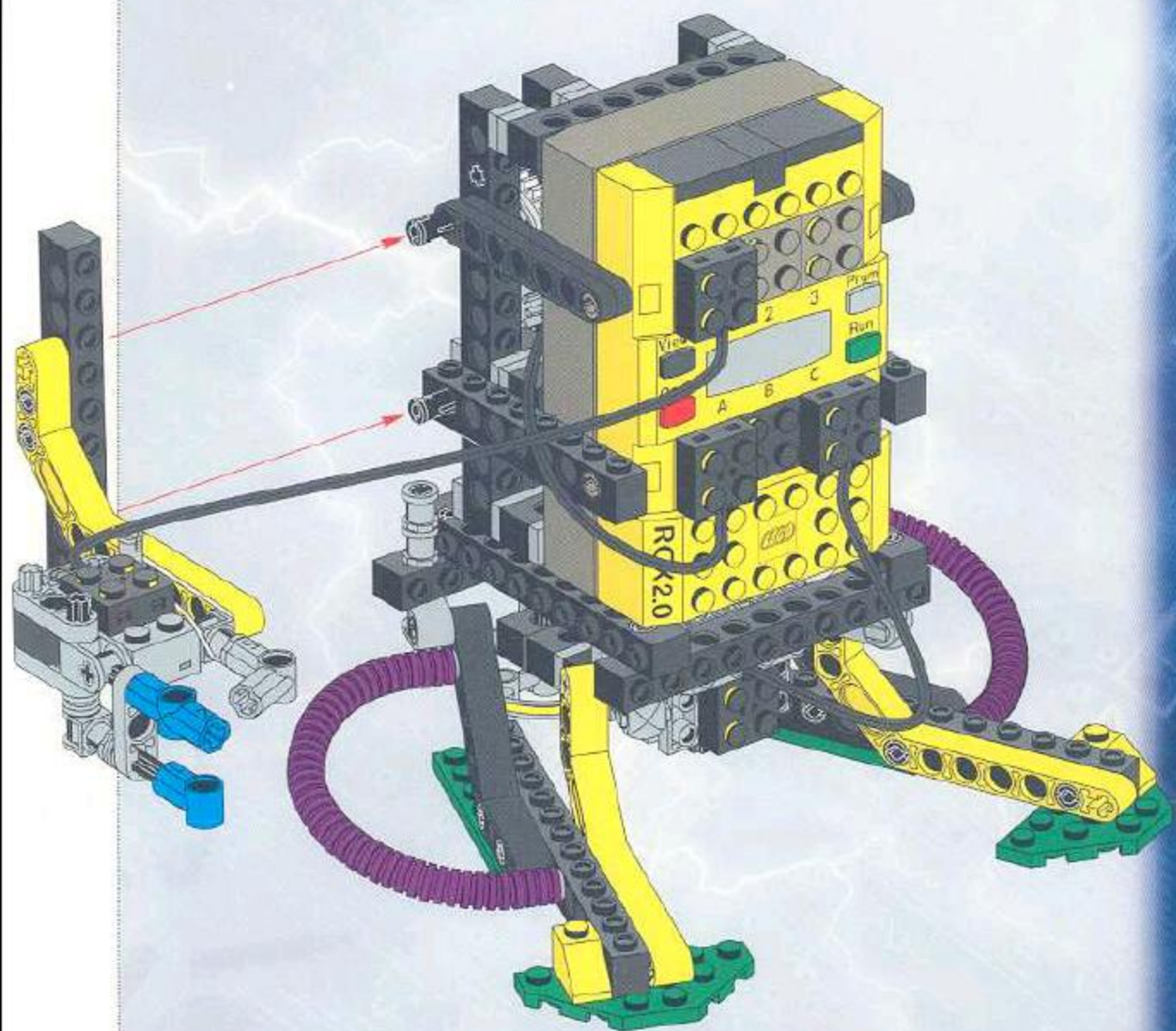

Attach the Squeeze Arm to the Inventorbot like this.

If you have not yet built the Body and the Standing Base, go to page 58.

Thrower Arm

1



2

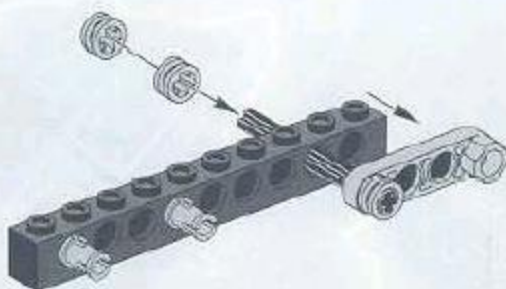

3

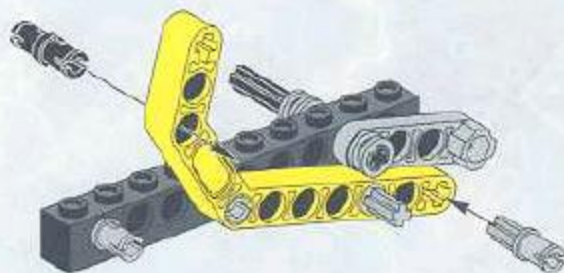
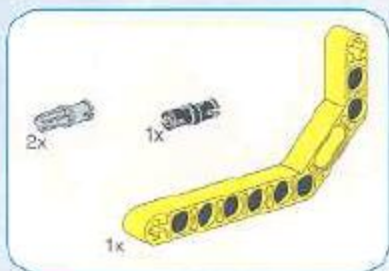

4

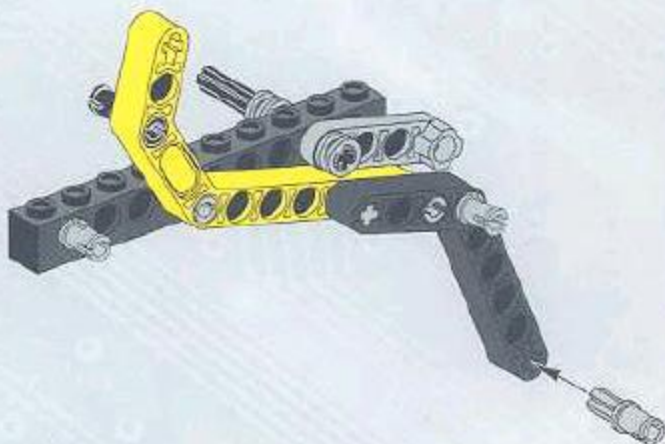

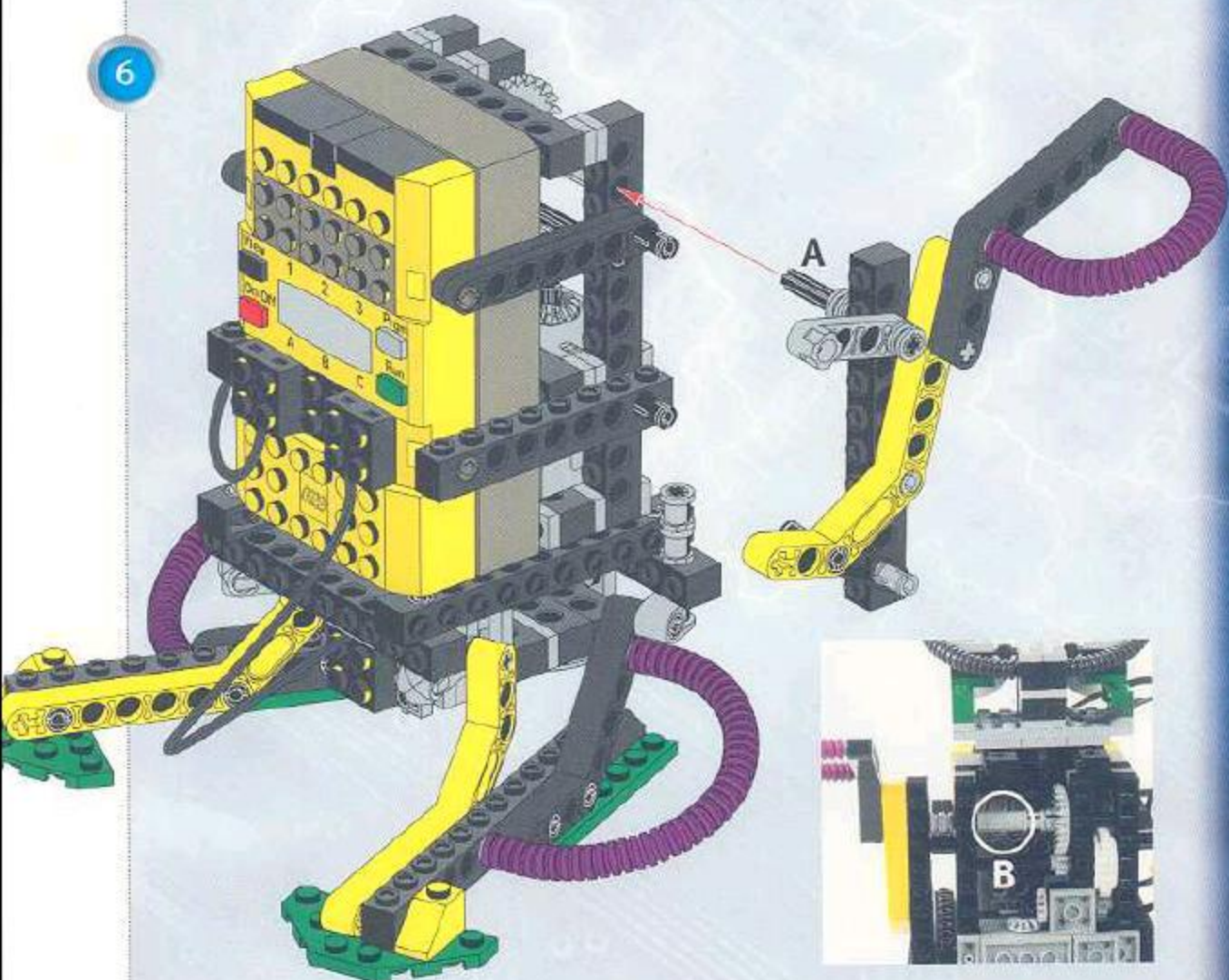
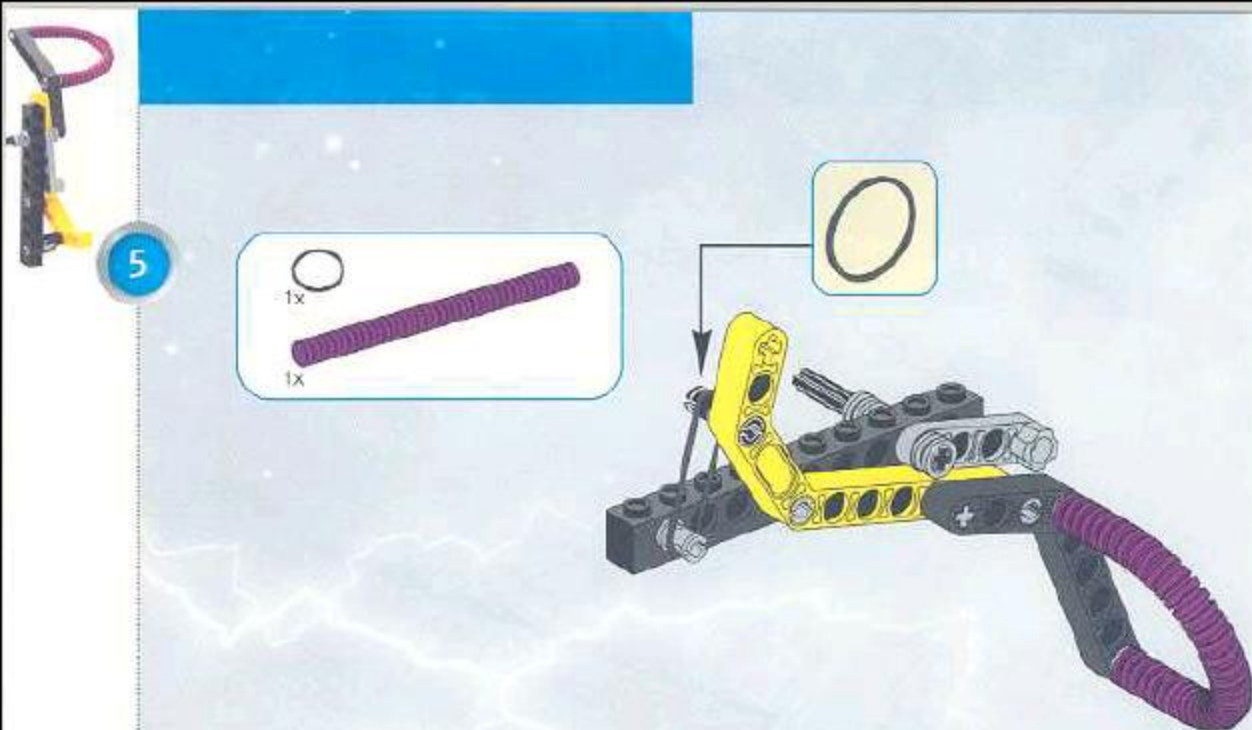

Attach the Thrower Arm to the Inventorbot like this. Make sure that piece A fits into piece B.

If you have not yet built the Body and the Standing Base, go to page 58.

Light Sensor



1

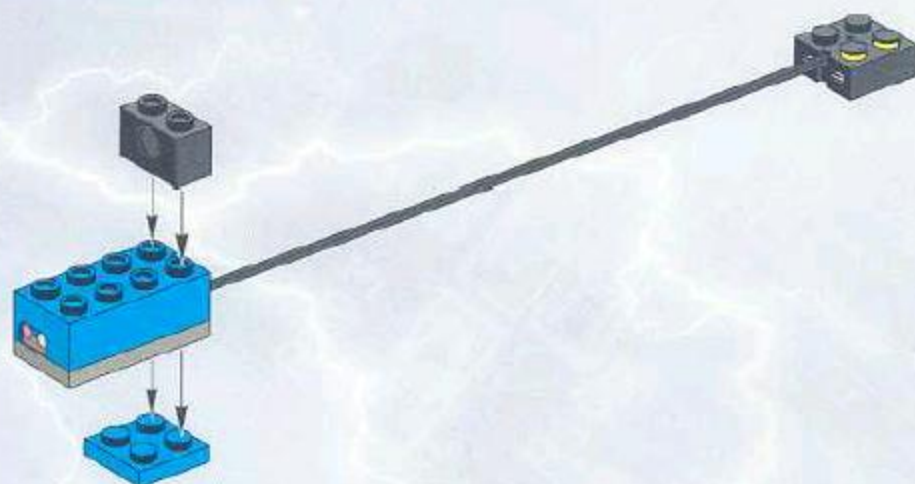
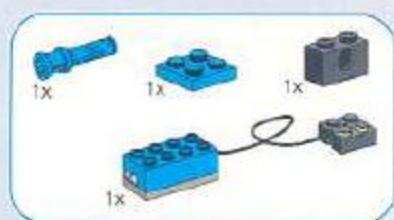

2

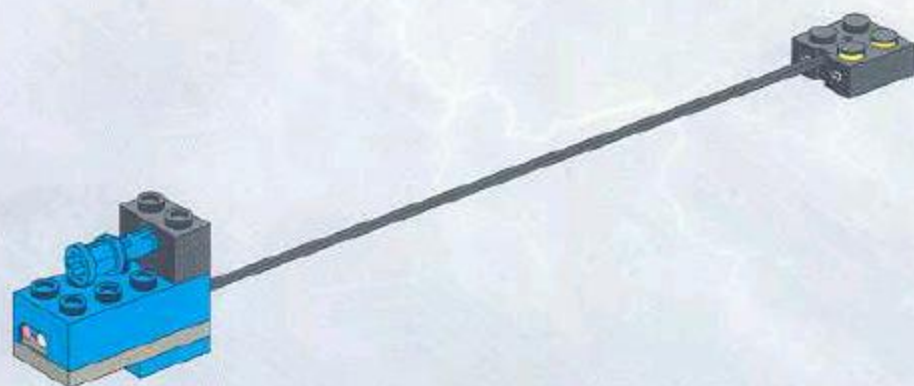

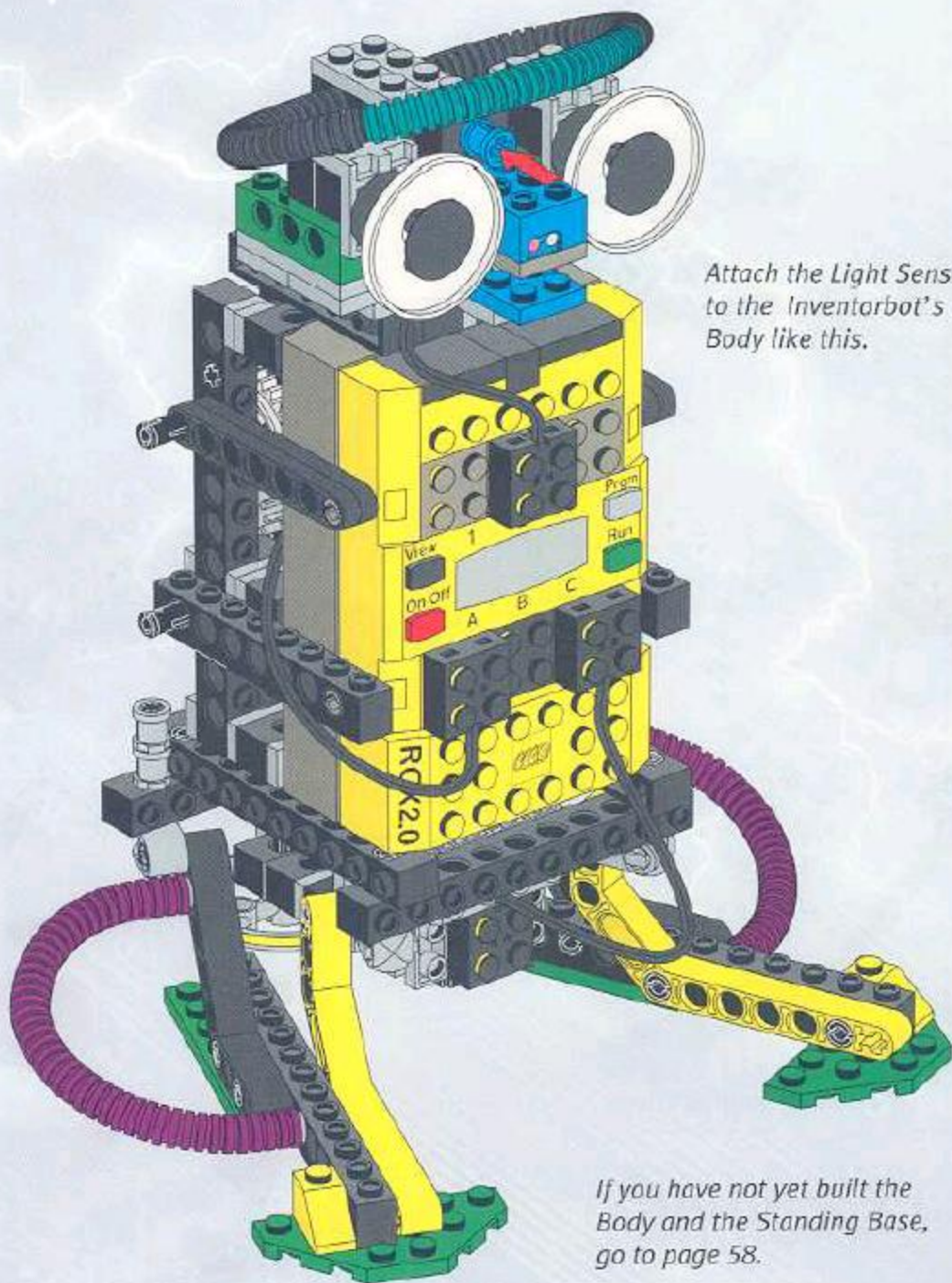

Attach the Light Sensor to the Inventorbot's Body like this.

If you have not yet built the Body and the Standing Base, go to page 58.



SPECIAL FEATURES

The following four pages show ideas and suggestions for dressing up your Roverbot.



Bug Eyes

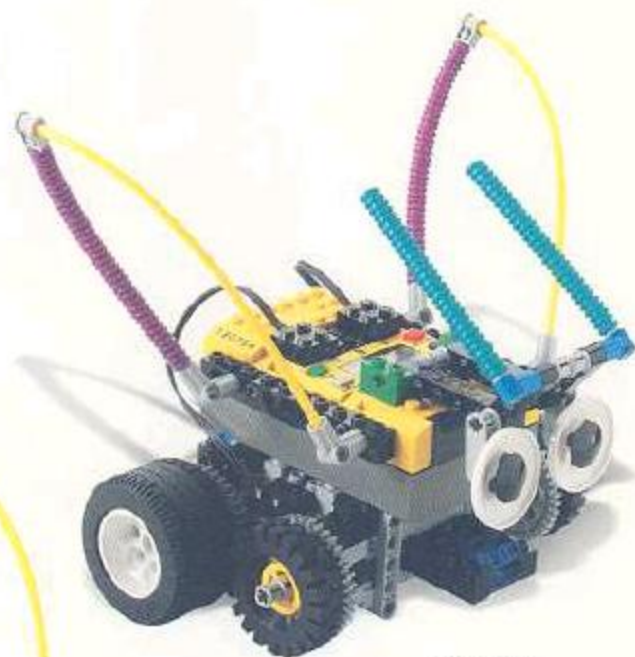

example

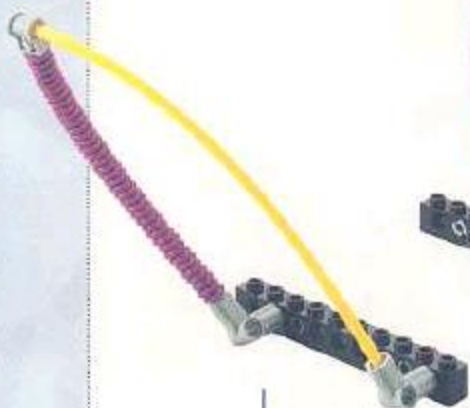

Angled Wings

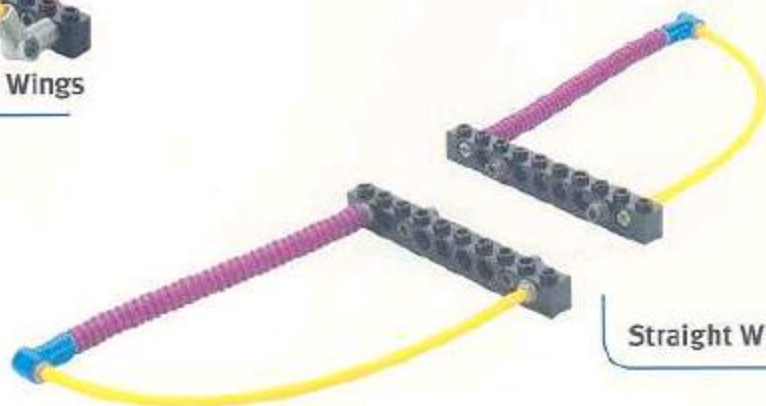

Straight Wings



Claws



example



Parrot Head



example

With this head you can program your robot to react when you stroke its "head feathers"

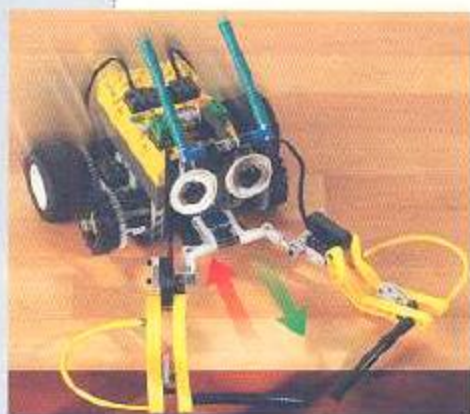
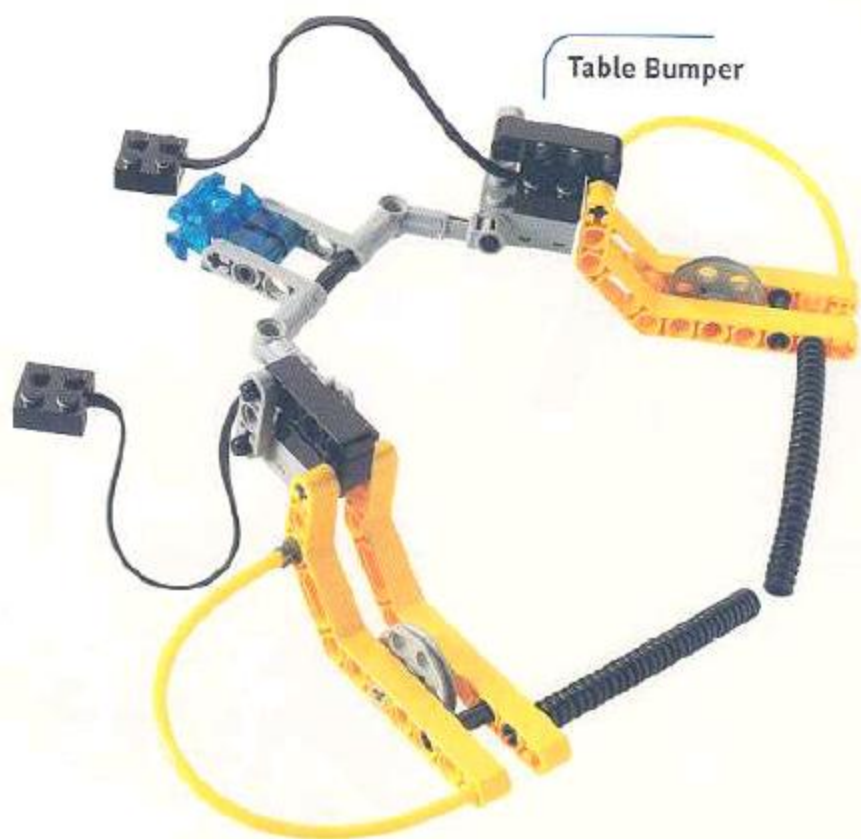

This bumper can make the Roverbot sense the edge of a table and then avoid falling off.

Hint: The Touch Sensors will be pressed when the bumper goes over the edge.

Warning: Make sure bumper works before trying it on a table.

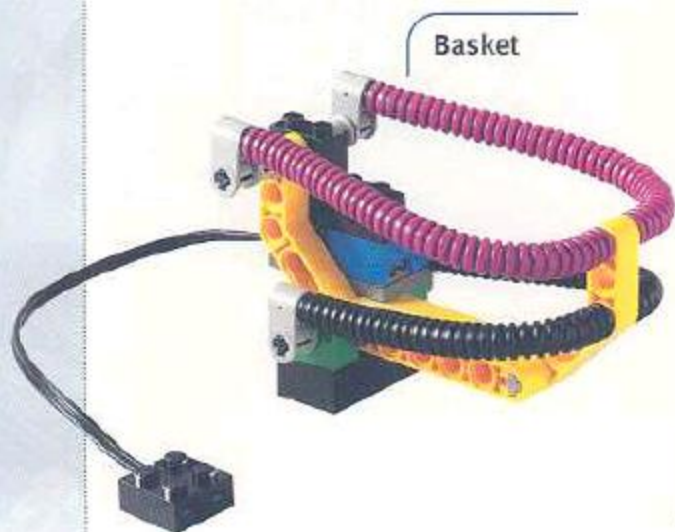

Tail Sensor



Cyclops



You can attach the Tail Sensor or the Cyclops like this.

Cable Control



The Cable Control can be used as a remote control to steer your robot. It uses two Touch Sensors. Use the longest wires in the set to get the maximum distance for control.



detail

SPECIAL FEATURES

The following four pages show ideas and suggestions for dressing up your Acrobot.

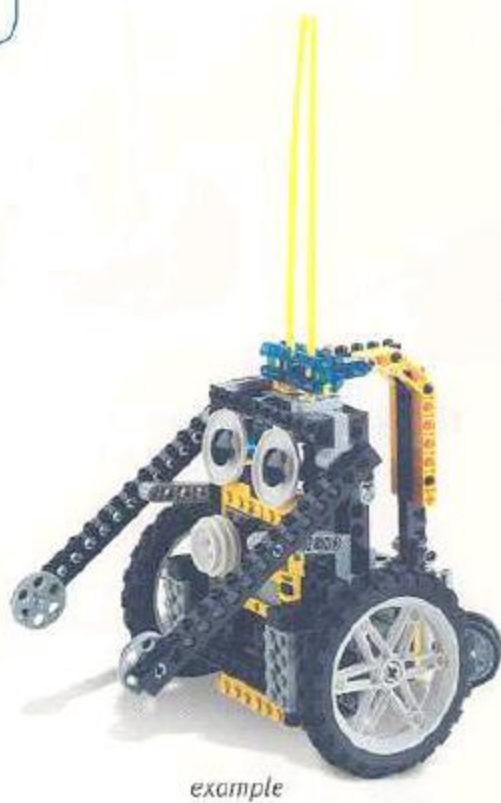
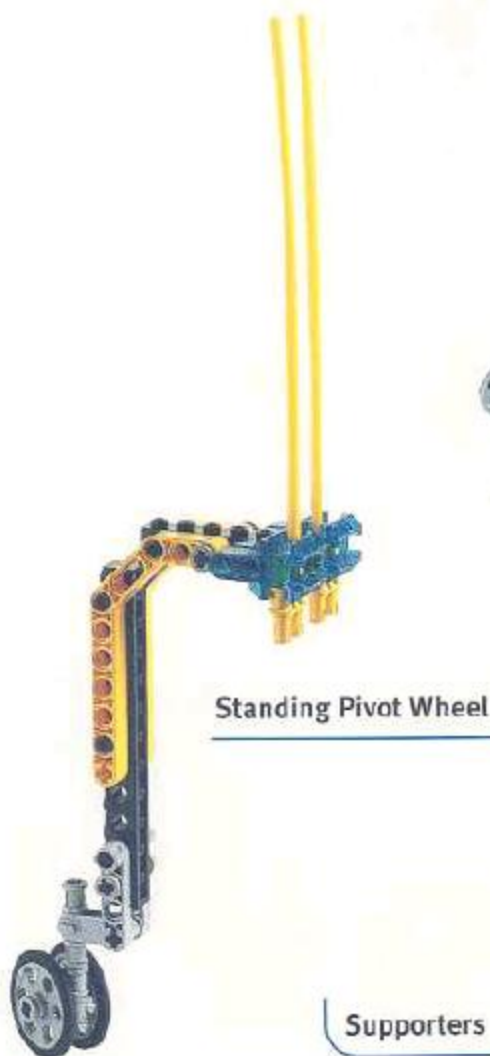



Big Eyes



example

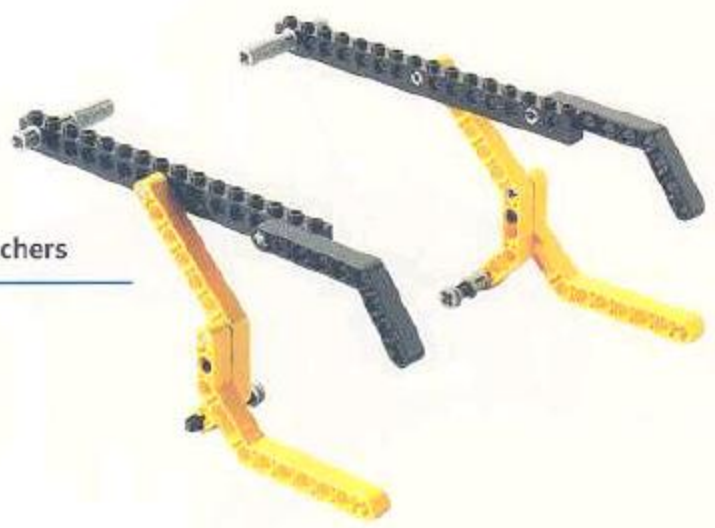

Wheel Pinchers

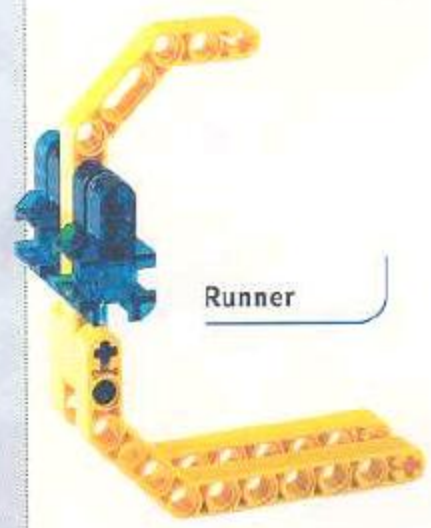

Runner



example



Hind Legs

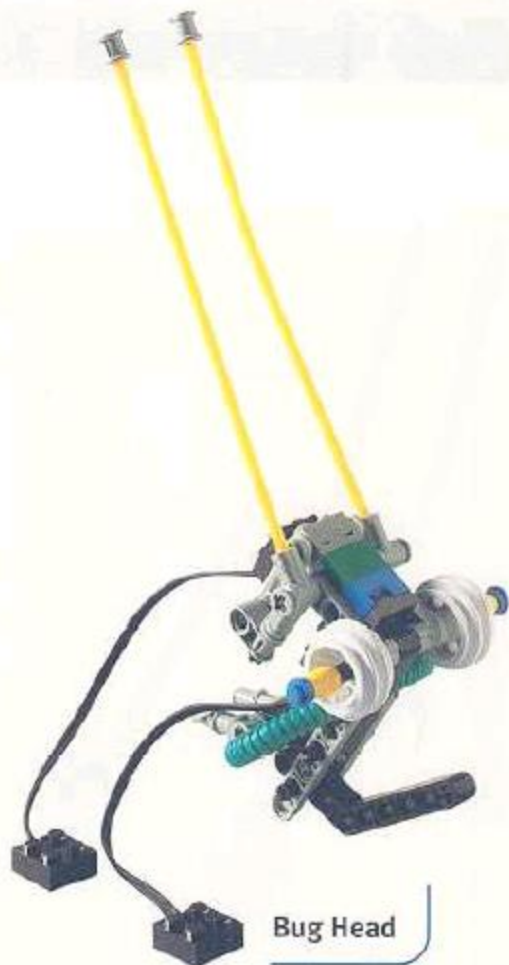

Bug Head

The Bug Head has a Touch Sensor that should be activated when the feelers bump into something. It also has a Light Sensor so it can follow a bright light.

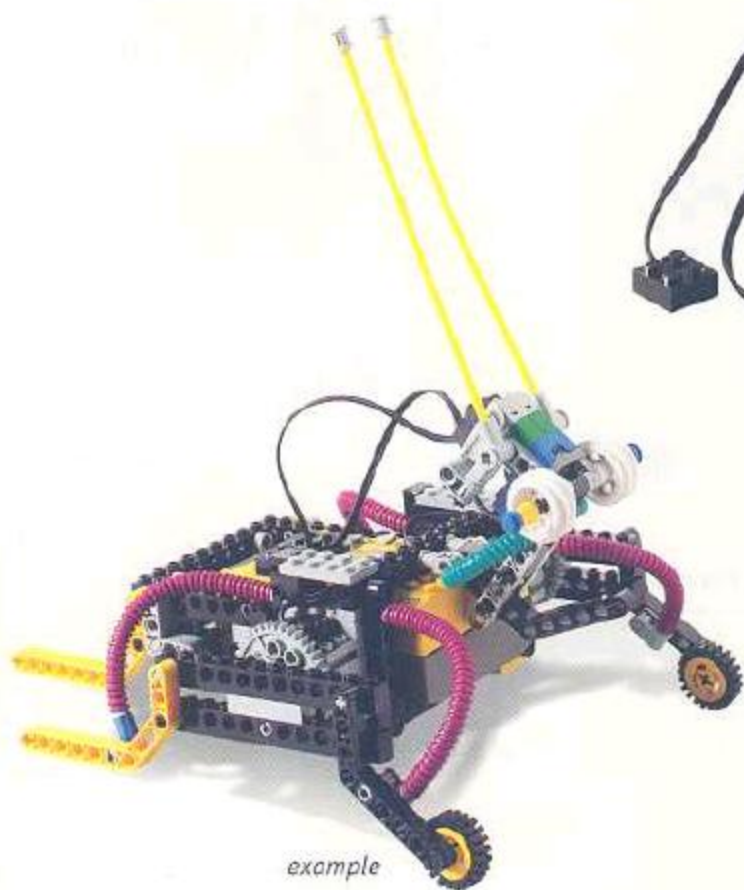

example

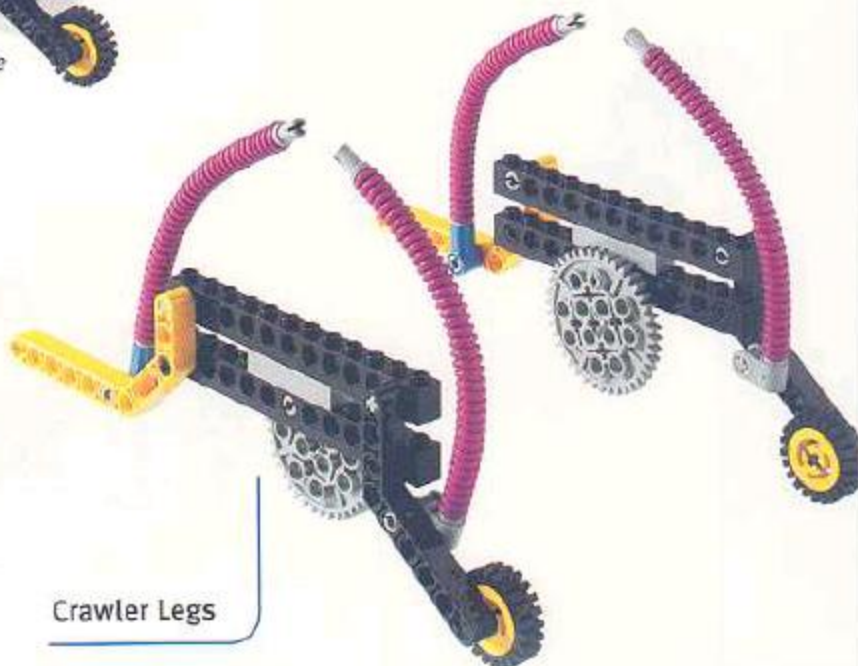

Crawler Legs



Power Bumper

This bumper can make the Acrobat react when the bumper hits an object. The robot is so fast, it needs Support Wheels to keep it from falling over.



detail



Support Wheels



example



SPECIAL FEATURES

These two pages show ideas and suggestions for dressing up your Inventorbot.



Waving Arm

The Waving Arm is attached to the Inventorbot like the Hat Arm on page 77



example

Touch Sensor Nose



Head



Head Shaker Attachment

When motor A is running, the robot will shake its head.



detail



example

Target Bumper

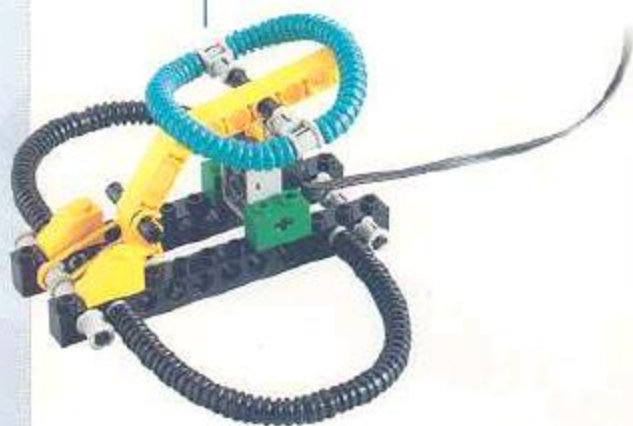

Can you program your robot to throw an object at the Target Bumper and make it sense when it hits? Use the longest wire to connect the Target Bumper to the Inventorobot.



example



TIPS & TRICKS

On the following four pages you can find tips and tricks to make your inventions bigger, stronger, and faster.

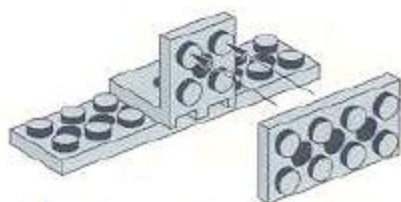

Making angles

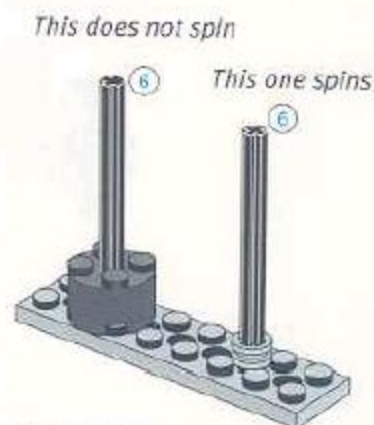

Adding axles



Gray connector pegs allow moveable connections.

Connecting two beams

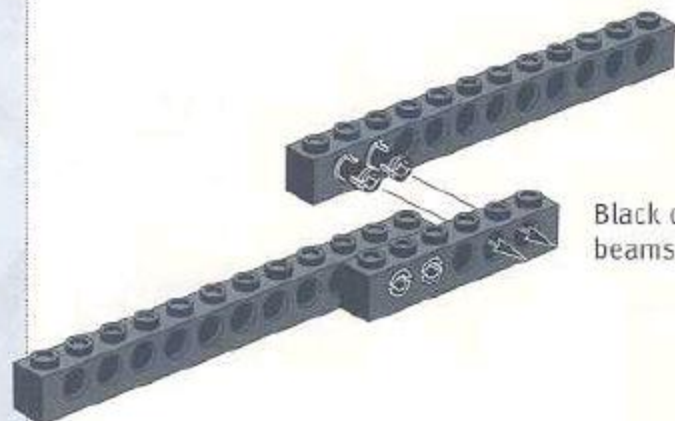

Black connector pegs lock beams firmly.

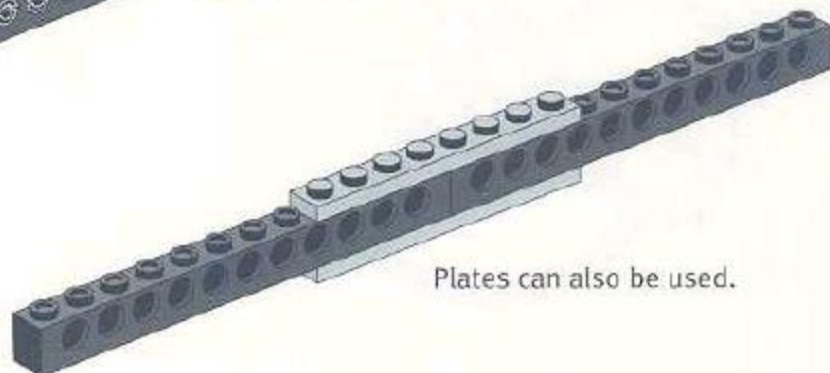

Plates can also be used.

Adding height

Using two plates between beams makes your construction more durable.

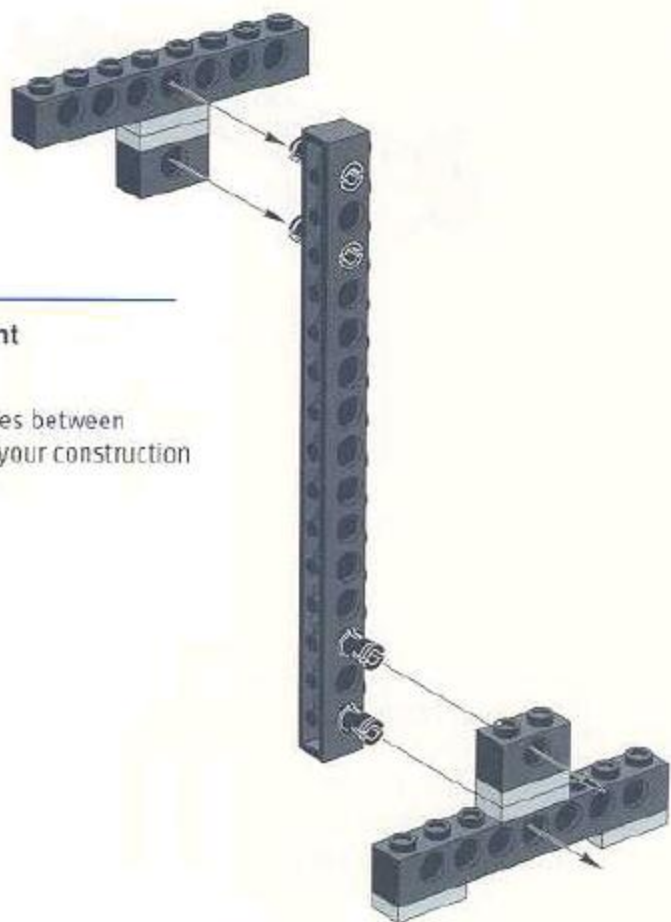

Extending axles

Using beams to support your axles makes your construction more durable.

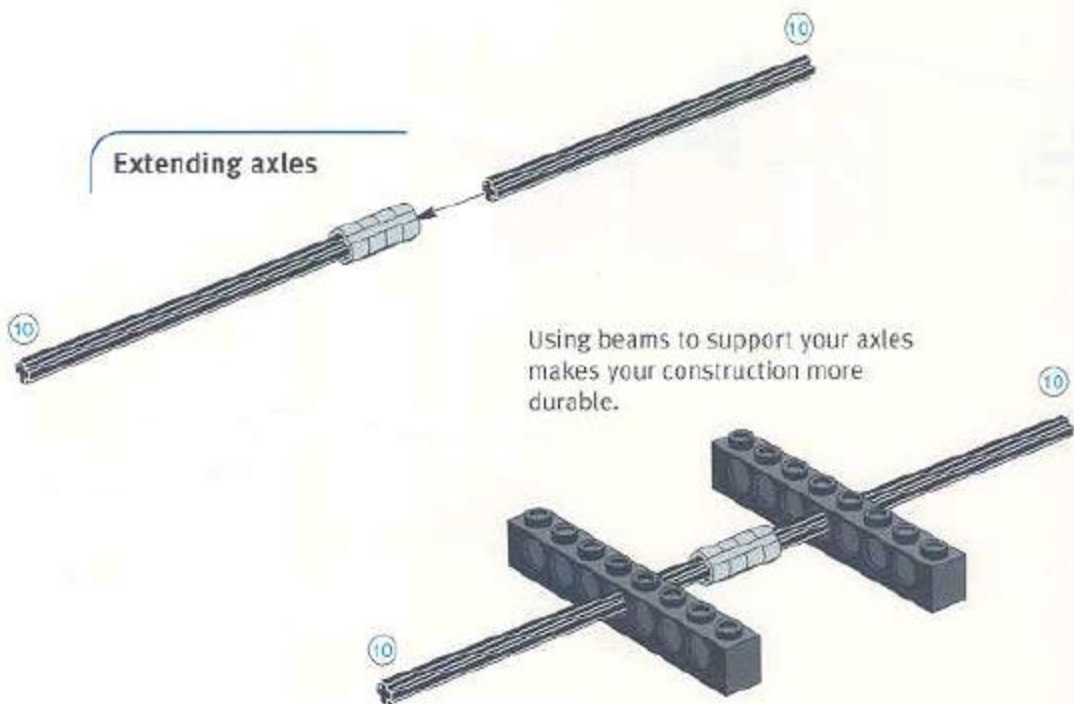

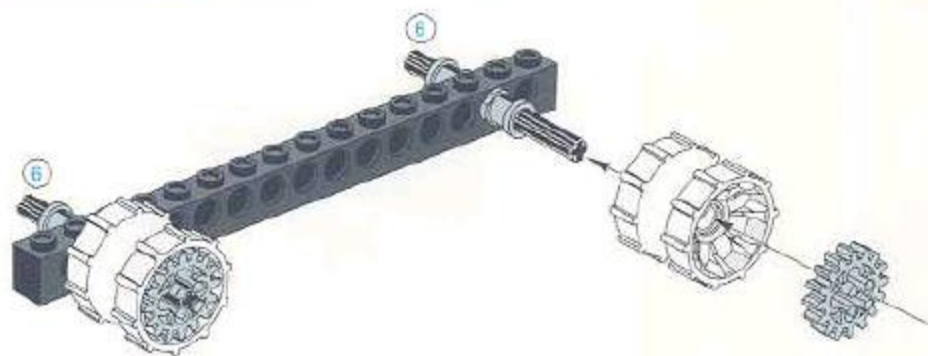

Adding hubs for caterpillar treads

The gears allow the hubs to revolve.

The Worm Gear

Connecting the worm gear axle to a motor will cause the 24-tooth gear to turn very slowly, but with lots of power.

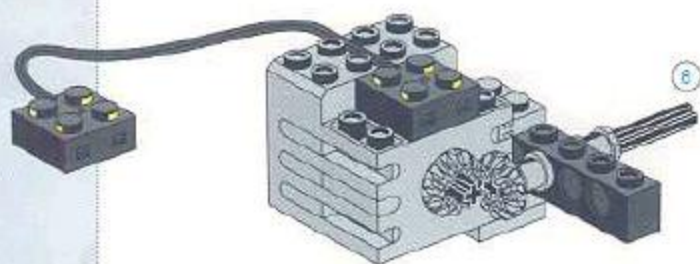
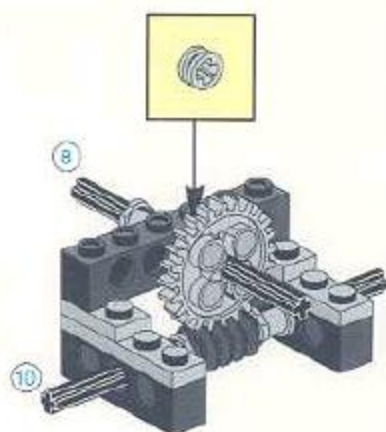

Angle gearing

Making a gearing at an angle.

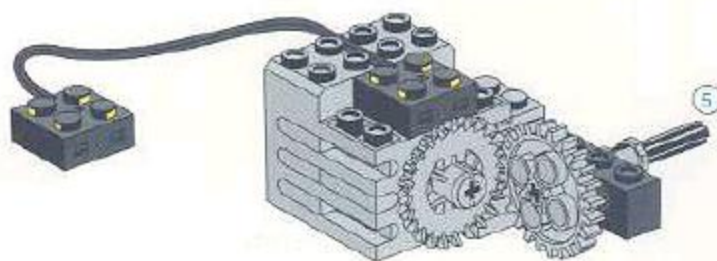

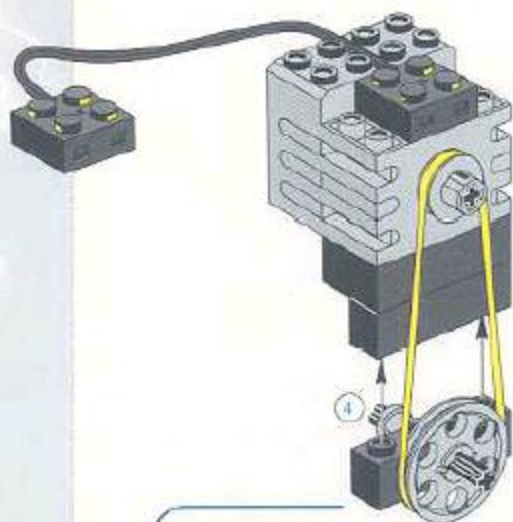
**Belt Drive**

By using a belt drive, you can transmit power over long distances.

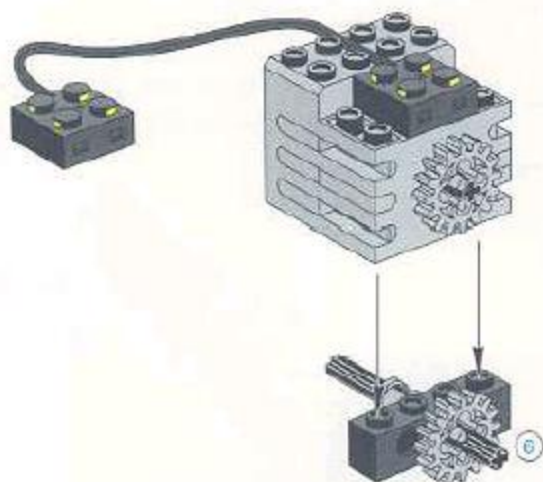
**1:1 gearing**

Using the same size gears makes the attached axle move at the same speed as the motor.

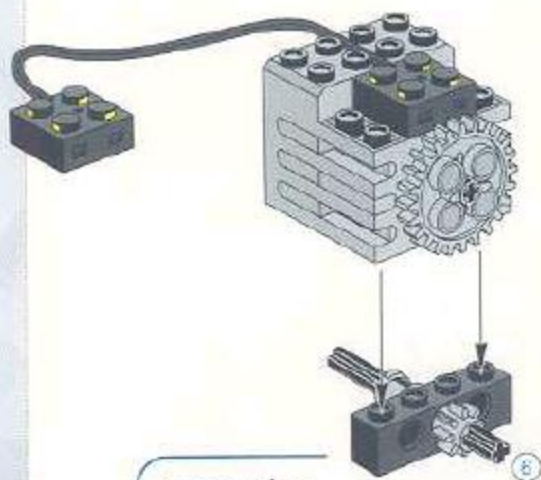
**1:3 gearing**

Using 1 to 3 gearing causes your axle to spin fast.

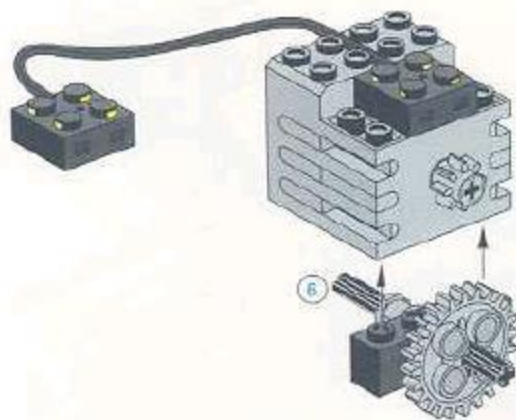
**3:1 gearing**

Using 3 to 1 gearing causes your axle to turn slow, but with power.

LEGO

TOP SECRET

CODE: NU-INV9747-A

DEP.: MINDSTORMS

REF. INVENTORBOT PLANS RCX 11/99

DESCRIPTION:

This is a prototype for a new Base that allows the Inventorbot to move forwards and turn while moving backwards. It uses only one motor!

By attaching a Light Sensor to the Base, the robot can be programmed to see the difference between the table edge and what lies beyond it.



103106YKYKU

MINDSTORMS



THIS PIECE LOCKS THE GEAR
CAUSING ROBOT TO TURN WHEN
MOTOR REVERSES DIRECTION



3



4

2



REF INVENTOR BOT PLANS



4A

1/1/91
RCX

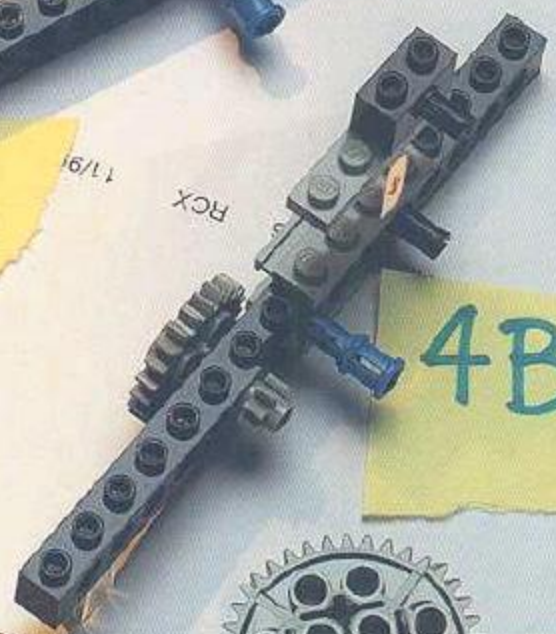

4B

5

MINDSTORMS
91747-A



MINDSTORMS
LEGO

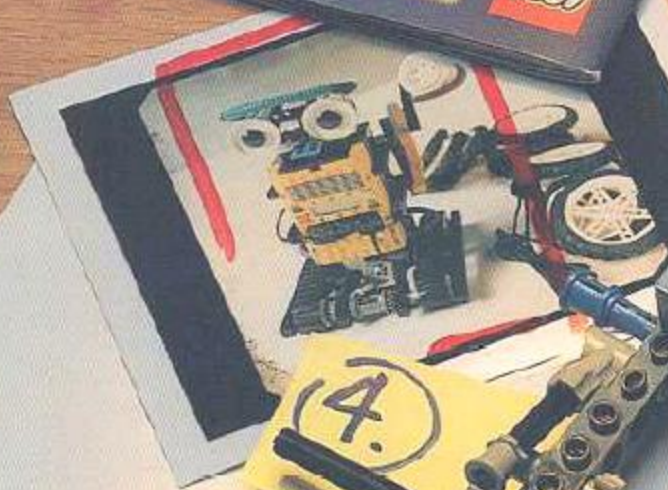

4.

2

5.

CODE: NU-INV9747-A
DSTORMS

LEGO MINDSTORMS



6.

REMEMBER!
SPECIAL RELEASES TO COME ON
WWW.LEGOMINDSTORMS.COM

THESE ARE USED
TO LOCK YELLOW BEAMS

7.





LIGHT SENSOR/TEST PAD

The Light Sensor can be used with the Test Pad.

With the Light Sensor pointing down, you can make your robot follow a black line.

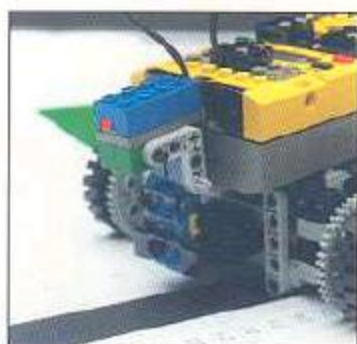
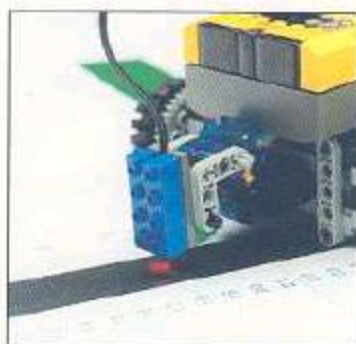

With the Light Sensor pointing forwards, you can make your robot follow or avoid light.

Use the numbers to measure distance.
See how far your robot goes with different wheels over time.

Make your robot count the green blocks.

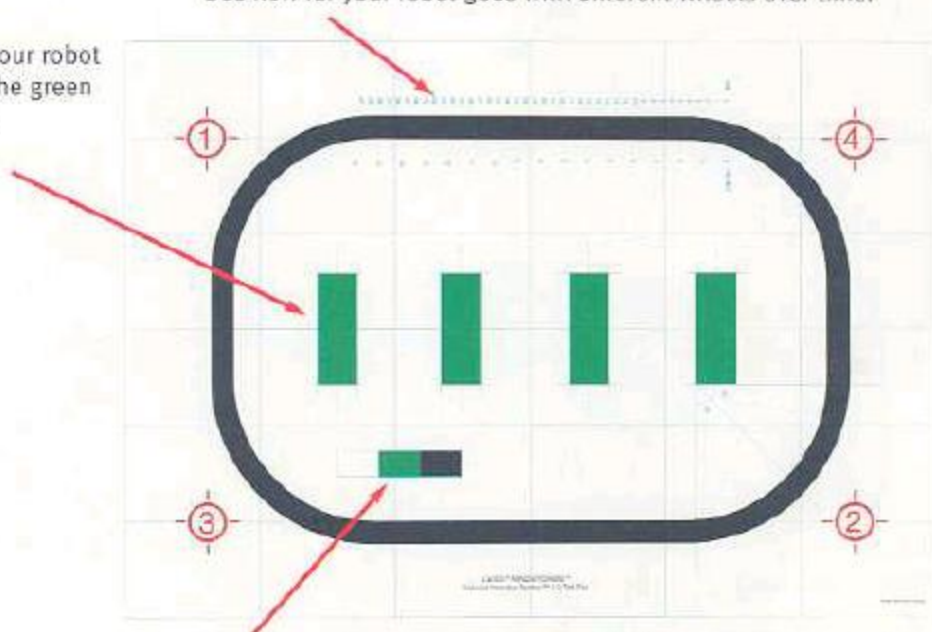

This color strip can be used to find out an individual color's numerical value as measured by the RCX. Use the View button (as explained on page 6) to see the Light Sensor readings.

Note: the amount of light in your room will effect the reading.

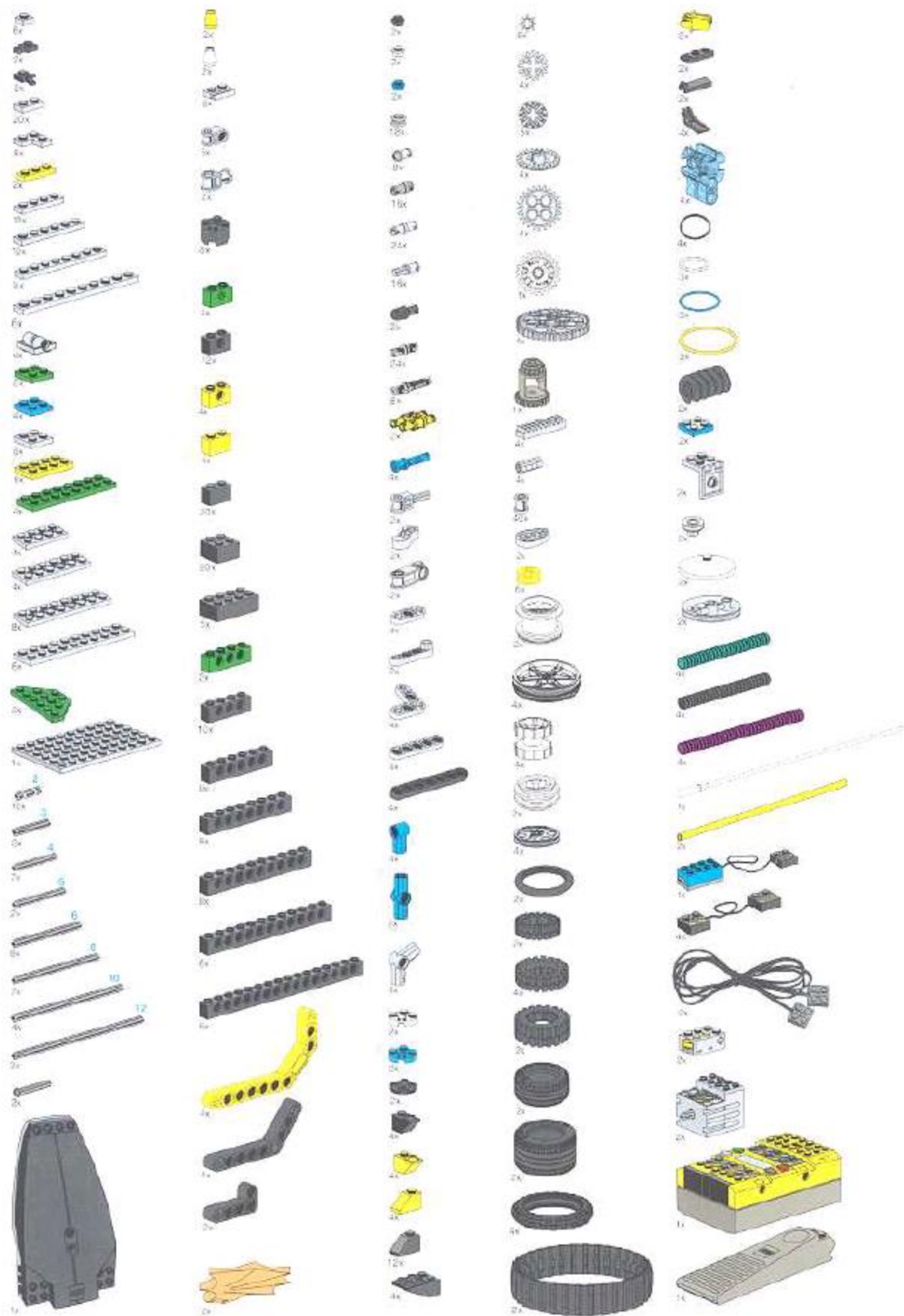

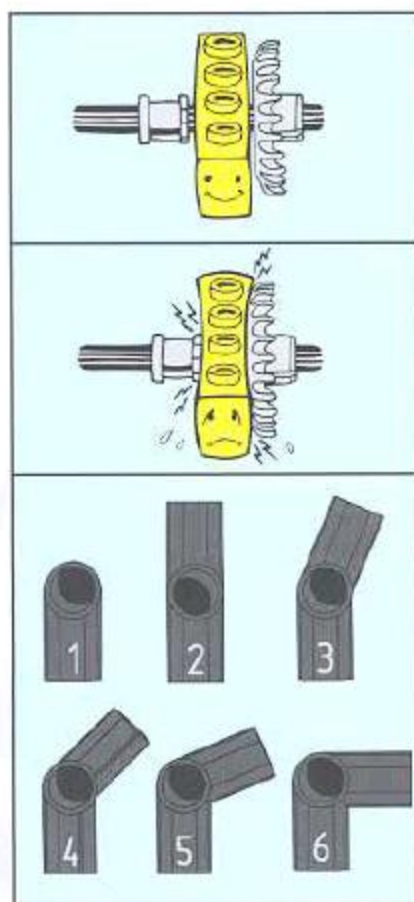
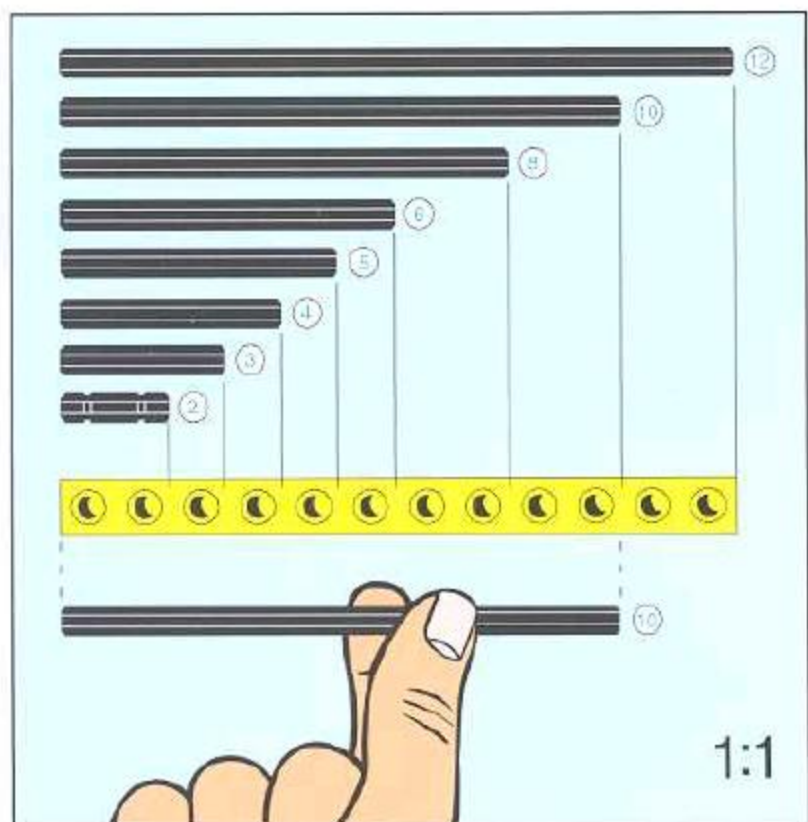

The background of the advertisement is a dark blue, atmospheric scene featuring a dense layer of white, misty clouds. In the foreground, a complex circuit board is visible, with various components and traces rendered in a lighter blue hue. The overall aesthetic is futuristic and technological.

LEGO MINDSTORMS™

www.legomindstorms.com