

8860

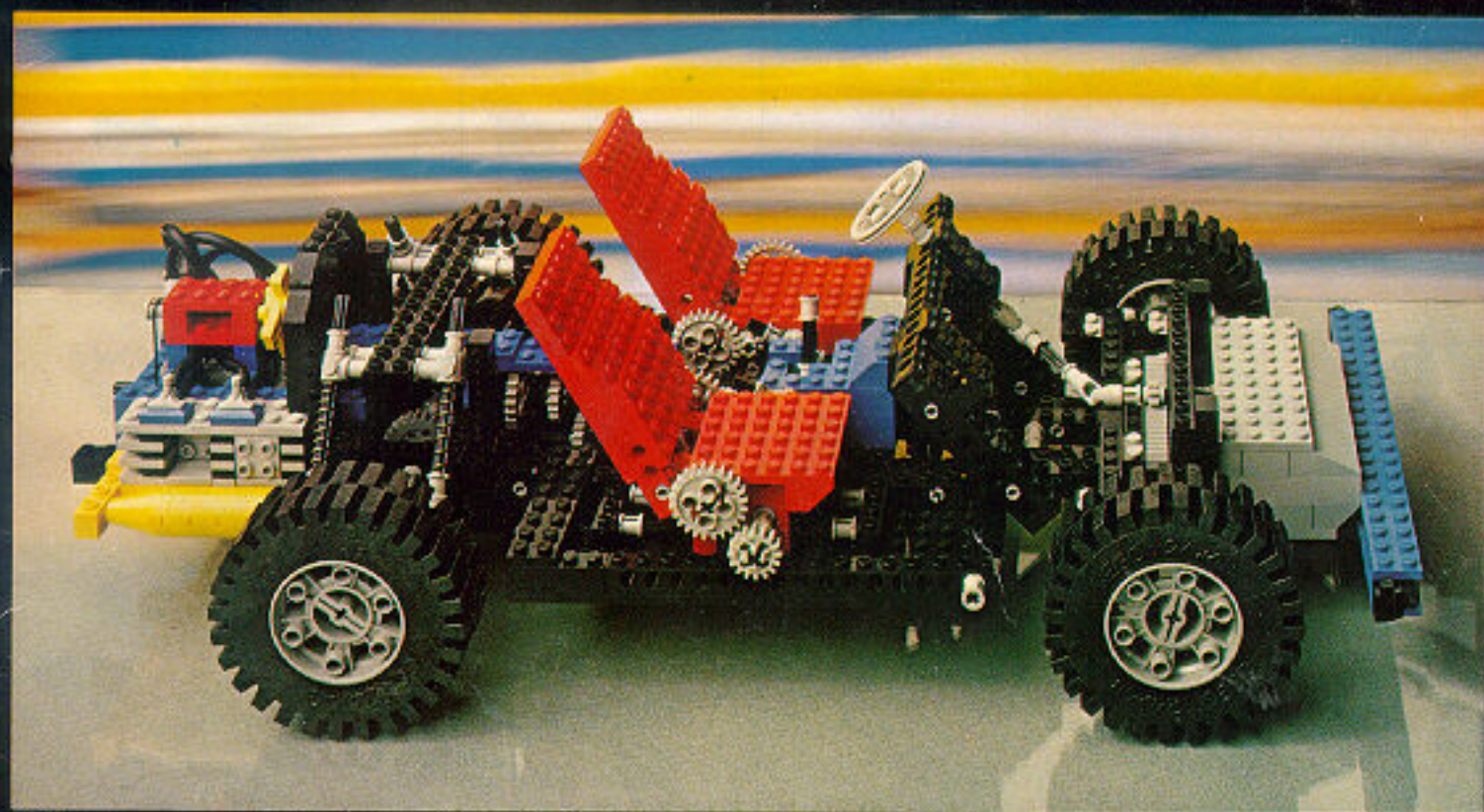

420162

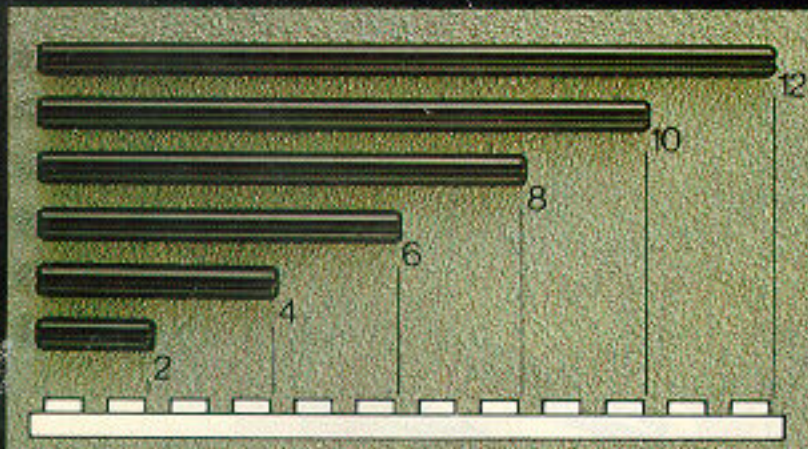
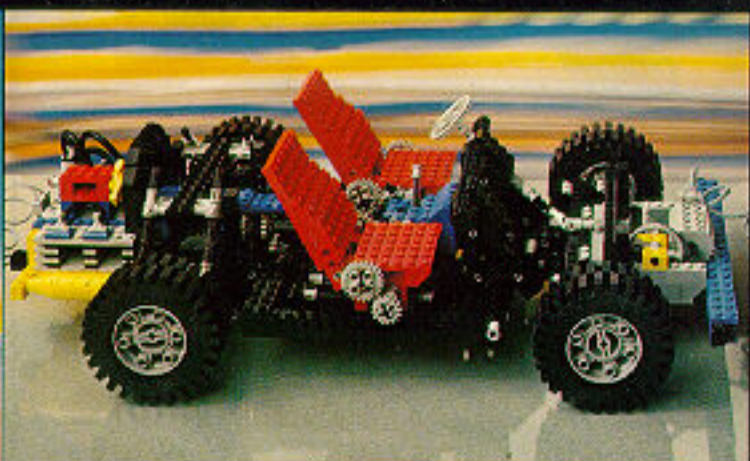

Los números que van al lado de los ejes en las instrucciones de montaje significan el largo del eje que debe utilizarse.

In der Bauanleitung steht vor den Achsen eine Zahl, die die benötigte Länge der Achsen anzeigt.

Numbers in the building instructions near axles show the length of axle to be used.

Dans les conseils de construction, il y a un chiffre à côté de chaque axe. Ce chiffre indique la longueur des axes à utiliser.

Ut for akslerne i byggeanvisningen er anført et tal, som viser hvilken aksellengde som skal brukes.

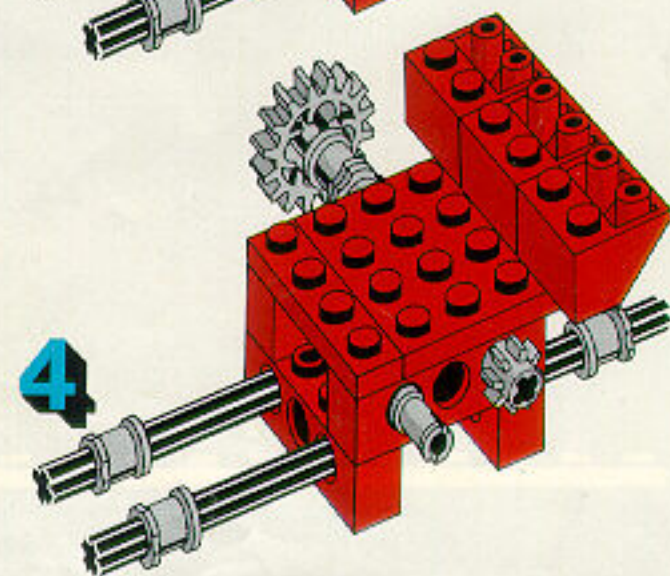
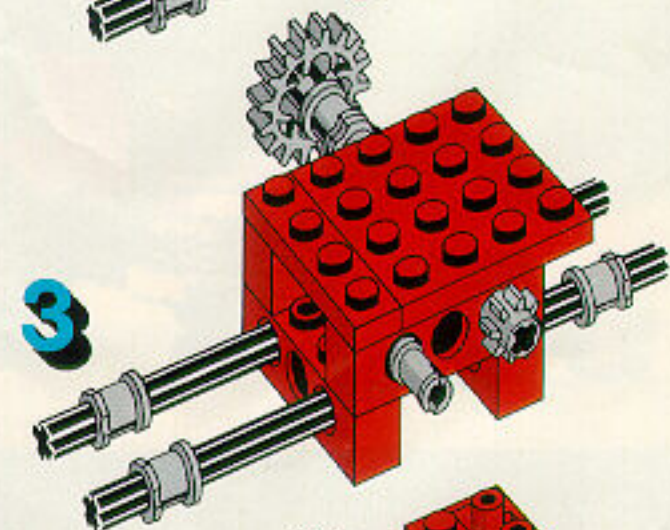
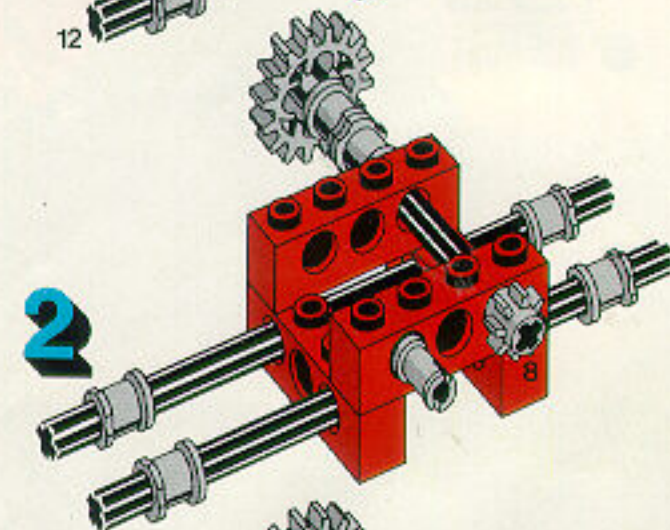
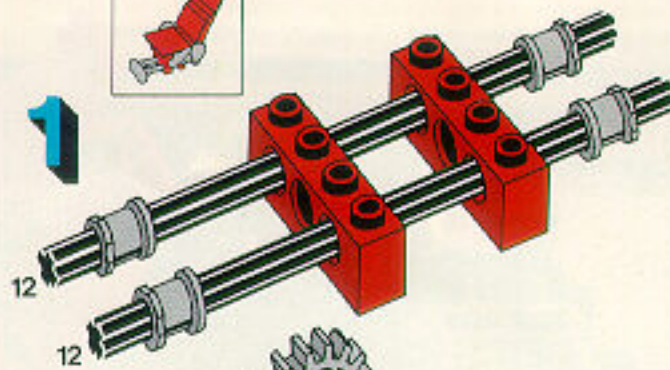
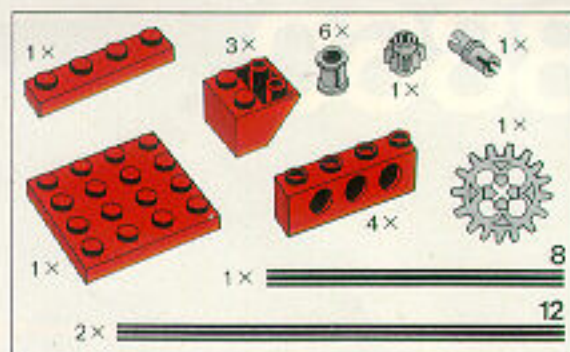
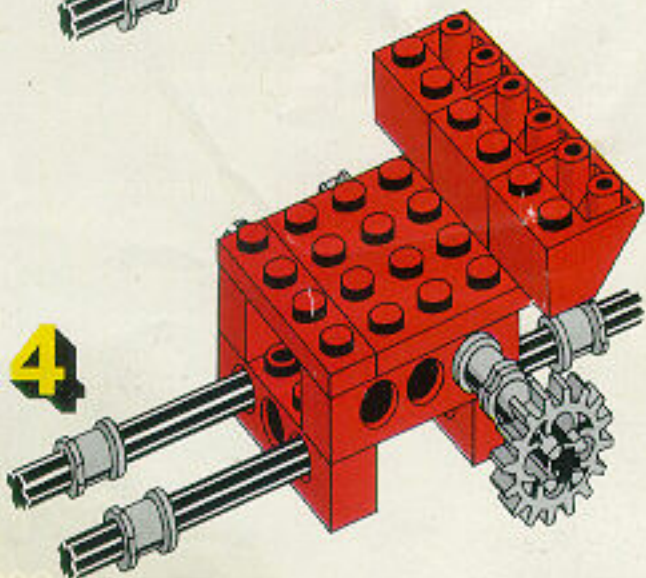
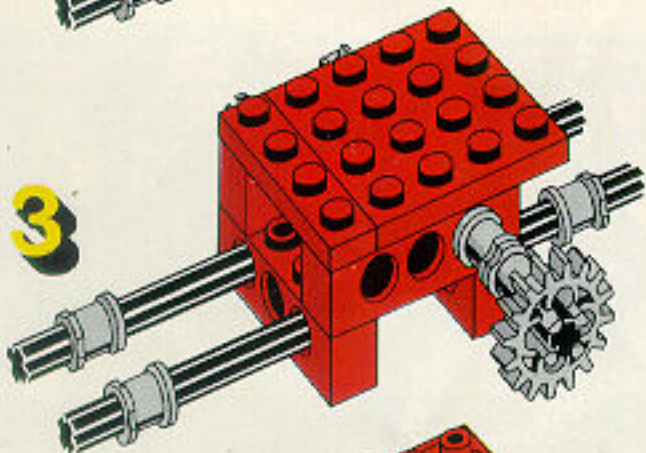
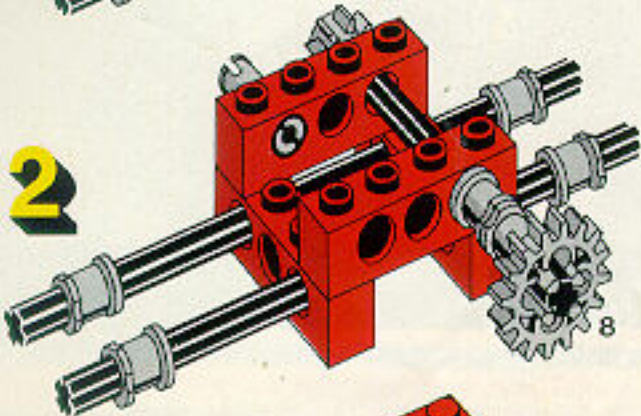
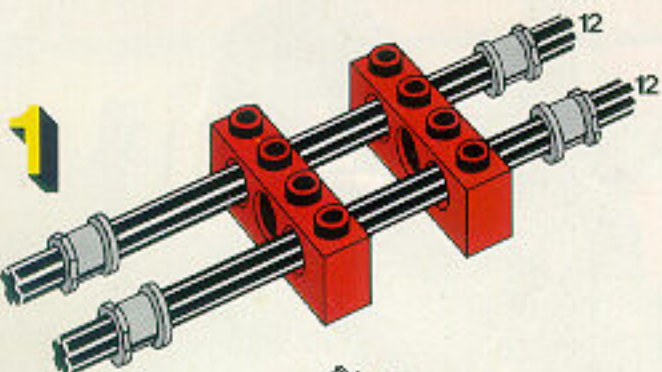
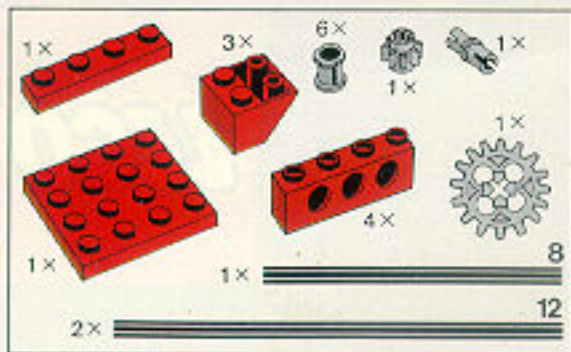

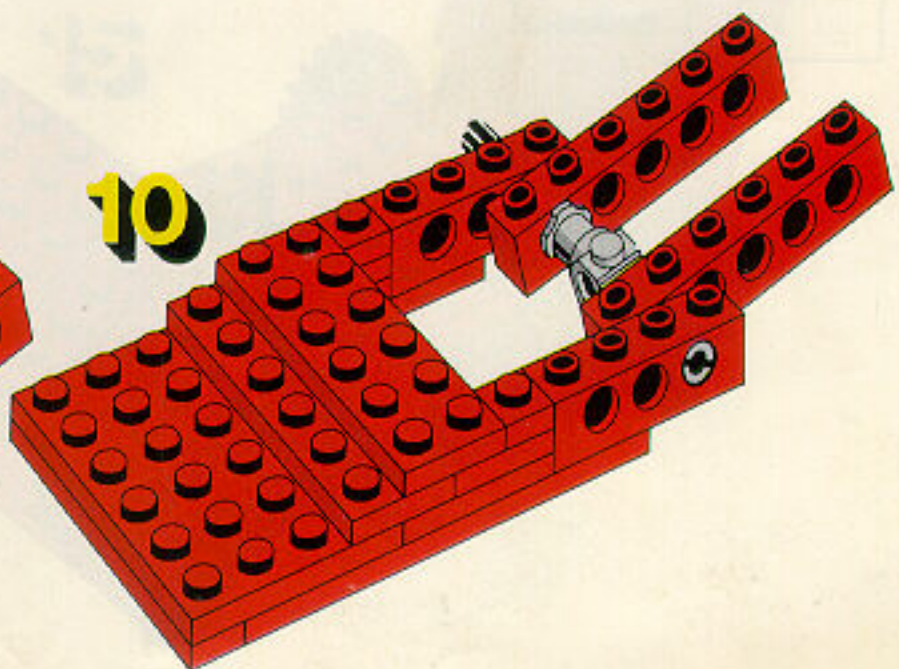
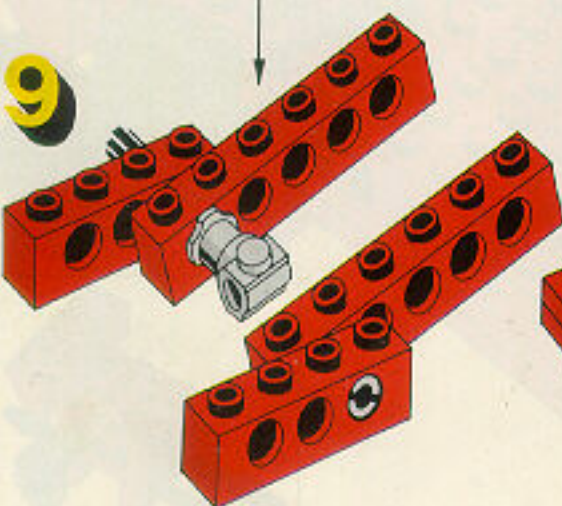
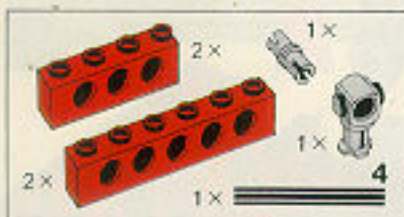
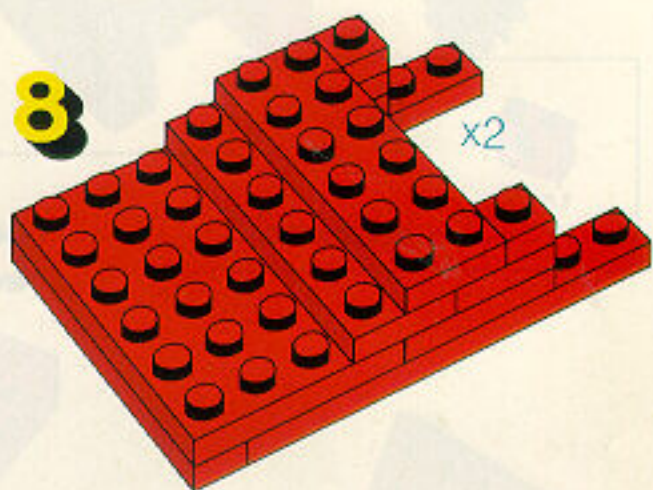
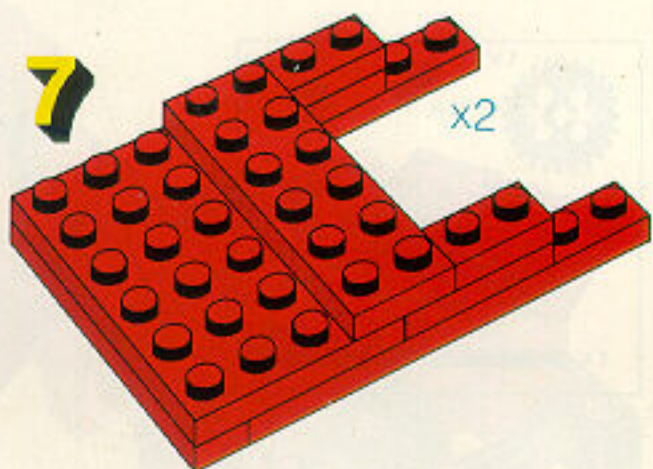
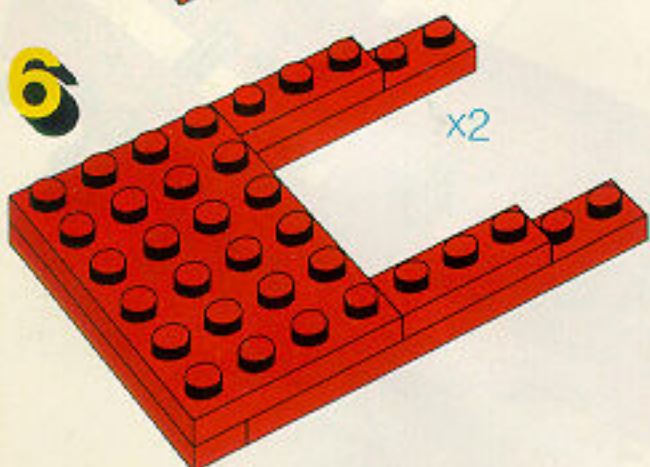
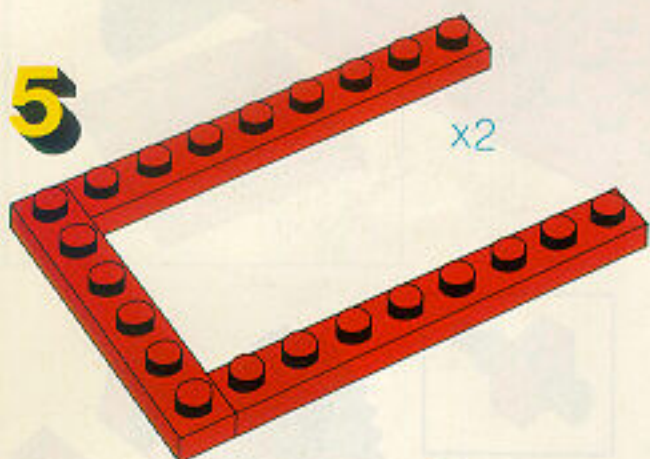
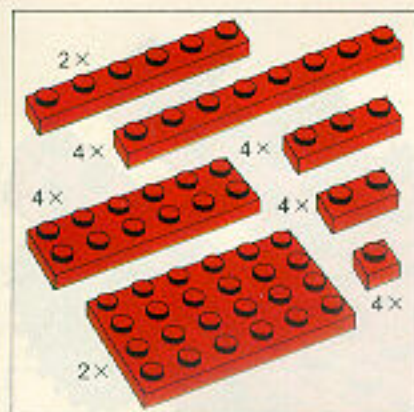

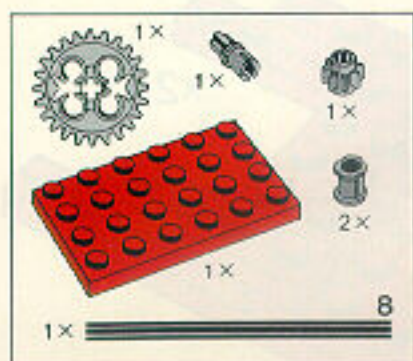

11

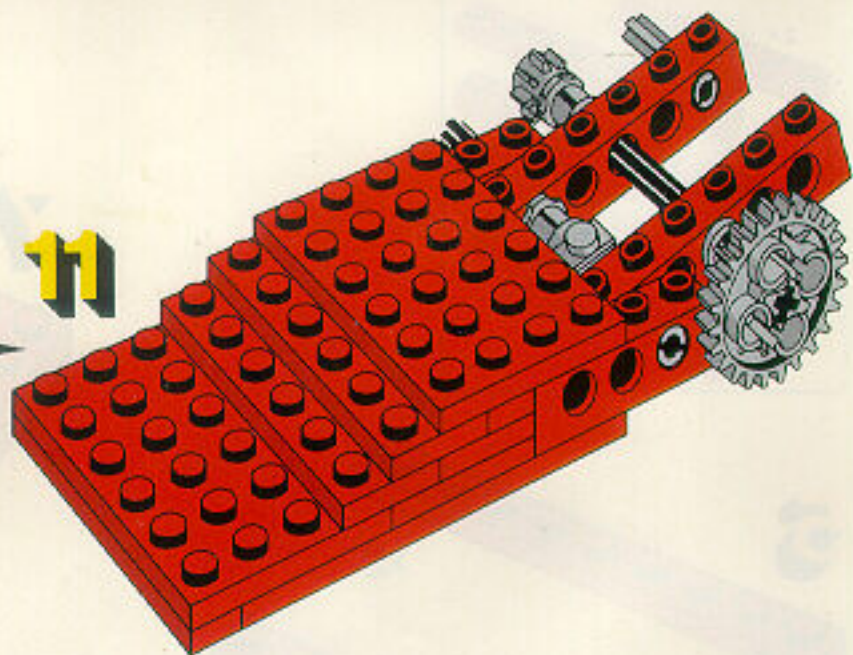

12

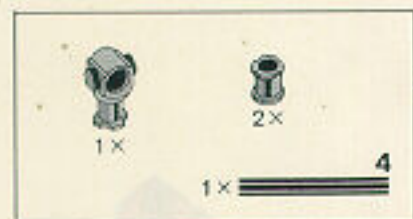
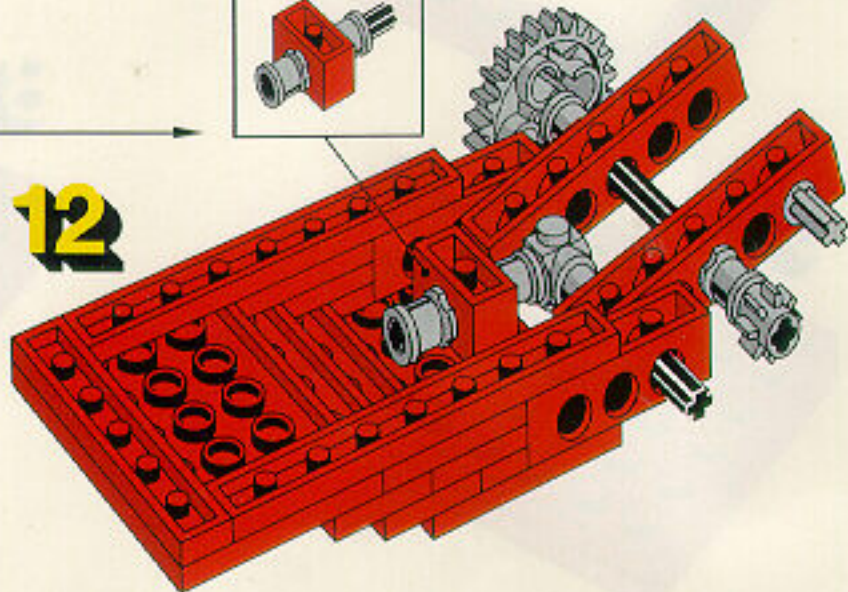

13

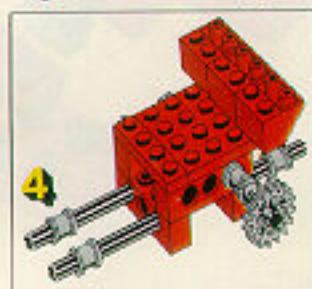
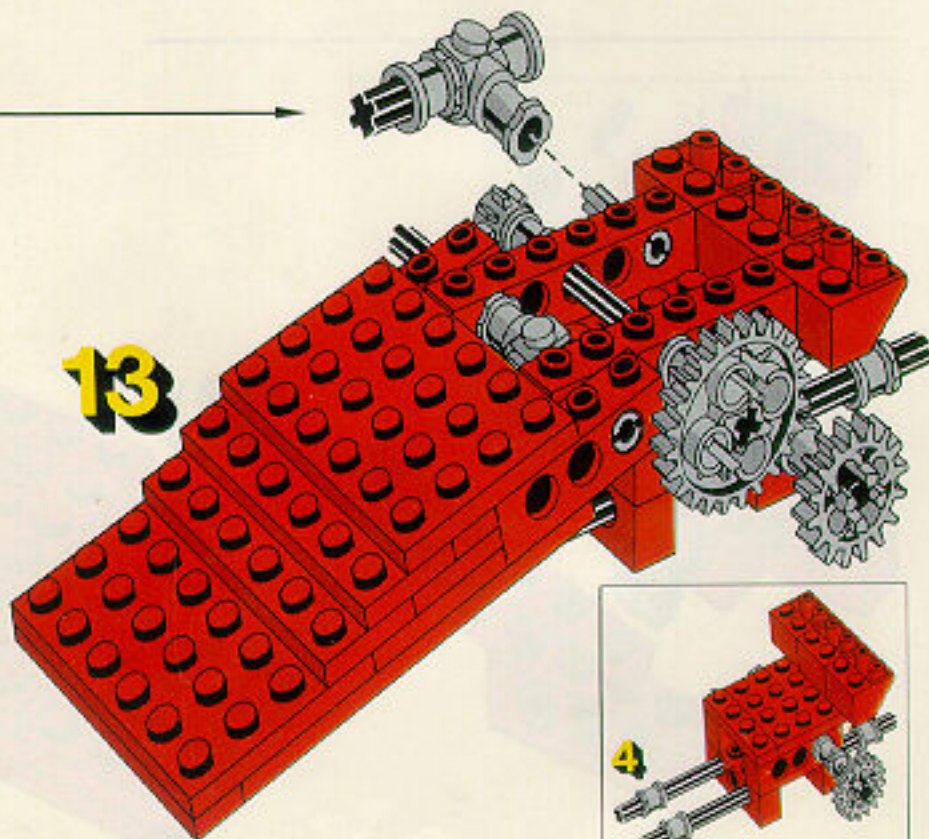
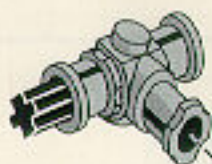

14

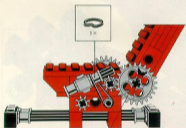
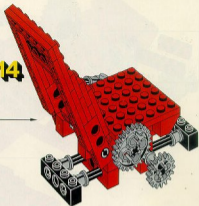

15

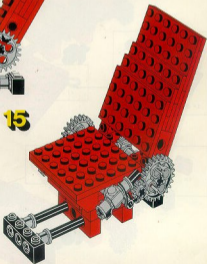

16

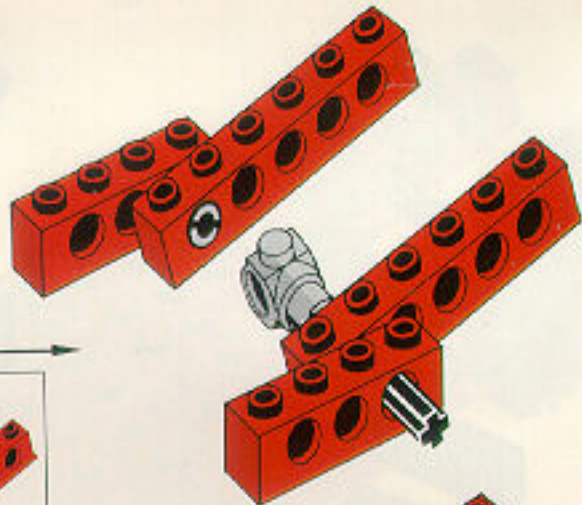
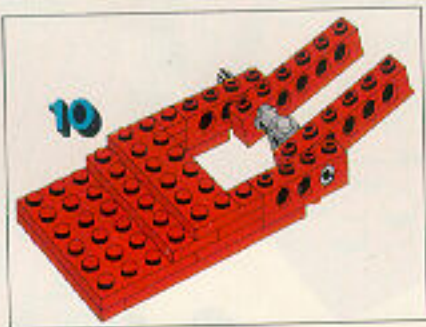
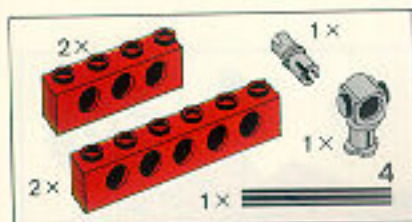

17

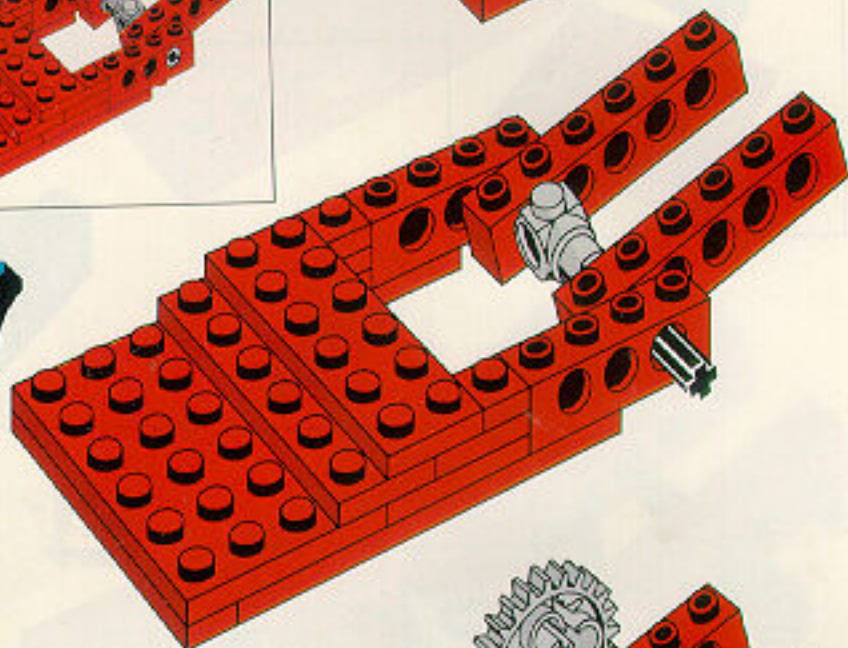

18

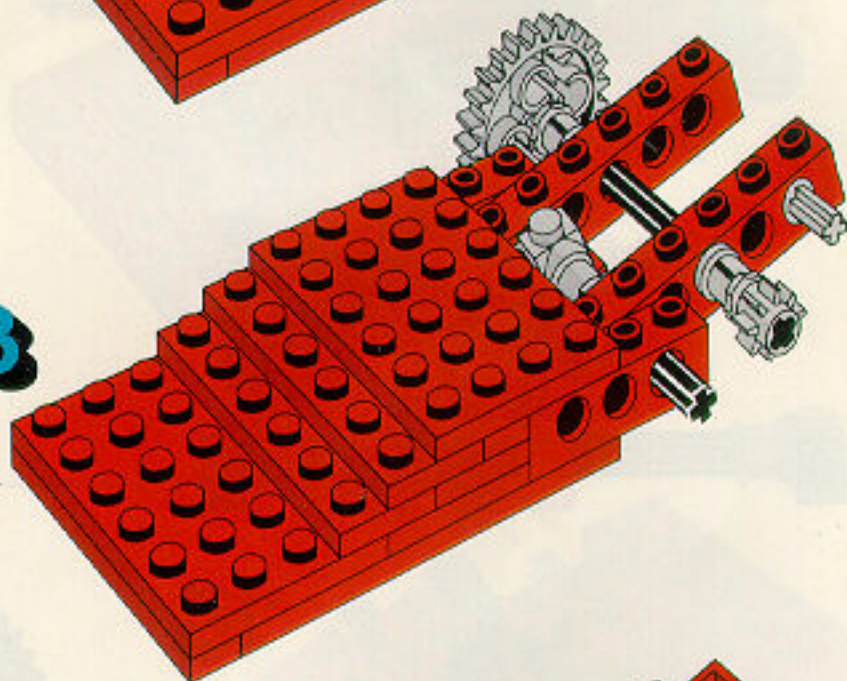
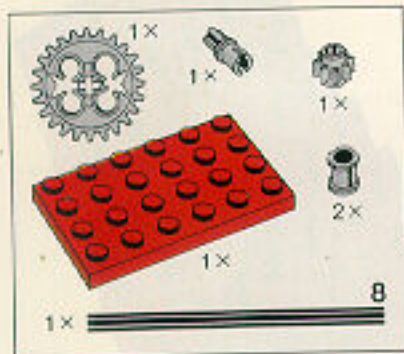

19

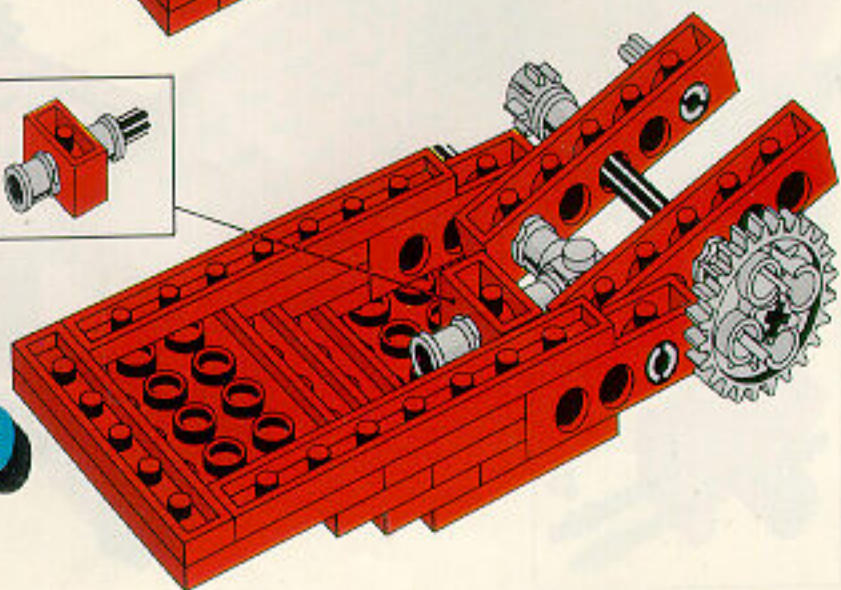



1

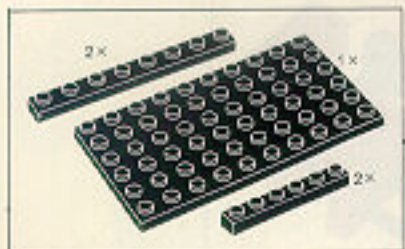

2

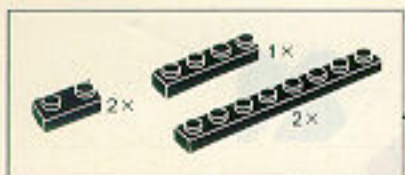
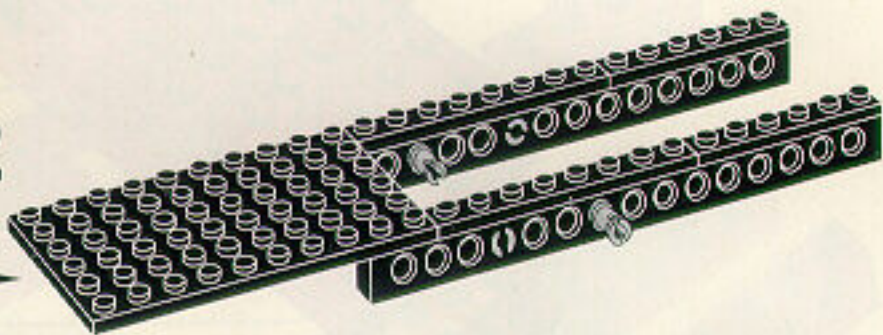

3

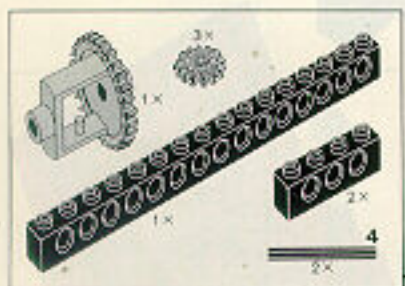
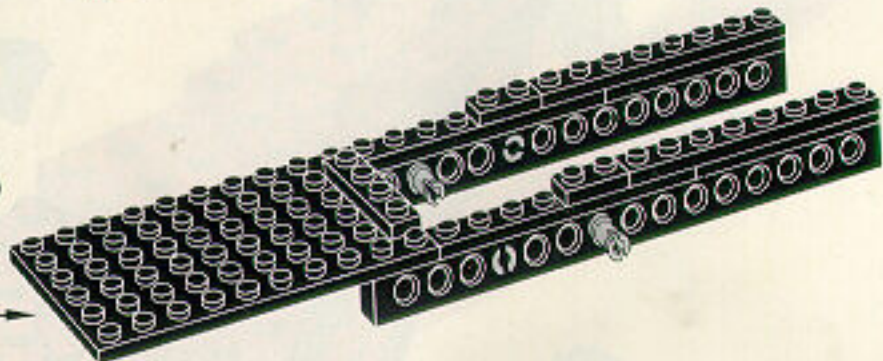

4

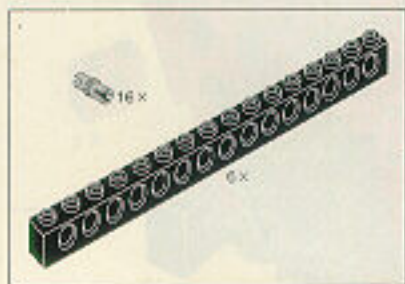
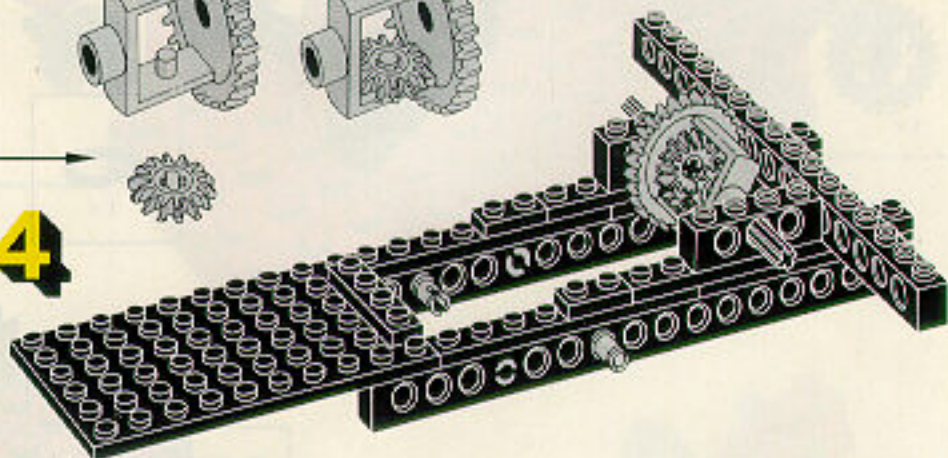
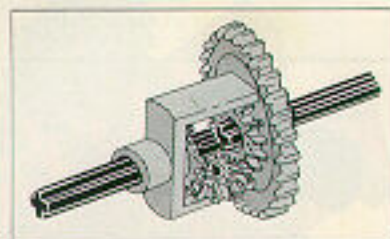
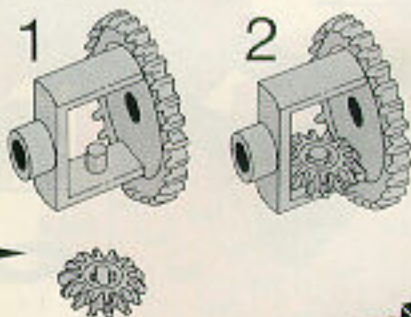

5

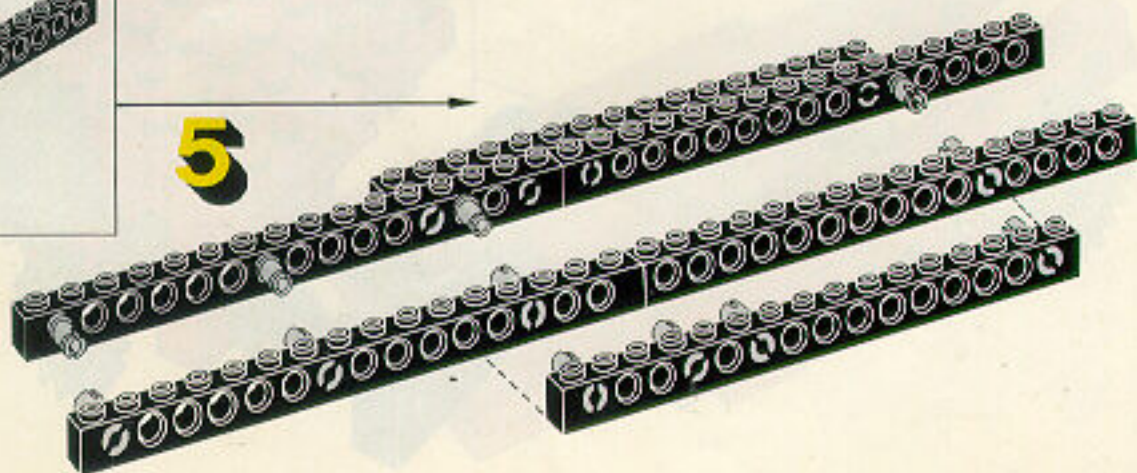

6

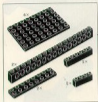
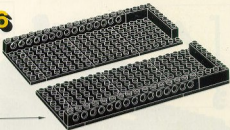

7

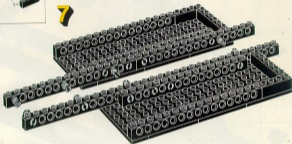

8

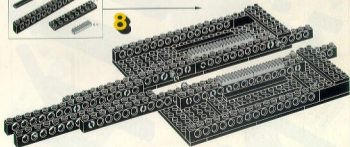

9

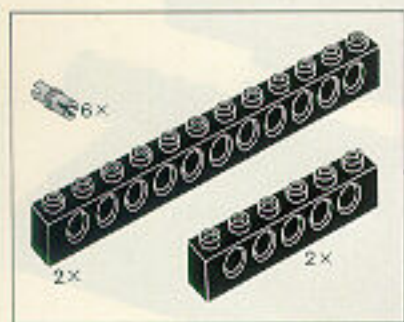
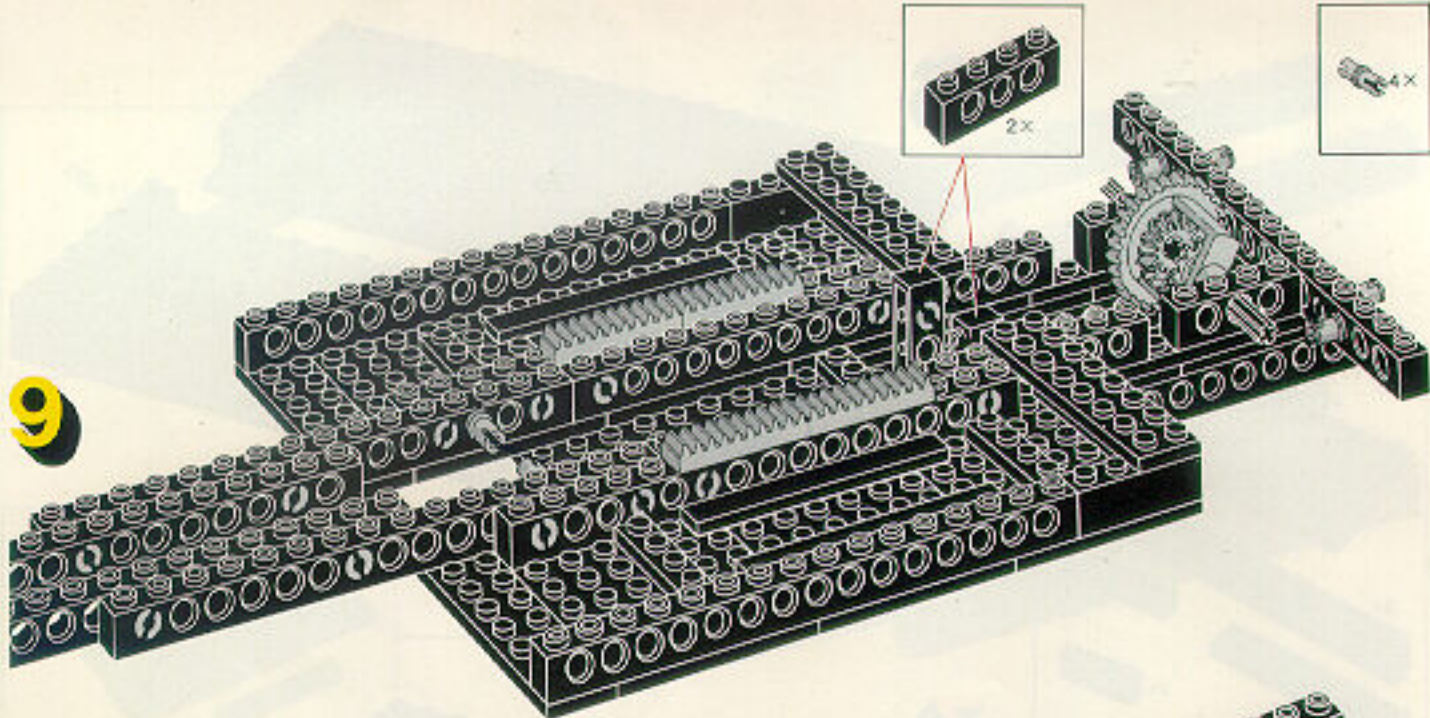

1

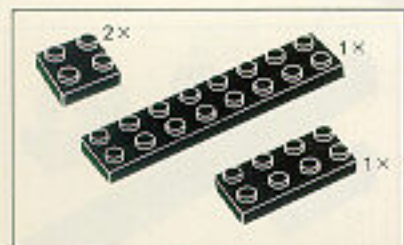

2

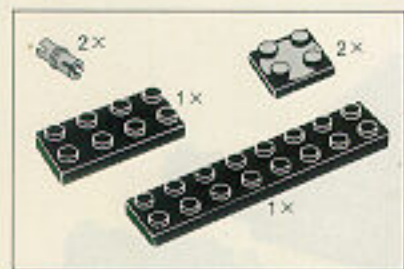
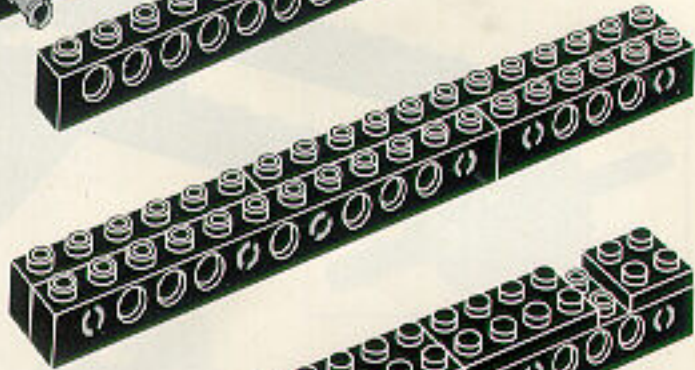

3

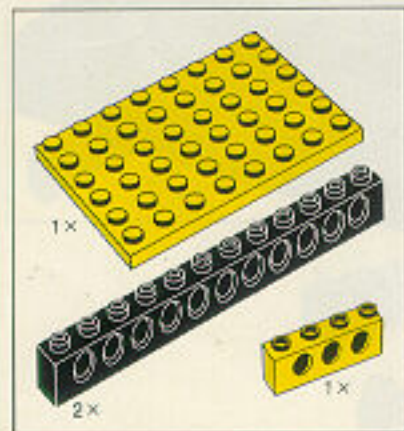
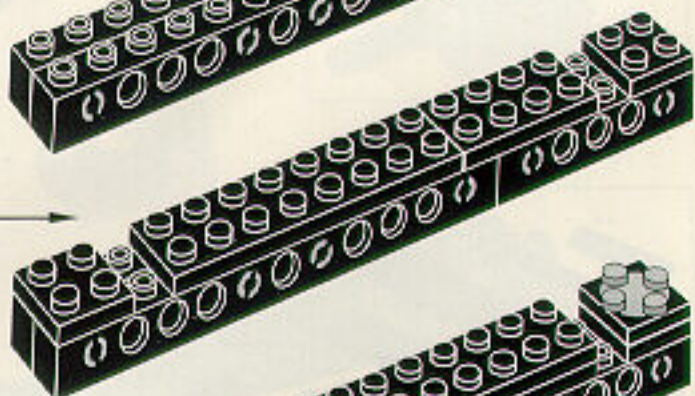

4

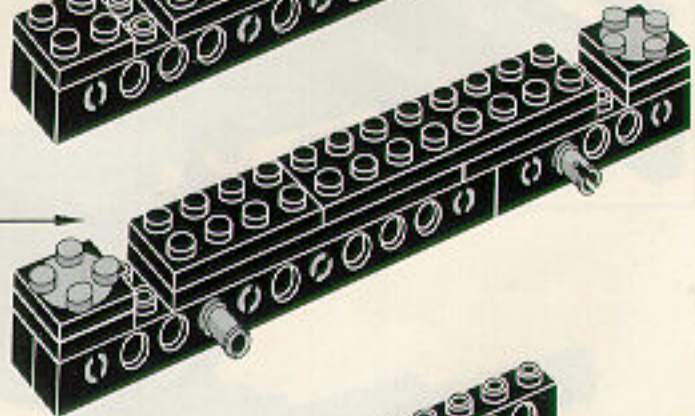

5

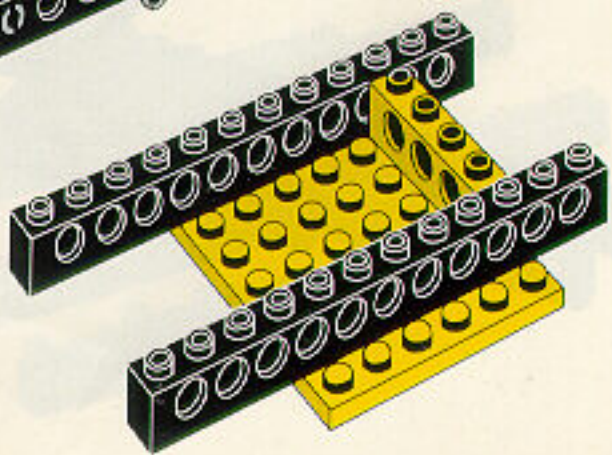

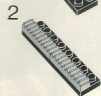
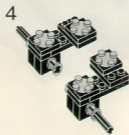
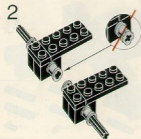
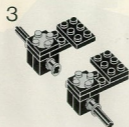
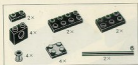

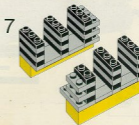
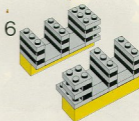
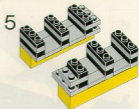
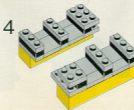
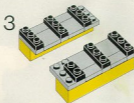
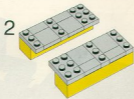
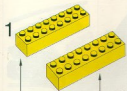

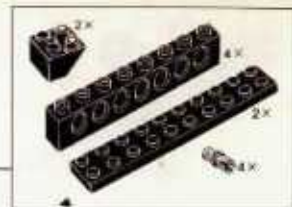
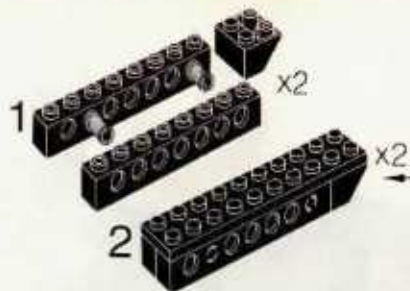
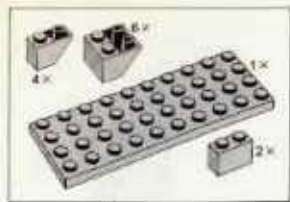

18

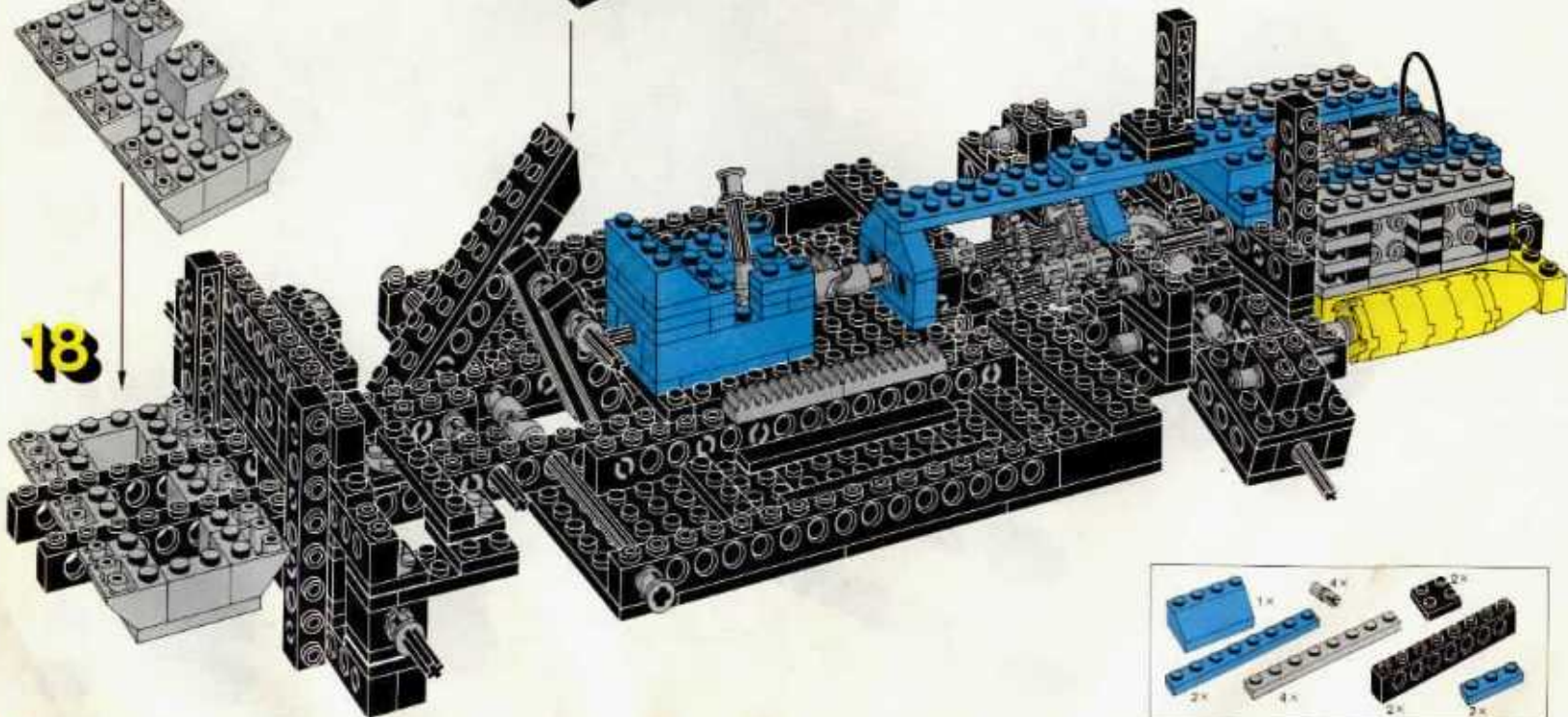

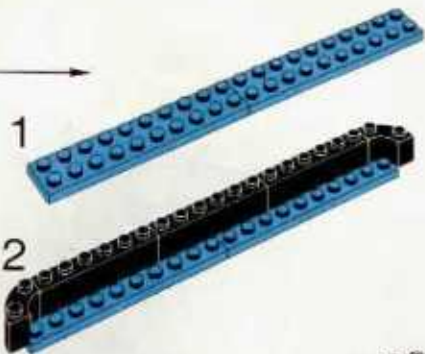

19

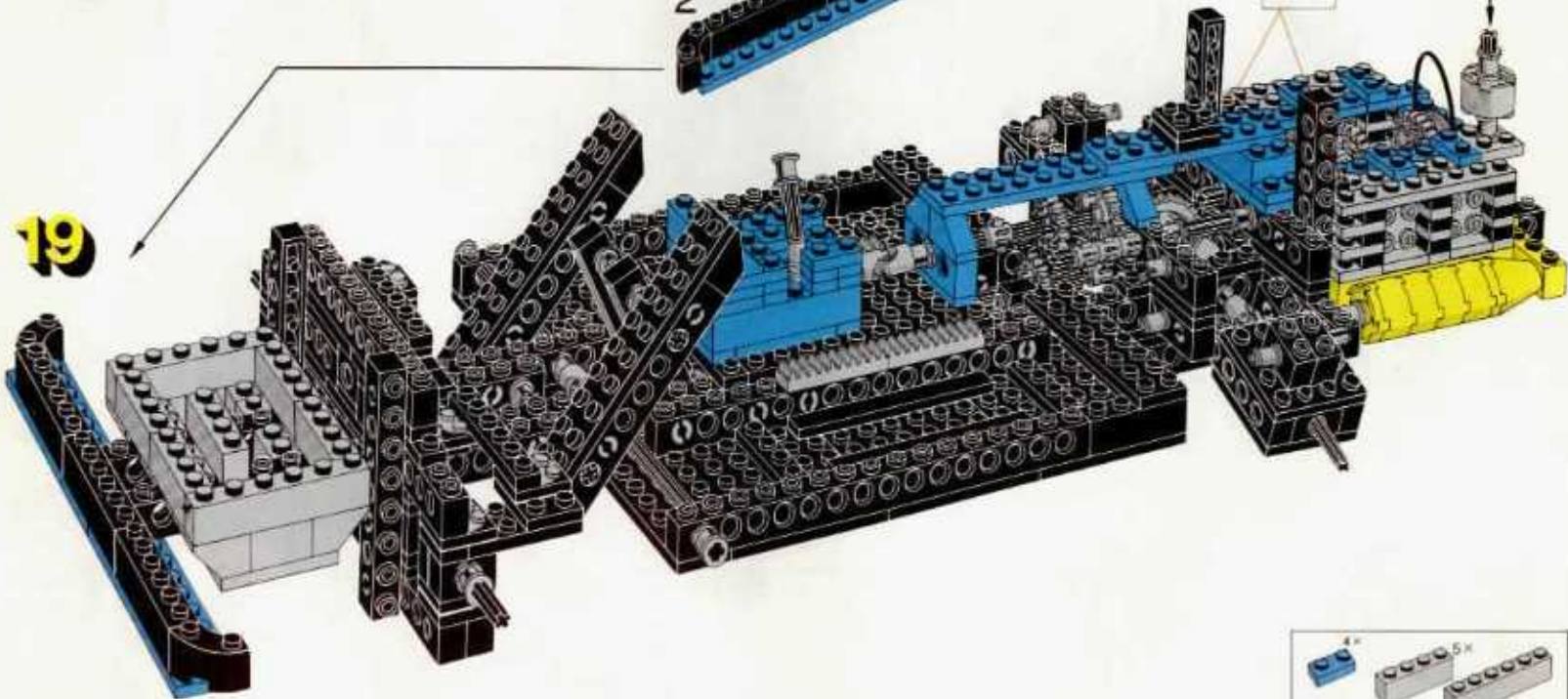

1

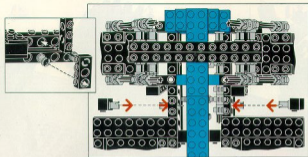

2

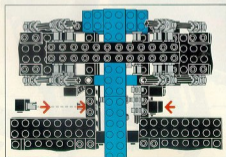

3

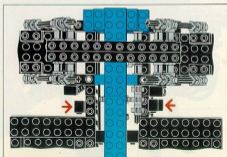

22

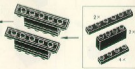
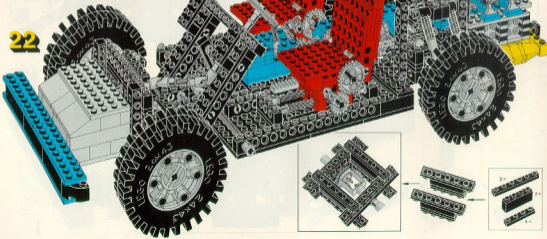
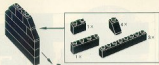

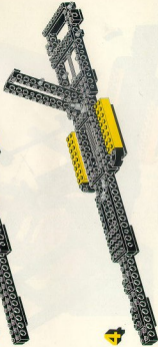
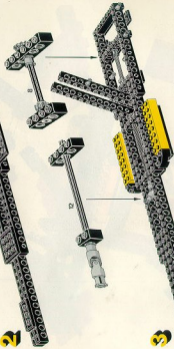

5

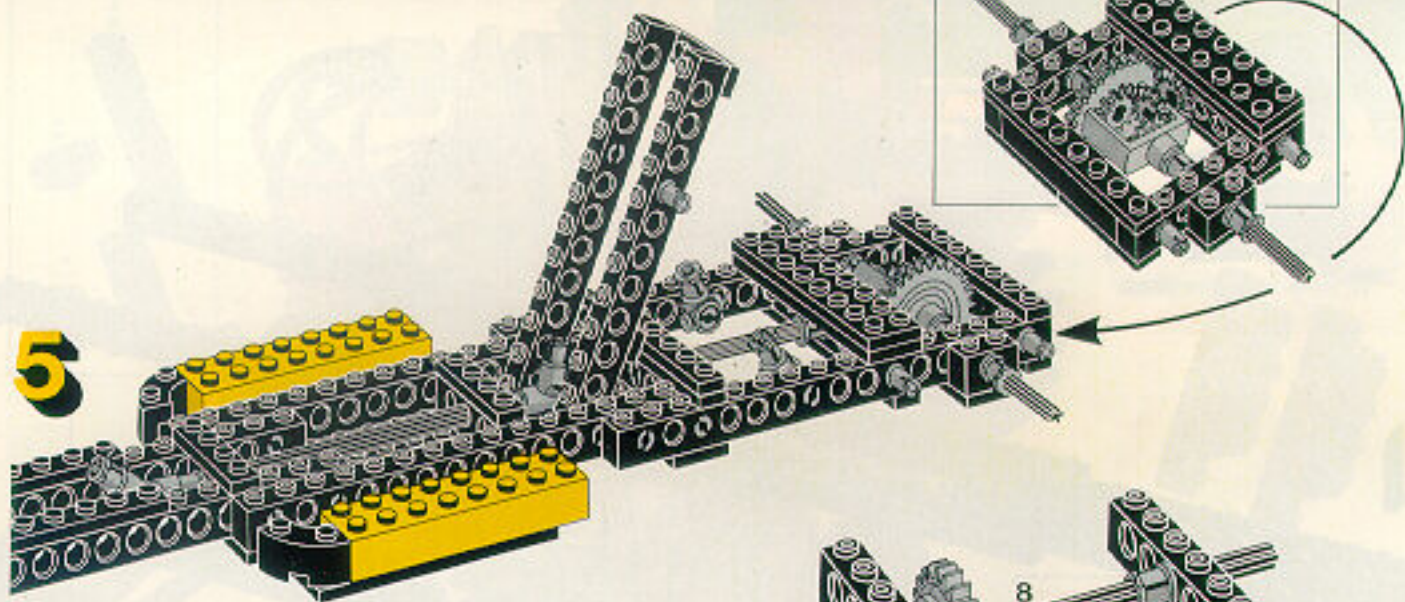

6

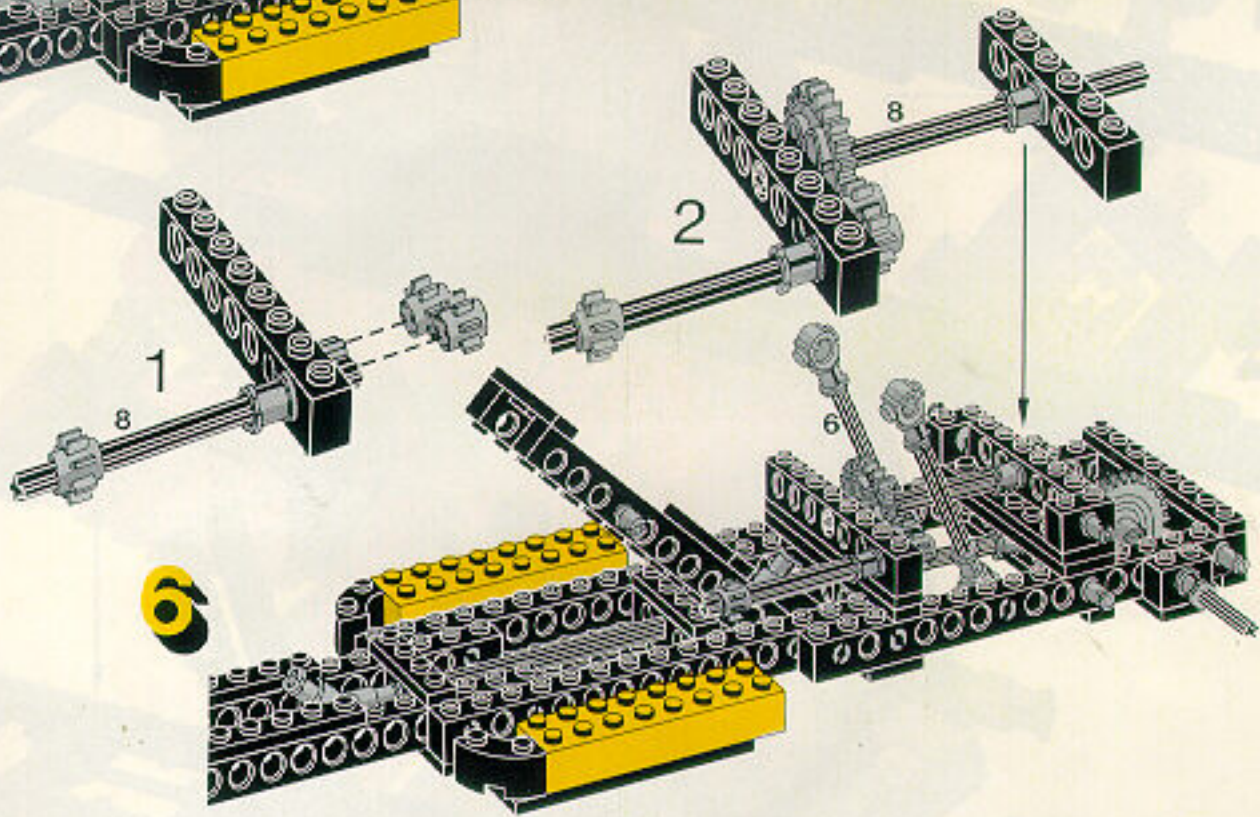

7

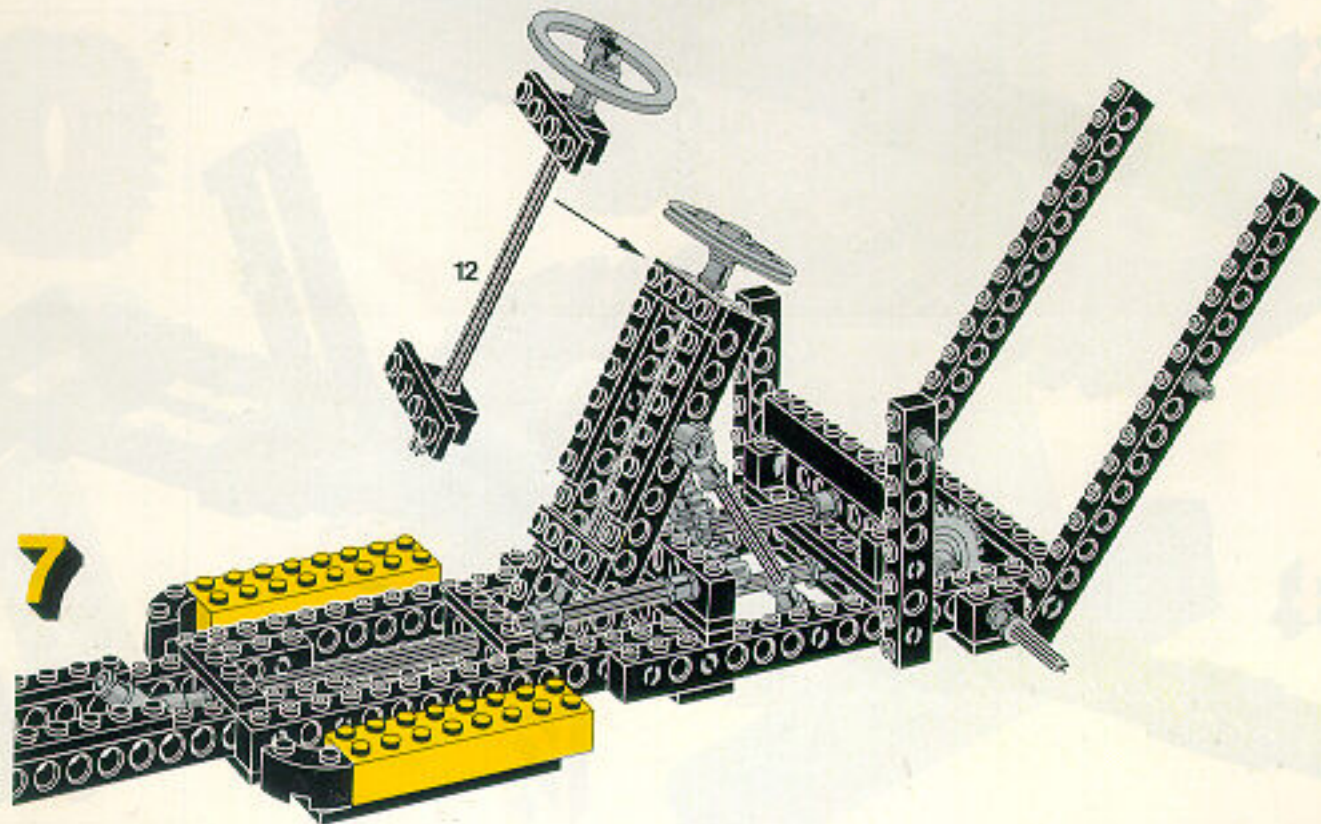

8

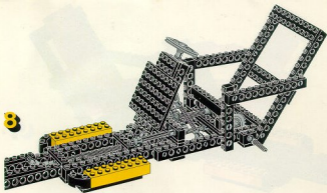

1



2



3

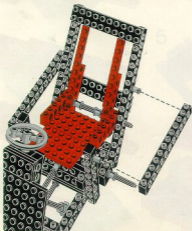

9

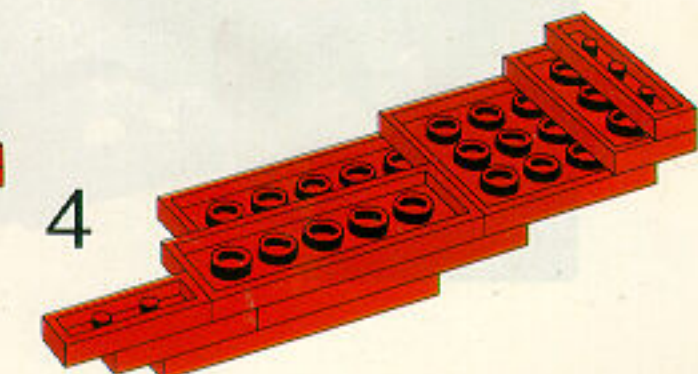
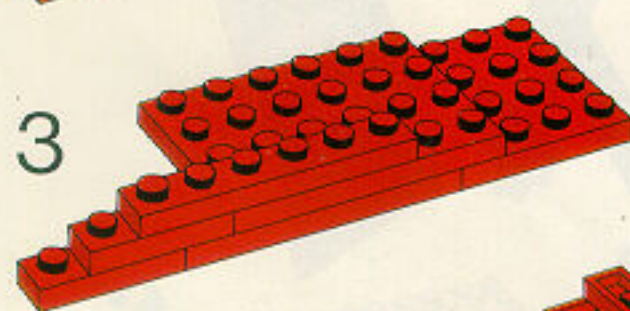
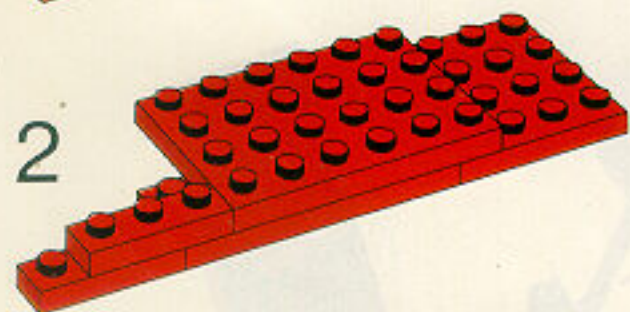
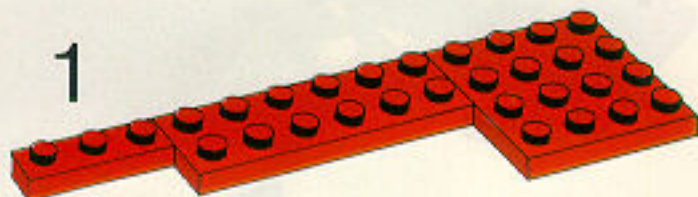
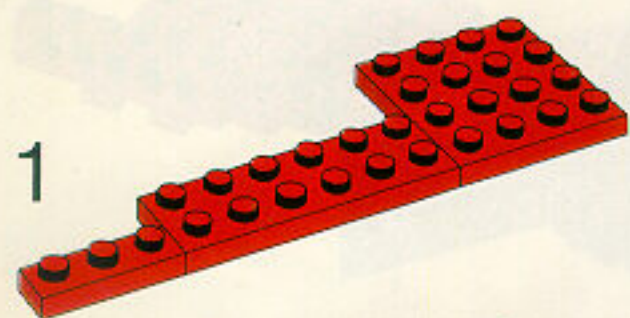
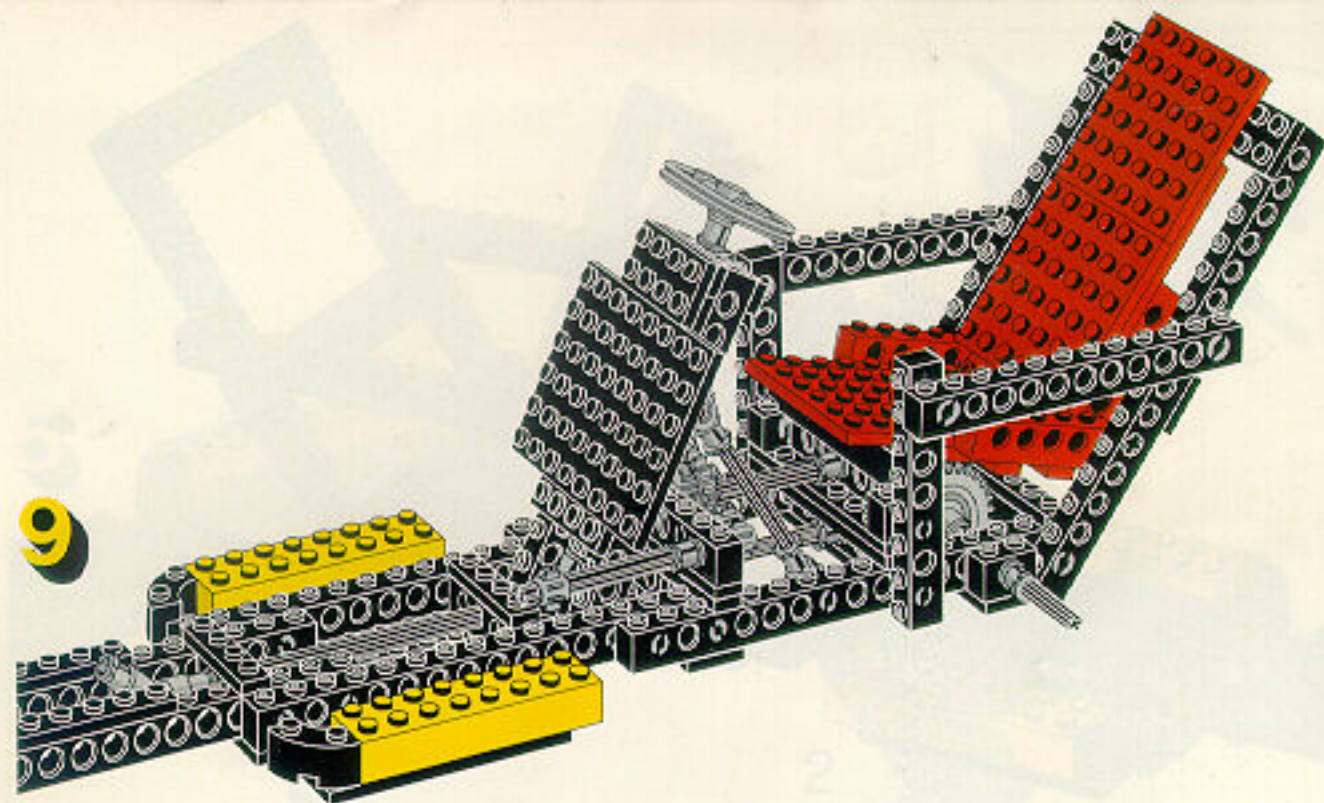

10

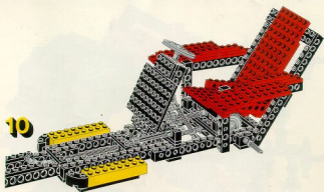

1

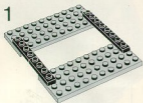

4

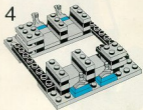

2

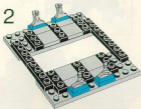

5

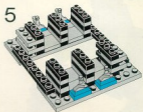

3

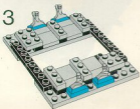

6



7

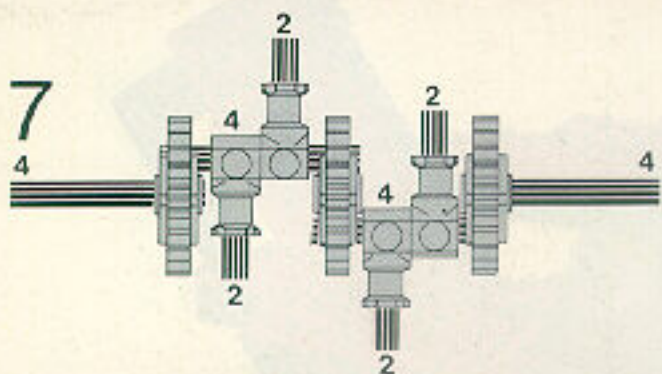

8

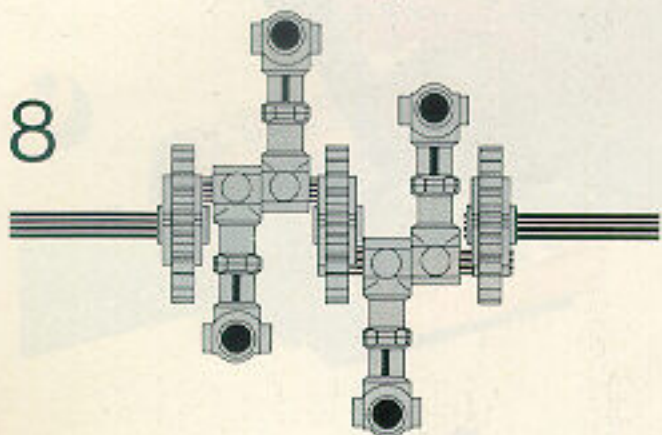

9

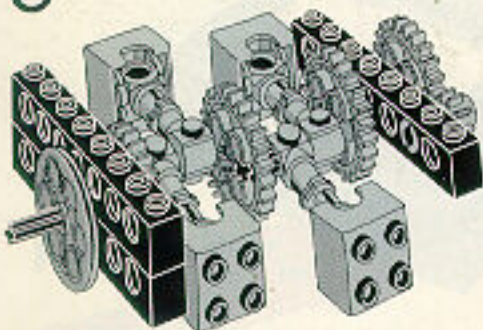

10

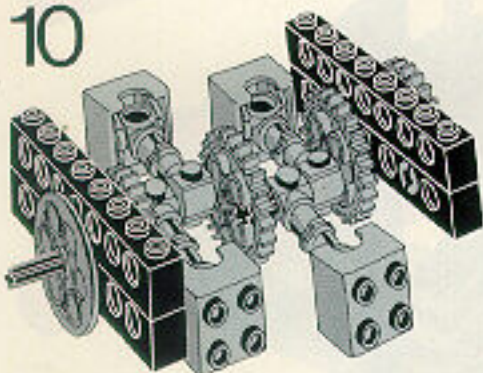

11

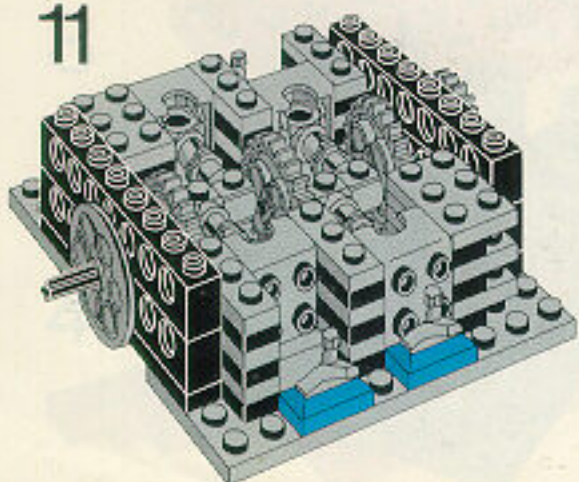

12

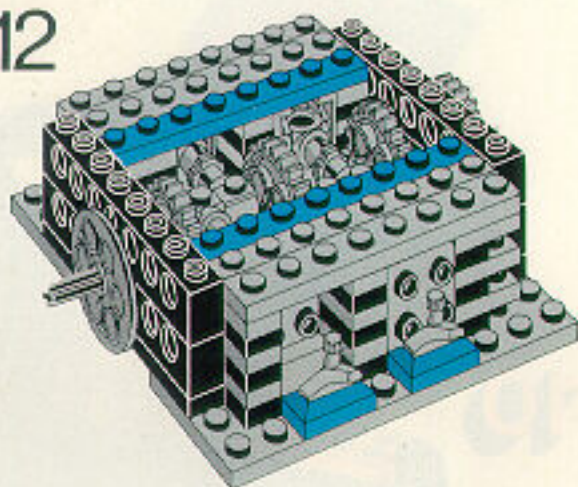

13

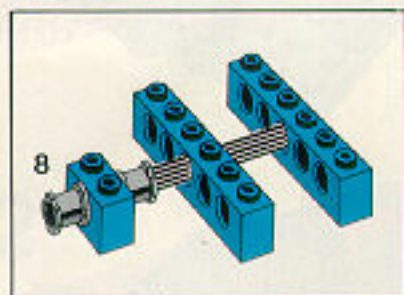
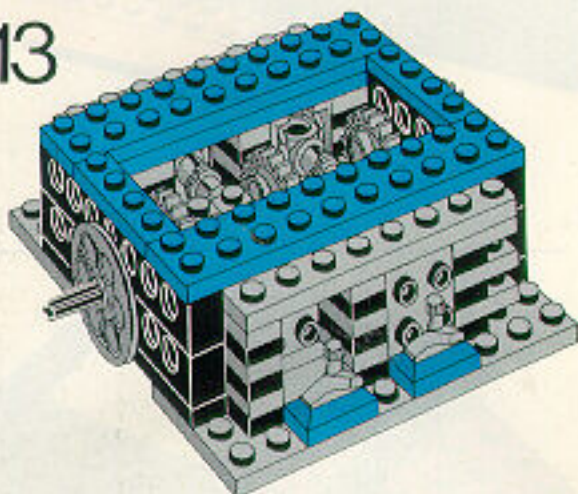

14

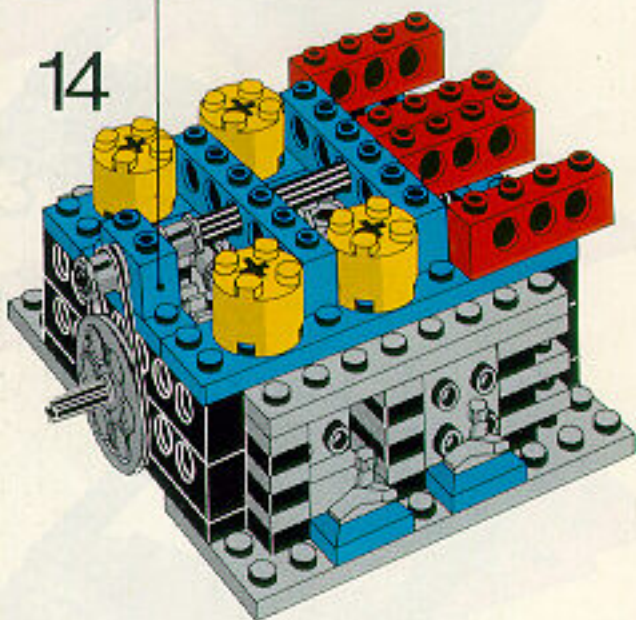

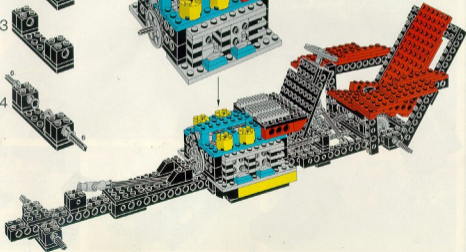
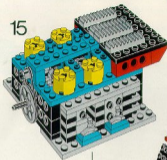

11



12

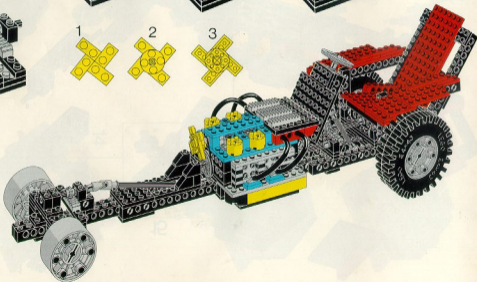

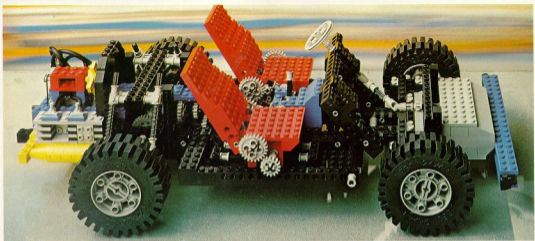

Art. No. 870

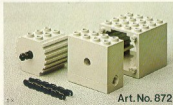

Art. No. 872



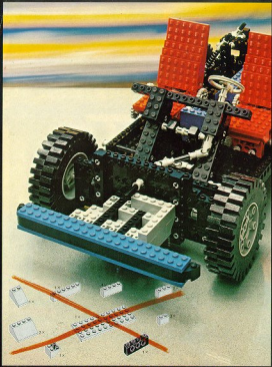



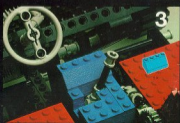
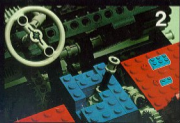
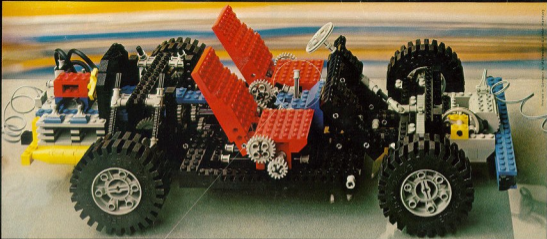

LEGO[®]

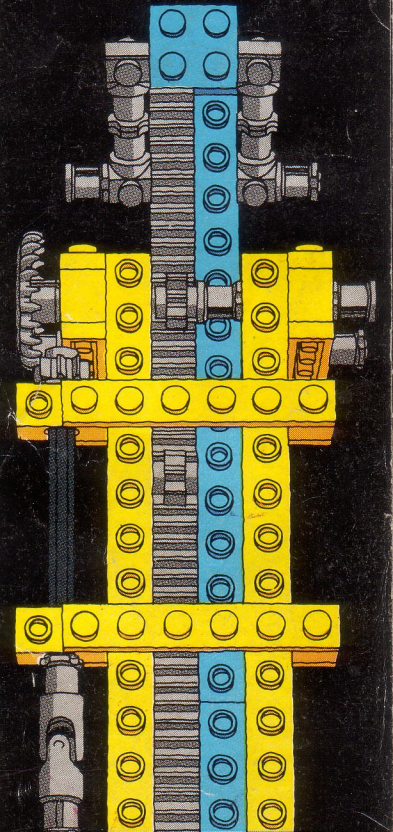
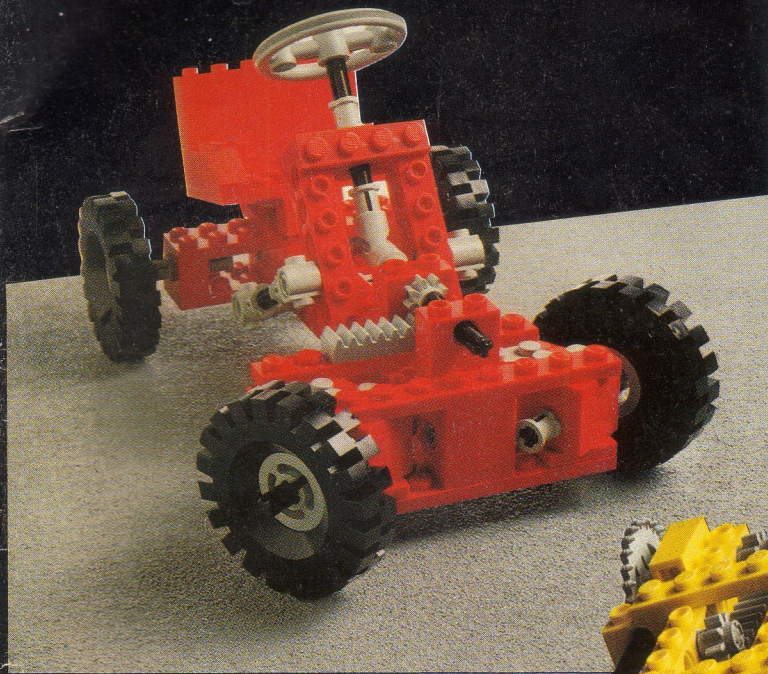



Dette hæfte giver ideer til en masse spændende modeller, som du kan bygge af LEGO teknik programmet. På de første sider er vist principper for byggeri med de mange nye elementer. Der er også anvendt elementer, som ikke hører til denne æske, men som findes i andre teknikæsker. I midten af hæftet (på siderne med stribet kant) er der detaljeret vejledning til modeller, der kan bygges udelukkende af denne æske. På de sidste sider gives ideer til større modeller, som du kan bygge, hvis du kombinerer forskellige teknikæsker. I øvrigt kan du altid finde inspiration ved at kigge på billederne på emballagen.

Byggetips:
Det er vigtigt at følge byggevejledningen nøje. Hvis der er noget, som du synes er vanskeligt at forstå, kan det tit hjælpe at kigge på de efterfølgende sektioner. F.eks. hvis du har svært ved at se, hvor et bestemt element skal placeres. For at sikre, at modellerne fungerer perfekt, bør alle bevægelige dele - som f. eks. tandhjul og aksler - justeres, så de løber let og ubesværet.



This booklet gives ideas for a number of interesting models you can build from LEGO Technical Sets. The first pages show basic building principles for the whole range of new components, not all of which are necessarily included in this particular set. The model pages (with striped edges) give detailed construction designs for models which can be built from this set. On the last pages are ideas for bigger models built from a combination of various Technical Sets. Still more models are shown on the box itself to suggest ideas for models of your own design, for it is the ones you work out on your own which are always the most satisfying!

Building Hints:
It is important to follow the building instructions exactly. If something seems difficult to understand, it often helps to look forward to the next stage. To ensure that the models work smoothly, the gear wheels and axles must be adjusted so that they run freely and easily with minimum friction.



Detta häfte ger idéer till spännande modeller, som Du kan bygga av LEGO's tekniska program. På första sidan visar vi hur man bygger med de nya elementen. Här visar vi också element, som inte finns i denna ask utan i andra Teknik askar. I mitten av häftet finner Du detaljerade byggvägledning till modeller som Du kan bygga med denna ask. På sista sidan visar vi större modeller, som Du kan bygga om Du kombinerar olika Teknik askar. Du kan också få idéer till spännande modeller om Du studerar de olika askarnas emballage.

Byggtips:
Det är viktigt att Du följer byggvägledningen noga. Om det är något som Du har svårt att förstå, kan det hjälpa att titta på efterföljande sektioner. T. ex. om Du har svårt att se, hur ett visst element skall placeras. För att vara säkra på att modellerna fungerar perfekt, bör alla rörliga delar - som t. ex. kugghjul och axlar - justeras så de löper lätt och ledigt.



Dette hefte gir idéer til en masse spennende modeller som du kan bygge av LEGO's tekniske program. På de første sidene er det vist forskjellige prinsipper for bygging med de nye elementene. Der er det også brukt elementer som ikke er med i denne esken, men som finnes i andre Teknisk-esker. I midten av heftet (på sidene med stripet kant) er det detaljert beskrivelse til modeller som bare kan bygges av denne esken. På de siste sidene gis idéer til større modeller som du kan bygge, hvis du kombinerer forskjellige Teknisk-esker. Du kan også få idéer til egne, spennende modeller fra bildene på eskene.

Byggetips:
Det er viktig at du følger byggeveiledningen nøye. Hvis noe er vanskelig å forstå, for eksempel hvordan et bestemt element skal sitte, kan det ofte hjelpe å se litt lenger frem i byggeveiledningen. Når modellen er ferdig, må du kontrollere at alle bevegelige deler, som tannhjul og aksler, løper lett og uhemmet.



Tämä vihkonen sisältää ideoita, joiden mukaan voit rakentaa monta jännittävää mallia LEGO Tekniikka sarjasta. Rakentamisen pääperiaatteet uusien osien hyväksikäyttämisen selviävät ensimmäisillä sivuilla. Malleissa on myös käytetty osia, jotka eivät sisälly tähän rasiaan, mutta joita löydät toisista Tekniikkasarjan rasioista. Vihkosen keskiosasta löydät seikkaperäiset piirustukset niistä malleista, joita voidaan rakentaa ainoastaan tämän rasian sisällöstä. Viimeisillä sivuilla annetaan ideoita suurien mallien rakentamiseen, yhdistämällä erilaisia Tekniikka-rasioita. Muutoin voit aina löytää lisäinnostusta vilkaisemalla rasiassa olevia kuvia.

Rakennusvihjeitä:
On Tärkeää seurata tarkoin rakennusohjetta. Jos jokin vaihe näyttää vaikealta, katso seuraavaa kuvaa. Ehkä Sinun silloin on helpompi nähdä, mihin esim. jokin tietty elementti on tarkoitettu sijoittaa. Mallit toimivat täydellisesti, jos säädät kaikki liikkuvat osat, esim. hammaspyörät ja akselit, niin, että ne pääsevät pyörimään kevyesti ja vapaasti.



Questo libretto contiene alcuni suggerimenti per la costruzione di fantastici modelli della serie tecnica. Le prime pagine illustrano l'utilizzo di tutti i nuovi elementi compresi quelli non contenuti in questa particolare confezione. Al centro (sulle pagine con il bordo contrassegnato), vi sono dettagliate istruzioni per la costruzione di modelli utilizzando esclusivamente i pezzi contenuti in questa scatola. Le ultime pagine contengono le istruzioni per costruire grossi modelli combinando le varie confezioni. Inoltre, le illustrazioni della scatola vi suggeriranno tante altre idee.

Suggerimenti:
E' importante seguire con attenzione le istruzioni di montaggio. Se avete delle difficoltà, ad esempio nel sistemare un particolare elemento, aiutatevi guardando la fase successiva. Per ottenere una perfetta funzionalità del modello assicuratevi di aver sistemato in modo appropriato i vari ingranaggi, giunti e boccole.

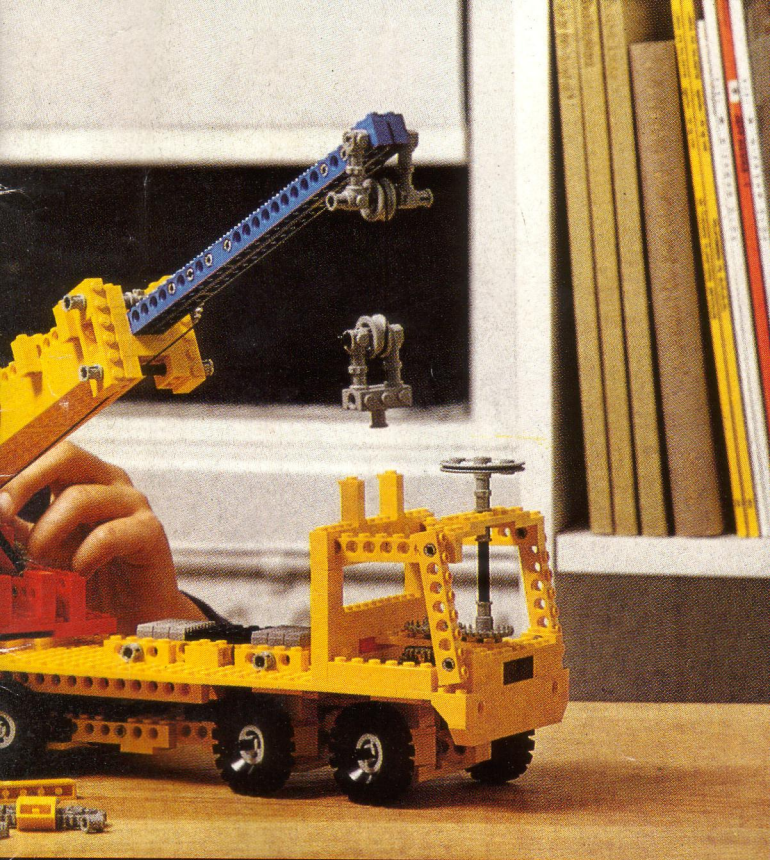

Dit boekje draagt ideeën aan om je verder op weg te helpen met materiaal uit de technische serie dozen van LEGO.

De eerste pagina's tonen je de verschillende elementen die in deze en/of andere dozen kunnen voorkomen.

De bladzijden met gestreepte randen laten je stap voor stap zien hoe je met het materiaal uit deze doos meerdere dingen kunt maken.

Tenslotte zie je suggesties voor grotere modellen waarvoor ook onderdelen gebruikt zijn uit andere technische dozen van LEGO.

En de plaatjes op de doos zelf inspireren je misschien weer tot geheel nieuwe eigen bedenksels.

Bouw tips:

Bekijk voor en tijdens het bouwen van een model nauwkeurig en stuk voor stuk de plaatjes van de bouwvoorwaarden goed.

Als je iets niet helemaal begrijpt, dan kun je het beste even kijken naar het volgende plaatje waarop het model al weer iets verder is, bijv. om te zien waar bepaalde elementen worden geplaatst.

Om er zeker van te zijn dat het model goed functioneert kan je nog

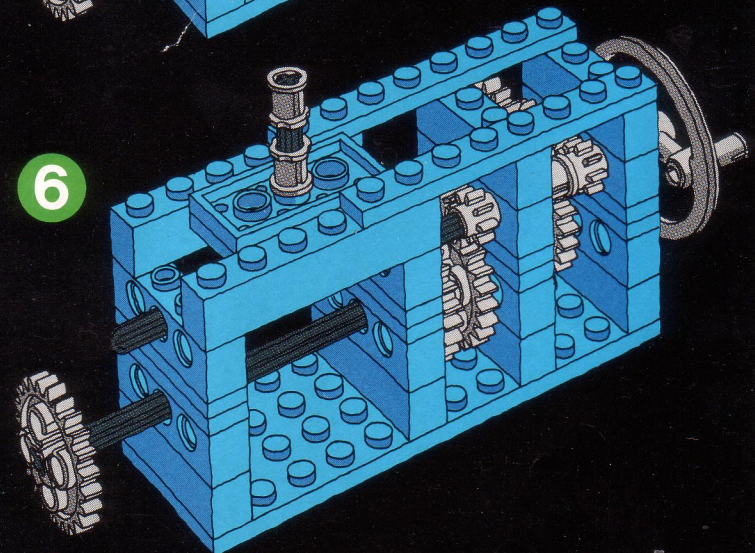
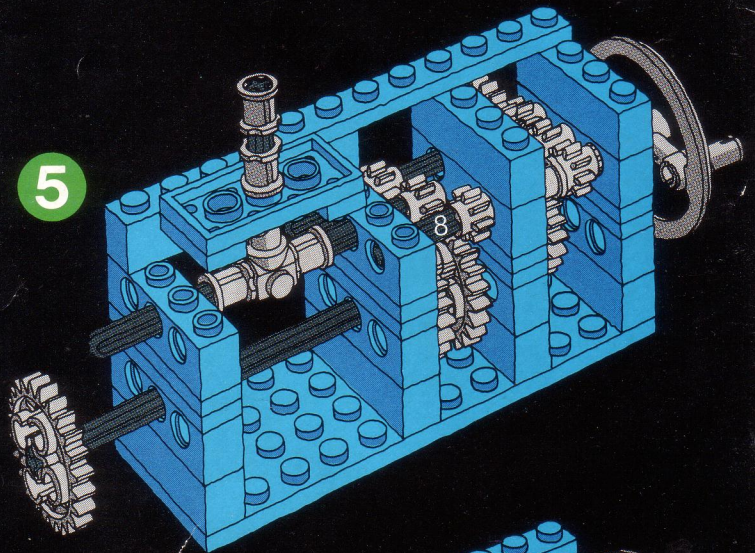
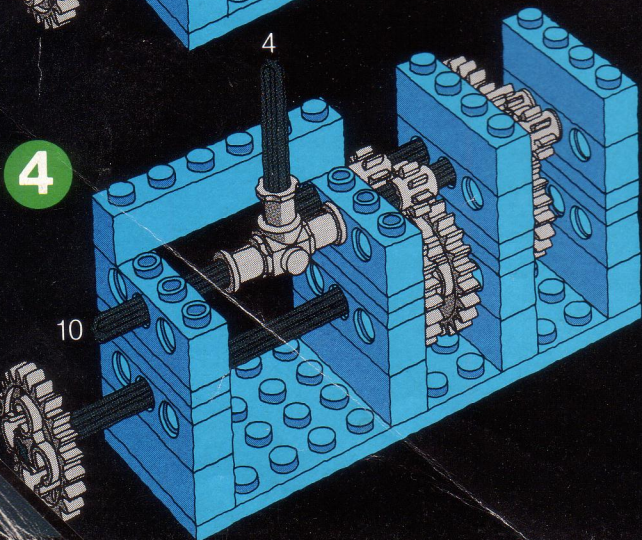
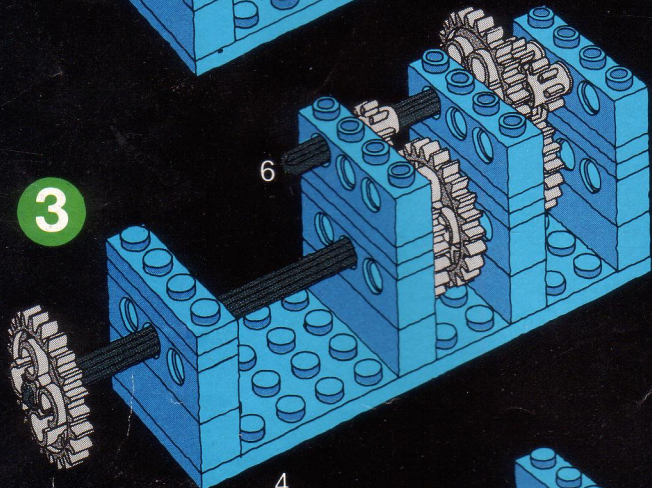
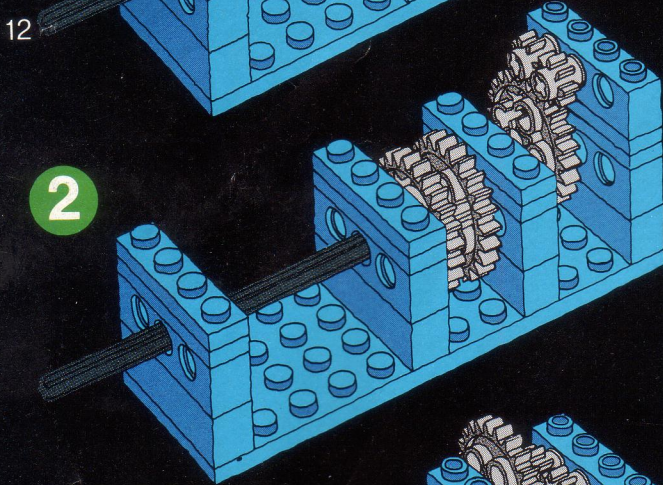
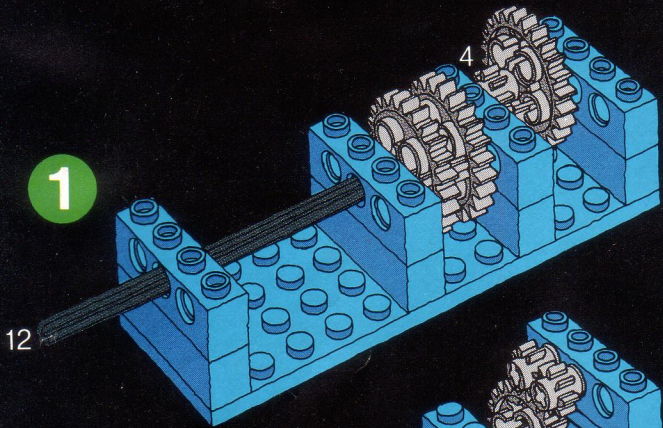
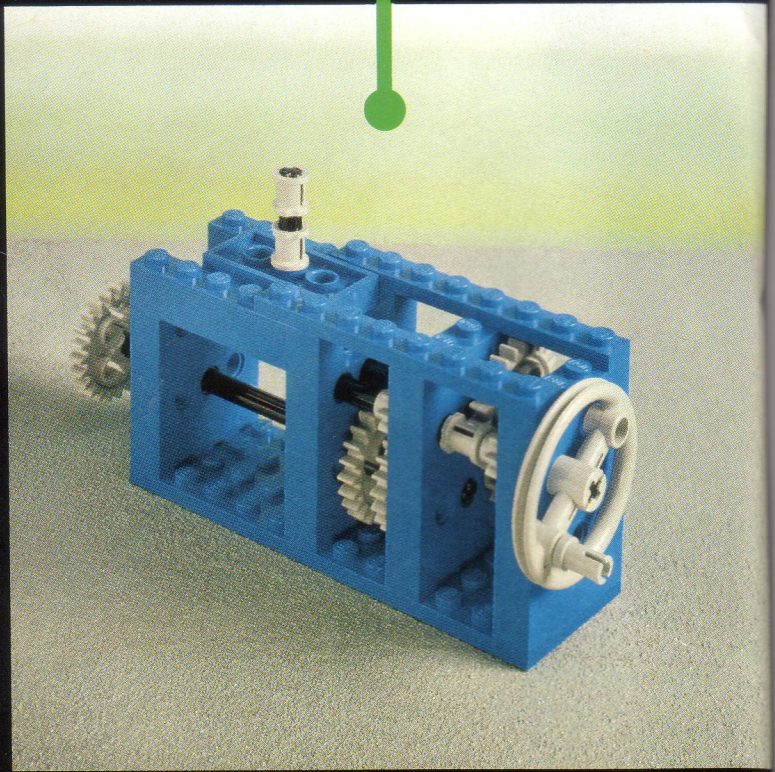
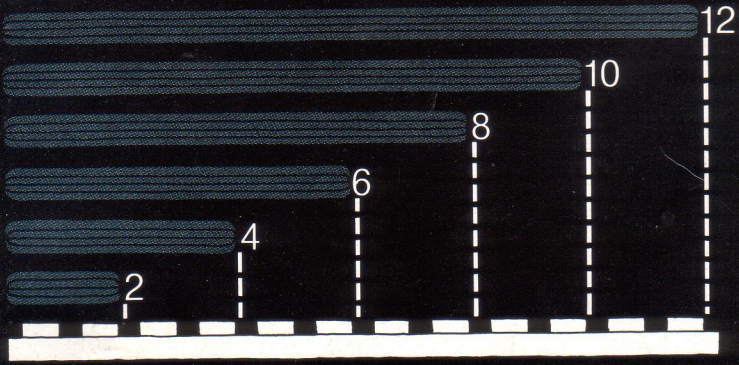

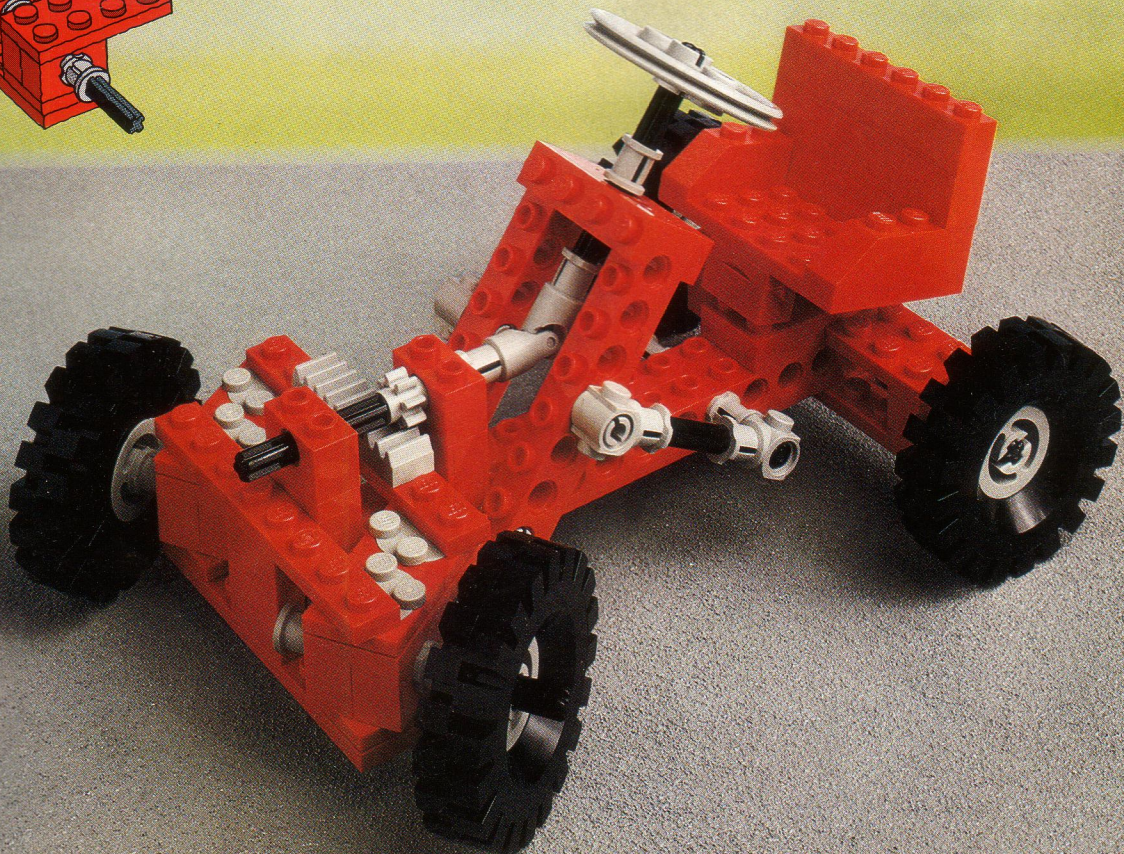
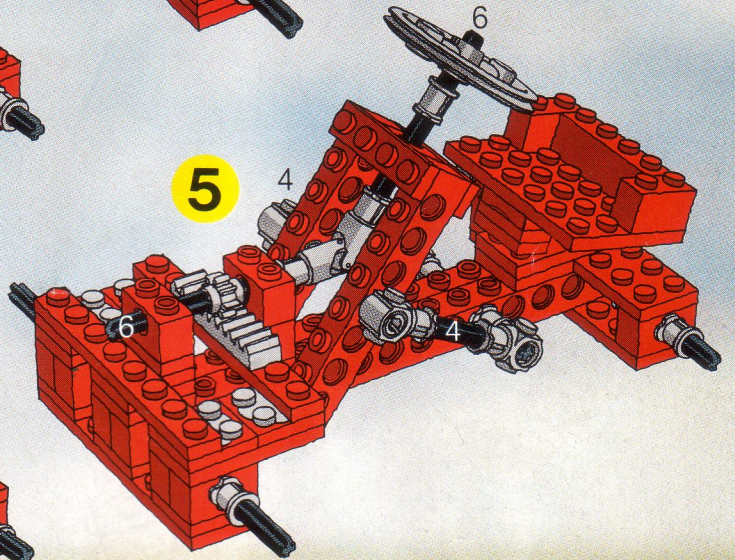
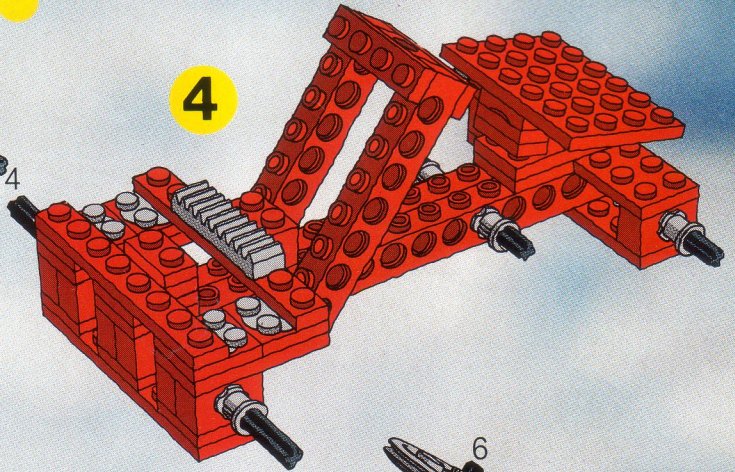
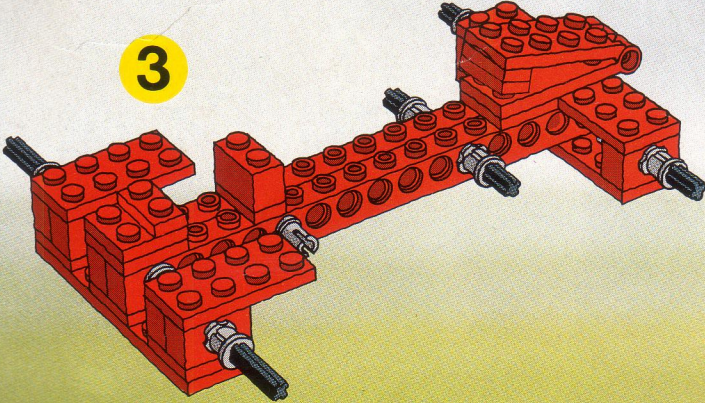
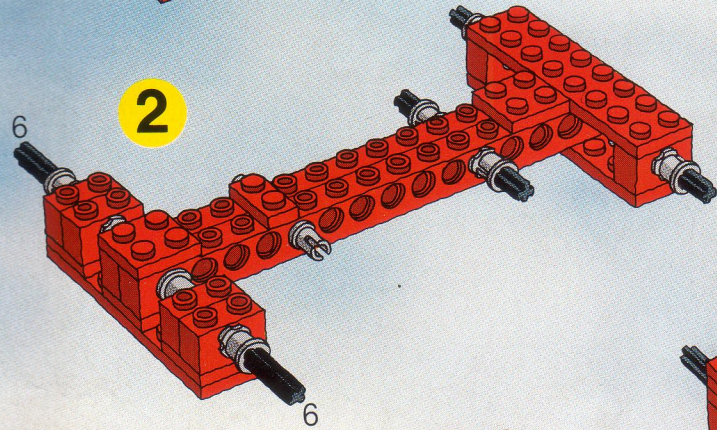
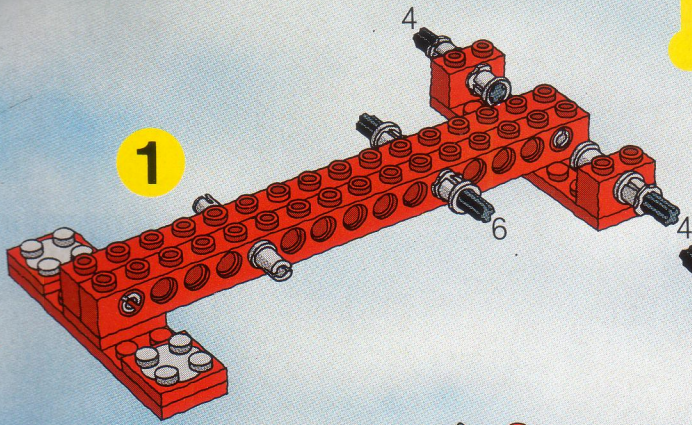

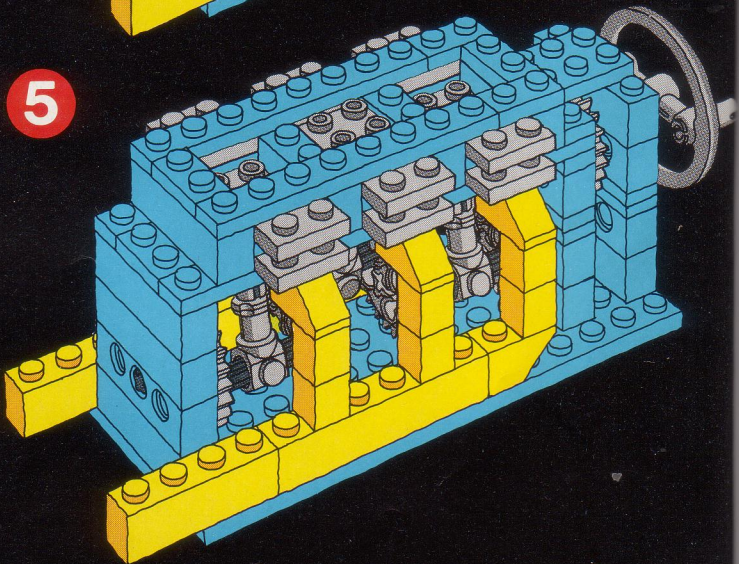
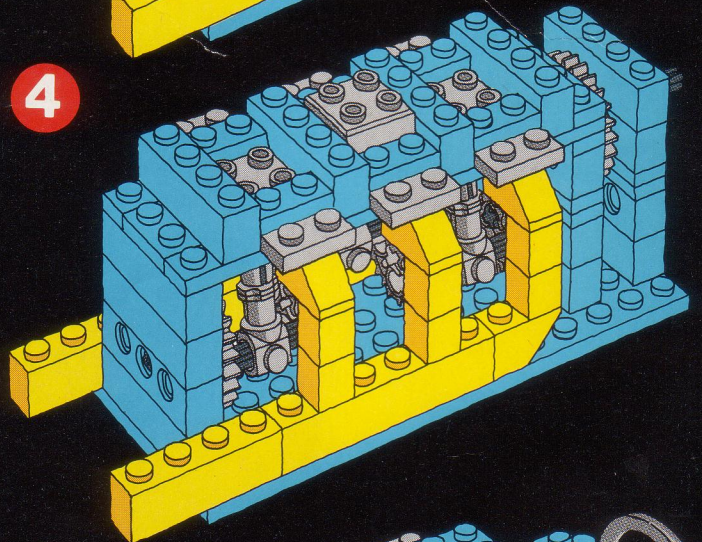
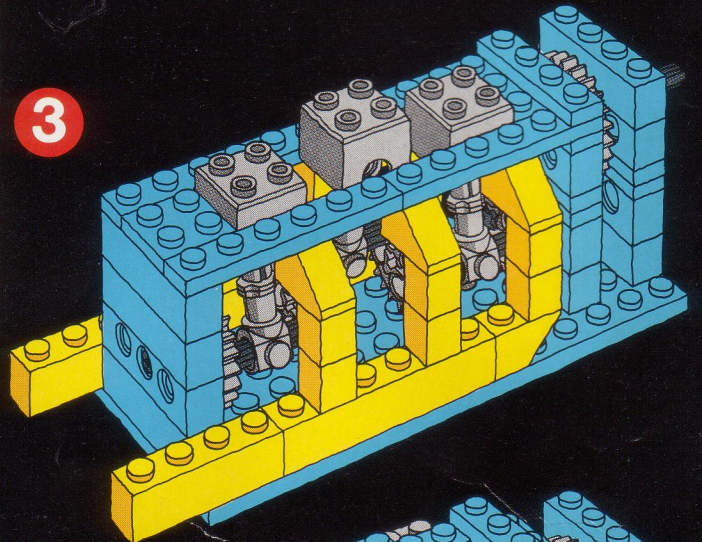
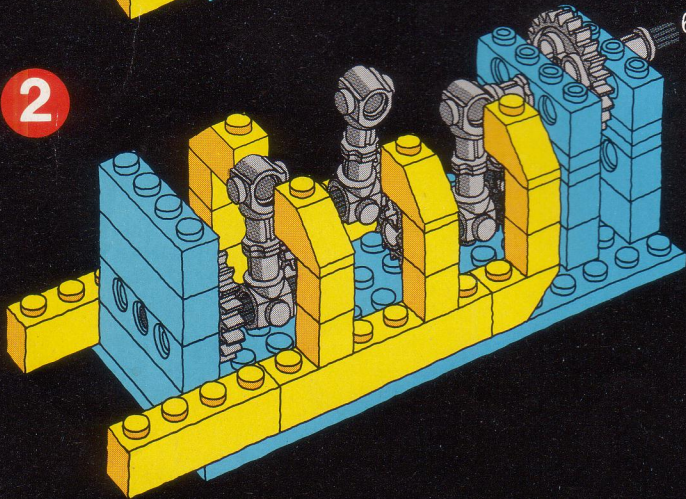
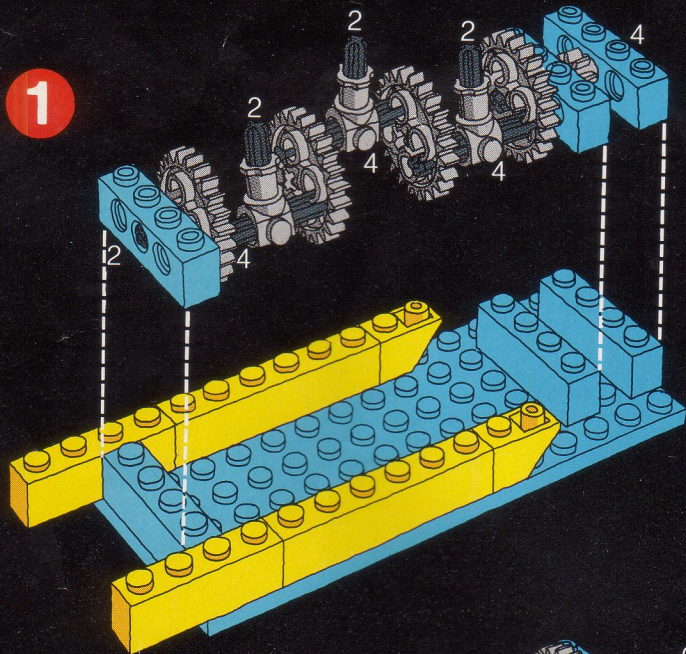
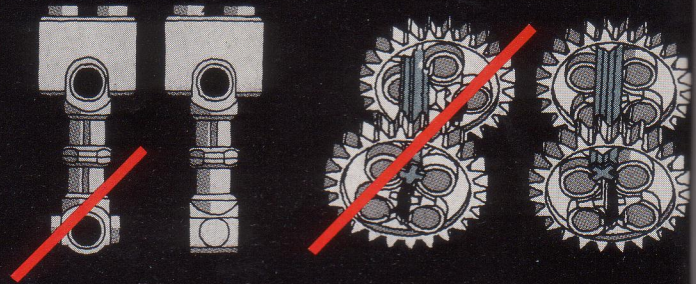
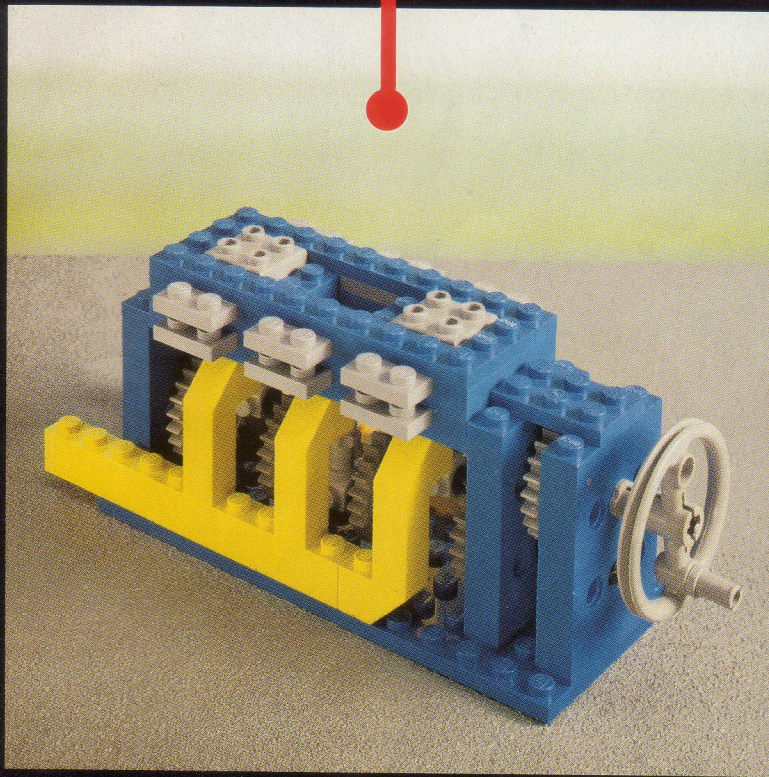

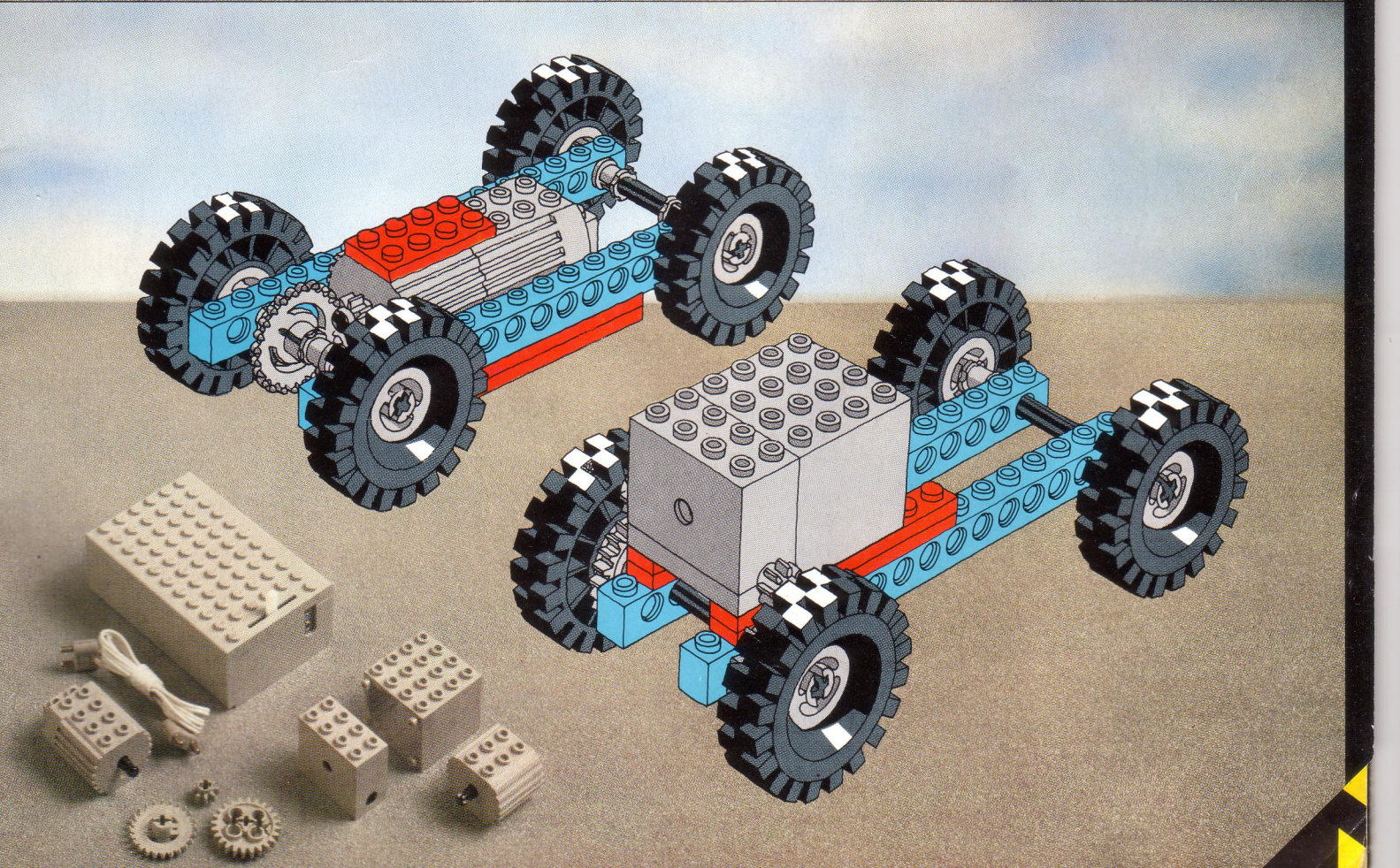
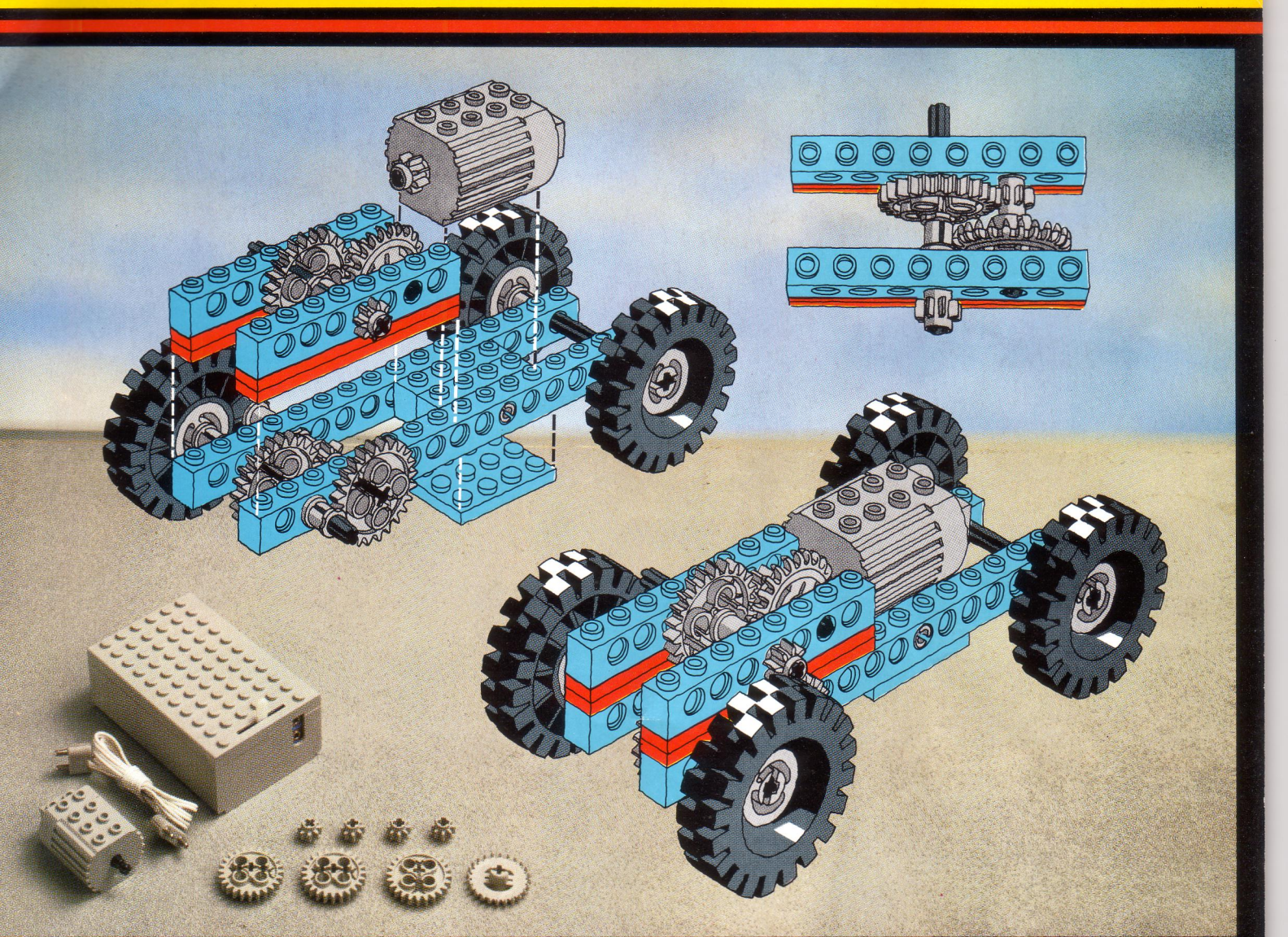

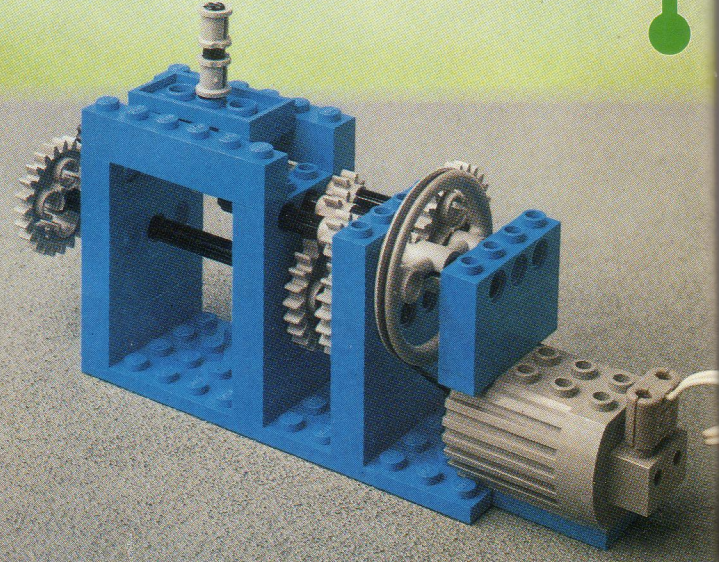
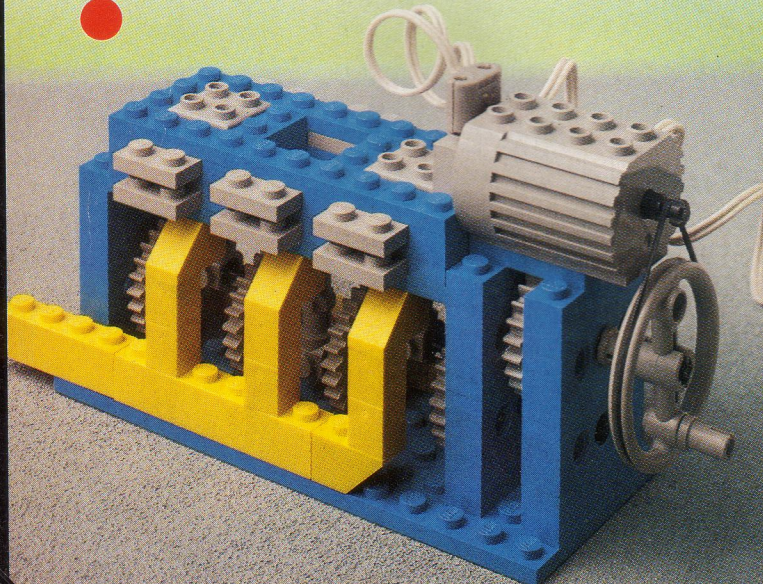
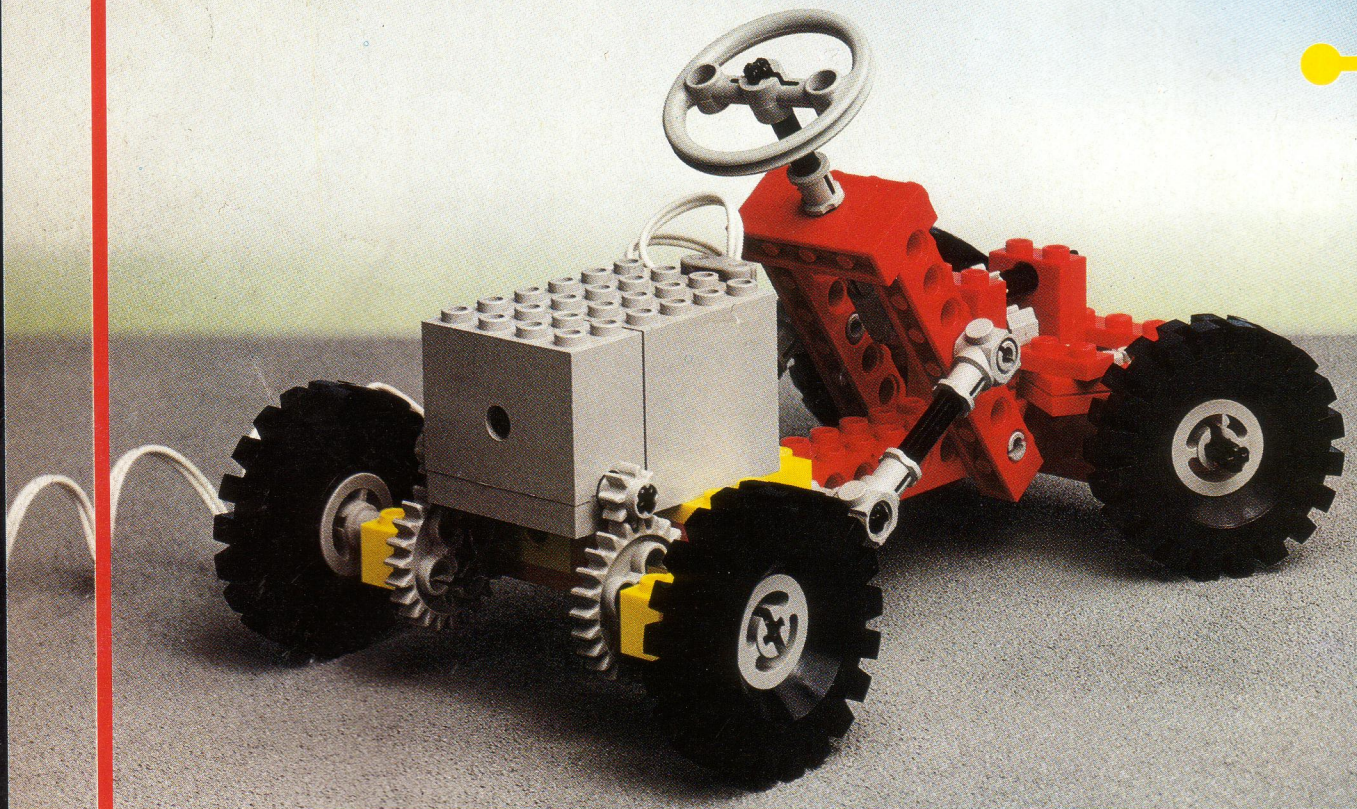
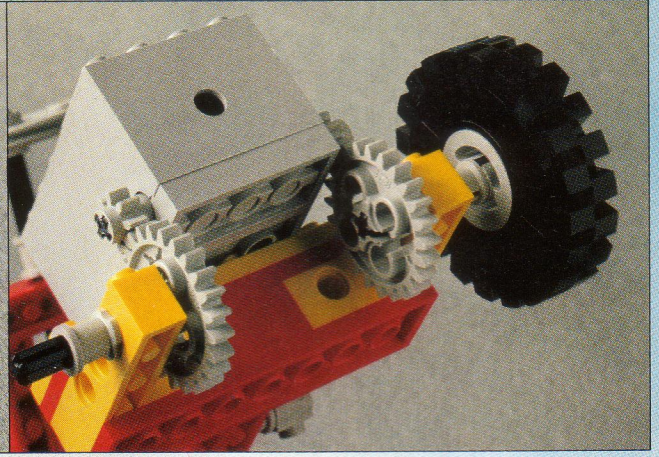
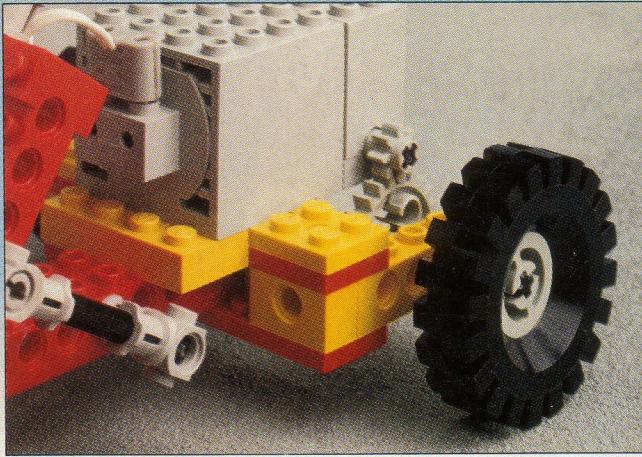

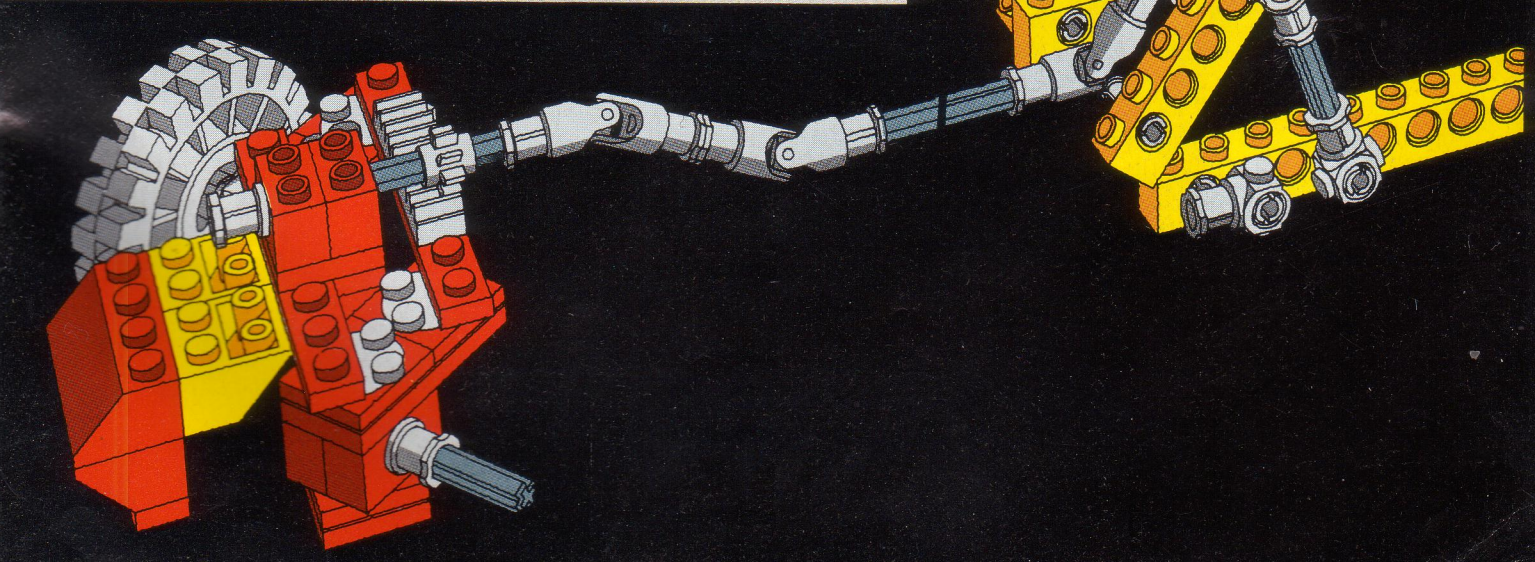
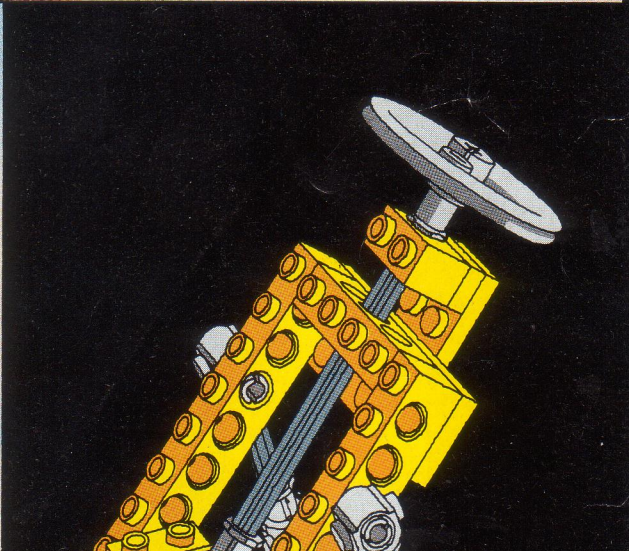

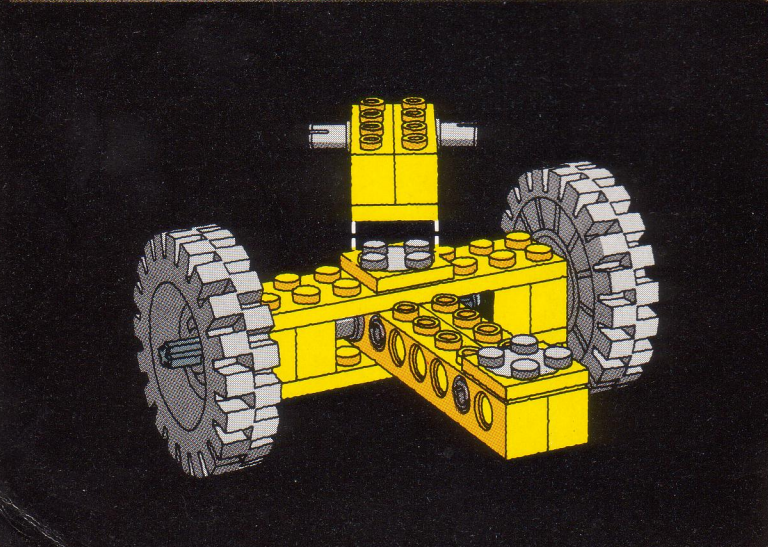
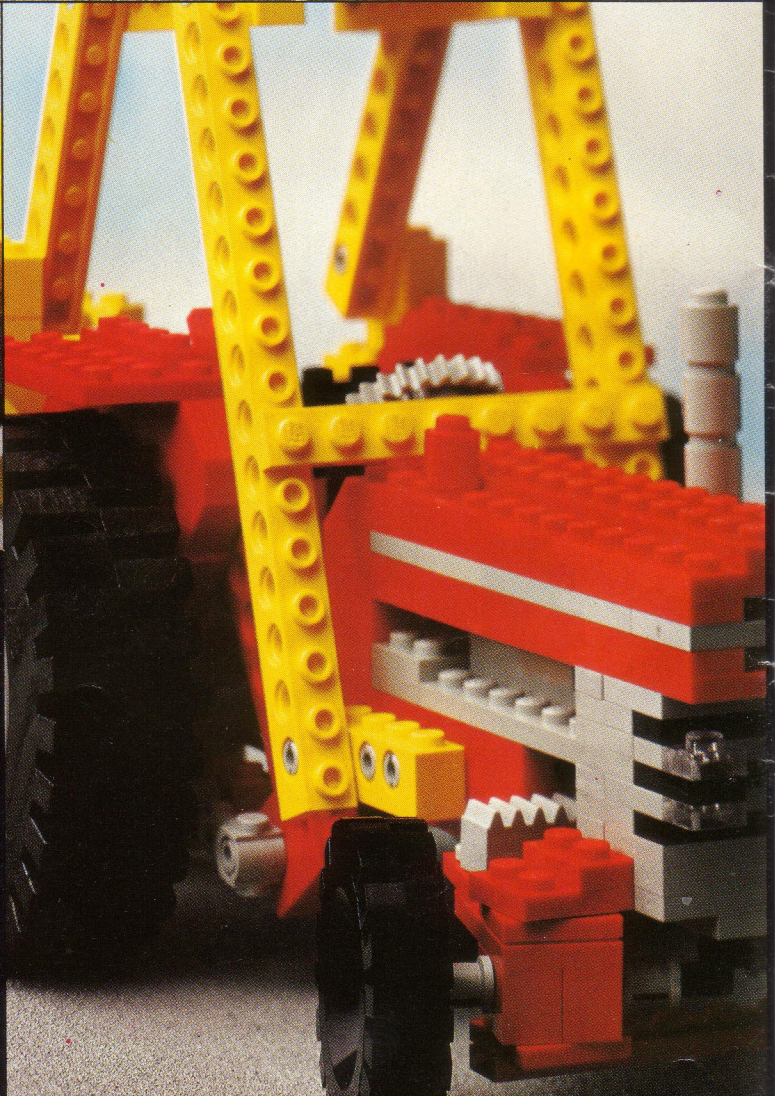
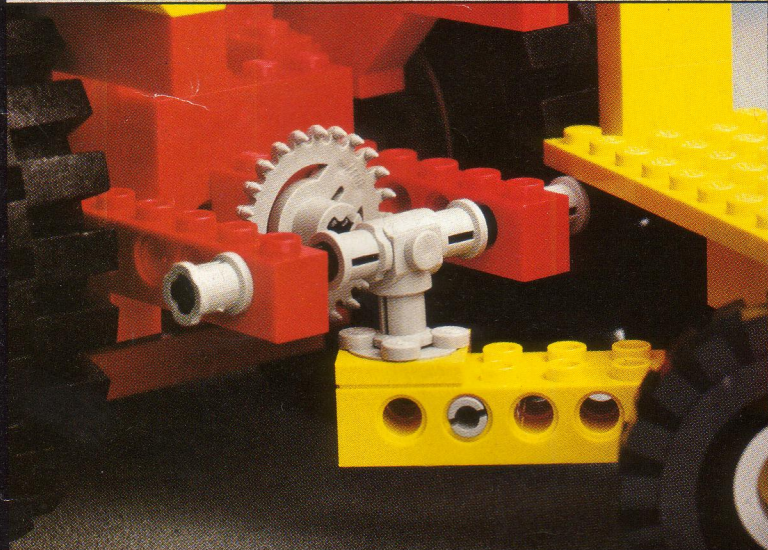

850 + 854

