

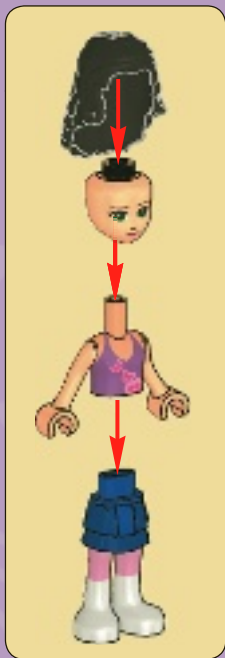

Friends



3936





1

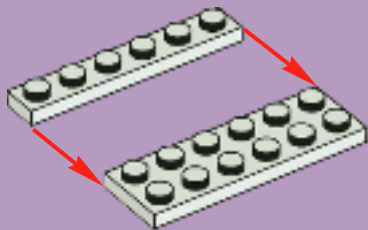

2

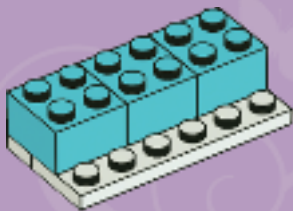

3

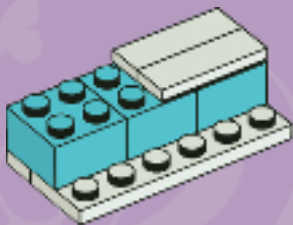

4

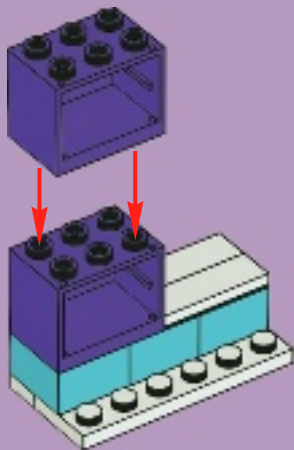

5

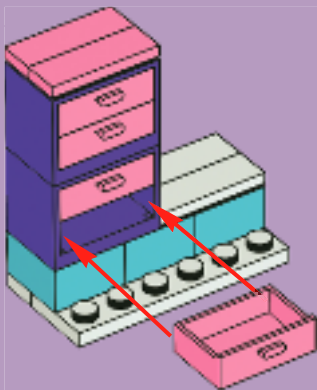

6

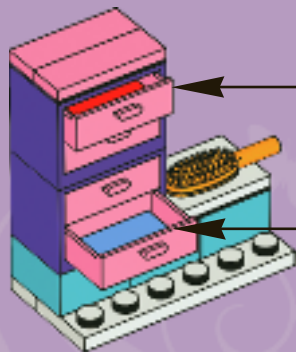
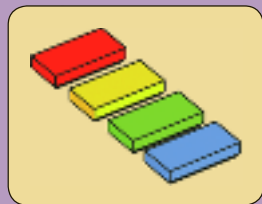

1



2

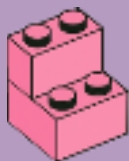

3



6





1

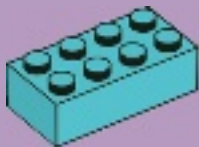

2



3

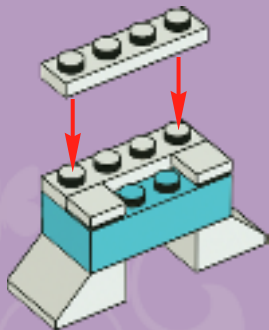

4

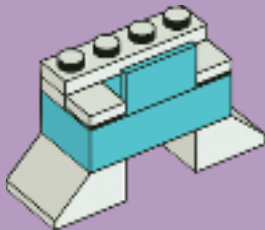

5

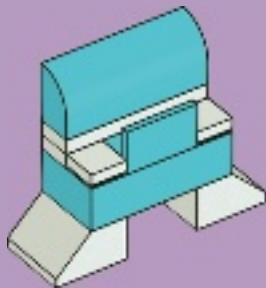

6





1



2

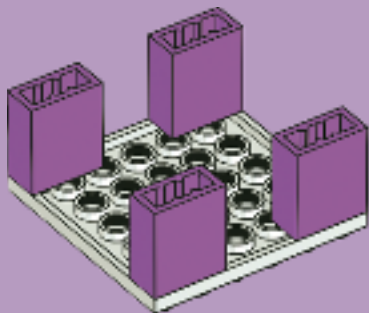

3

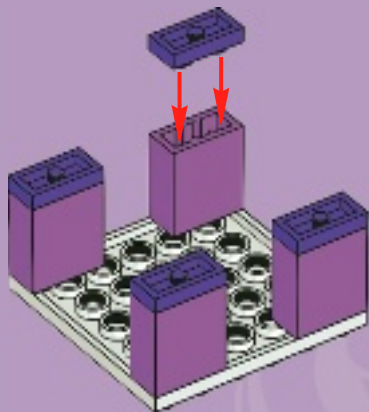

4

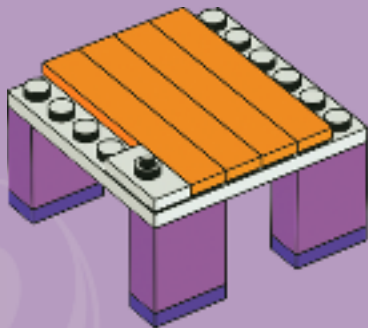

5



6



7

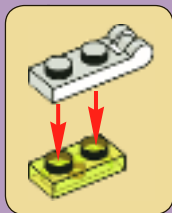

8





1

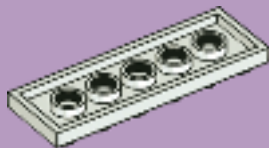

2

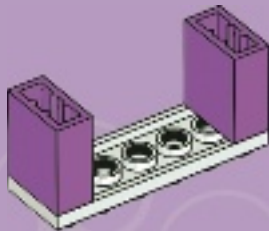

3

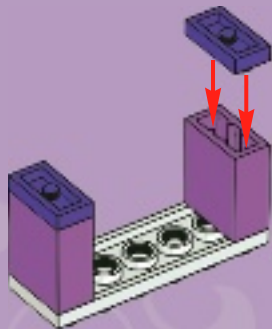

4

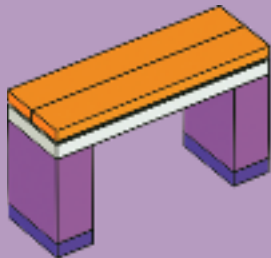

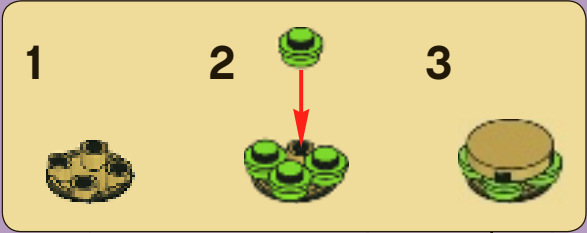

5

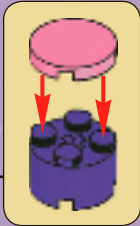





3x
379401



2x
307001



1x
4518400



2x
303901



2x
371001



1x
366601



2x
379501



1x
4653275



1x
4515364



2x
4558168



1x
626601



1x
4653271

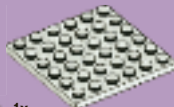

1x
4144012



1x
4129501



1x
4278422



1x
4194746



1x
4168345



1x
306921



1x
306924



1x
4596243



1x
4106552



1x
4527063



1x
374128



1x
4143404



1x
4500125



4x
4183133



6x
4654129



1x
4216375



6x
4654130



1x
4243668



1x
4621609



1x
4654127



1x
4517993



1x
4550359



2x
4622744



4x
4599534



1x
4618647



1x
4620909



3x
4653970



1x
4625629



1x
4618658



6x
4655695



1x
4622176



2x
4654109



1x
4621414



1x
4646910



1x
4612383



Customer Service

Kundenservice

Service Consommateurs

Servicio Al Consumidor

www.lego.com/service or dial



: 00800 5346 5555

: 1-800-422-5346



Friends

LEGOFriends.com



Emma



Olivia



Stephanie



Mia



Andrea

Heartlake City



LEGO

Friends

LEGO Friends



LEGOFriends.com





3183



3061



3065



3187



3942



3936



3188



3934



3315



CREATOR

5771



creator.LEGO.com

3 IN **1**



www.LEGOclub.com



LEGO® Club Email

LEGO club™

FREE! GRATIS! GRATUIT!



LEGO® Club Magazine

SIGN UP ONLINE!

www.LEGOclub.com

00800 5346 5555*



1-866-534-6258 • 1-877-518-5346

US & Canada only

Canada seulement

BI110

- * Freephone. Mobile charges may apply.
- * Numéro sans frais. Des frais peuvent s'appliquer avec les téléphones cellulaires.
- * Gebührenfrei, Kosten für Anrufe aus Mobilfunknetzen können abweichen.
- * Gratis telefoonnummer vanaf vaste lijn.
- * Det er et gratis nummer, når du ringer fra fasttelefon.
- * Det är gratis, när du ringer från en fast telefon.
- * Numéro sans frais. Des frais peuvent s'appliquer avec les téléphones portables.



Win!

Go to www.LEGOsurvey.com/product to fill out a survey for a chance to win a cool LEGO® Product. No purchase necessary. Open to all residents where not prohibited.



www.LEGOsurvey.com/product

Gewinne!

Nimm an der Umfrage auf www.LEGOsurvey.com/product teil und hab die Chance ein cooles LEGO® Produkt zu gewinnen! Die Teilnahme am Gewinnspiel führt zu keinerlei Kaufverpflichtungen. Teilnahme in allen nicht ausgeschlossenen Ländern möglich.

Win!

Ga naar www.LEGOsurvey.com/product, vul een enquêteformulier in en maak kans op een cool LEGO® product. Geen aankoopverplichting. Iedereen mag deelnemen, uitgezonderd ingezetenden van landen waar een enquêteverbod geldt.

Gagne !

Visite www.LEGOsurvey.com/product pour répondre à un questionnaire et avoir une chance de gagner un produit LEGO® très cool ! Aucune obligation d'achat. Ouvert à tous les résidents des pays autorisés.

当てよう!

www.LEGOsurvey.com/product にアクセスして、アンケートにご記入ください。当選者にはレゴ®製品を差し上げます。お買い上げの必要はありません。禁止されていない限り、すべての皆様にご利用いただけます。



www.LEGO.com

6006133

LEGO and the LEGO logo are trademarks of the LEGO Group. ©2012 The LEGO Group.