

**LEGO**

# ULTRA AGENTS

70168



LEGO.com

1



2



3



4





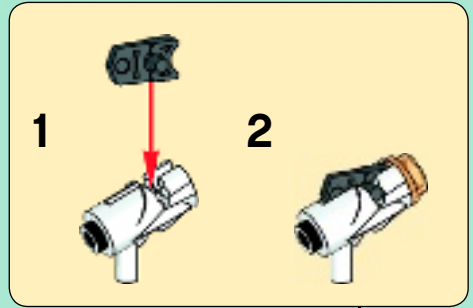
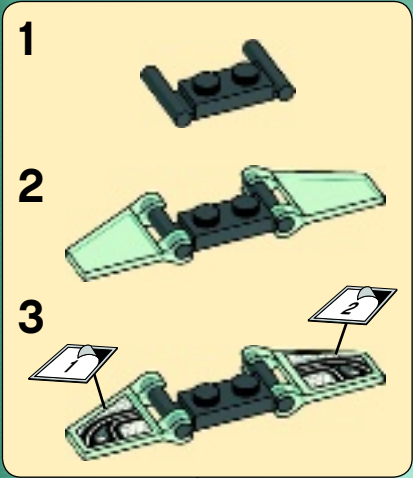

2



3





1x

1



2x

2



1x



1x

3





4

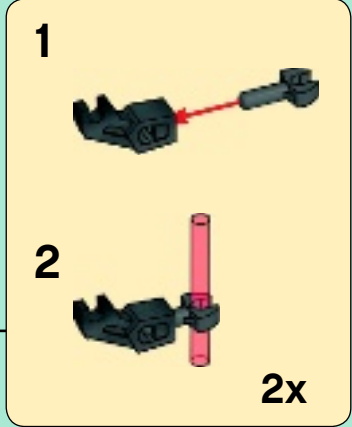

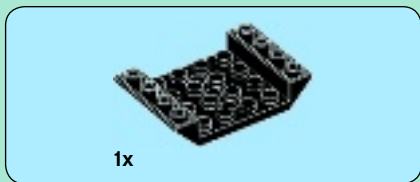

1x

1

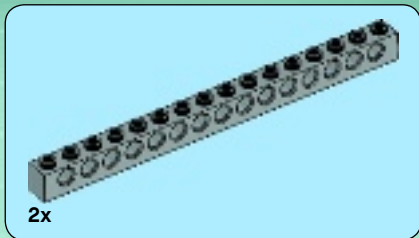

2x

2

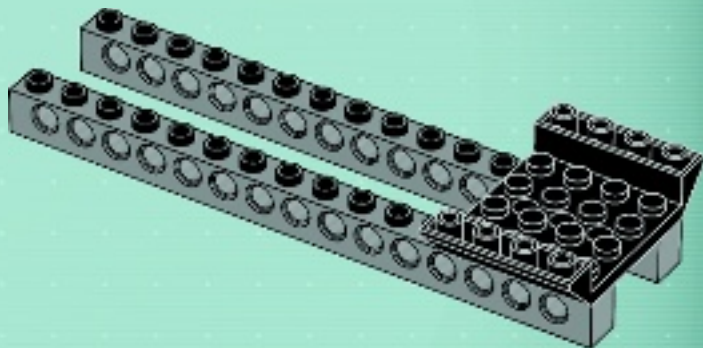



3

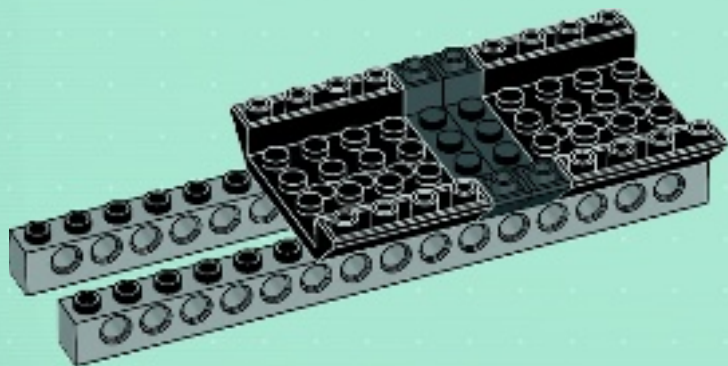
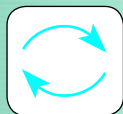



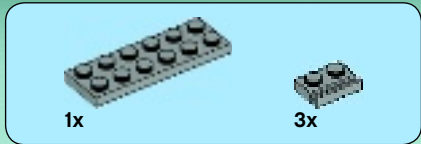

# 4

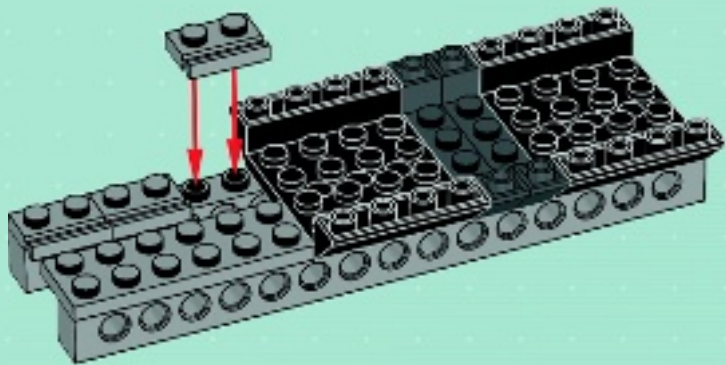



1x



2x

5

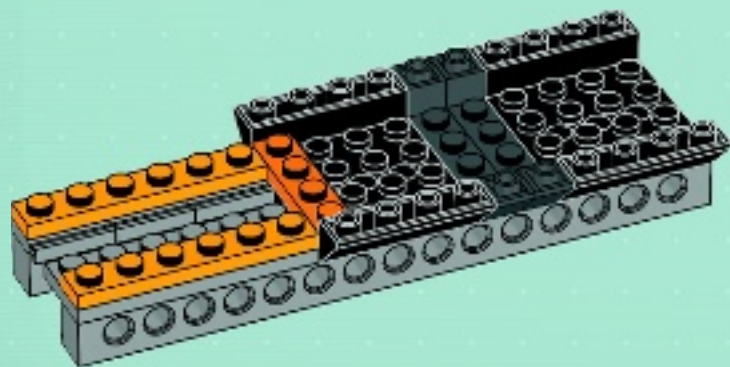



# 6

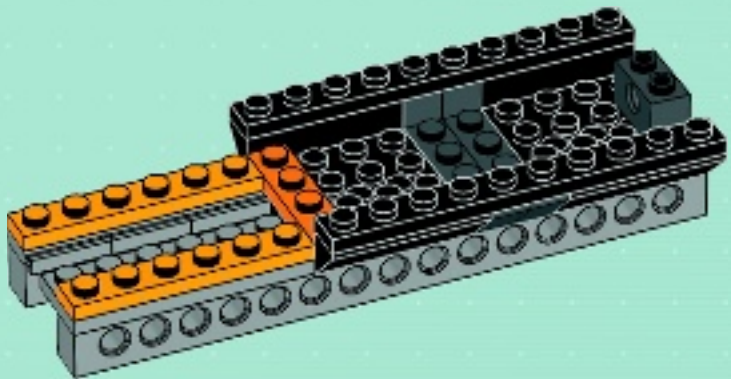

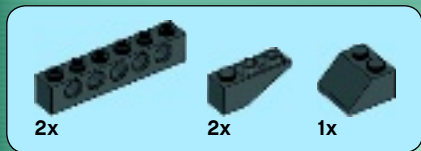

7

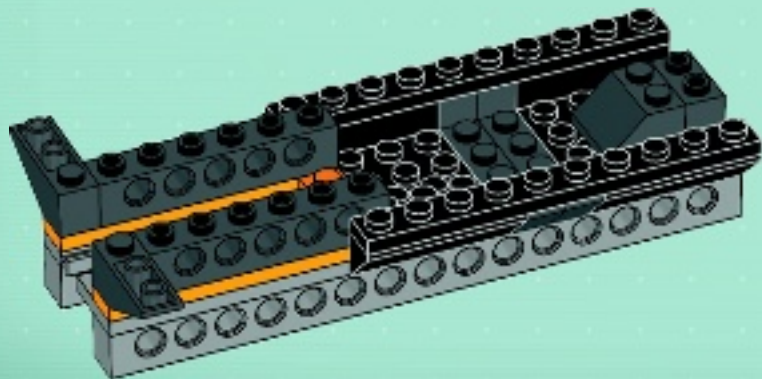



8

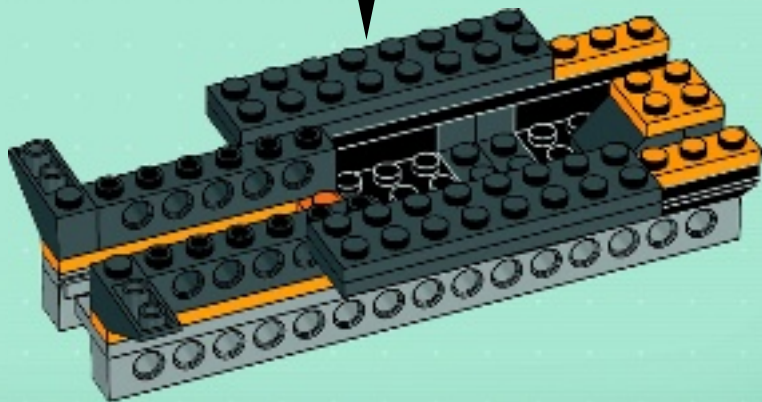
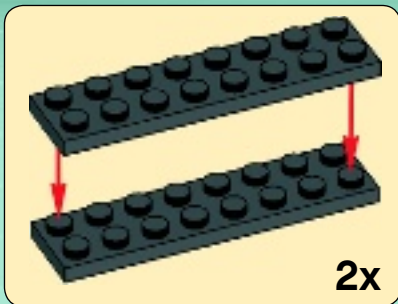



1x



1x

9

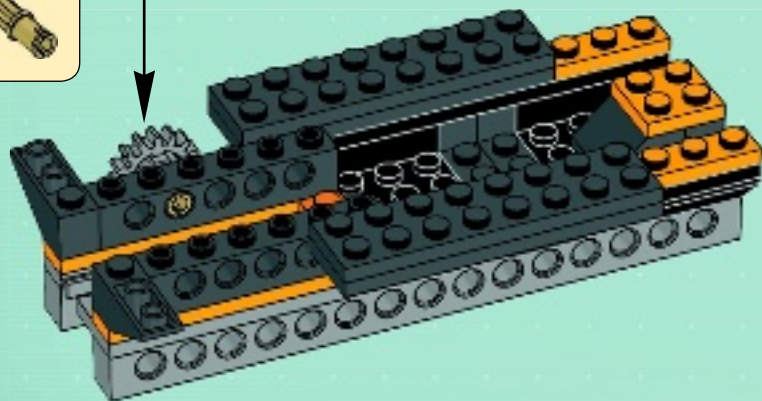

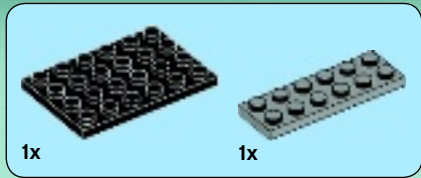

# 10

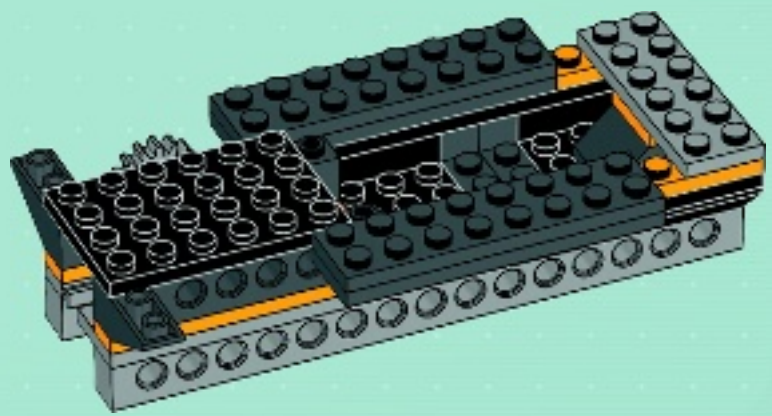



2x



3x

# 11

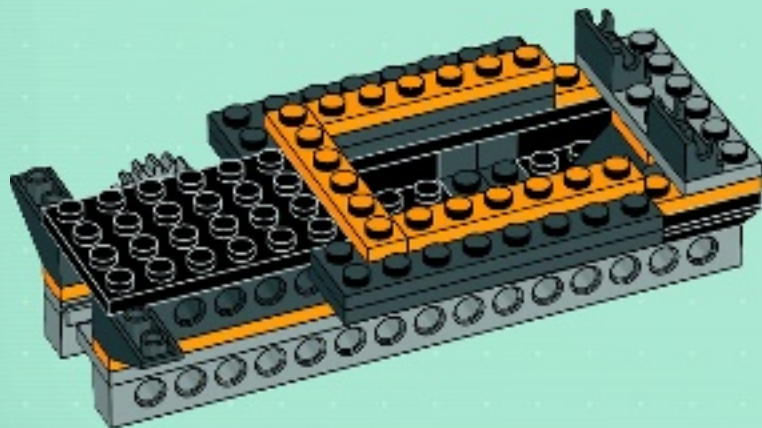



3x

2x

# 12

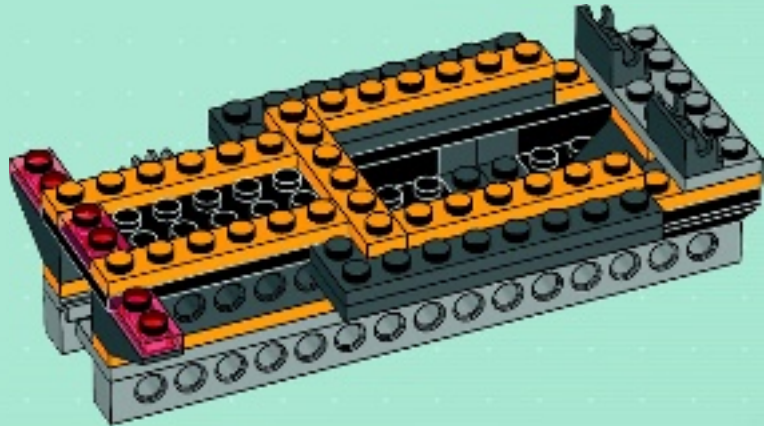



13

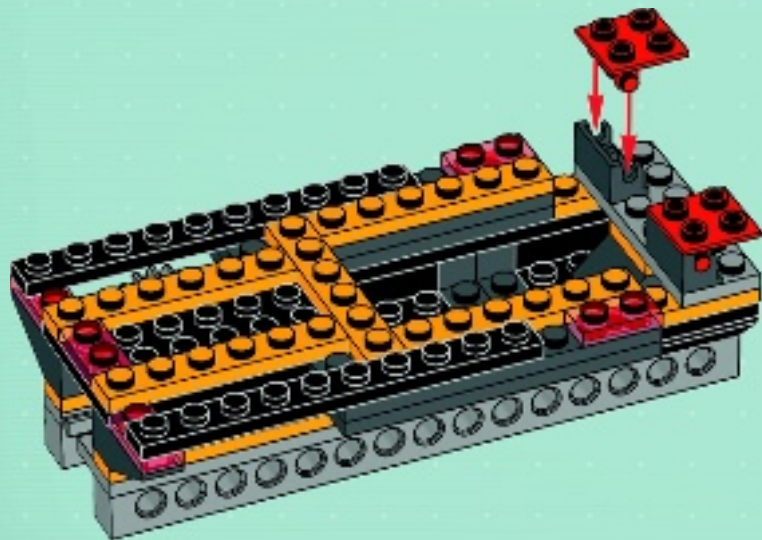

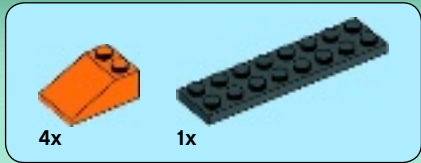

# 14

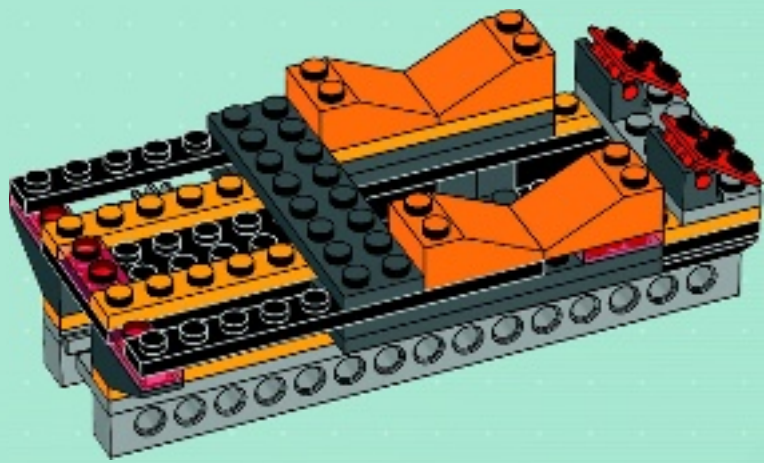



3x

15

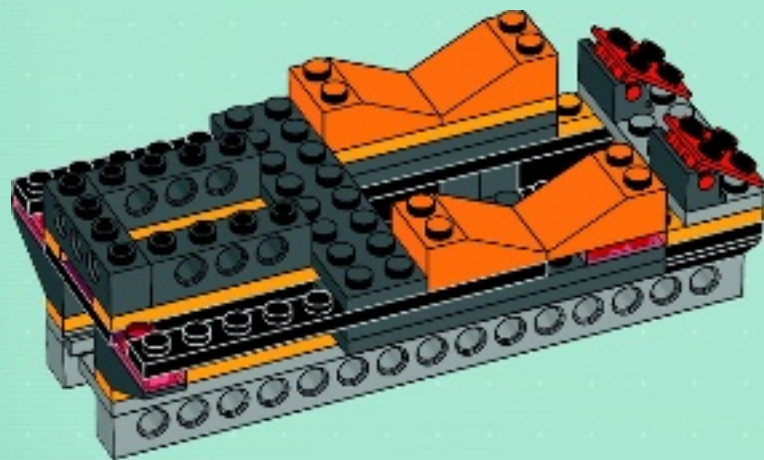

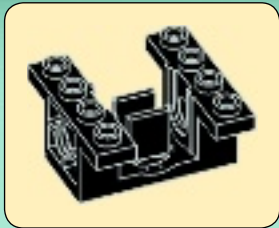
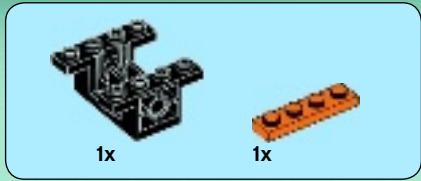

# 16

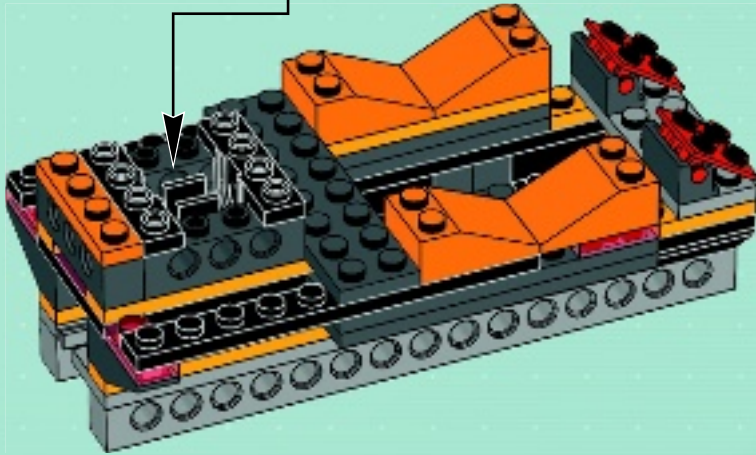



2x



2x

17

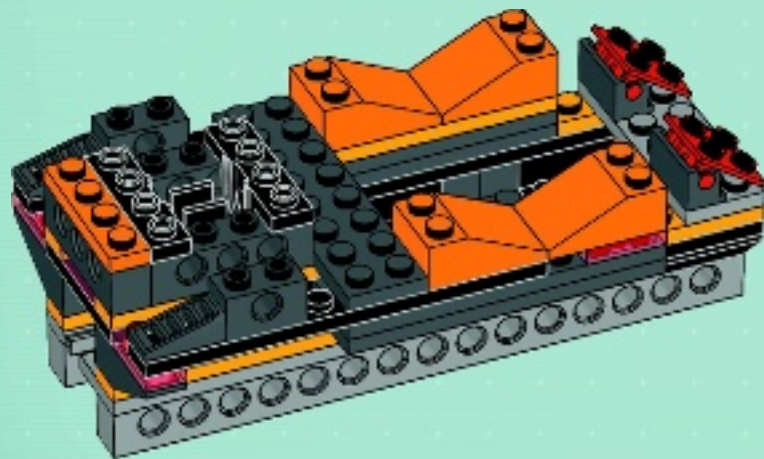

2x

18

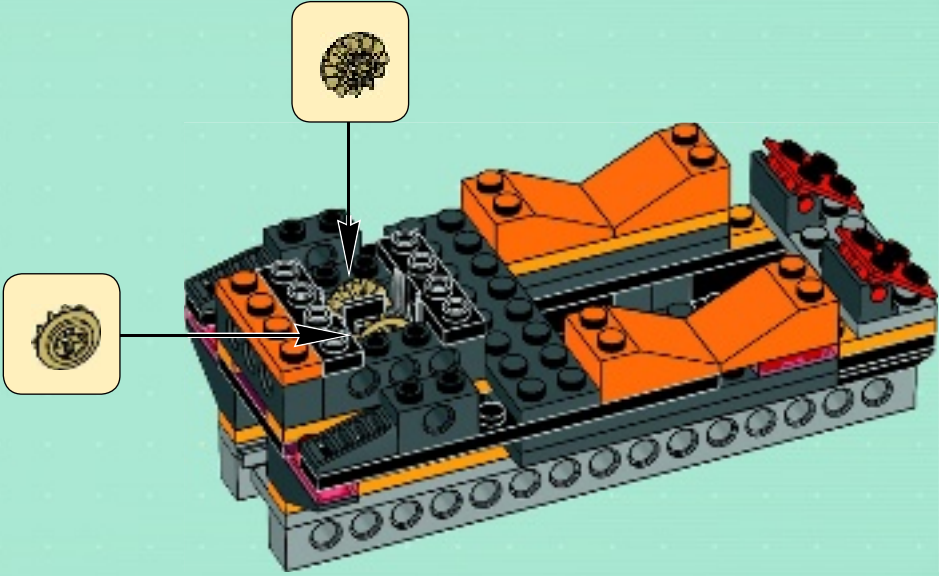

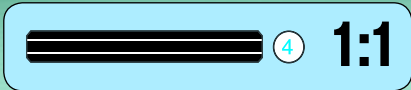
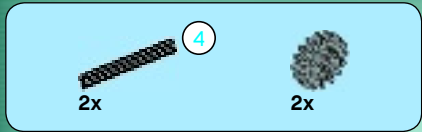

19

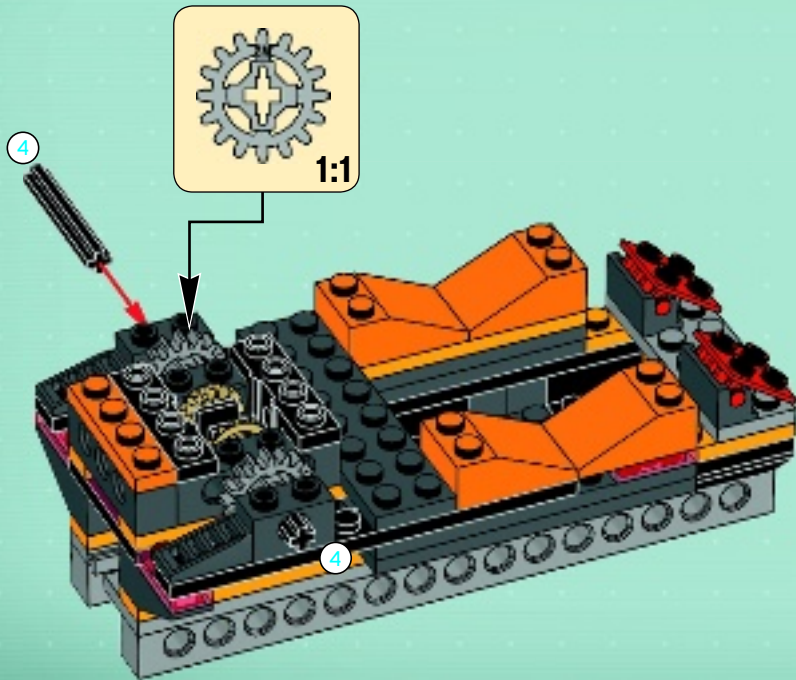





 **1:1**

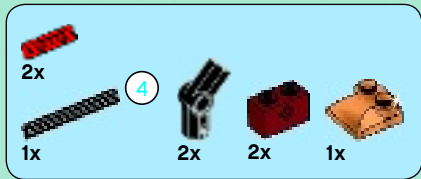

**20**



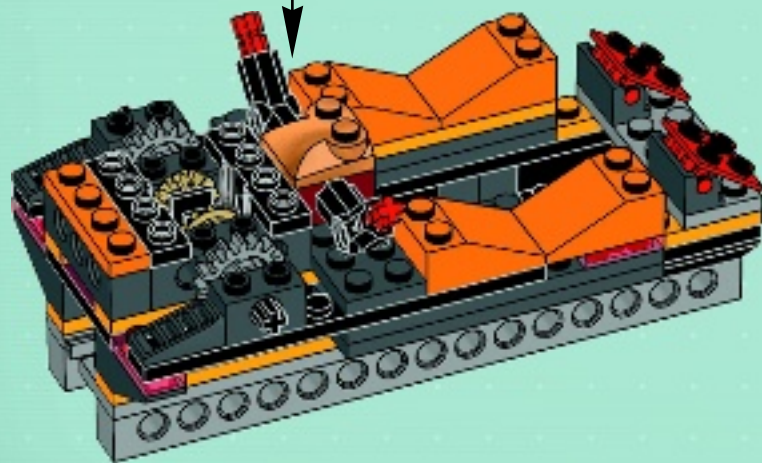



1x



2x

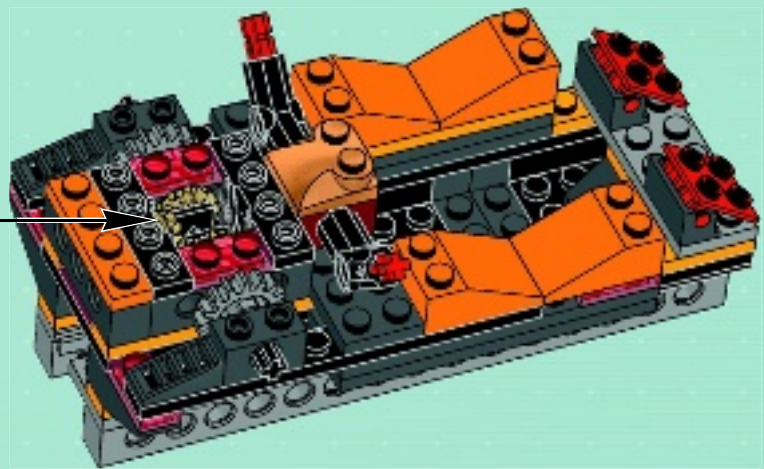
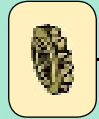

# 21

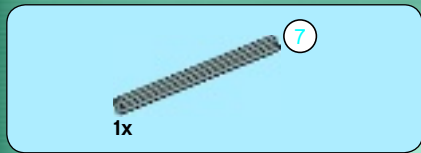

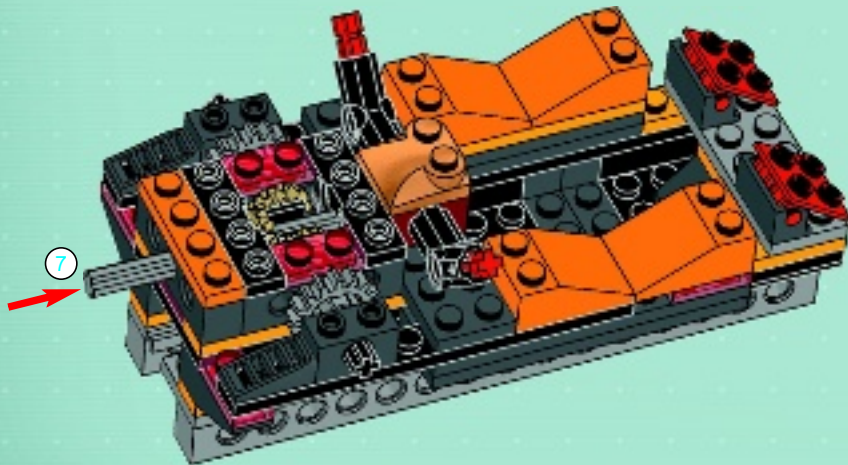

22



2x  1x 

# 23

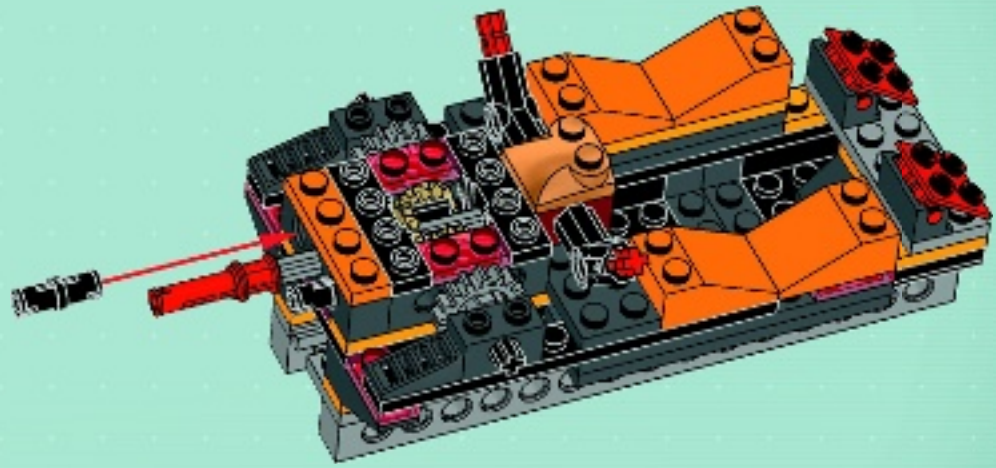

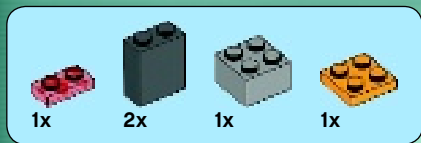

24

1



2



3



4

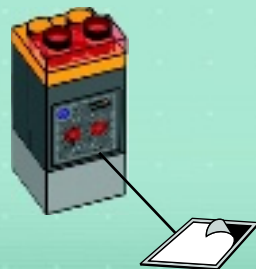

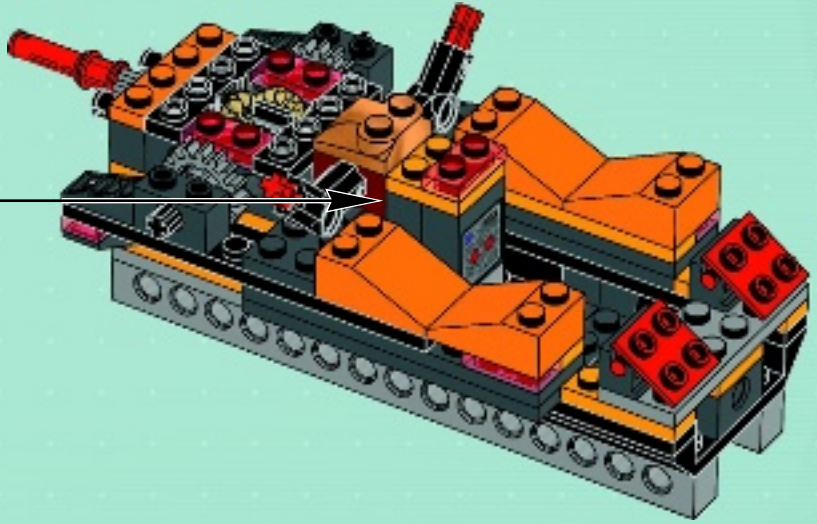

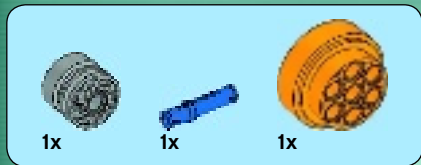

25

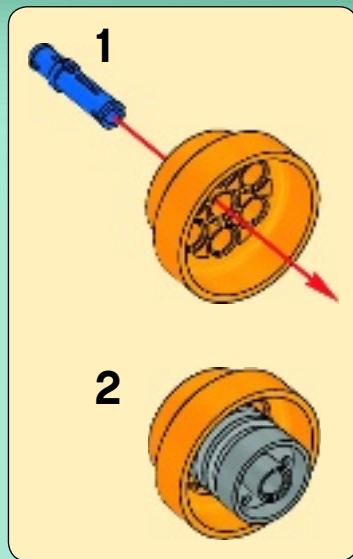
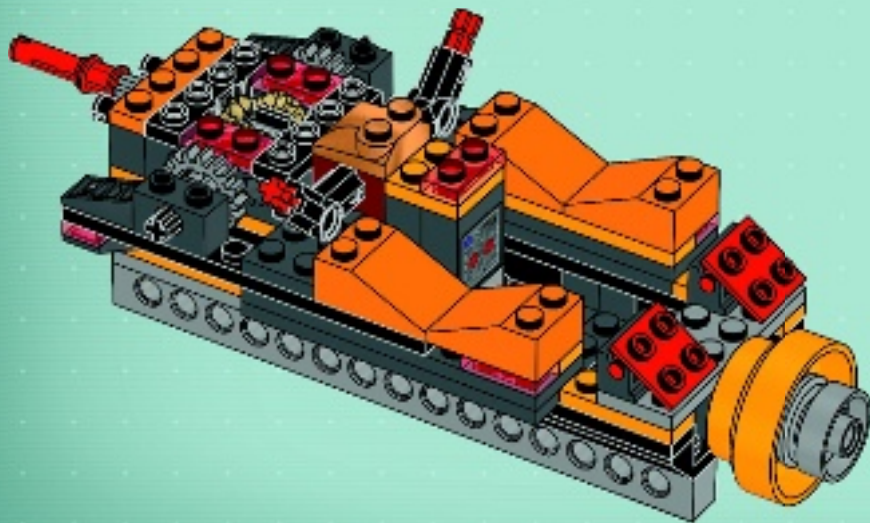



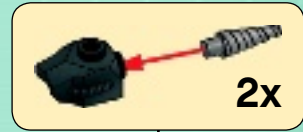

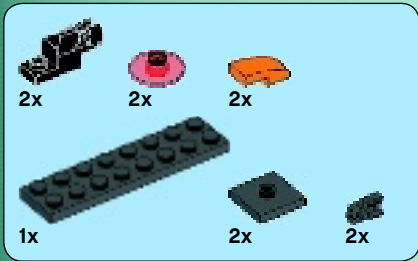

26

1



2

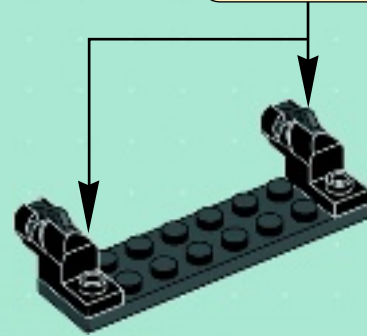
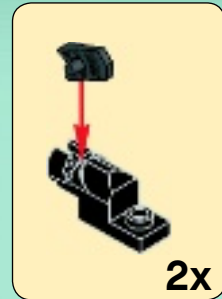

3



4



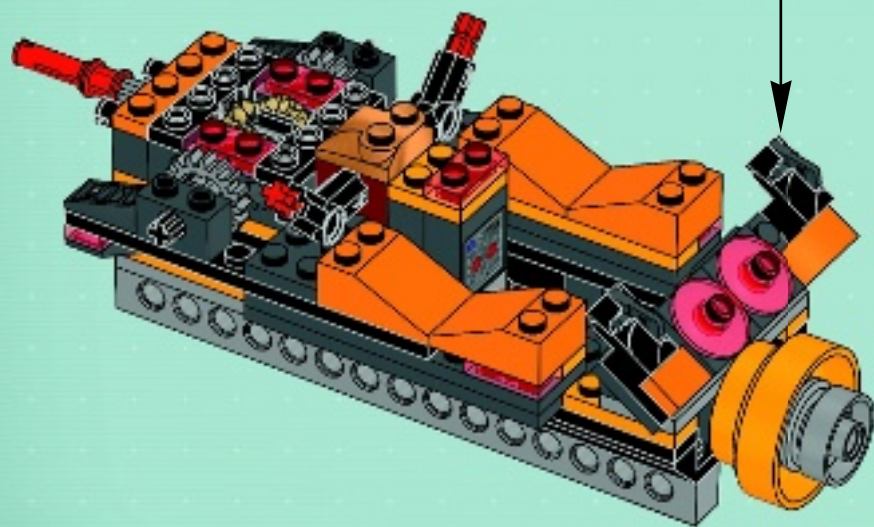



6x

27

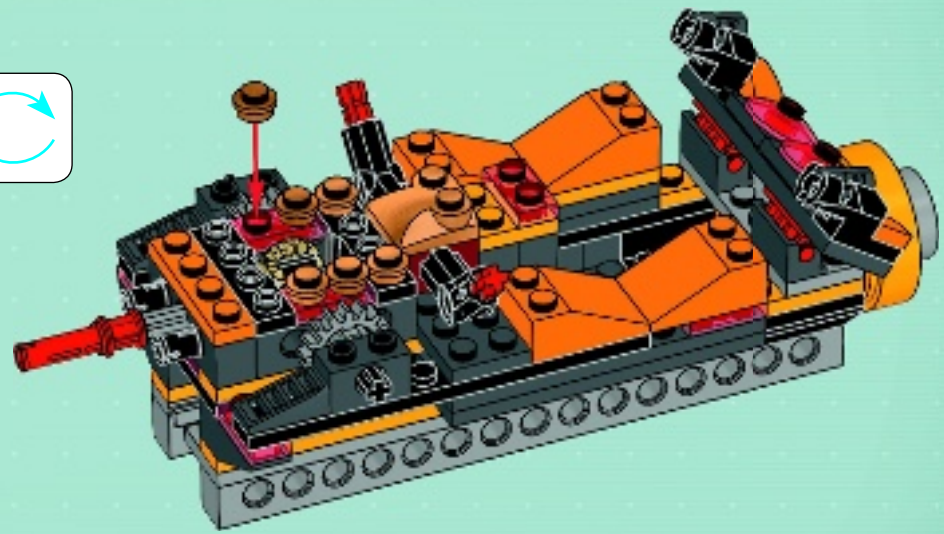
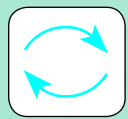



1x



2x

# 28

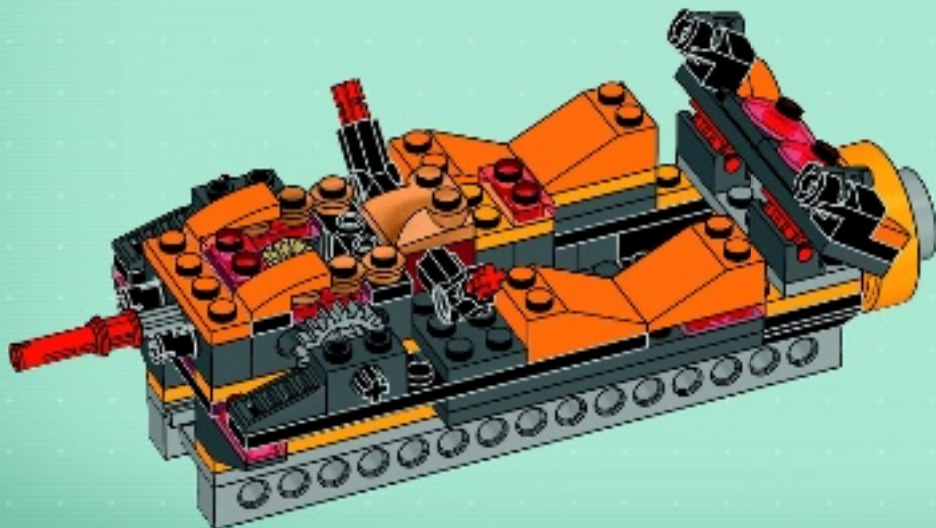



1x



1x

# 29

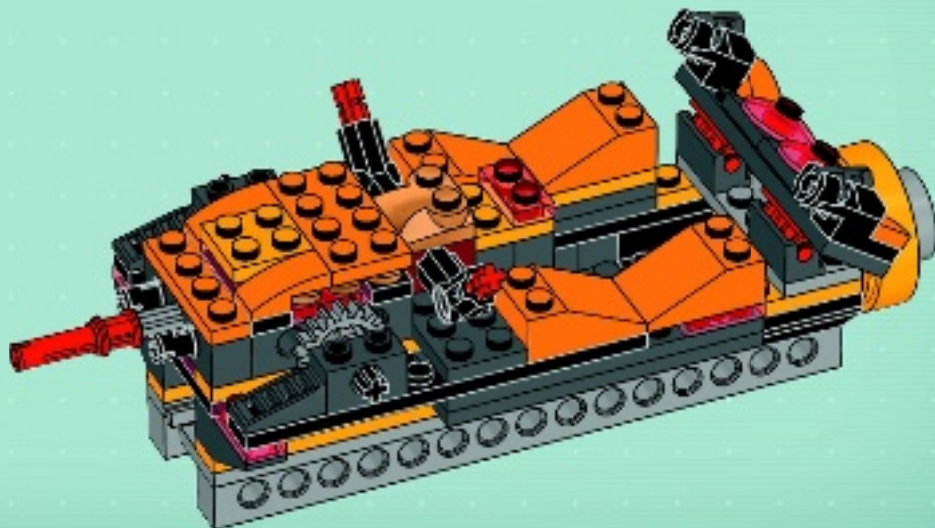



2x

30

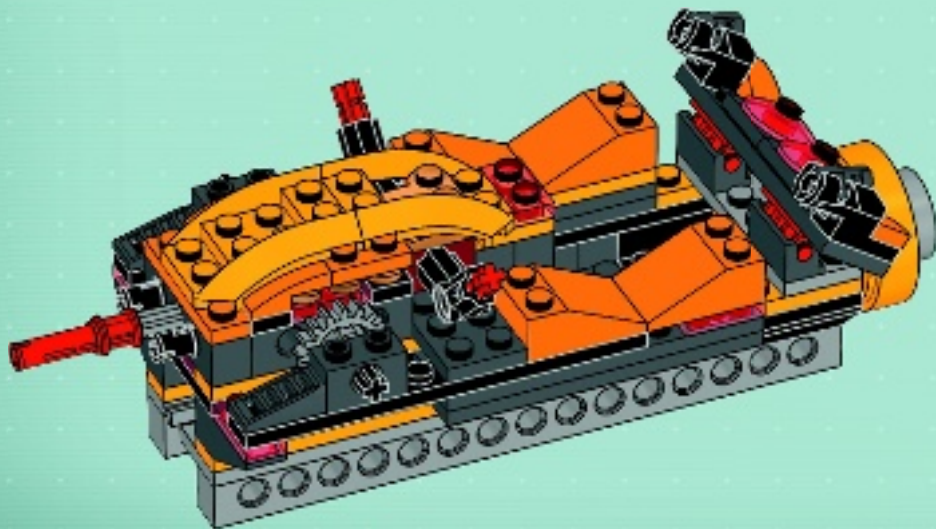



2x 1x 1x

# 31

1

2

3

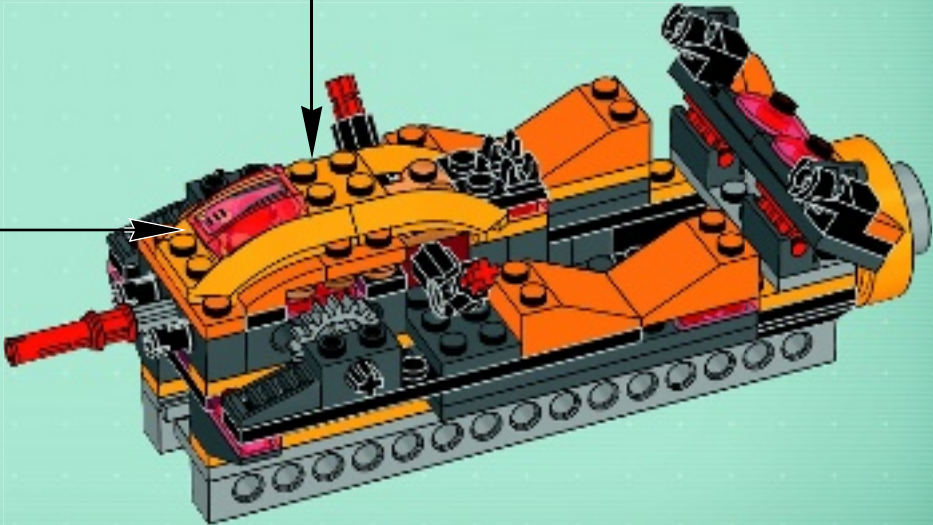

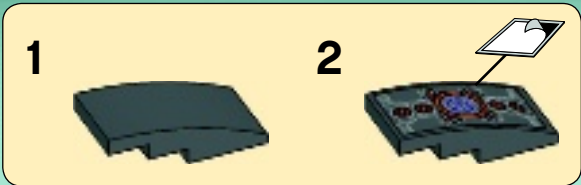

32

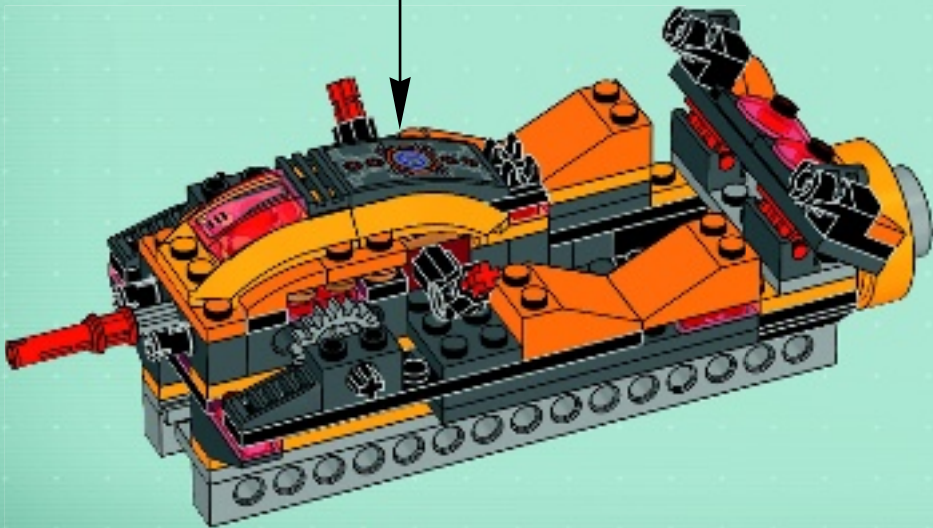

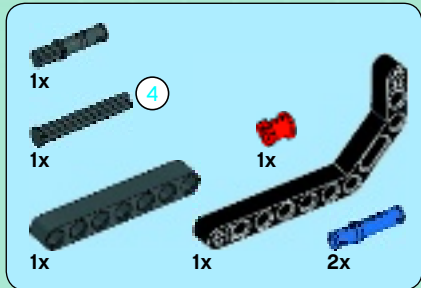
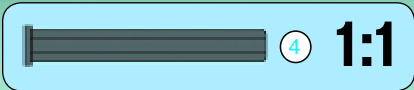

33

1



2

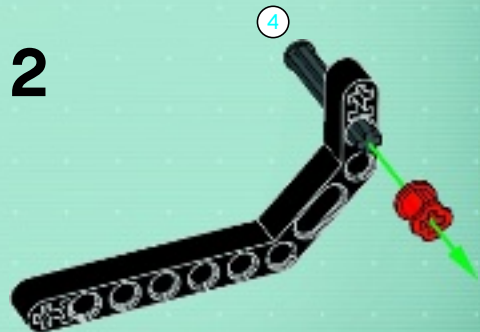

3

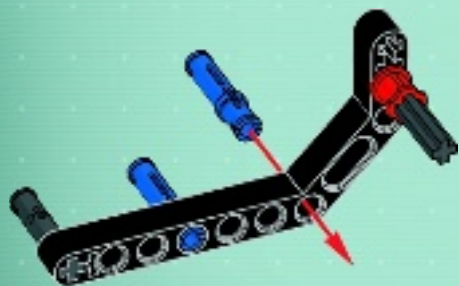

4

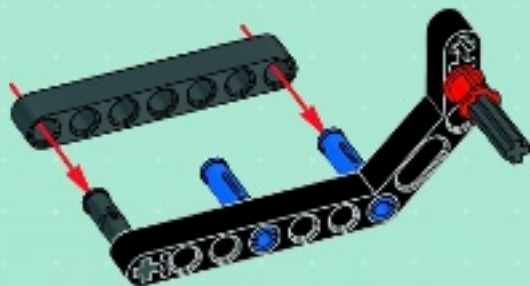

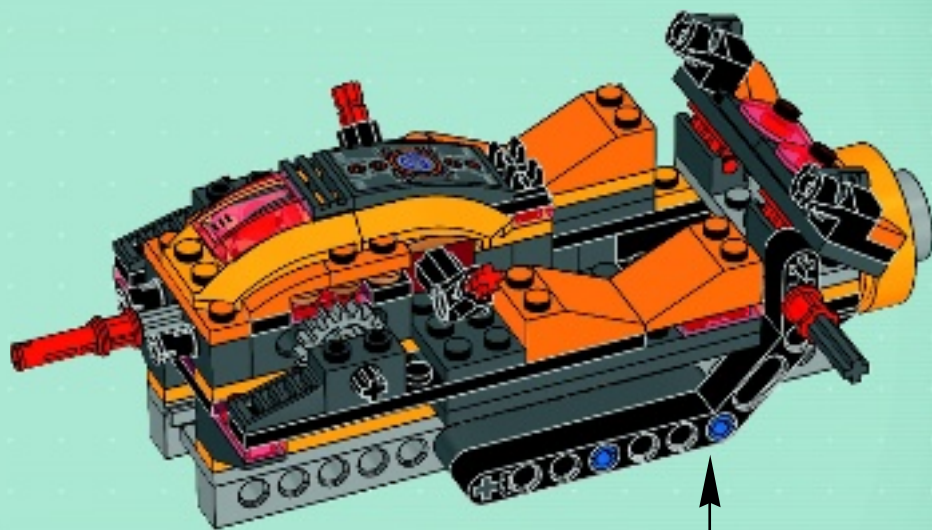

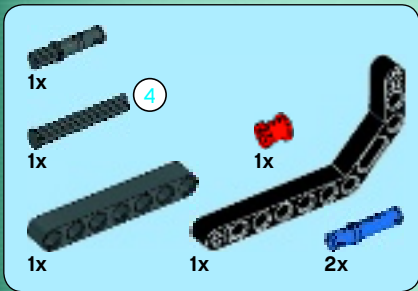
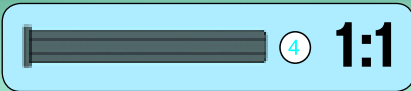

34

1



2

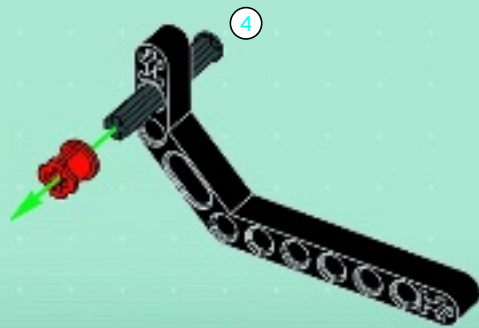

3

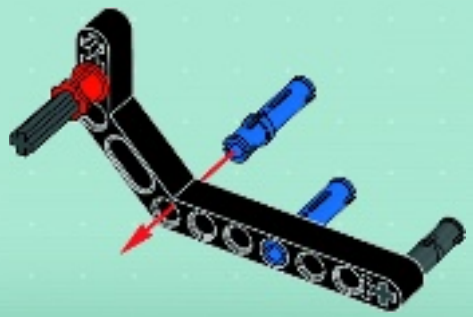

4

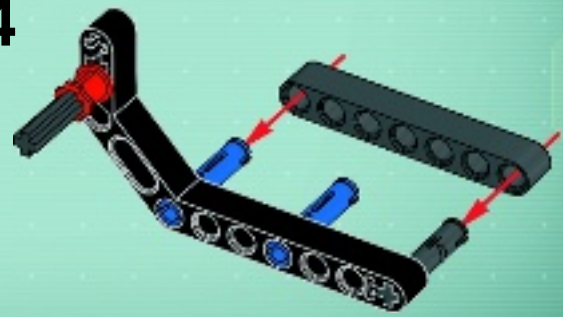

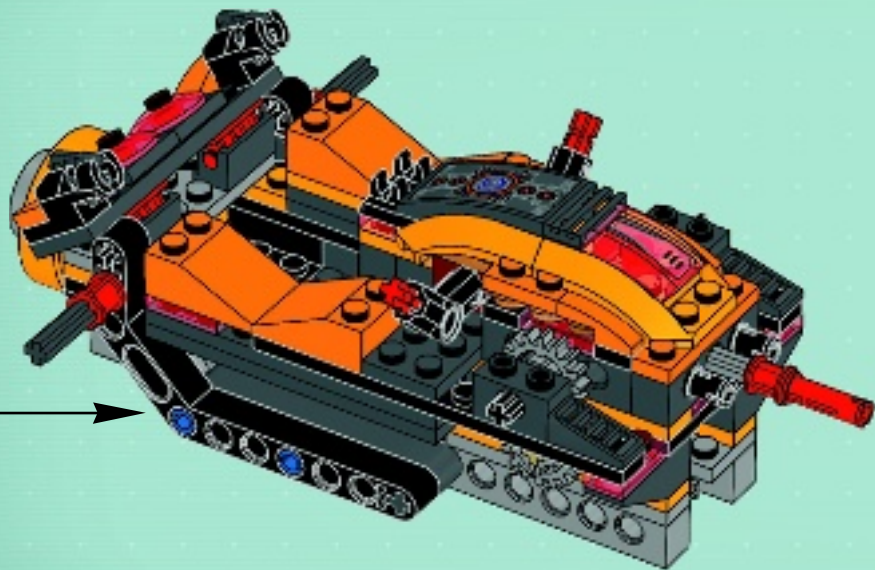



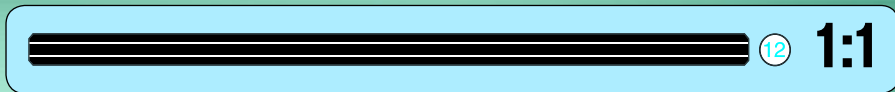
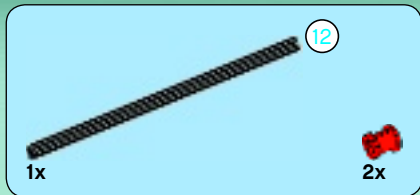

35

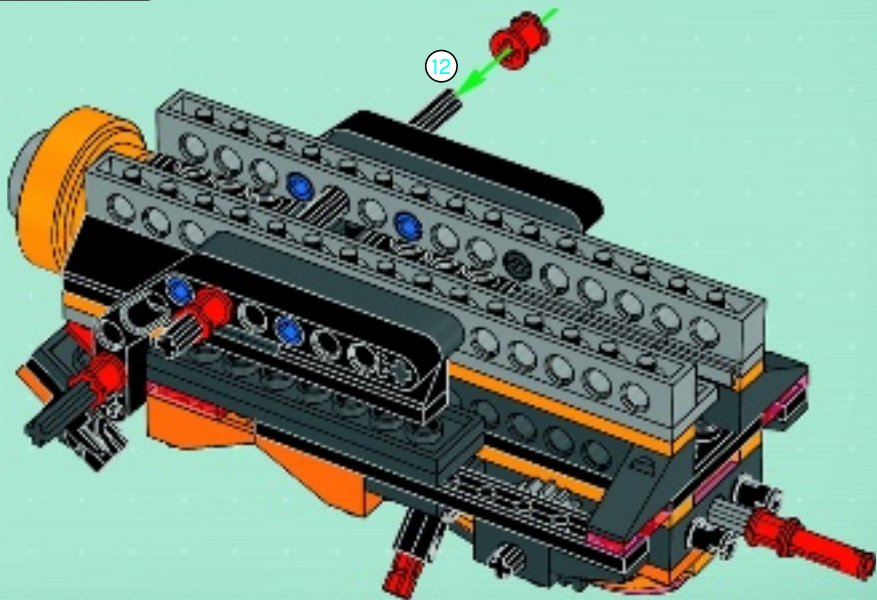
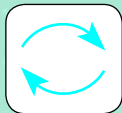

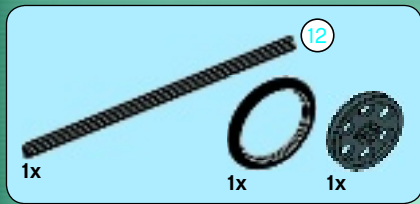

36

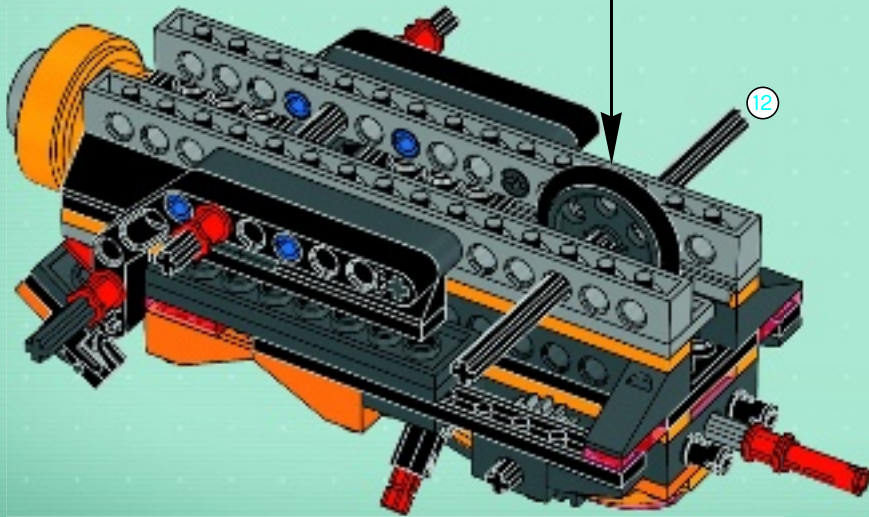

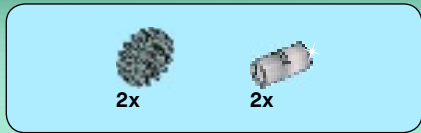

# 37

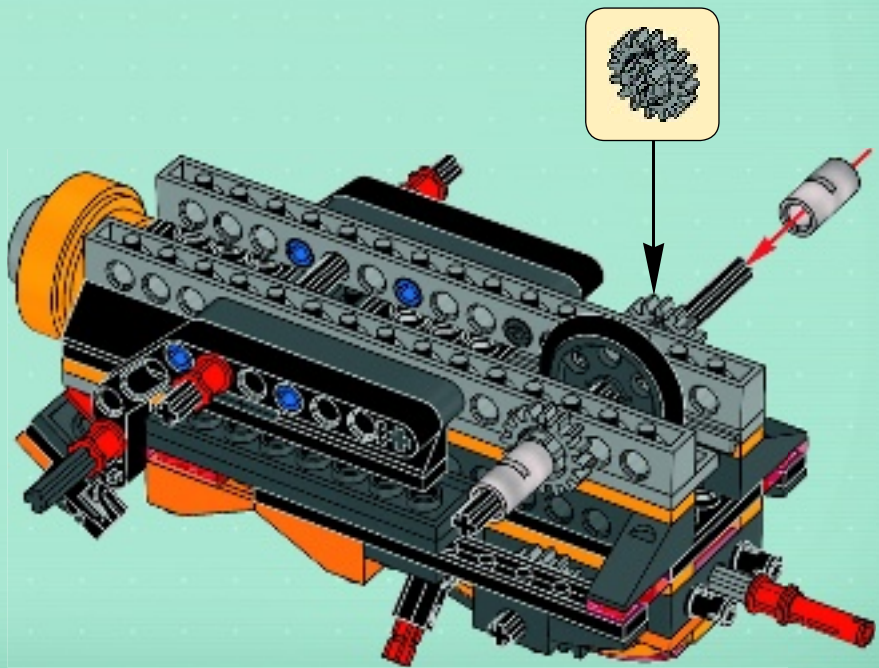



6x



6x

# 38

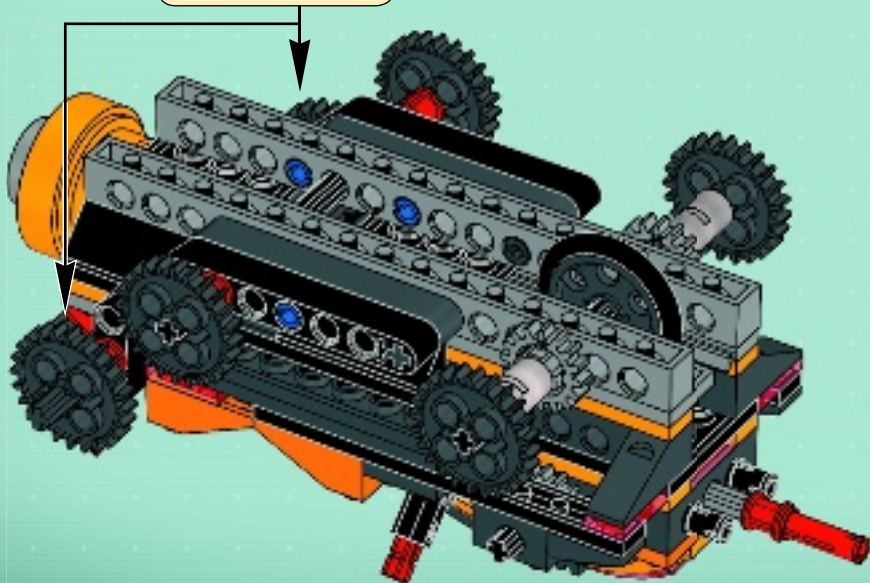



# 39

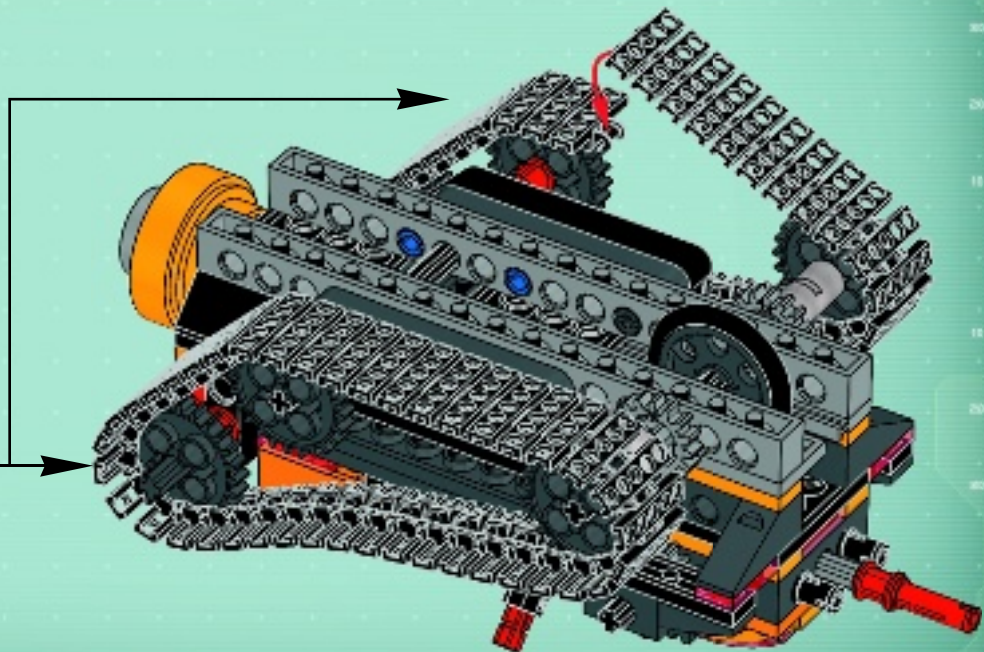
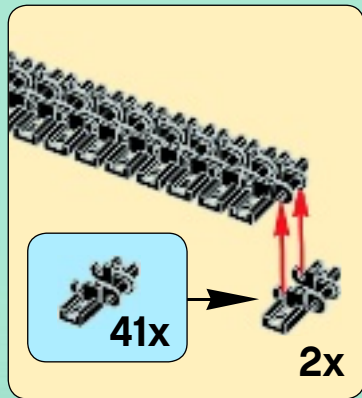



40

1

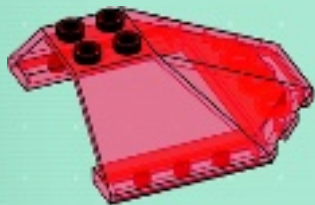

2



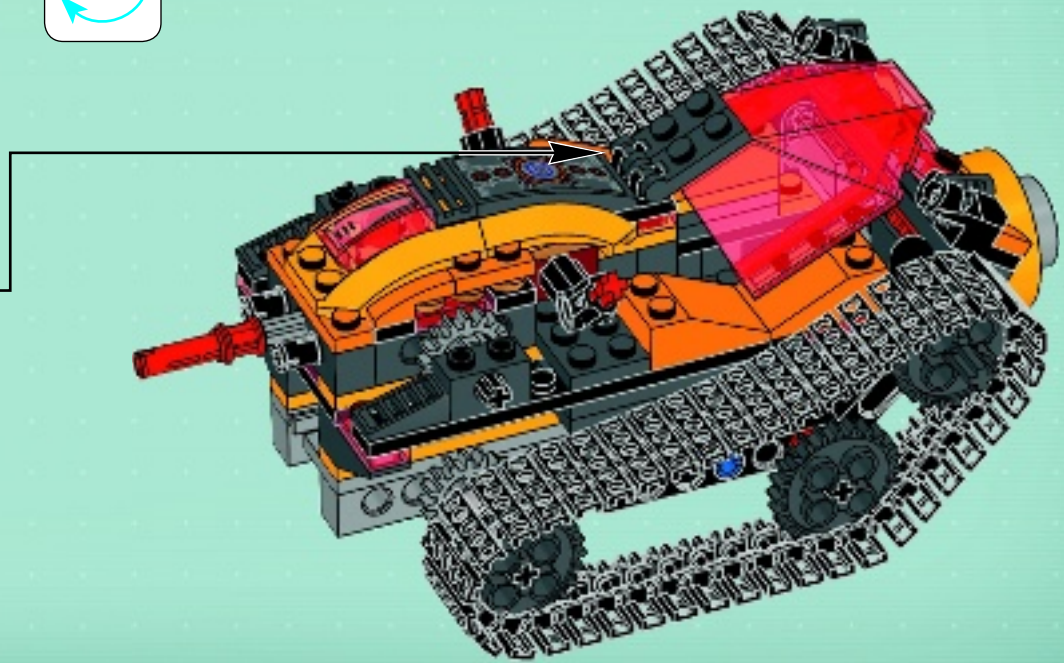
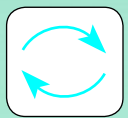

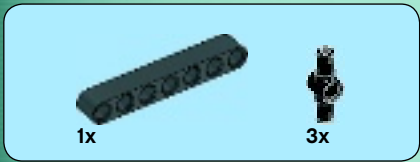

1



2







1x



1x

3

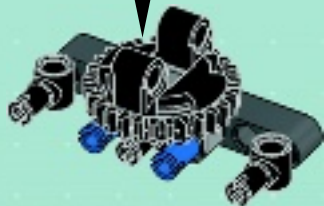
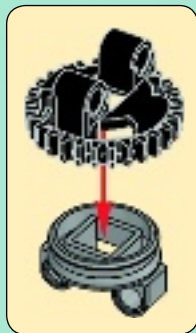

1x

4



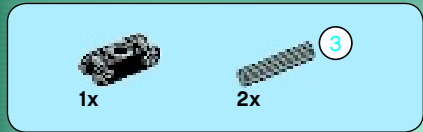

5

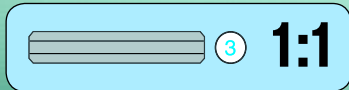
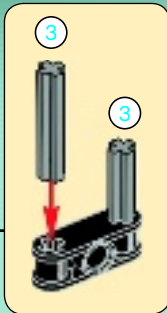

6

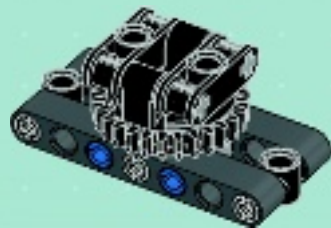

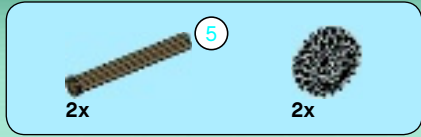

7

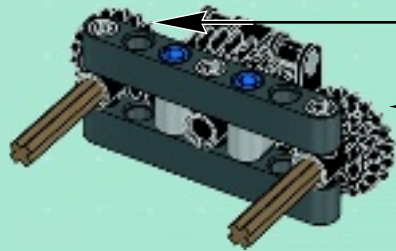
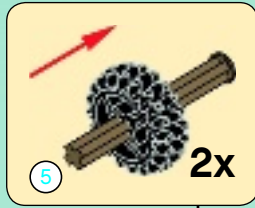
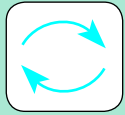



1x

8

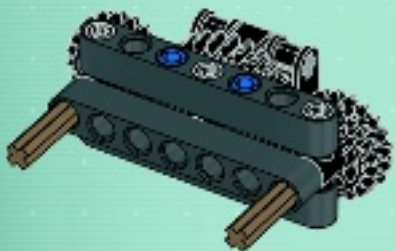

2x

9

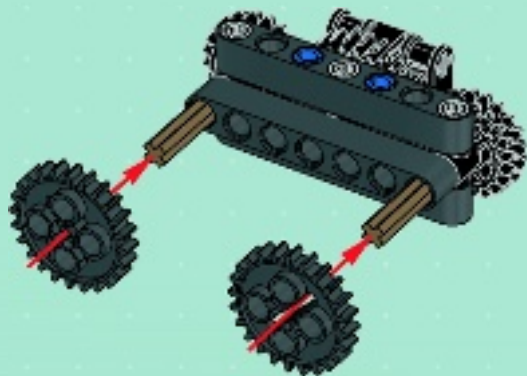



2x

10

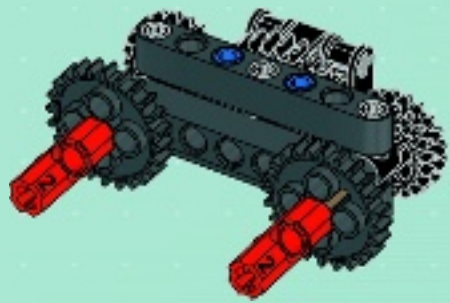



11

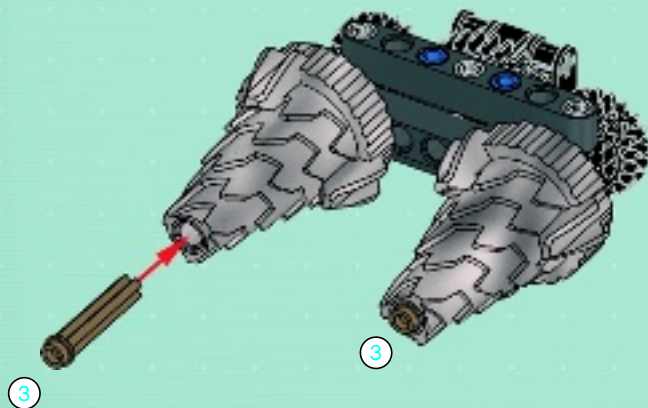

41

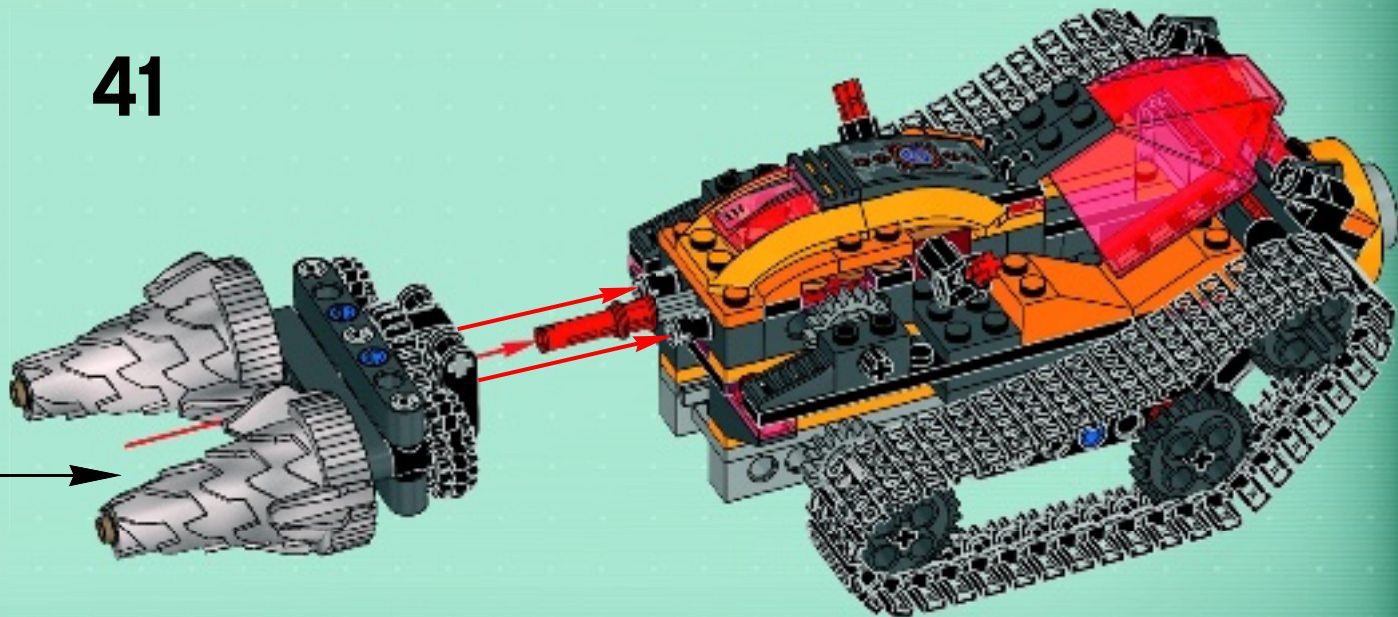

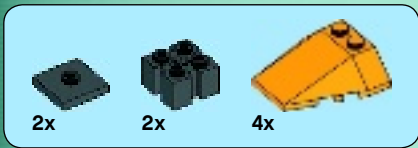
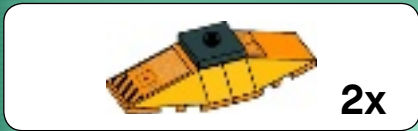

42

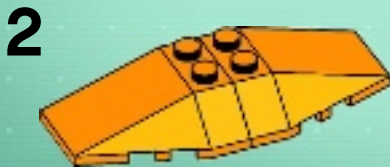

3



4

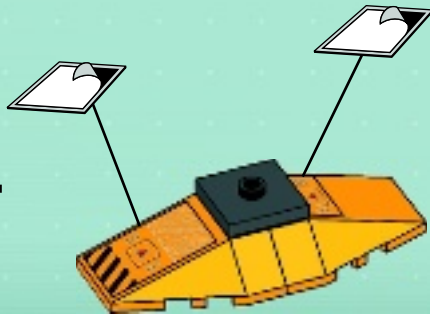

2x



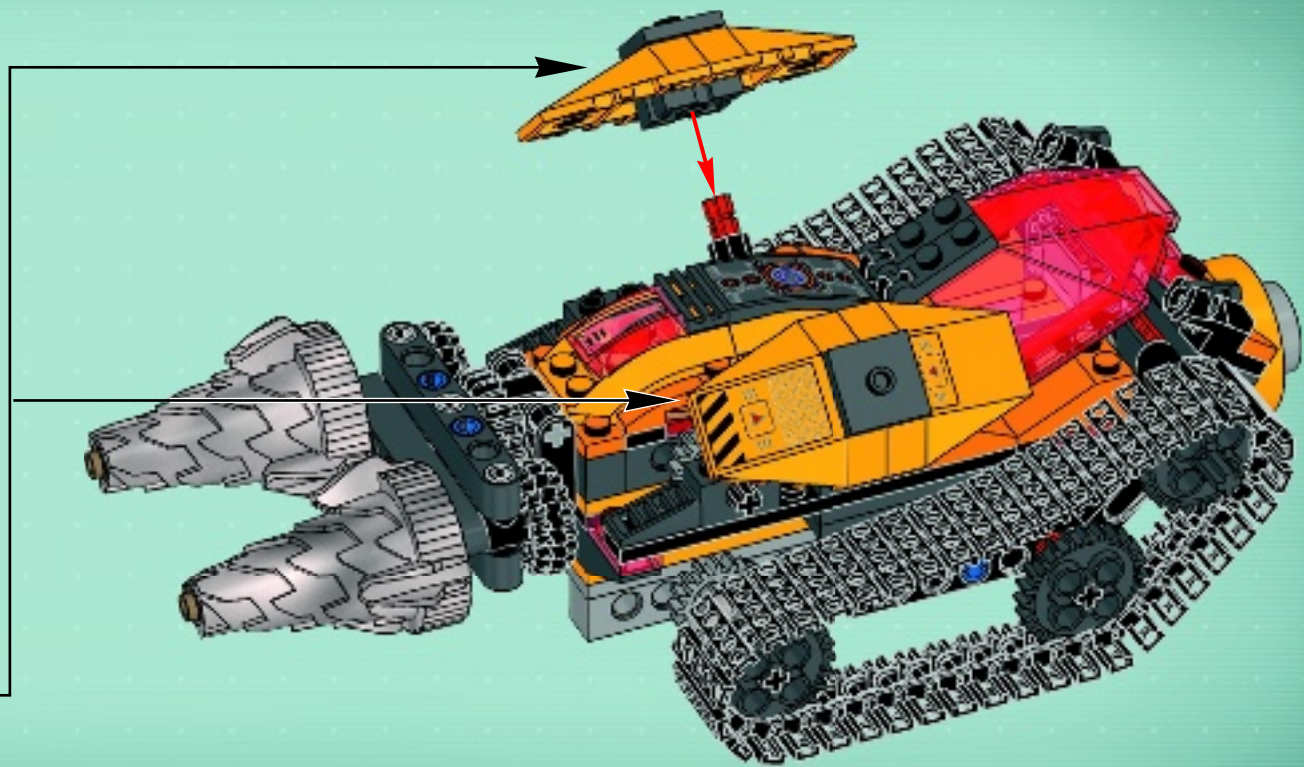



43

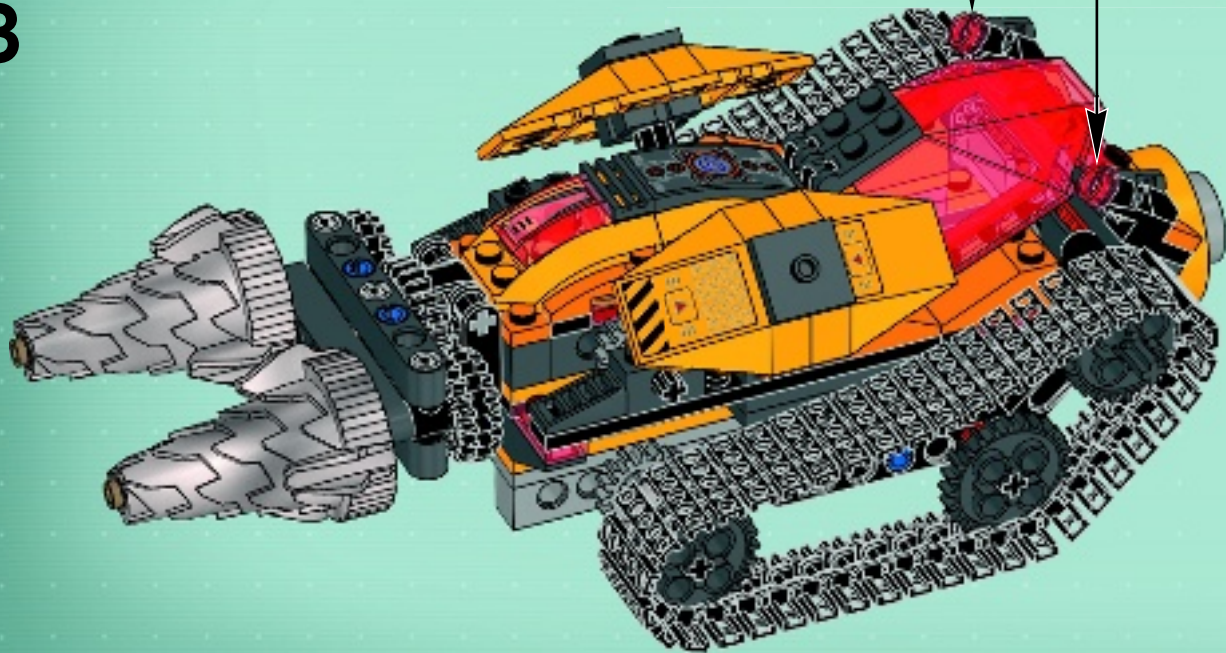

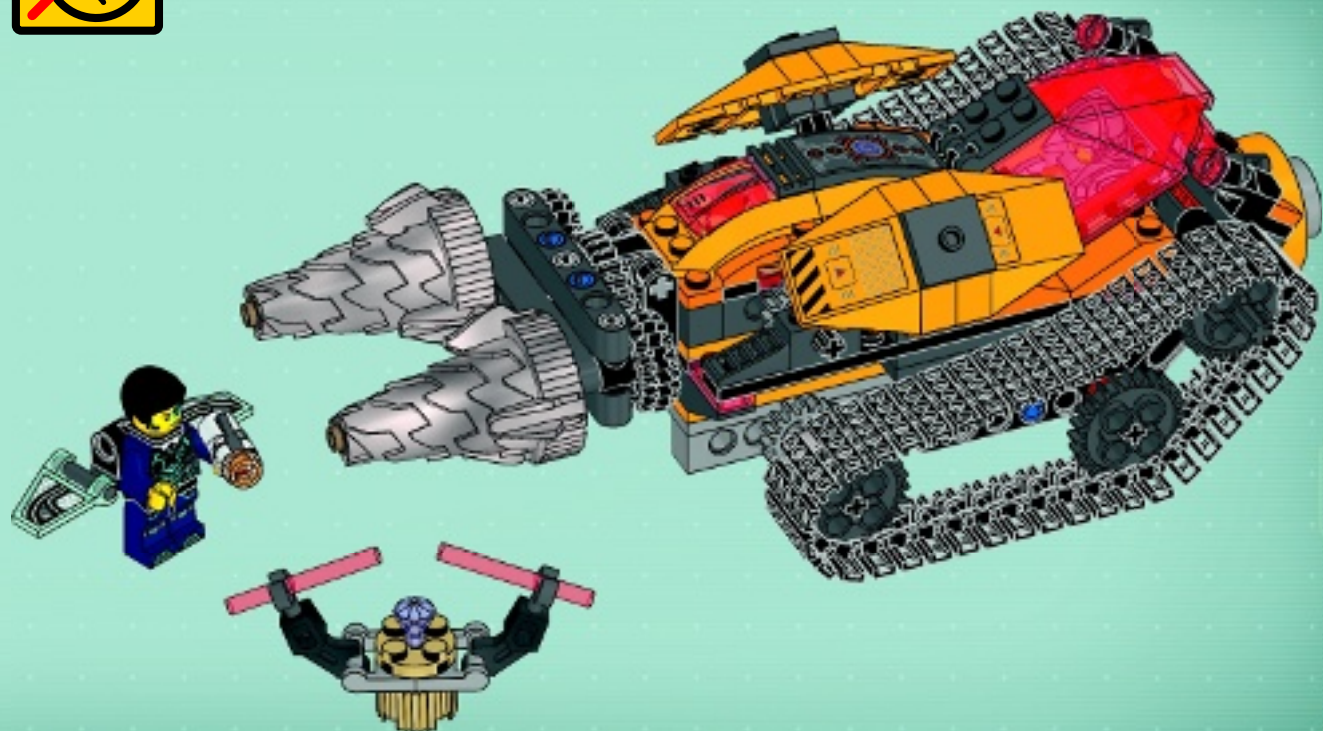



1x



3x



1x



1x

1



2



3



4



**Download the app  
and use the AppBrick Gadget  
to complete the mission!**



**Lade die App herunter und beende die Mission mithilfe des AppBrick-!  
Télécharge l'application et utilise l'AppBrick pour réussir ta mission !  
¡Descarga la app y usa el AppBrick para completar la misión!  
Descarrega a app e usa o Gadget AppBrick para completares a tua missão!  
Töltsd le az appot és az AppBrick eszközzel teljesítsd a küldetését!**

**下载应用程序并使用 AppBrick 工具来完成任务!**

Available on the  
**App Store**

ANDROID APP ON  
**Google play**

Available on  
**Samsung Apps**

Apple, the Apple logo, iPad, iPhone and iPod touch are trademarks of Apple Inc., registered in the U.S. and other countries. App Store is a service mark of Apple Inc. Google Play is a trademark of Google Inc.

# **Unlock the secrets with the new AppBrick Gadgets**



**Schalte geheime Inhalte mit den neuen AppBricks frei!**

**Découvre de nombreux secrets avec l'AppBrick**

**Descubre los secretos con los nuevos AppBricks**

**Desbloqueia os segredos com os novos Gadgets AppBrick**

**Tárd fel a titkokat az új AppBrick eszközökkel!**

**使用新的 AppBrick 工具来解锁秘密**



# ULTRA AGENTS



70166



70167



70168



70169



70170



42034



42035



42033



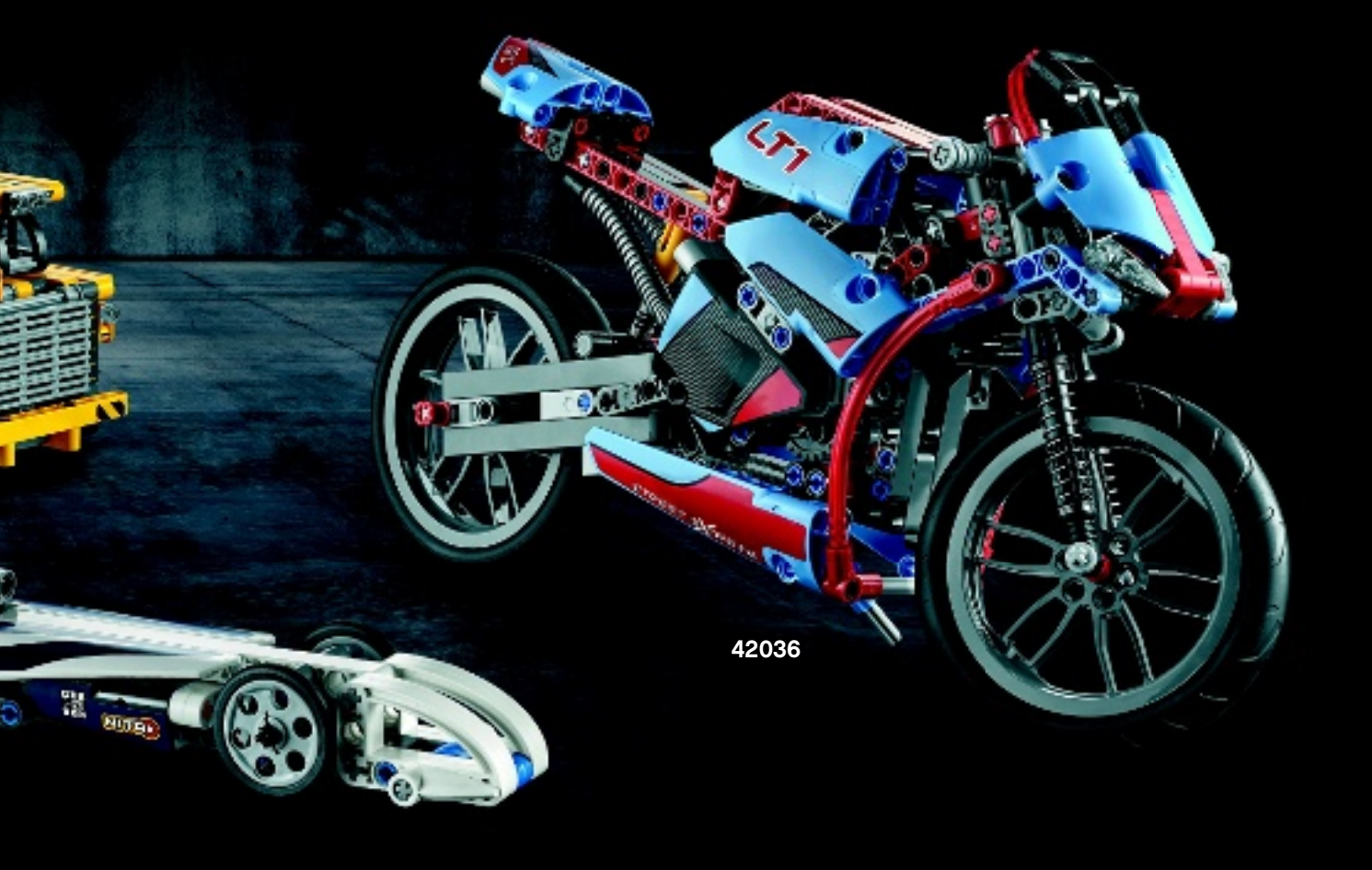

42036





1x  
4211387



2x  
4211443



2x  
4211452



3x  
4211568



2x  
4244627



1x  
4299119



2x  
4211815

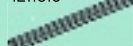

1x  
4211805



1x  
4652235



5x  
4640536



2x  
4210978



2x  
4583879



3x  
4211111



3x  
4213607



2x  
4210917



1x  
4211054



2x  
4211068



2x  
4294180



1x  
6005668



1x  
4210631



4x  
4565322



6x  
4210997



2x  
4521187



1x  
4263176



2x  
4540386



2x  
4289542



3x  
6051334



1x  
4210700



2x  
4211066



5x  
4495931



1x  
4587275



2x  
6015356



2x  
6083620



8x  
4514558



1x  
6065515



6x  
4523159



1x  
4286597



3x  
4612829



2x  
6054858



2x  
4609774



1x  
6104684



1x  
6103305



2x  
6008484



2x  
6104199



1x  
6056236



3x  
6103777

Customer Service

Kundenservice

Service Consommateurs

Servicio Al Consumidor

LEGO.com/service or dial



: 00800 5346 5555

: 1-800-422-5346



# LEGO.com/productfeedback

## GEWINNE



Erzähle uns auf  
[www.LEGO.com/productfeedback](http://www.LEGO.com/productfeedback)

etwas über die Erfahrungen, die du mit  
diesem LEGO® Set gemacht hast, und  
sichere dir die Chance auf einen coolen  
LEGO Preis!

## GAGNE



Rends-toi sur  
[www.LEGO.com/productfeedback](http://www.LEGO.com/productfeedback)

et donne-nous quelques commentaires  
sur ce produit LEGO® pour avoir une  
chance de gagner un prix LEGO !

## GANAN



Visita  
[www.LEGO.com/productfeedback](http://www.LEGO.com/productfeedback)

y envíanos tu opinión acerca de este set  
LEGO®. ¡Participarás en el sorteo de un  
premio LEGO!

## 获取奖品



登录  
[www.LEGO.com/productfeedback](http://www.LEGO.com/productfeedback)

给出关于此乐高®套装的简短反馈，  
就有机会获得炫酷乐高奖品

LEGO and the LEGO logo are trademarks of the LEGO Group. ©2015 The LEGO Group.