



MARVEL
**SUPER
HEROES**



76036





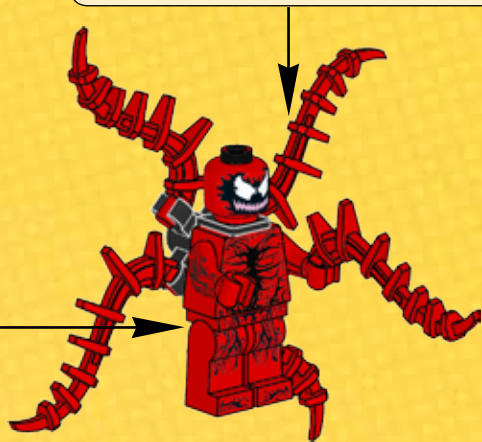
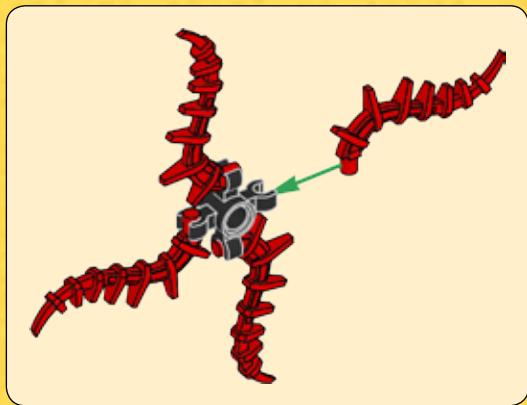
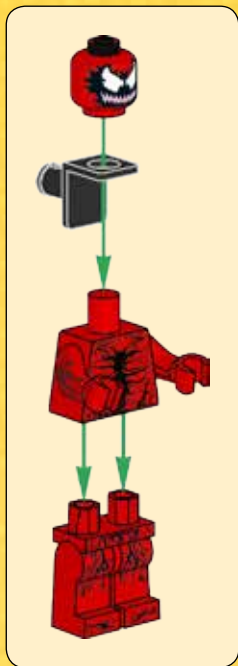

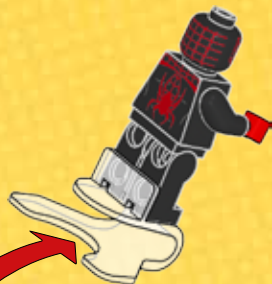
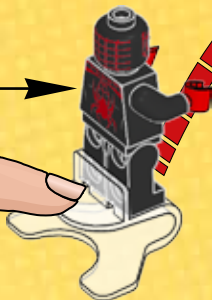
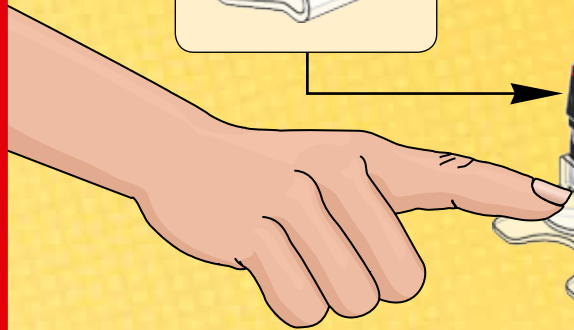
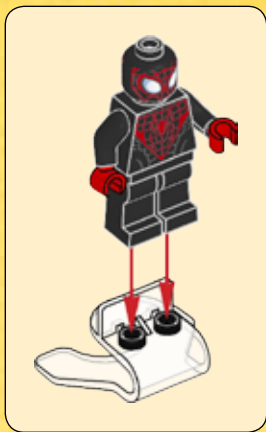

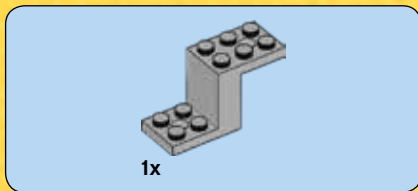

1

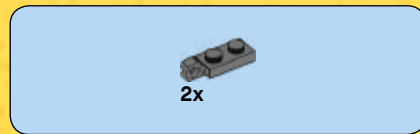
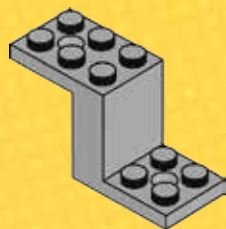

2

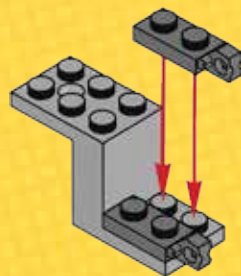



2x

3

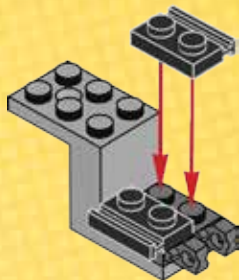

6



1x

4

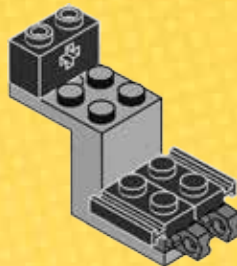



2x

5

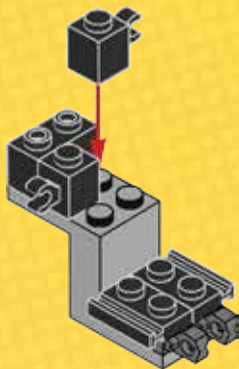

1x



1x

6

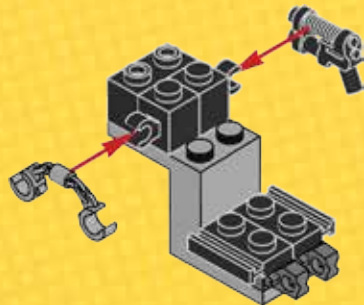



1x

7

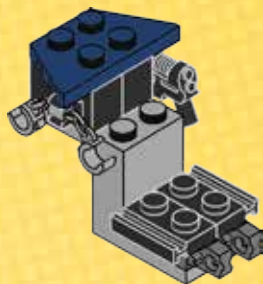

8



1x

8

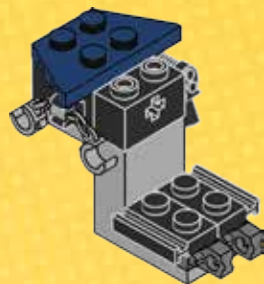



1x



1x

9

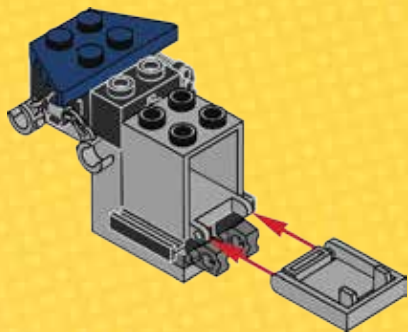

3x

10

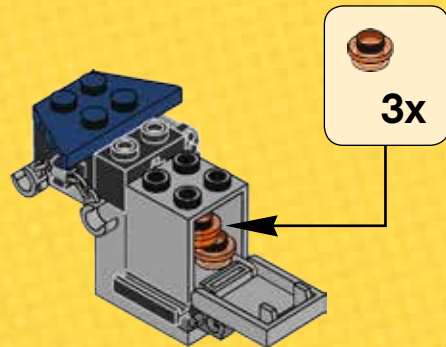



2x

11

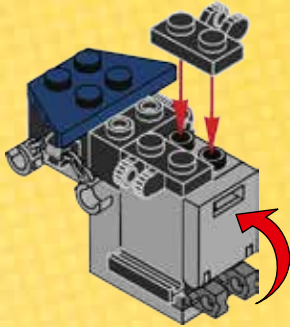

1x

12

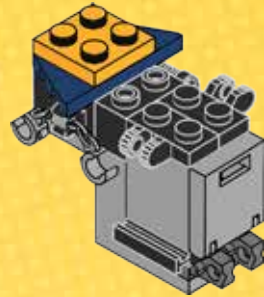



1x

13

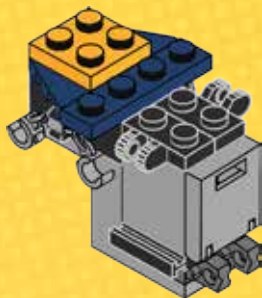

1x

14

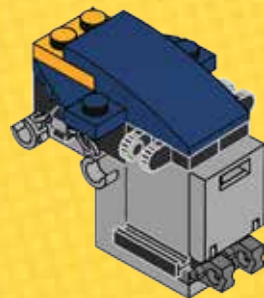

15

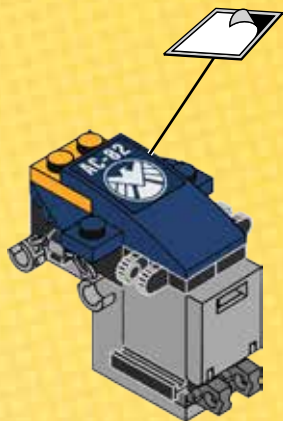

16

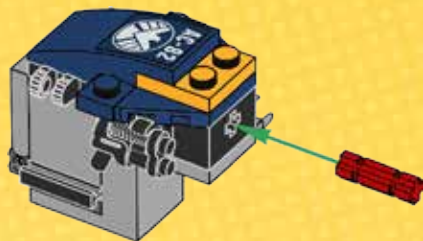
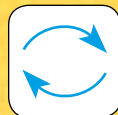



1x



2x



1x



1x



1x



1x

17

1



2



3



4

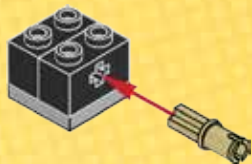

5



6



7

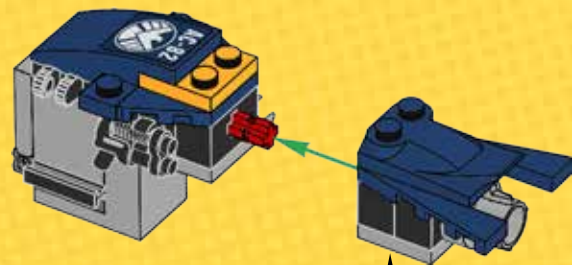



2x

18

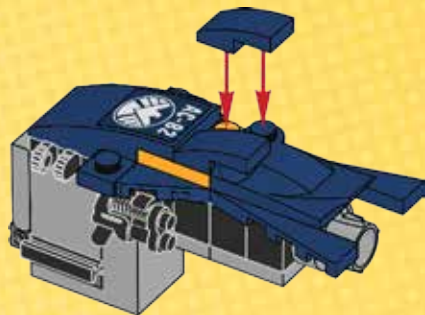

1x

19

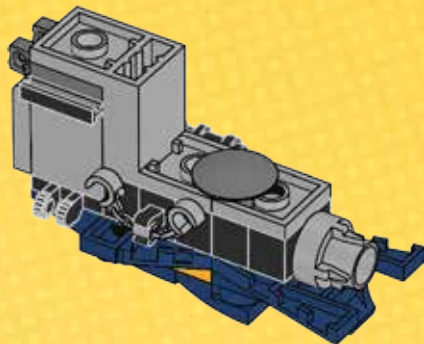



2x



2x



2x

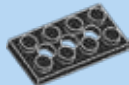

2x



2x



2x



2x



2x

20

1



2



3



4



5



6



7



8



2x

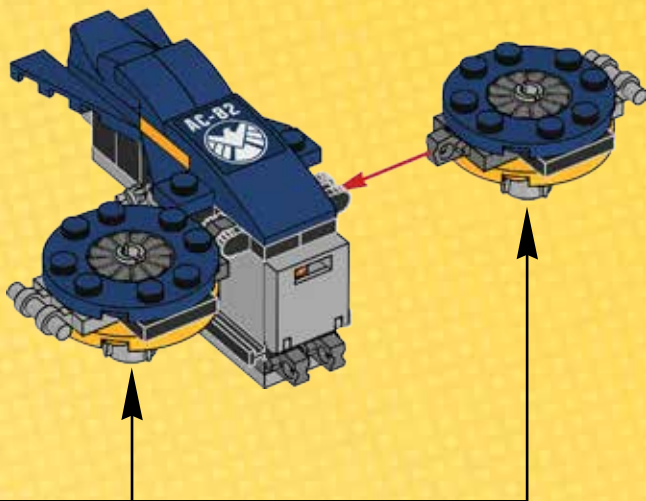



2x

21

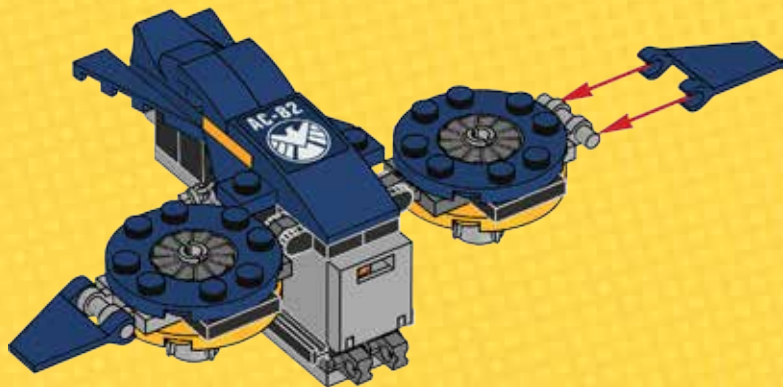



1x

1



2x

2

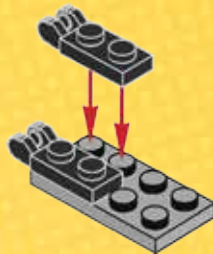



2x

3



1x

4





2x

5



2x

6

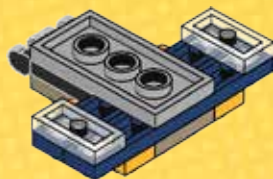



7

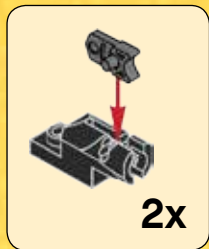
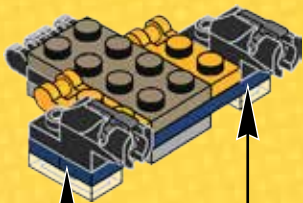

8

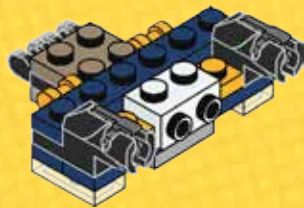



2x

9

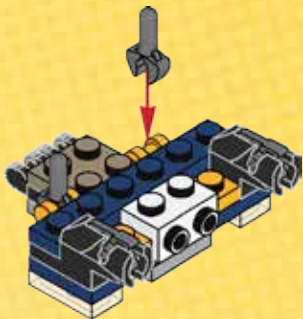

2x

10

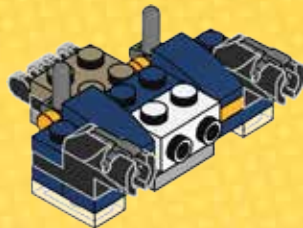



2x

11

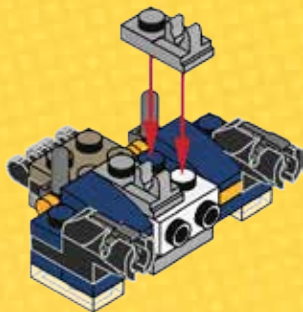

2x

12

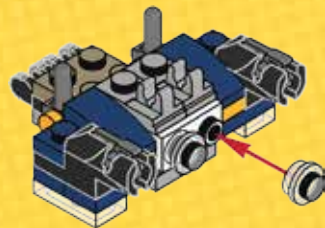

22

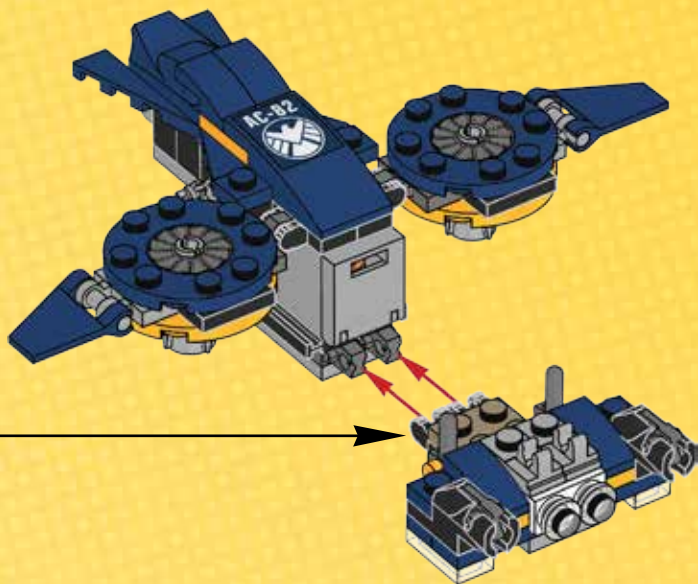

23

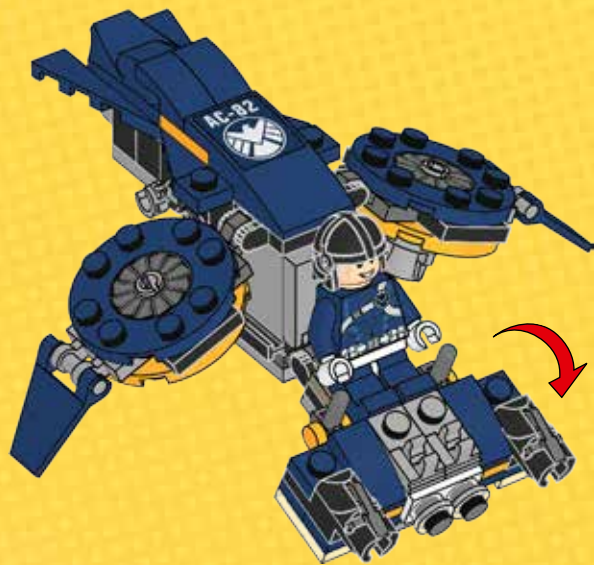



24

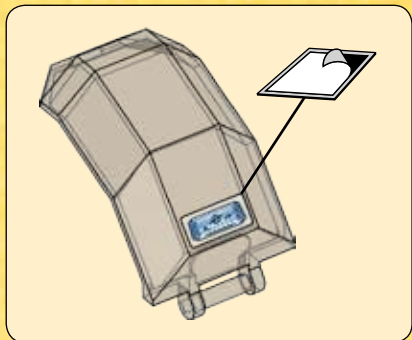
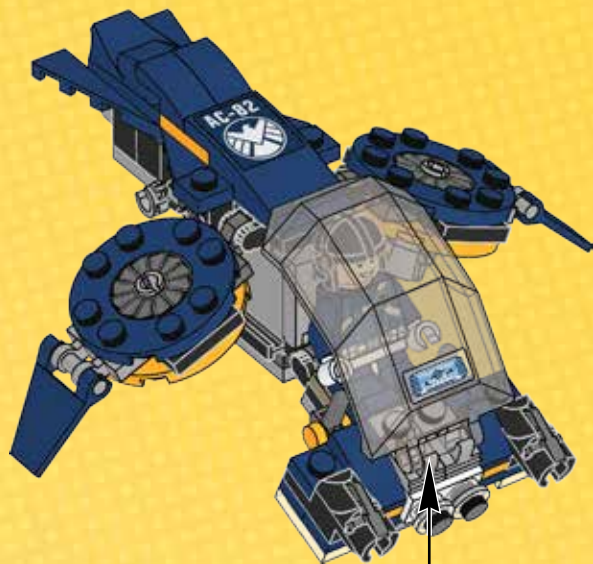



2x

25

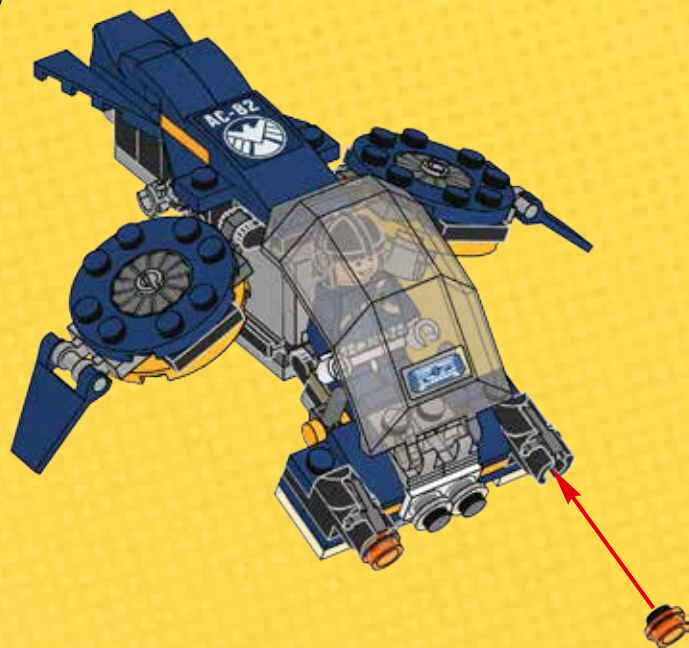





Customer Service

Kundenservice

Service Consommateurs

Servicio Al Consumidor

LEGO.com/service or dial



: 00800 5346 5555

: 1-800-422-5346

LEGO

MARVEL
SUPER
HEROES

76037



76036



76039



video games

COMING 2015

LEGO.com/videogames

MARVEL



7
www.pegi.info

PS3 PS4 PSVITA XBOX ONE XBOX 360 PC WiiU NINTENDO 3DS Nintendo eShop

©2015 The LEGO Group. © MARVEL.™ & © WBEI. (s15) Wii U, Nintendo DS and Nintendo 3DS are trademarks of Nintendo. © 2015 Nintendo. "PlayStation" and the "PS" Family logo are registered trademarks and the PlayStation Network Logo is a trademark of Sony Computer Entertainment Inc. KINECT, Xbox, Xbox 360, Xbox LIVE, and the Xbox logos are trademarks of the Microsoft group of companies and are used under license from Microsoft. All other trademarks and copyrights are the property of their respective owners. All rights reserved.



WIN

GO TO WWW.LEGO.COM/PRODUCTFEEDBACK AND
GIVE US YOUR SHORT **FEEDBACK** ABOUT THIS
LEGO® SET FOR A CHANCE TO WIN
A COOL LEGO PRIZE.



LEGO.com/productfeedback

GEWINNE



Erzähle uns auf
www.LEGO.com/productfeedback

etwas über die Erfahrungen, die du mit
diesem LEGO® Set gemacht hast, und
sichere dir die Chance auf einen coolen
LEGO Preis!

GAGNE



Rends-toi sur
www.LEGO.com/productfeedback

et donne-nous quelques commentaires
sur ce produit LEGO® pour avoir une
chance de gagner un prix LEGO !

GANAN



Visita
www.LEGO.com/productfeedback

y envíanos tu opinión acerca de este set
LEGO®. ¡Participarás en el sorteo de un
premio LEGO!

获取奖品



登录
www.LEGO.com/productfeedback

给出关于此乐高®套装的简短反馈，
就有机会获得炫酷乐高奖品

LEGO and the LEGO logo are trademarks of the LEGO Group. ©2015 The LEGO Group.

MARVEL

marvelkids.com

© MARVEL

6128702