



LEGENDS OF  
**CHIMA**  
TM



70227





[LEGO.com/brickseparator](https://LEGO.com/brickseparator)

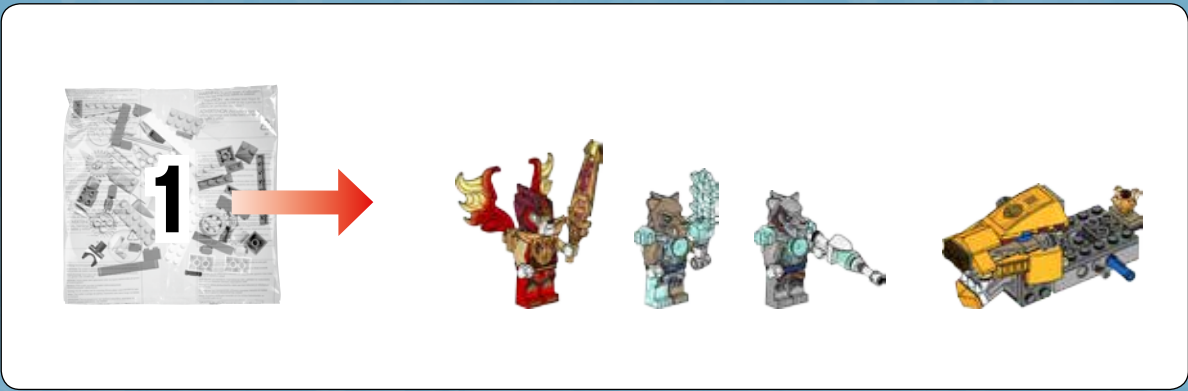



1x



1x



1x



1x



1x



1x

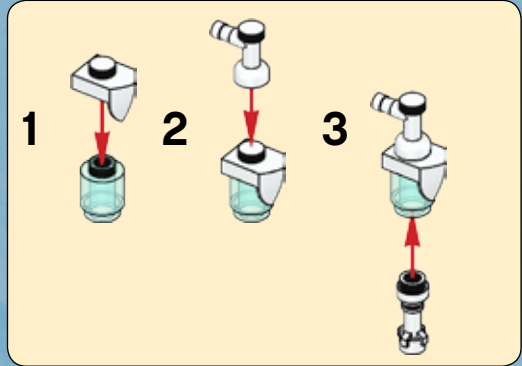
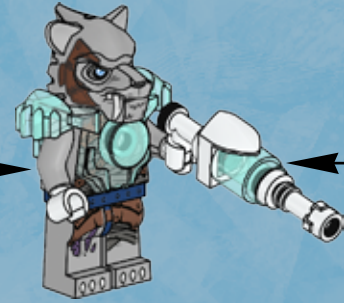
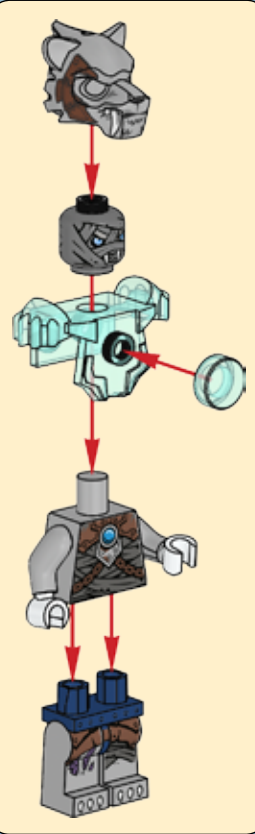
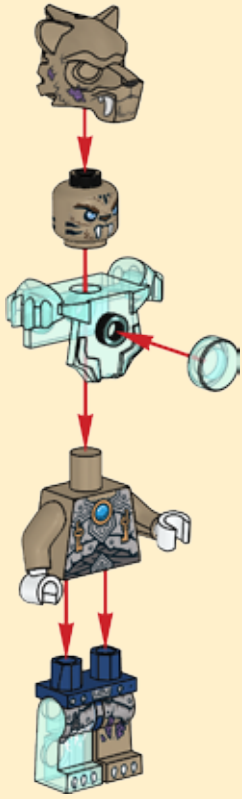

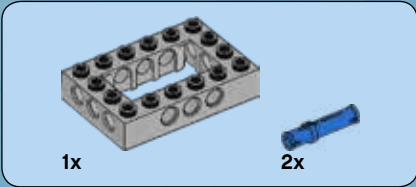
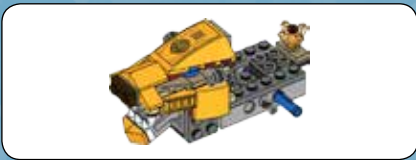

1

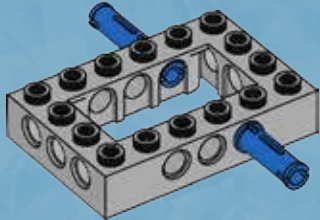

2

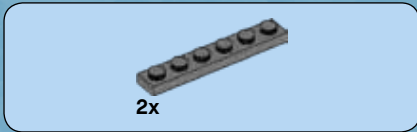
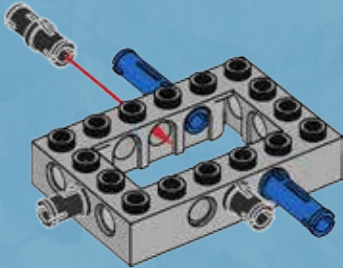

3

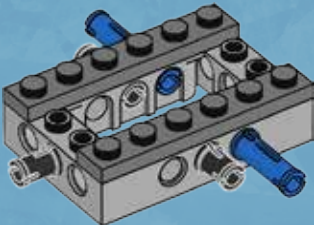

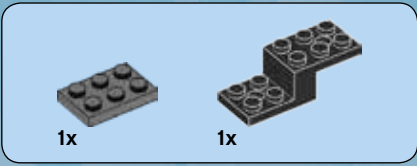

# 4

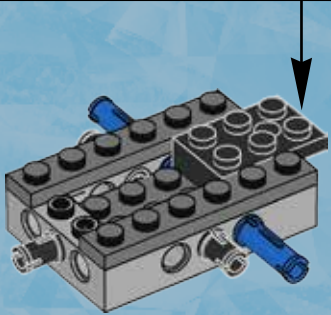
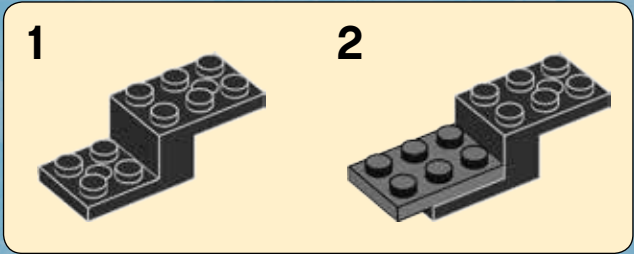

# 5

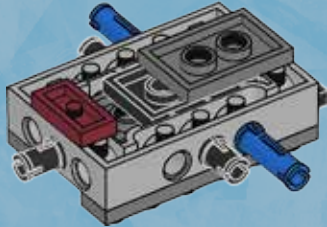



6

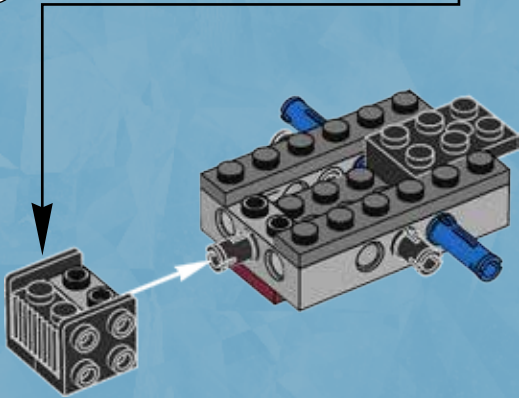
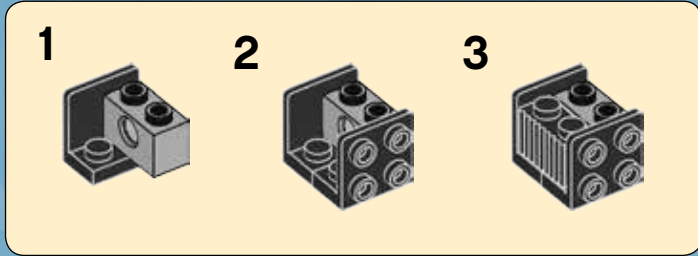

7

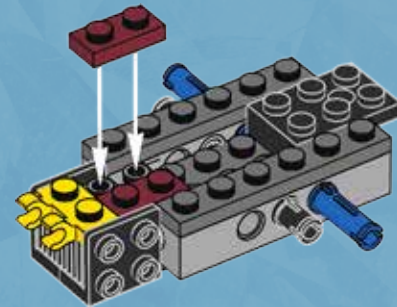



8

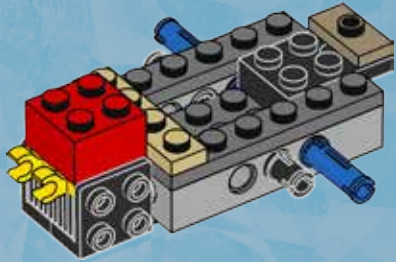

9

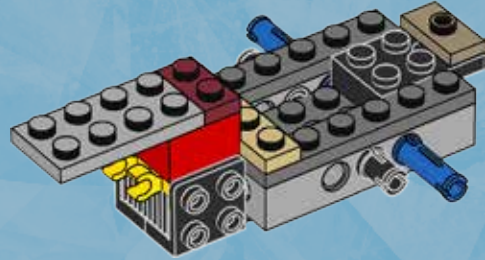

10

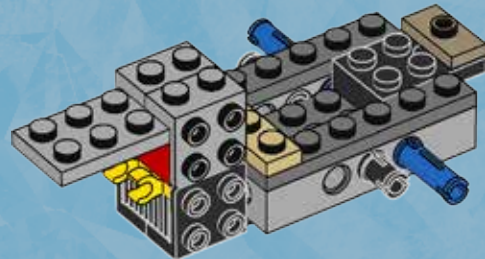





1x

# 11

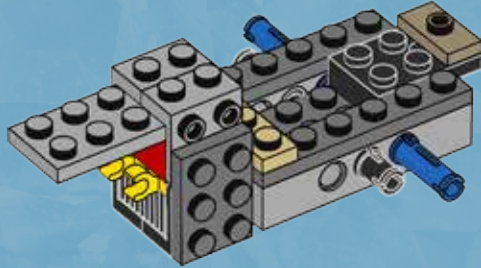

1x

# 12

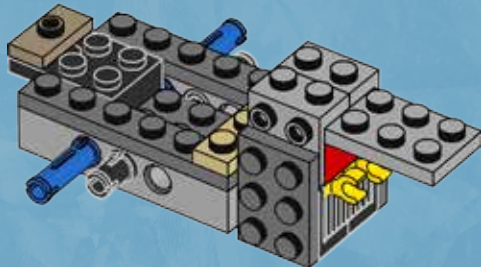

1x



1x



2x



1x

# 13

1

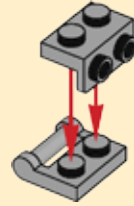

2

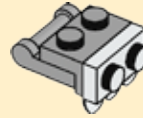

3

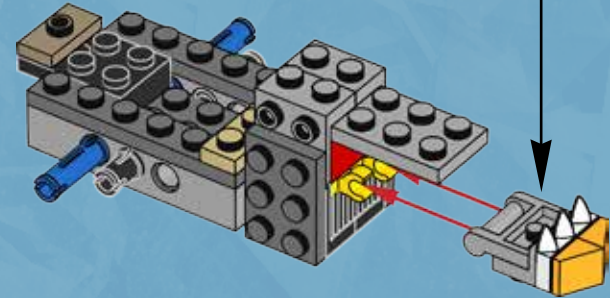
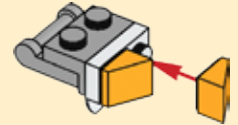



2x

# 14

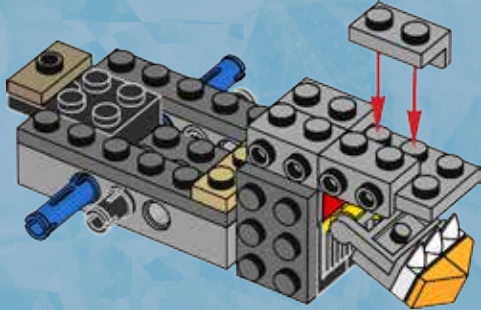

2x



2x

# 16

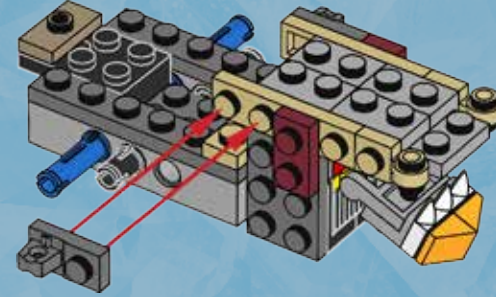

2x



2x

# 15

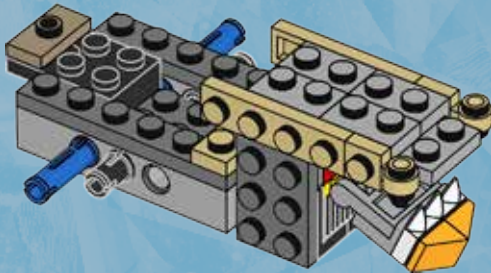

2x

# 17

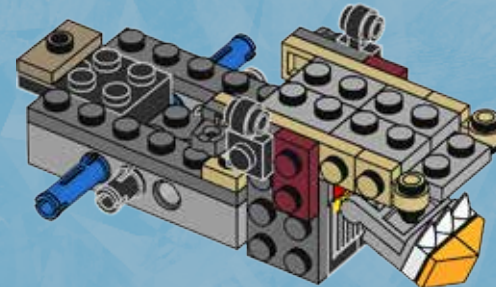



2x



2x

# 18

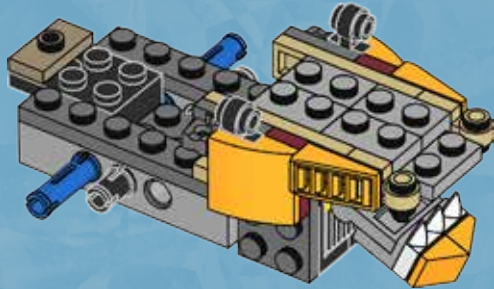

2x

# 19

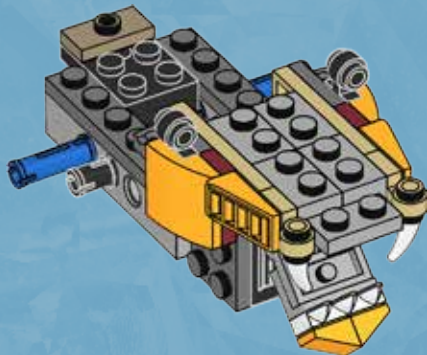

1x



2x

# 20

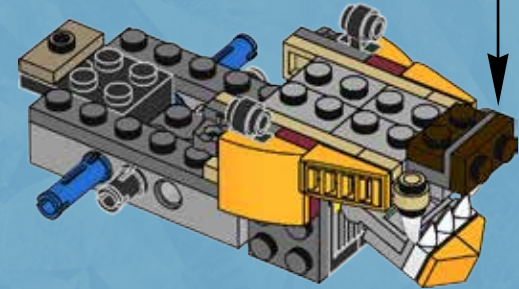
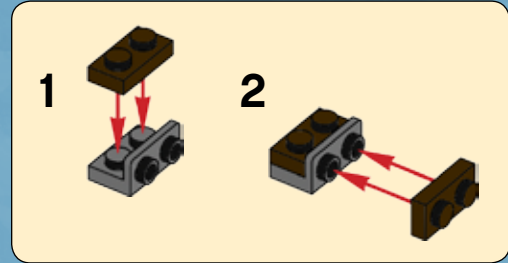



21

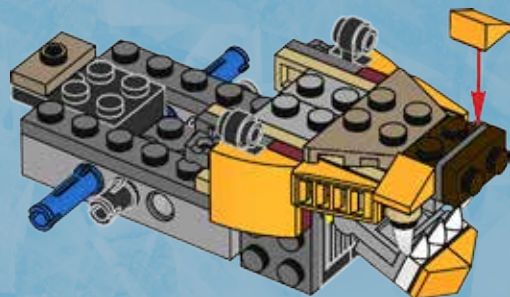

22

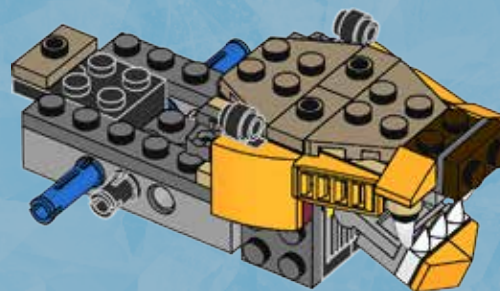

23

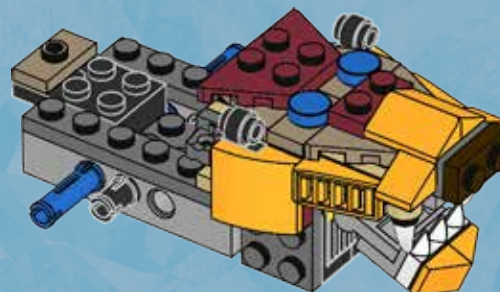

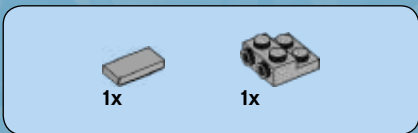

# 24

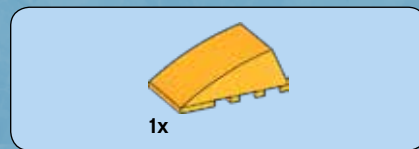
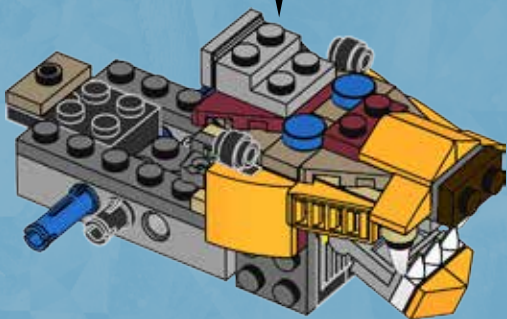
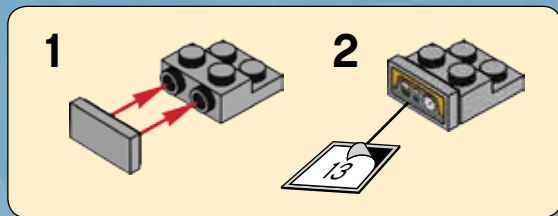

# 25

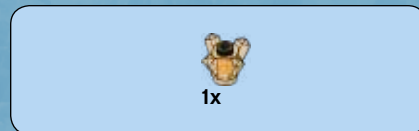
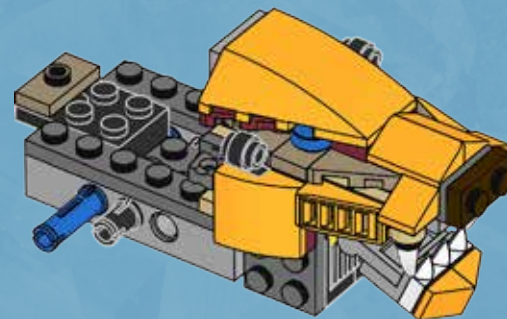

# 26

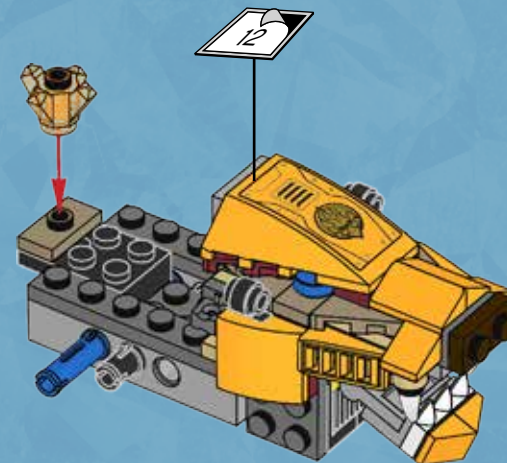

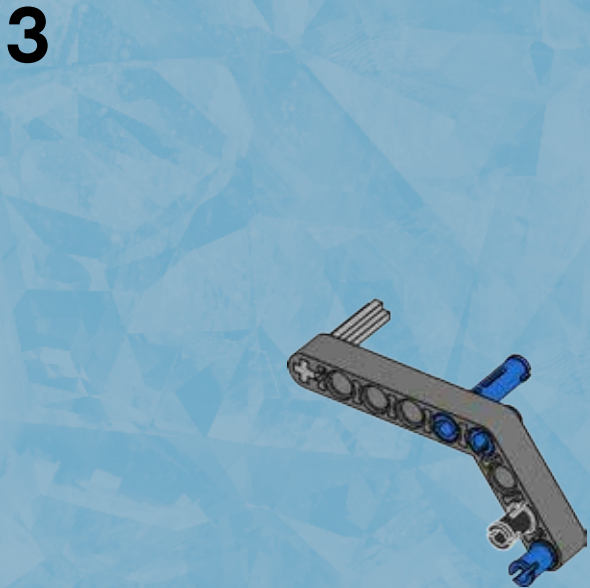
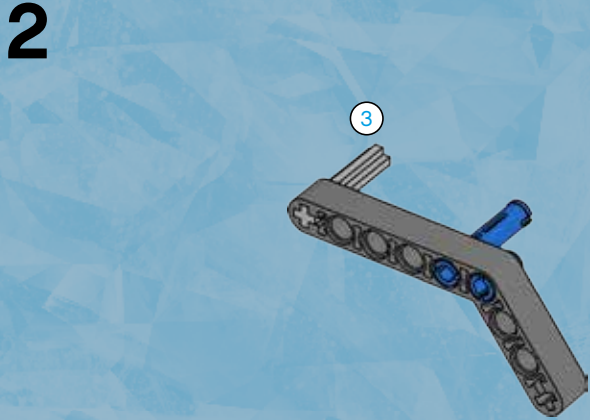
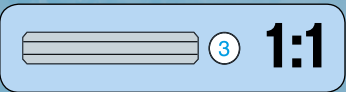
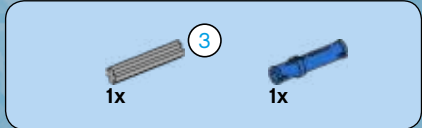
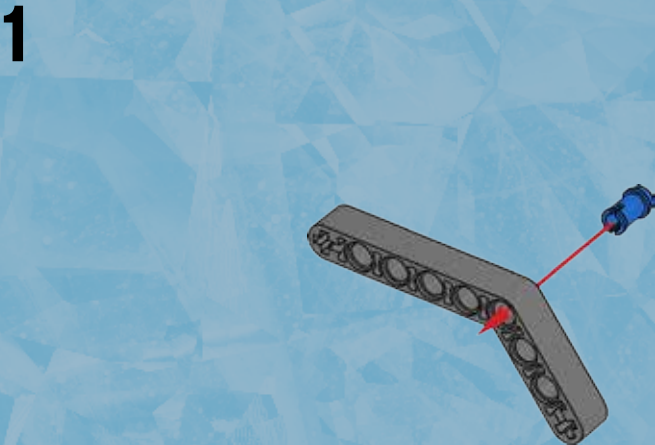
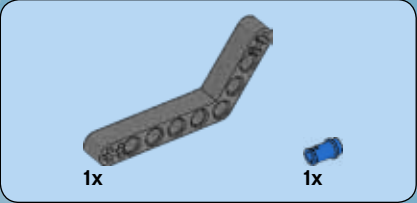
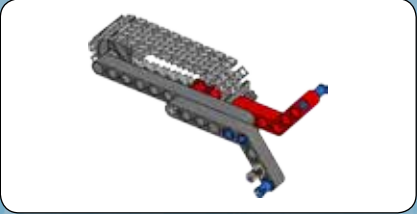
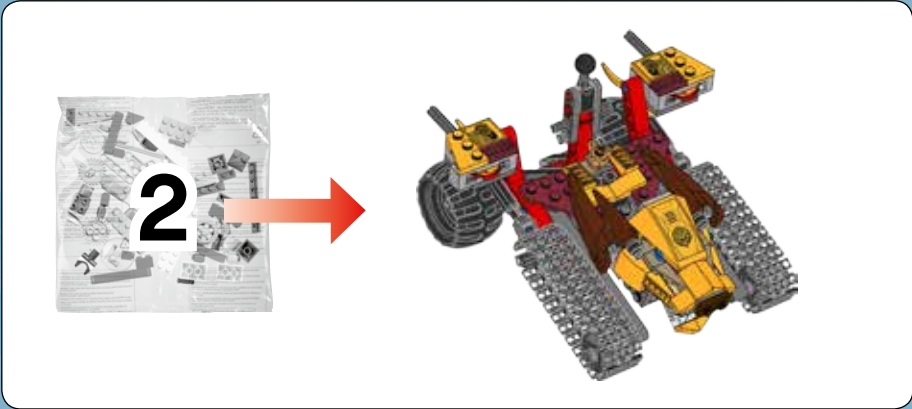

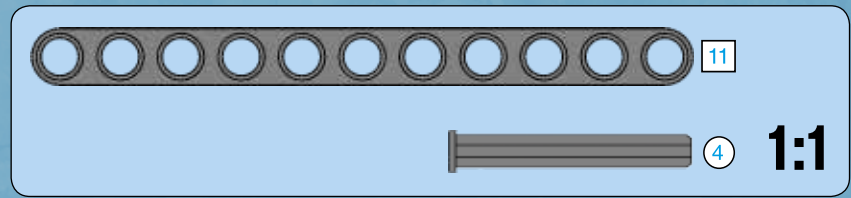
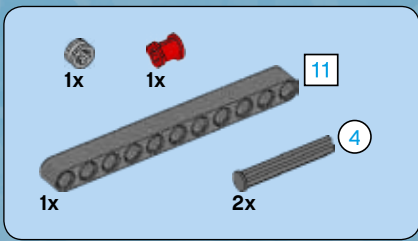

4

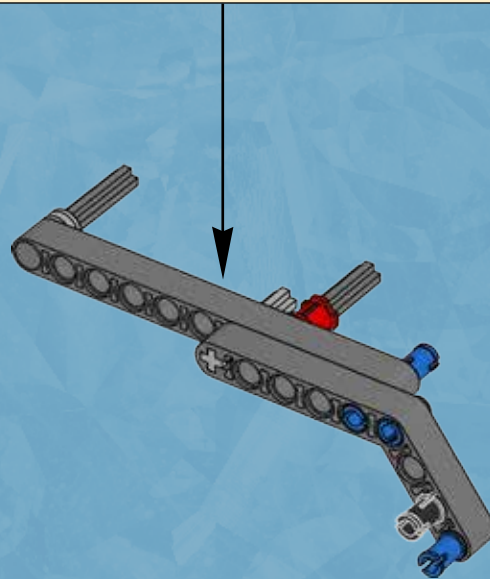
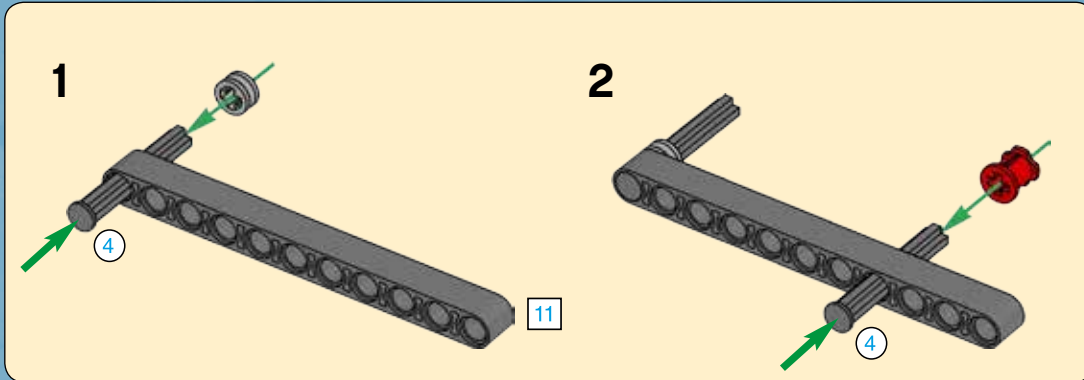



1x

5

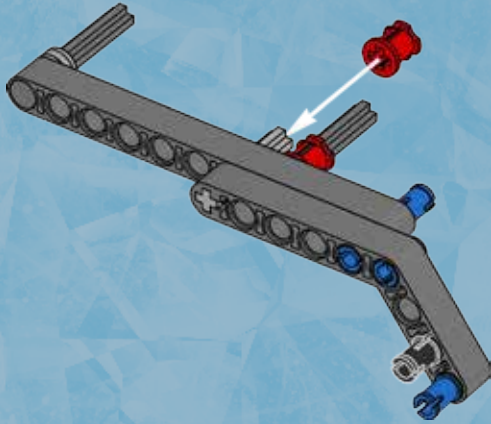

1x

1x

1x

6

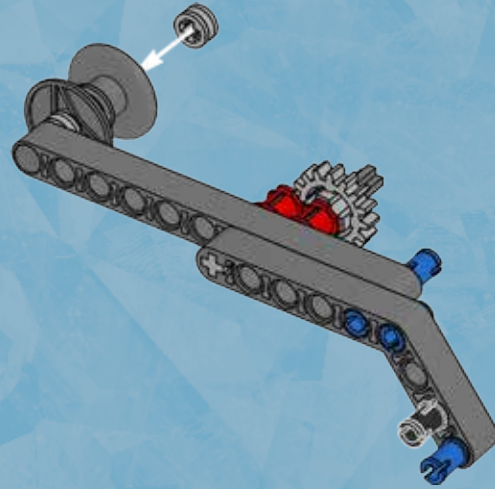





7

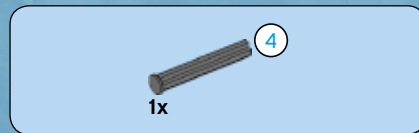
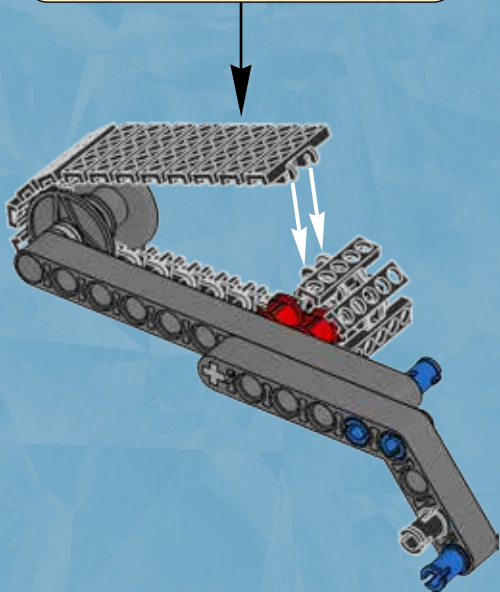
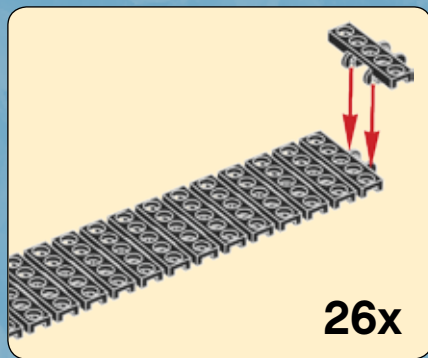

8

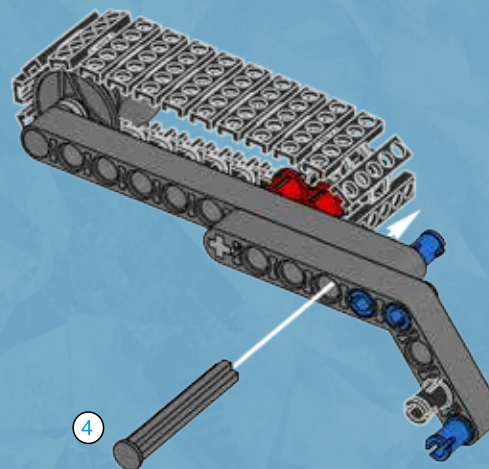
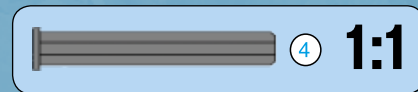



9

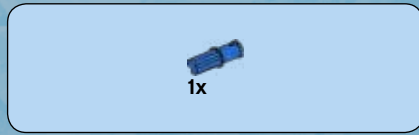
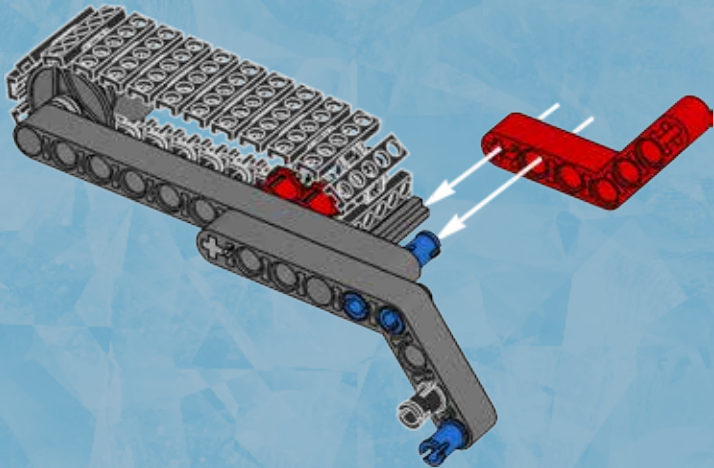

10

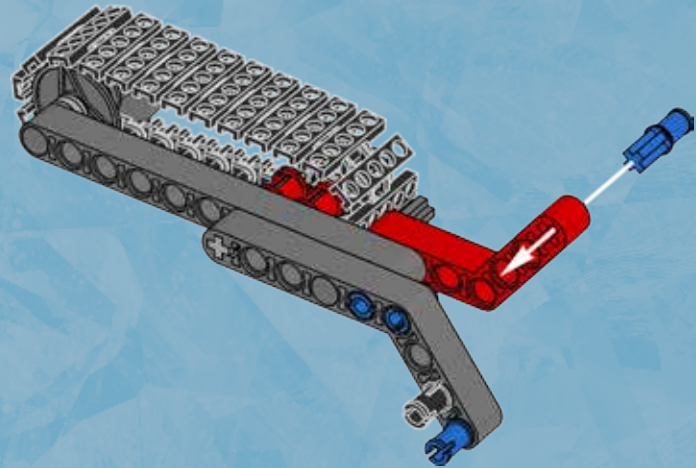



27

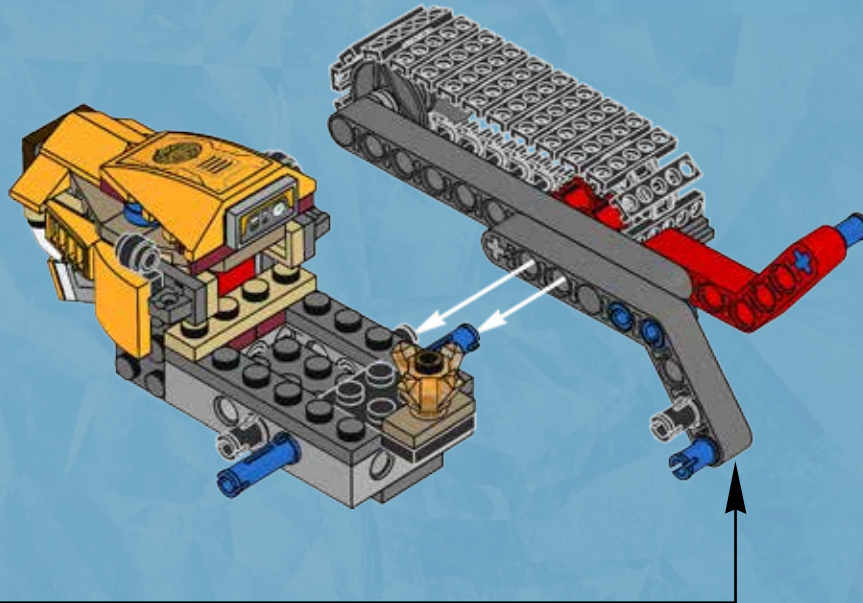

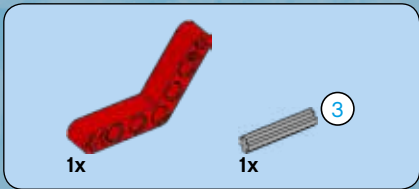
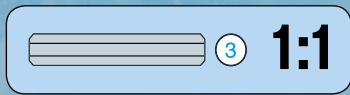

1

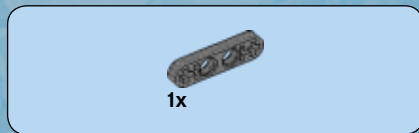
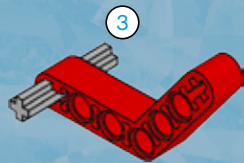

2

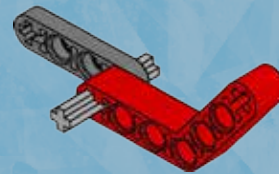

3

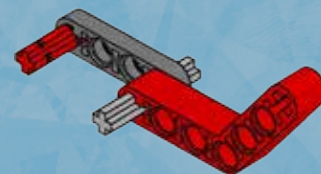

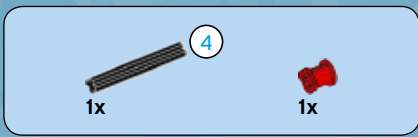

4

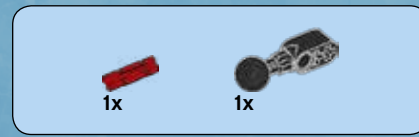
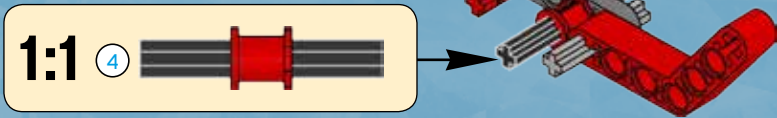

5

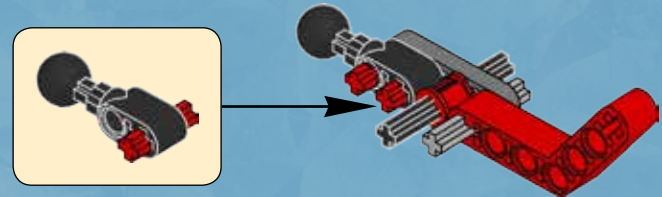

6



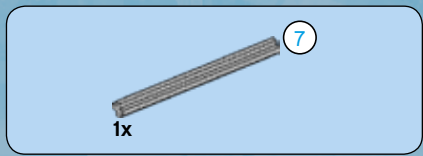

7

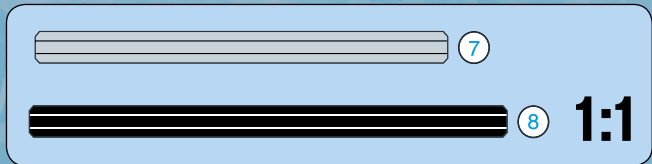
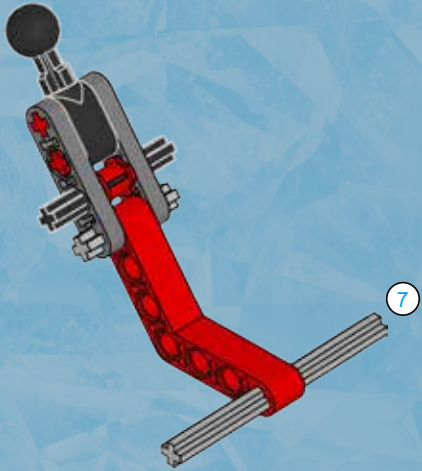

8

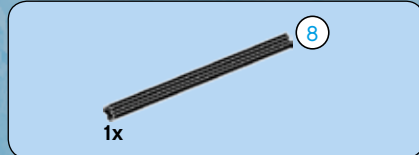
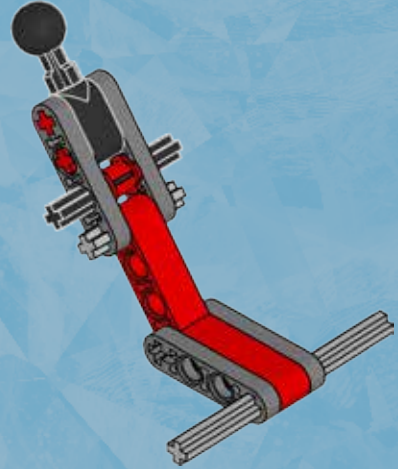

9

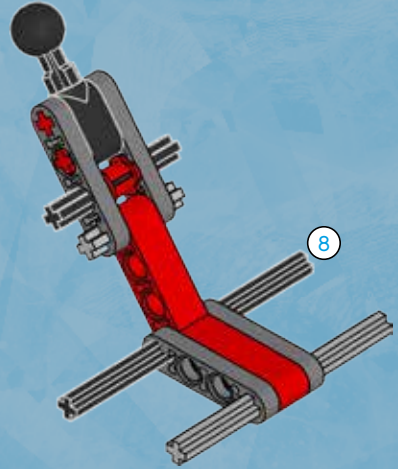

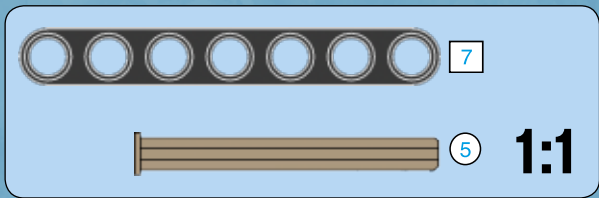
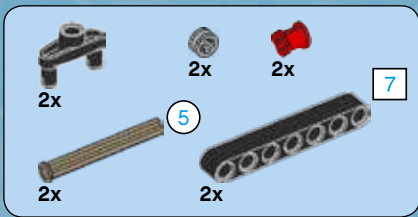

# 10

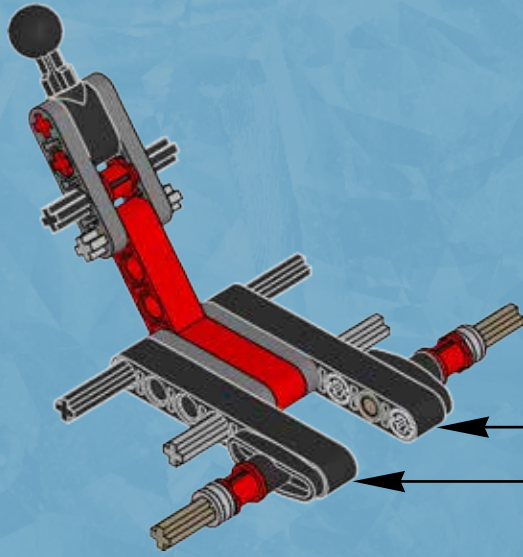
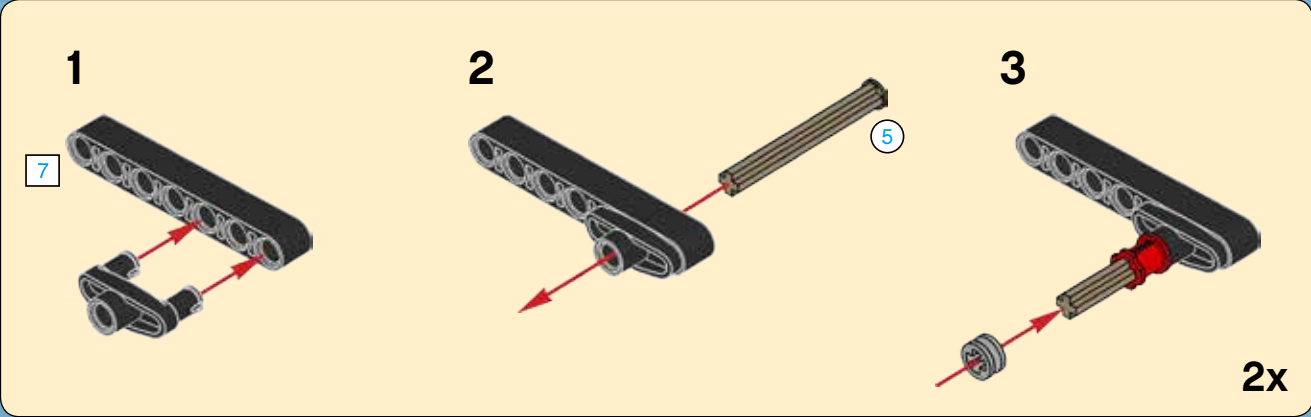



2x

11

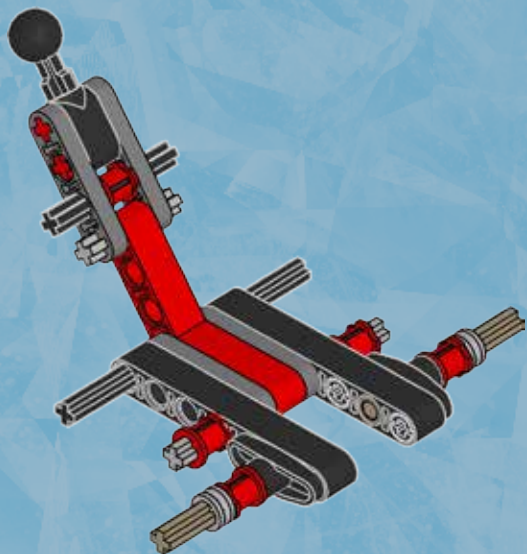

28

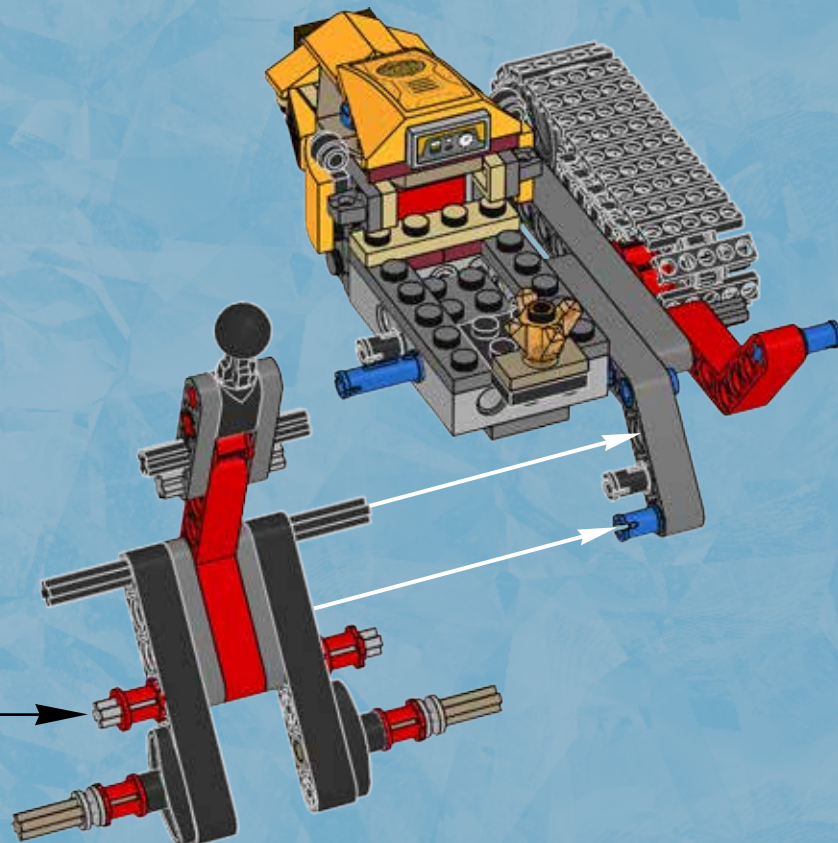



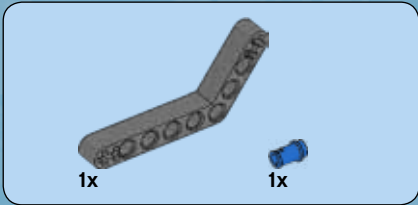
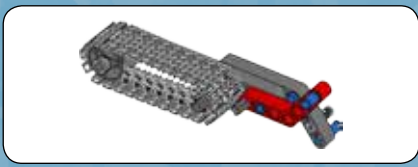

1

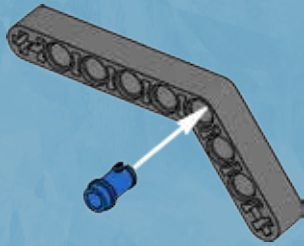

2

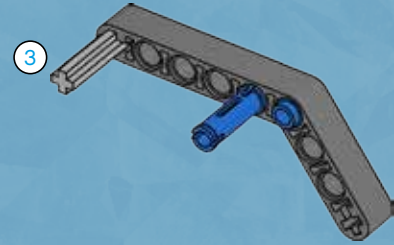

3

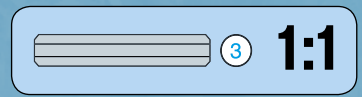
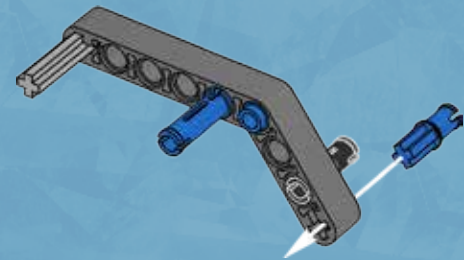

1:1

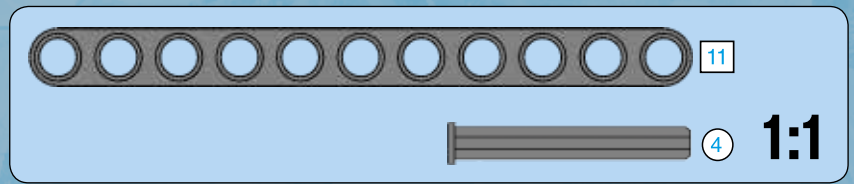
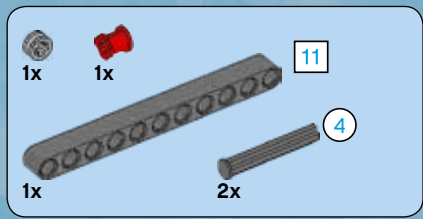

4

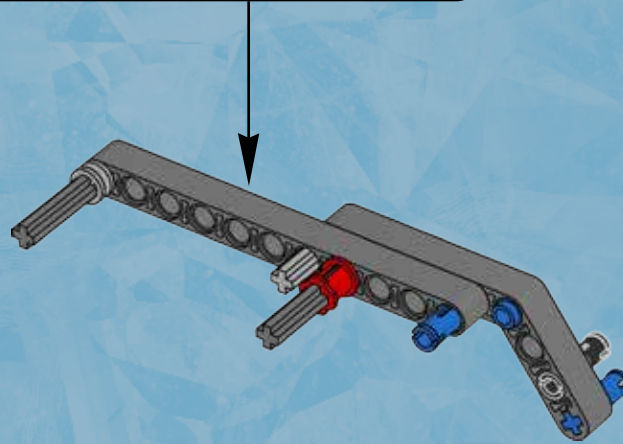
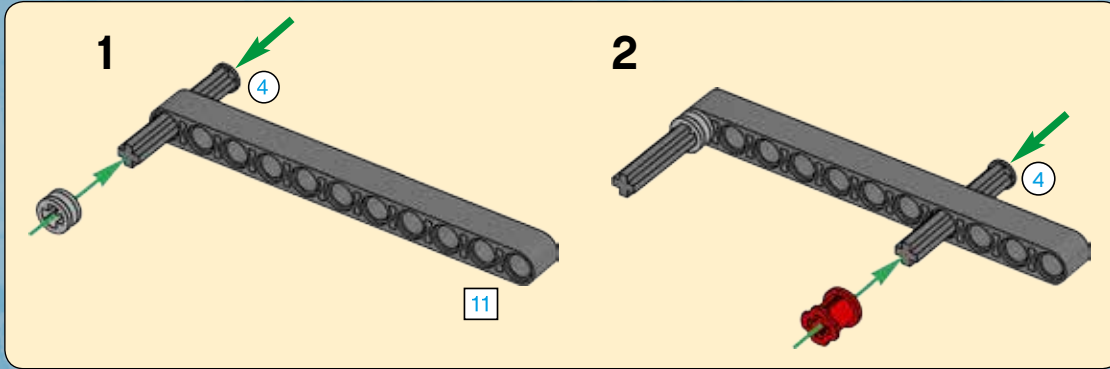



1x

5

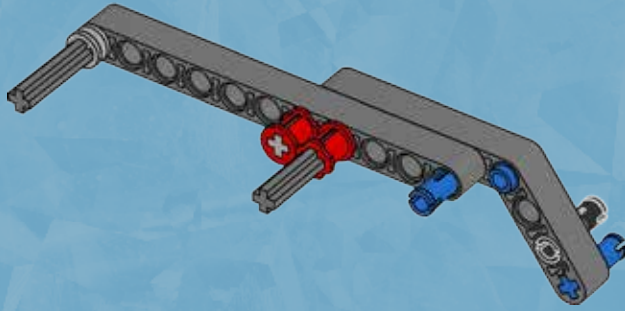

1x

1x

1x

6

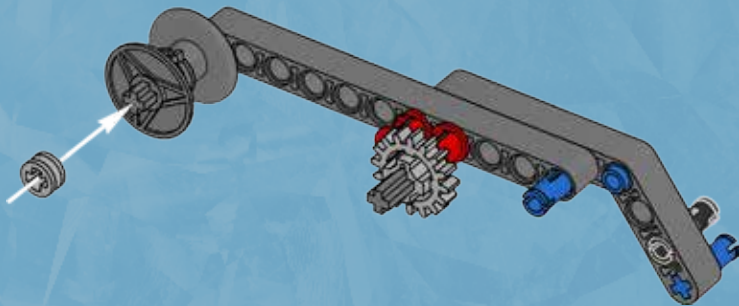

26x

7

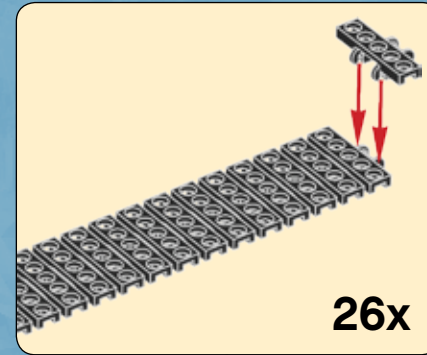

26x

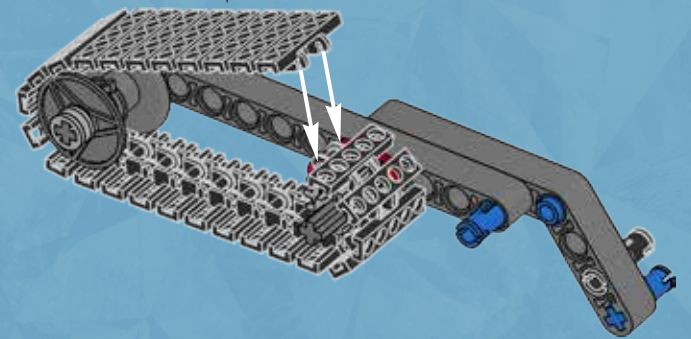

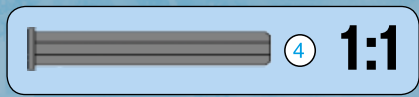
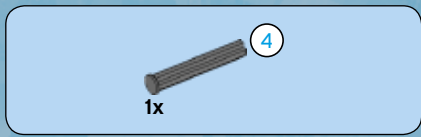

8

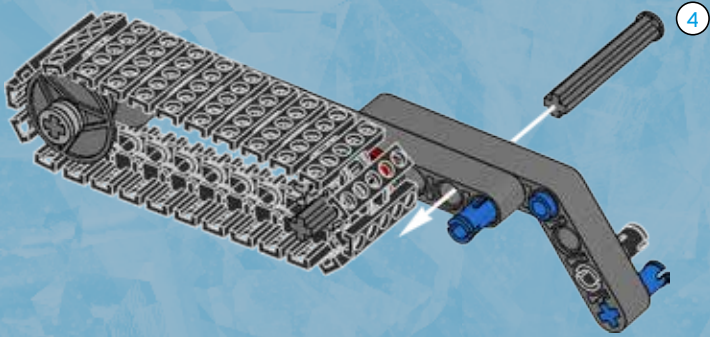

9

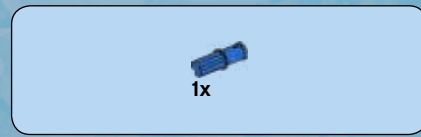
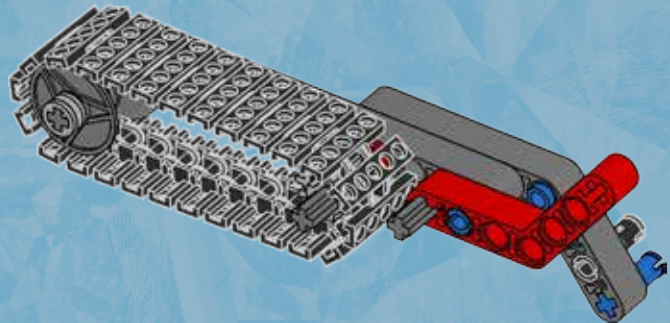

10

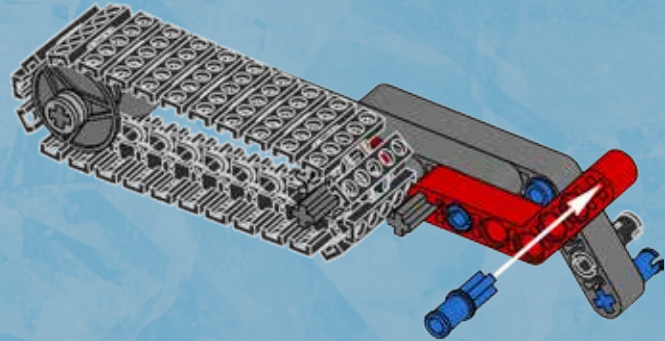

29

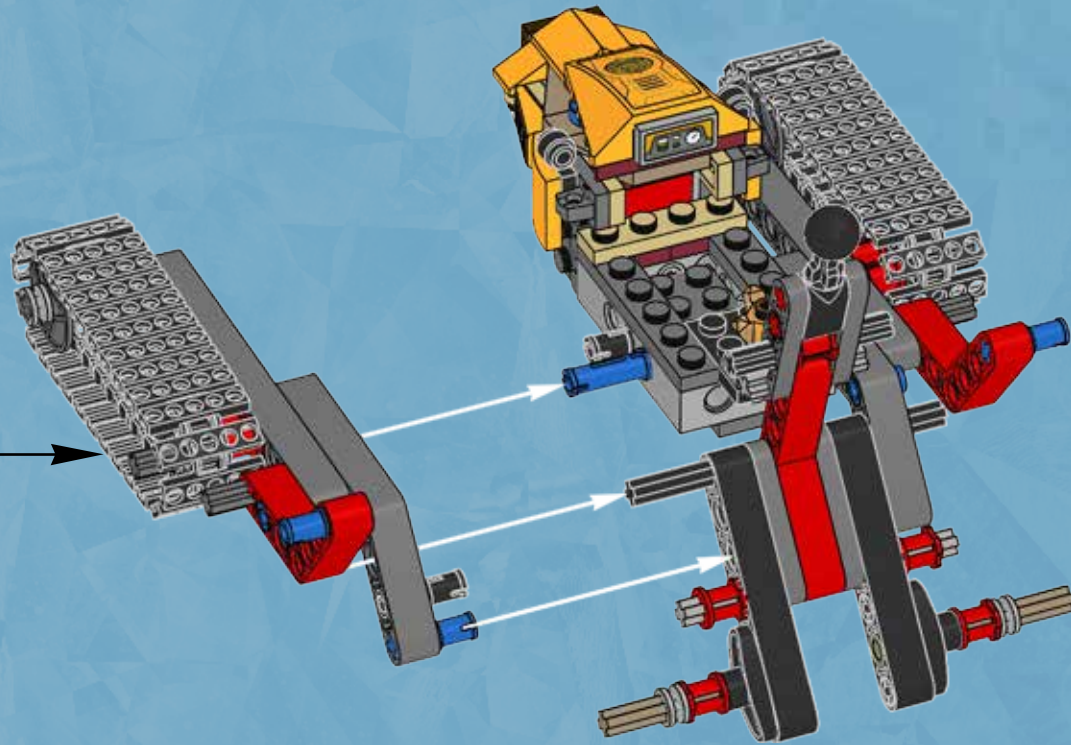



2x

# 30

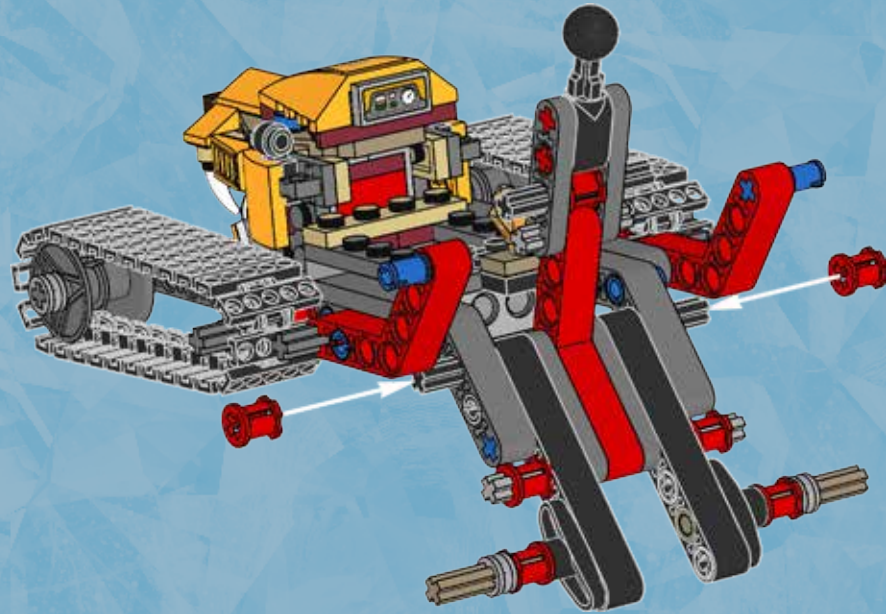

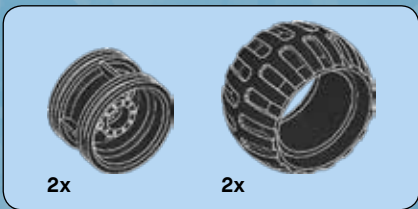

# 31

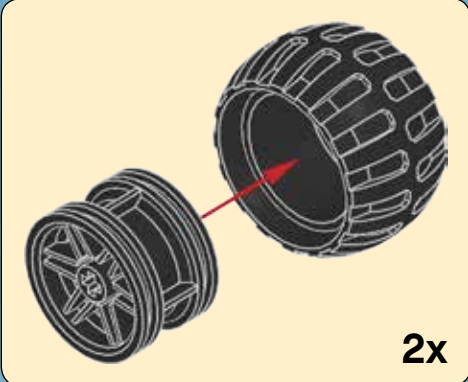
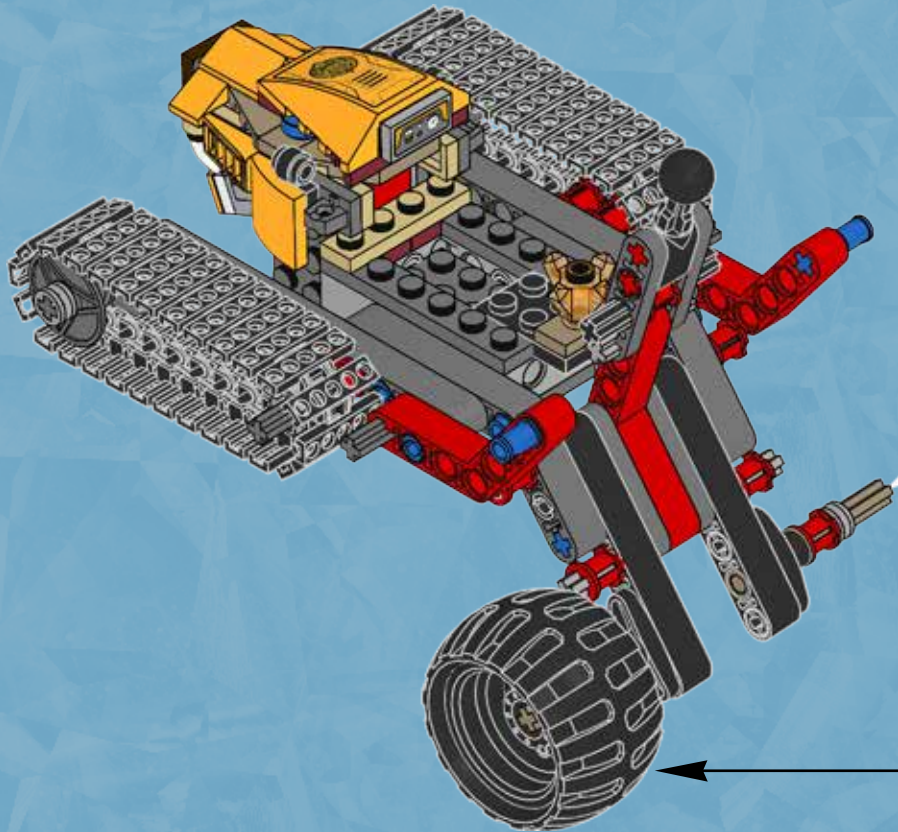



2x

32

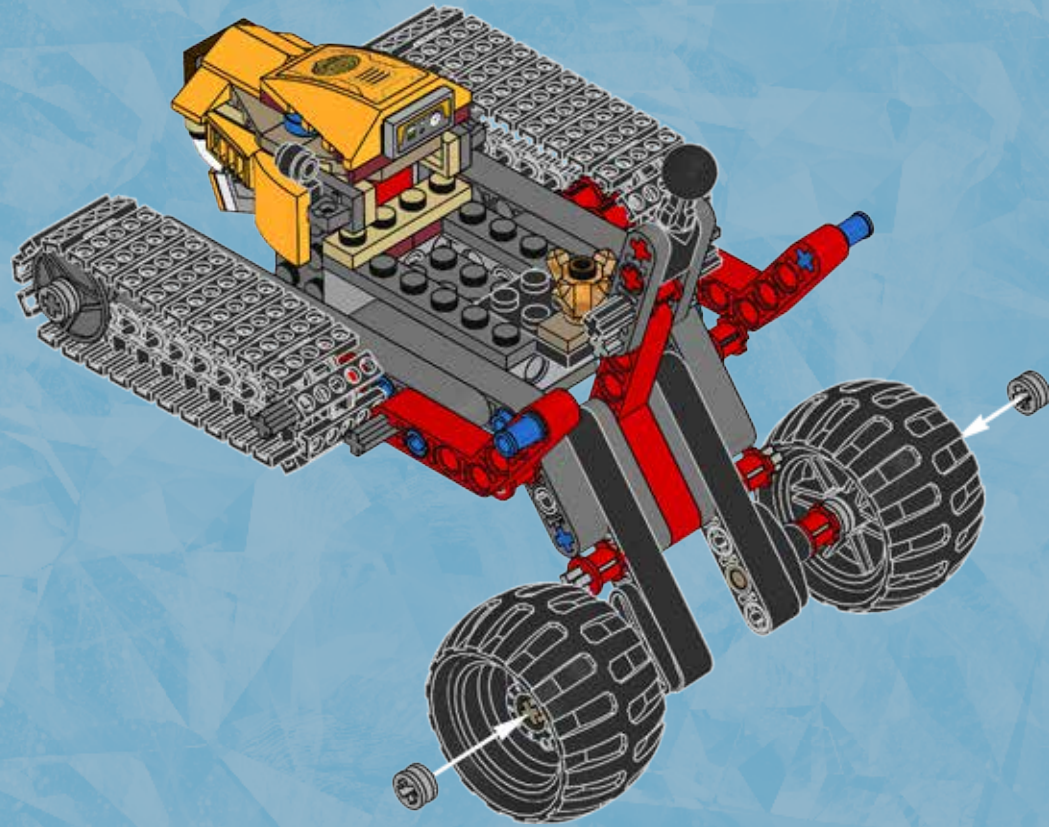





33

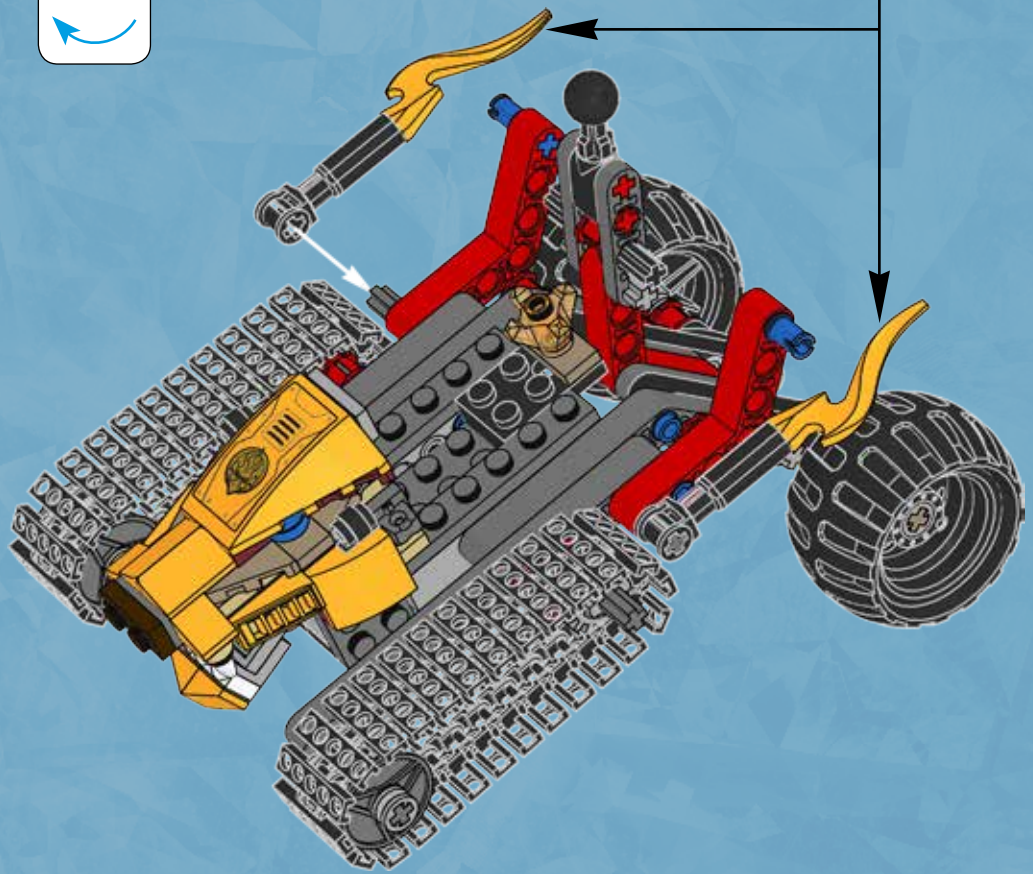

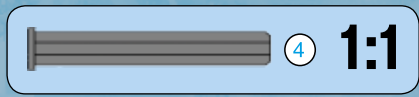
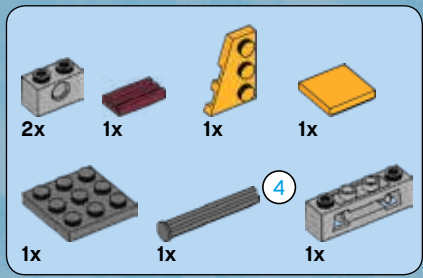

# 34



1



2

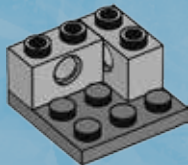

3

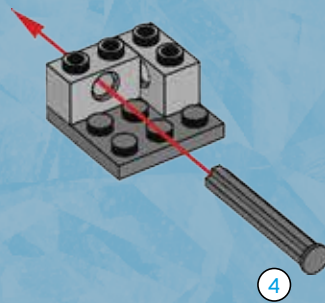

4

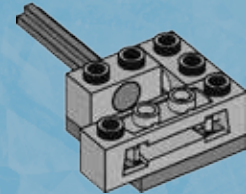

5

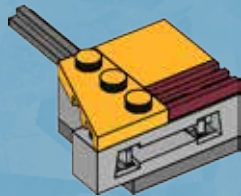

6

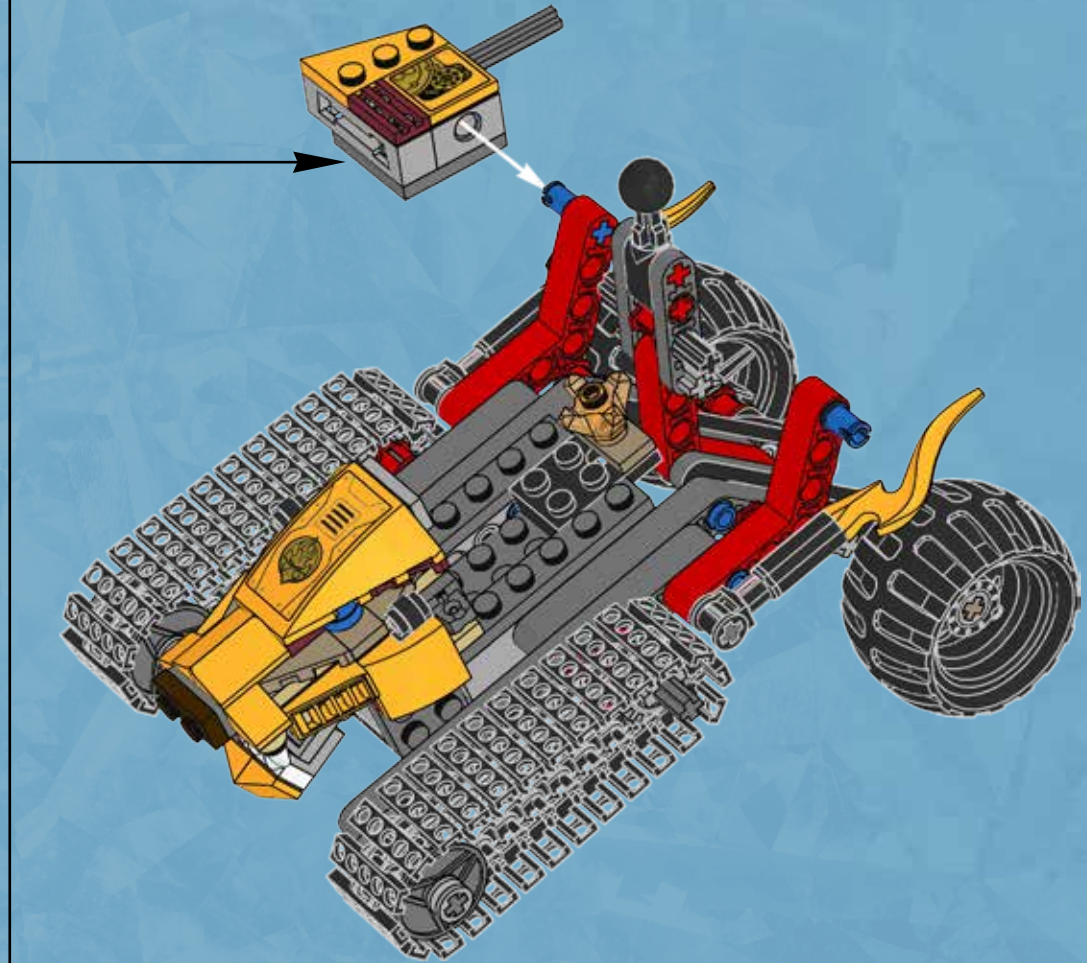

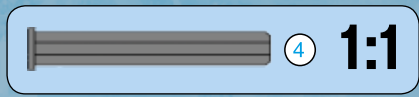
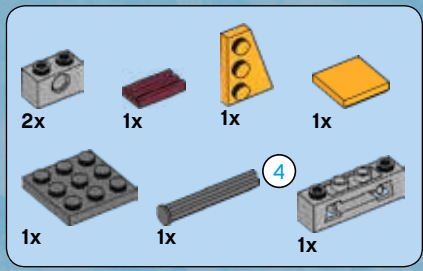

# 35



1

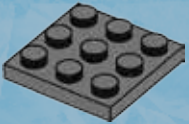

2

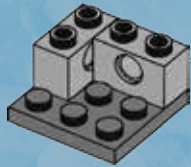

3

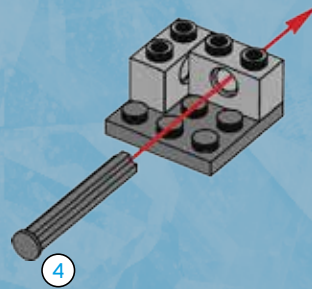

4

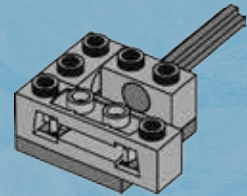

5

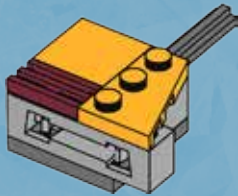

6

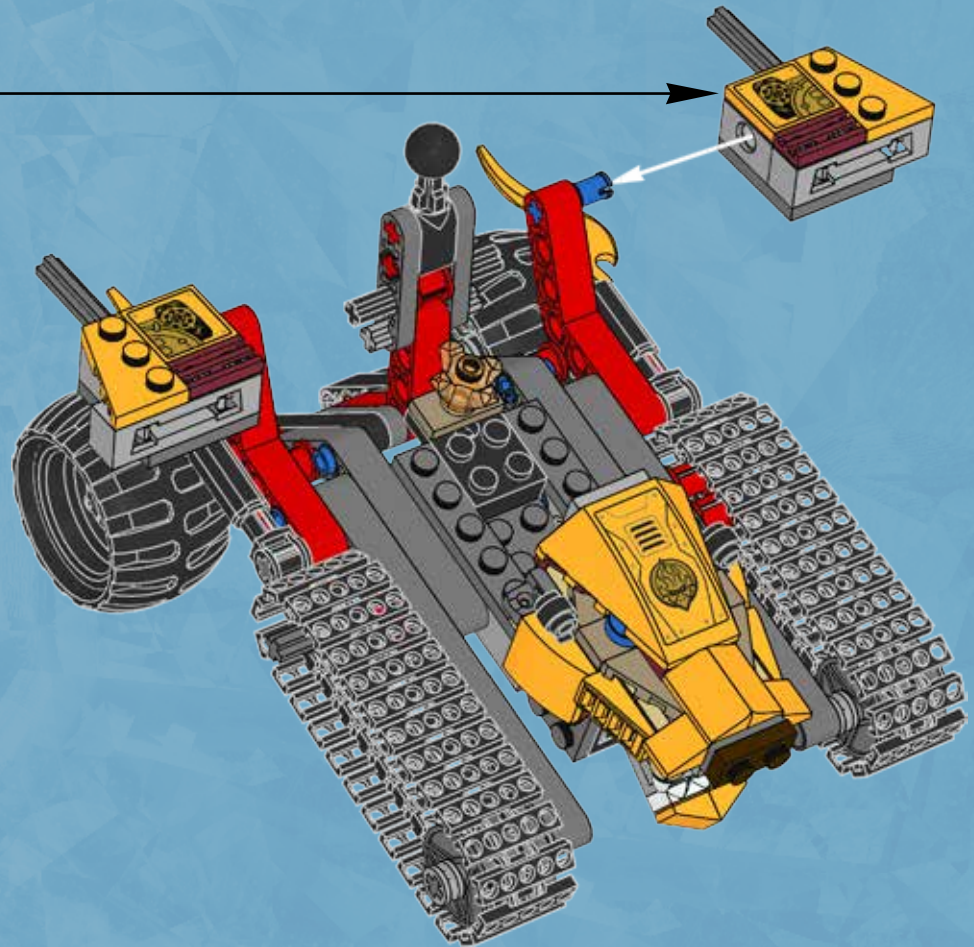



2x

# 36

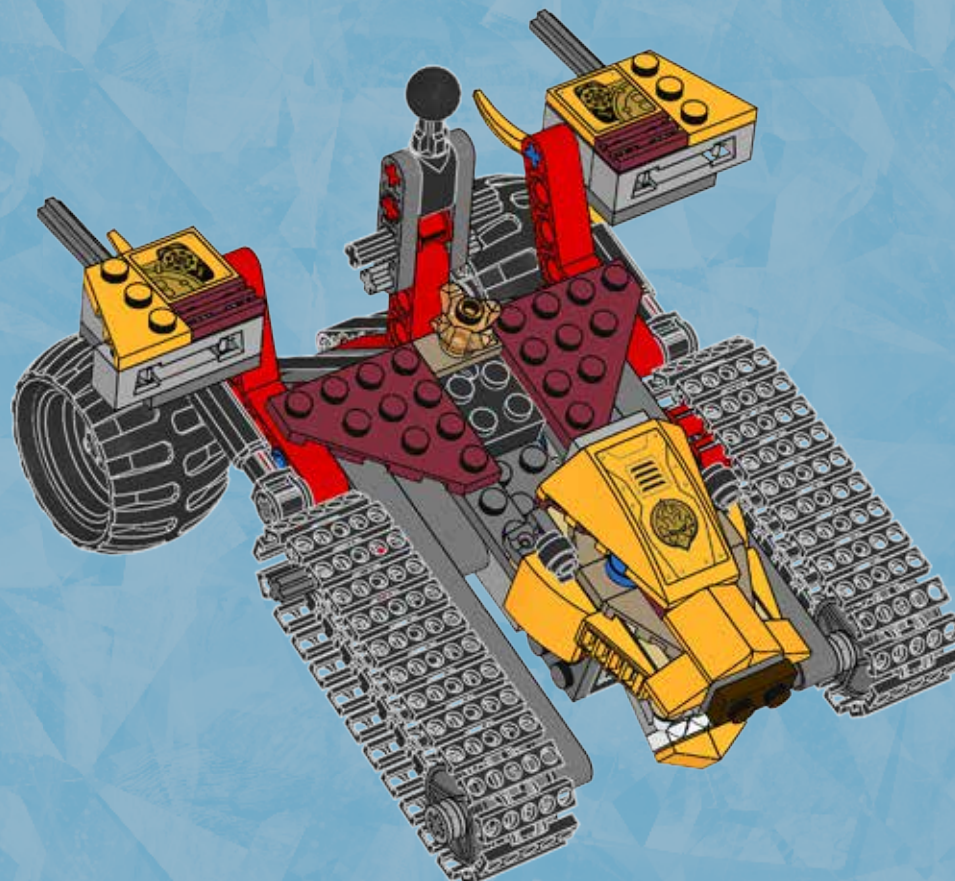

2x

2x

# 37

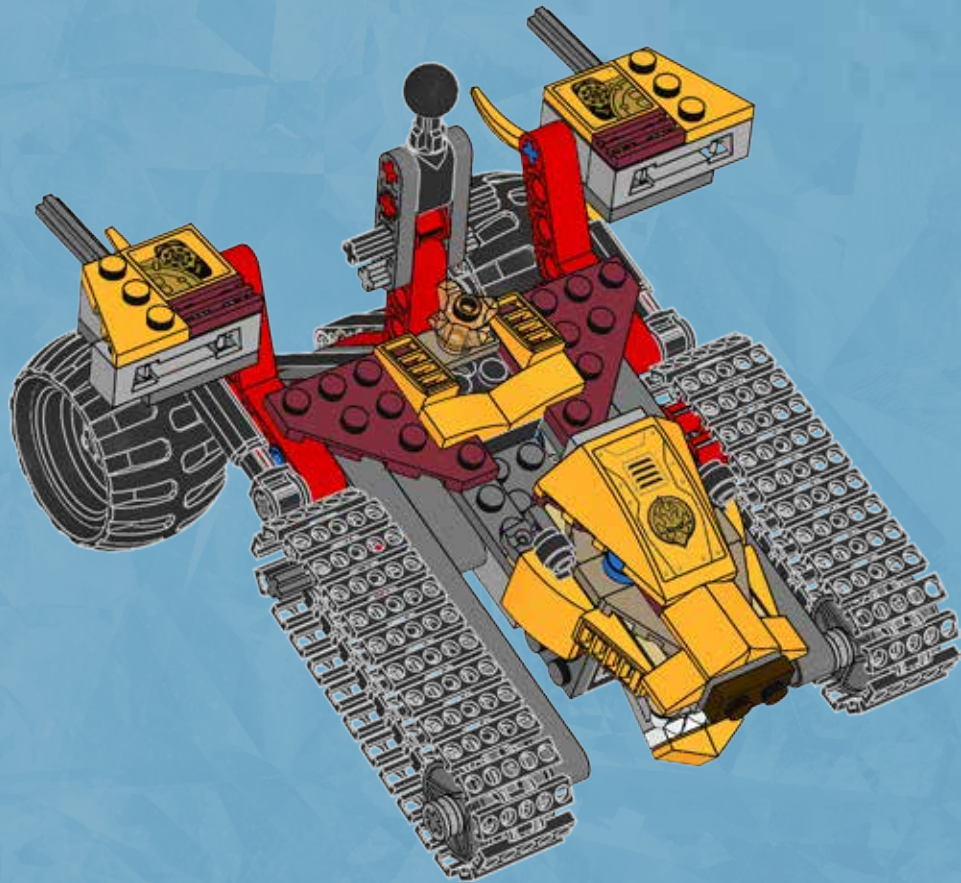

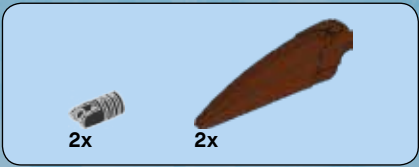

# 38

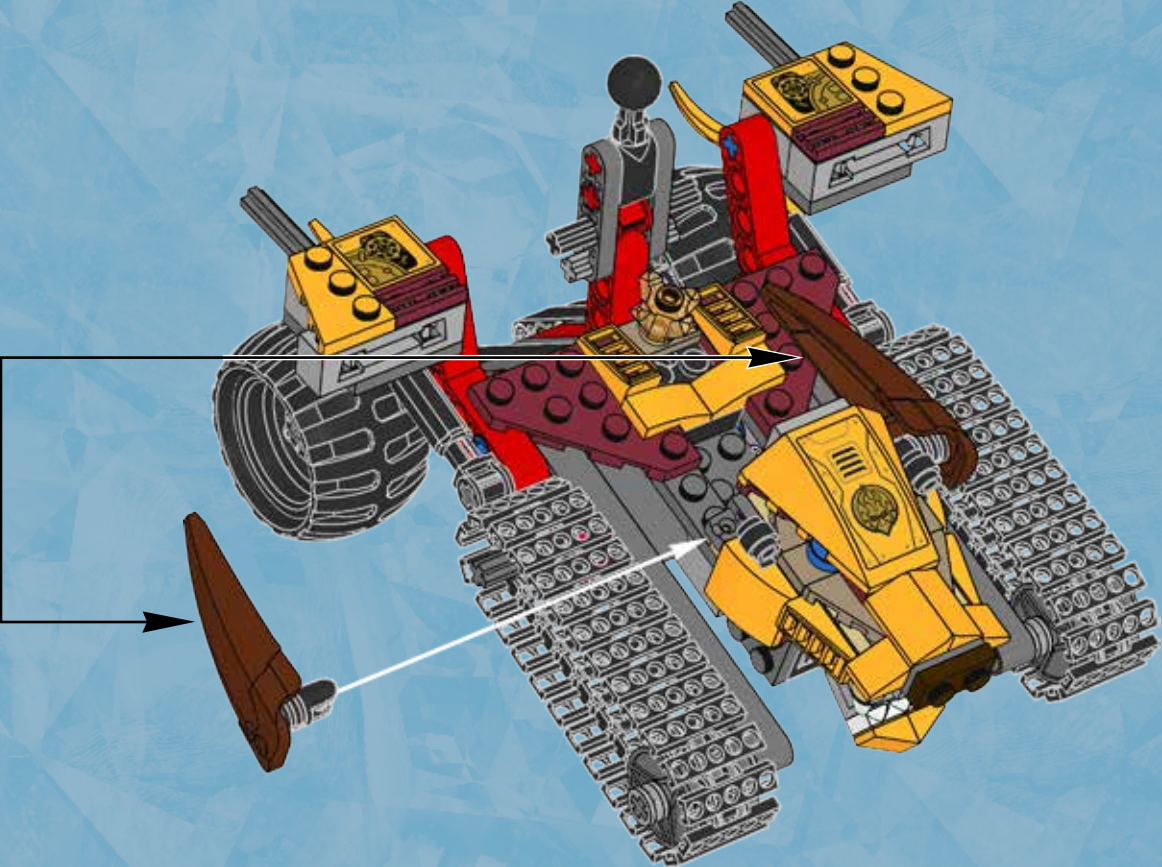
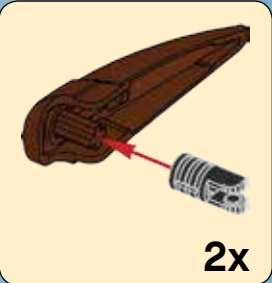





39

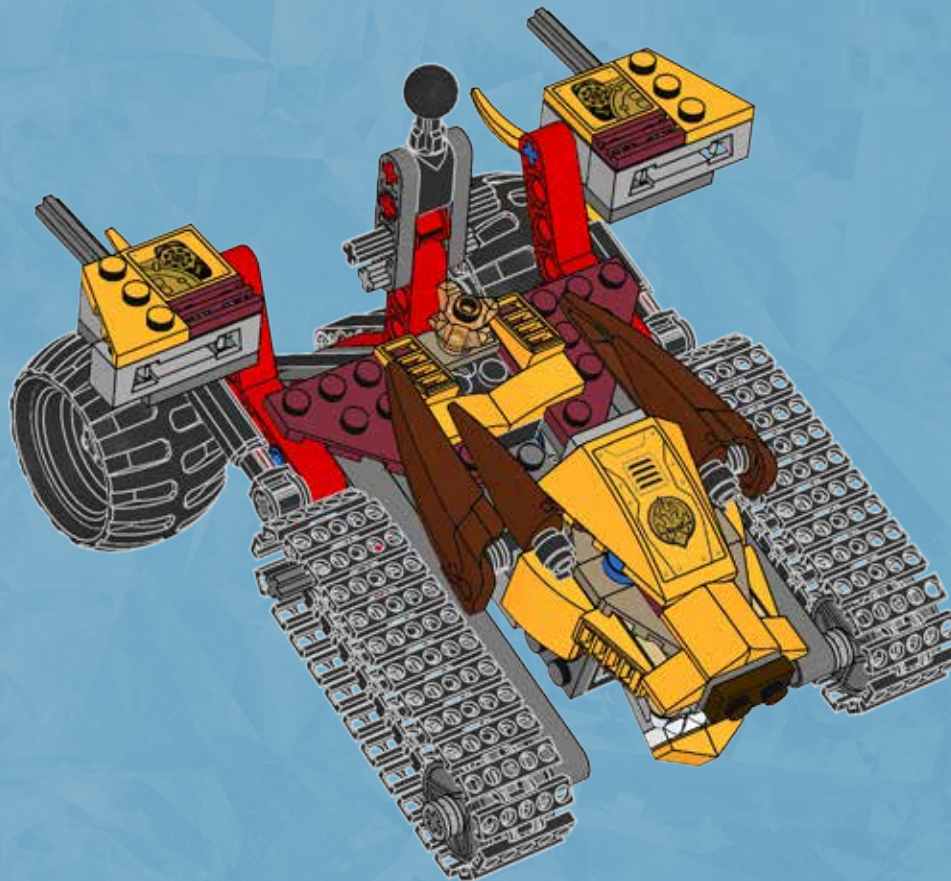



2x

40

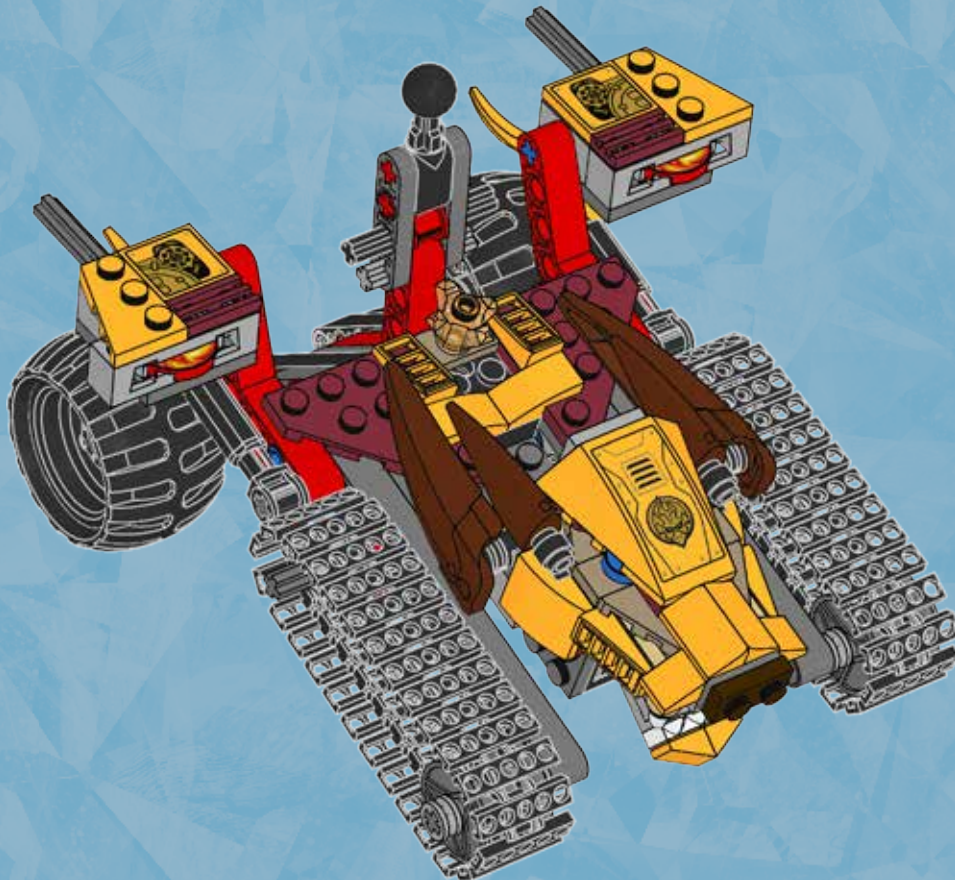

41

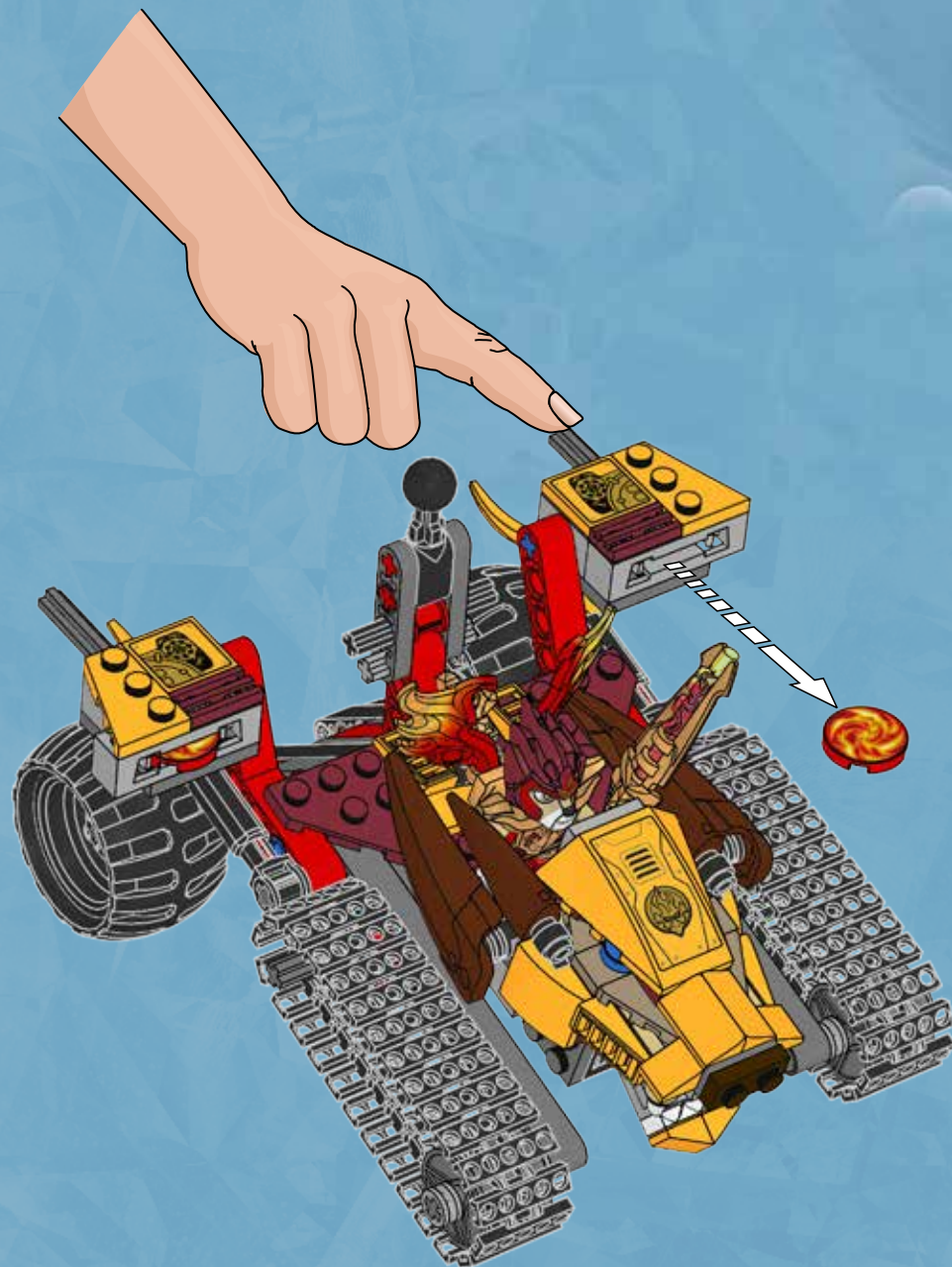

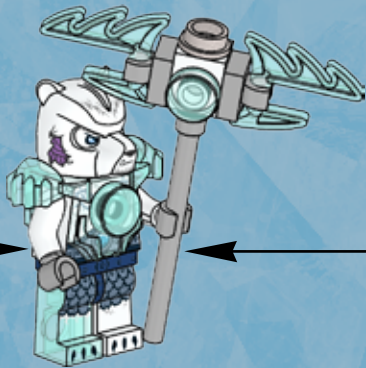
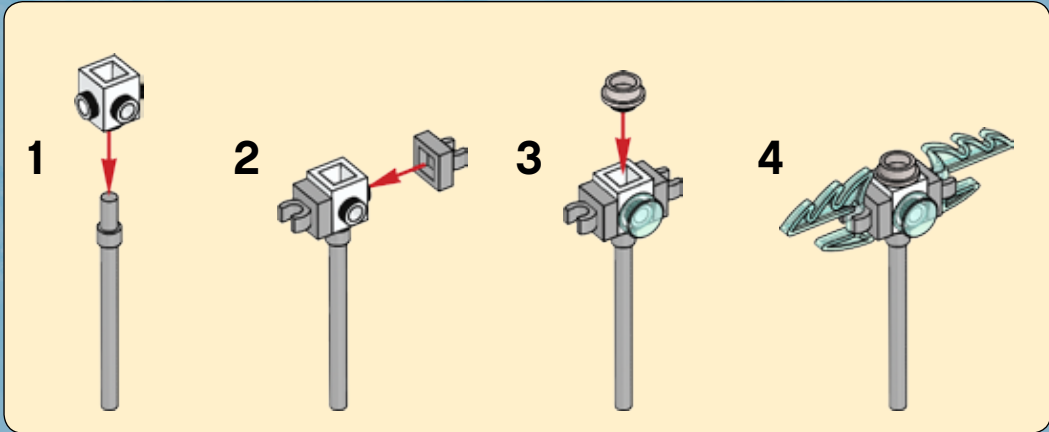
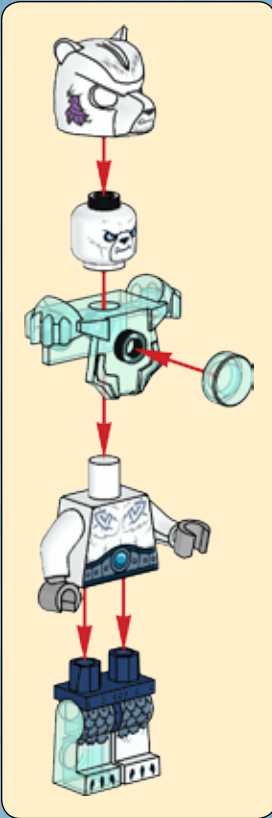
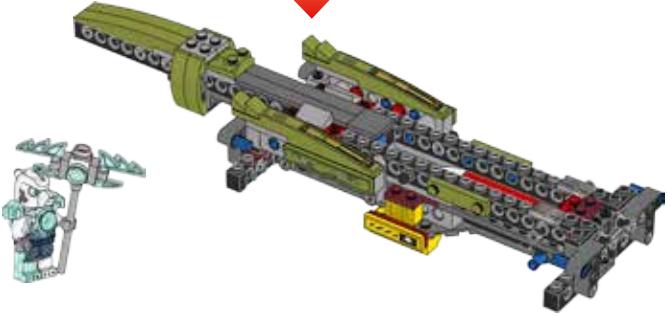
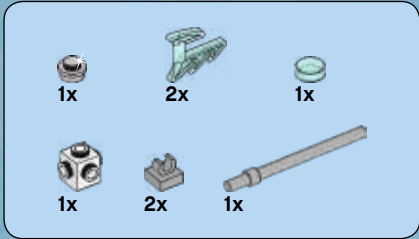
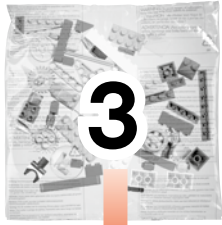

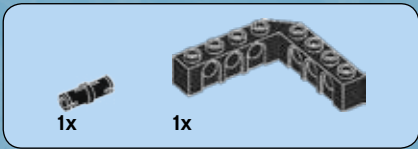
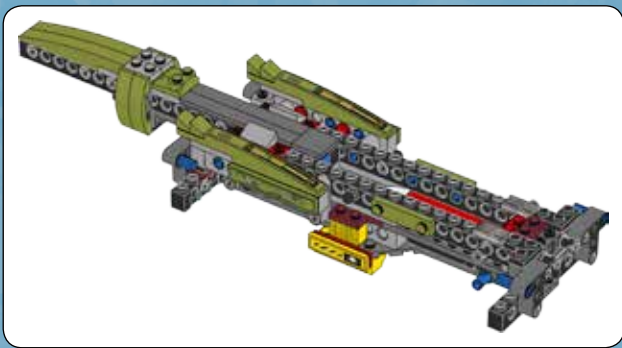

**1**



**2**

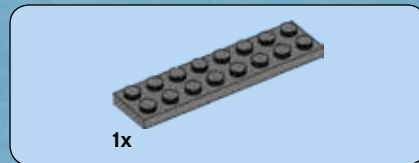

**3**

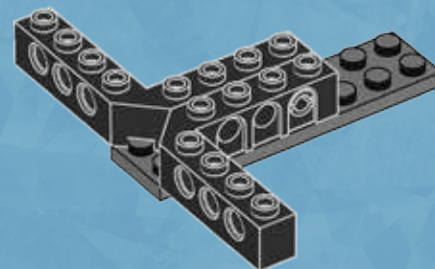

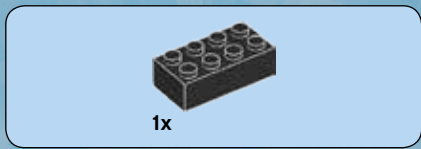

4

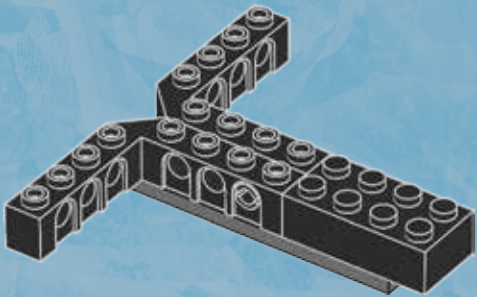

5

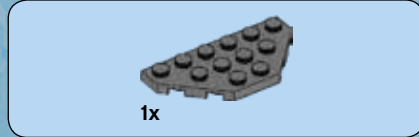
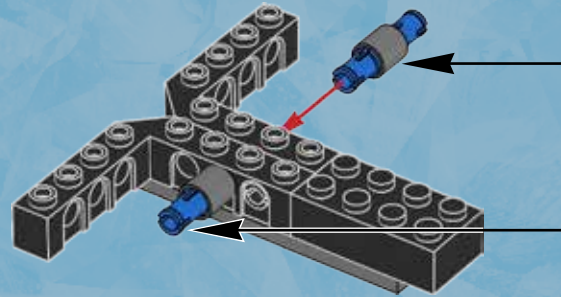
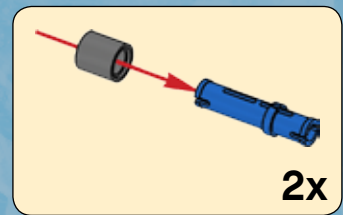

6

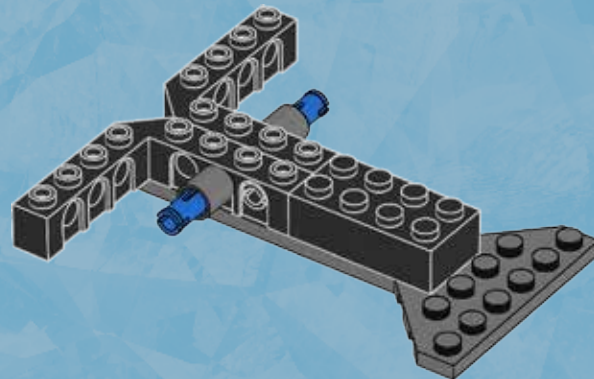



7

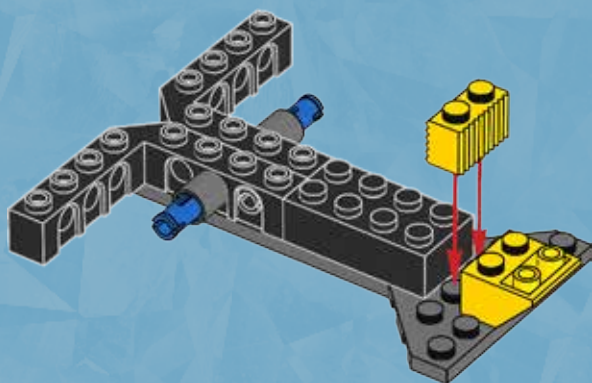

8

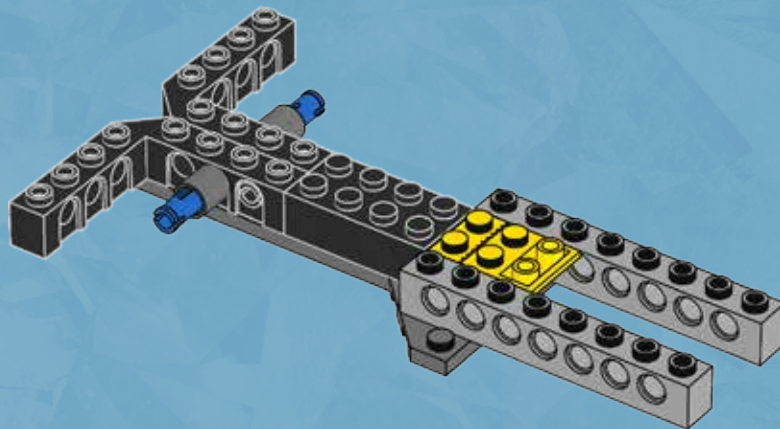

9

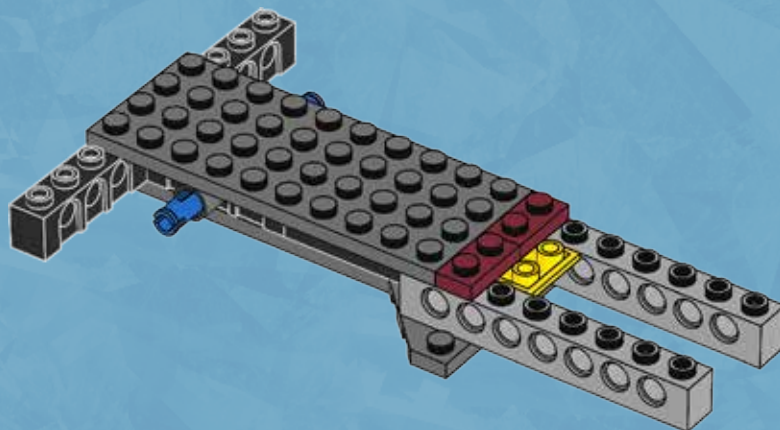

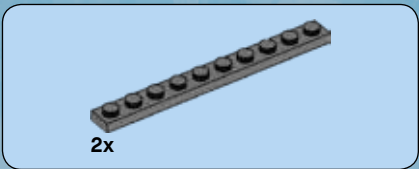

# 10

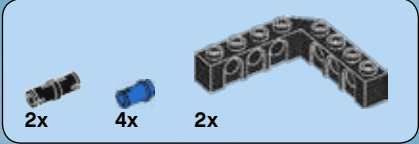
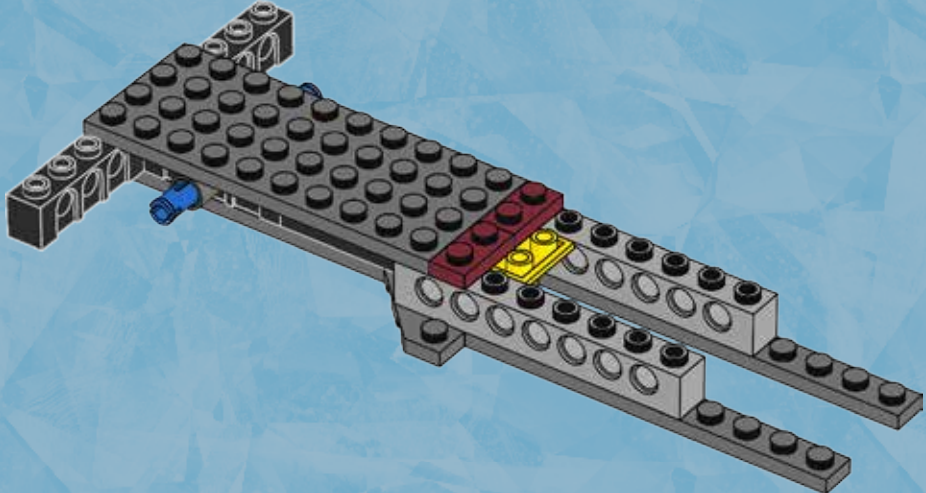

# 11

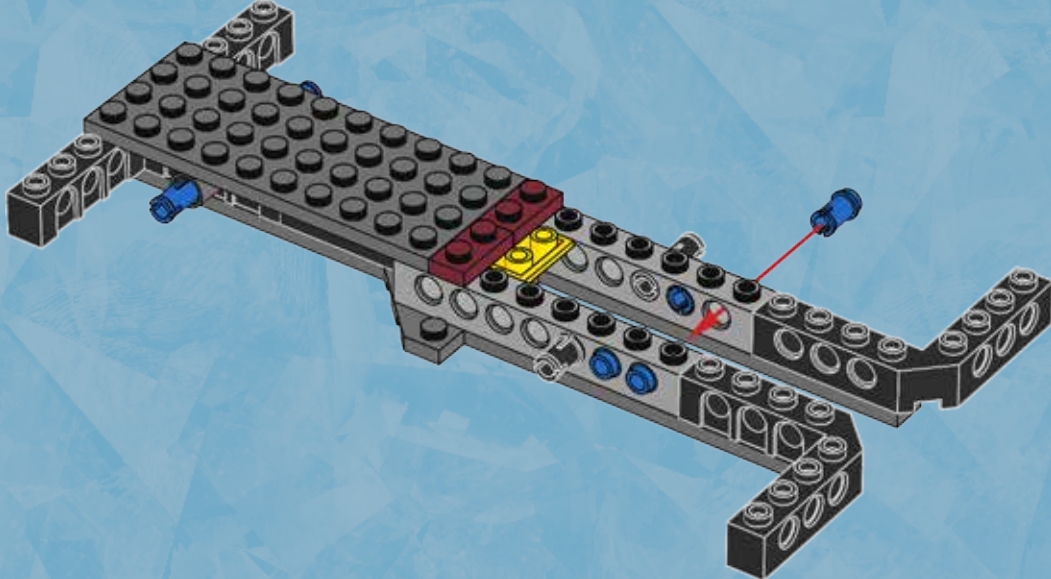



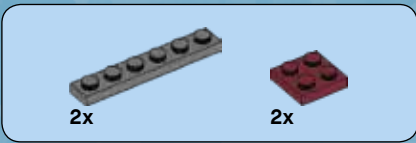

12

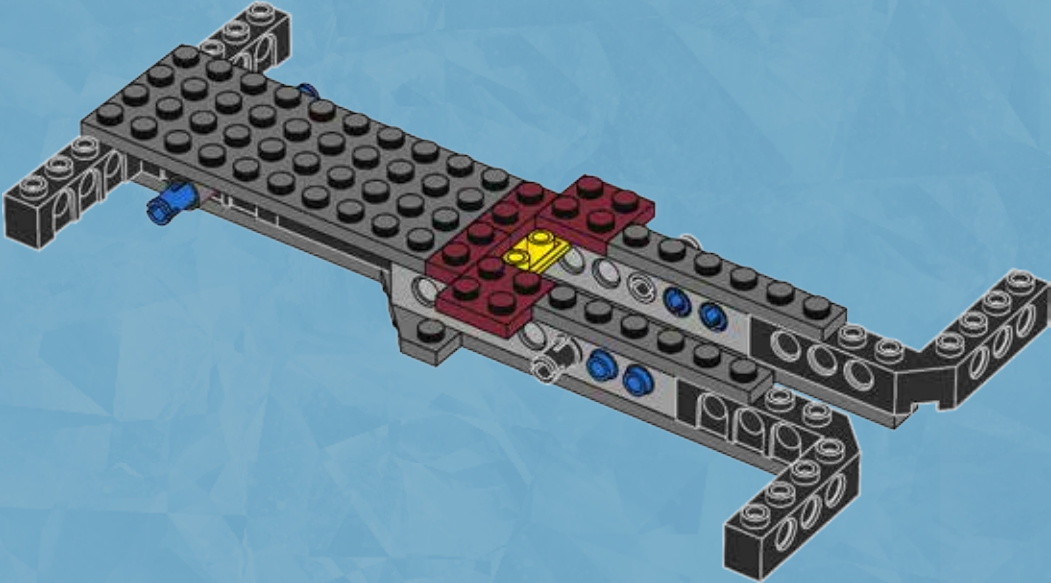

13

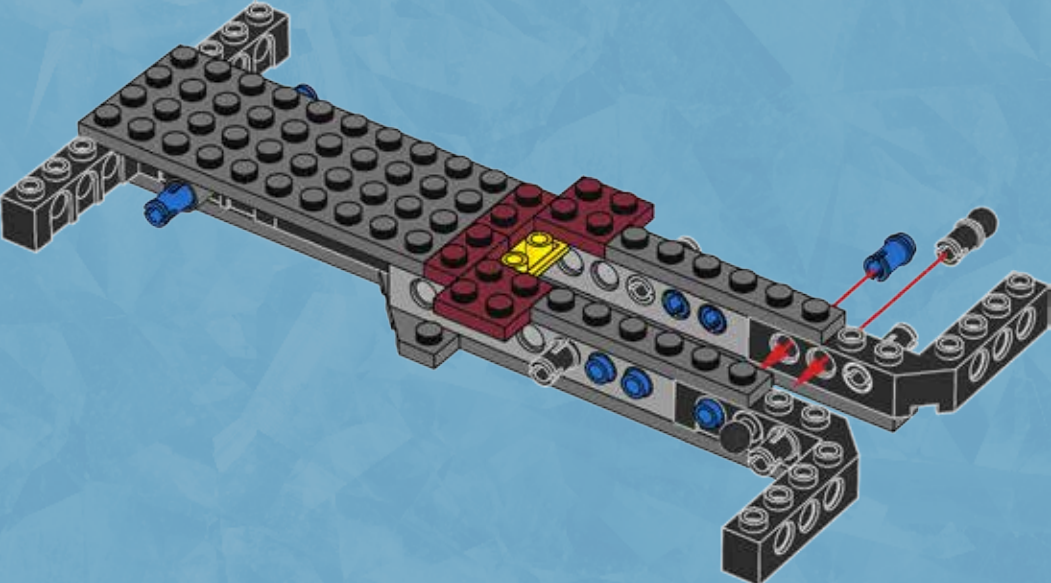

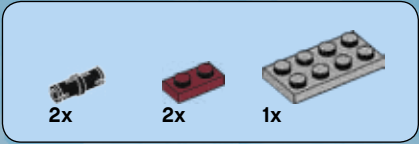

14

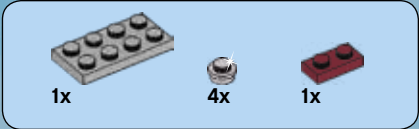
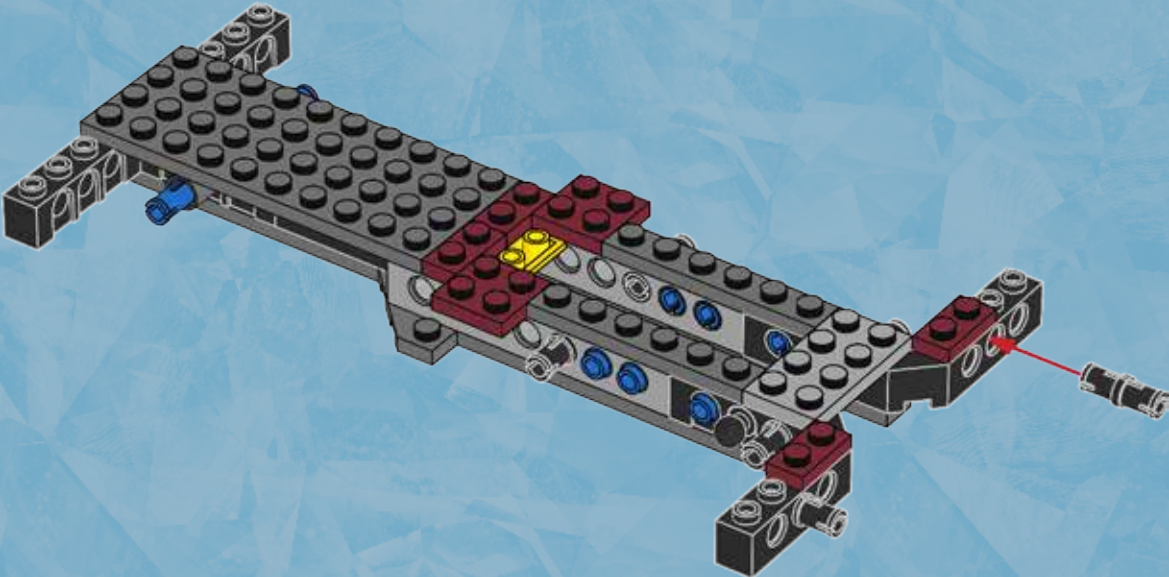

15

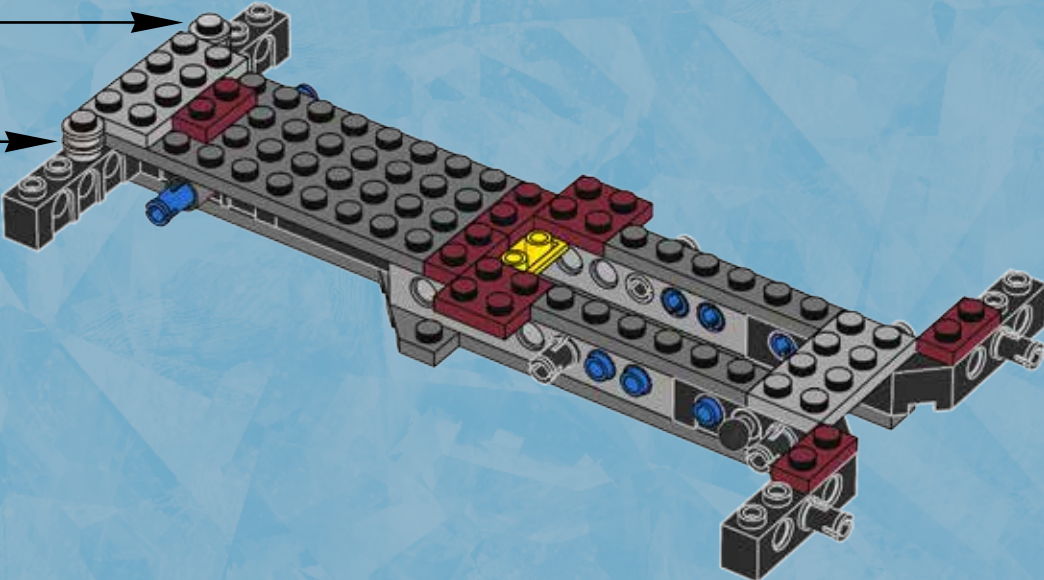
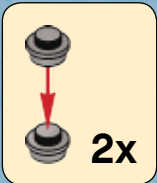



16

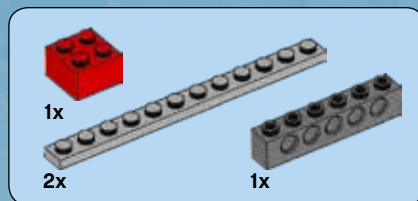
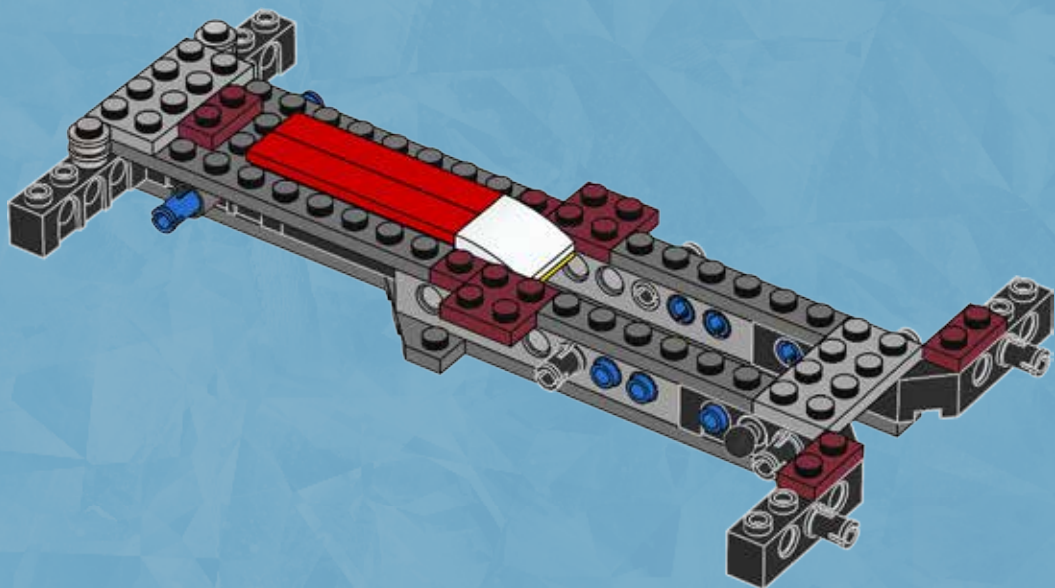

17

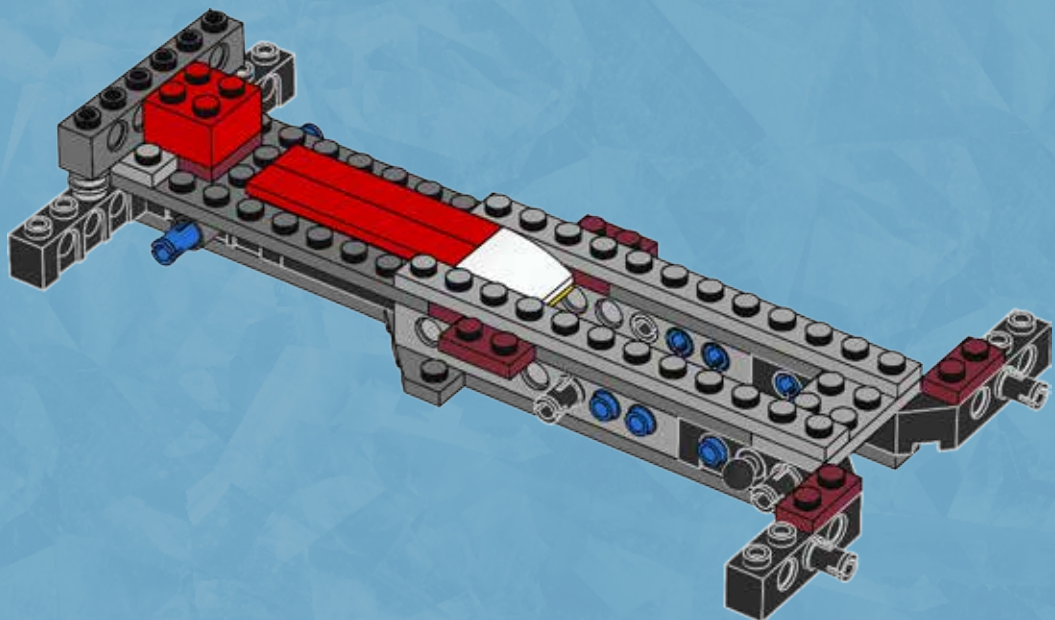

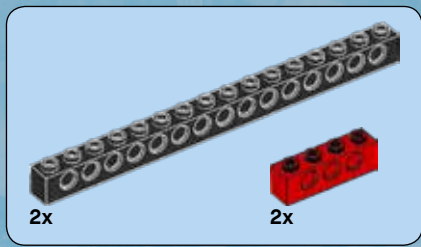

18

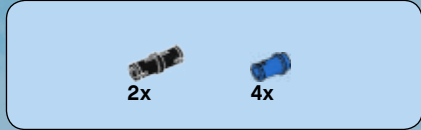
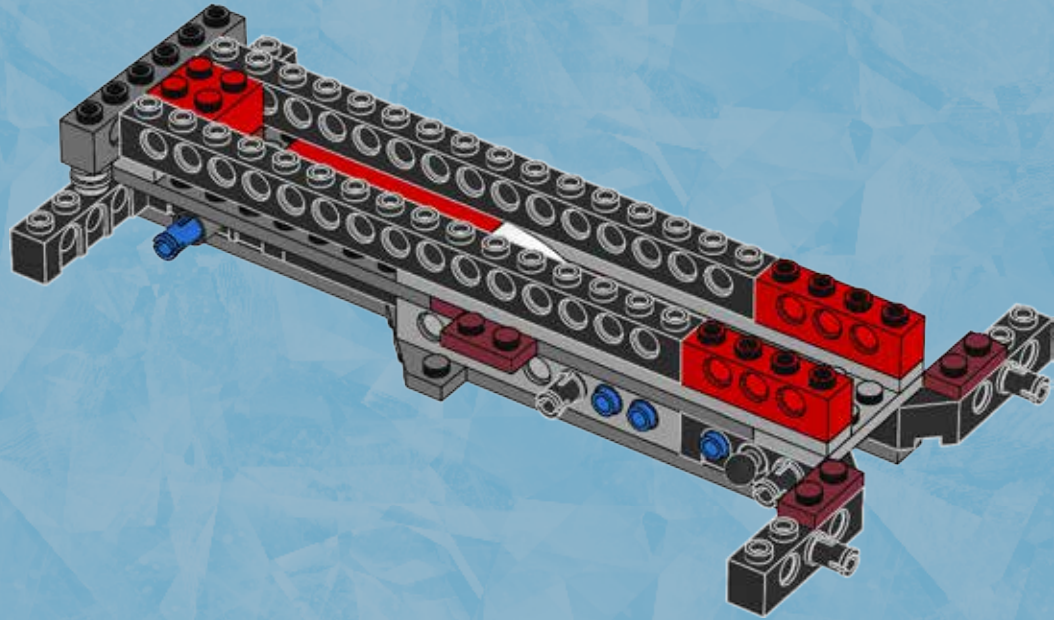

19

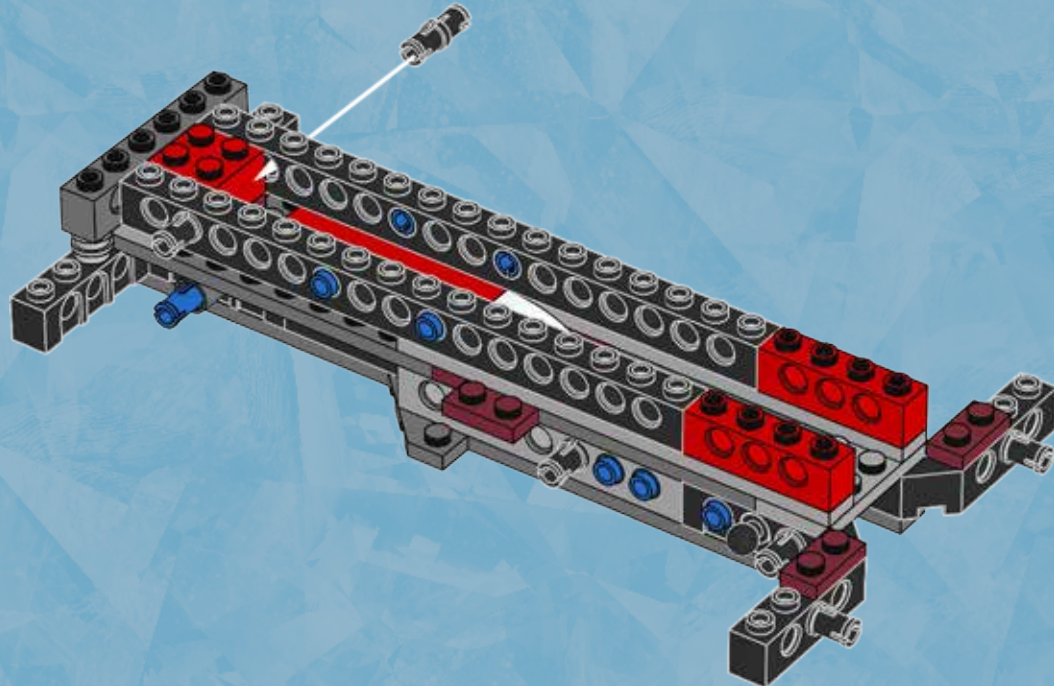



20

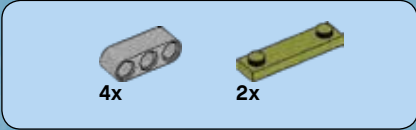
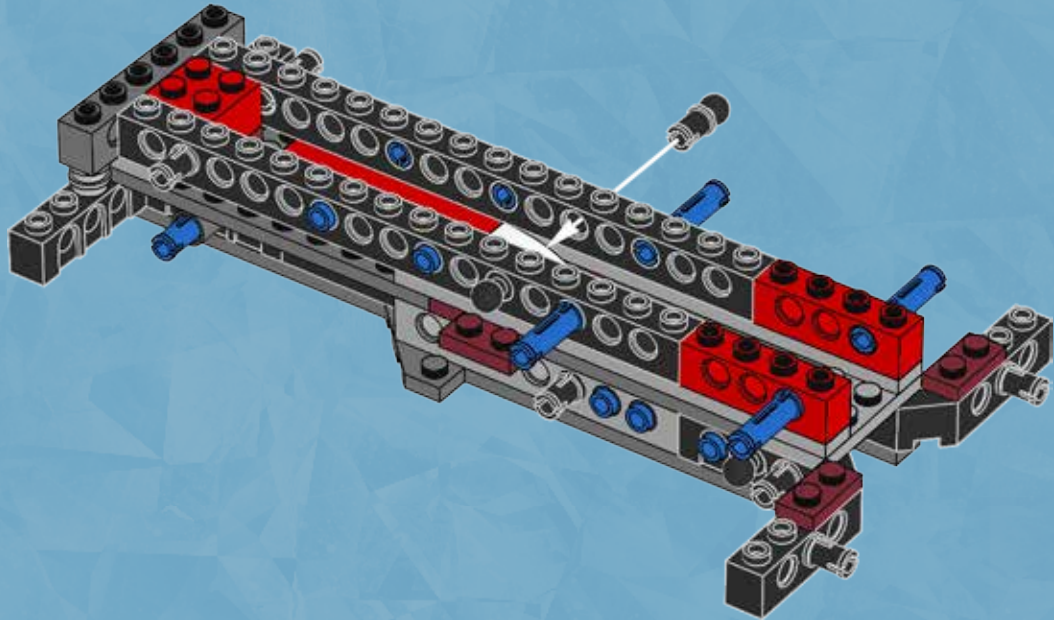

21

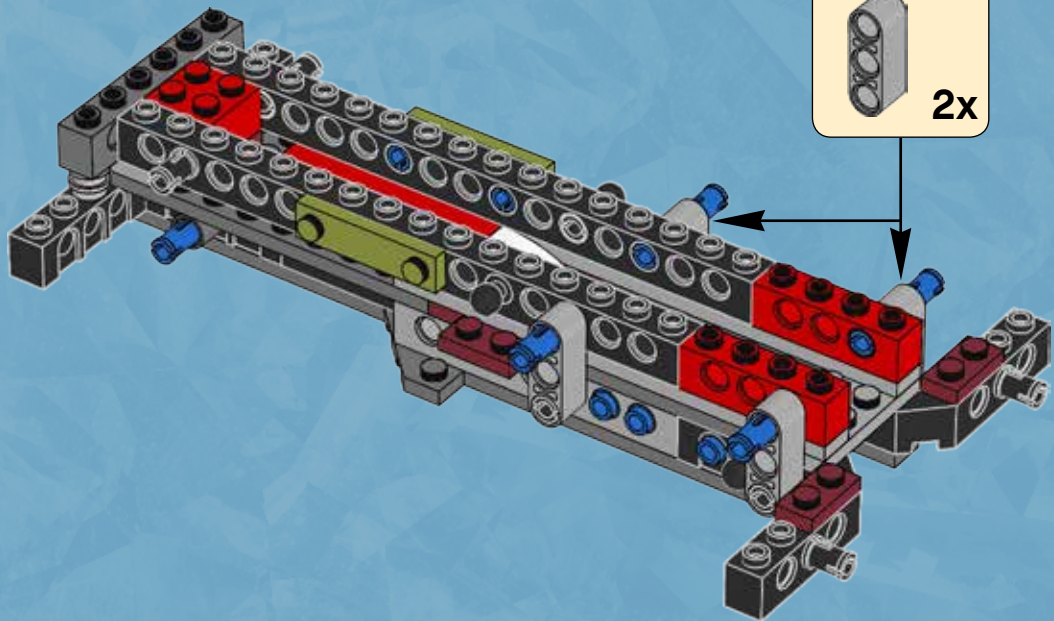



4x

22

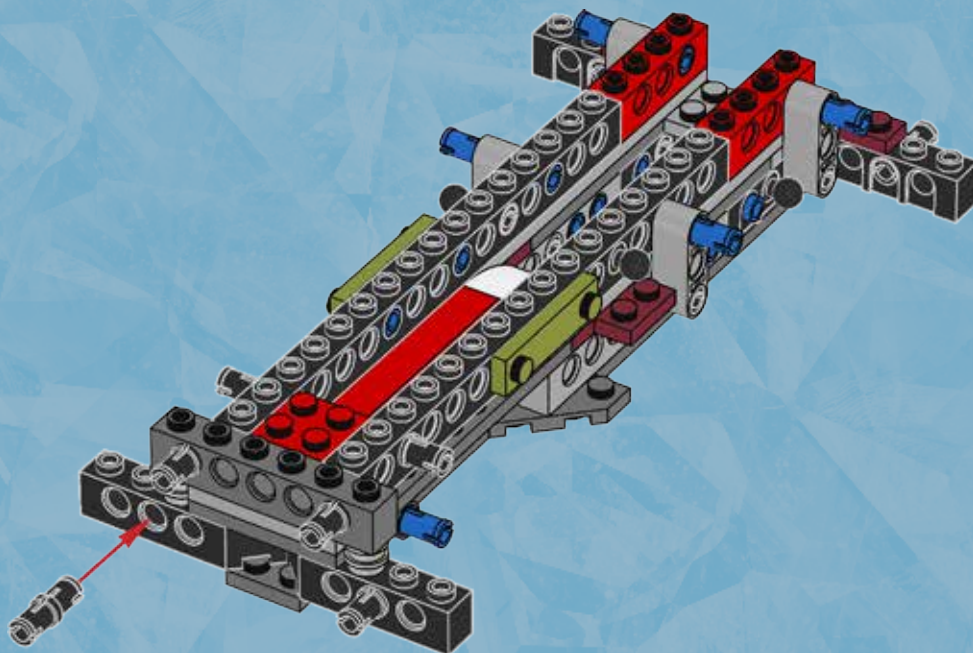



2x

# 23

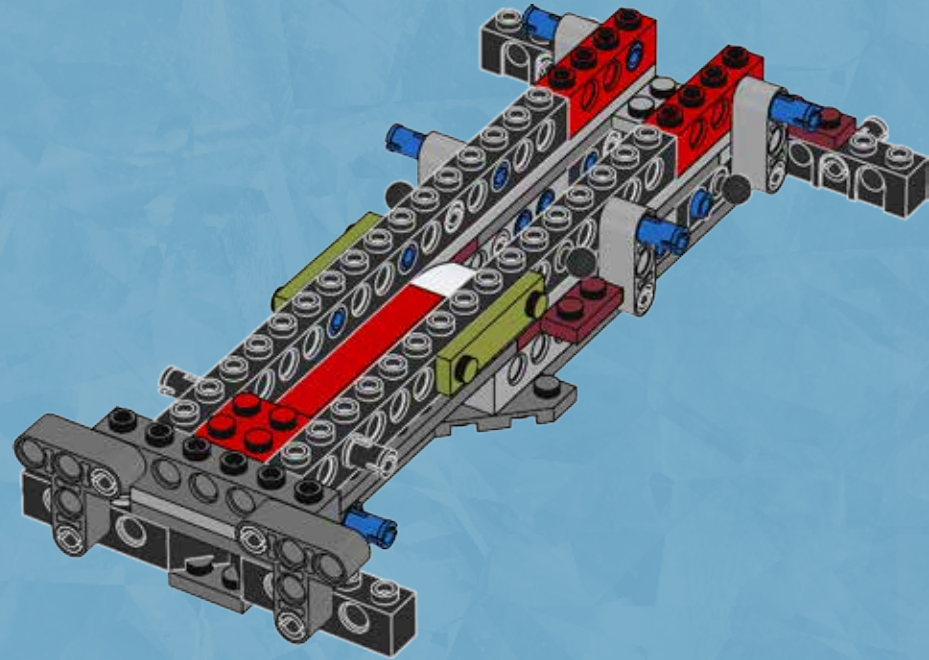

2x



2x

# 24

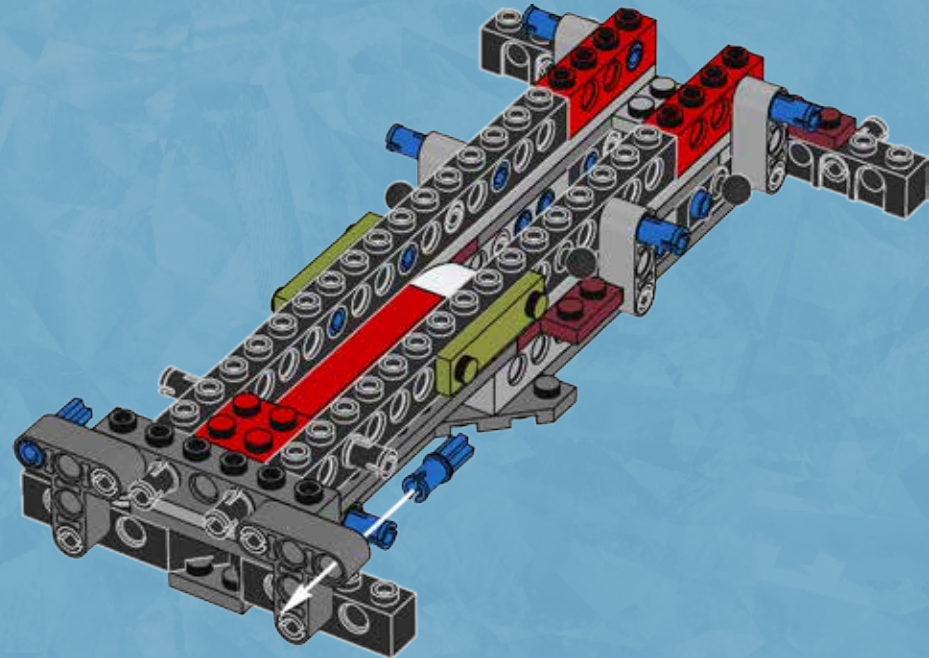

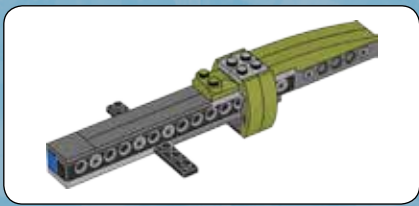

1

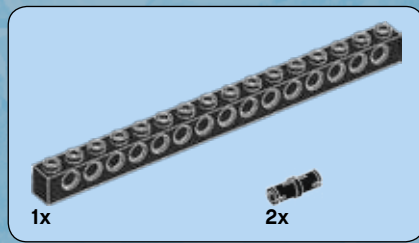
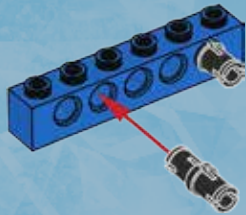

2

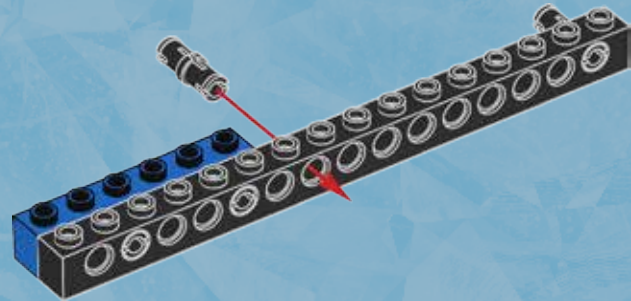



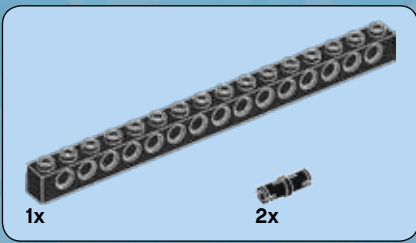

3

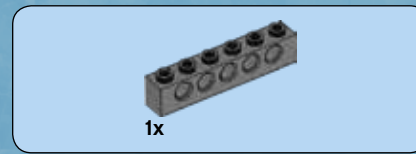
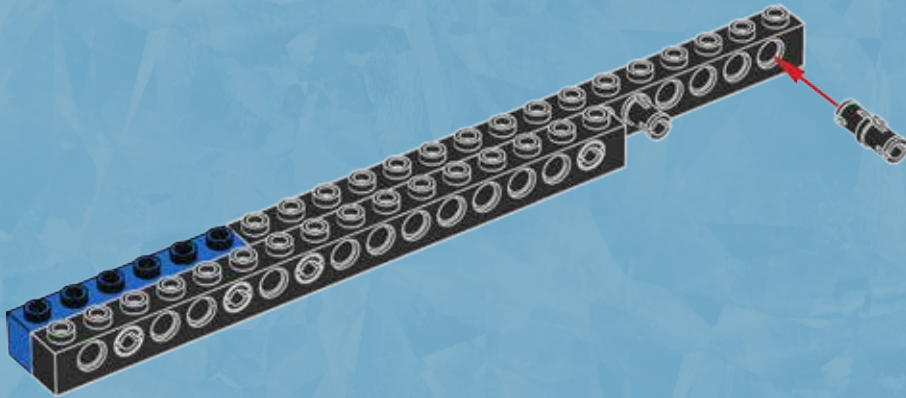

4

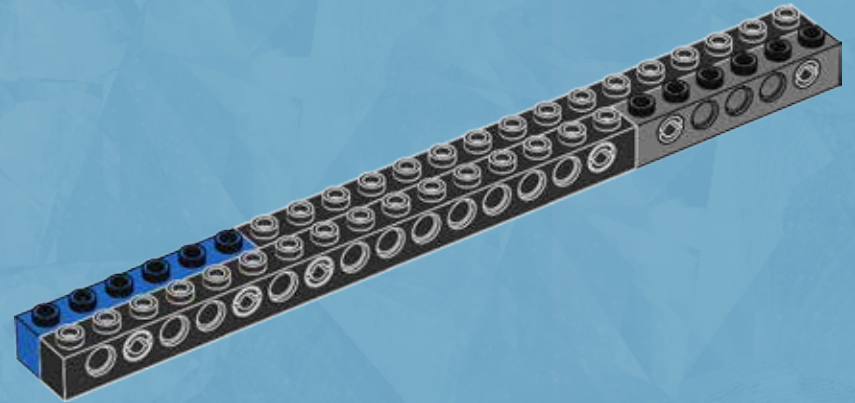

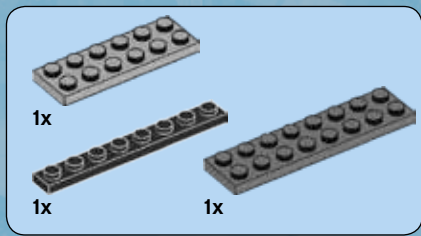

5

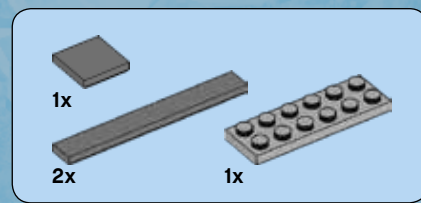
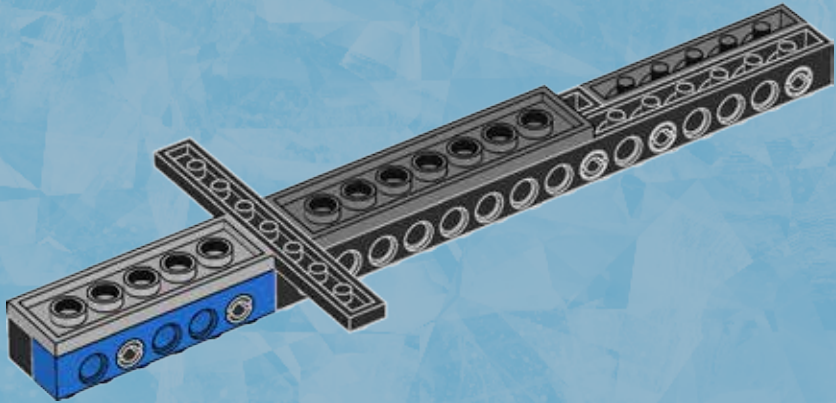

6

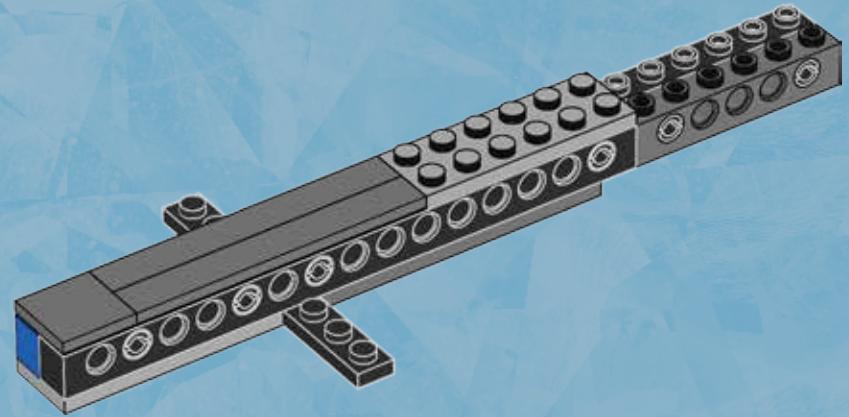

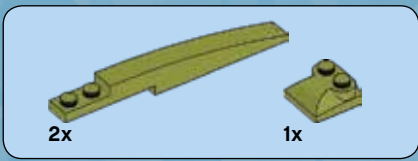

7

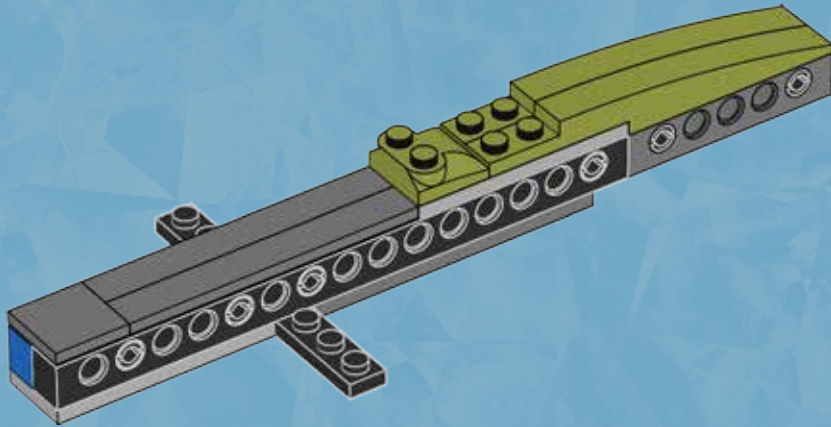

8

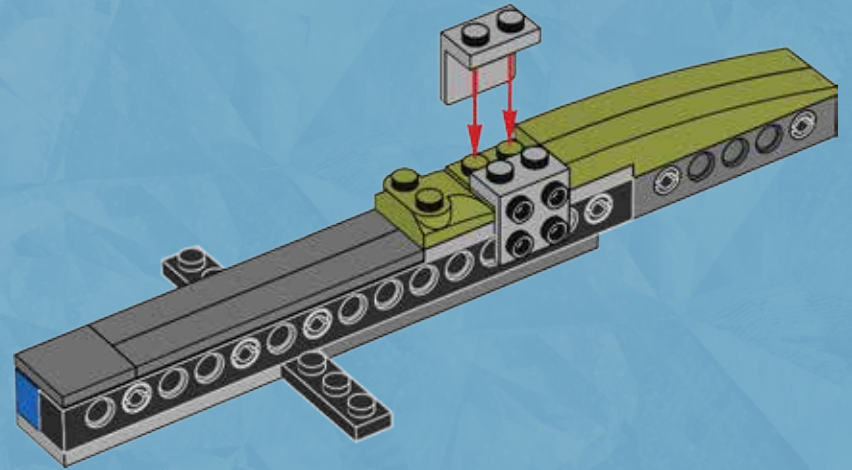



2x



2x

# 9

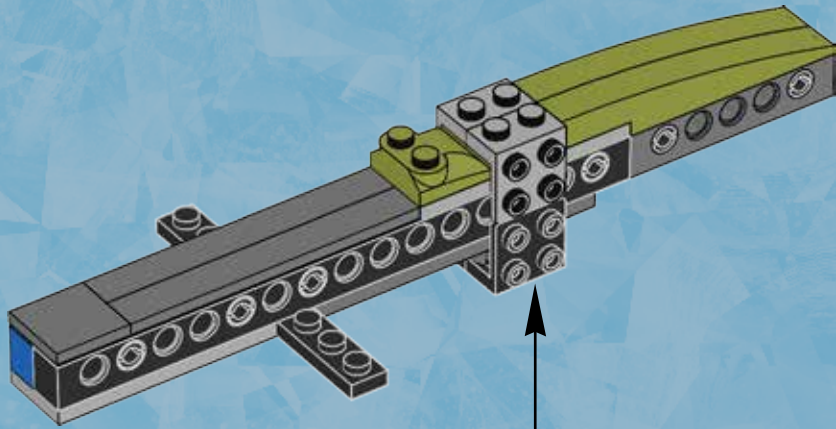

1



2



2x



4x

# 10

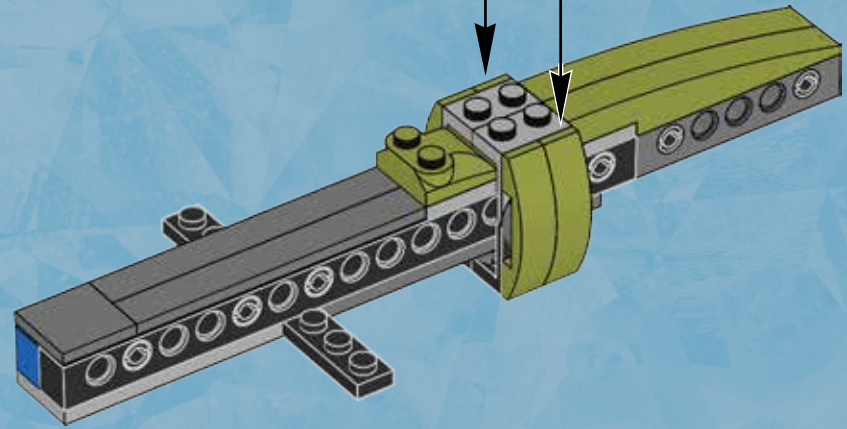

1



2

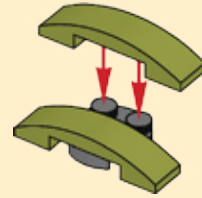

2x

25

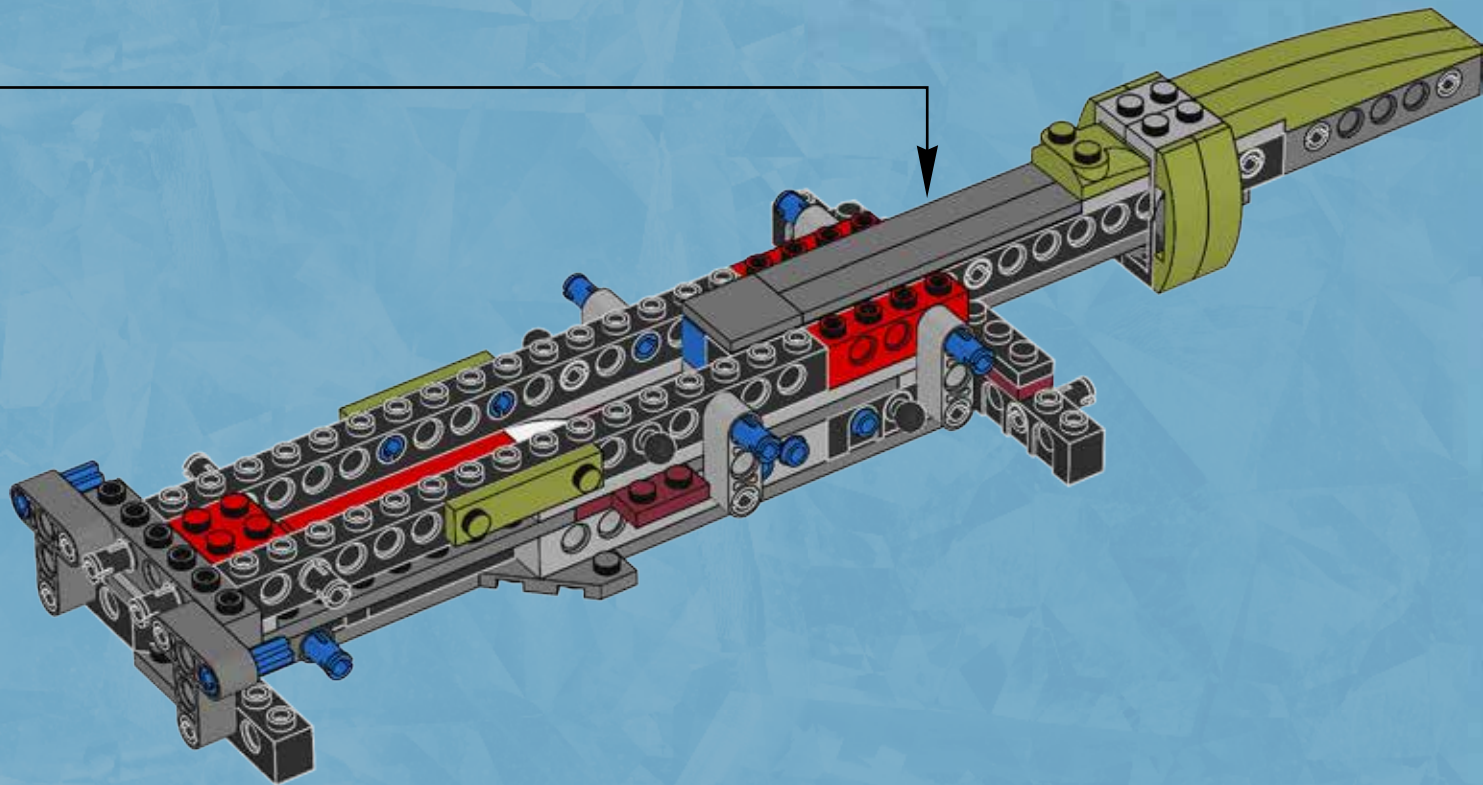



4x



2x

# 26

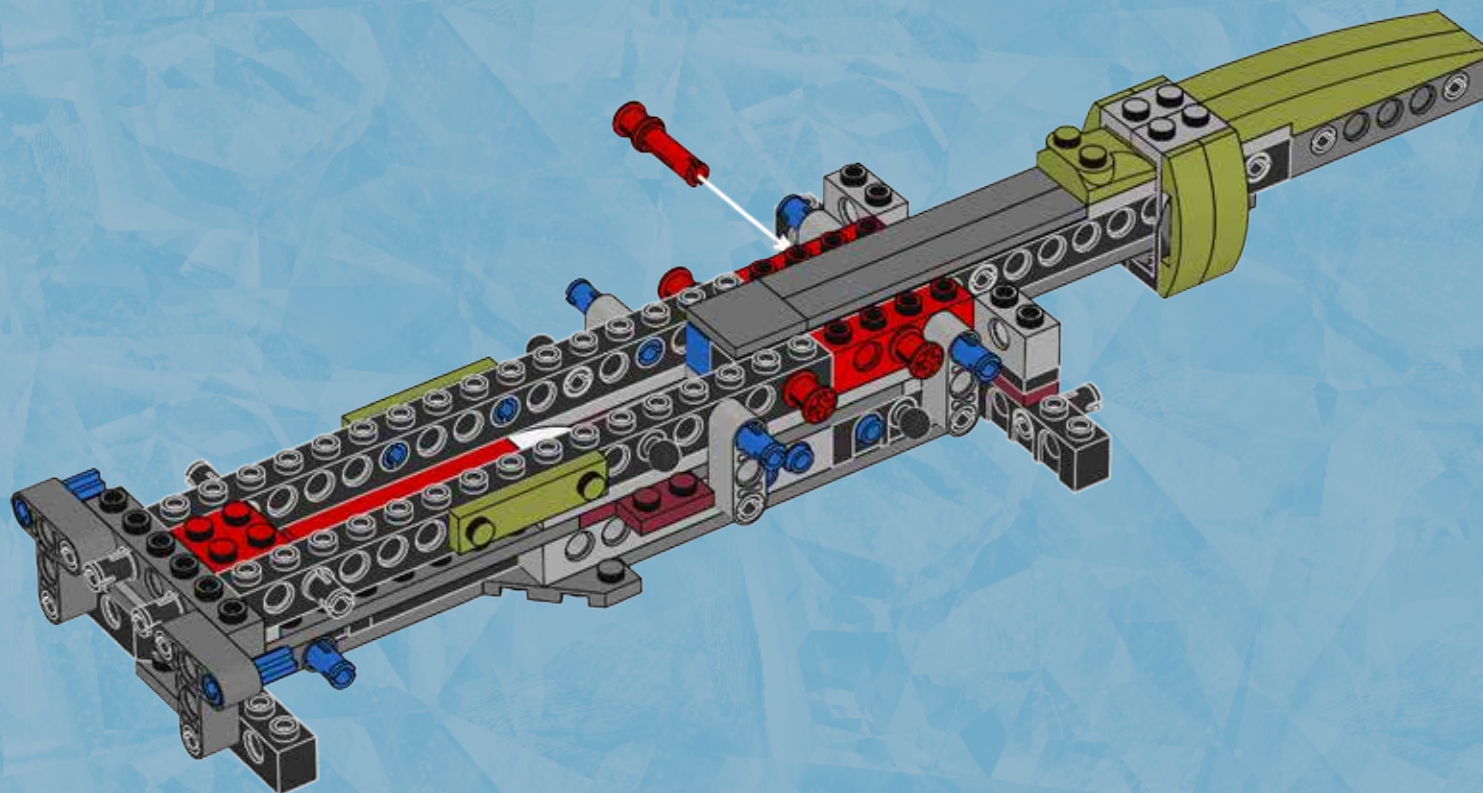





4x

28

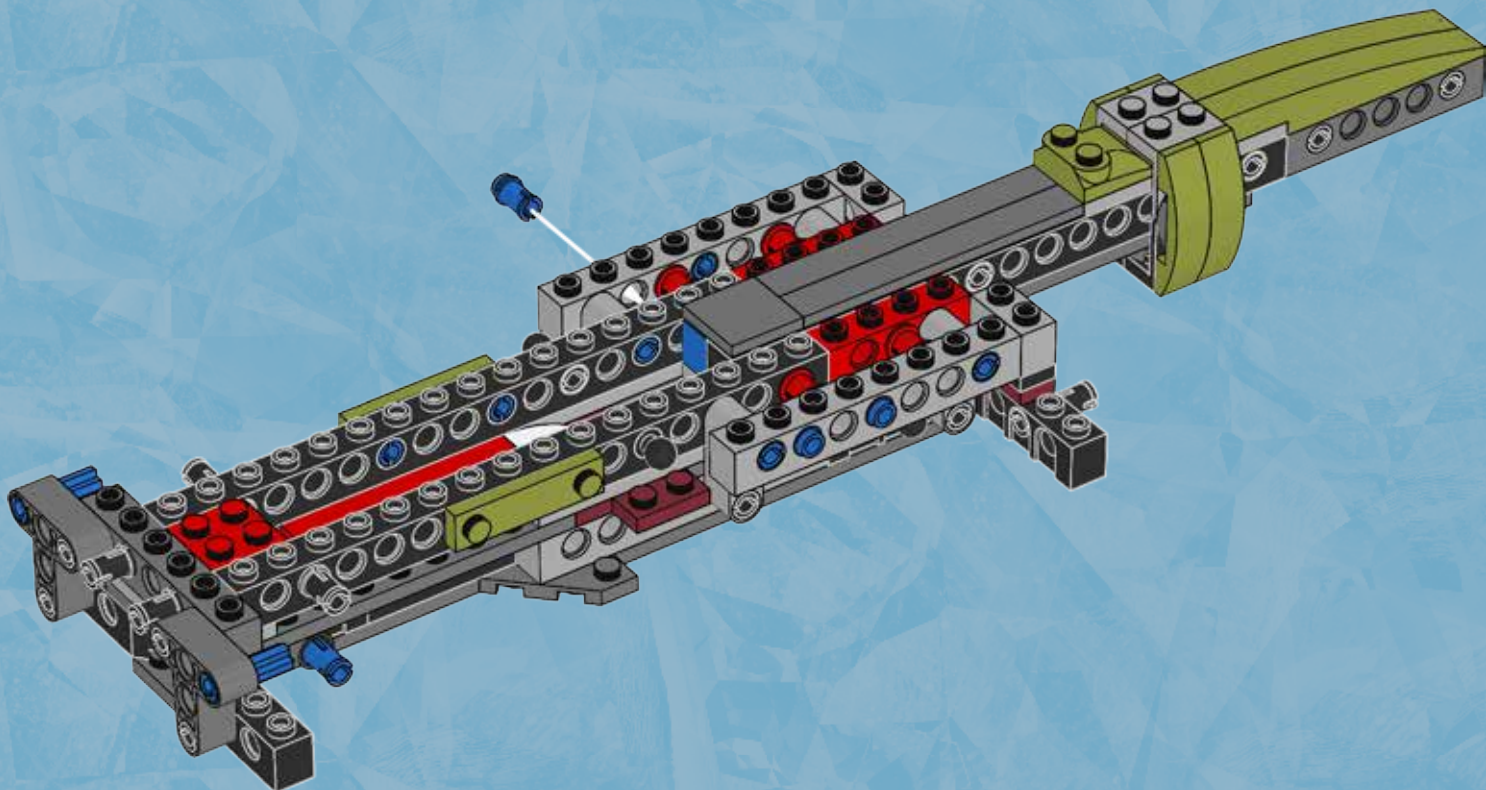



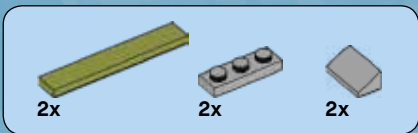

29

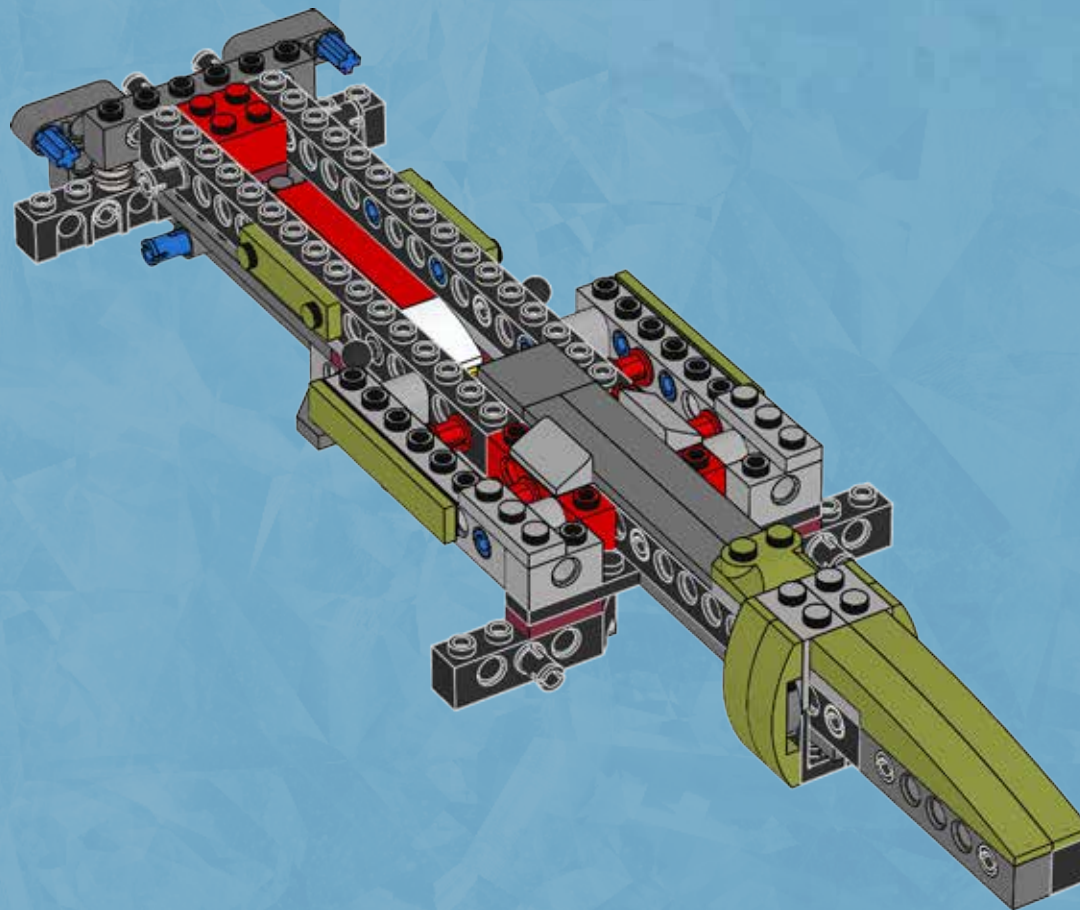



2x

# 30

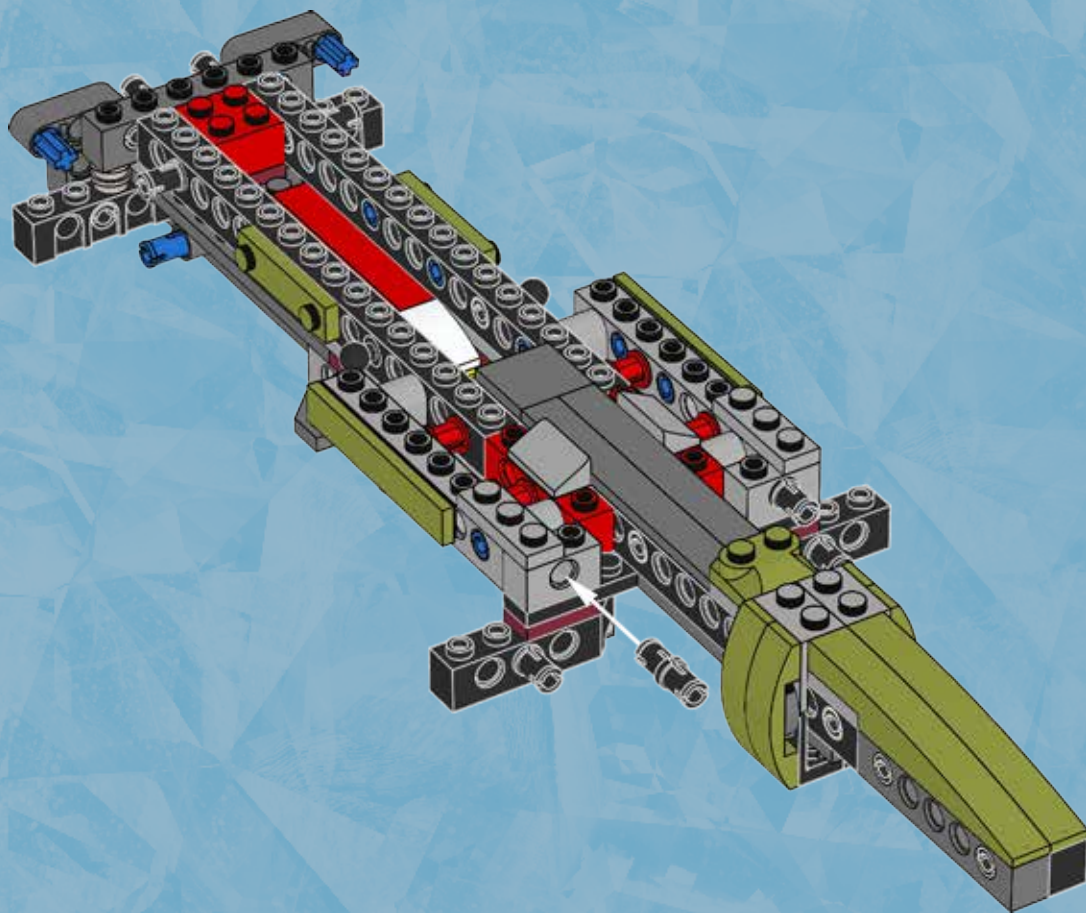



31

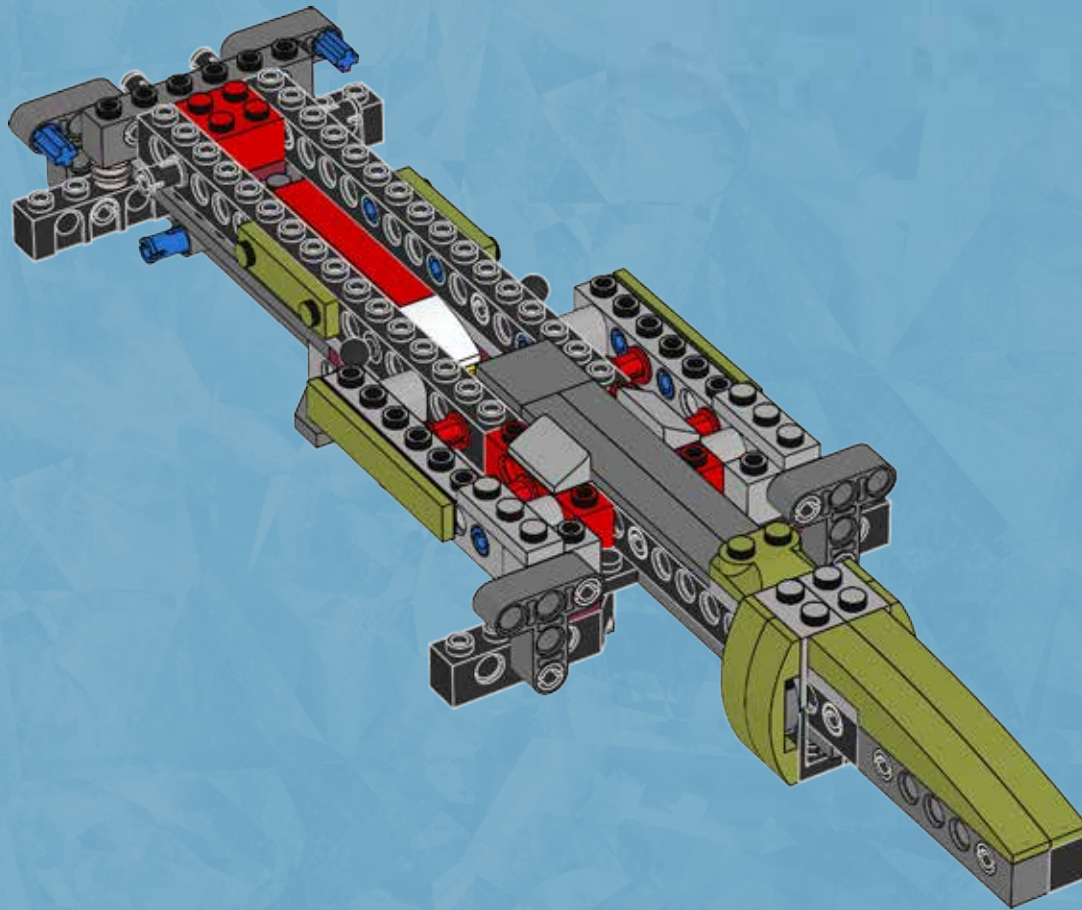



2x

# 32

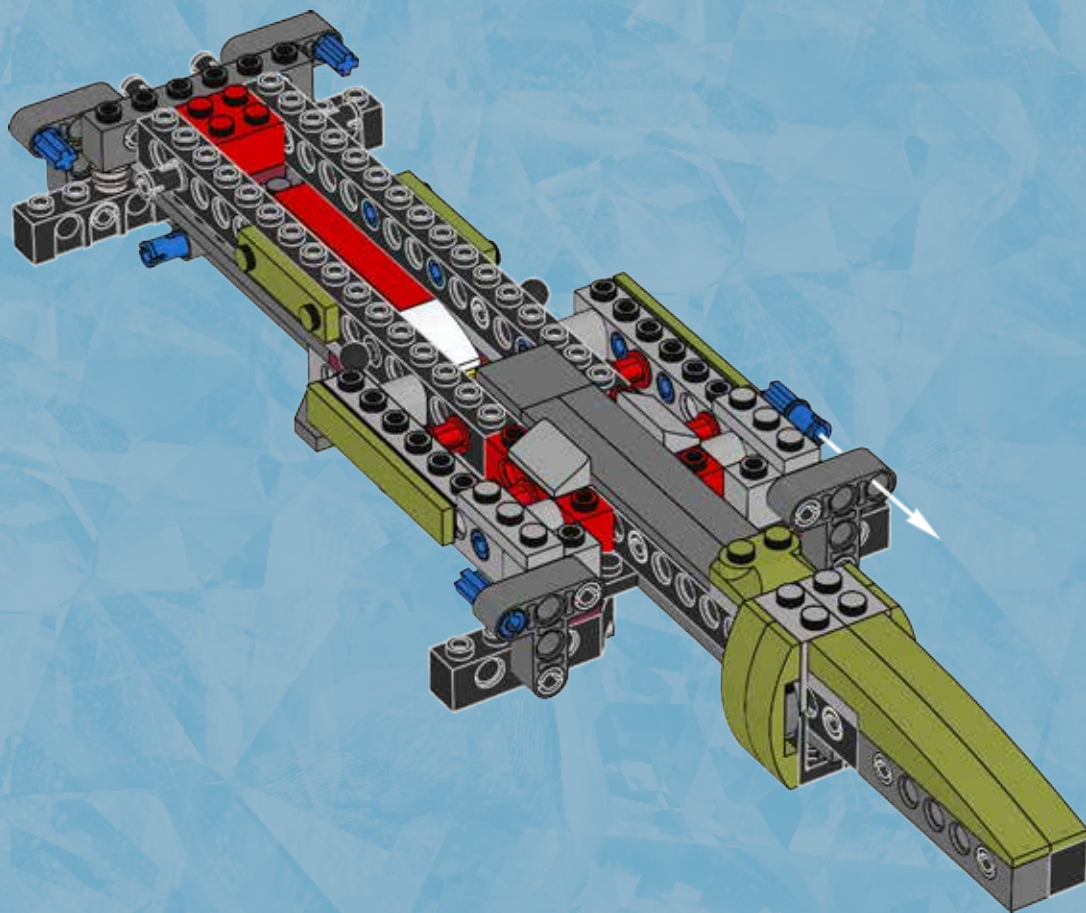

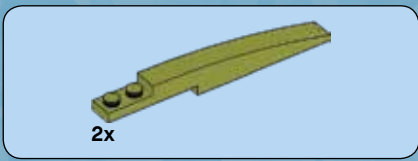

33

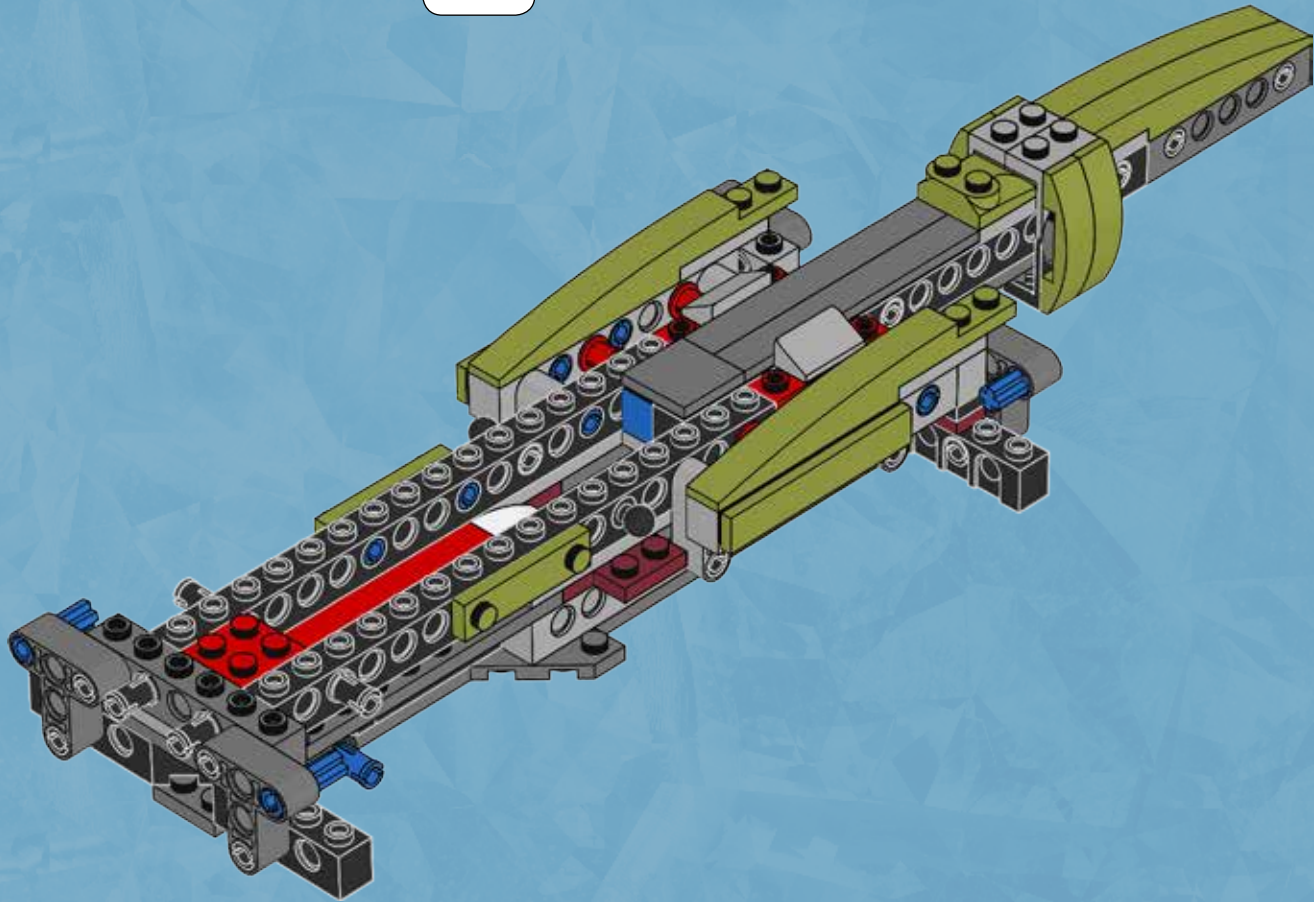



4x

# 34

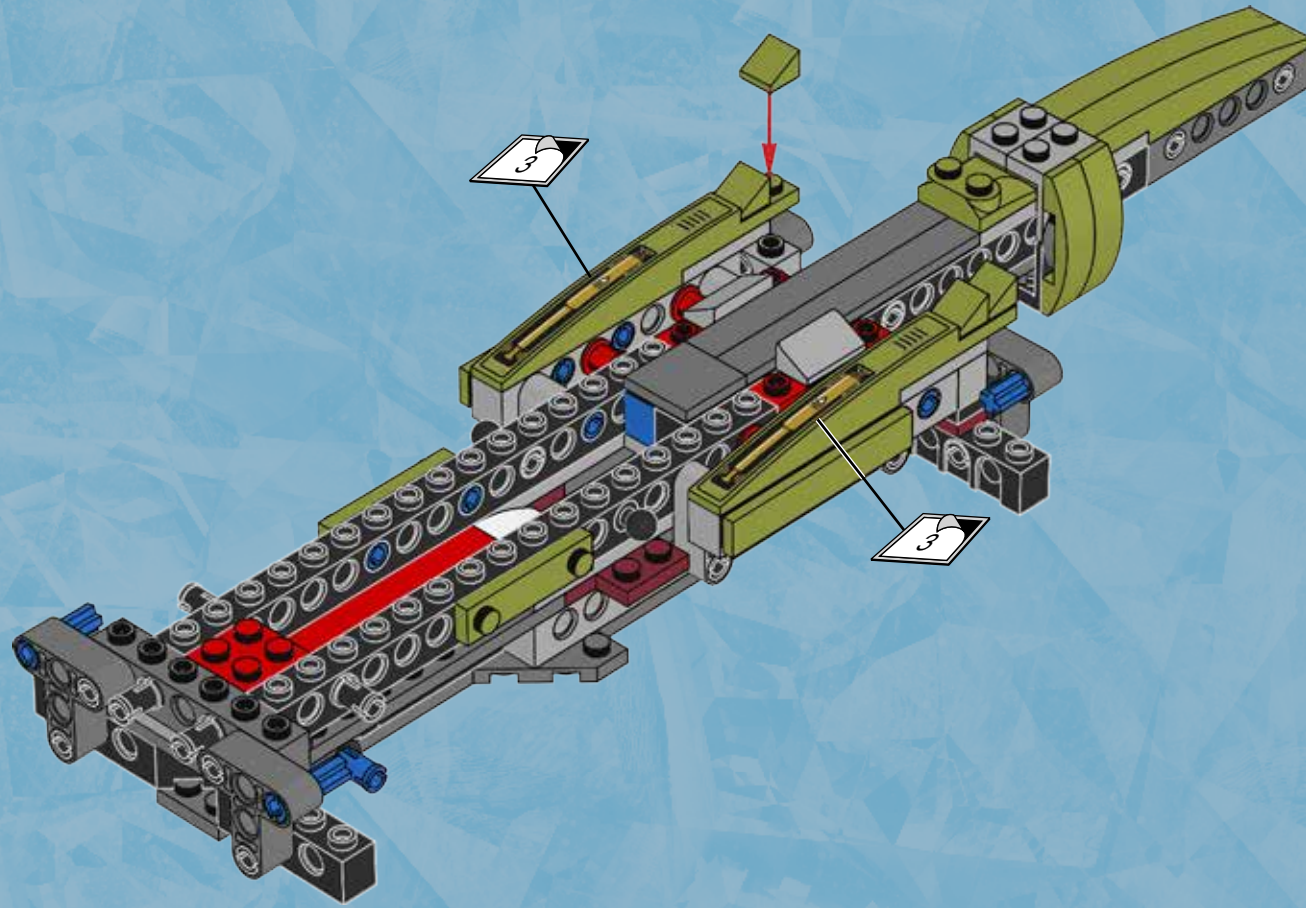



2x

# 35

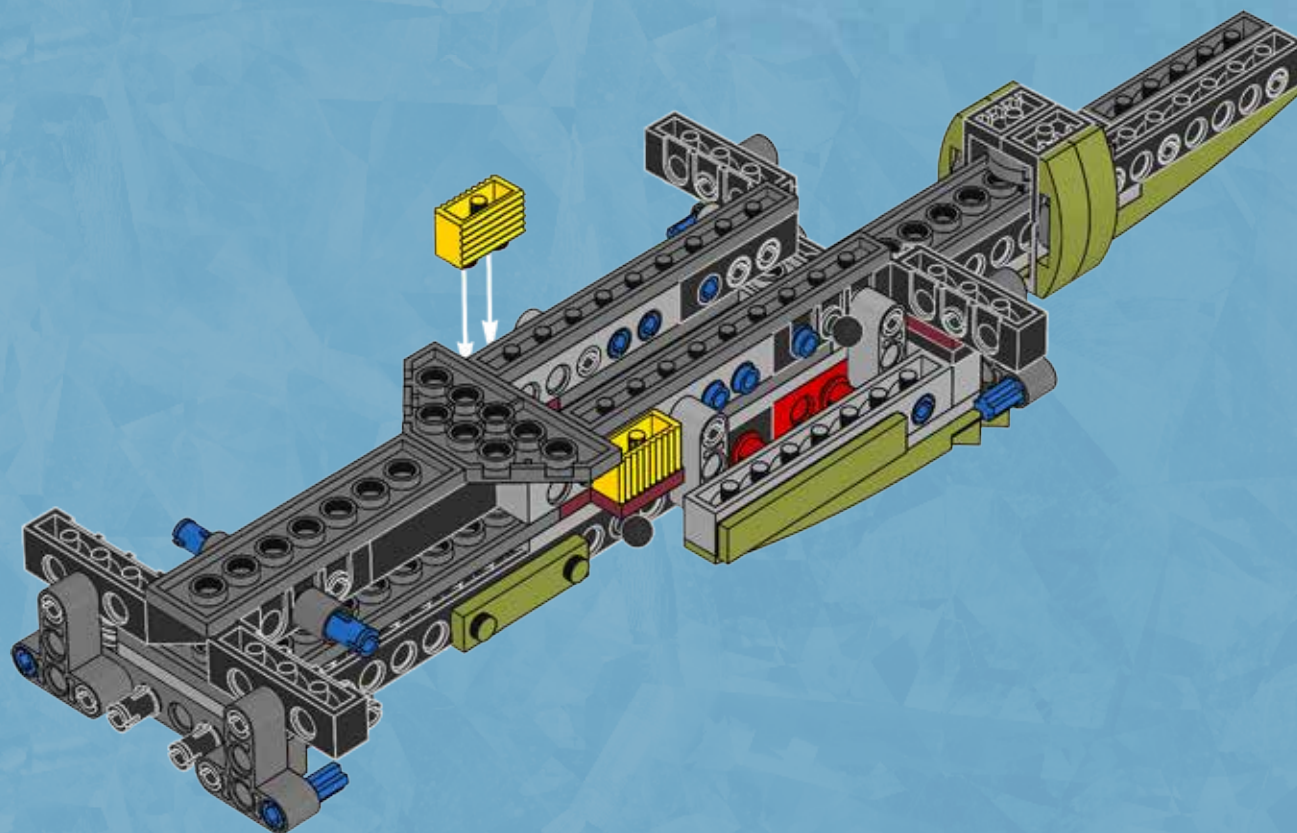



2x



2x

# 36

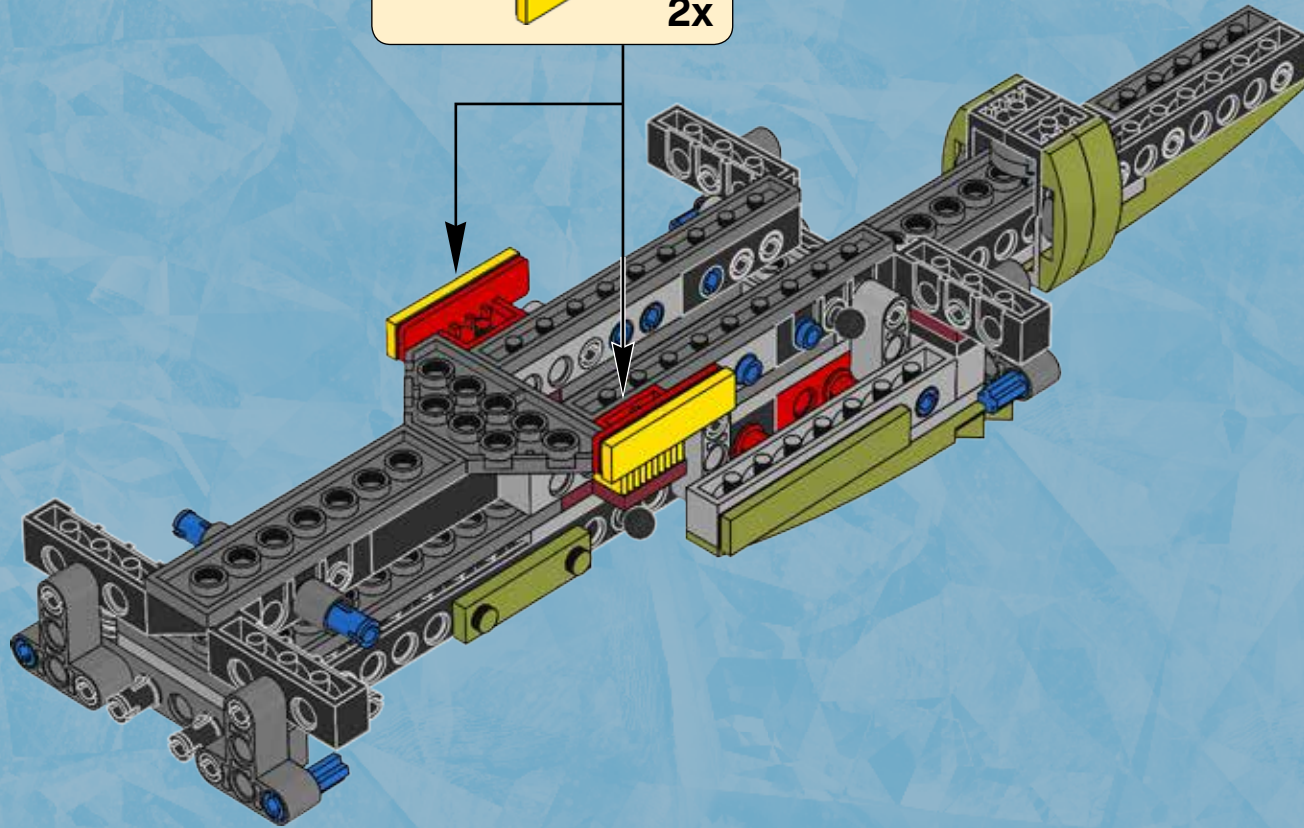
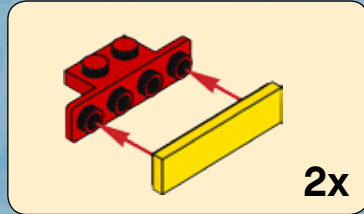





4x

# 37

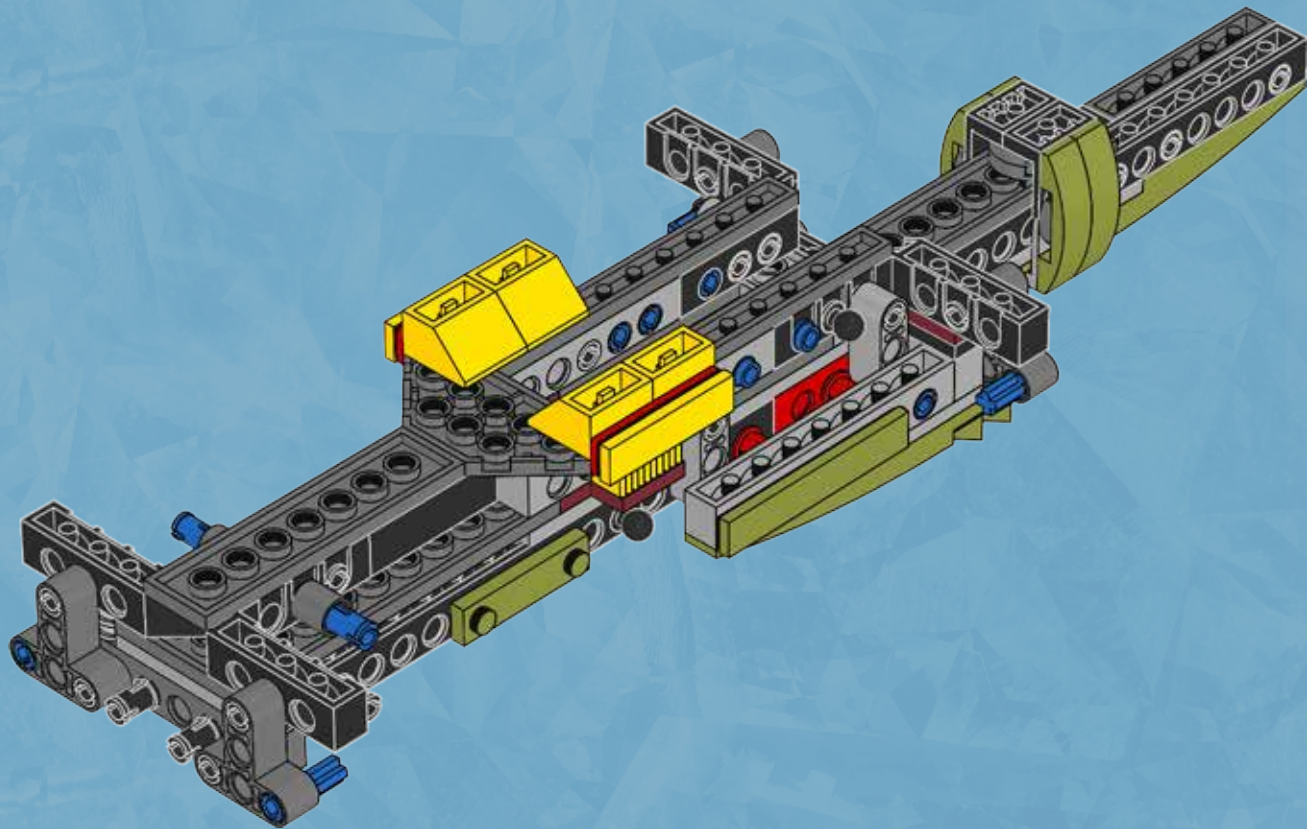



1x



2x



2x

# 38

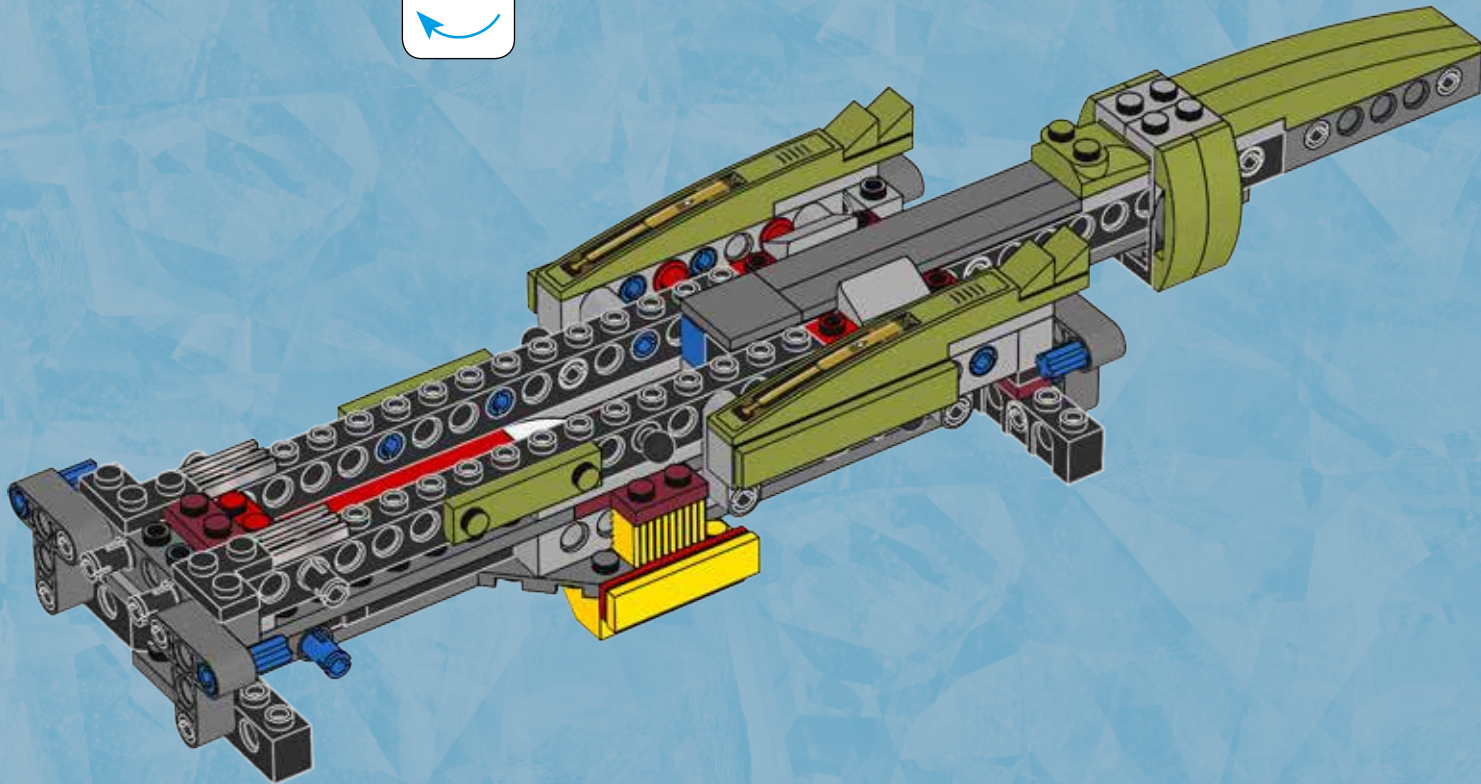

39

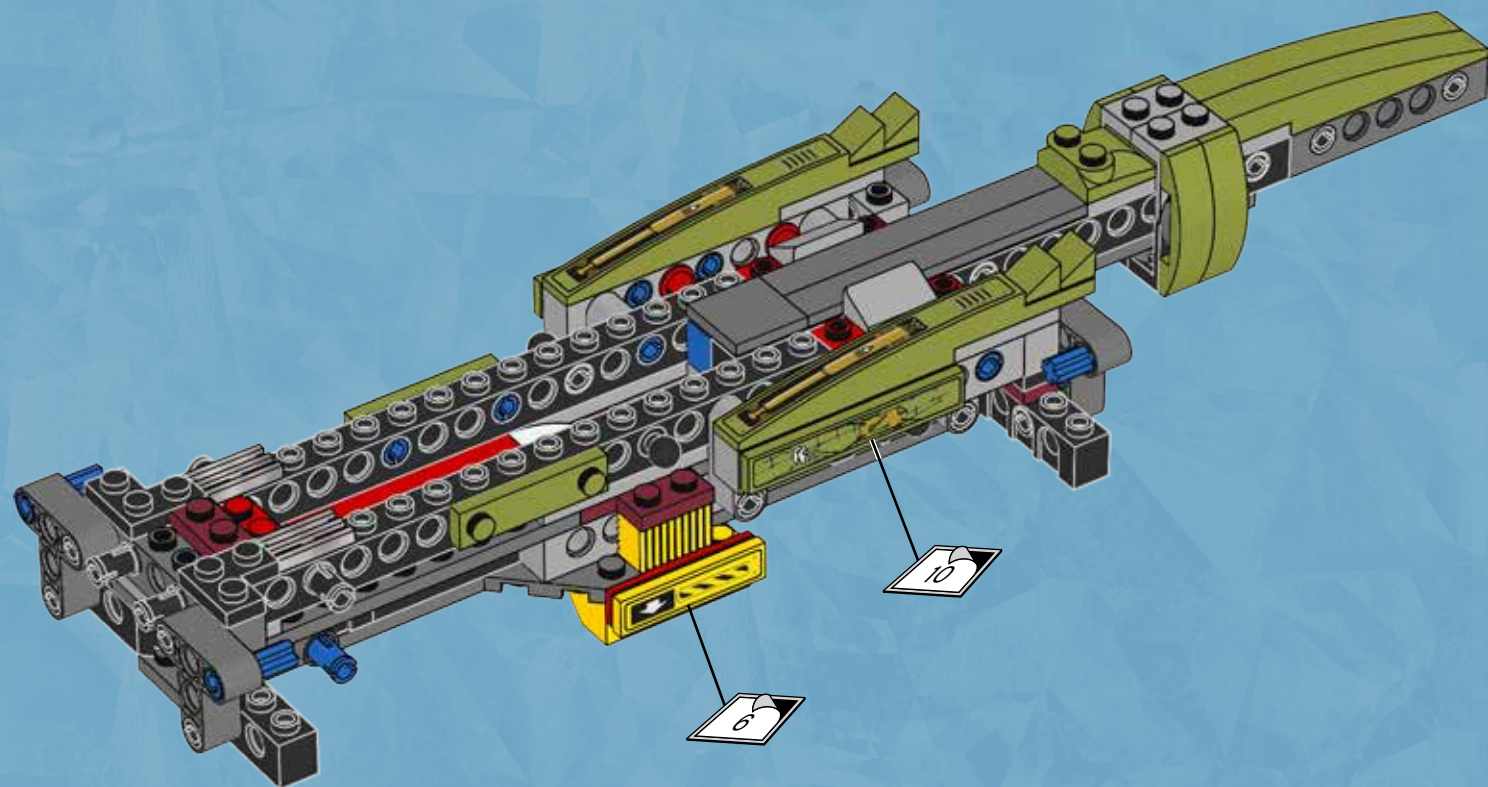

40

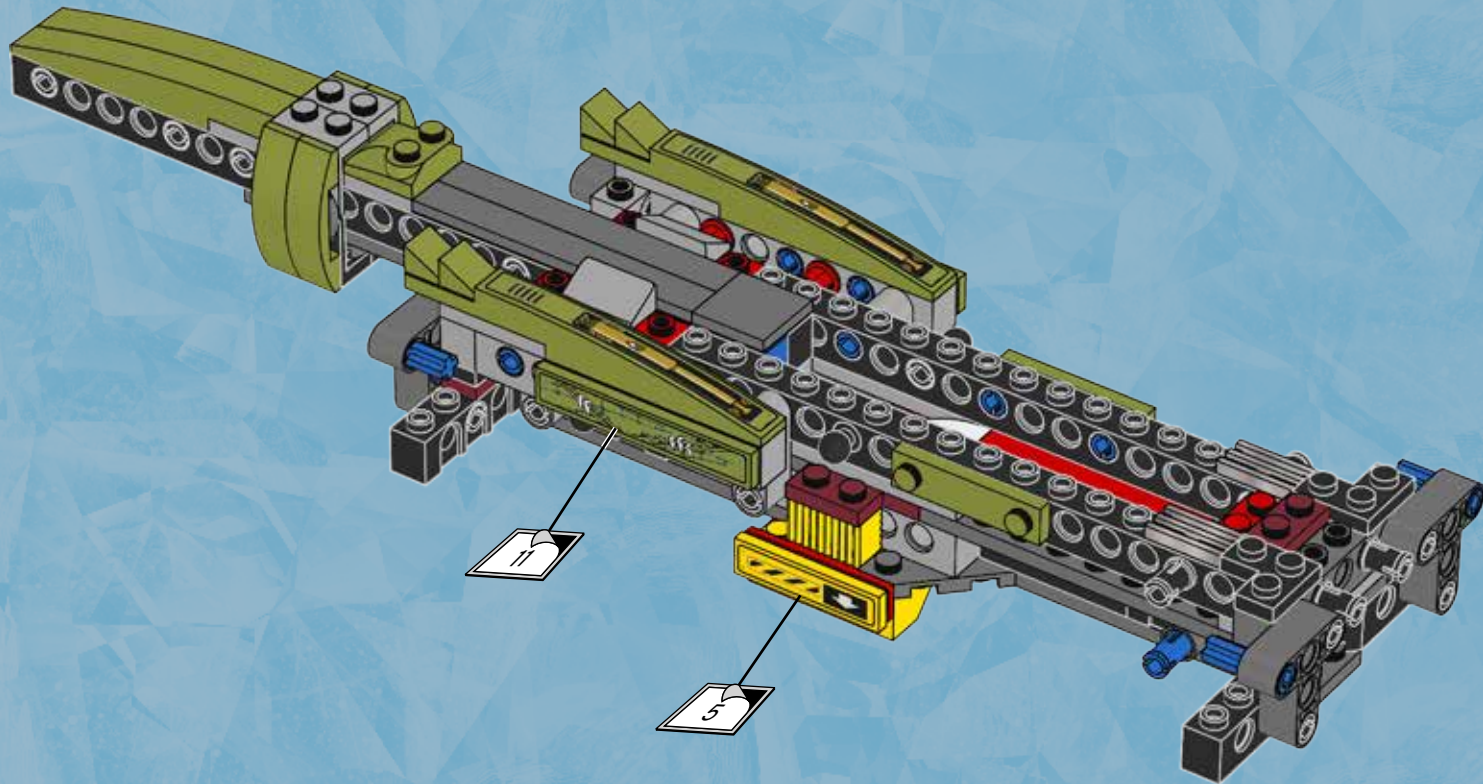

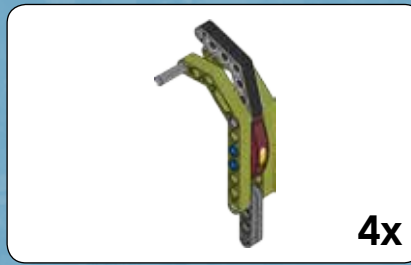
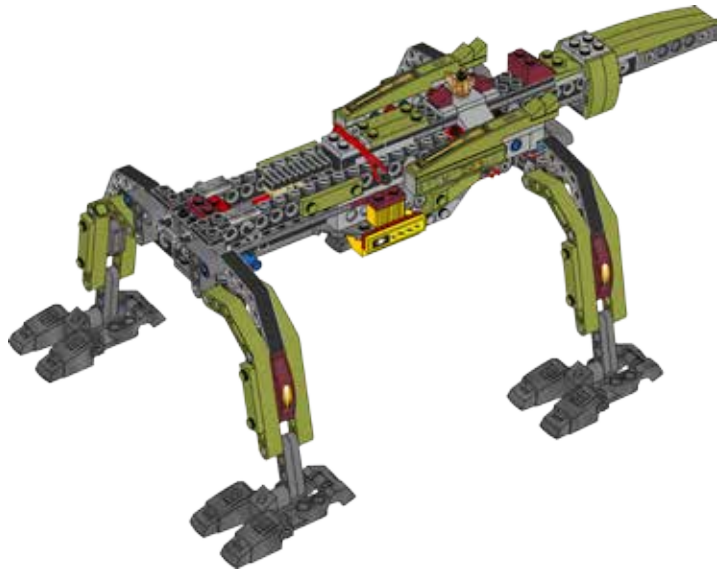
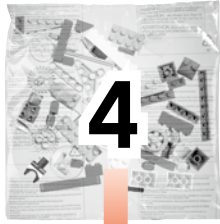

4x

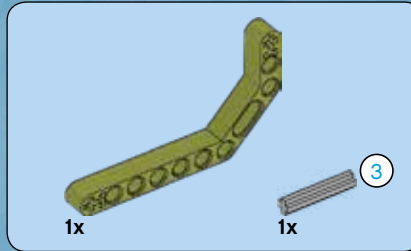
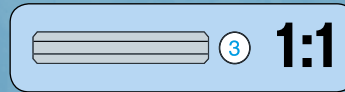

1

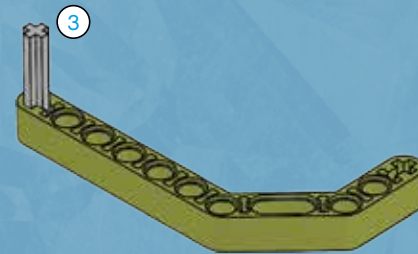



2x



2x

2

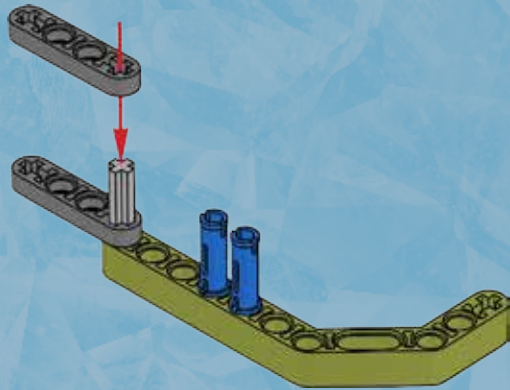

1x



1x

3

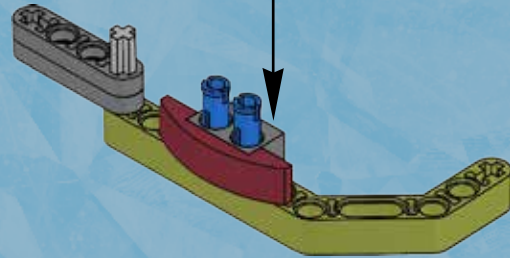
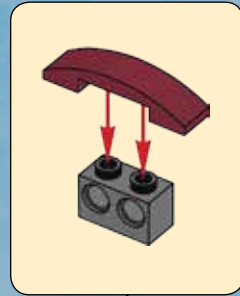

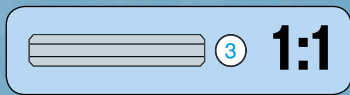
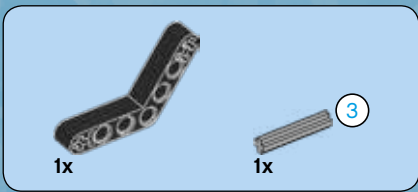

4

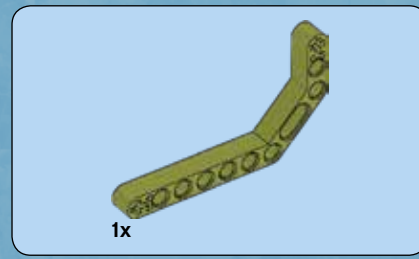
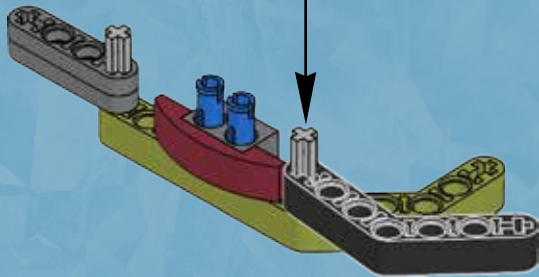
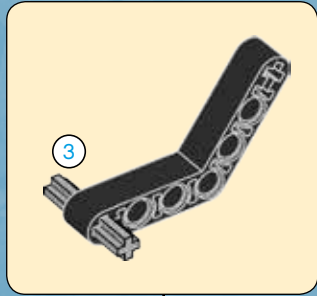

5

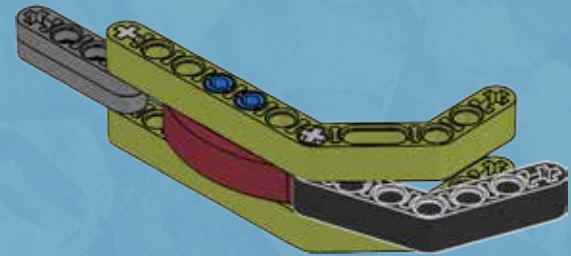

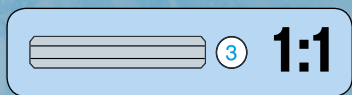
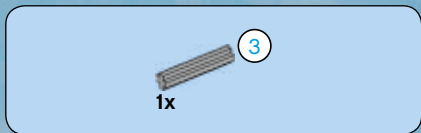

6

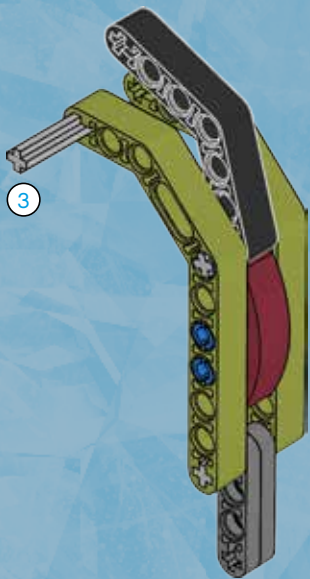

7

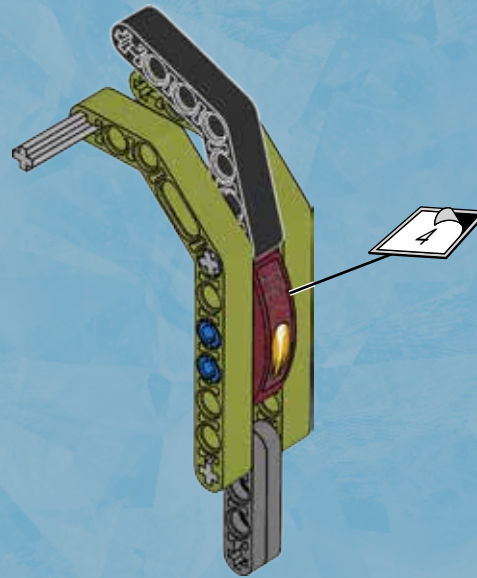

4x



41

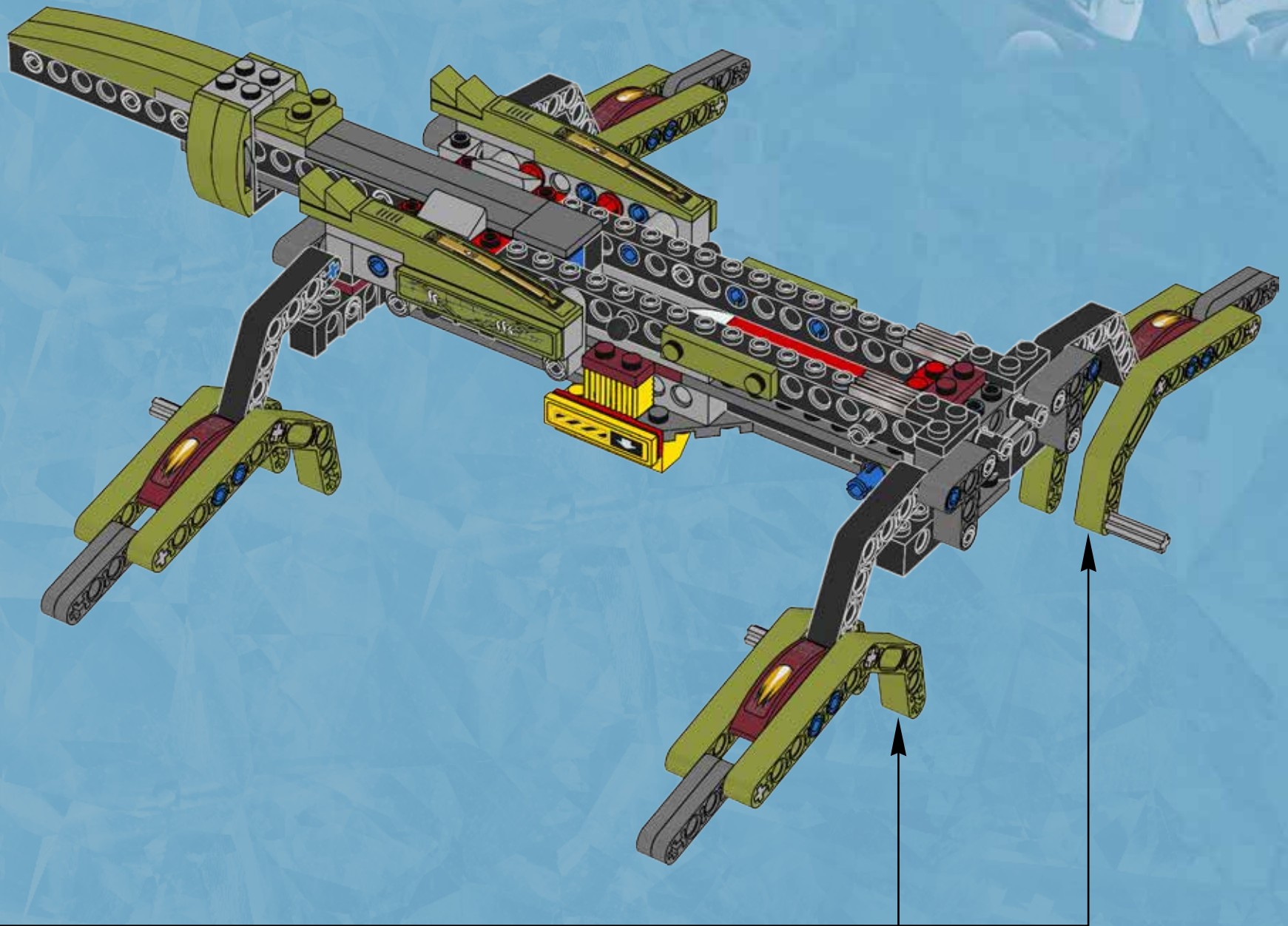

42

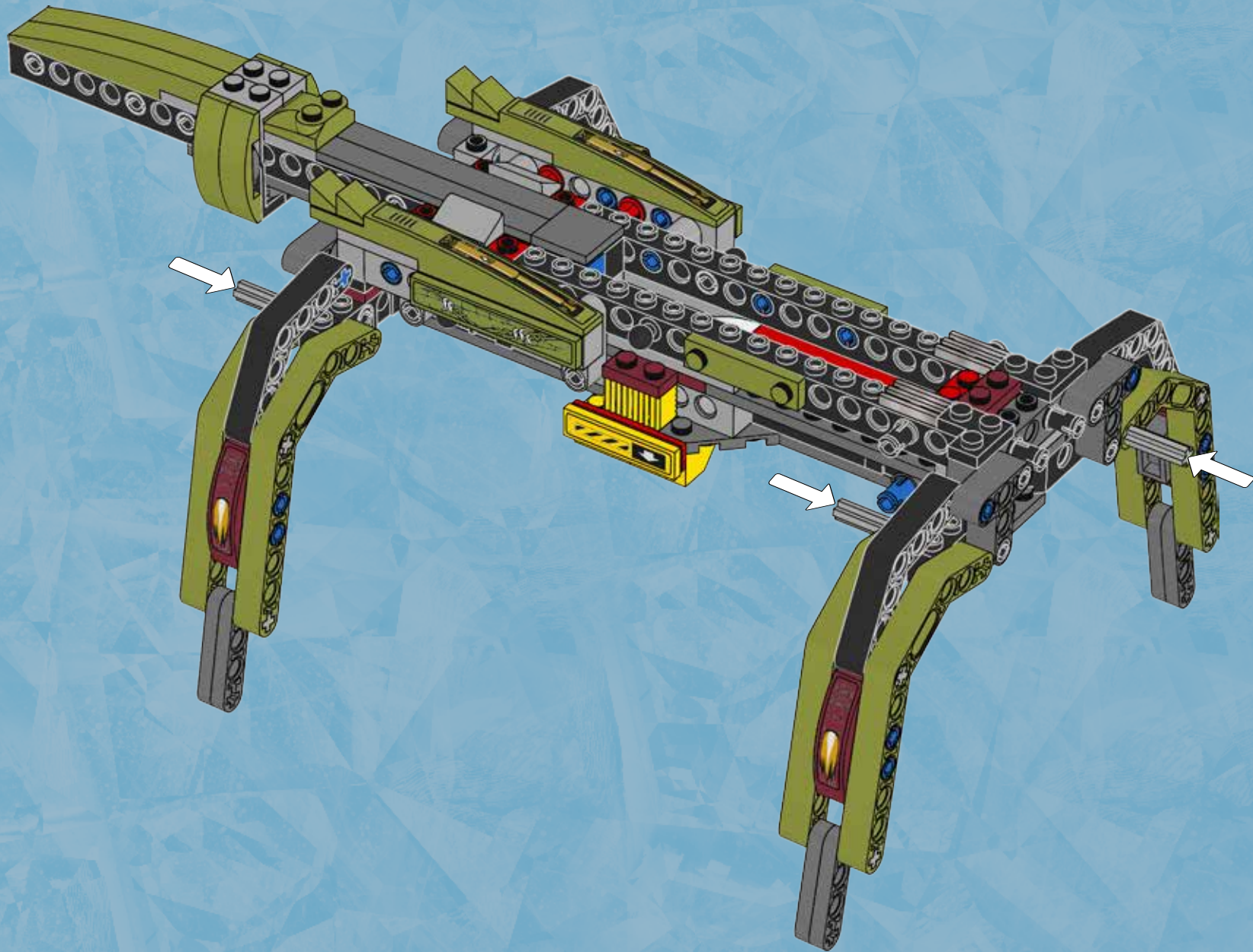



4x

# 43

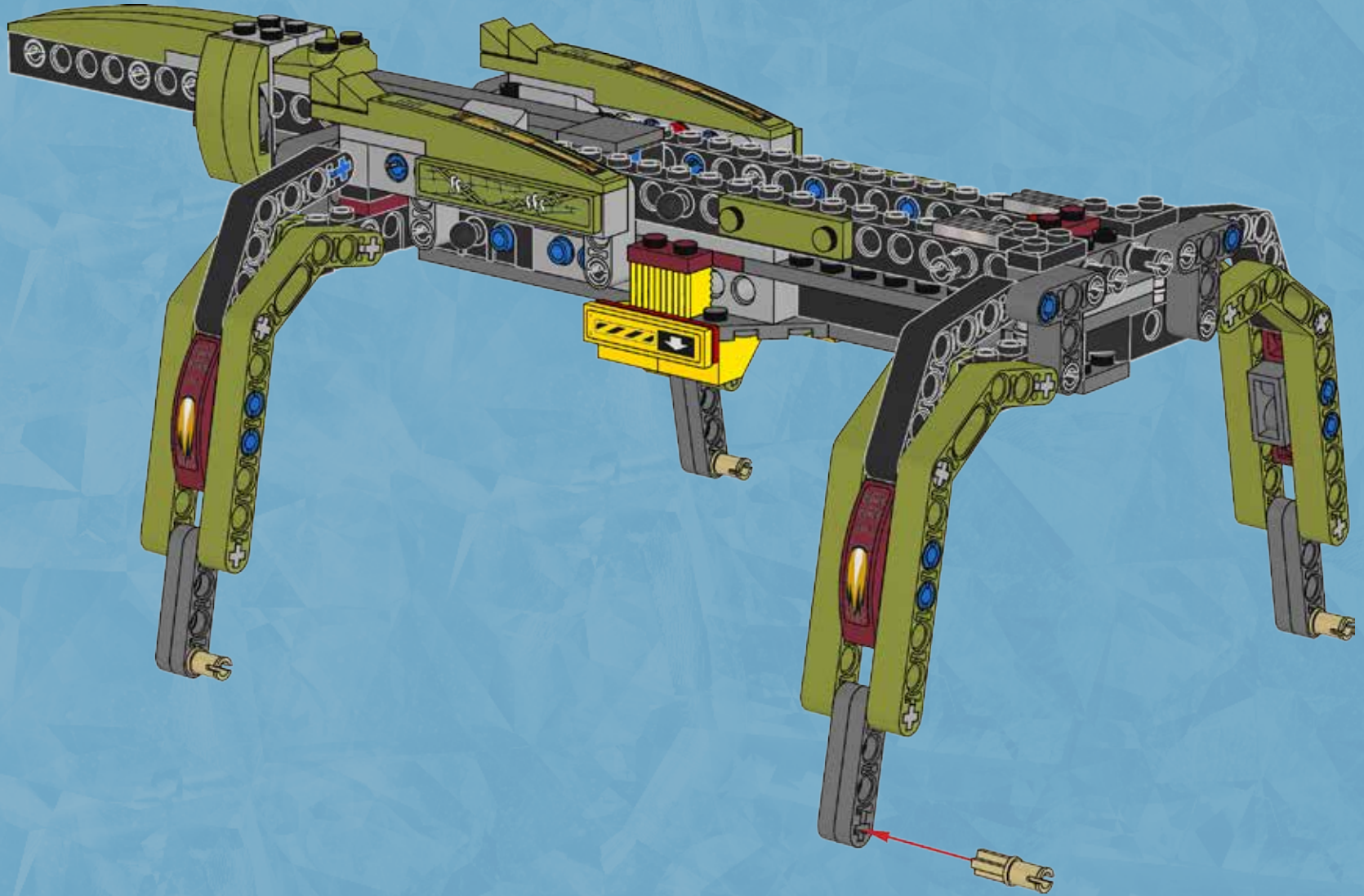



44

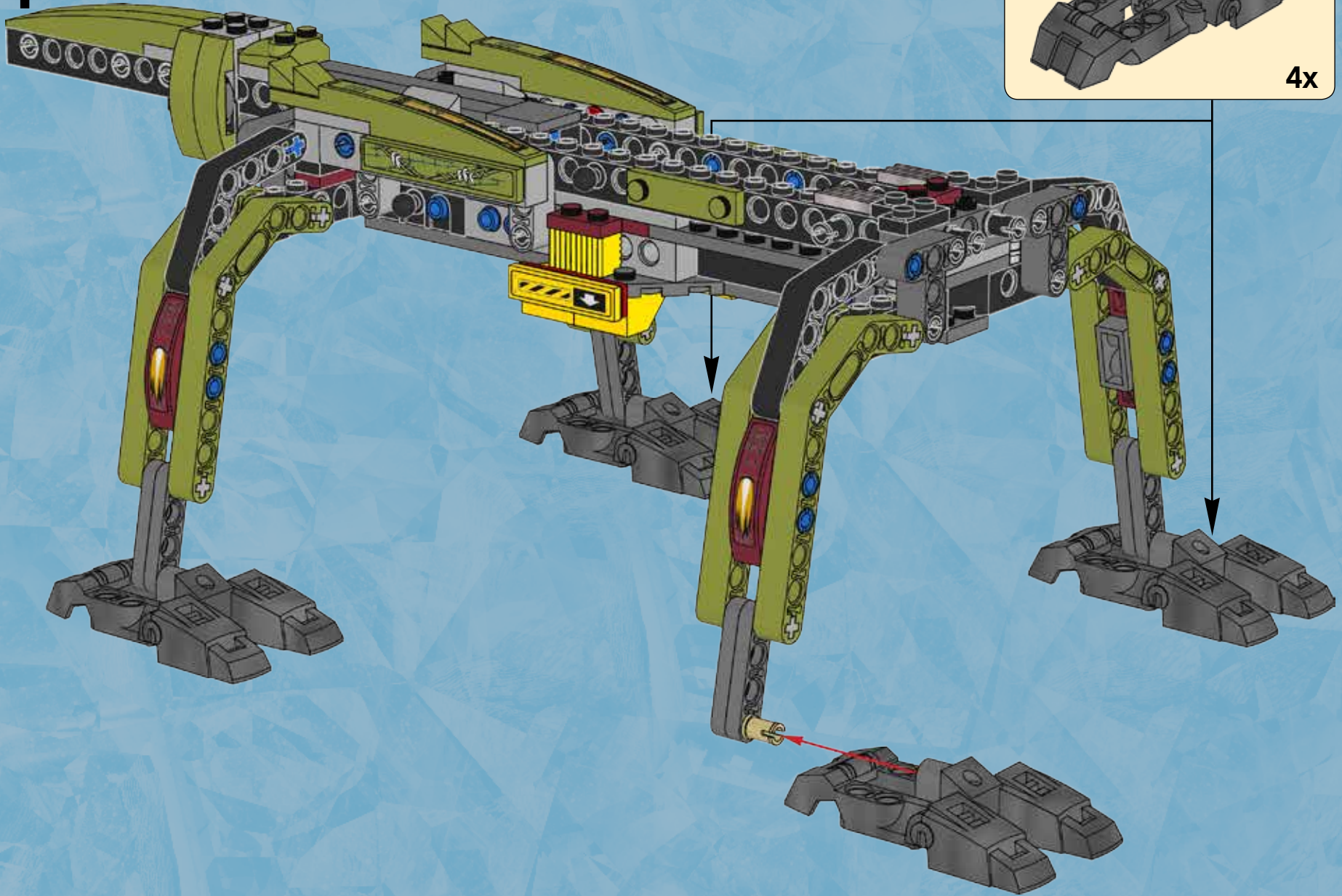
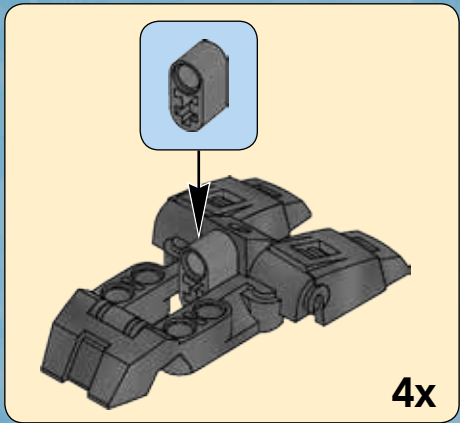

4x

45

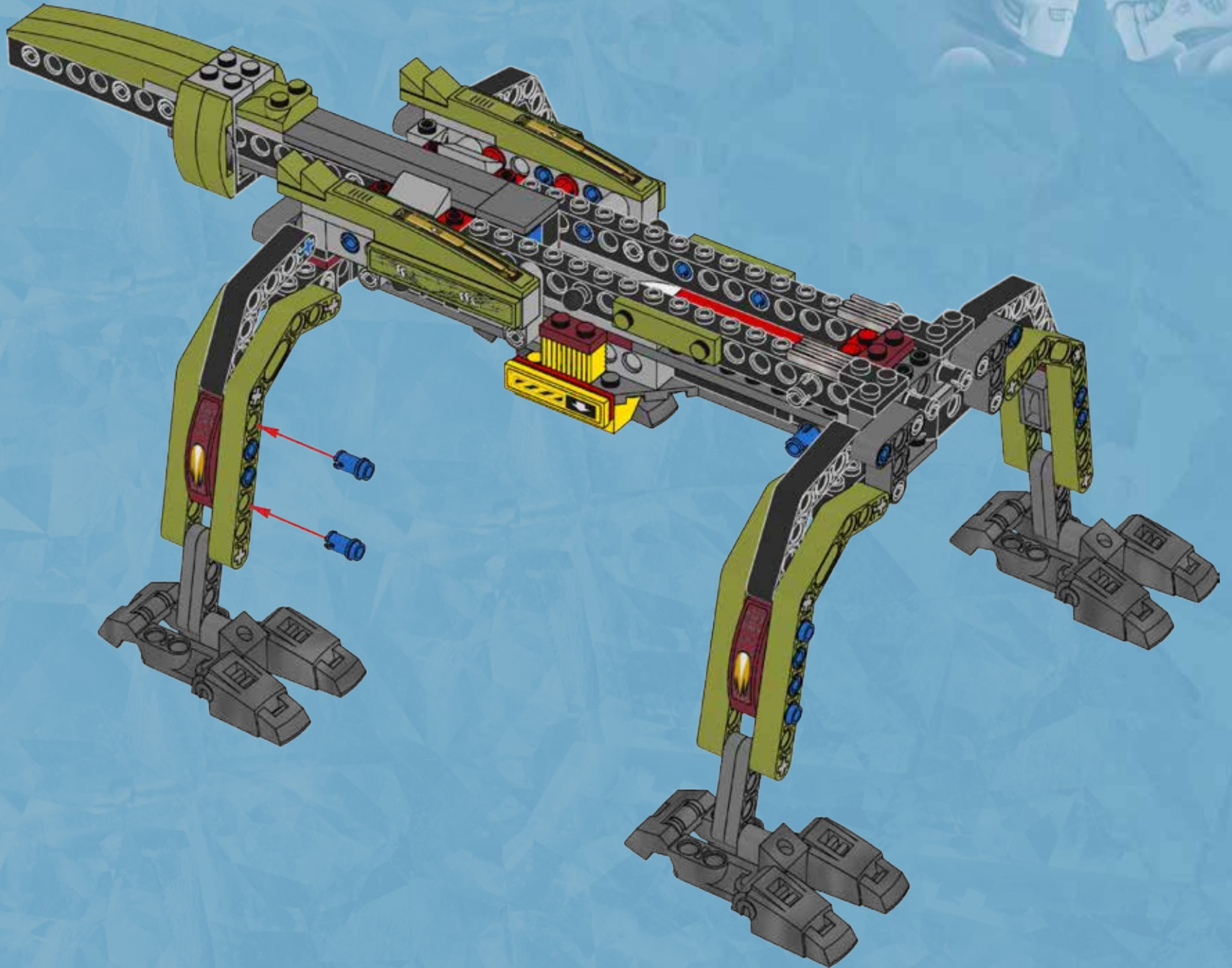



46

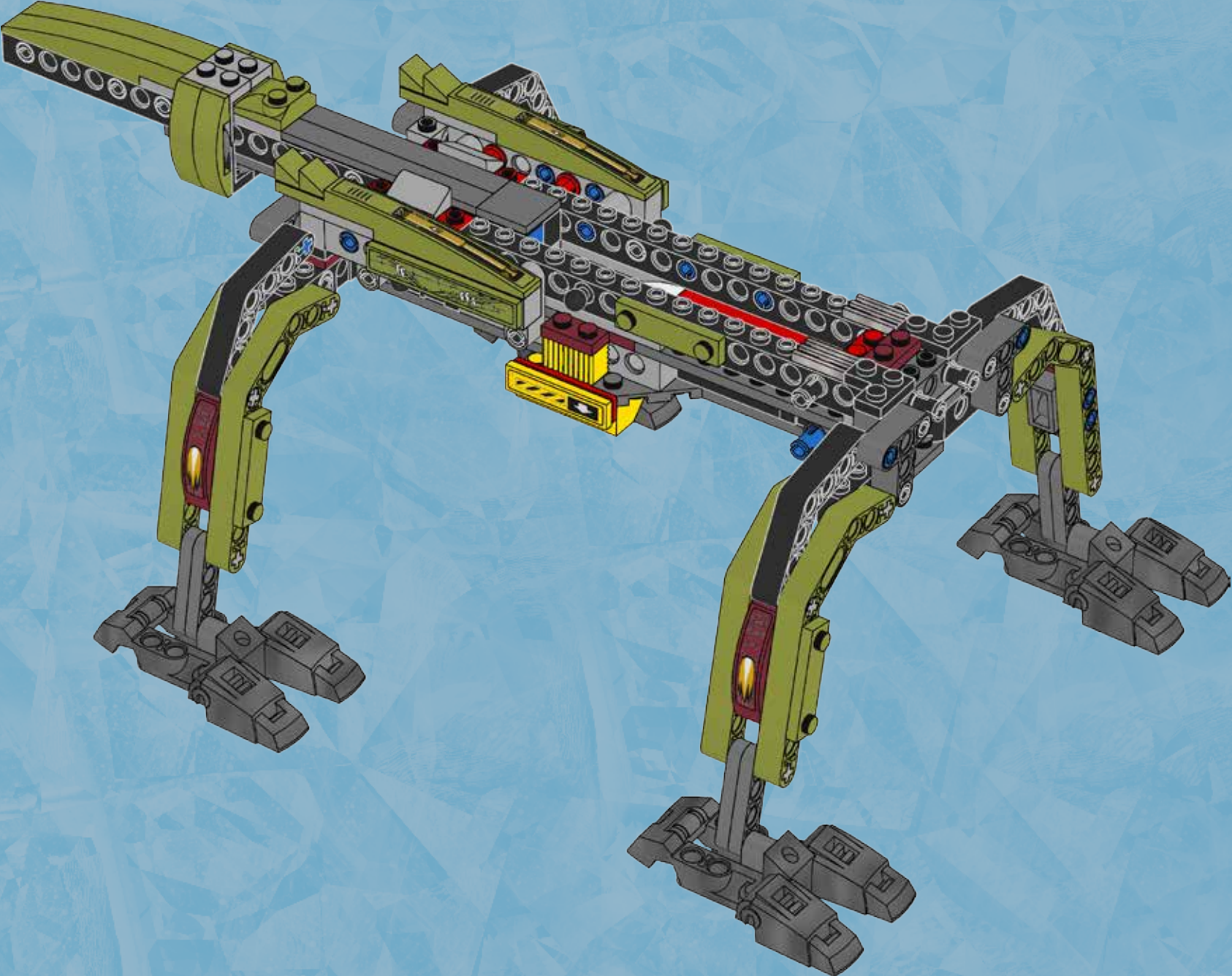

4x

47

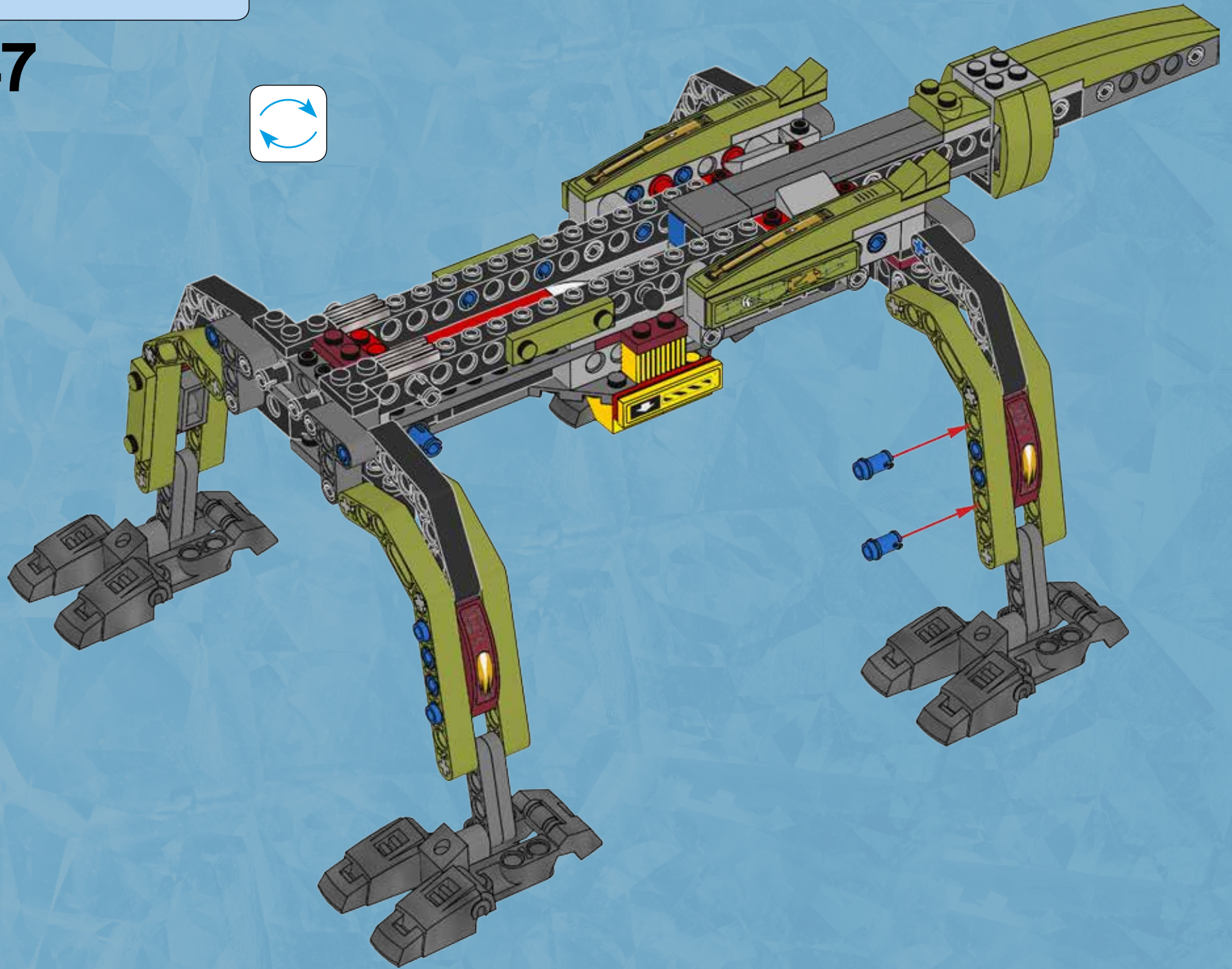



48

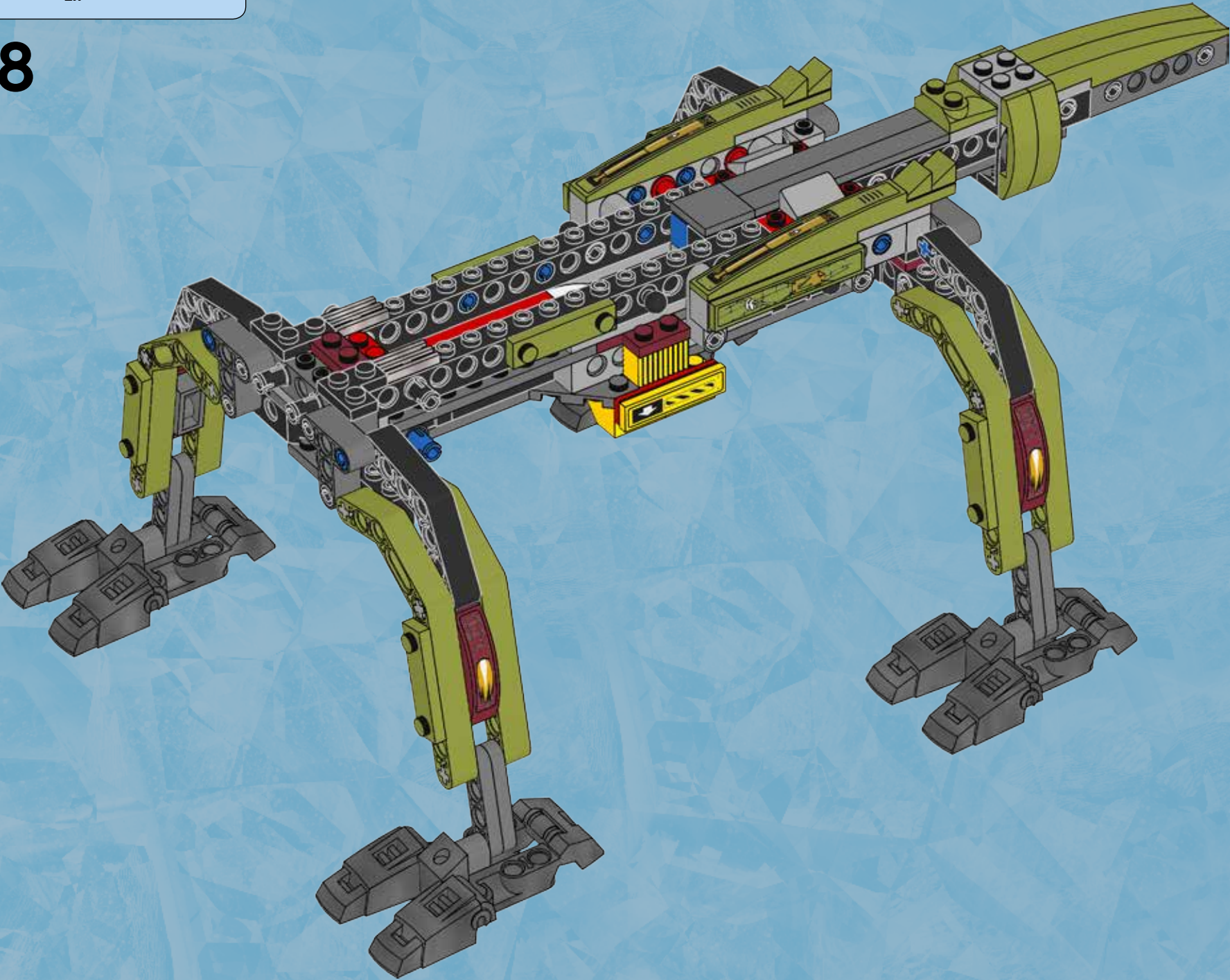



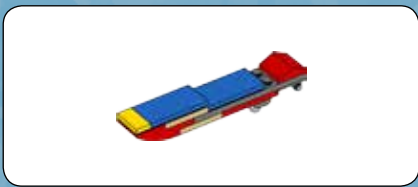

1



2

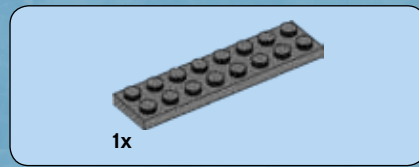

3



4





5

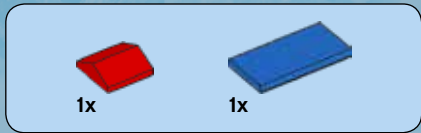
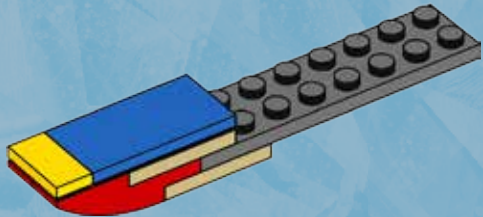

6

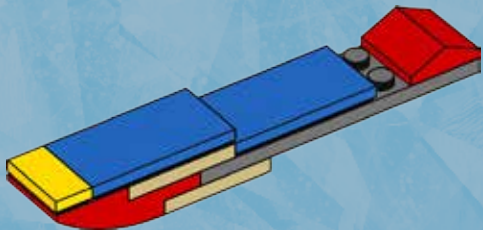

7

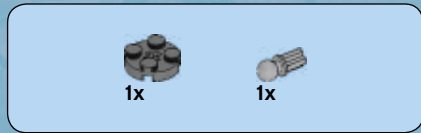
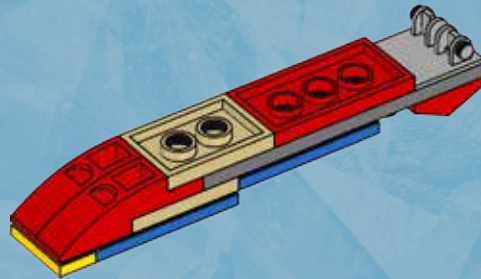

8

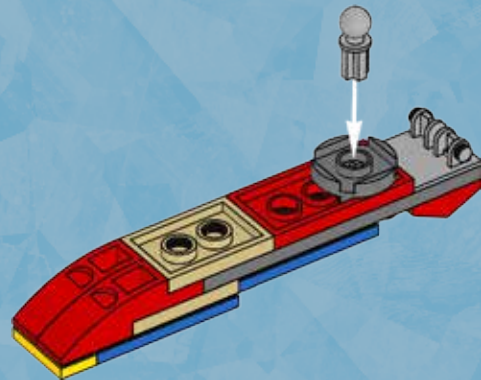

49

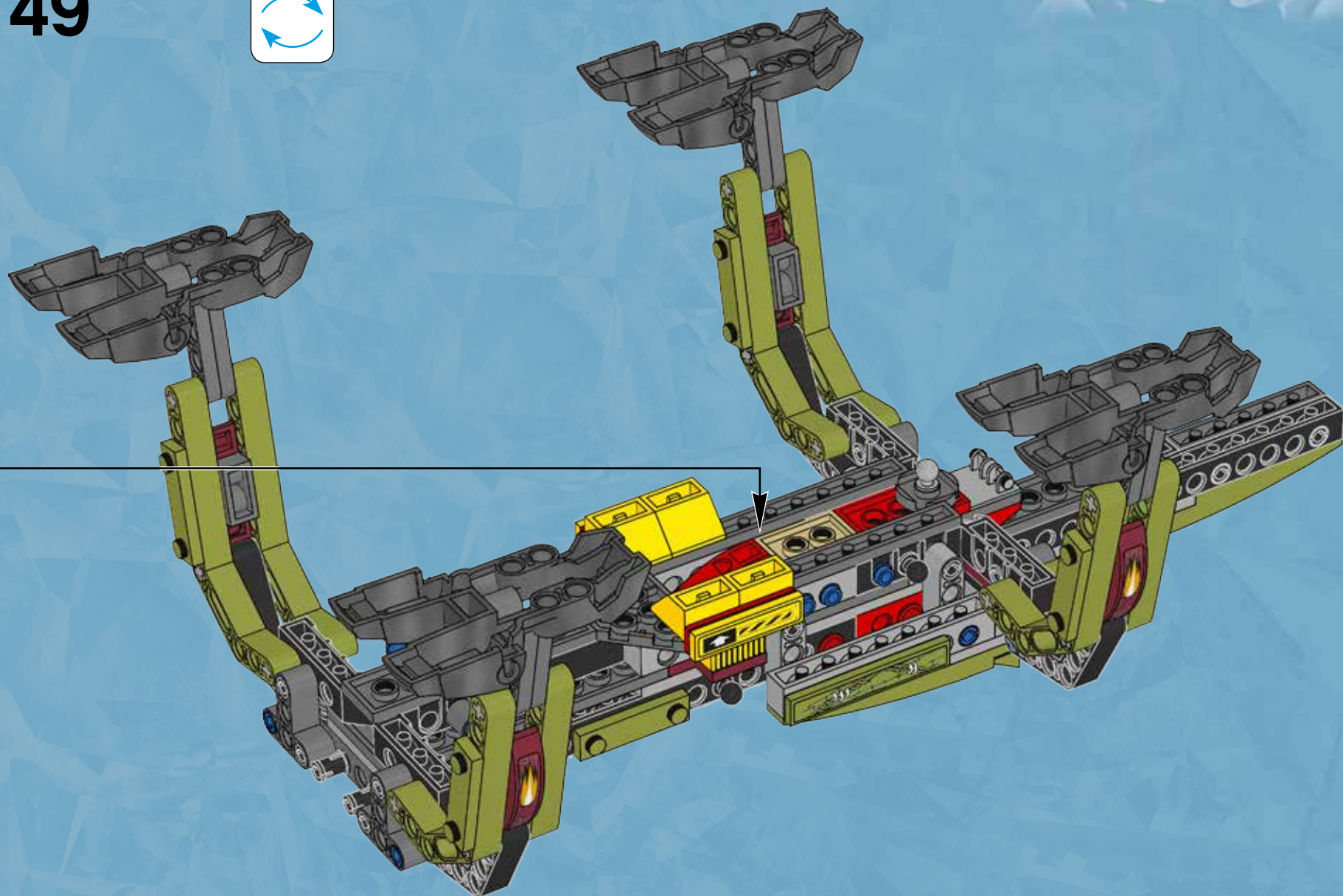

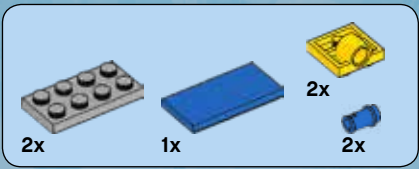

# 50

1

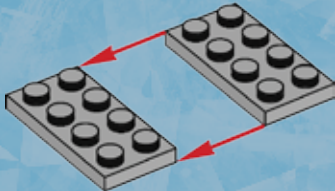

2

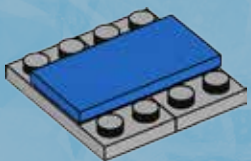

3

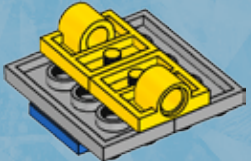
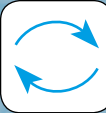

4

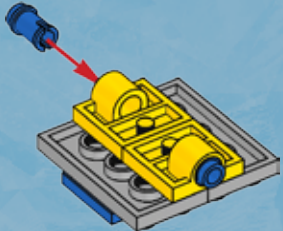

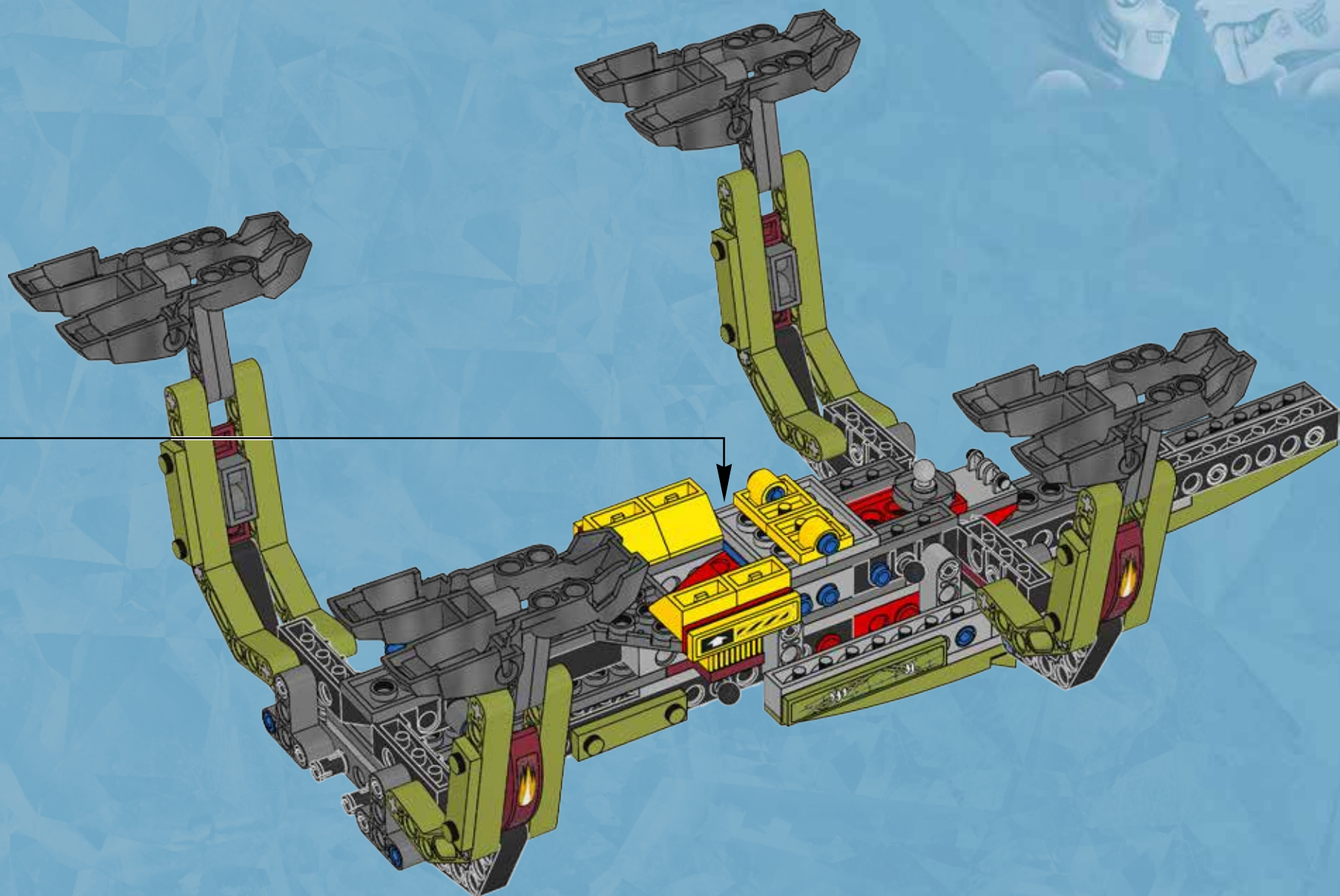



1x

51

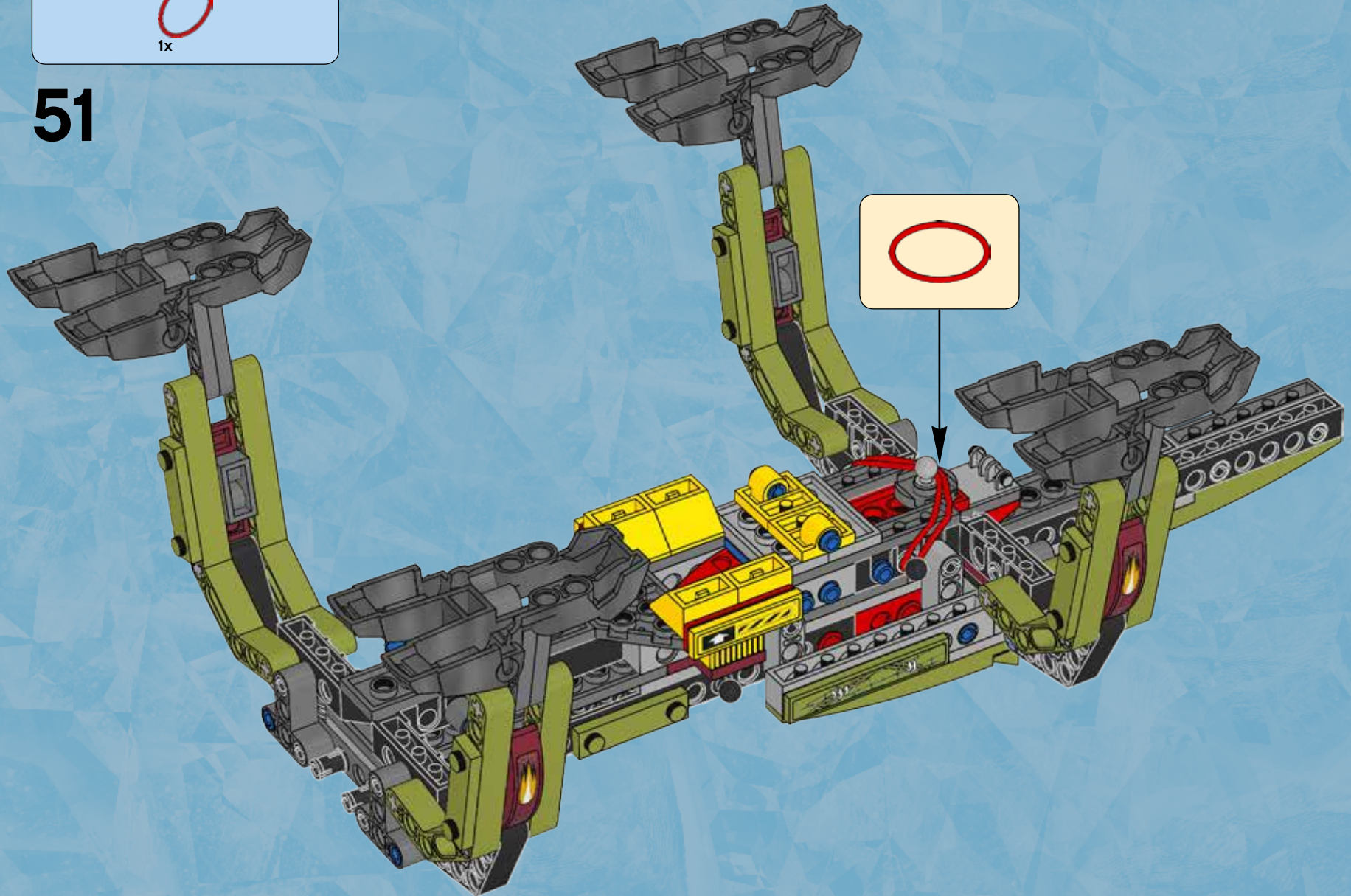



52

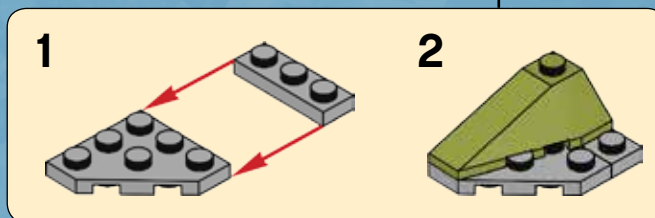
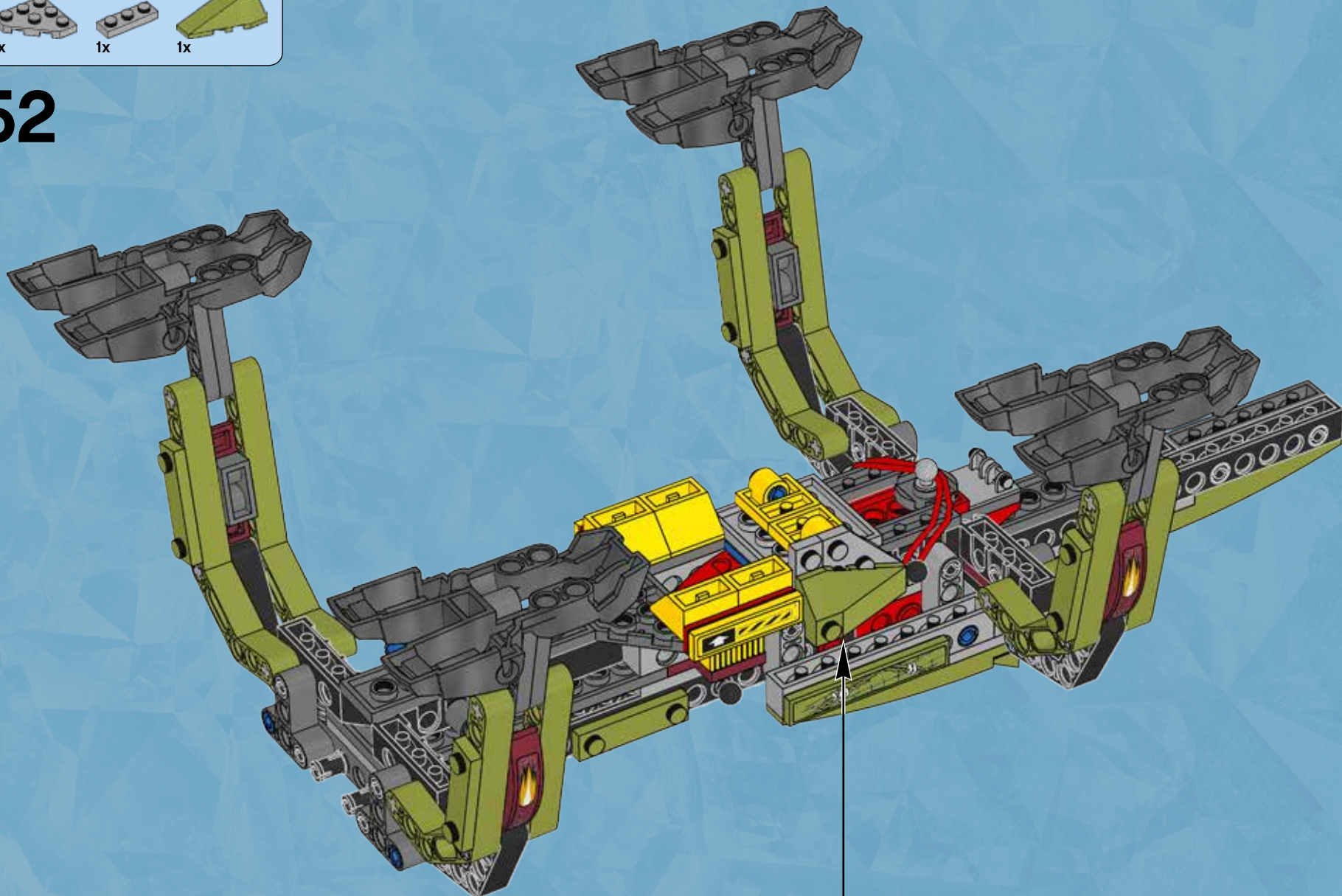

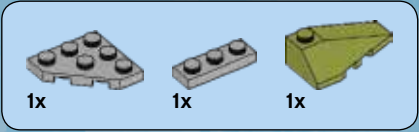

# 53

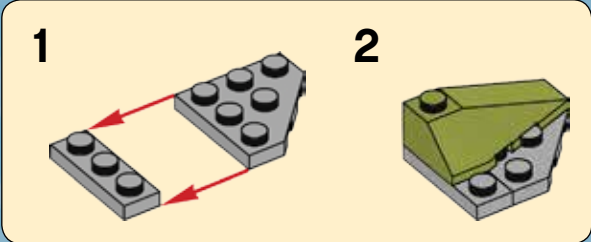
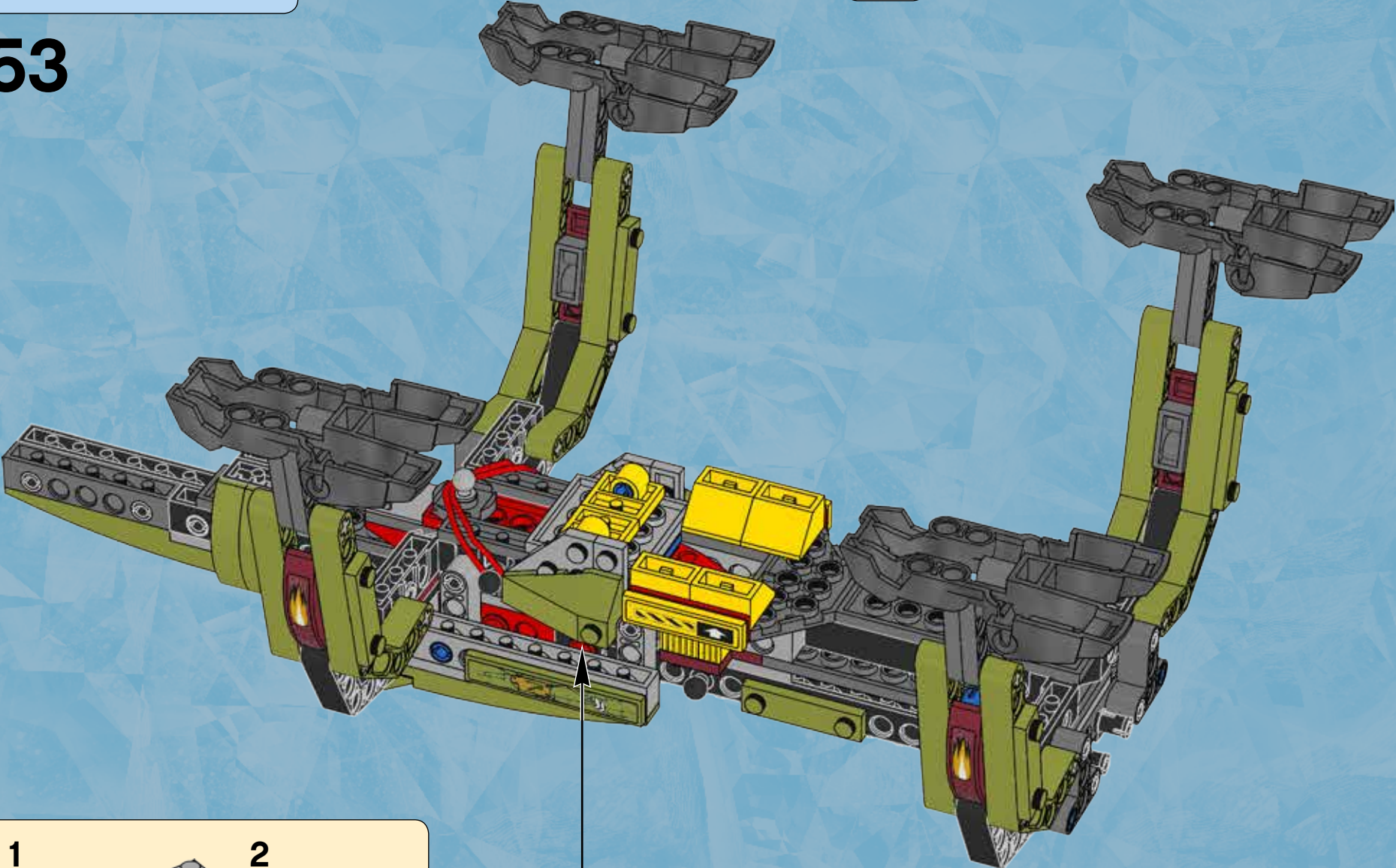



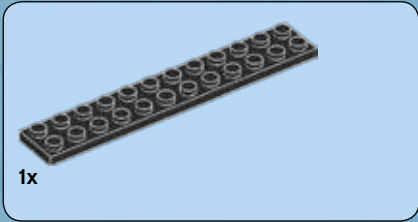
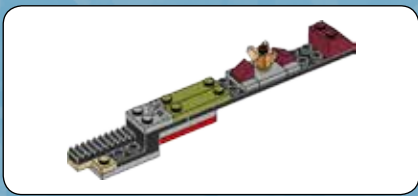

1x

**1**

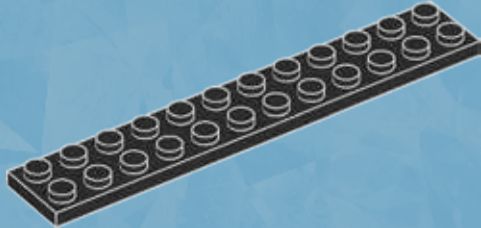

1x

2x

**2**

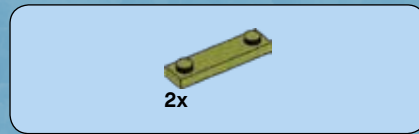
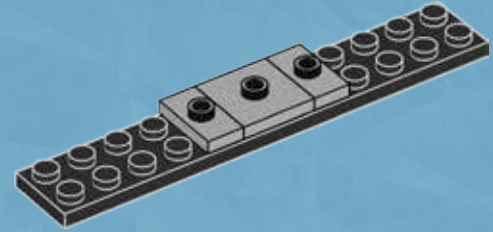

2x

**3**

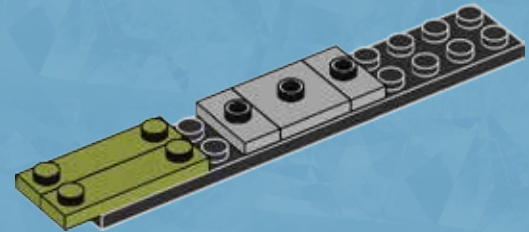

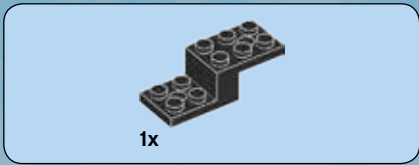

4

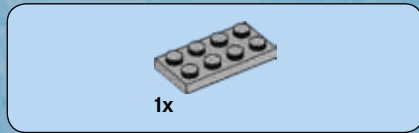
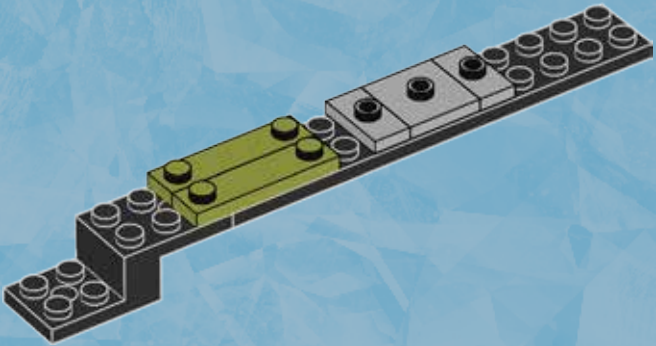

5

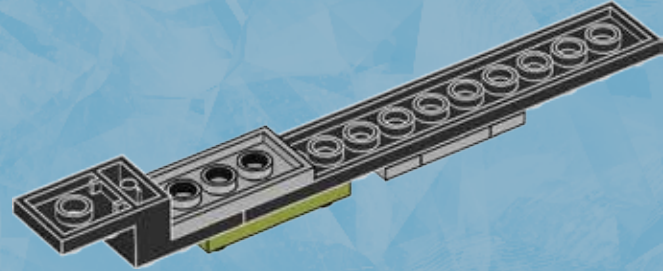

6

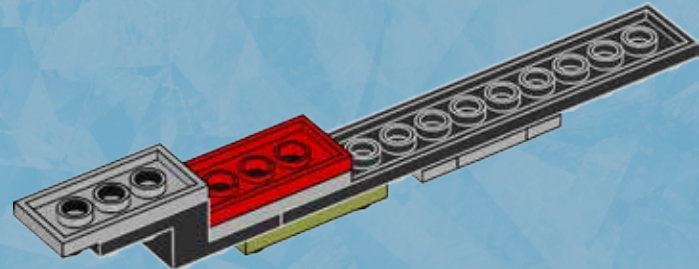



1x



1x

# 7

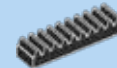
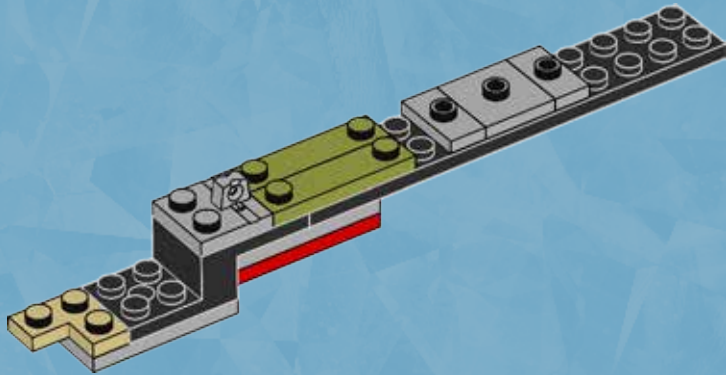

1x

# 8

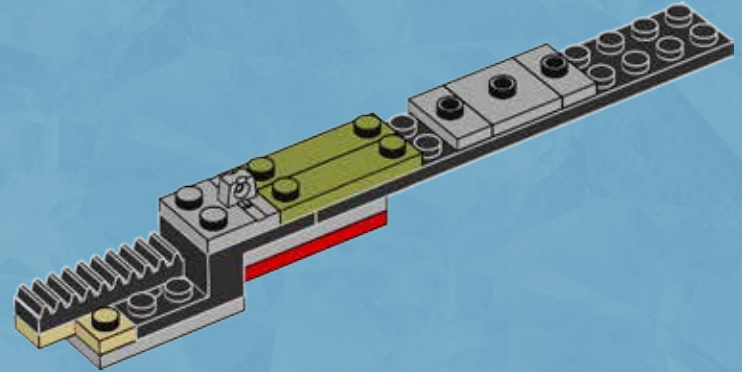

2x



1x



1x

# 9

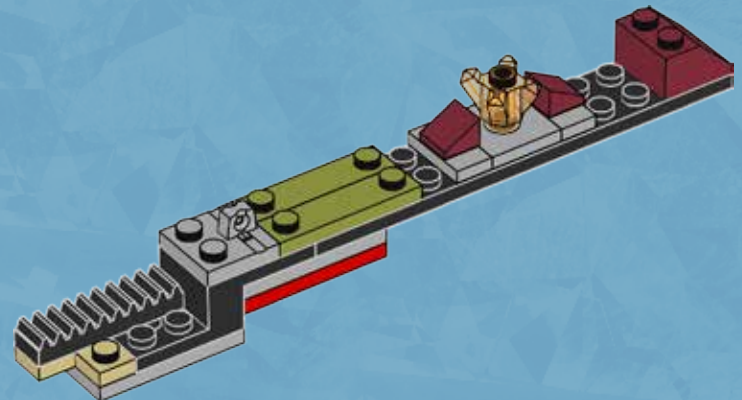

54

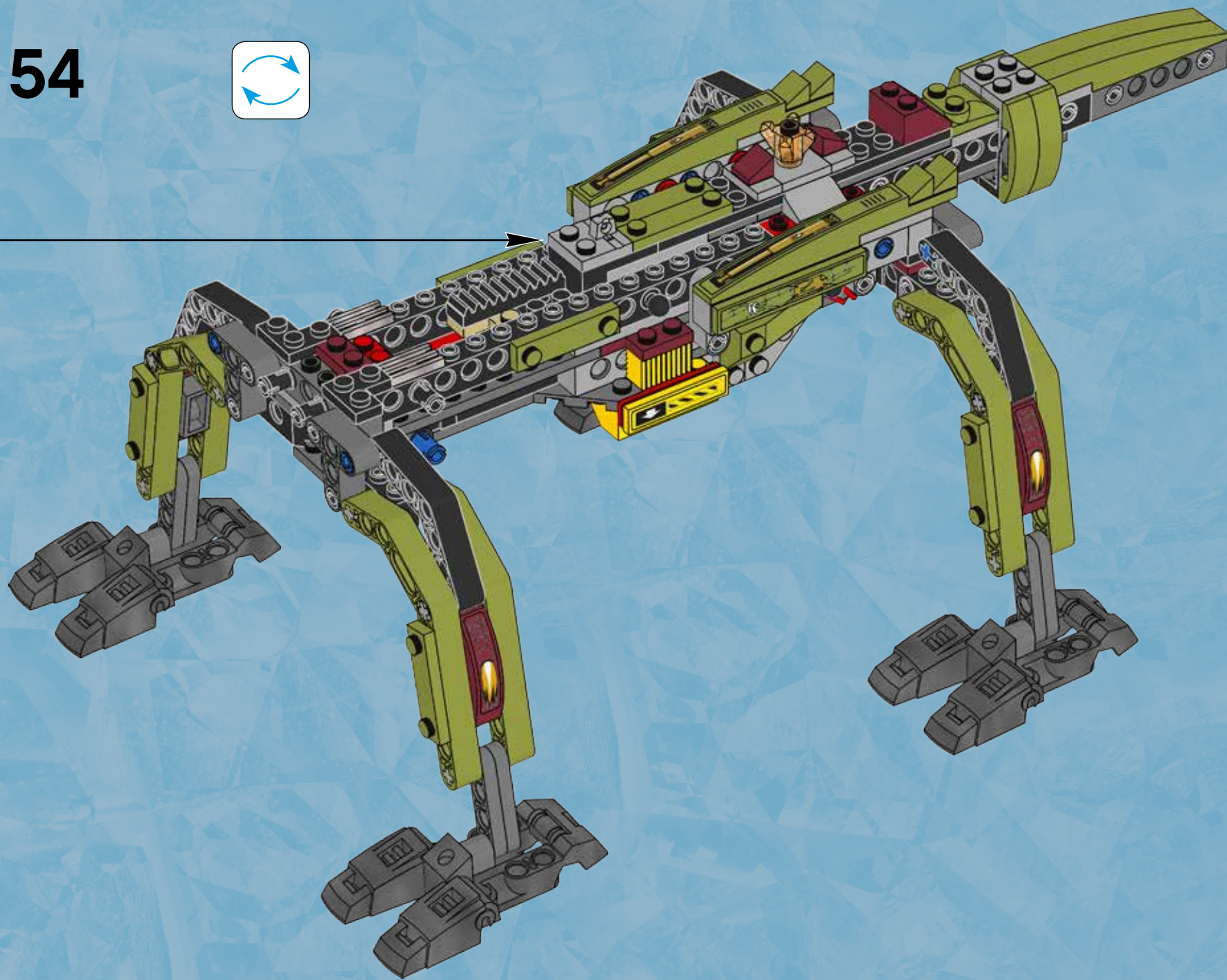



1x

55

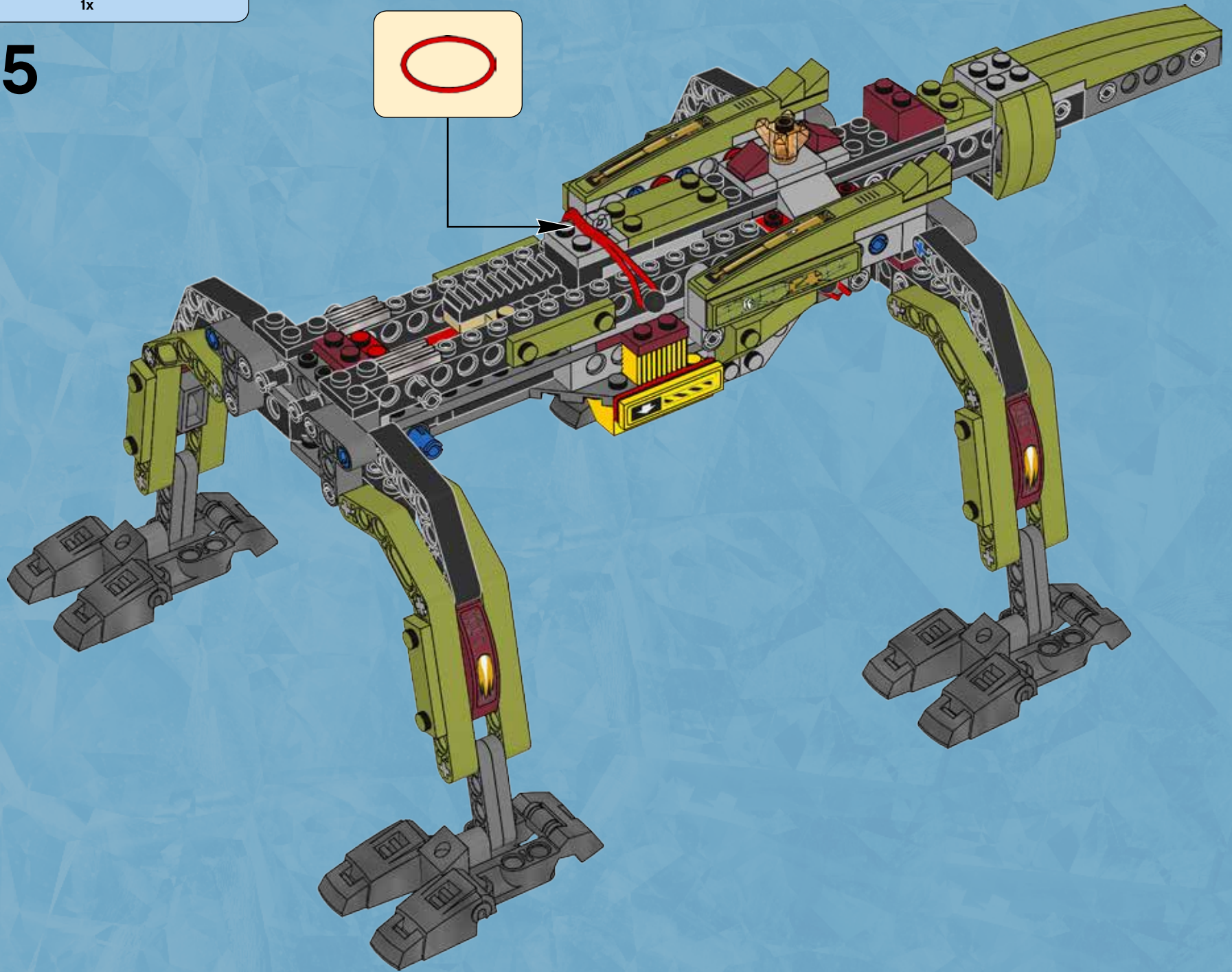
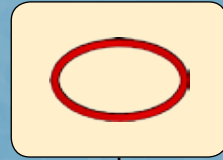

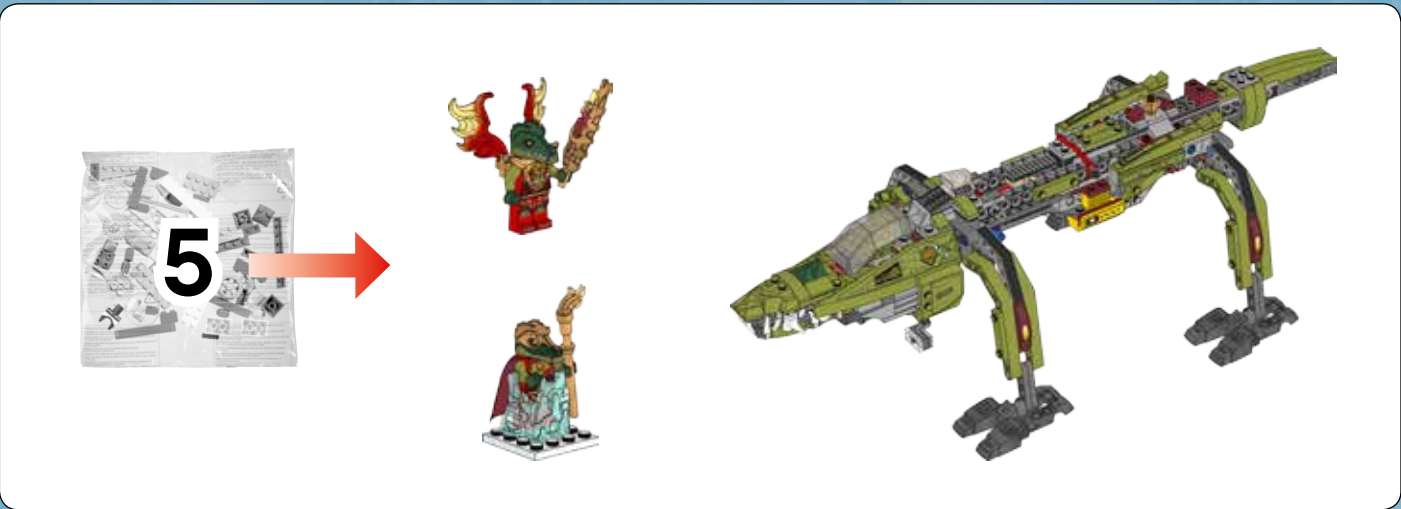

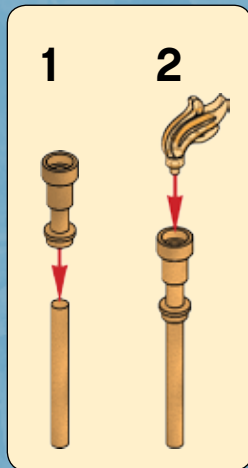
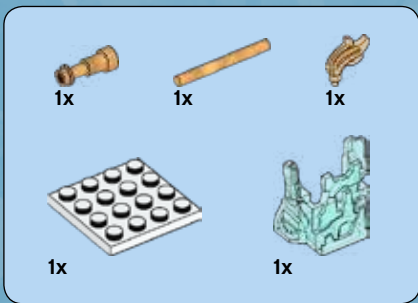

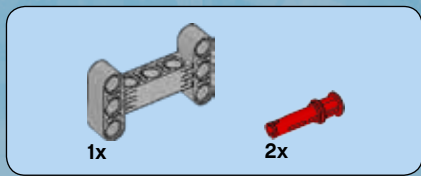

# 56

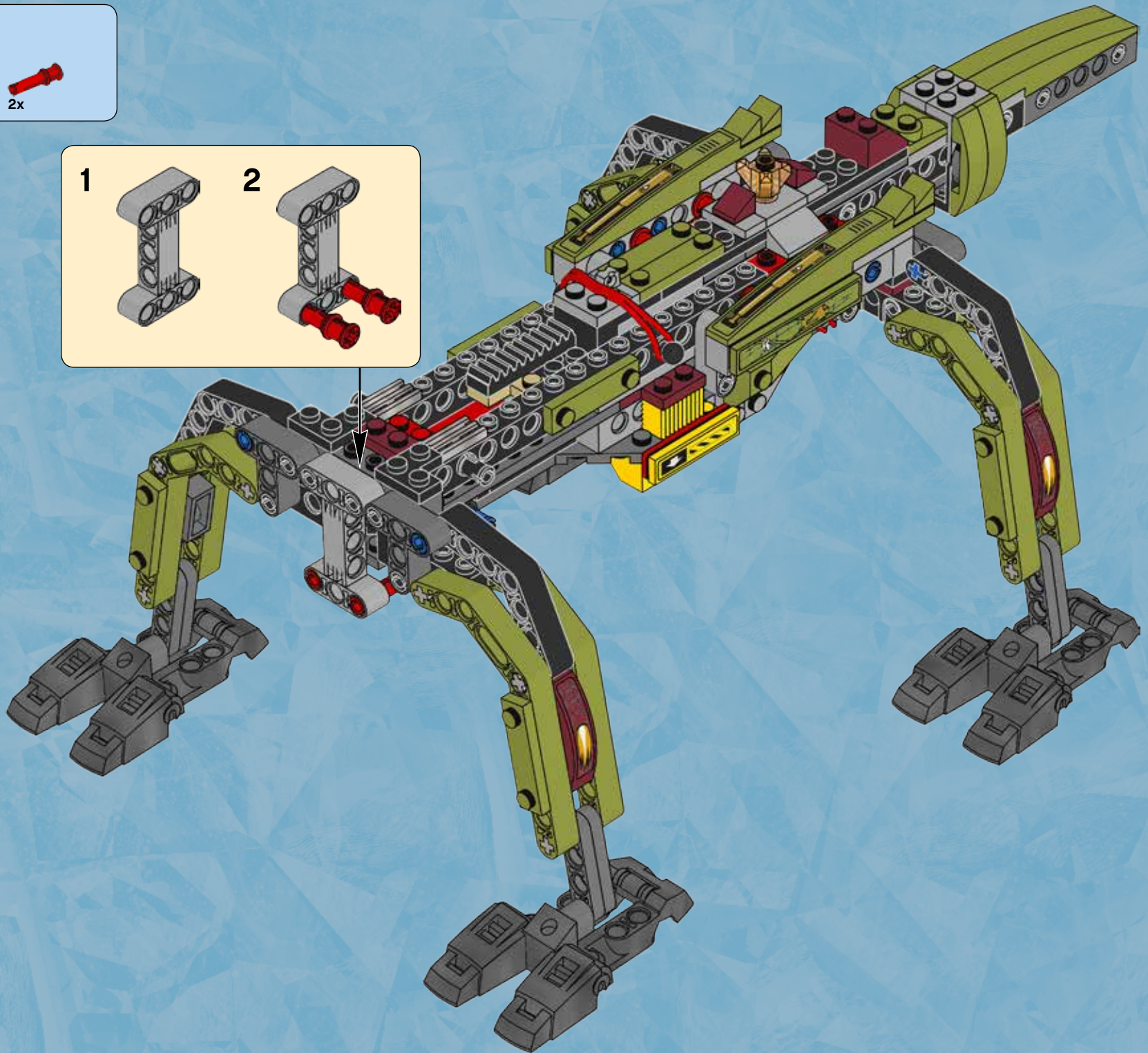
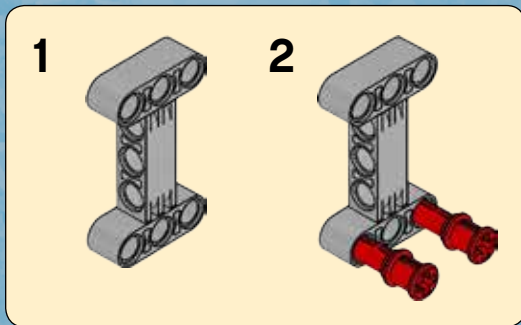



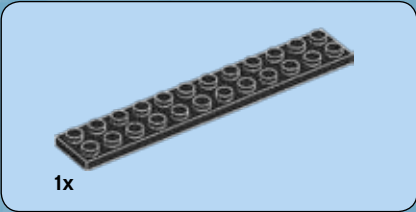
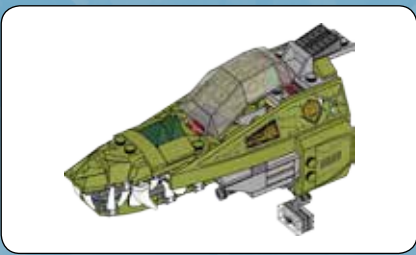

1

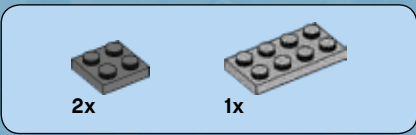
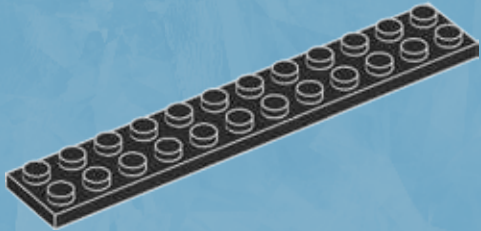

2

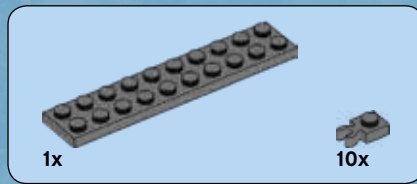
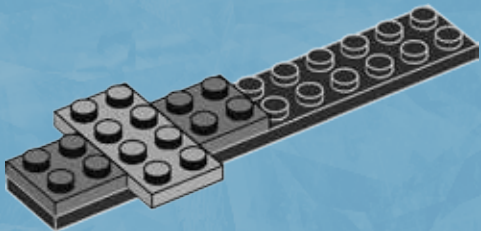

3

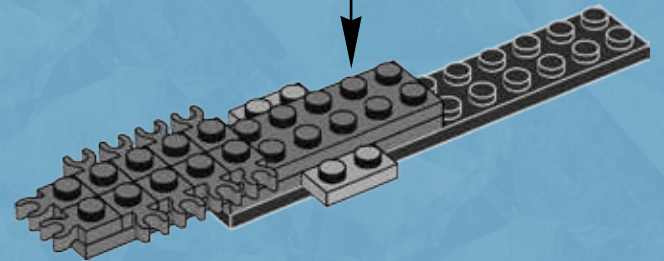
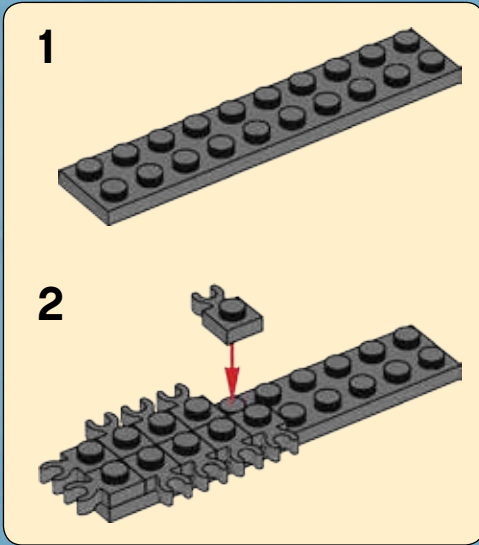



2x



2x

4

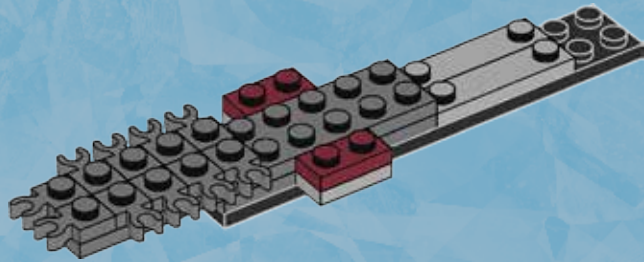

2x

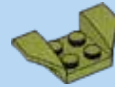

1x

5

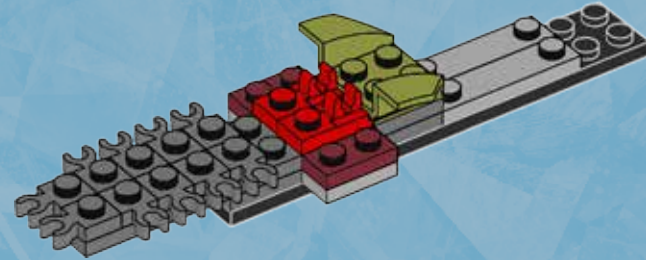

2x

6

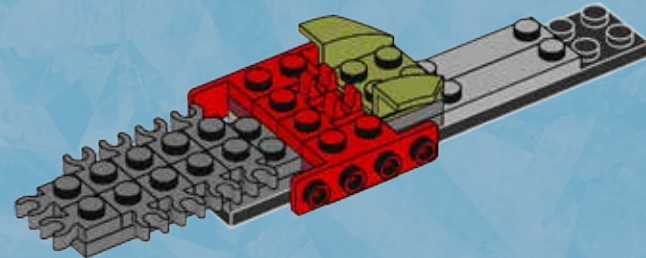



7

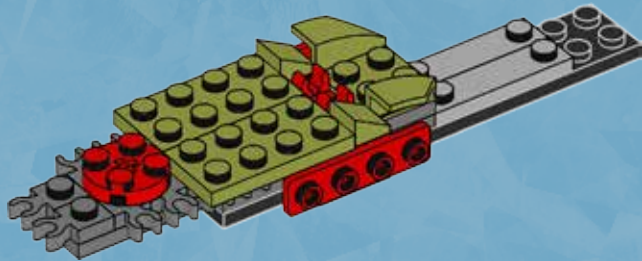

8

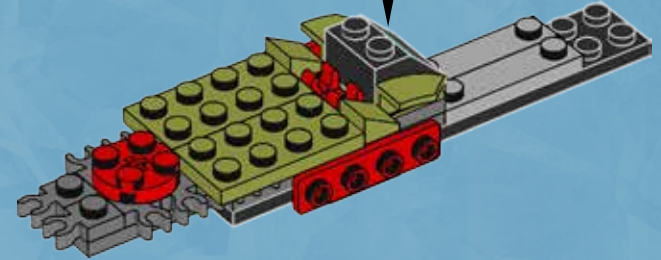

9

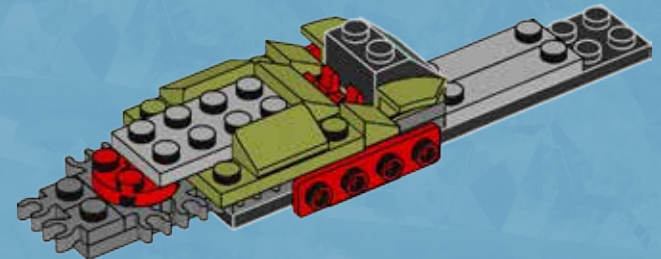



1x



2x

# 10

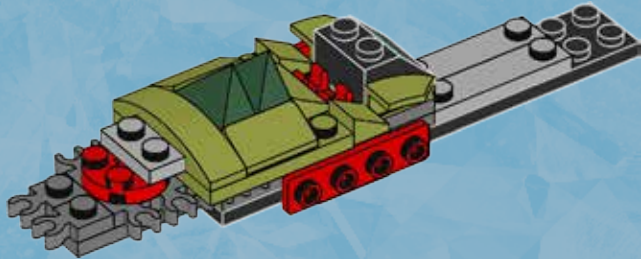

1x

# 11

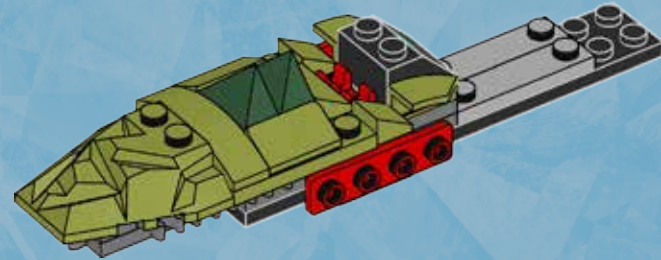

2x



8x

# 12

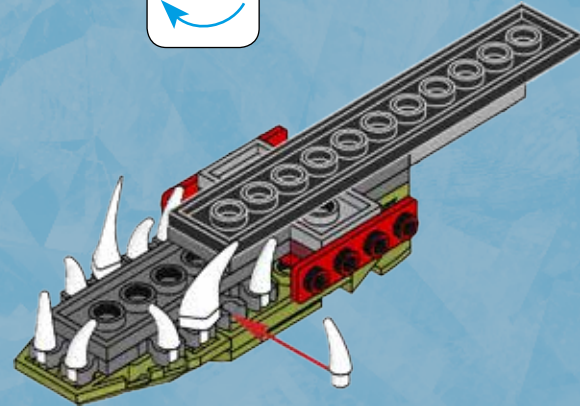
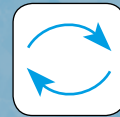

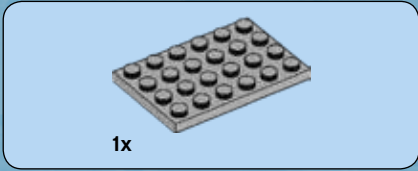
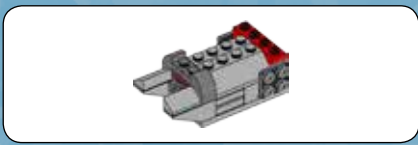

1x

1



2x

2

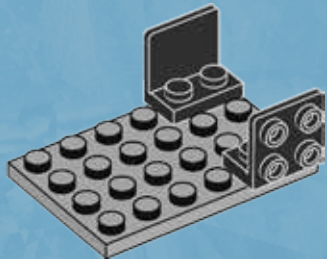

2x

3

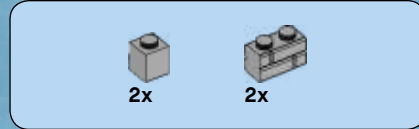

2x

2x

4

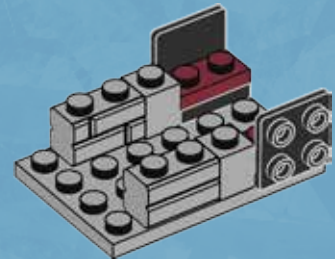



1x



1x

5

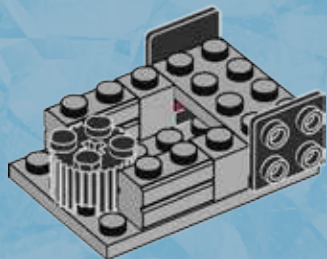

2x

6

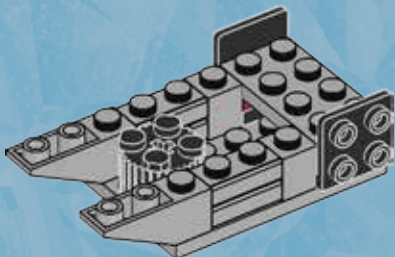

1x



1x

7

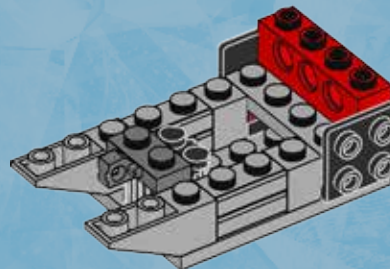

2x



1x

8

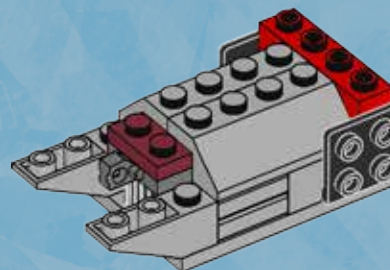



9

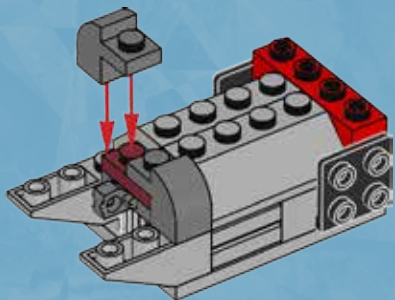

10

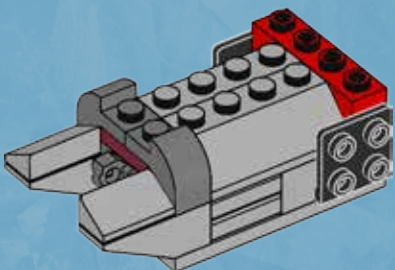

13

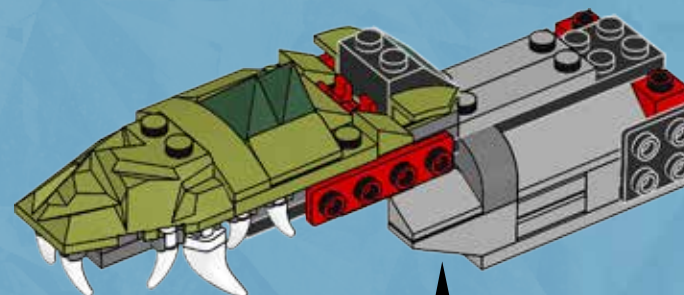
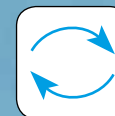



1x

# 14

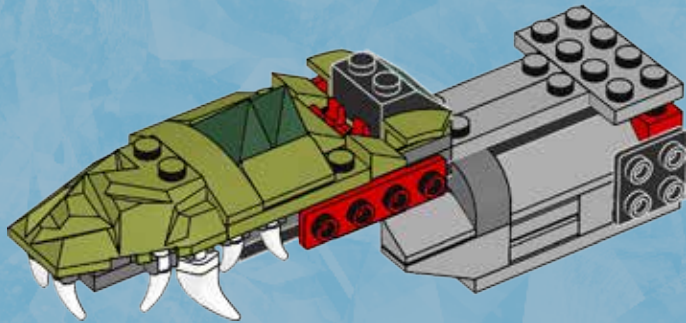

2x



1x

# 15

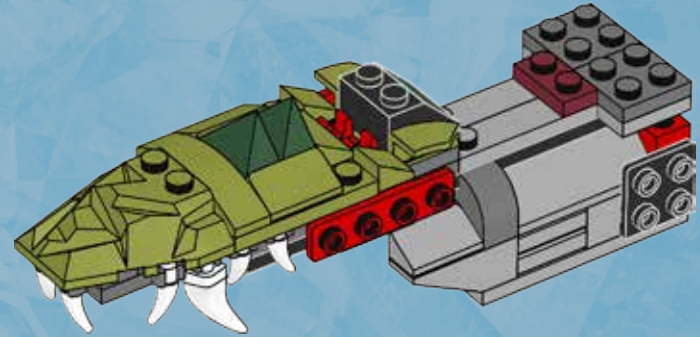

1x



2x

# 16

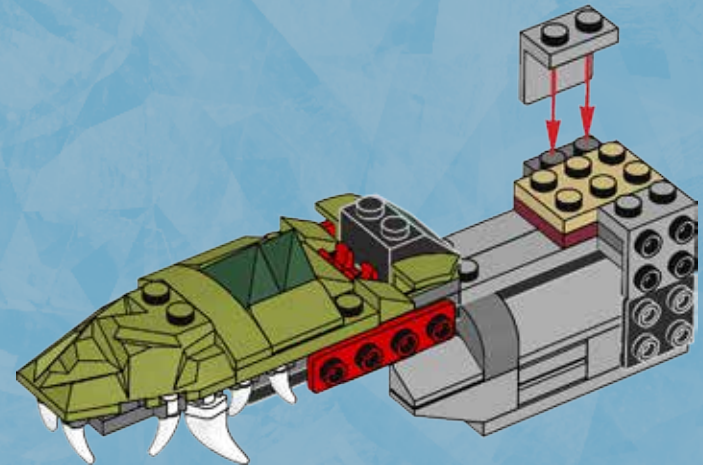



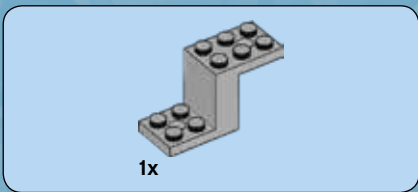

17

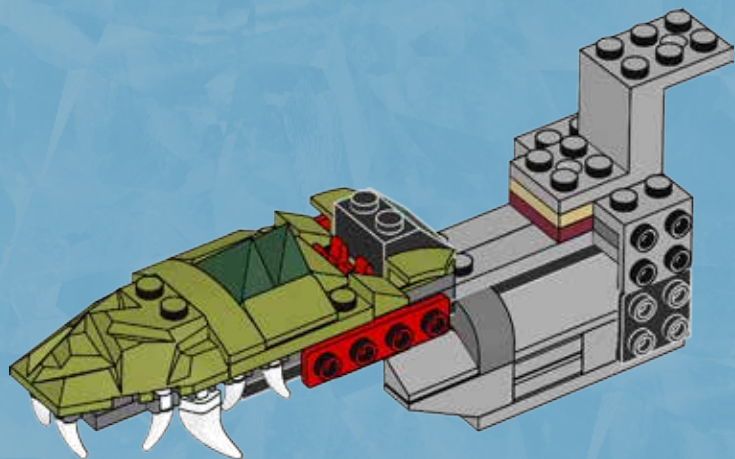

18

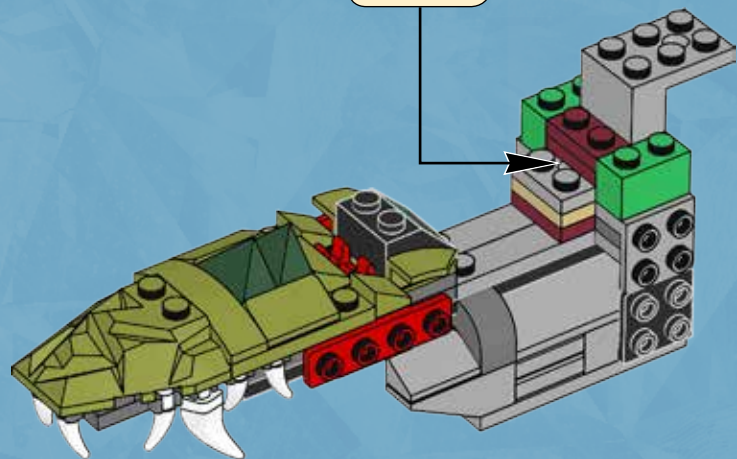
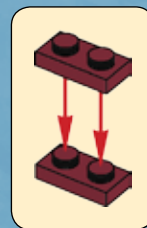



2x

# 19

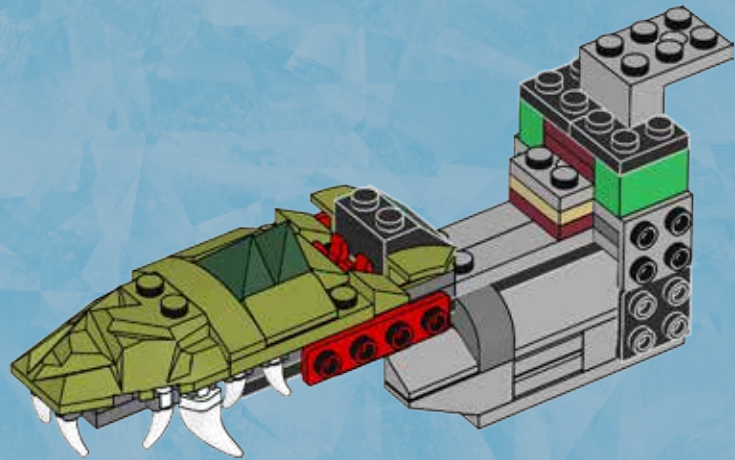

2x

# 20

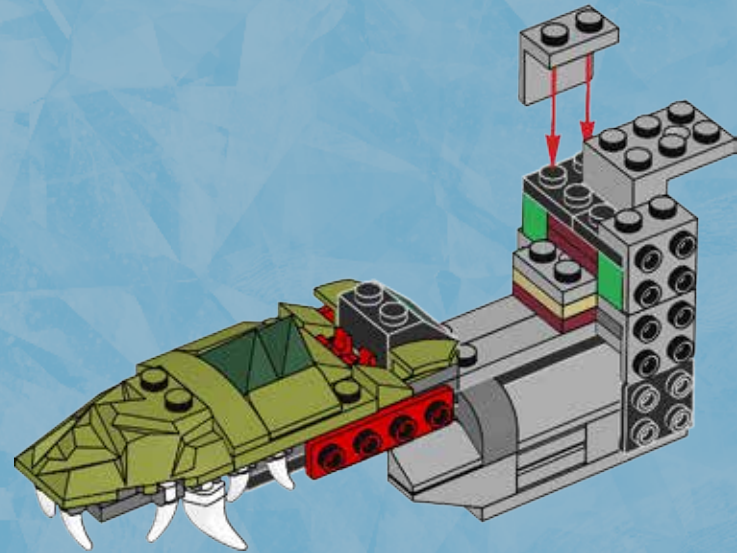



2x

# 21

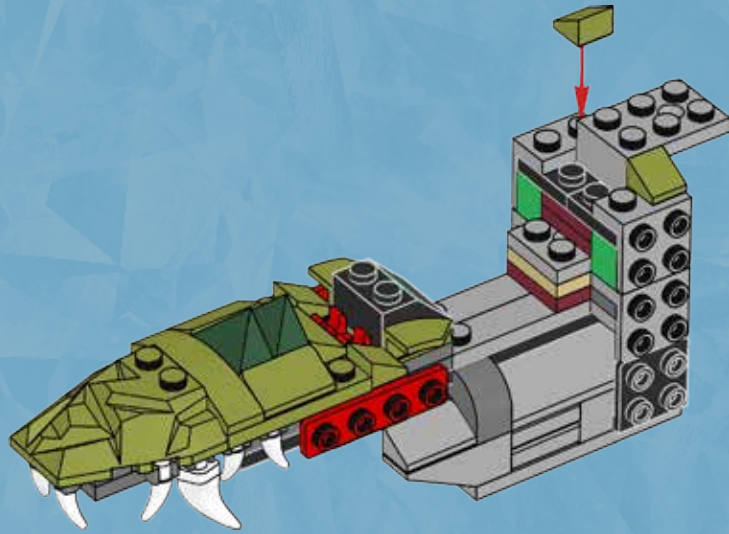

1x



2x

# 22

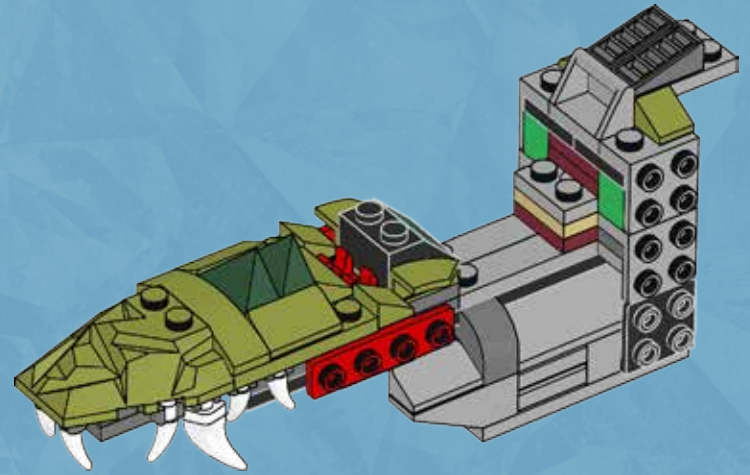



1x



1x

# 23

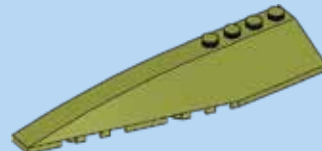
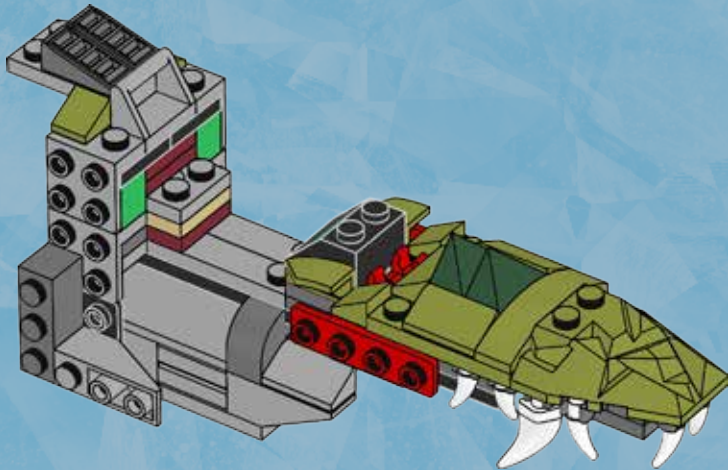

1x

# 24

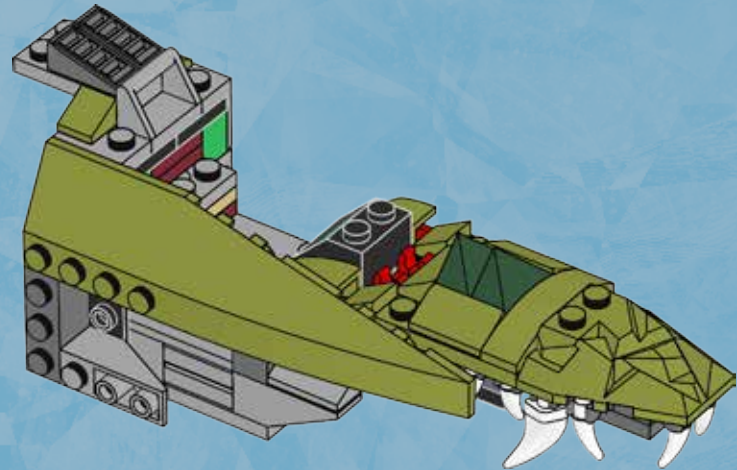



1x

# 25

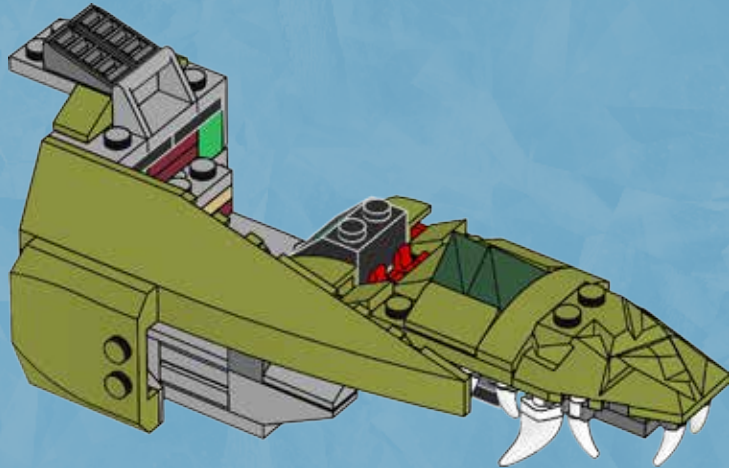

# 26

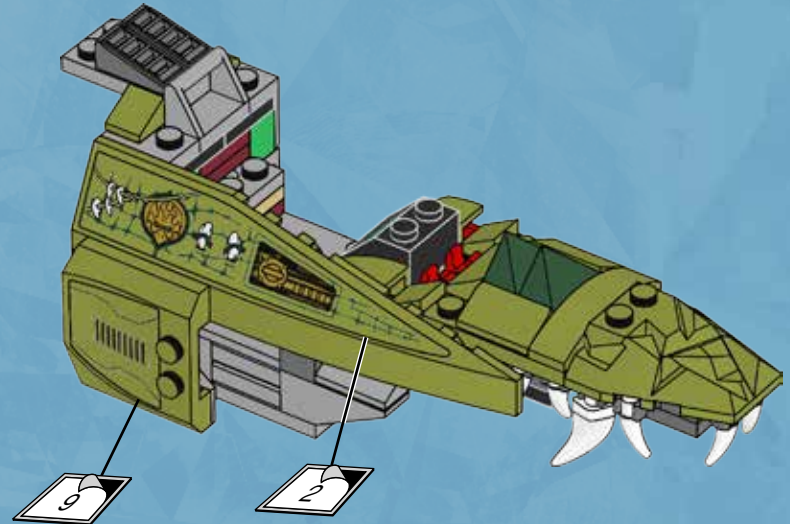



1x



1x

# 27

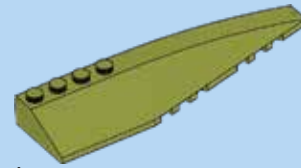
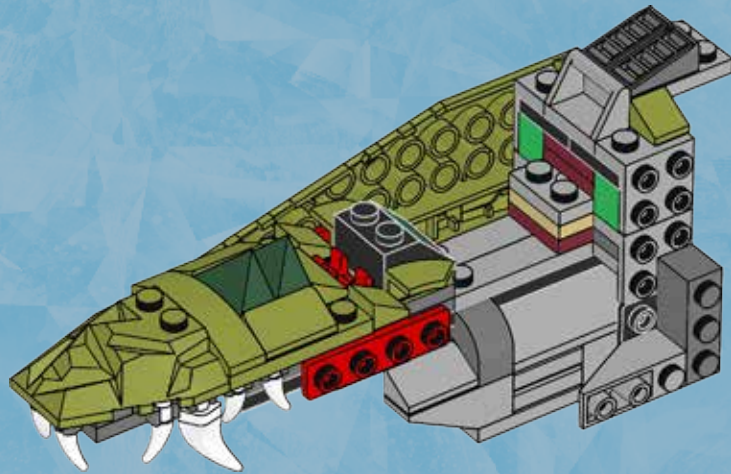

1x

# 28

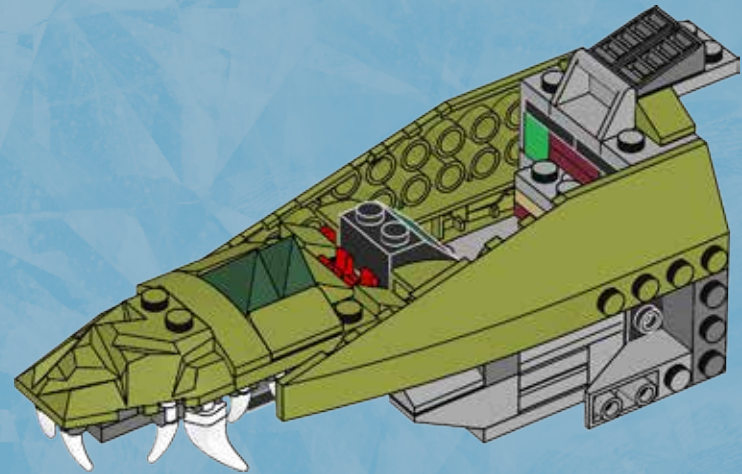



29

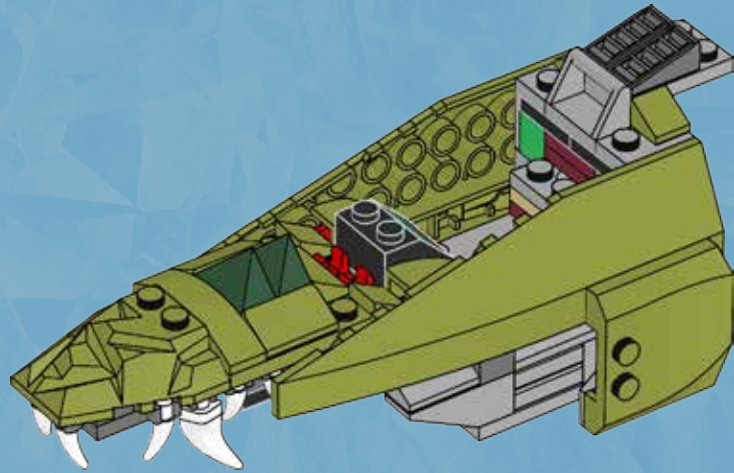

30

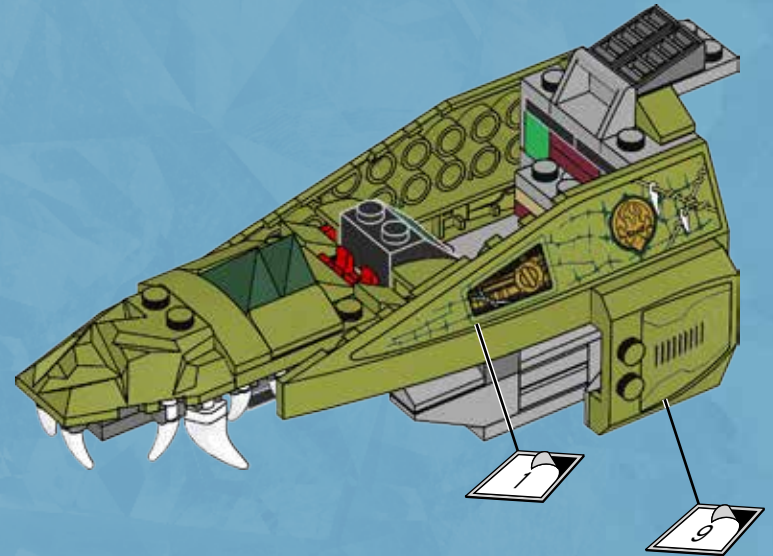

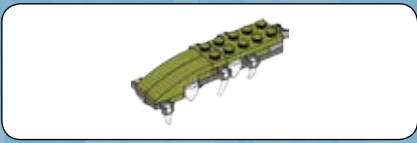

1

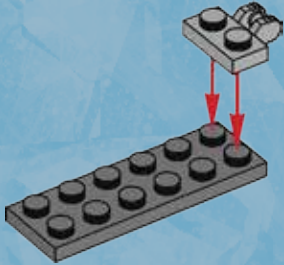

2

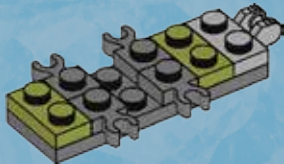

3

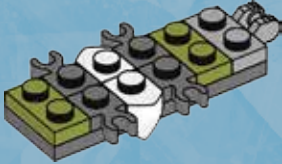

4

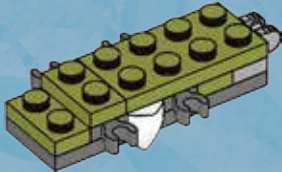



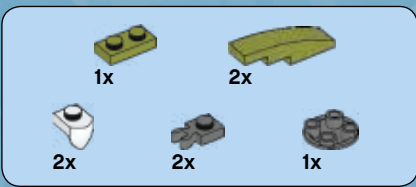

# 5

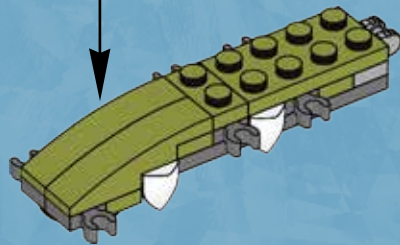
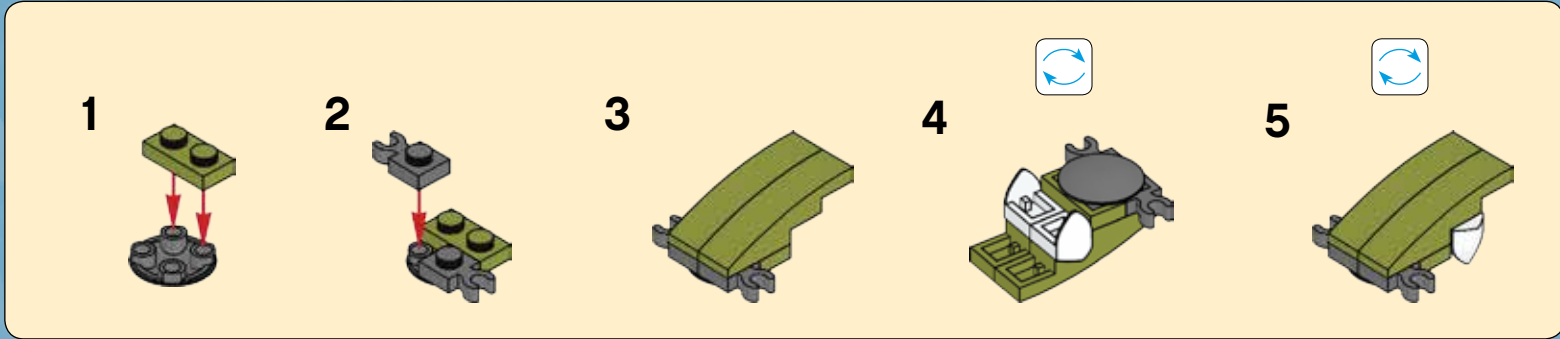



1x

6

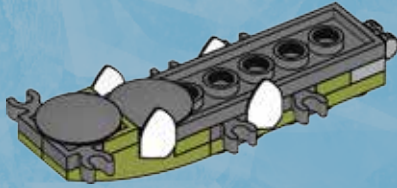

6x

7

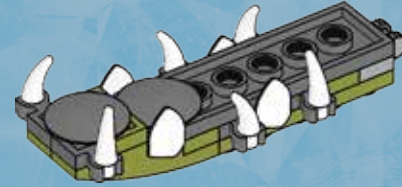

8

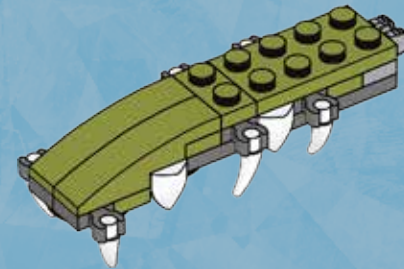

# 31

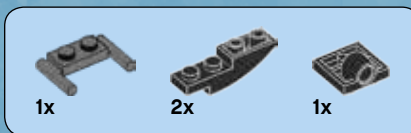
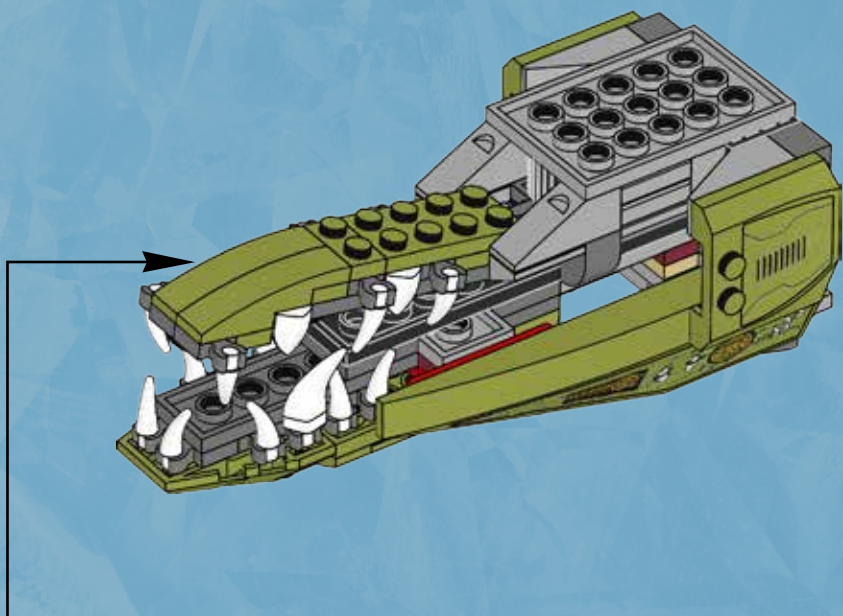

# 32

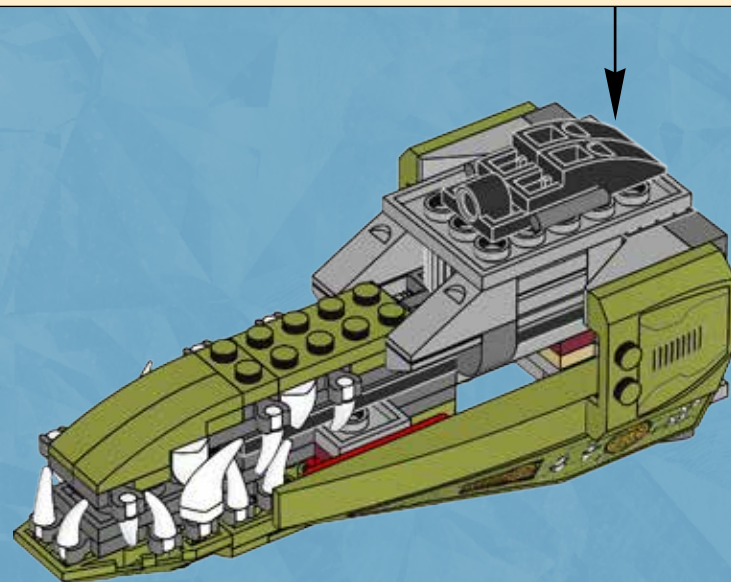



4x

# 33

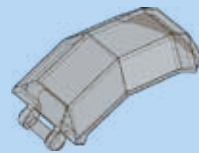
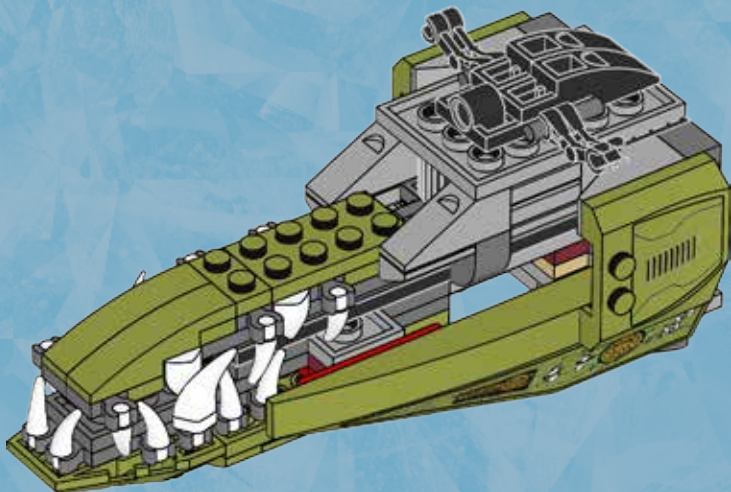

1x

# 34

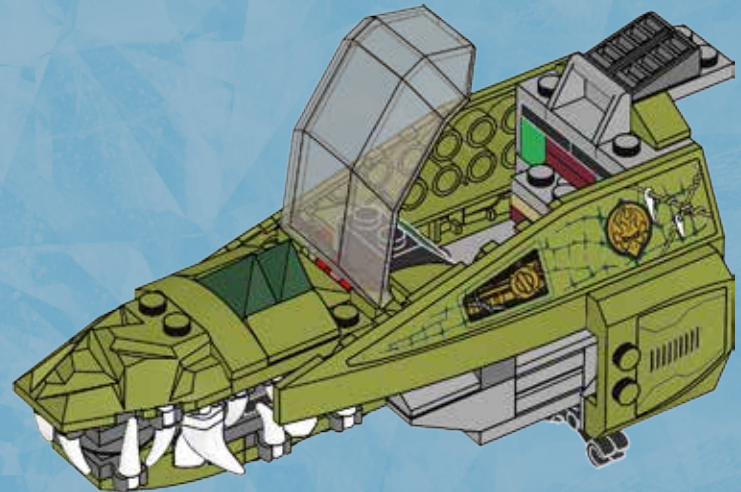

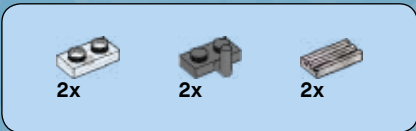

35

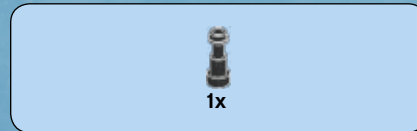
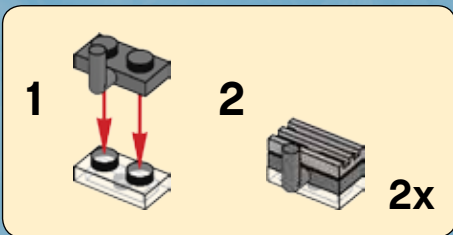
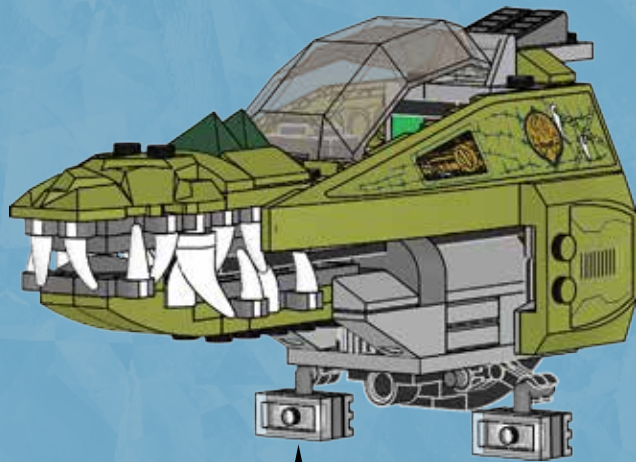

36

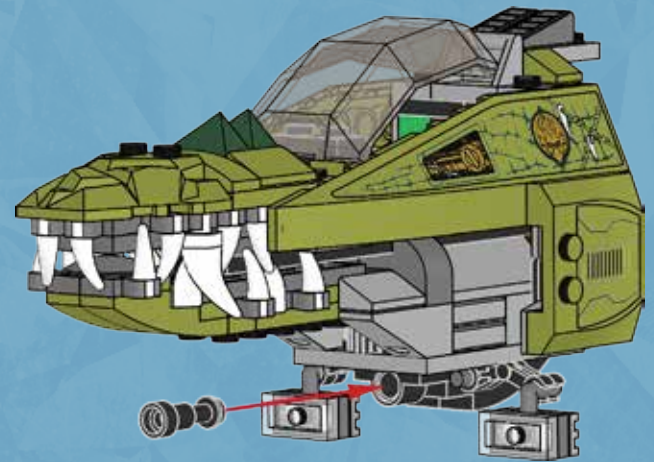

37

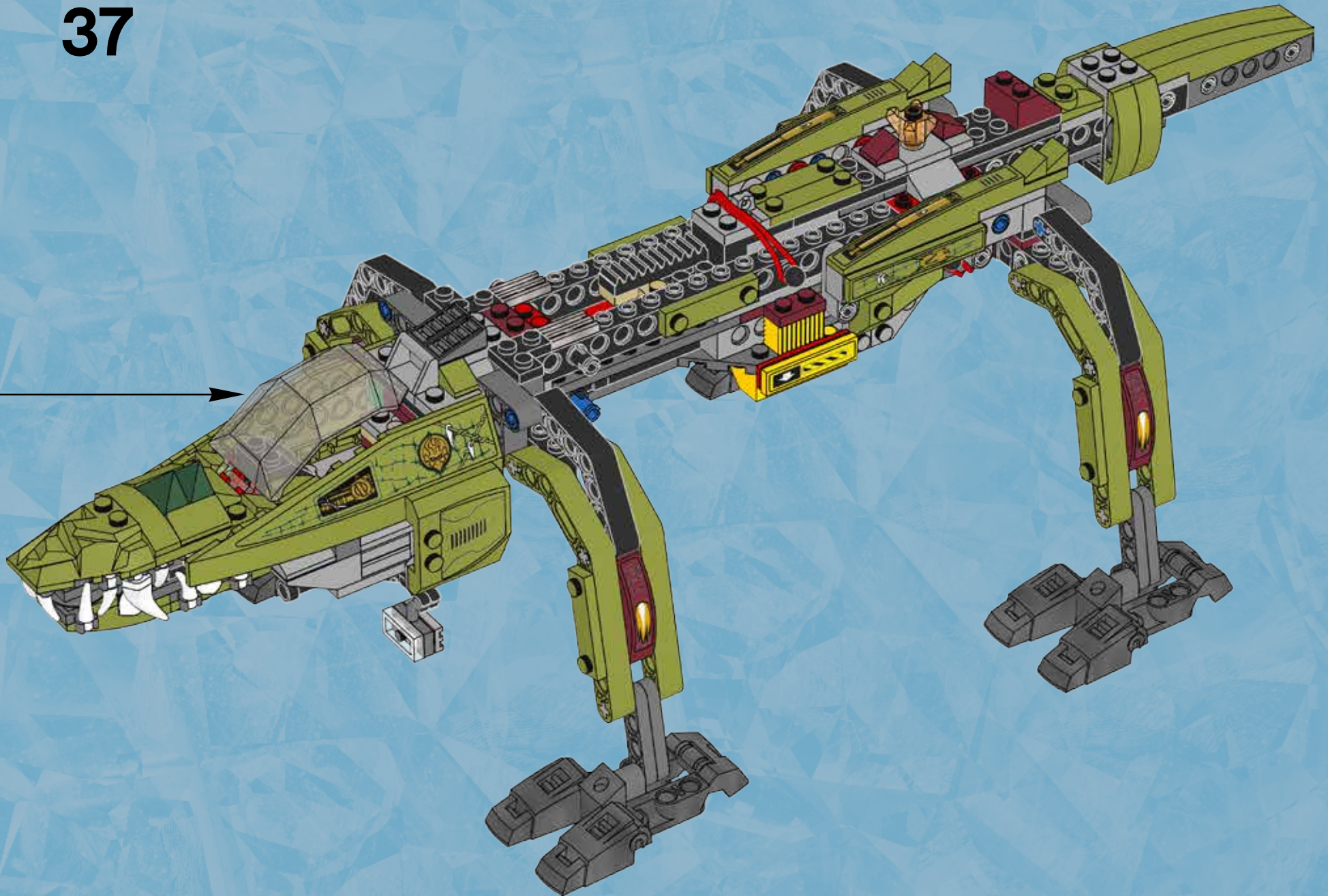

38

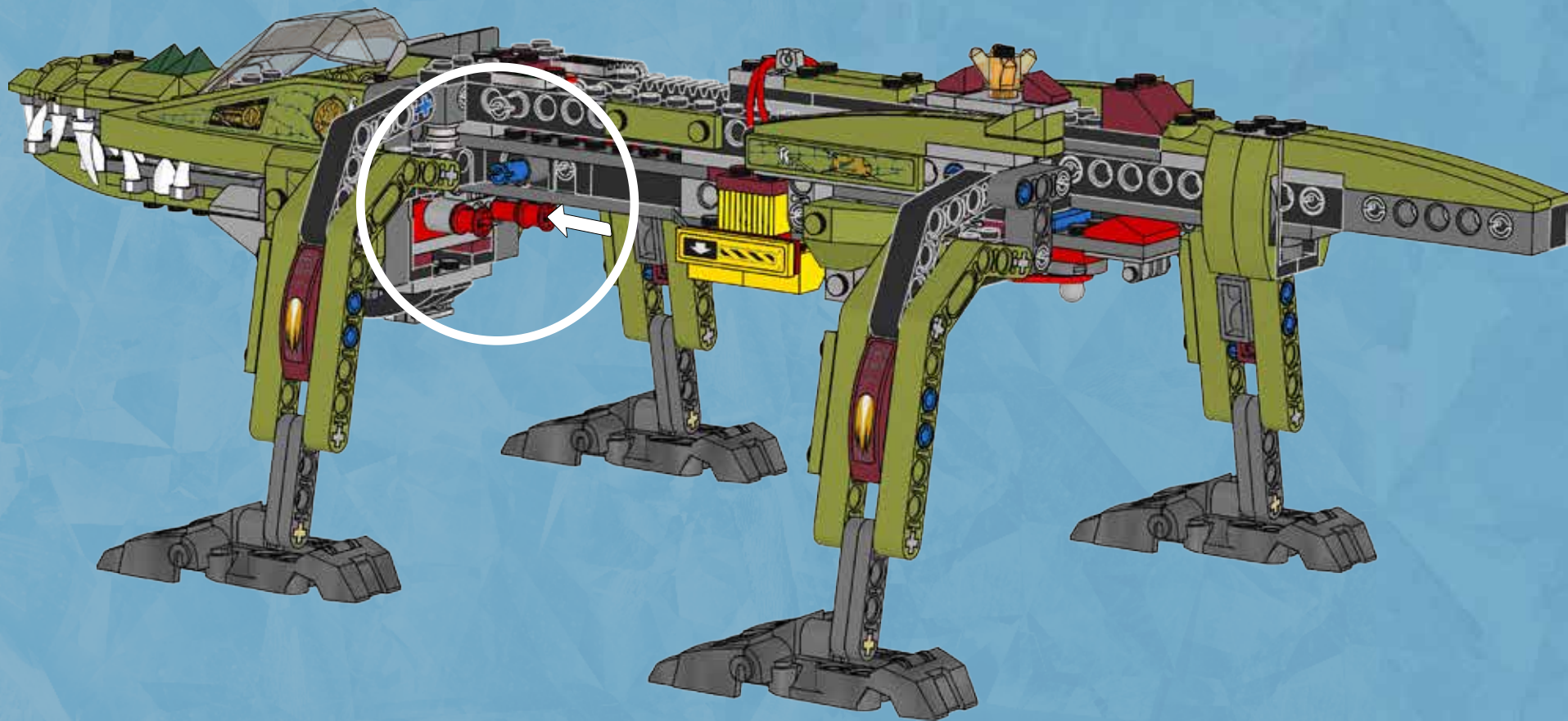



1x

39

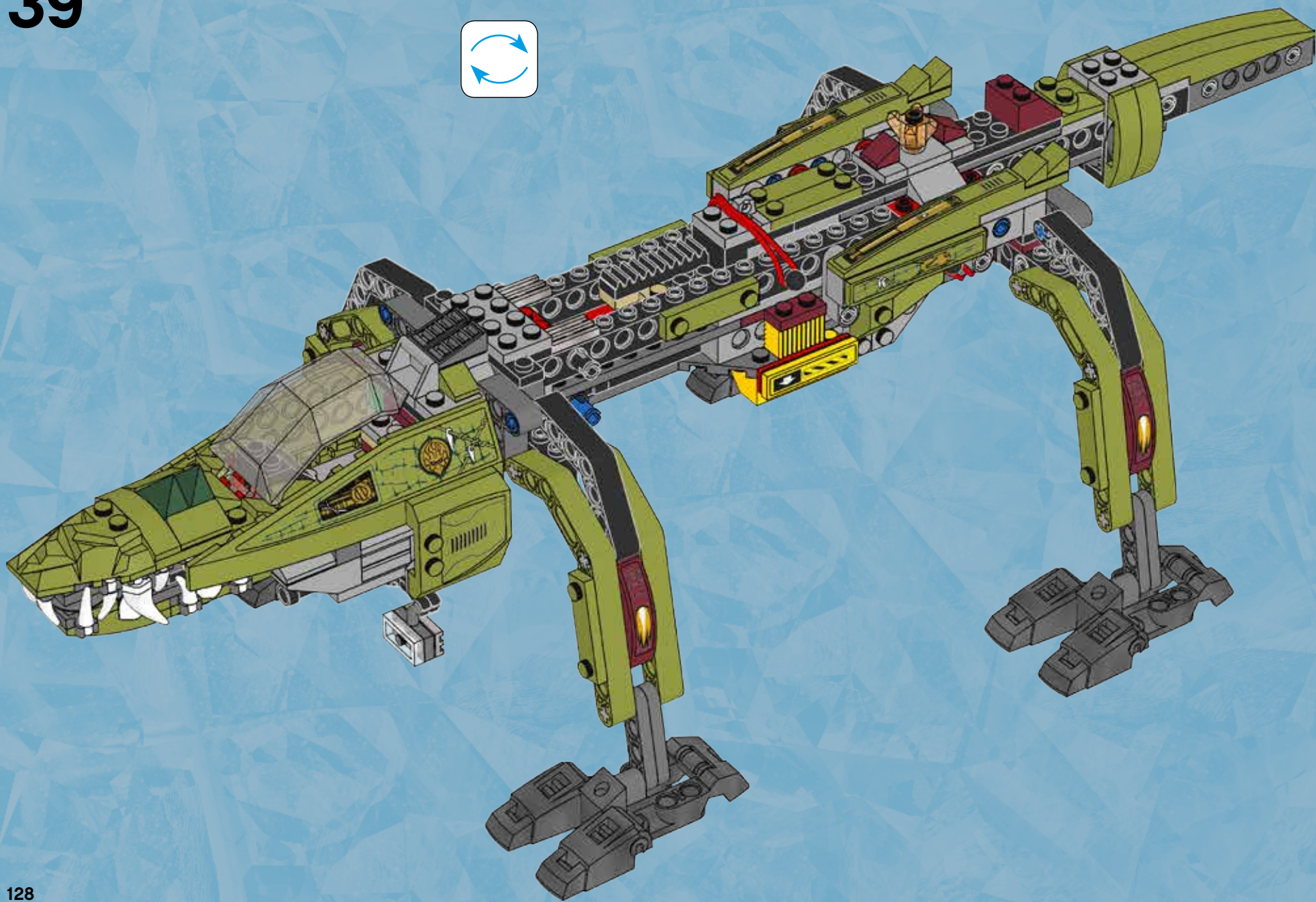





2x

40

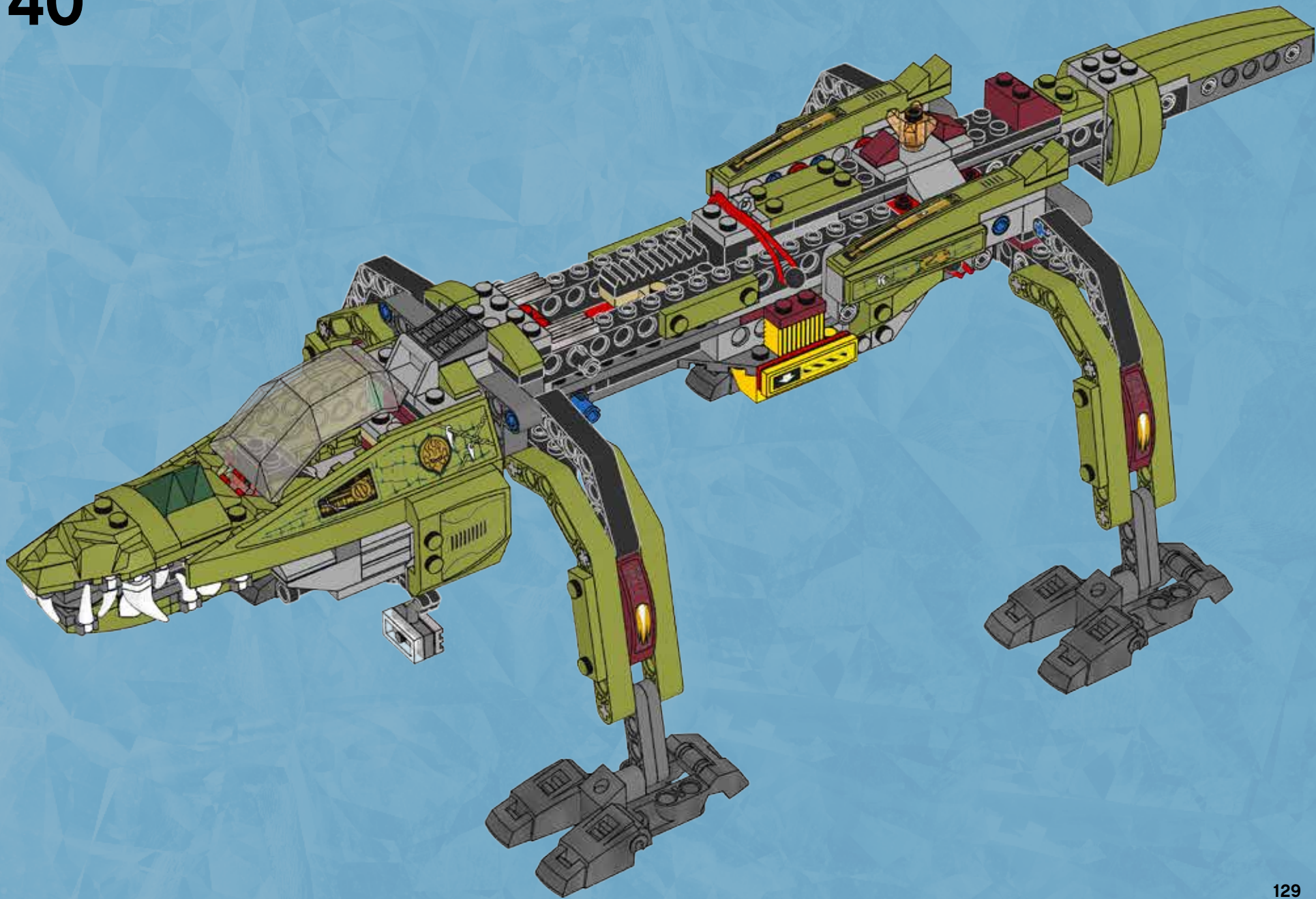



1x

41

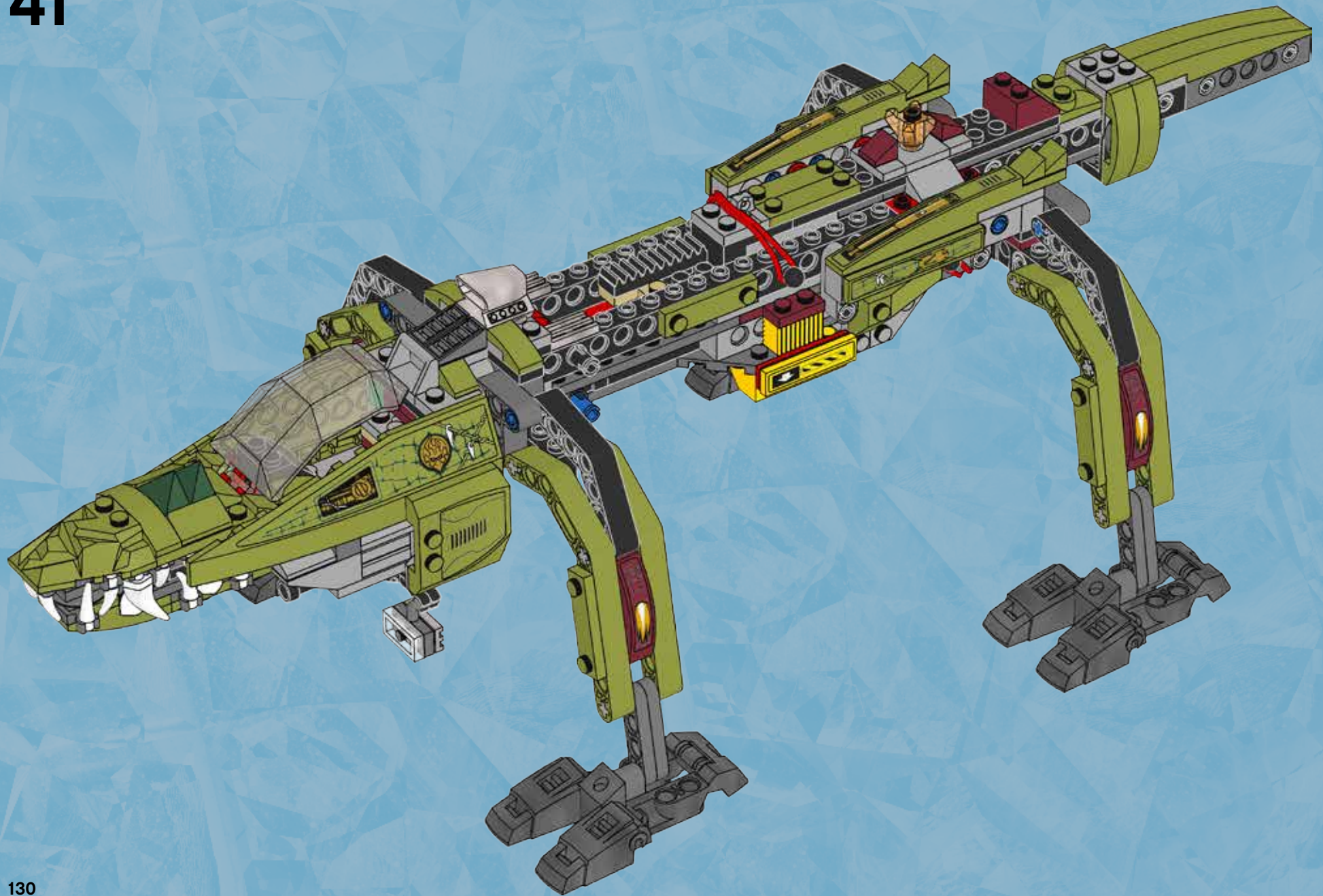

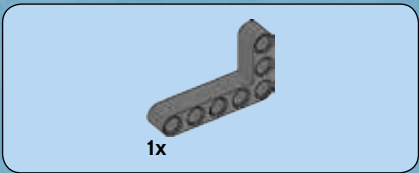
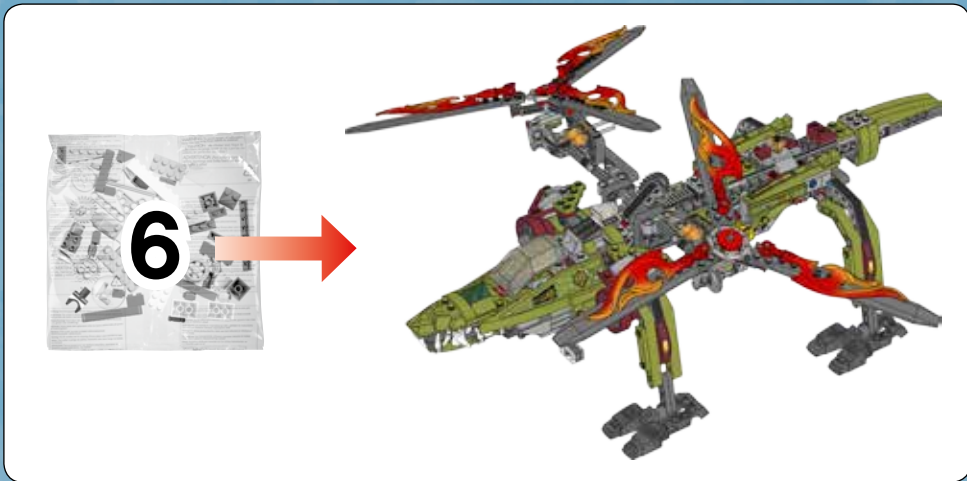

42

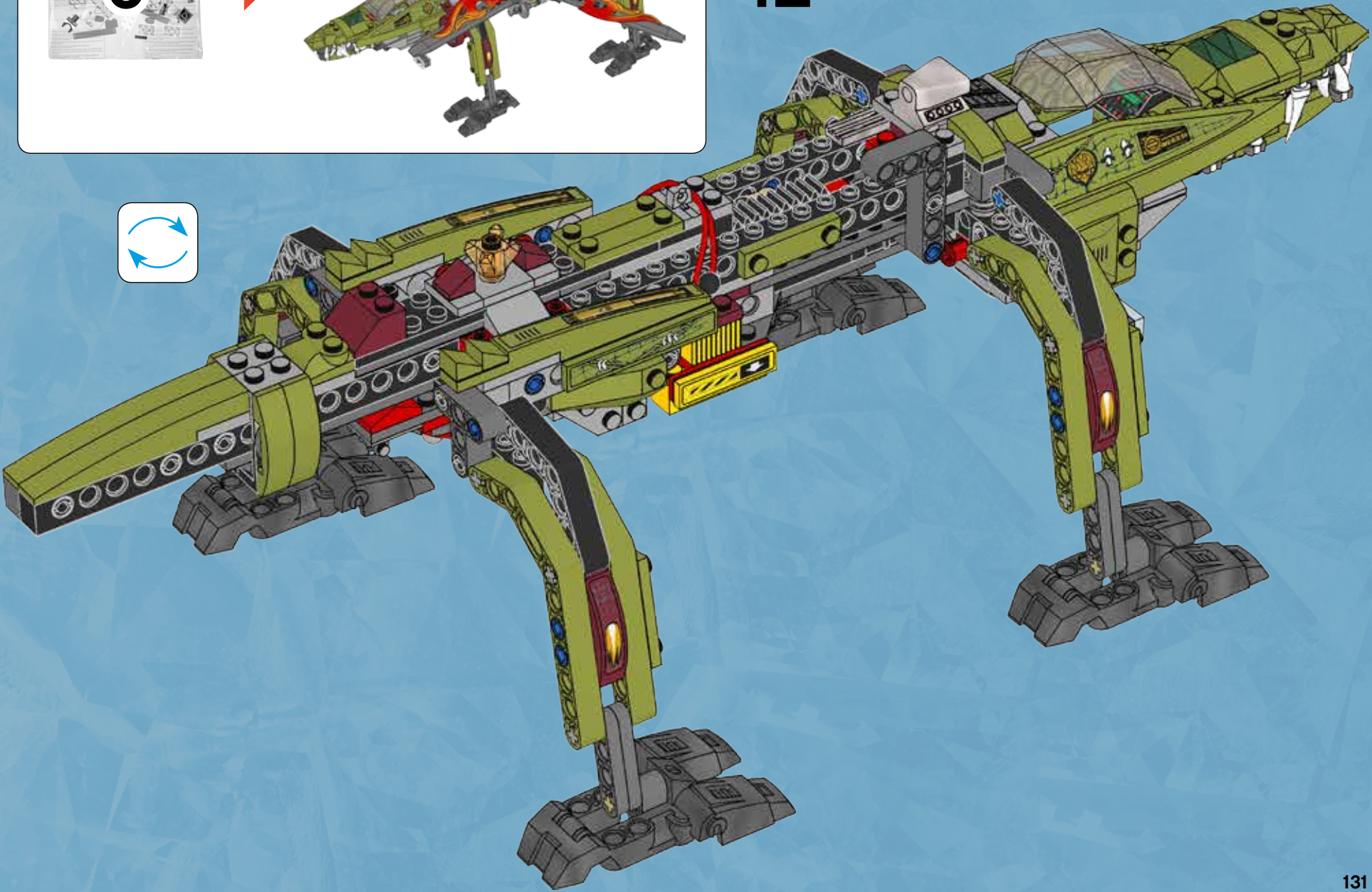



1x

# 43

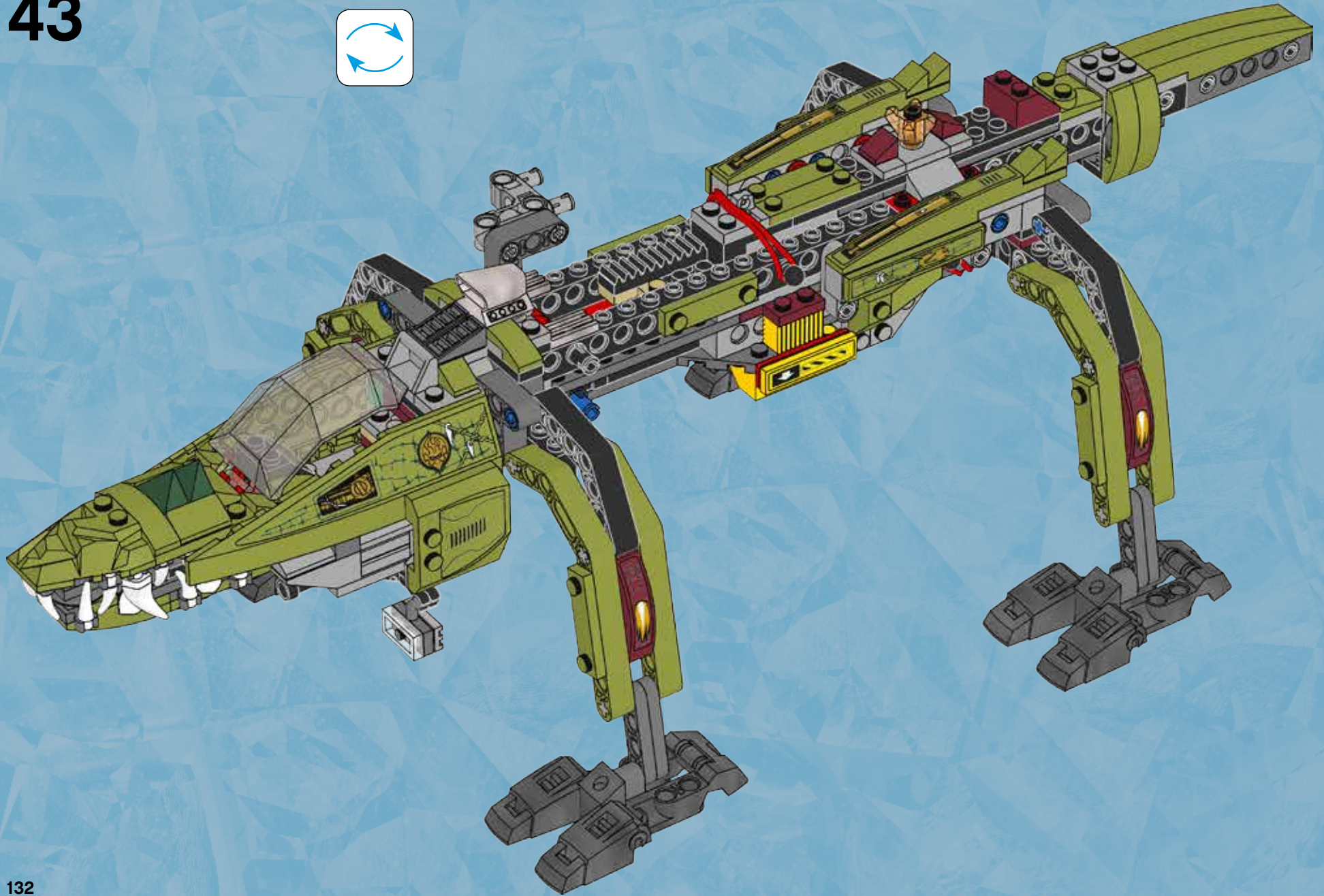

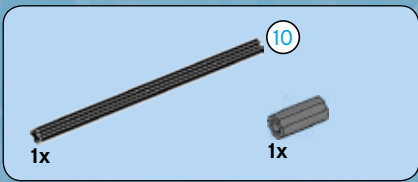

44

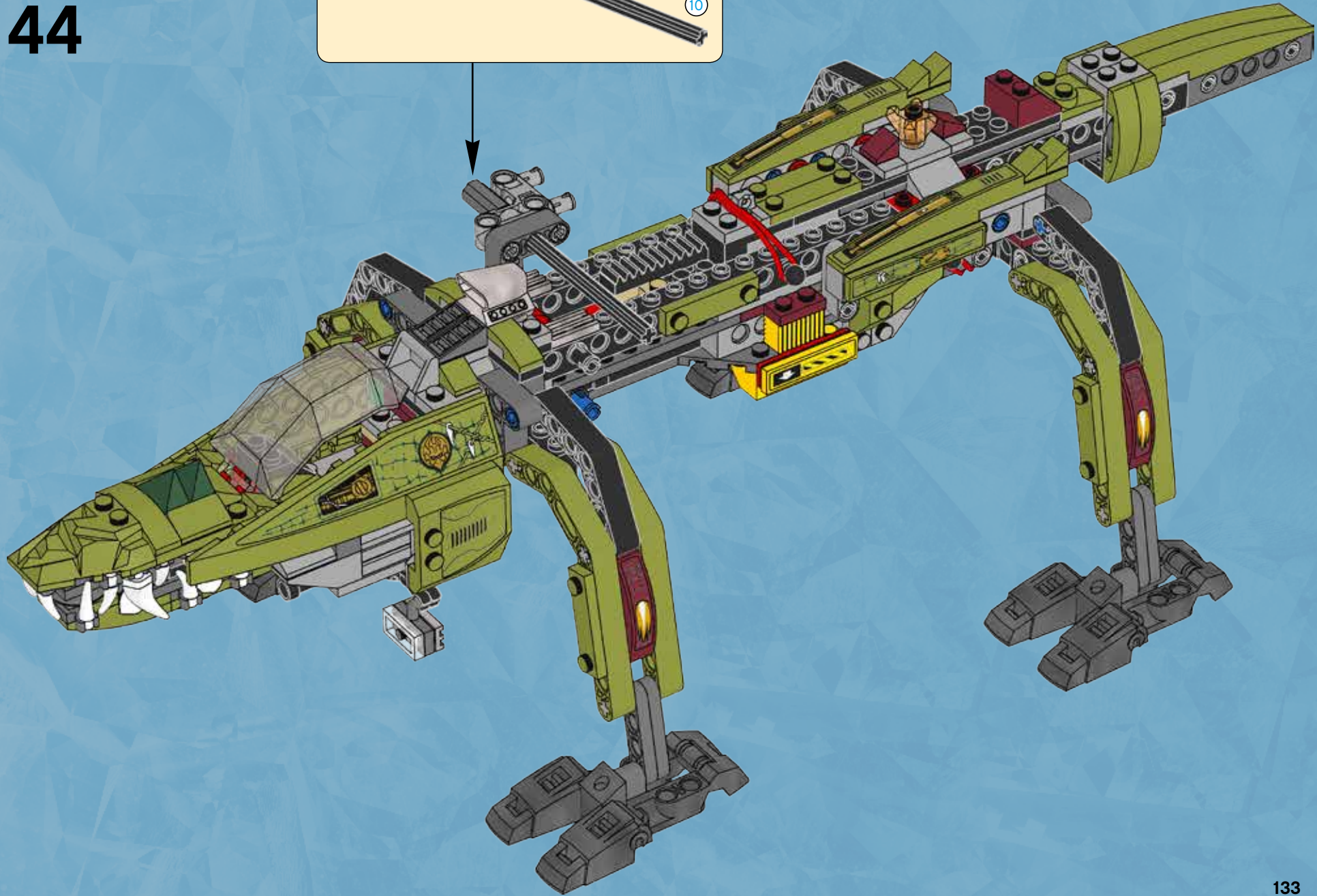
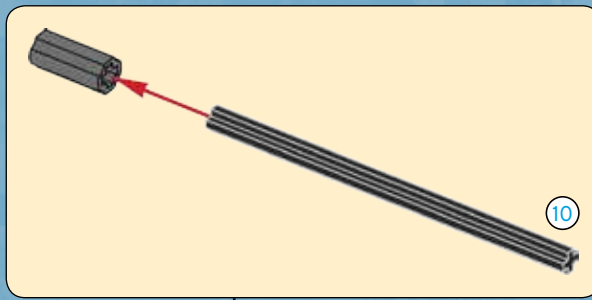



1x



1x

# 45

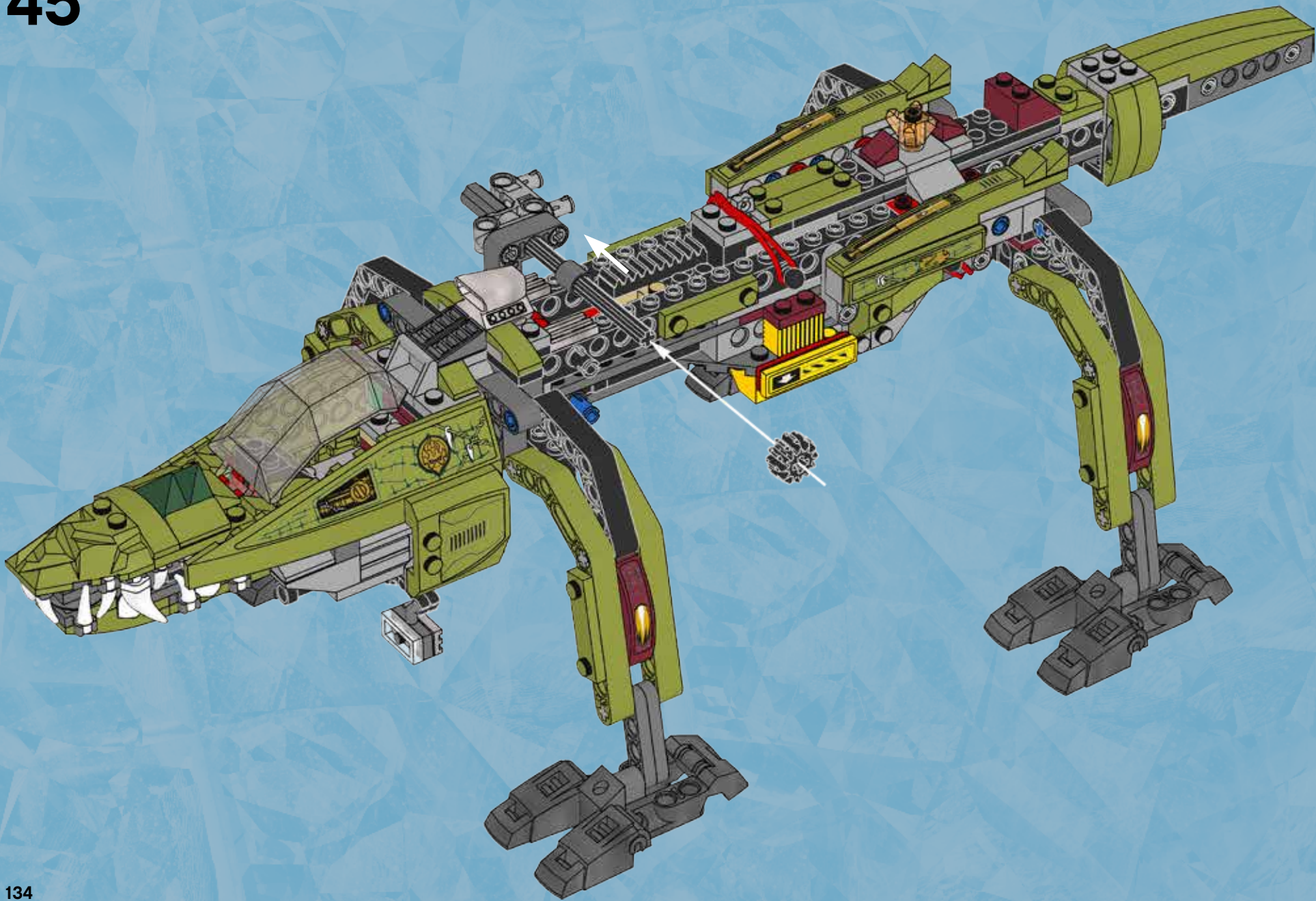

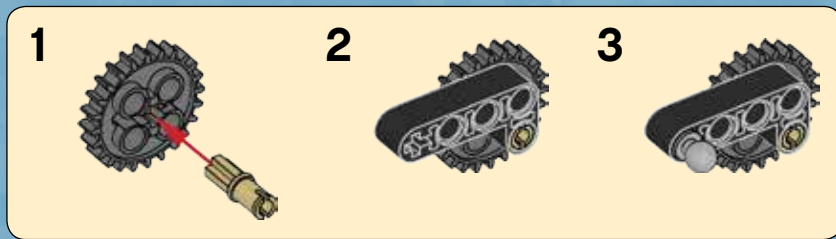
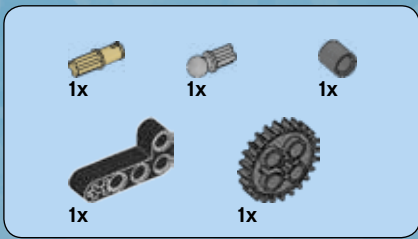

46

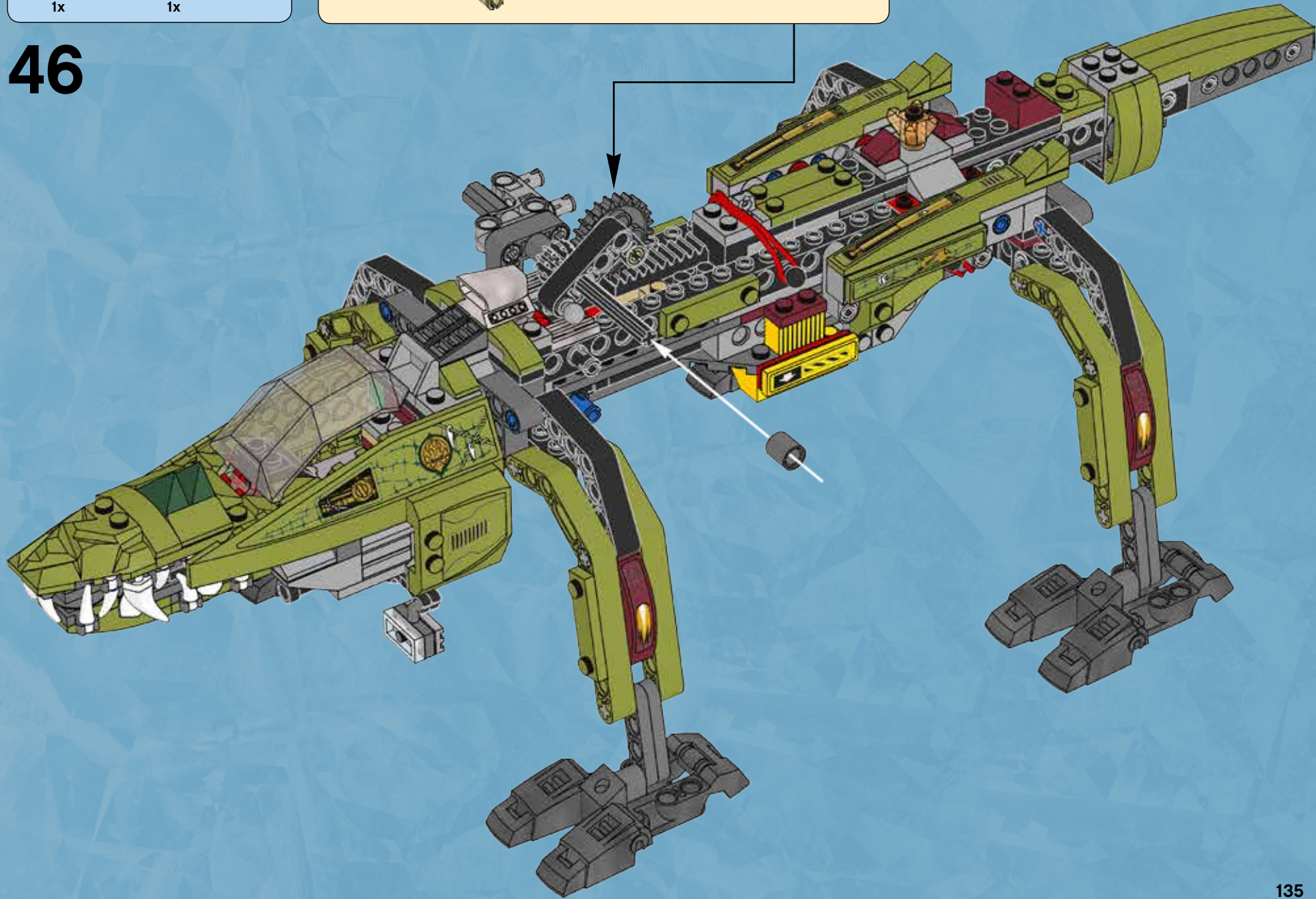

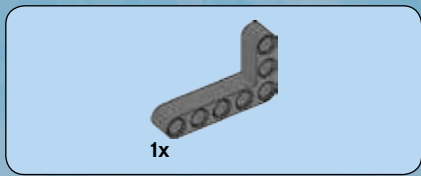

47

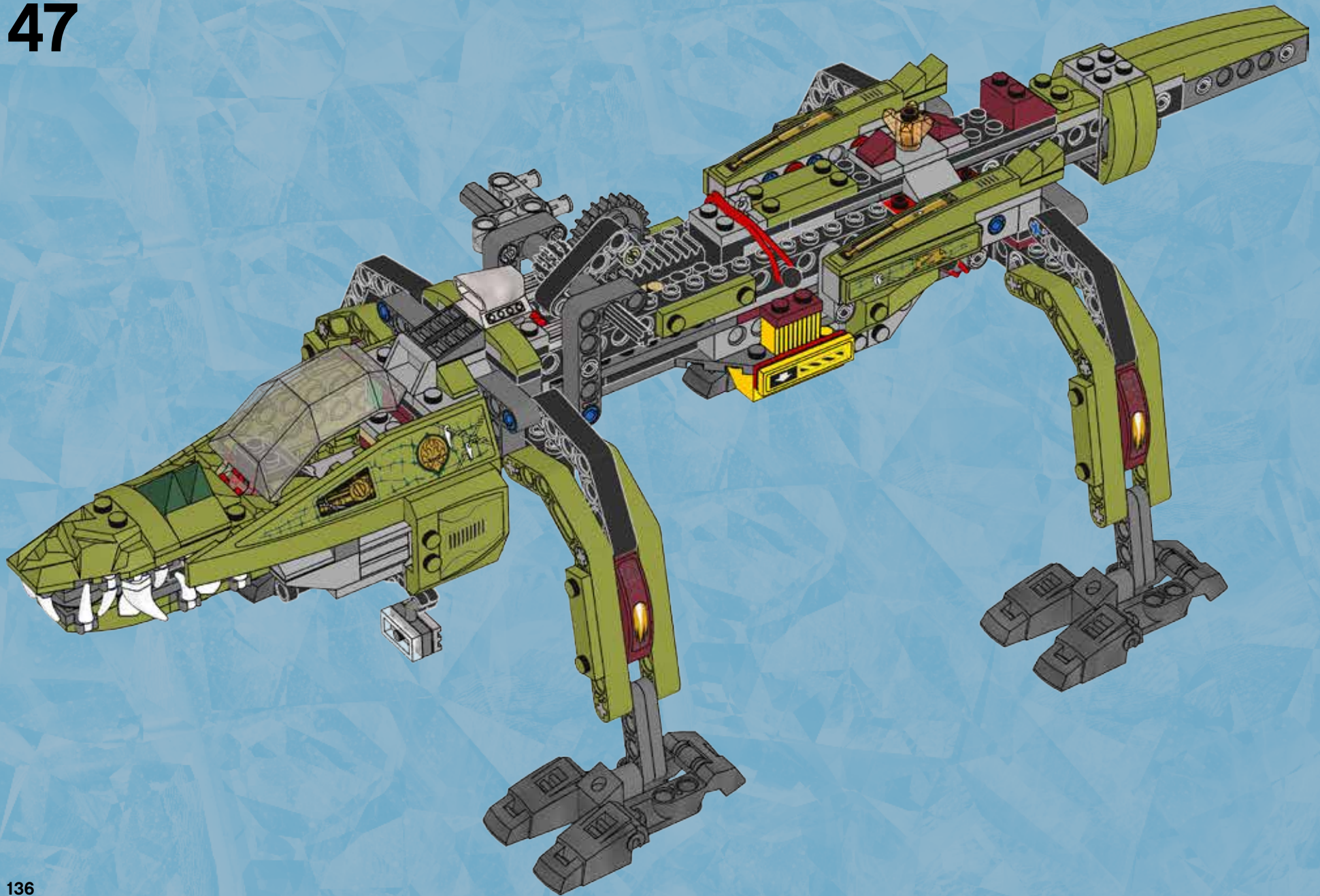



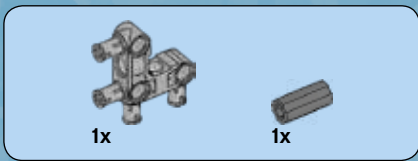

48

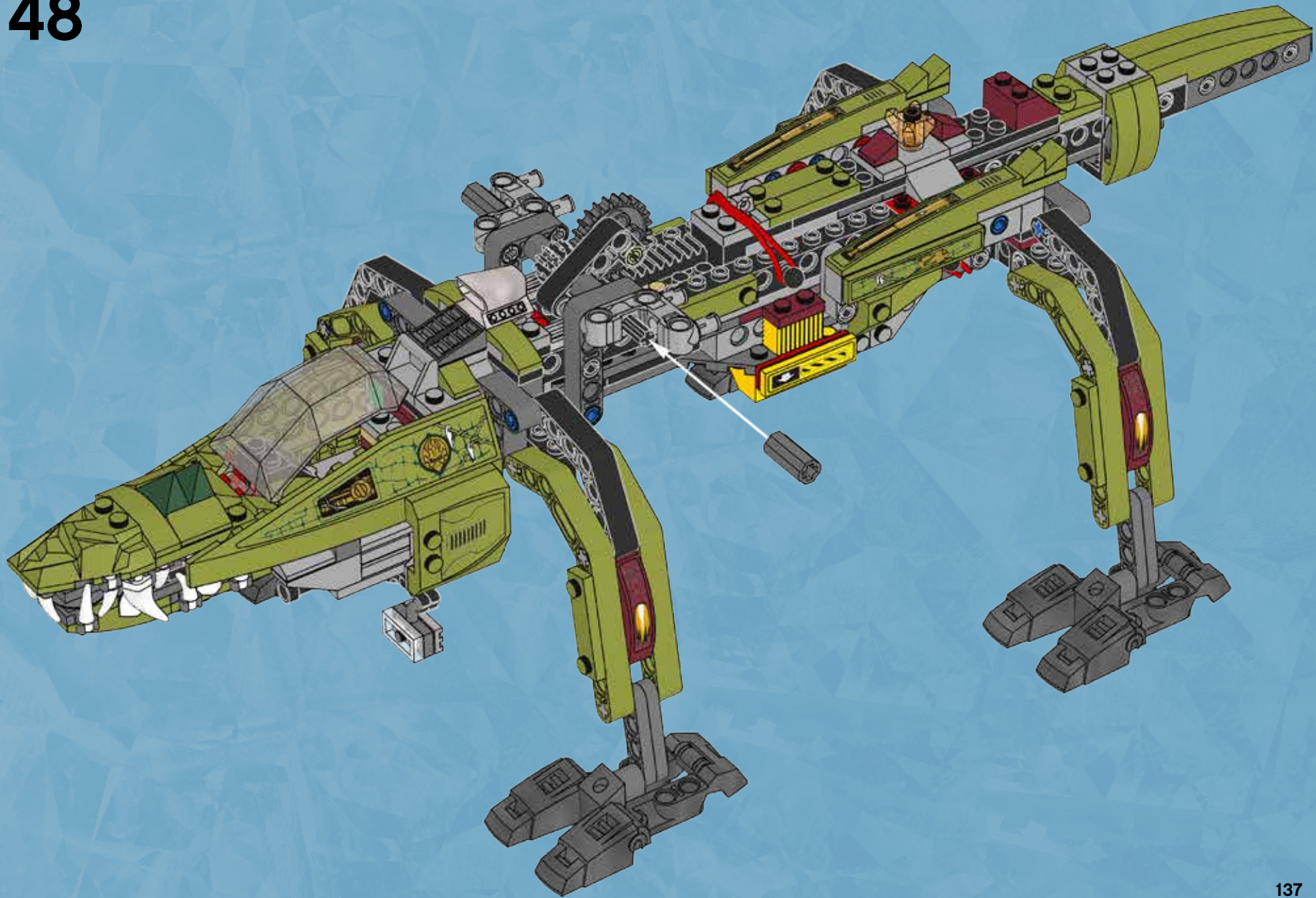

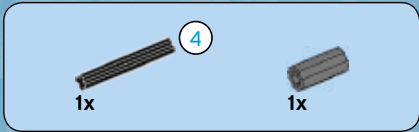
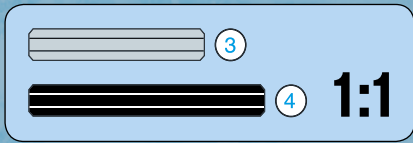

1

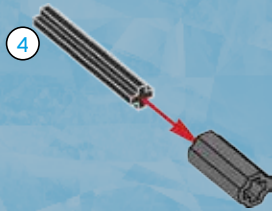

2

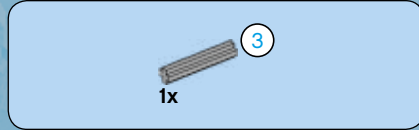
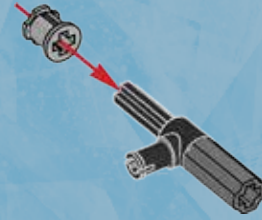

3

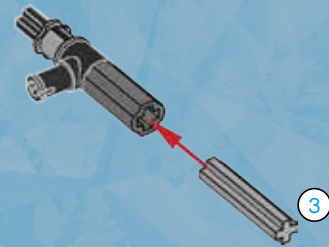



4

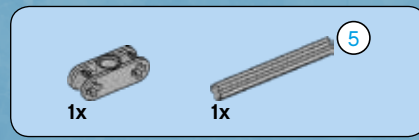
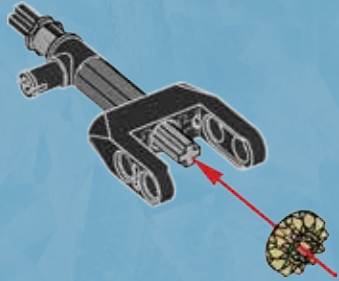

5

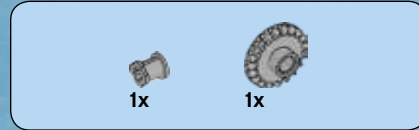
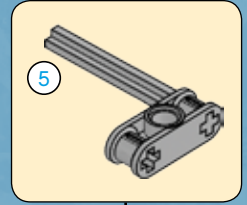

6

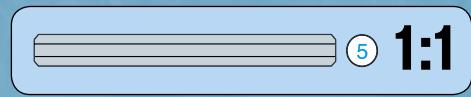
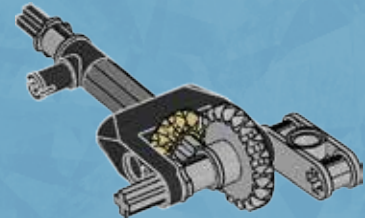

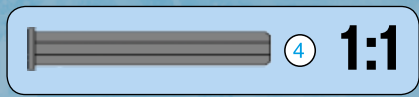

7

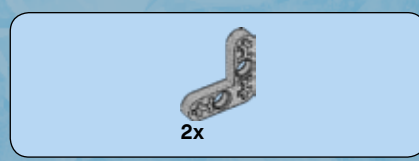
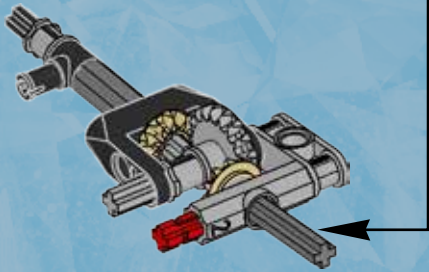
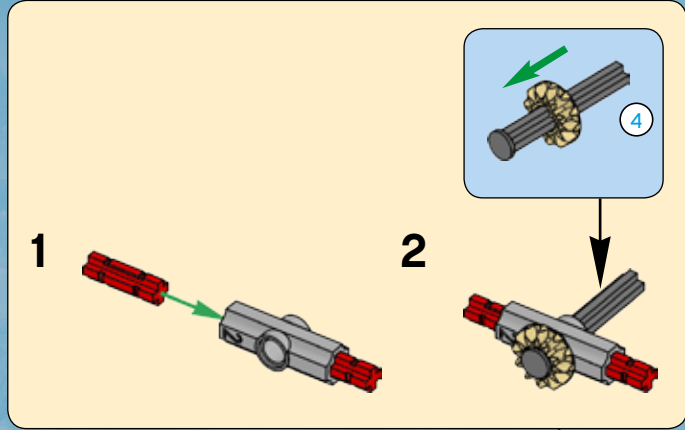

8

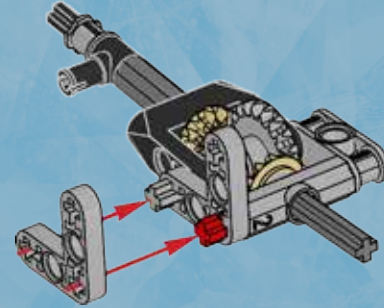

9

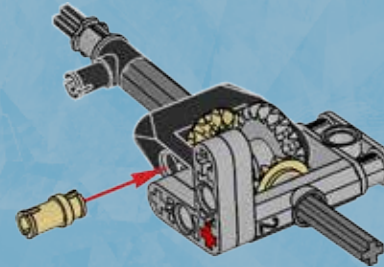



10

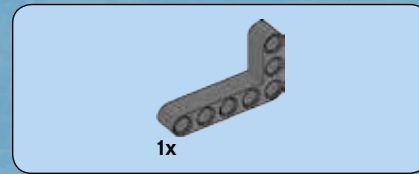
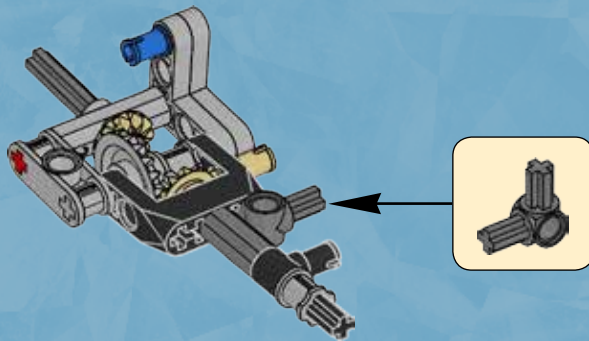

11

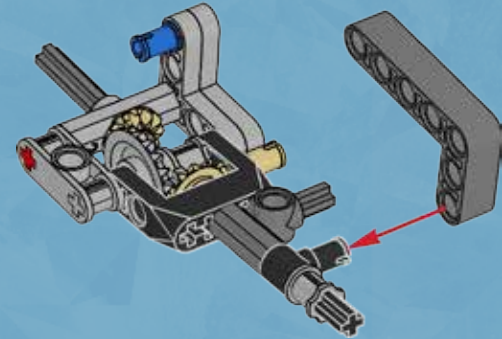

12

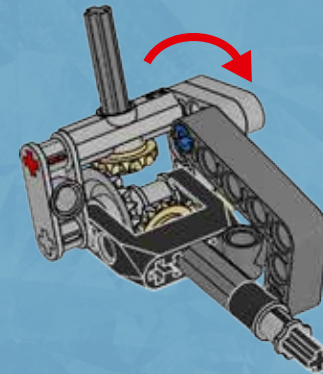

49

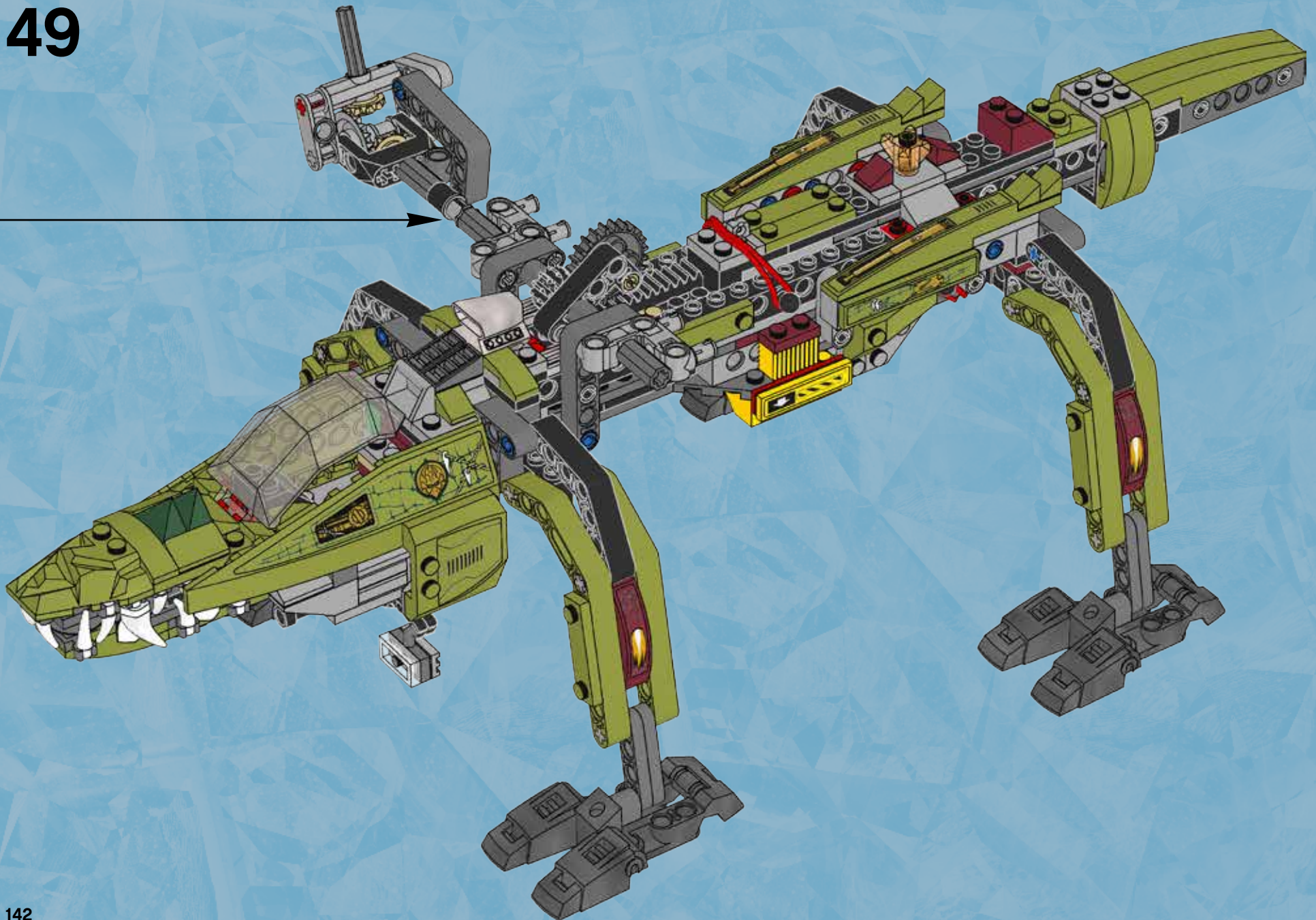

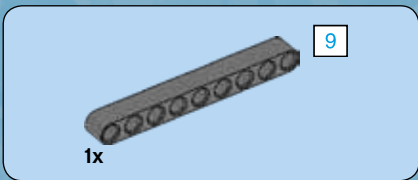

50

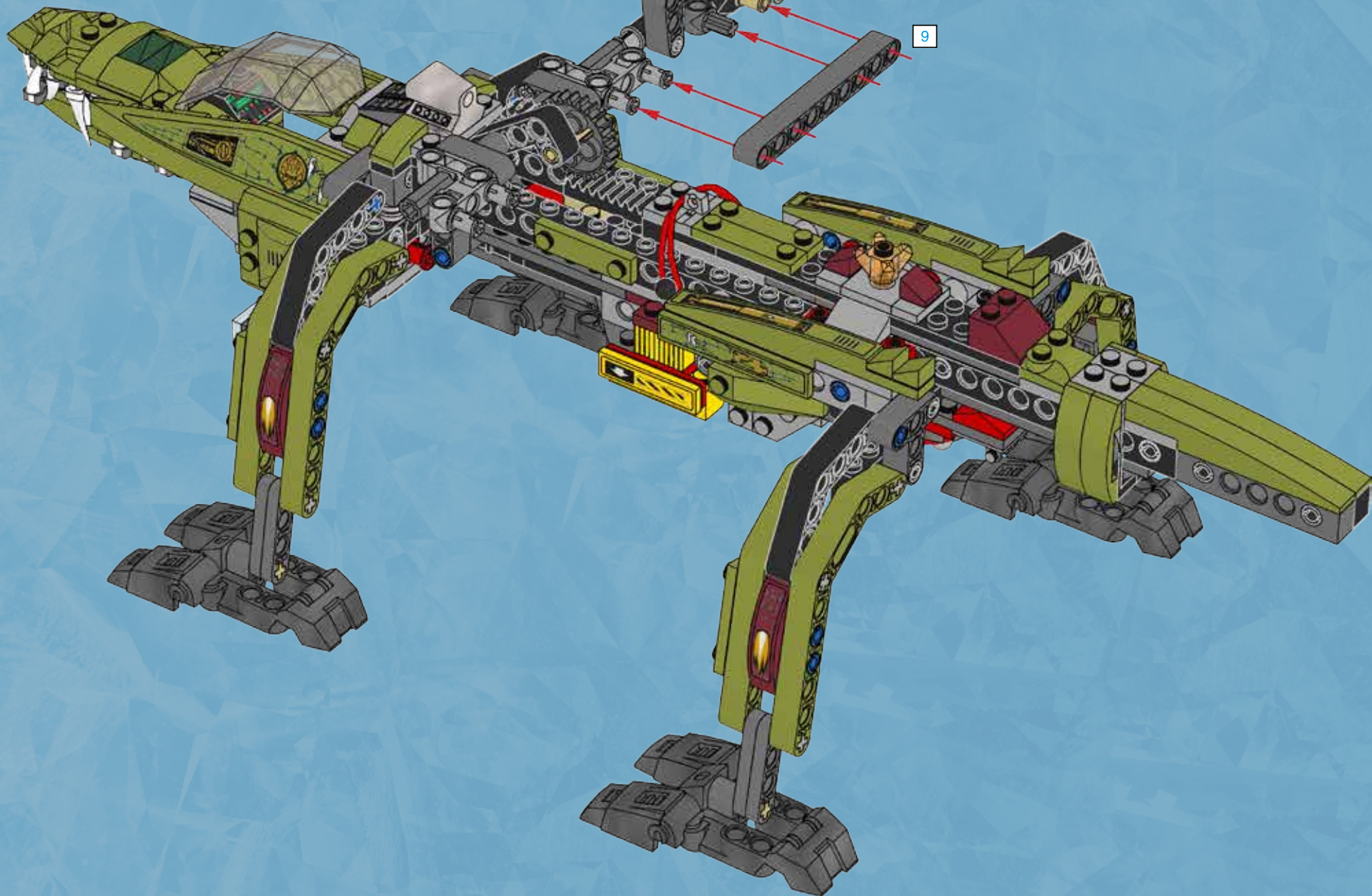

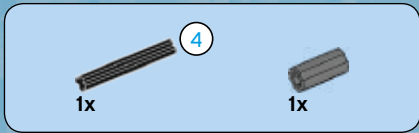
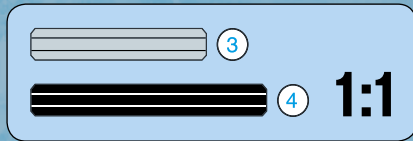

1

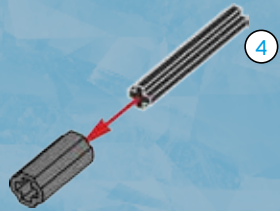

2

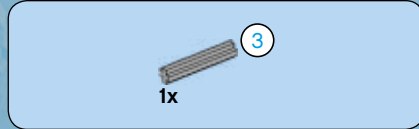
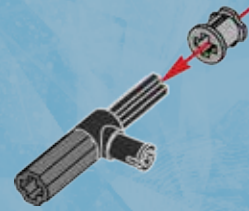

3

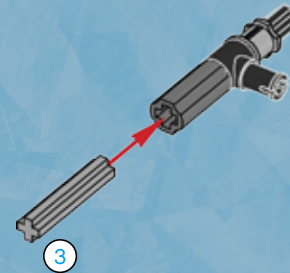





4

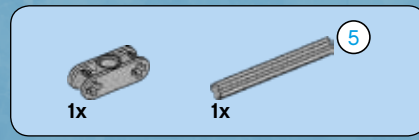
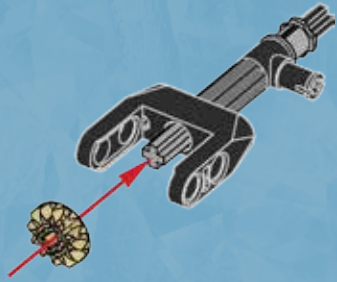

5

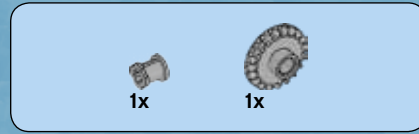
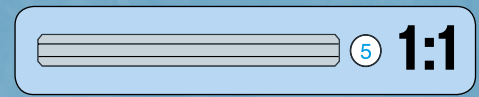
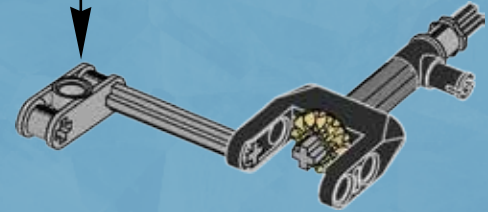
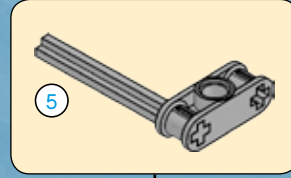

6

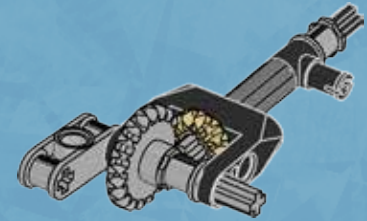

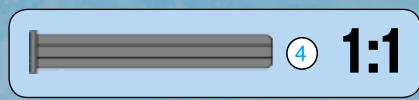

7

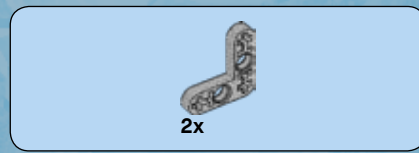
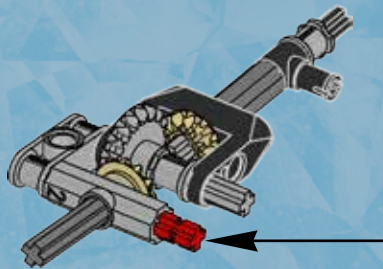
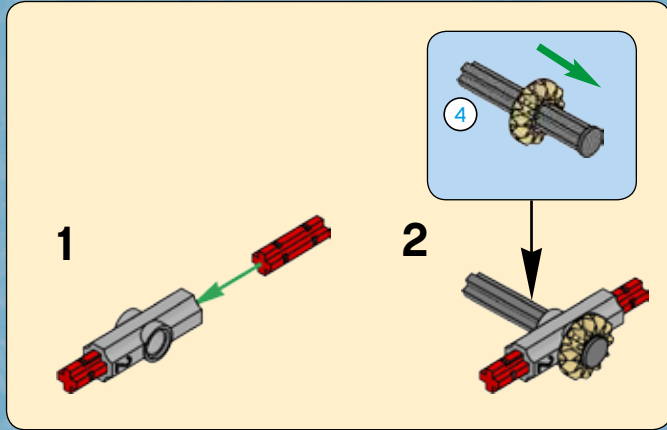

8

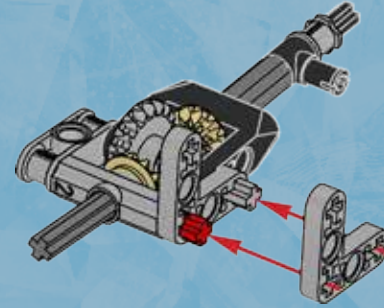

9

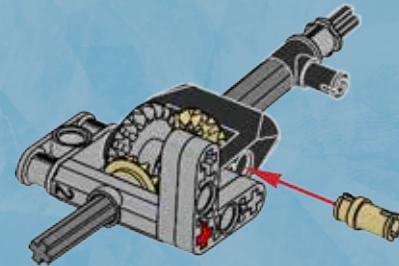



10

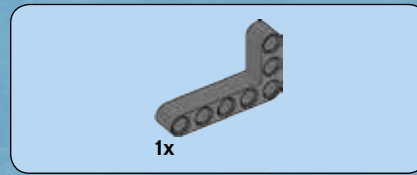
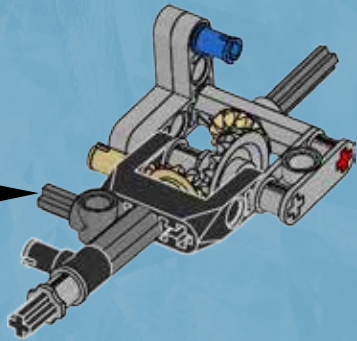

11

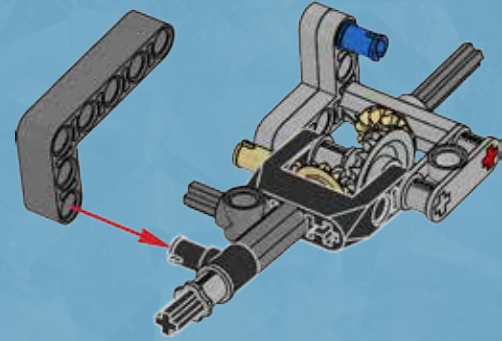

12

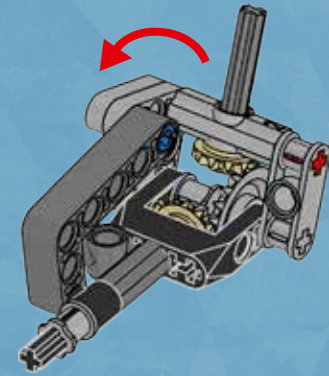

51

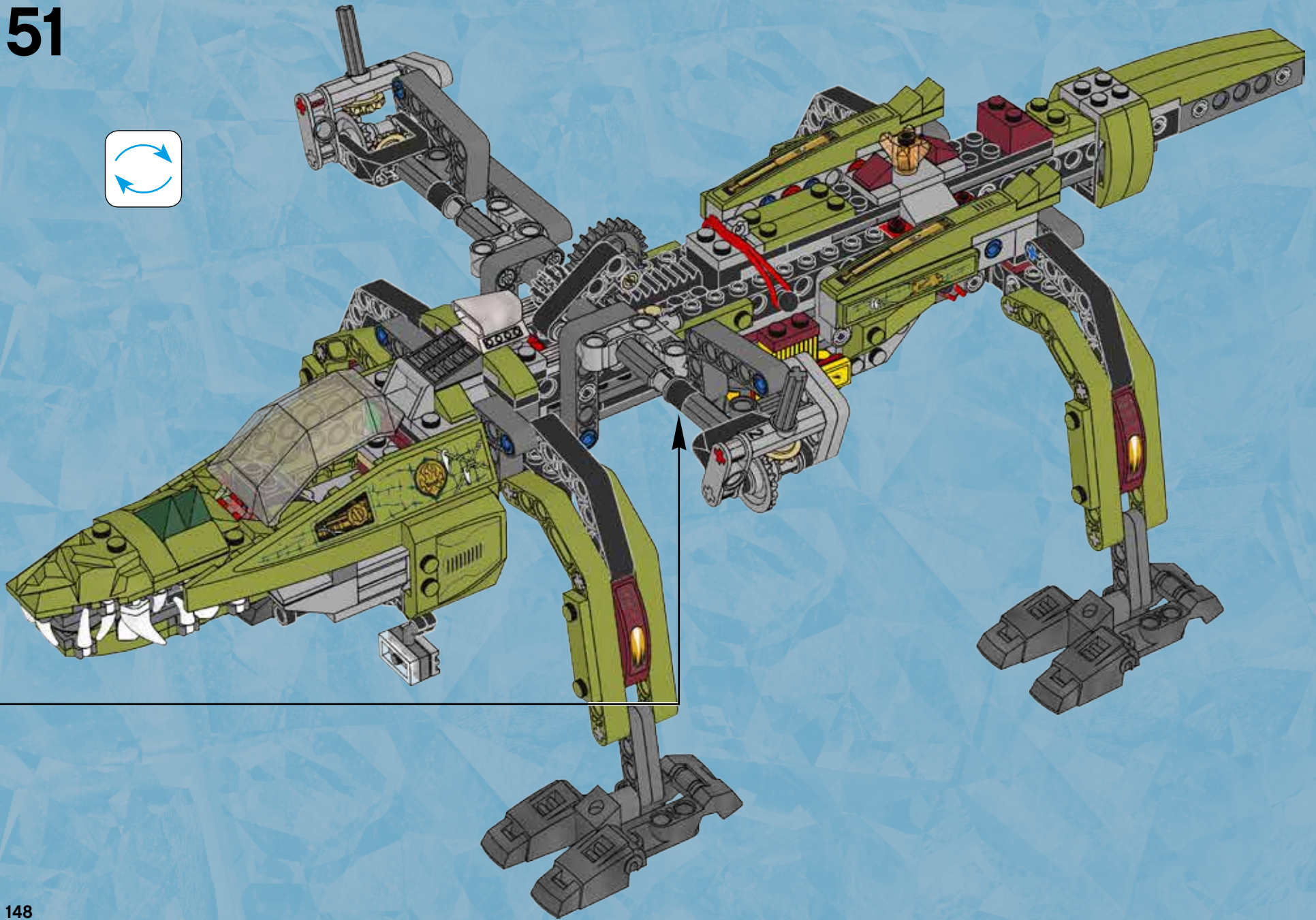

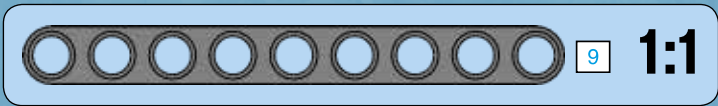
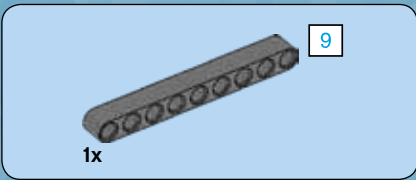

52

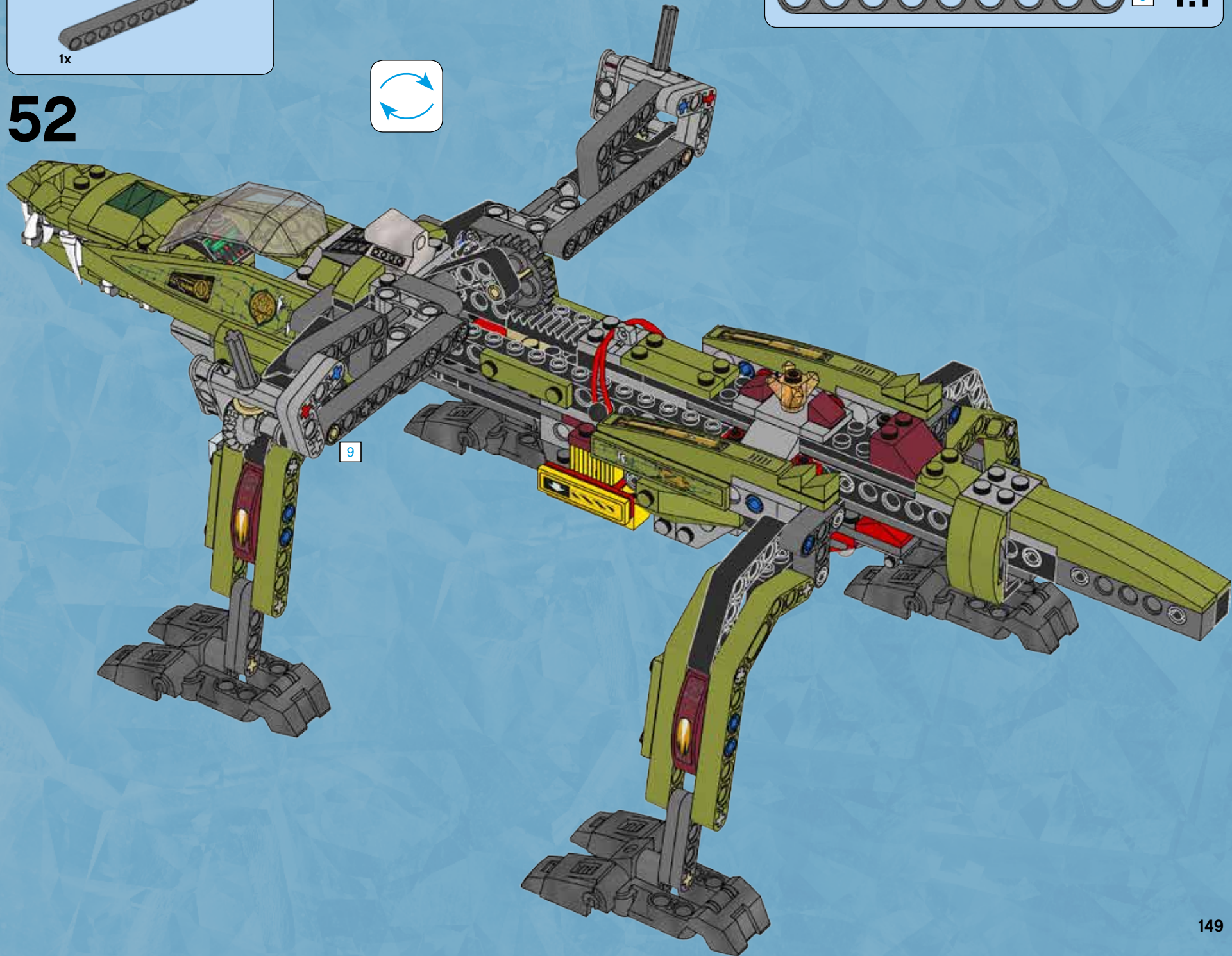



# 53

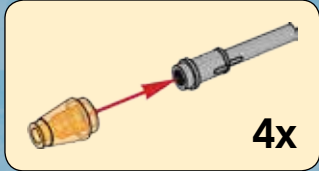
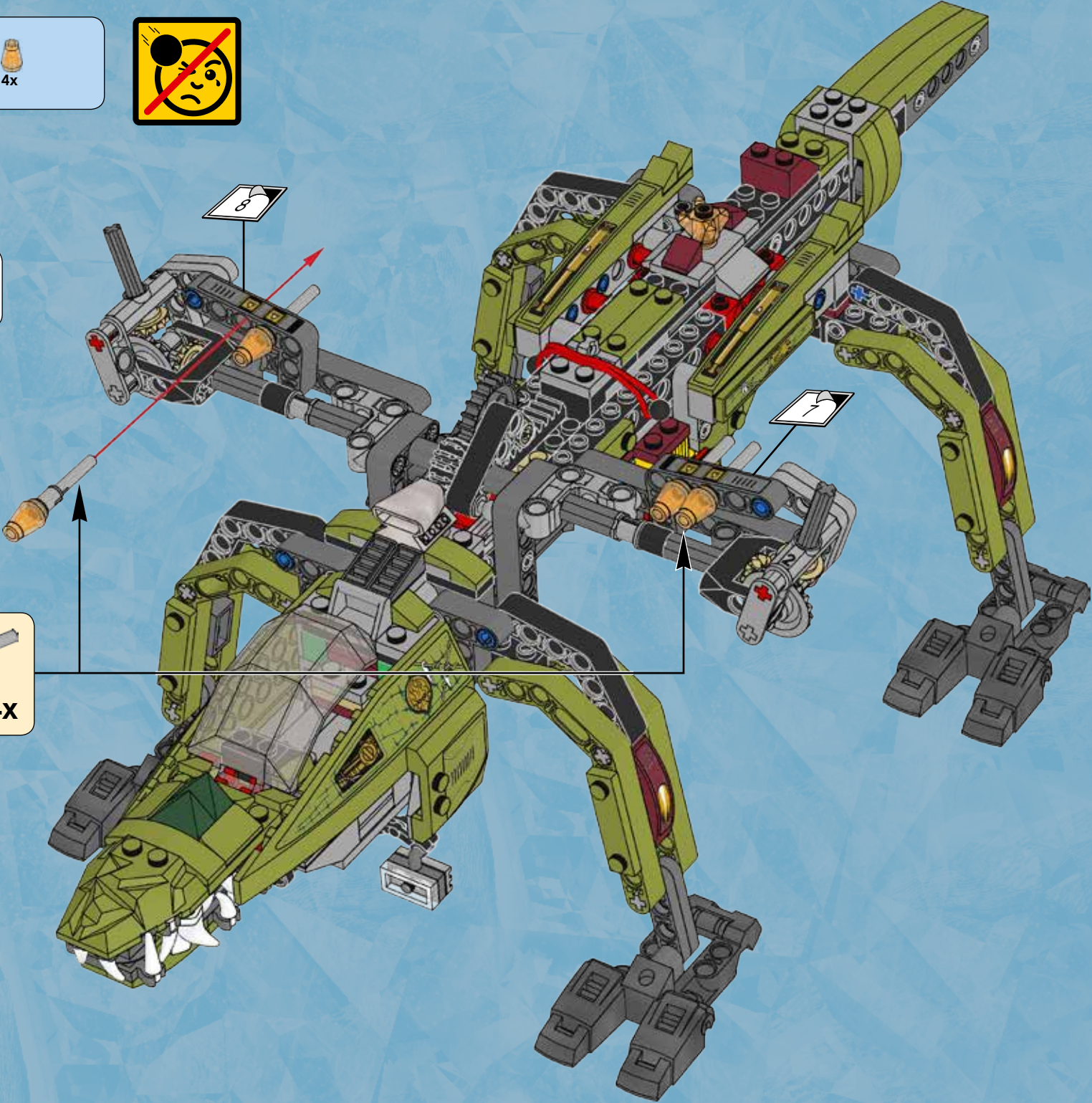



# 54

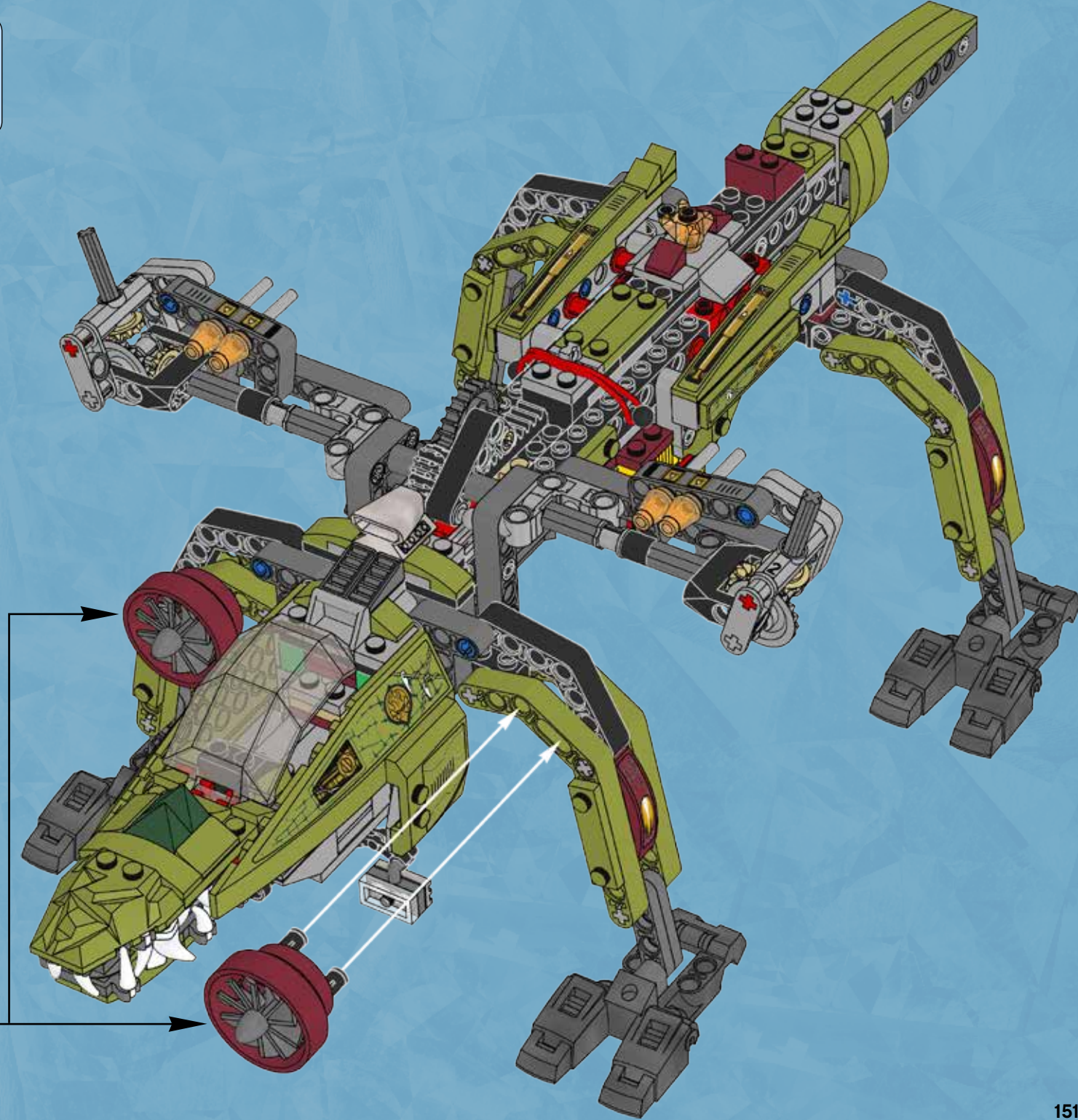
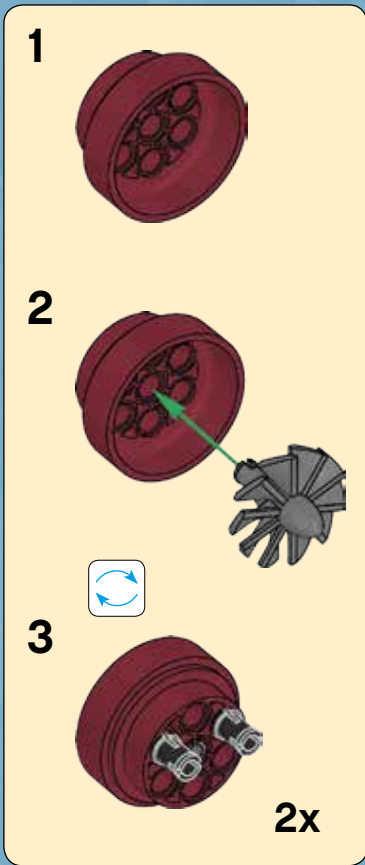

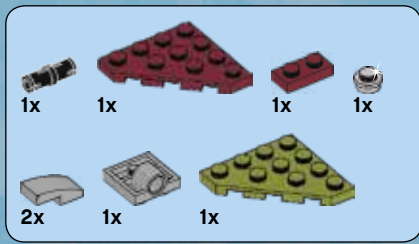

# 55

1



2



3

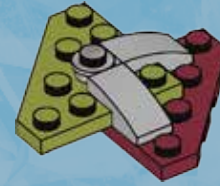

4

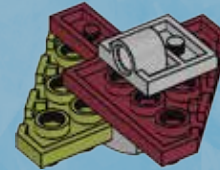
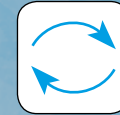

5

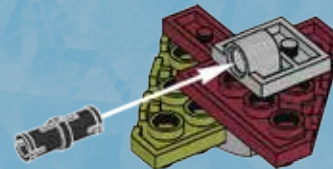



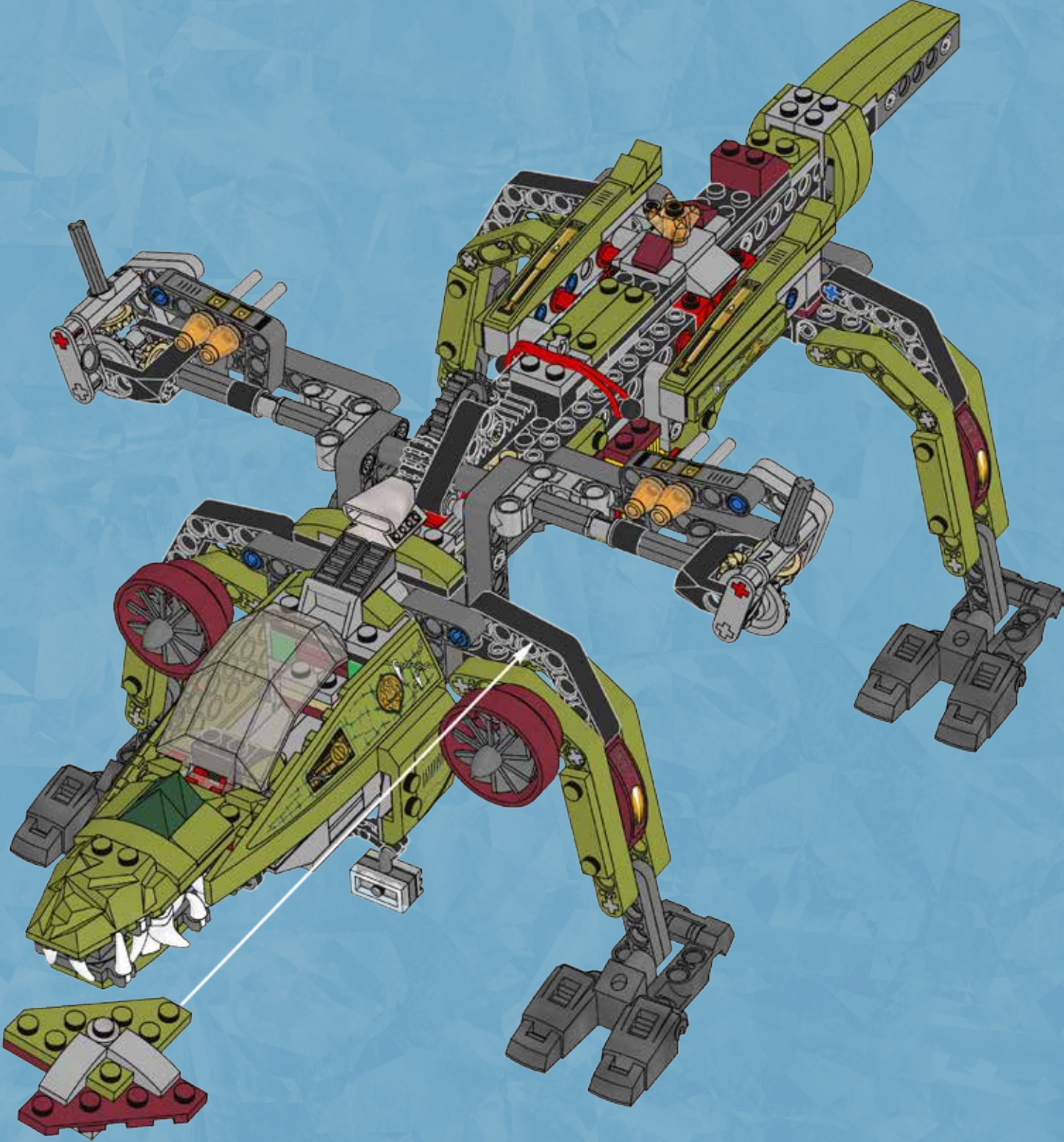

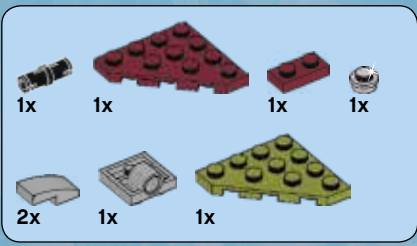

# 56

1



2



3

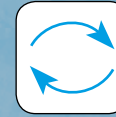
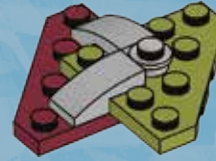

4

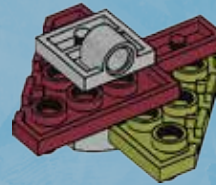

5

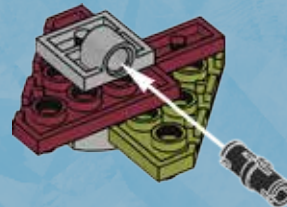

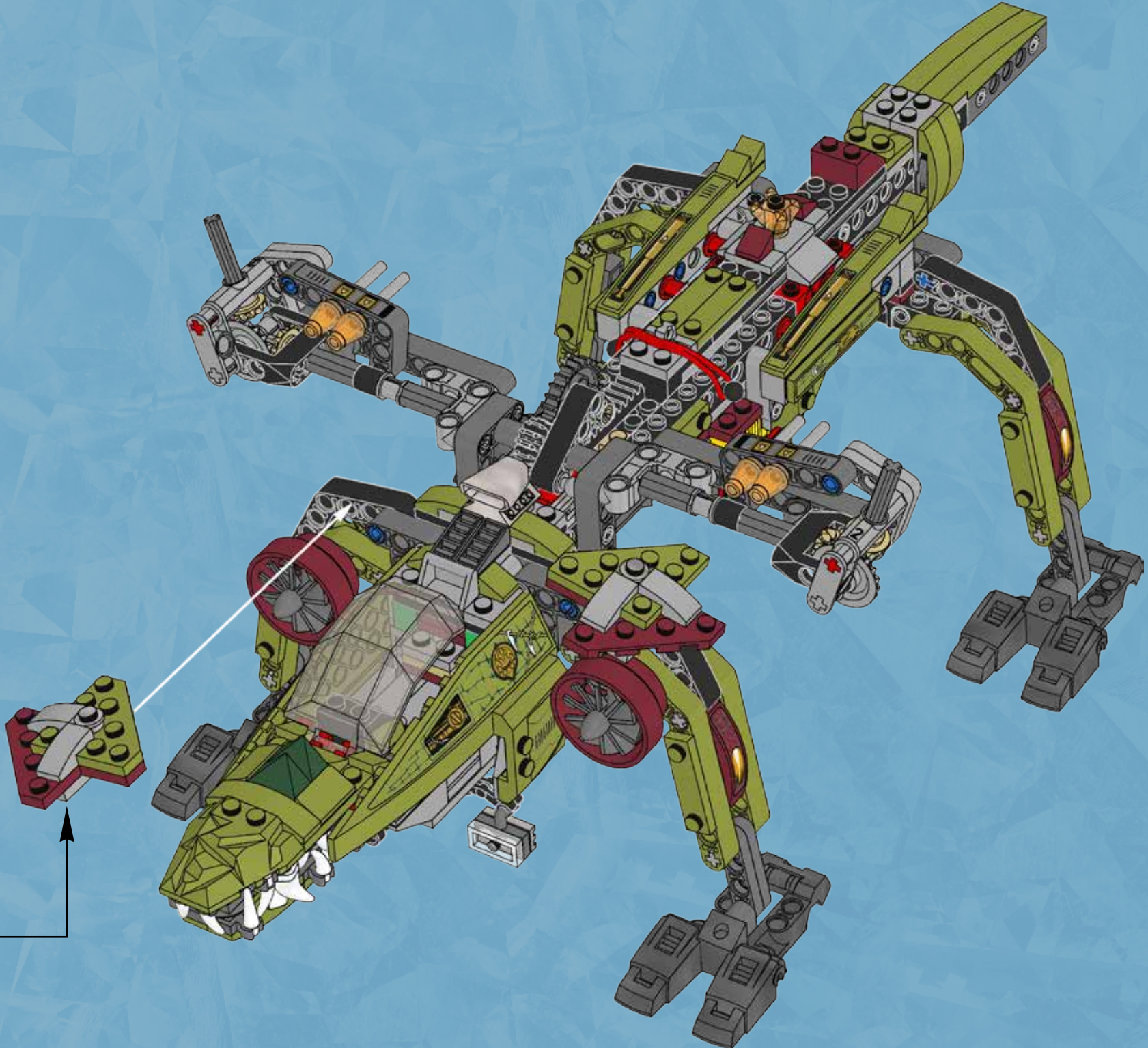

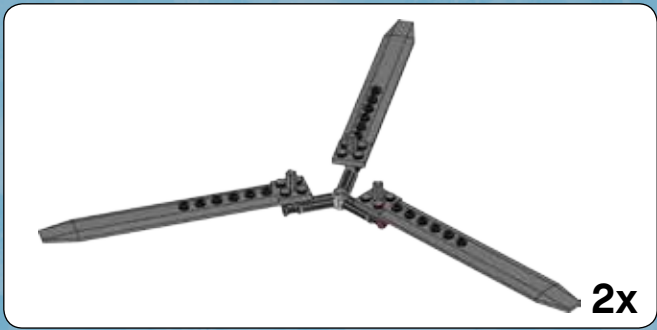

1

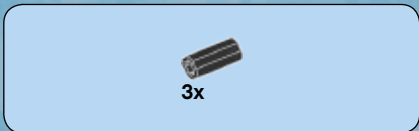

2



3

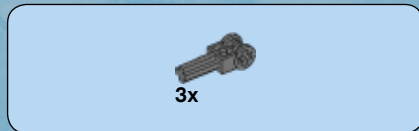
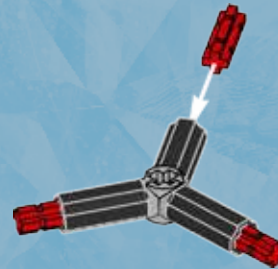

4

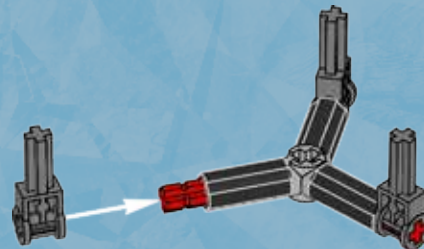

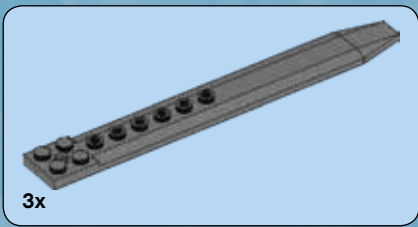

5

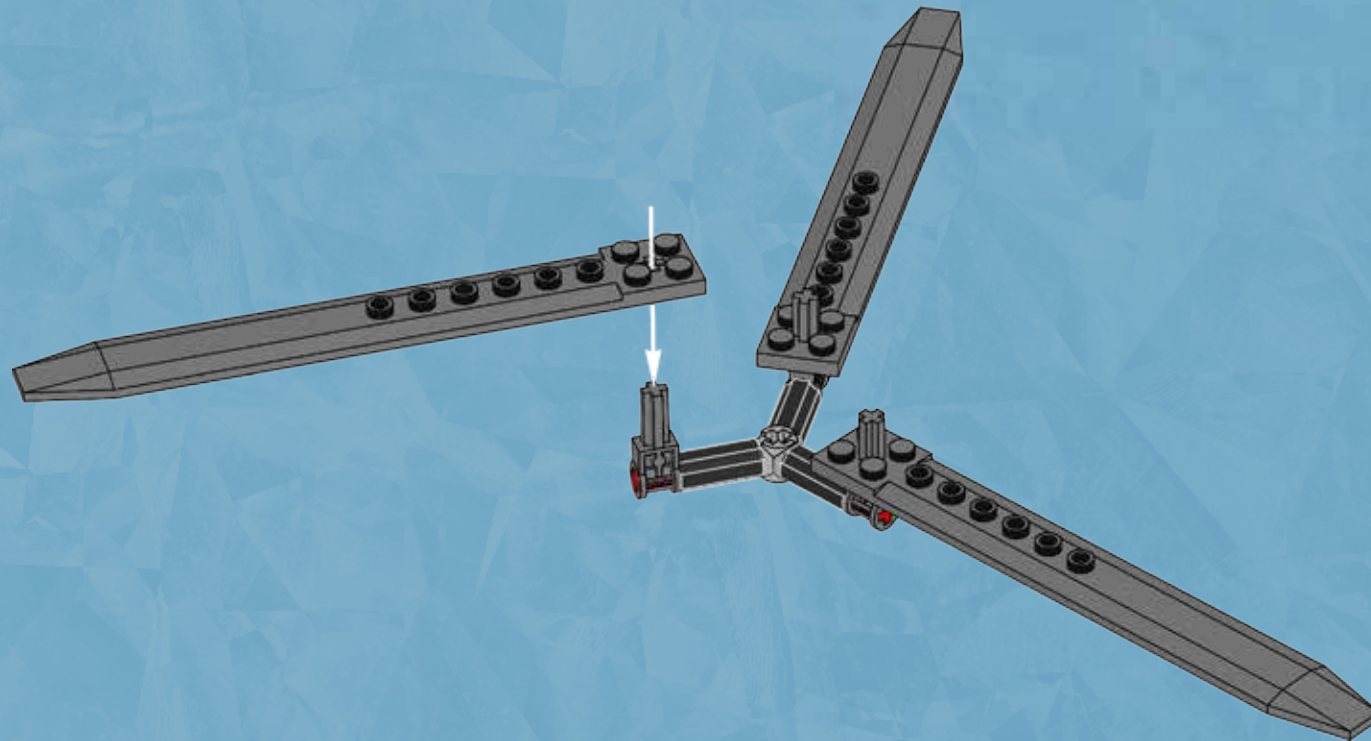

57

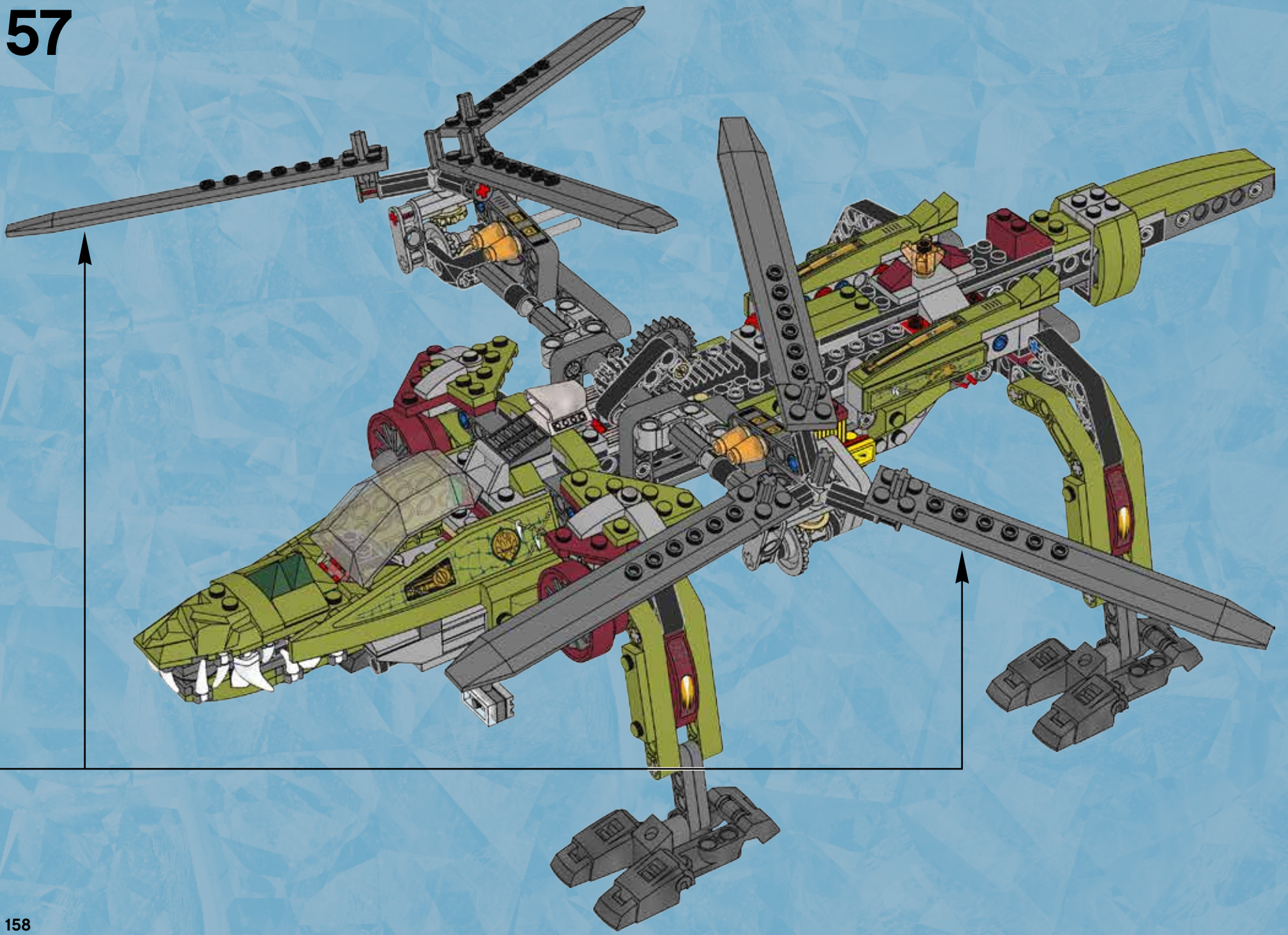



58

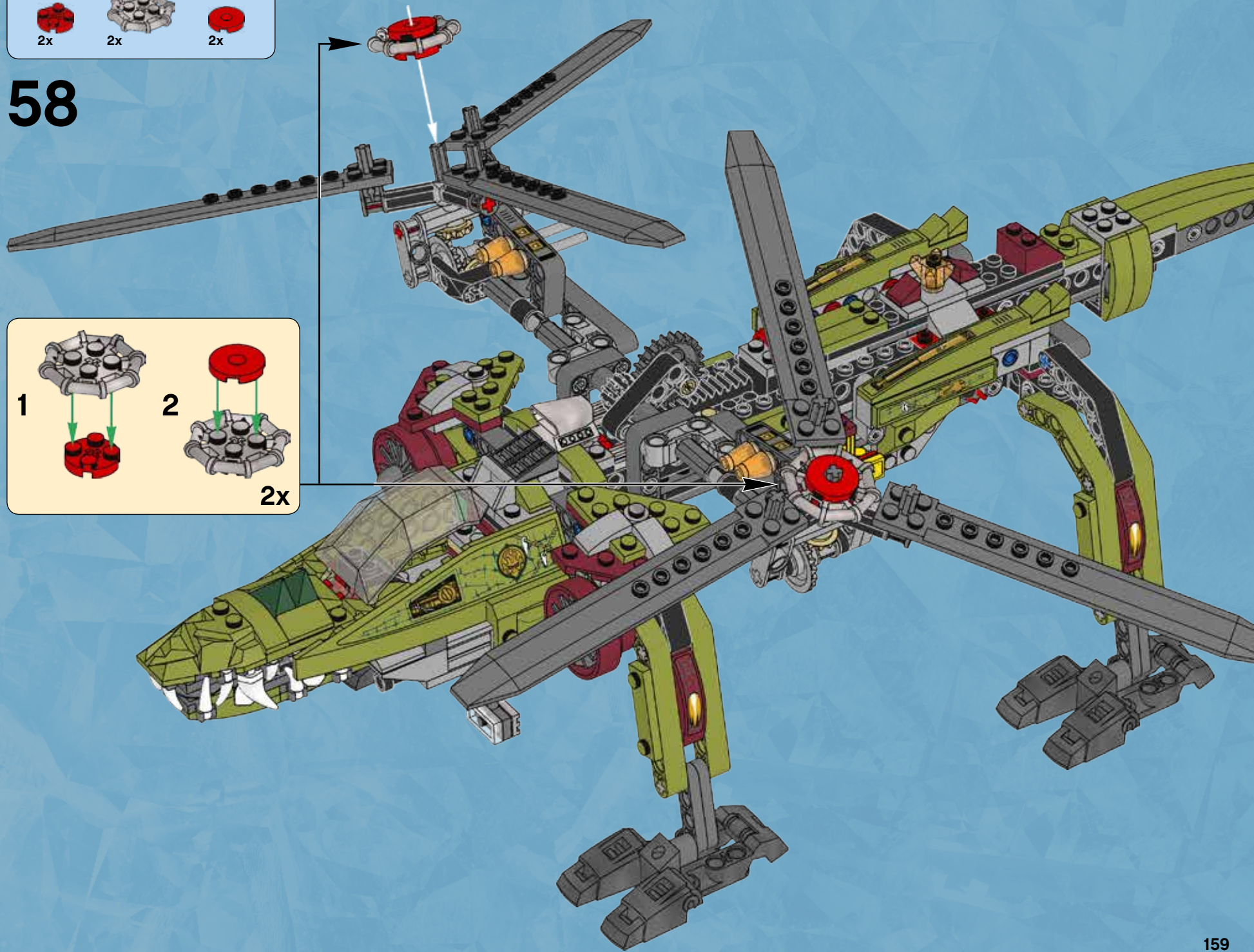
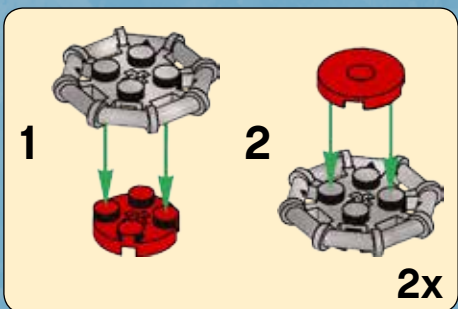

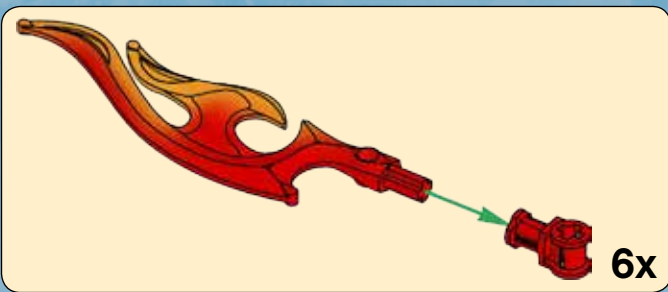
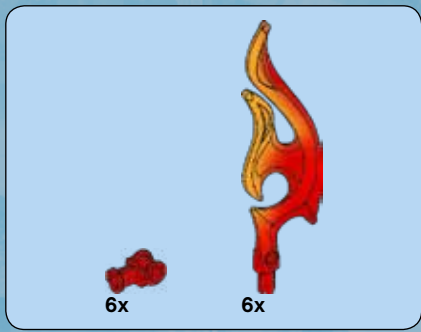

59

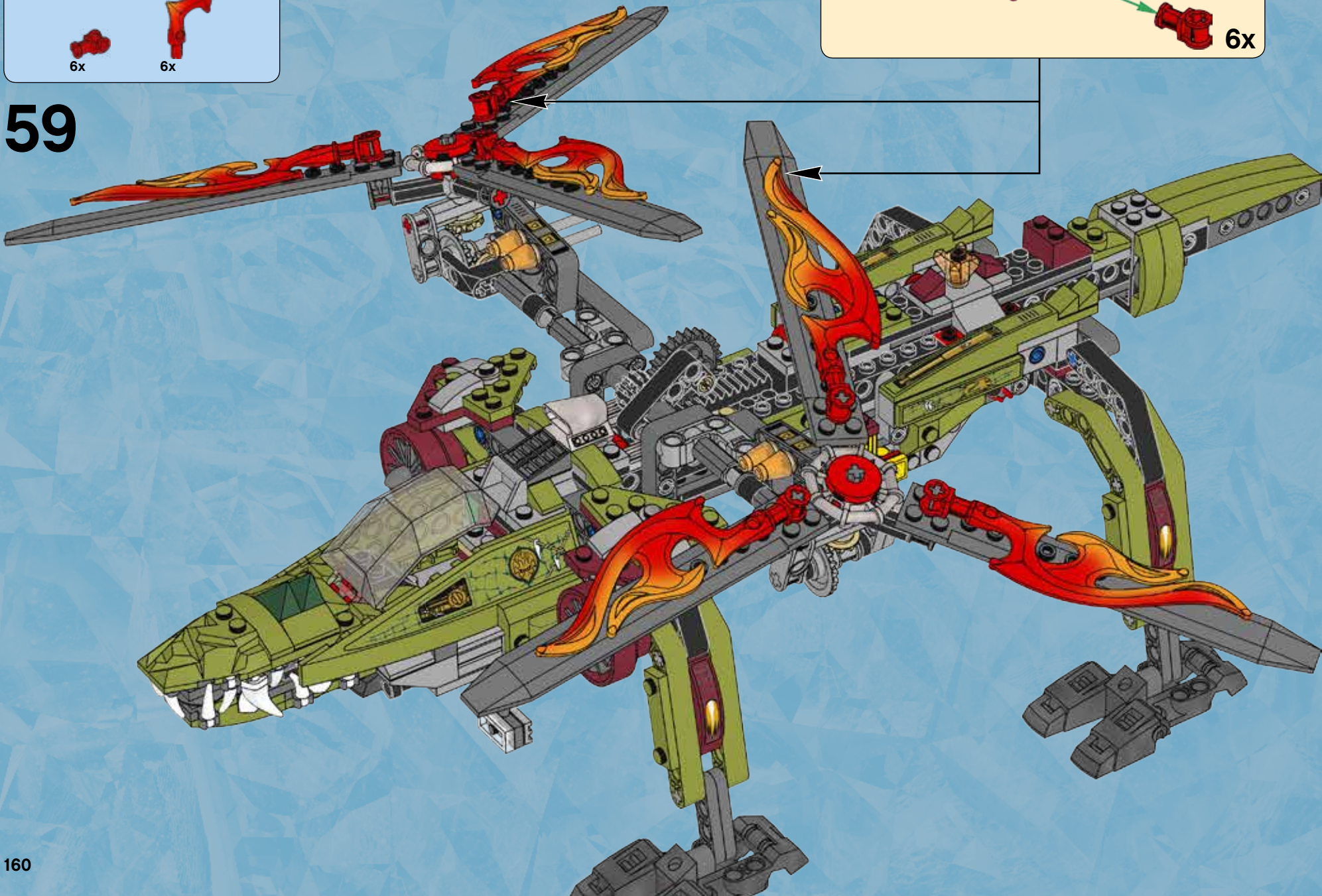



60

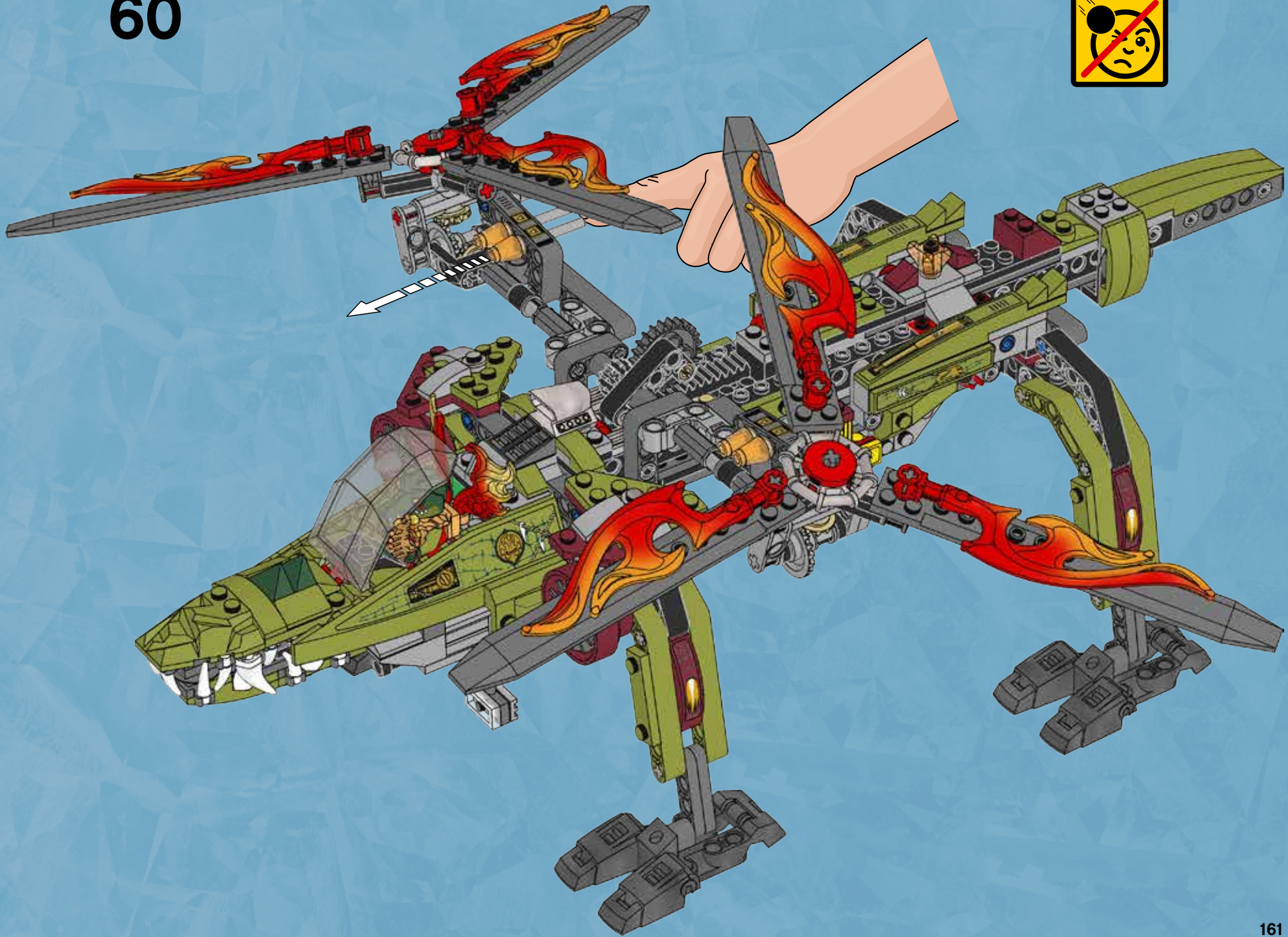

61

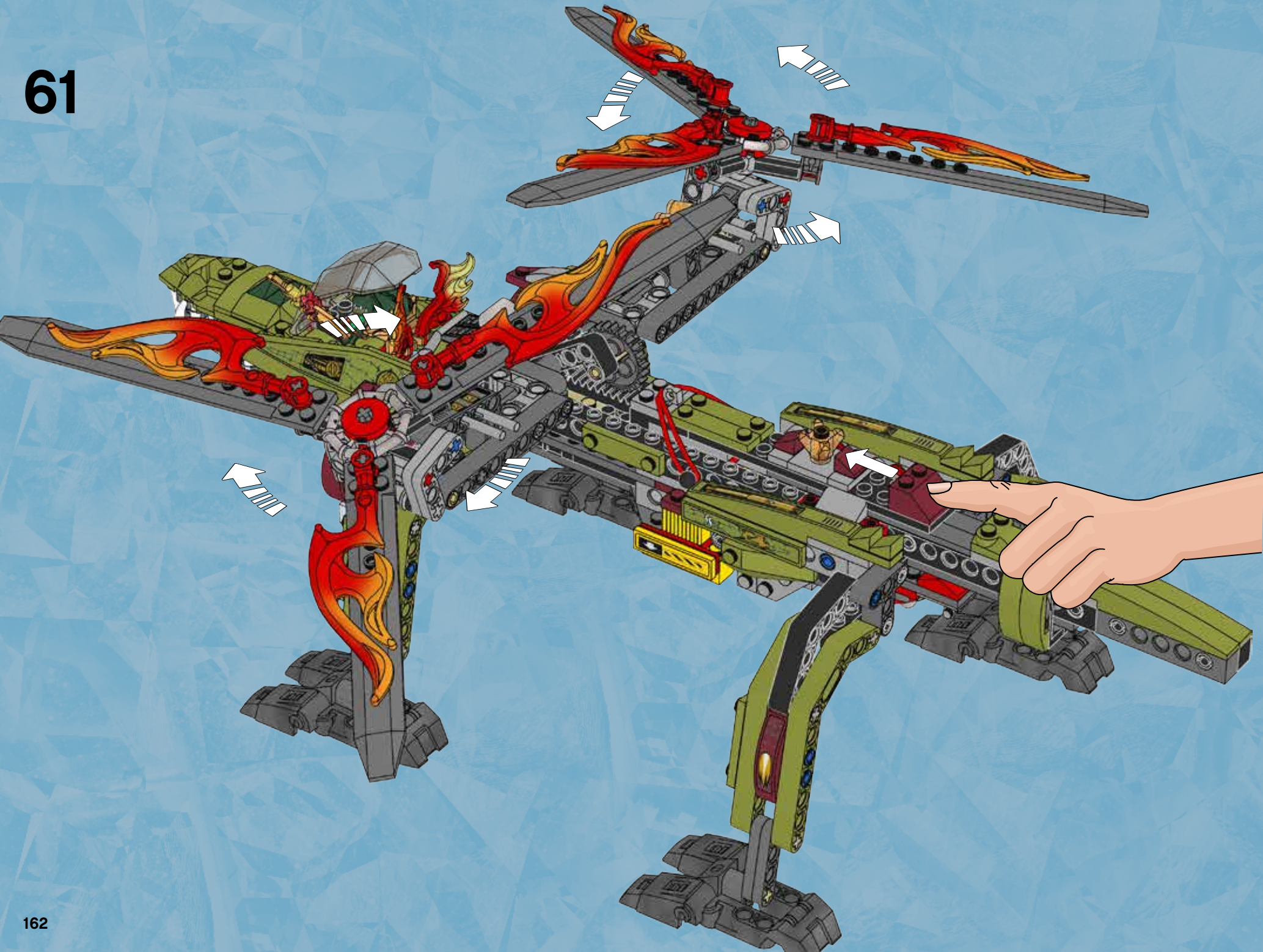

62

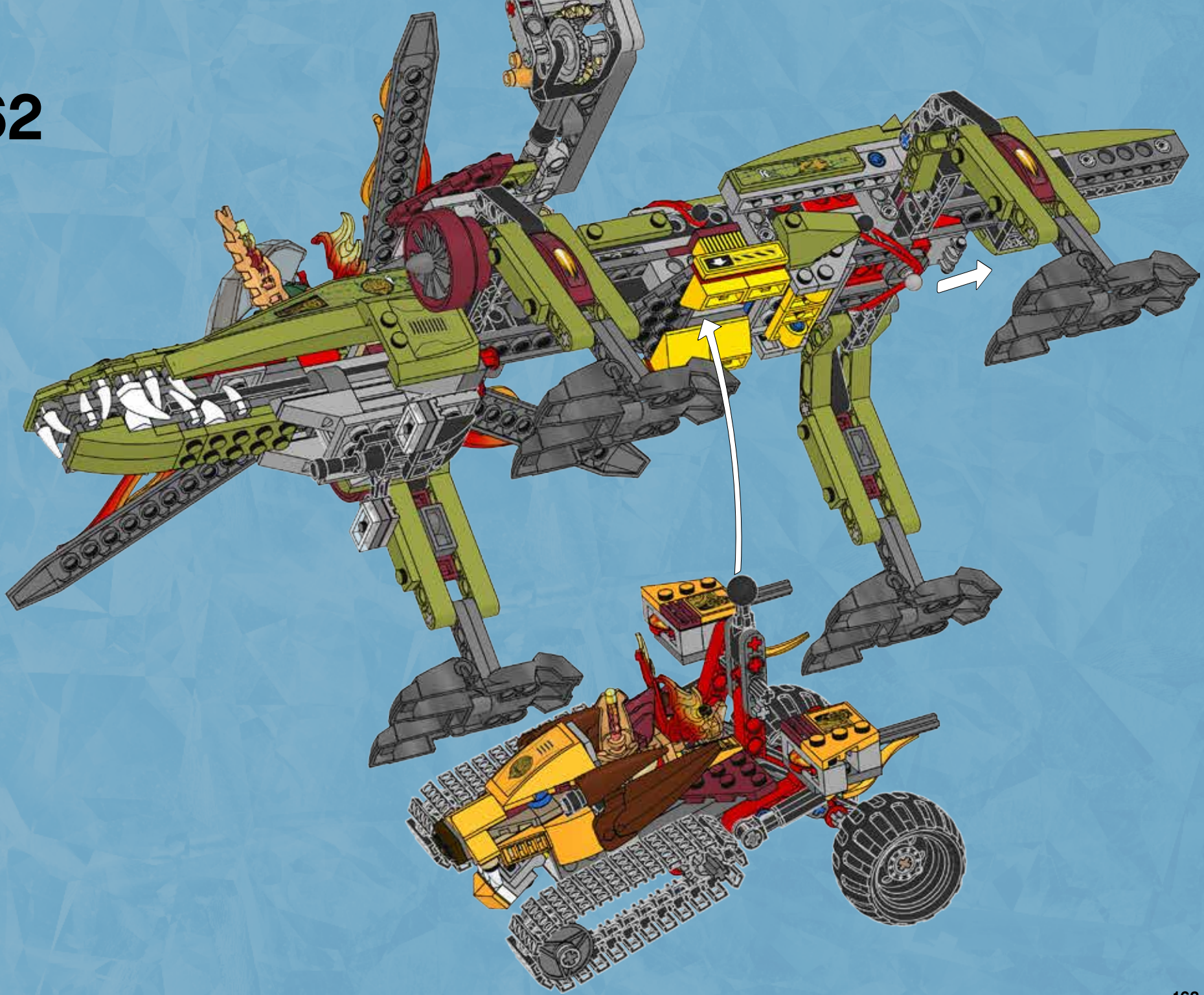

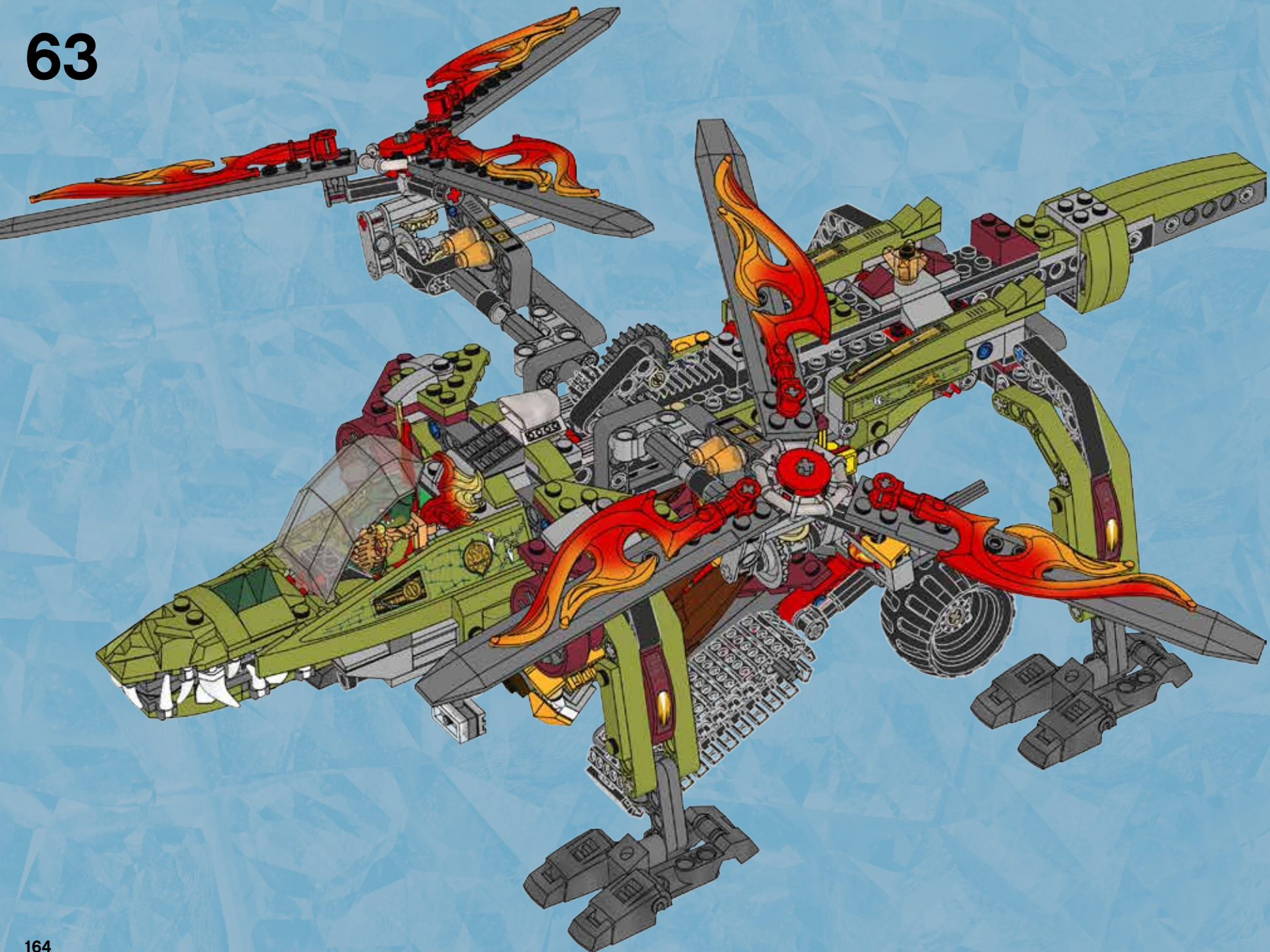

64

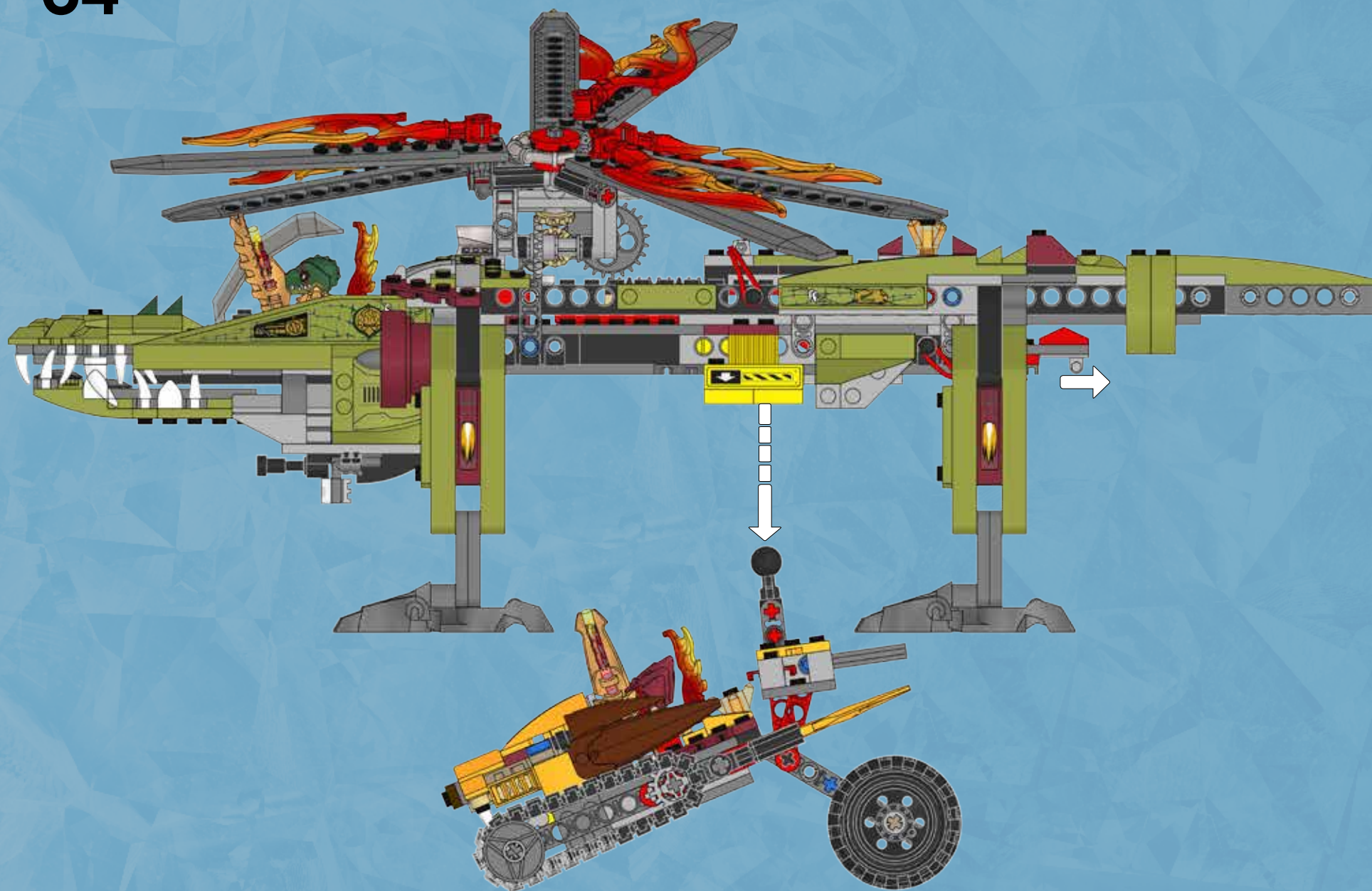

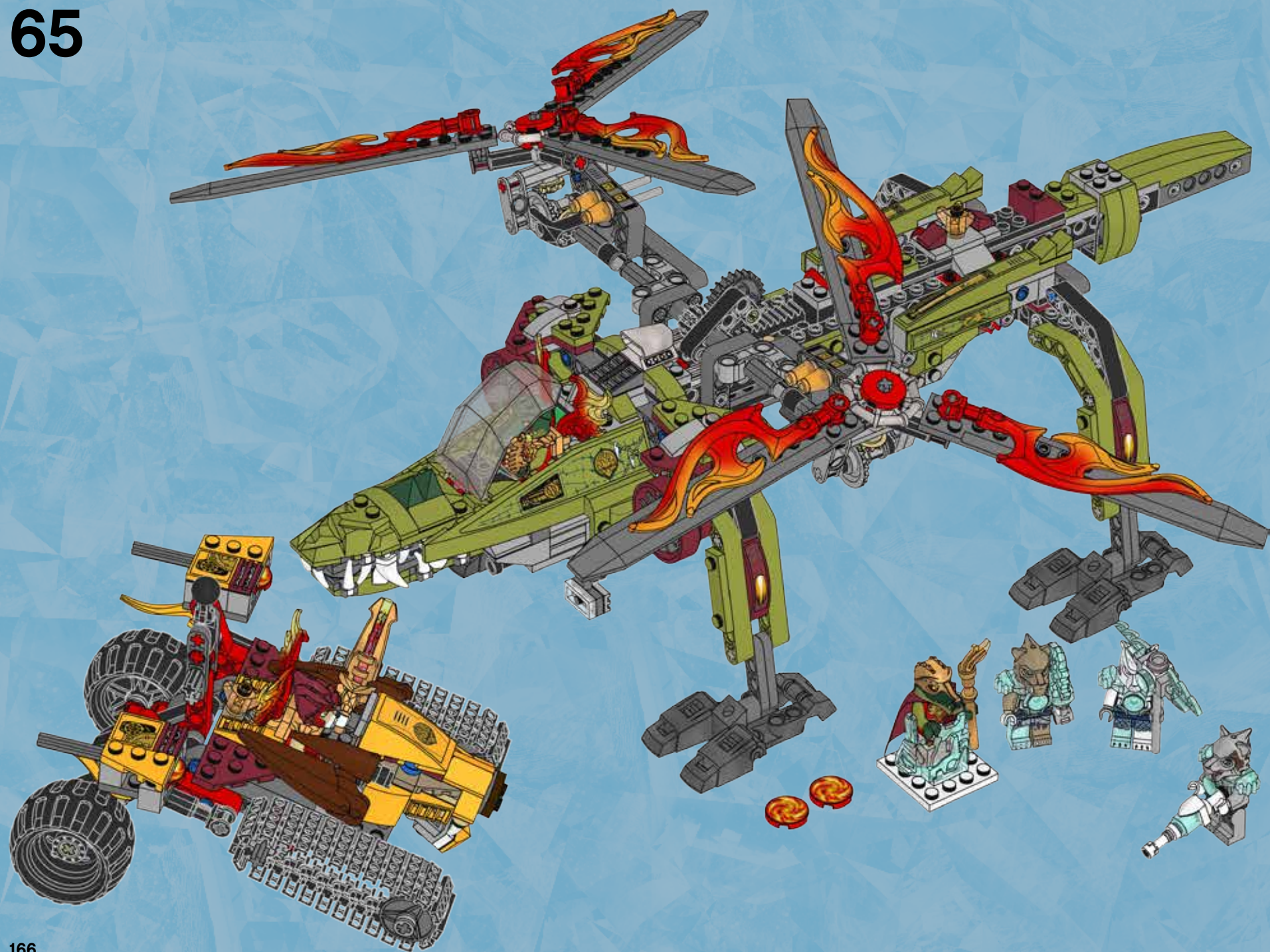

1x 6102369  
1x 4111971  
1x 6047220  
1x 4243812  
1x 459901  
1x 6100568  
1x 6102322  
1x 6103906  
1x 6040333  
16x 4568387  
2x 4566256  
5x 6046905  
1x 6046381  
1x 4114077  
3x 4118790  
3x 4113233  
2x 4632573

1x 6021599  
2x 6013938  
5x 4666579  
4x 4565452  
2x 300321  
3x 370121  
1x 330021  
2x 6057432  
2x 4113858  
2x 4597713  
4x 6089576  
2x 370921  
3x 403221  
4x 6102613  
2x 6102138  
6x 4140806  
1x 6073764

2x 6073639  
2x 6073600  
1x 6073752  
2x 4544143  
3x 4263821  
6x 6100700  
11x 4227155  
14x 4142865  
6x 4118897  
4x 6097662  
2x 6083865  
1x 4654448

10x 4206482  
18x 4514553  
1x 389423  
3x 4560180  
2x 6009460  
26x 4143005  
2x 6039869  
2x 4632571  
6x 6000650  
1x 6061032  
4x 4223247  
1x 4538456  
1x 287726  
1x 300126  
2x 6039194

4x 242026  
1x 4560108  
2x 4299389  
2x 4518826  
2x 4143372  
1x 4205760  
1x 4120017  
4x 4529549  
4x 4128593  
2x 4495935  
1x 346026  
2x 244526  
4x 370326

1x 6024730  
2x 6073231  
2x 4558692  
52x 6047885  
4x 4184169  
34x 4121715  
2x 4107081  
8x 4512363  
2x 6055630  
3x 370526  
1x 370726  
1x 373726  
1x 4177431  
1x 4551168  
2x 6021493  
2x 6068078

2x 4107736  
2x 4167842  
1x 4183544  
4x 6022171  
2x 6021974  
1x 6053028  
3x 6070887  
1x 6065032  
1x 6030851  
3x 6092591  
2x 6003379  
1x 6074013  
1x 6073932  
1x 6070269  
2x 6055631  
1x 6074050

3x 287724  
5x 366024  
1x 306924  
2x 243124  
1x 4556156  
2x 6061025  
2x 6075077  
1x 6022515  
1x 6022517  
1x 6022275  
2x 4531415  
1x 4609925  
4x 6000752  
2x 4541506  
23x 4539097  
2x 4585479  
1x 4541544  
4x 4539070

1x 6070612  
1x 6119414  
2x 6030706  
4x 4567338  
1x 4649066  
2x 6066085  
4x 6023173  
2x 6024286  
2x 6099728  
2x 6099730  
1x 6020141  
2x 6020147  
1x 6020145  
1x 6020146  
2x 6099396  
4x 6110043



**Customer Service**  
**Kundenservice**  
**Service Consommateurs**  
**Servicio Al Consumidor**  
**LEGO.com/service or dial**



00800 5346 5555 :



1-800-422-5346 :







# LEGENDS OF CHIMA™



70229



70230



70231



70232

[LEGO.COM/CHIMA](http://LEGO.COM/CHIMA)



LEGENDS OF  
**CHIMA**™



**LAVAL**

70227



**CRAGGER**

70227



**ROGON**

70226



**BLADVIC**

70225



**GORZAN**

70222



**WORRIZ**

70220



**RAZAR**

70223

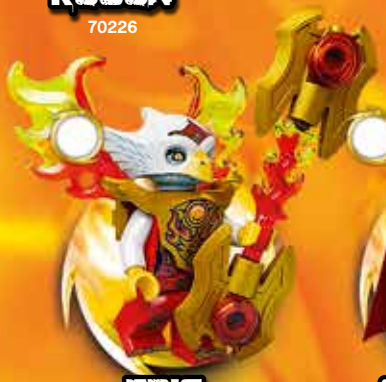

**ERIS**

70224



**CROMNIUS**

70227



**CROKENBURG**

70231



**LI'ELLA**

70229

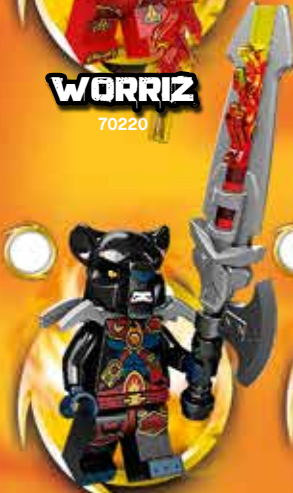

**TORMAK**

70222



**RINONA**

70226



**TAZAR**

70224



**TRAKKAR**

70224



**BREEZOR**

70224



**FLINX**

70221



**BULKAR**

70223



**SIR FANGAR**

70224



**STRAINOR**

70227



**ICEPAW**

70227



**ICECLAW**

70225



**VORNON**

70225



**ICEBITE**

70223



**SYKOR**

70232



**SARAW**

70227



**SIBRESS**

70224



**MAULA**

70226



**MOTTROT**

70226



**SIROX**

70232



**ICECLAW**

70230



**VARDY**

70226



**VOOM VOOM**

70221



**STRAINOR**

70220



**ICEPAW**

70223



LEGENDS OF  
**CHIMA**<sup>TM</sup>



70227



70225



70226





LEGENDS OF  
**CHIMA**<sup>TM</sup>

70220

70221

70222

70223

70224



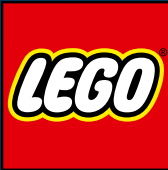

# LEGENDS OF CHIMA™

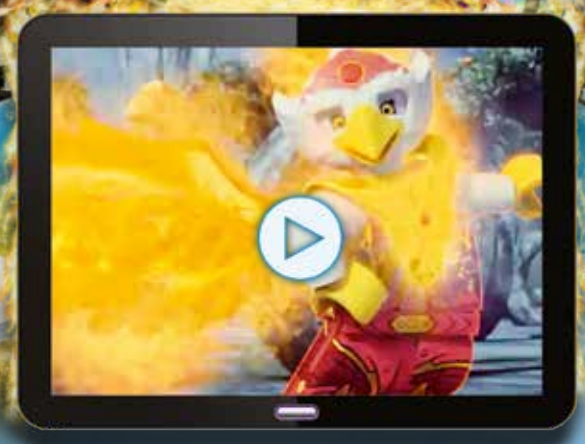

## LEGO.COM/CHIMA

...Or visit:



Apple, the Apple logo, iPad, iPhone and iPod touch are trademarks of Apple Inc., registered in the U.S. and other countries. App Store is a service mark of Apple Inc.

Google Play is a trademark of Google Inc.



# club

TM



# WIN

GO TO [WWW.LEGO.COM/PRODUCTFEEDBACK](http://WWW.LEGO.COM/PRODUCTFEEDBACK) AND  
GIVE US YOUR SHORT **FEEDBACK** ABOUT THIS  
LEGO® SET FOR A CHANCE TO WIN  
A COOL LEGO PRIZE.



## LEGO.com/productfeedback

### GEWINNE



Erzähle uns auf  
[www.LEGO.com/productfeedback](http://www.LEGO.com/productfeedback)

etwas über die Erfahrungen, die  
du mit diesem LEGO® Set gemacht  
hast, und sichere dir die Chance  
auf einen coolen LEGO Preis!

### GAGNE



Rends-toi sur  
[www.LEGO.com/productfeedback](http://www.LEGO.com/productfeedback)

et donne-nous quelques com-  
mentaires sur ce produit LEGO®  
pour avoir une chance de gagner  
un prix LEGO !

### GANAN



Visita  
[www.LEGO.com/productfeedback](http://www.LEGO.com/productfeedback)

y envíanos tu opinión acerca de  
este set LEGO®. ¡Participarás en el  
sorteo de un premio LEGO!

### 获取奖品



登录  
[www.LEGO.com/productfeedback](http://www.LEGO.com/productfeedback)

给出关于此乐高®套装的简短反馈，  
就有机会获得炫酷乐高奖品

### 경품 당첨 기회



[www.LEGO.com/productfeedback](http://www.LEGO.com/productfeedback)

페이지로 이동하여 이 레고® 세트에  
대한 간략한 피드백을 보내 주시고  
멋진 레고 경품을 탈 수 있는 기회도  
잡으십시오

### ЗАПОЛНИ АНКЕТУ И ПОЛУЧИ ПРИЗ



Перейди по ссылке  
[www.LEGO.com/productfeedback](http://www.LEGO.com/productfeedback)

ответь всего на несколько во-  
просов об этом наборе LEGO®,  
и у тебя появится шанс выиграть  
замечательный приз от компании  
LEGO.