



# Mixels™

41548



# DRIBBAL



 [LEGO.com](http://LEGO.com)

6126533

1

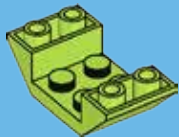

2

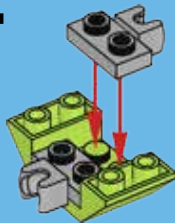

3

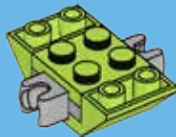

4

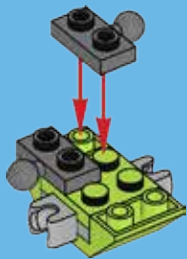

5

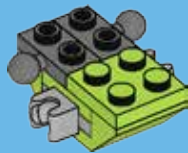

6



7

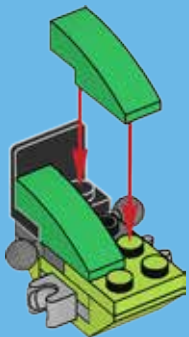

8



1

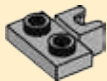

2

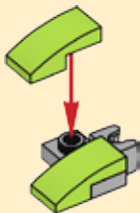

3



9

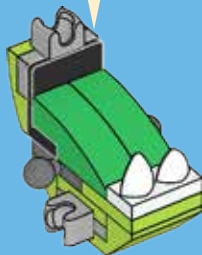

1

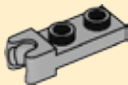

2

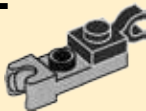

3

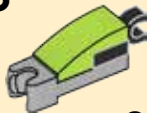

2x

10

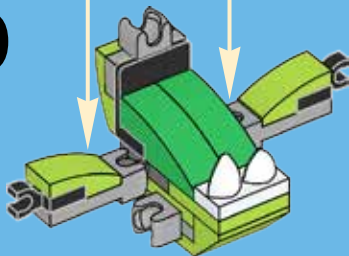

1



2

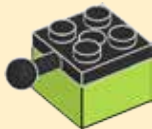

3



2x

11

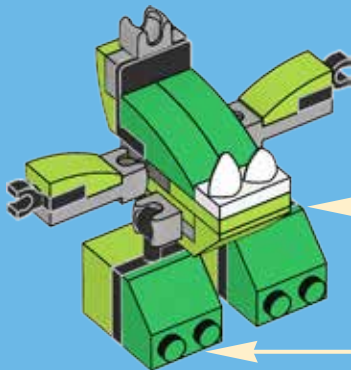



12

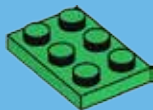

13



14

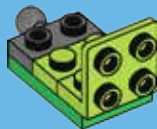



15

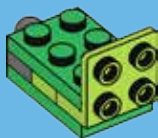

16

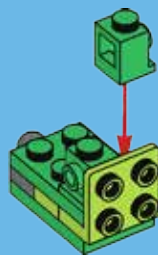

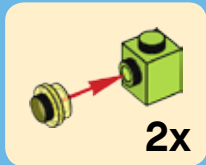

17

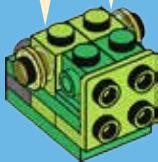

18

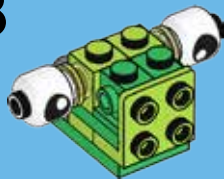



19



20

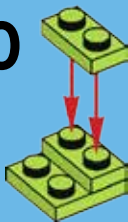

21



22

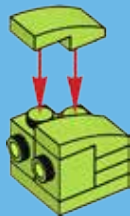

23

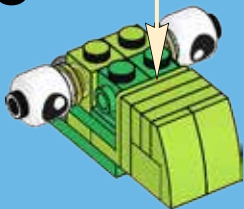

24

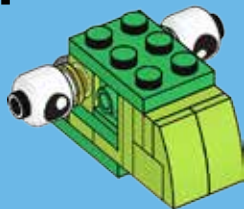

25

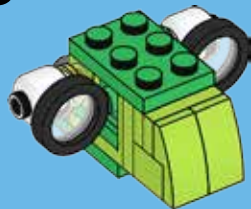

26

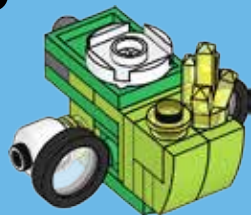

27



28

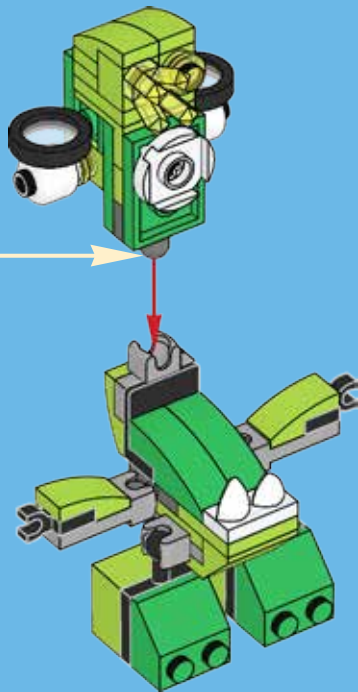

29

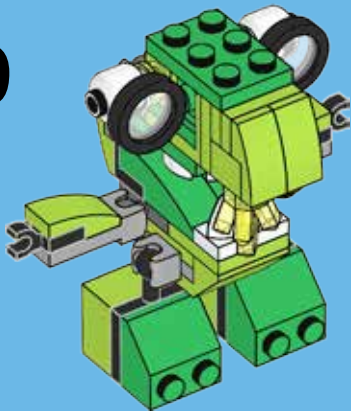



3x  
6043656



4x  
6073026



6x  
6069006



1x  
403201



2x  
4187334



2x  
6043639



2x  
4220632



3x  
4164037



2x  
6060802



2x  
303928



3x  
6039479



1x  
6110067



3x  
4537937



1x  
6046384



2x  
6039946



3x  
302128



**Customer Service**

**Kundenservice**

**Service Consommateurs**

**Servicio Al Consumidor**

**LEGO.com/service or dial**



**00800 5346 5555 :**



**1-800-422-5346 :**



1x  
6094031



2x  
4517925



1x  
6000650



2x  
6051038



2x  
6012466



3x  
3005749



1x  
4540417





**DRIBBAL  
41548**



**GLORP CORP  
MAX!**



**GURGGLE  
41549**



**SLUSHO  
41550**



[LEGO.com/mixels](http://LEGO.com/mixels)





# Mixels™



**41545  
KRAMM**



**41546  
FORX**



**41547  
WUZZO**



**41548  
DRIBBAL**



**41549  
GURGGLE**



**41550  
SLUSHO**



**41551  
SNAX**



**41552  
BERP**



**41553  
VAKA-WAKA**



[LEGO.com/mixels](http://LEGO.com/mixels)



# Mixels RUSH



**YOU CAN  
BUY THE  
GAME!**

**D R O O 1 D R A W 1**

**IN GAME CODE!**



Apple, the Apple logo, iPad, iPhone and iPod touch are trademarks of Apple Inc., registered in the U.S. and other countries. App Store is a service mark of Apple Inc. Google Play is a trademark of Google Inc.

# WIN

GO TO [WWW.LEGO.COM/PRODUCTFEEDBACK](http://WWW.LEGO.COM/PRODUCTFEEDBACK) AND  
GIVE US YOUR SHORT **FEEDBACK** ABOUT THIS  
LEGO® SET FOR A CHANCE TO WIN  
A COOL LEGO PRIZE.



## LEGO.com/productfeedback

GEWINNE



Erzähle uns auf  
[www.LEGO.com/productfeedback](http://www.LEGO.com/productfeedback)

etwas über die Erfahrungen, die  
du mit diesem LEGO® Set gemacht  
hast, und sichere dir die Chance auf  
einen coolen LEGO Preis!

GAGNE



Rends-toi sur  
[www.LEGO.com/productfeedback](http://www.LEGO.com/productfeedback)

et donne-nous quelques commen-  
taires sur ce produit LEGO® pour  
avoir une chance de gagner un  
prix LEGO !

GANA



Visita  
[www.LEGO.com/productfeedback](http://www.LEGO.com/productfeedback)

y envíanos tu opinión acerca de este  
set LEGO®. ¡Participarás en el sorteo  
de un premio LEGO!

获取奖品



登录  
[www.LEGO.com/productfeedback](http://www.LEGO.com/productfeedback)

给出关于此乐高®套装的简短反馈，  
就有机会获得炫酷乐高奖品

LEGO, the LEGO logo and MIXELS are trademarks and/or copyrights of the LEGO Group.  
©2015 The LEGO Group. All rights reserved.  
TM & © 2015 Cartoon Network

6126533