

**LEGO**

# Architecture

21036

Arc de Triomphe

Paris, France



[LEGO.com/architecture/booklet](https://www.lego.com/architecture/booklet)







## Arc de Triomphe

Located at the western end of the Champs-Élysées, the iconic Arc de Triomphe stands at the center of the Place Charles de Gaulle, also known as the “Place de l’Étoile”.

It was built between 1806 and 1836 in honor of those who had fought for France and is considered the linchpin of the historic axis (L’Axe historique) – a sequence of monuments and grand thoroughfares on a route that stretches from the courtyard of the Louvre Palace to the outskirts of Paris.



# Then and now

Commissioned by Napoléon I to commemorate his military conquests, the Arc de Triomphe was the world's largest triumphal arch when it was finally completed in 1836. Architect Jean François Thérèse Chalgrin's creation is twice the size of the ancient Roman Arch of Constantine after which it is modeled. Work on the Arch stopped when Napoléon was defeated in 1814, but started up again in 1833 in the name of King Louis-Philippe I, who dedicated it to the glory of the French armed forces.

Seen as an emblem of French patriotism, the Arc de Triomphe is engraved with the names of war victories and 558 generals (those who died at war are underlined). An Unknown Soldier is buried under the arch and an eternal flame of remembrance, lit since 1920, commemorates victims of the world wars.

Each of the Arc's pillars is adorned with one of four large sculptural reliefs: The Departure of the Volunteers in 1792 (aka La Marseillaise), Napoléon's Triumph of 1810, Resistance of 1814 and Peace of 1815. The simple design and immense size of the Arc de Triomphe are typical of late 18th-century romantic neoclassicism.

The observation deck at the top of the Arch still offers some of the best views in Paris. At the summit of 284 steps, you can see much of the city and take in the spectacular panoramas of La Défense, the Champs Elysées and the Sacré Coeur. On national holidays like Armistice Day and Bastille Day, the decorated Arc de Triomphe always features at the beginning or end of the parade or celebration.





# The architects and design history



In March 1806, architect Jean-Francois-Therese Chalgrin (1739-1811) was given the task of finding the best possible location for a “triumphal arch” in Paris. He studied several different options and on May 9th, Napoleon agreed to the site: Place de l'Etoile.

Chalgrin was then tasked with designing and constructing the Arch itself, and on August 15th, 1806 the first stone was laid to coincide with Napoleon's birthday. Chalgrin was able to see his drawings brought to life when a wood and painted canvas replica of the Arch was constructed exactly the same

as it was to be built. This allowed the architect to make some last minute changes after seeing what it would look like.

After the unfortunate death of Chalgrin in 1811, the work was taken over by Louis-Robert Goust (1762-1838) who had been a pupil of Chalgrin. The construction of the arch was disrupted and eventually halted in April 1814 by the defeat of Napoleon and subsequent decades of political turmoil. In 1832 the architect Guillaume-Abel Blouet (1795-1853) took over the project and the Arch was eventually completed in 1836. Blouet is the architect actually credited on the monument itself.

While the Neoclassical version of ancient Roman architecture was Chalgrin's design, the main sculptures, treated as independent trophies applied to the vast masonry edifice, were created by many of the most renowned French artists of the day such as Jean-Pierre Cordot, François Rude, Antoine Étex, James Pradier and Philippe Lemaire.













*"You will return home through  
arches of triumph"*

Napoleon to his troops after  
the victory at Austerlitz, 1805







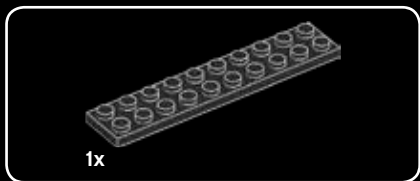

1

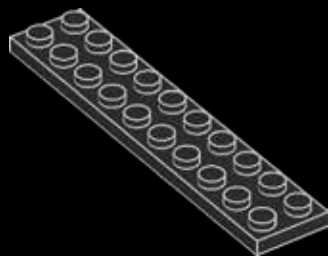

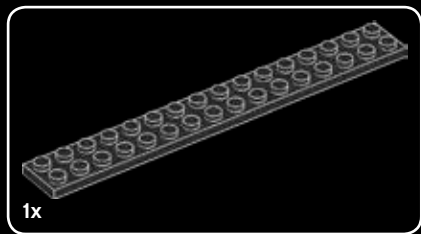

2

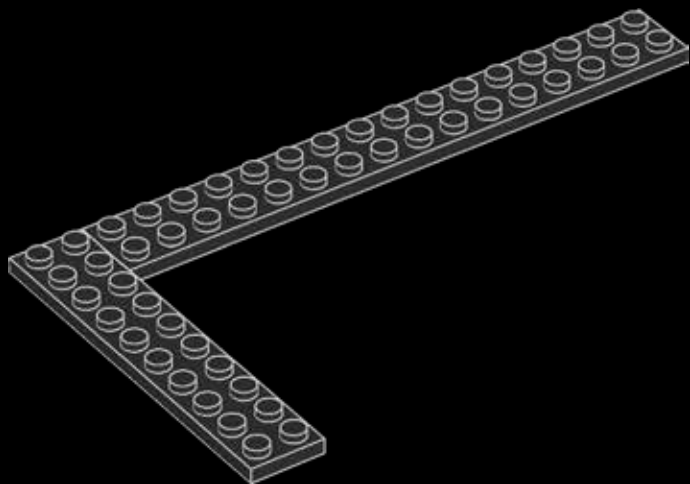

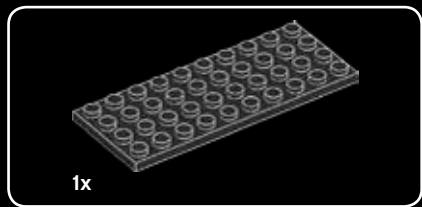

**3**

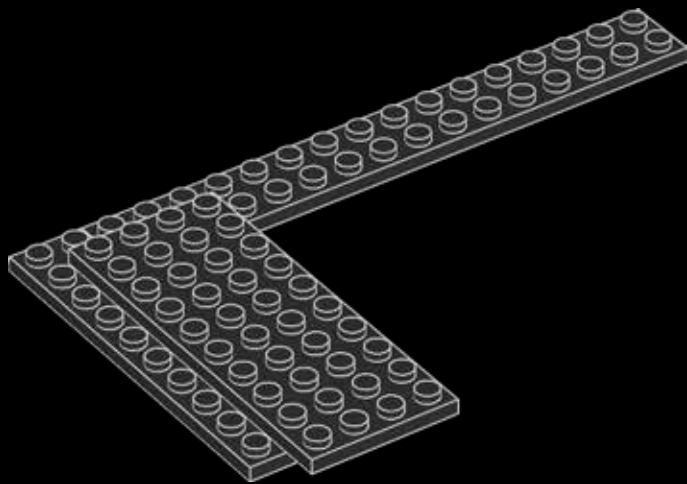

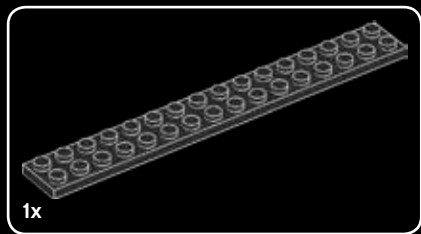

4

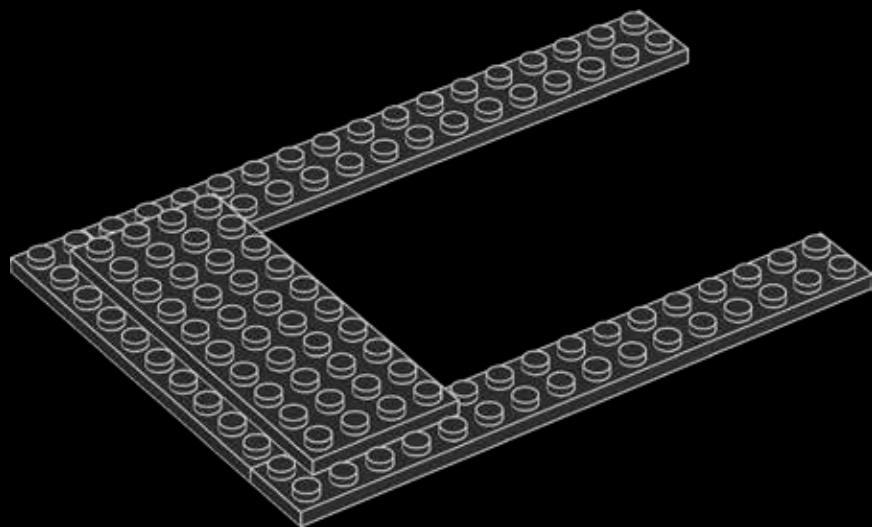

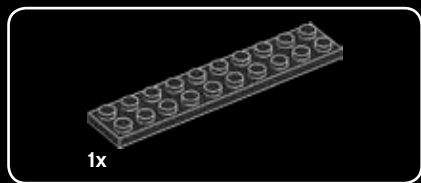

5

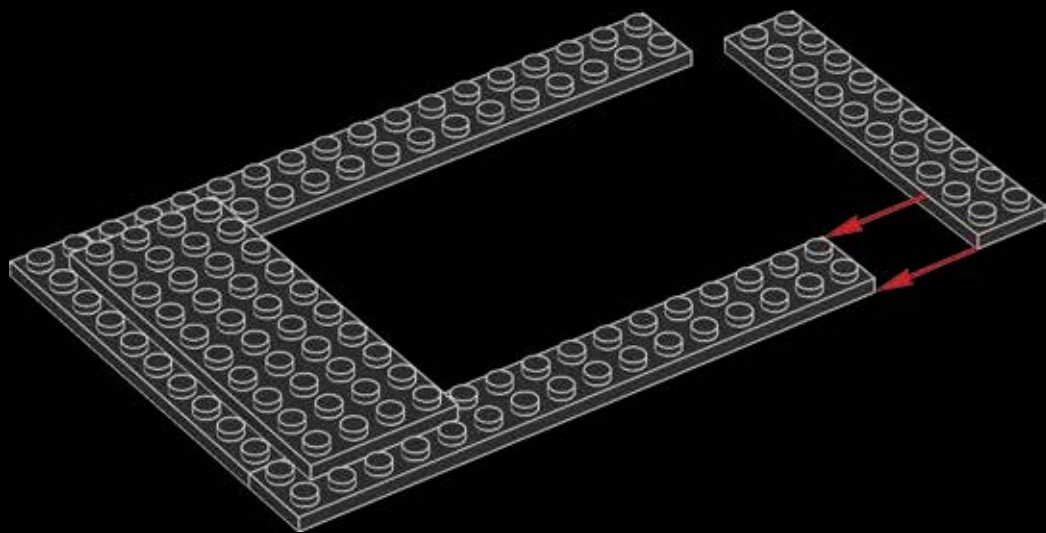

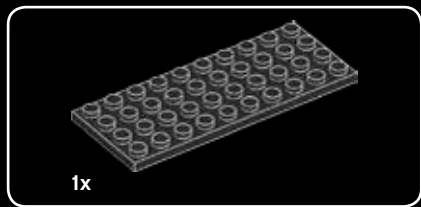

6

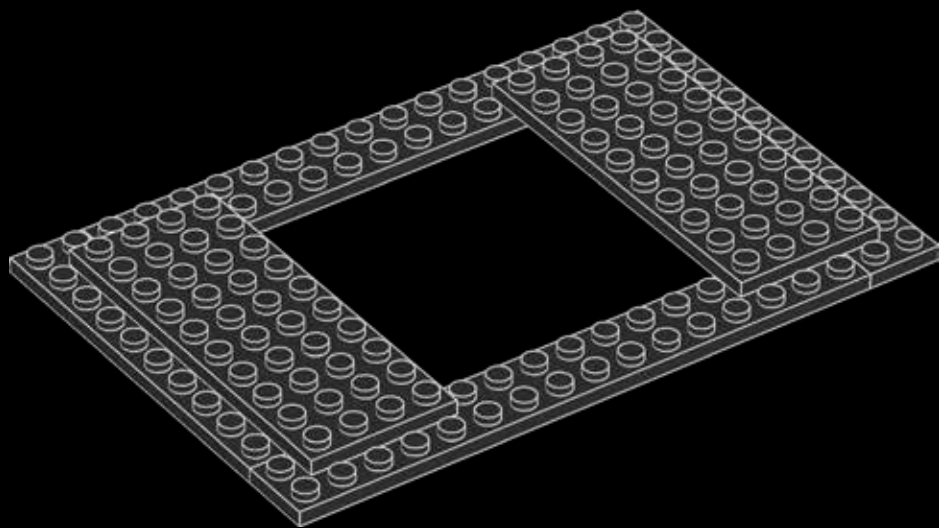



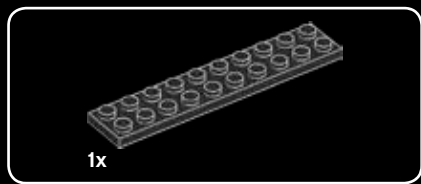

7

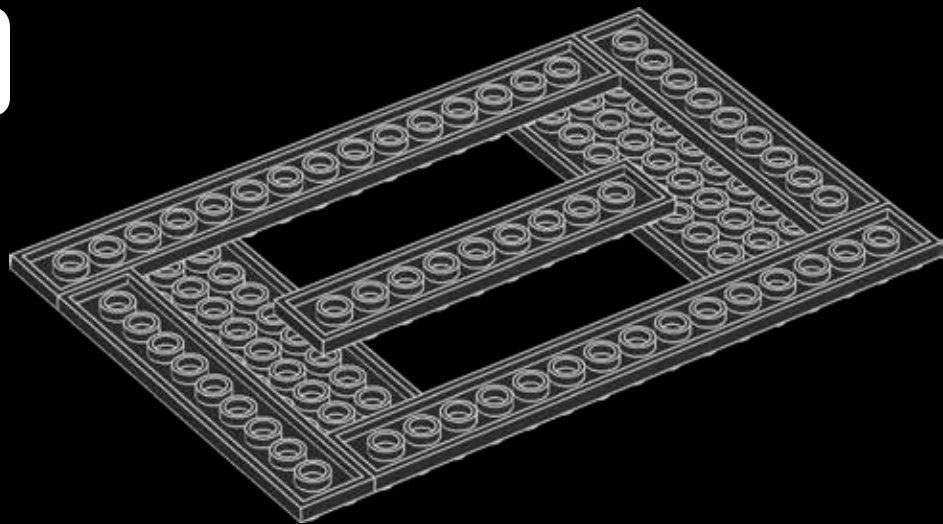

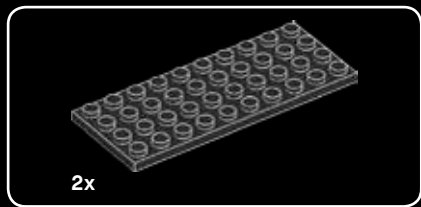

8

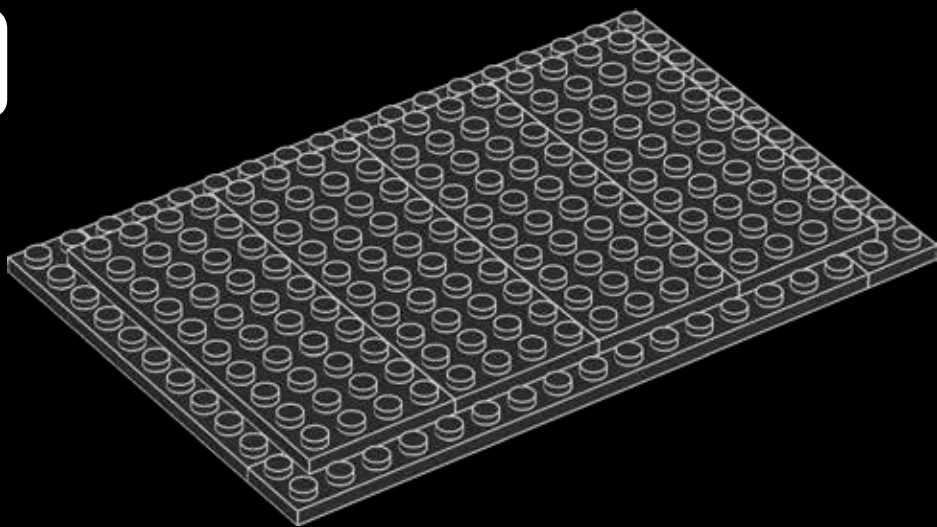



Pedestrian tunnels under the heavily trafficked intersection offer visitors safe access to the monument.



9

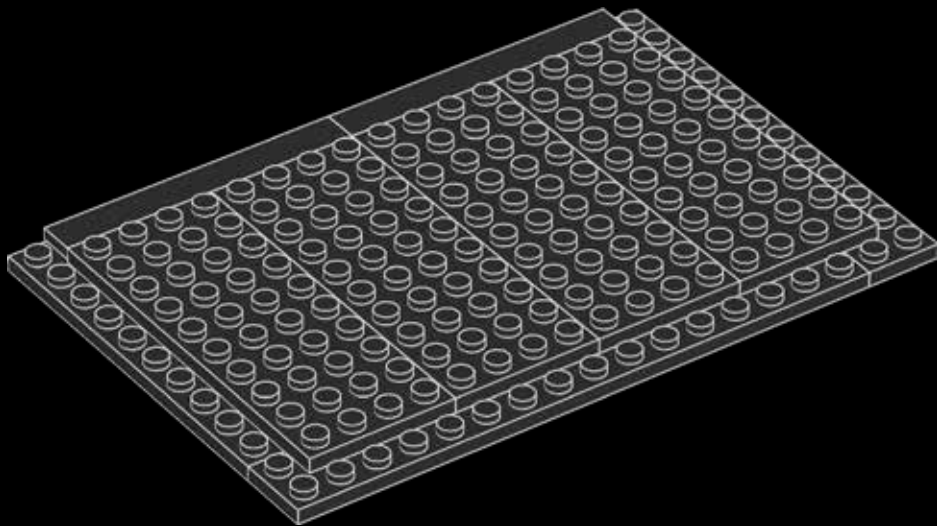

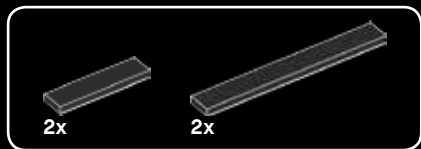

10

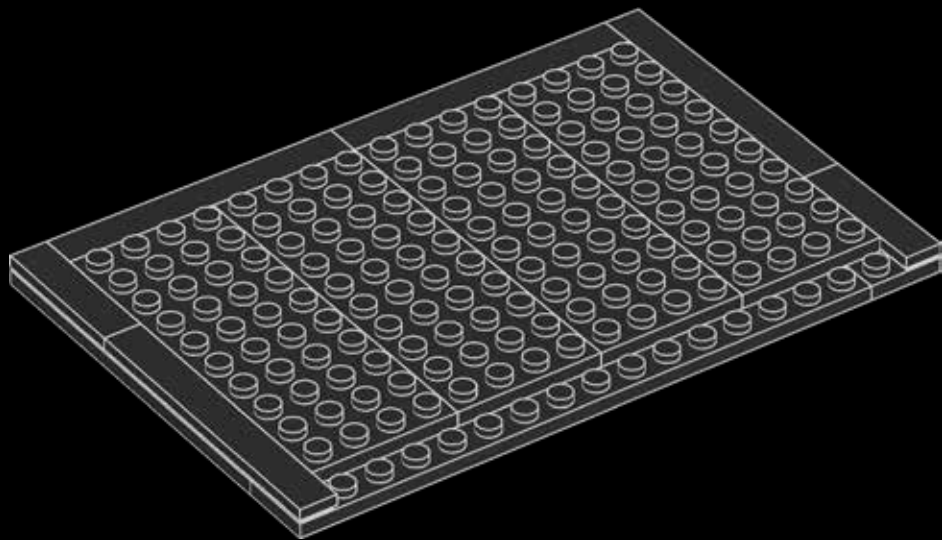

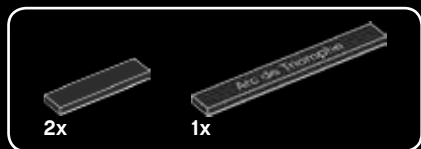

11

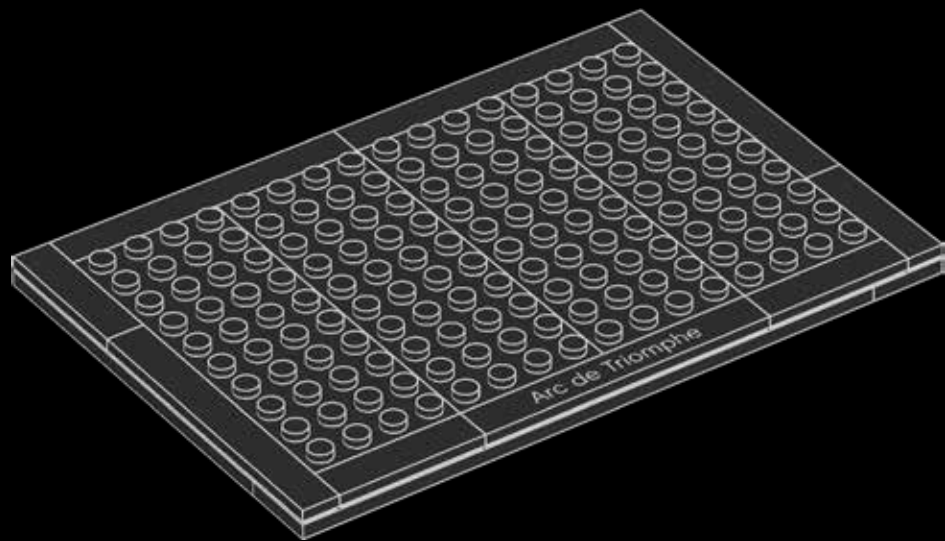



8x

12

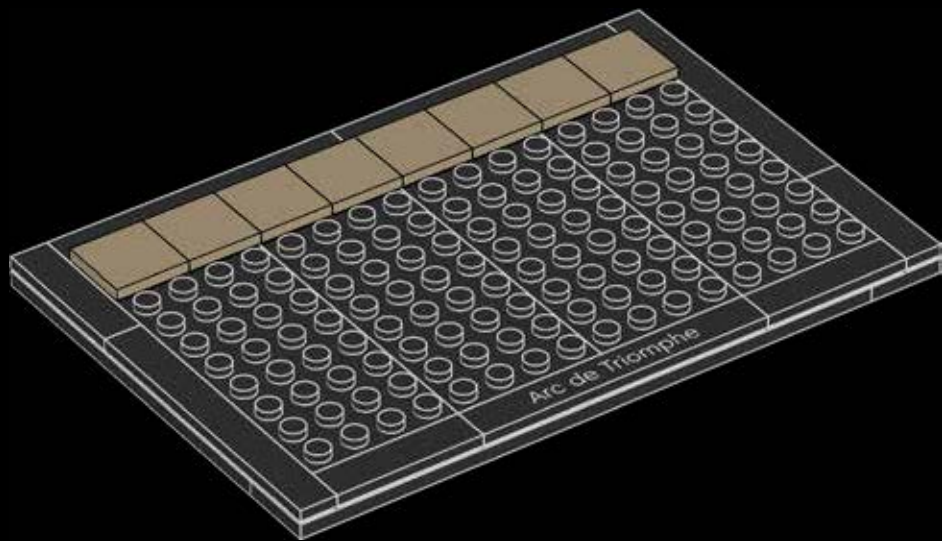





4x



2x



4x

# 13

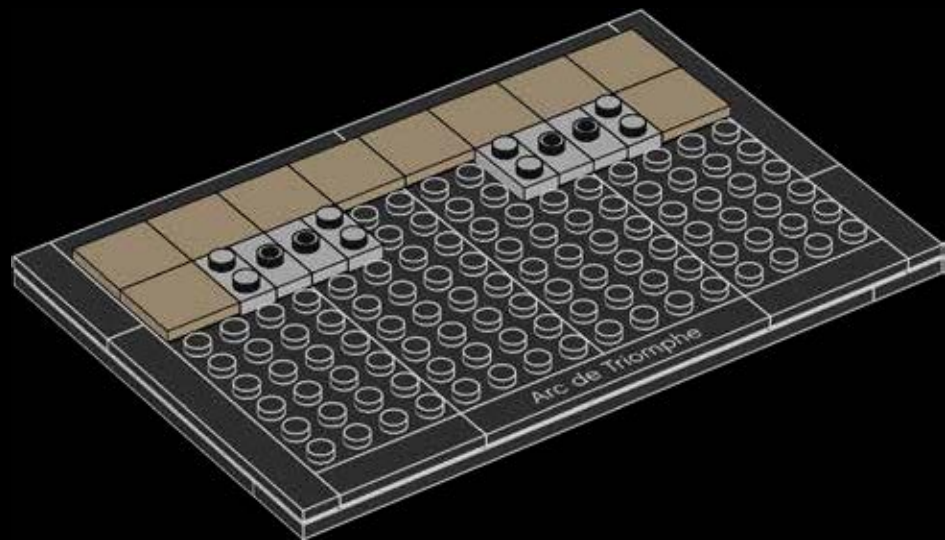



1x



2x



2x

# 14

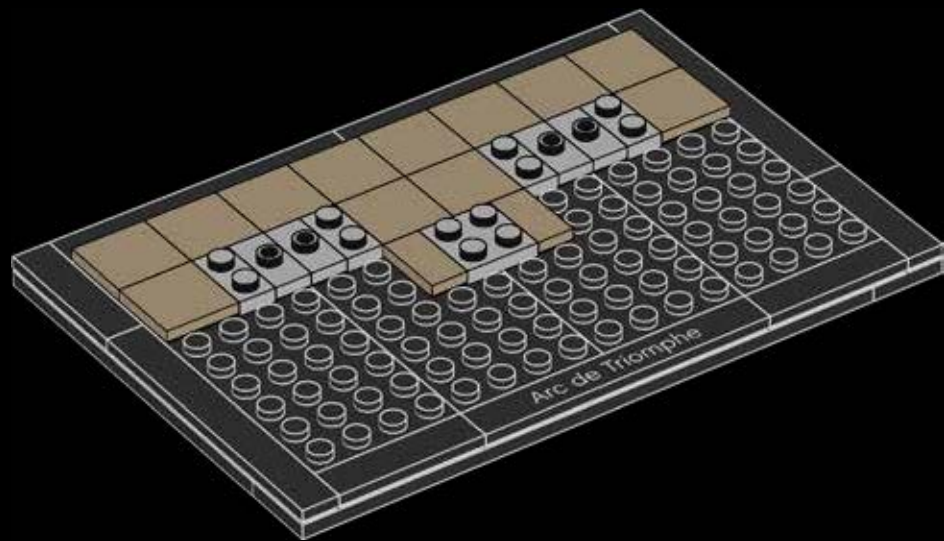



6x

15

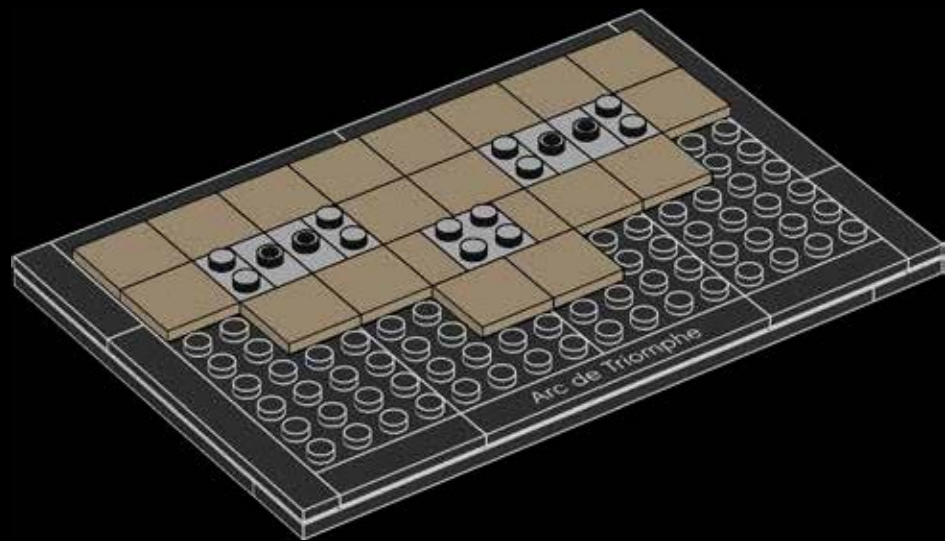



4x



4x

# 16

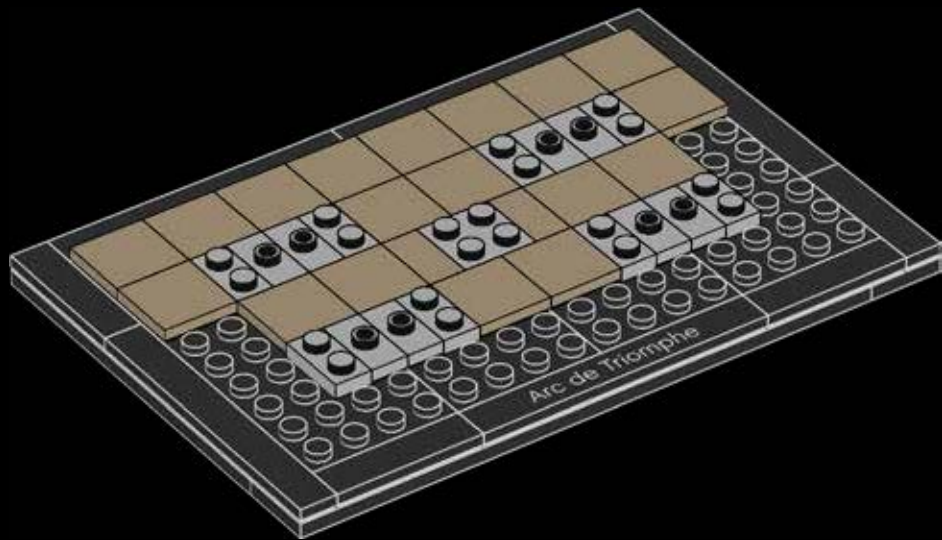



12x

17

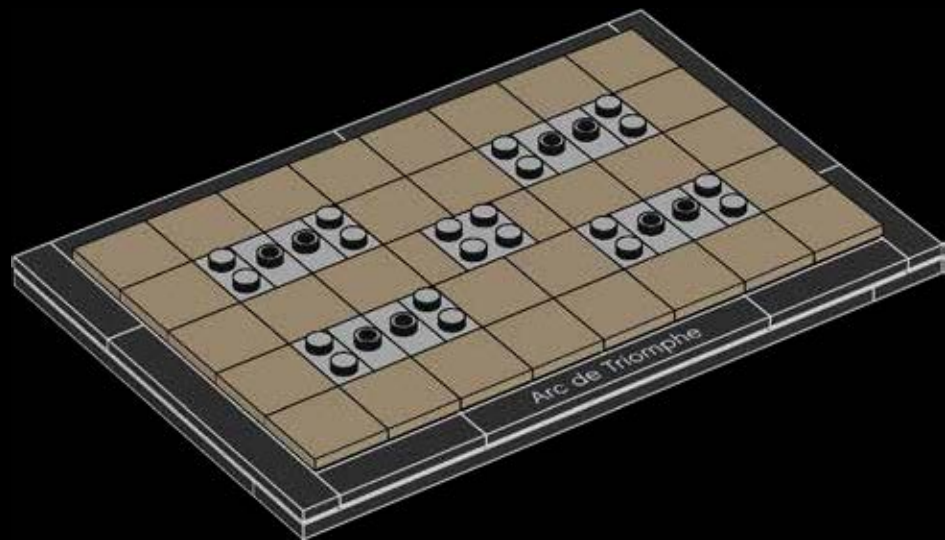

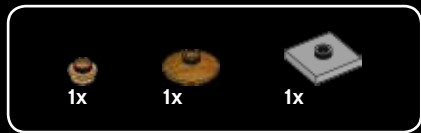

18

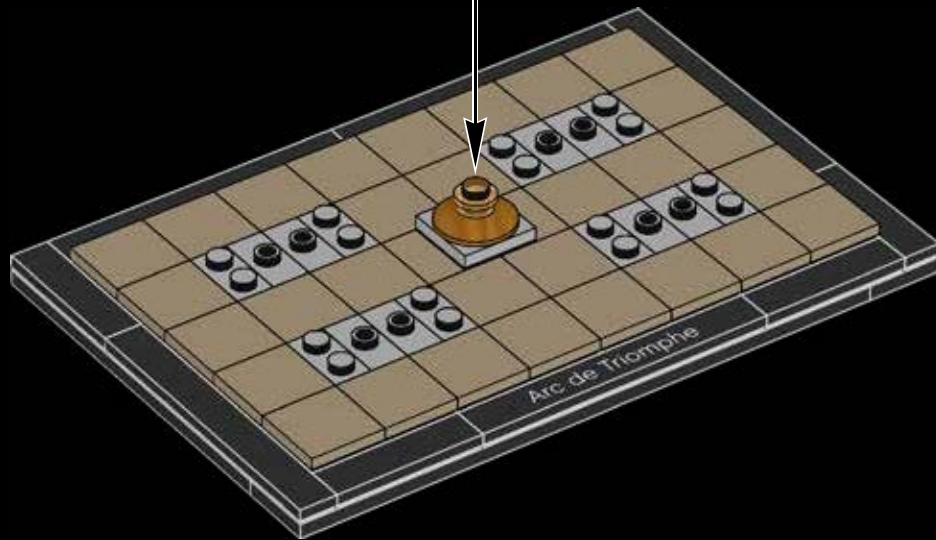
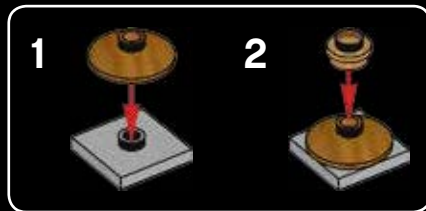



19

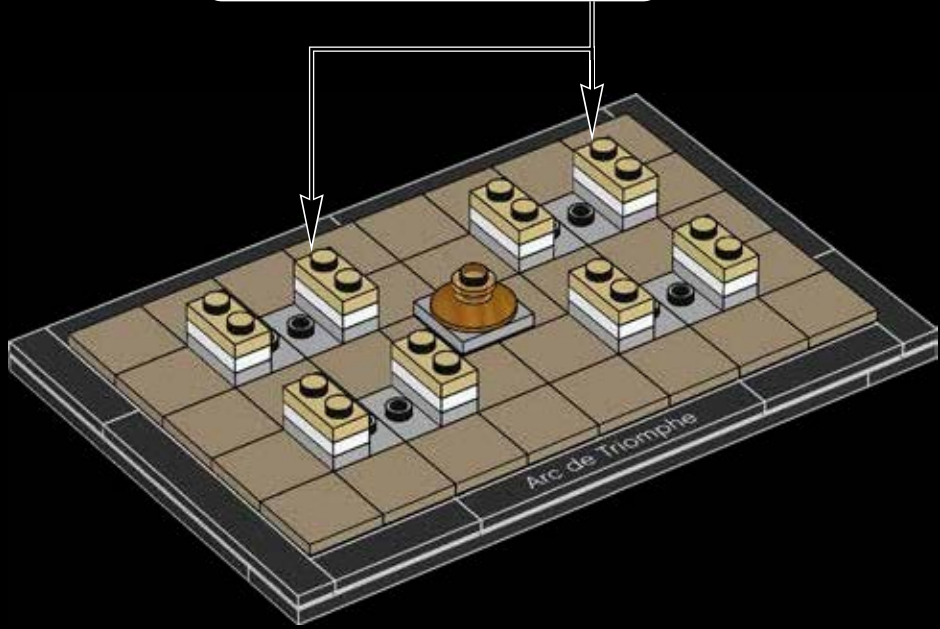
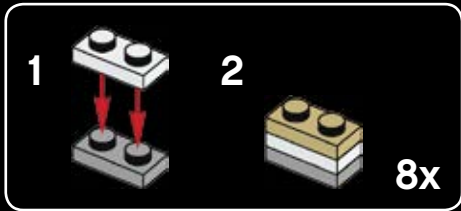

Every year, on 11 November, a ceremony is held in commemoration of the anniversary of the Armistice of Compiègne, which was signed between France and Germany in 1918.





4x



4x



4x



4x



4x



8x



4x



4x



4x



4x



4x

20

1



2



3

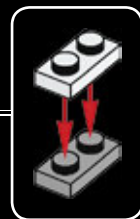



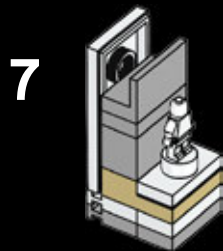
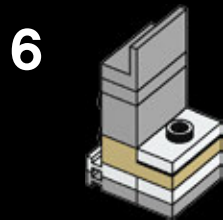
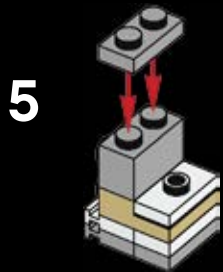
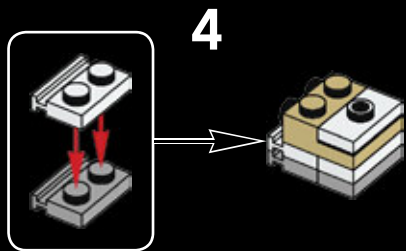

4x

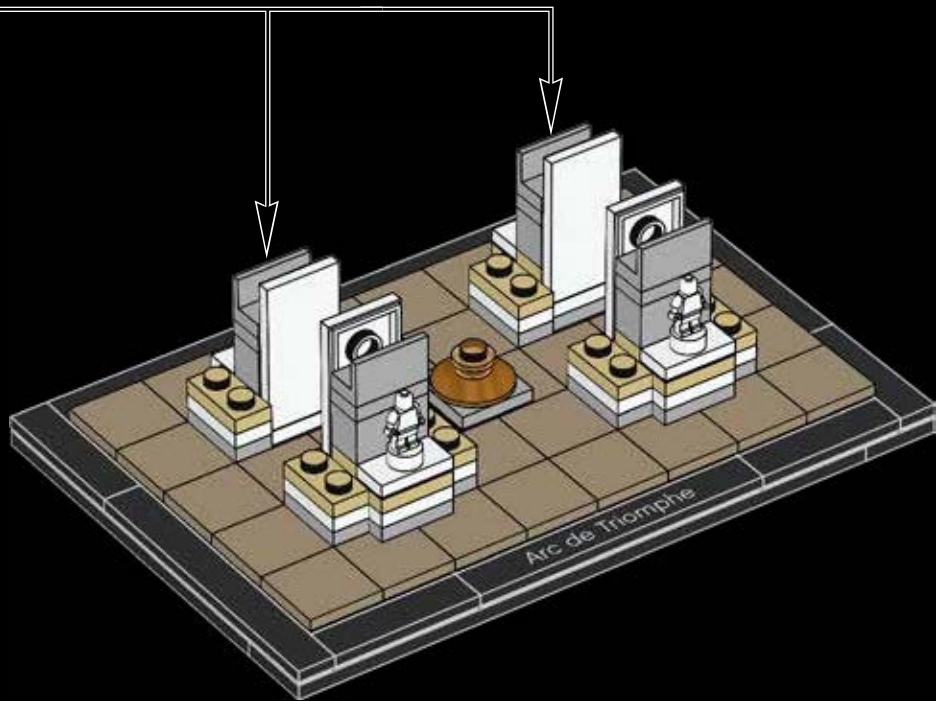



8x

21

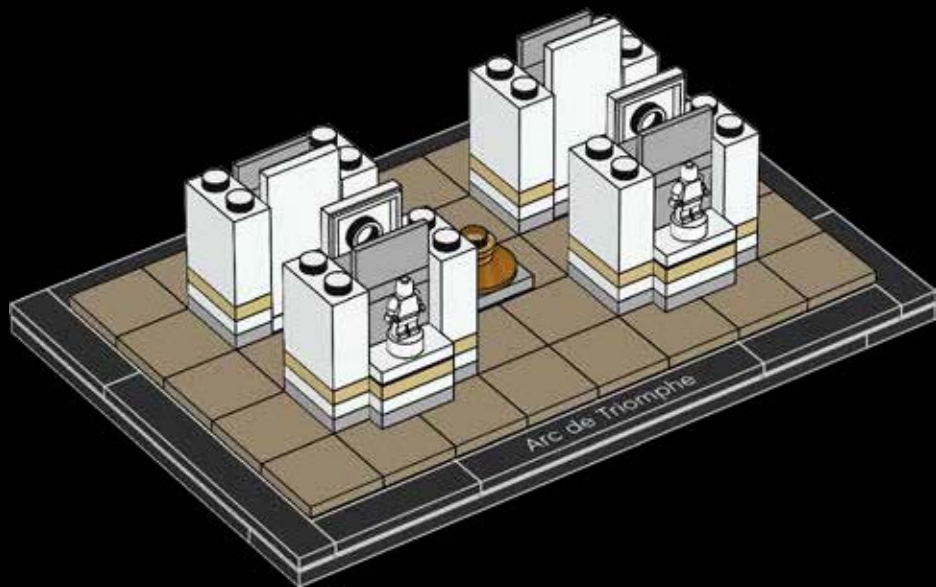



8x

22





23

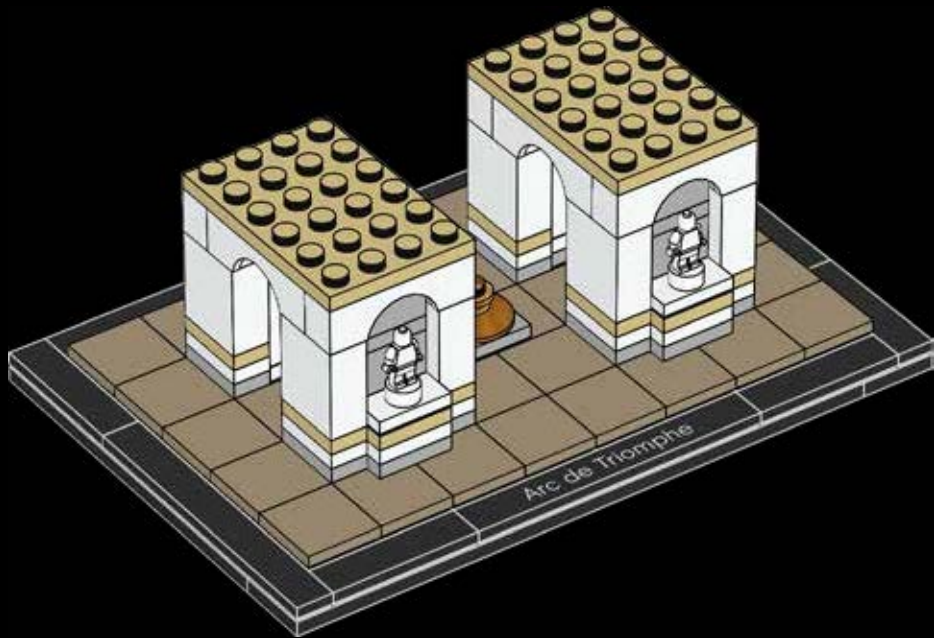

Over 600,000 people  
visit the Arc de Triomphe  
every year.





4x



2x

24





2x



4x

# 25



The Arc de Triomphe cost 9.3 million French francs to complete, a huge amount of money at that time.





4x

26

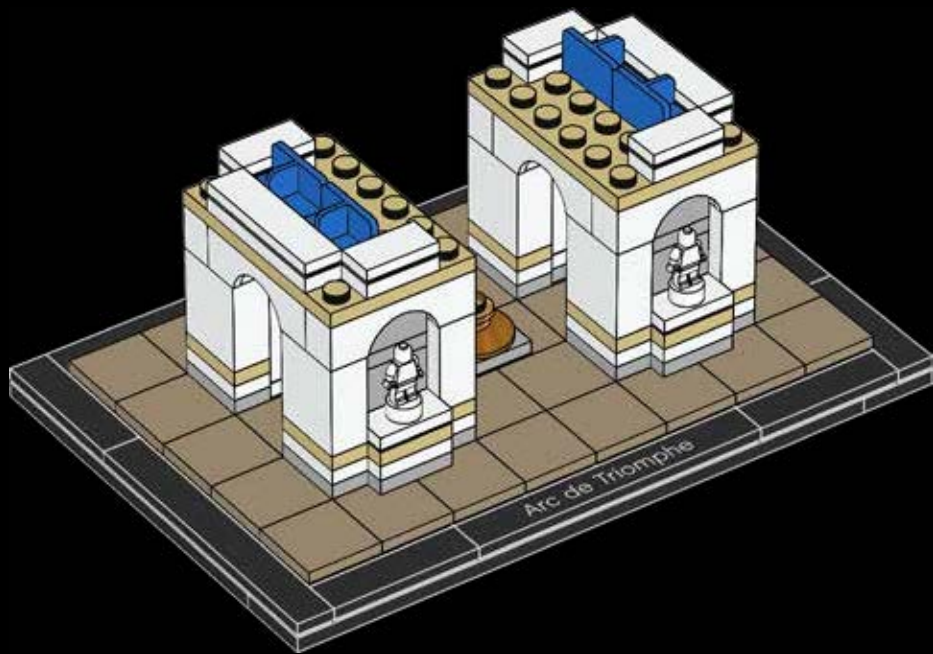





8x

27



4x





6x

28

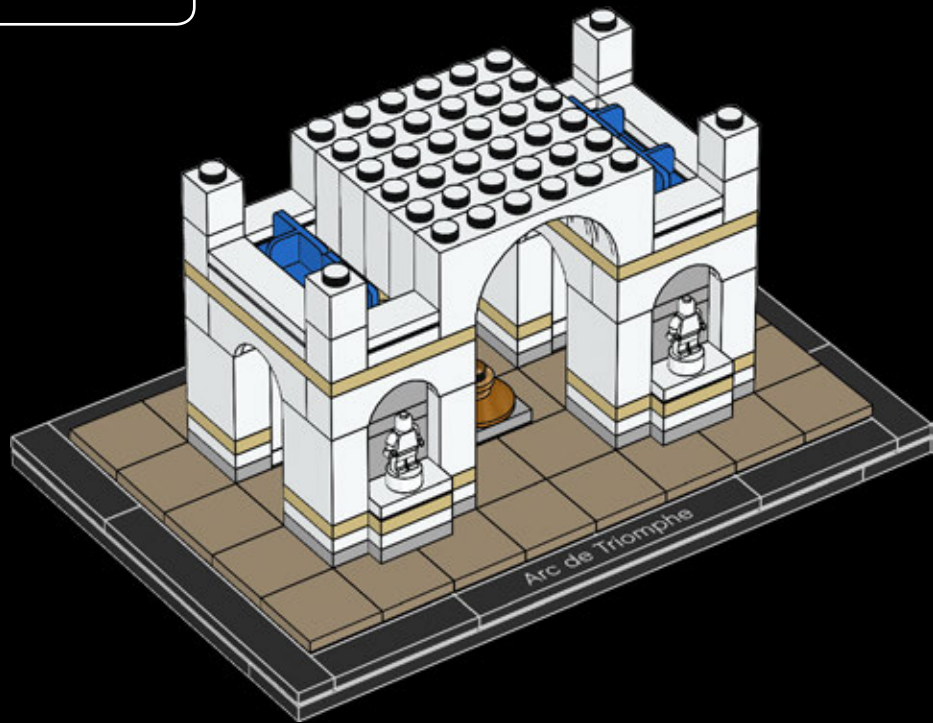



2x



4x



8x



8x



2x



2x

29

1

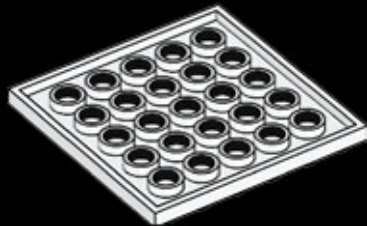

2



3

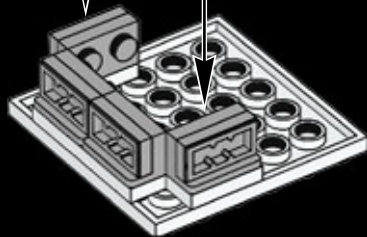
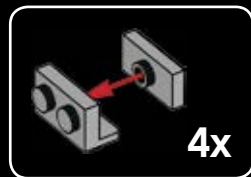

2x

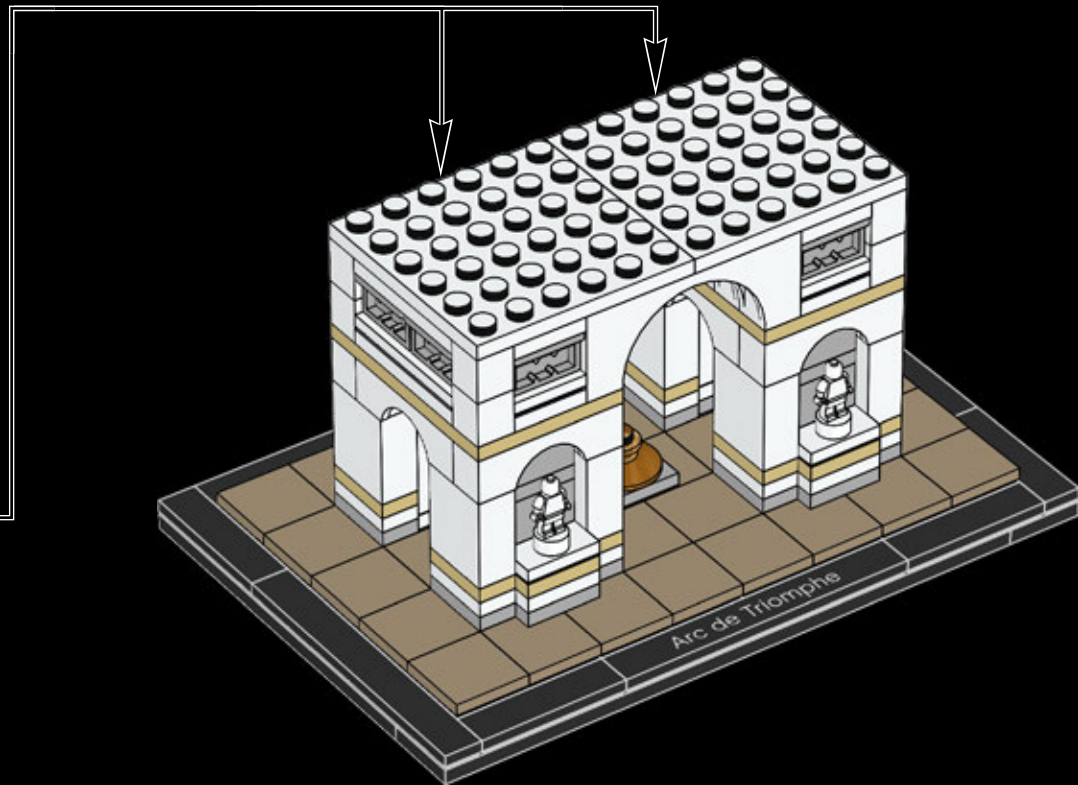

Arc de Triomphe



1x



4x

30

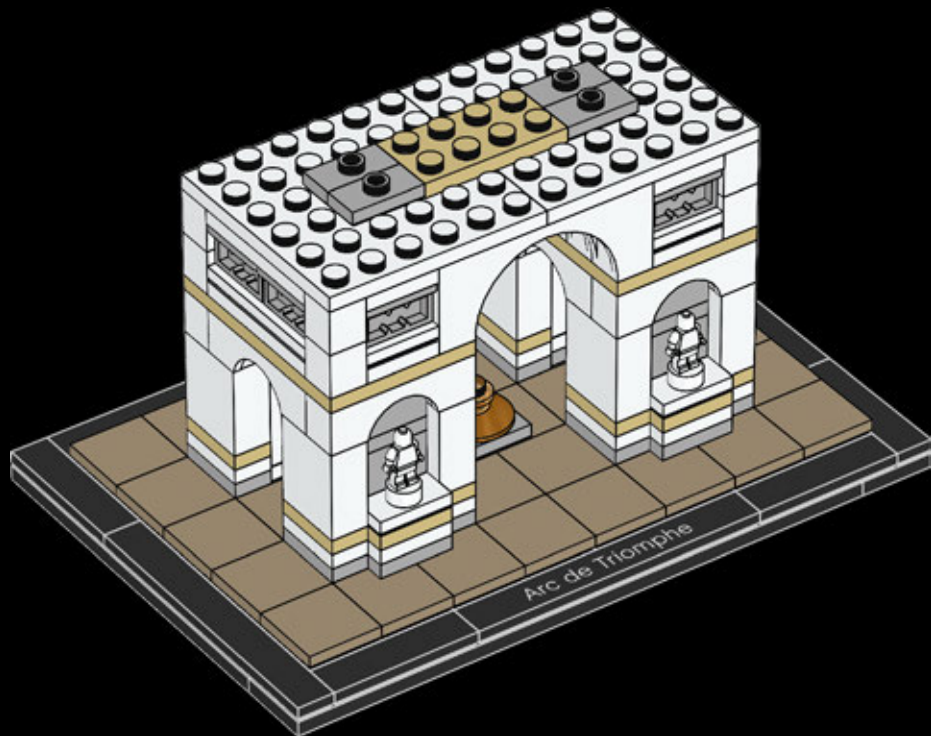



31





2x



4x



4x



4x



4x



2x

# 32

1

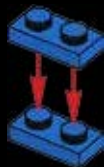

2



3







4

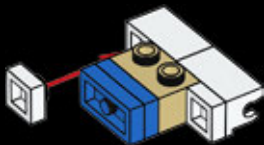

5

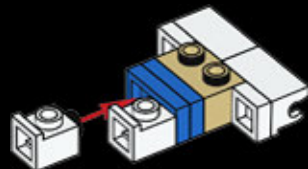

2x

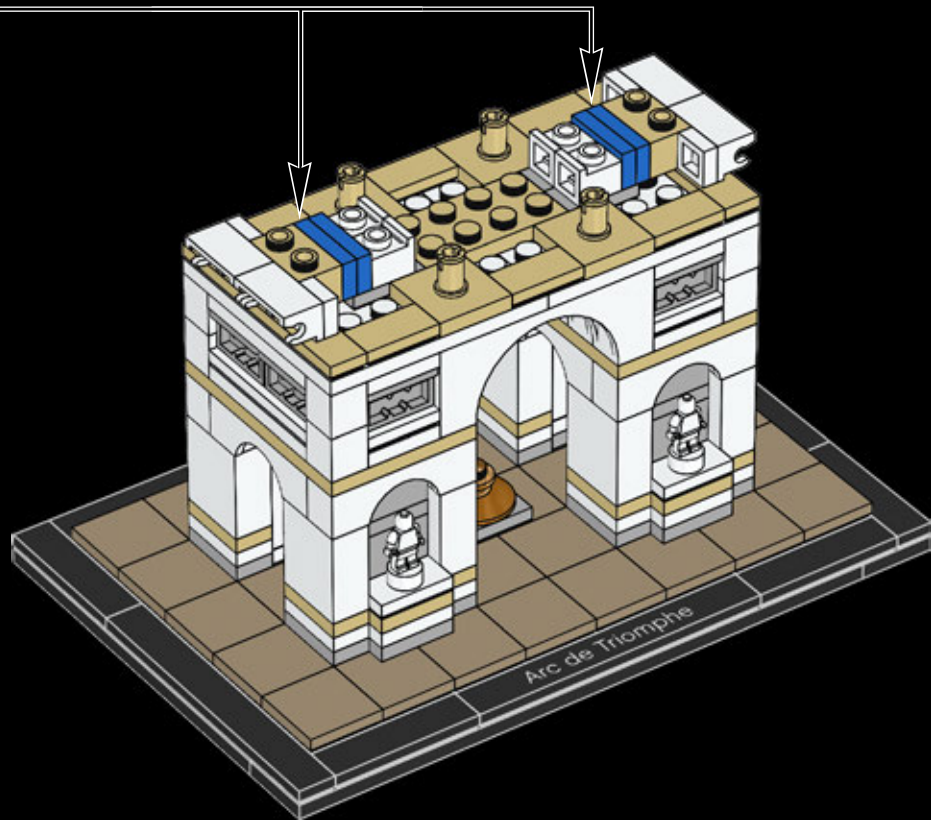

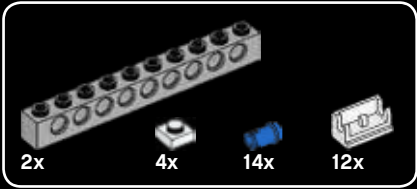

33

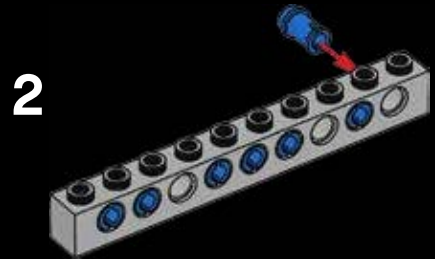
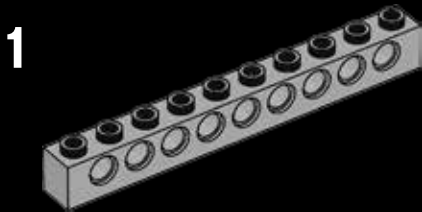

3

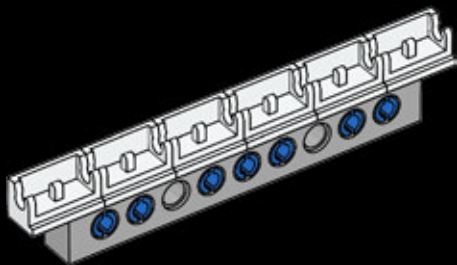

4

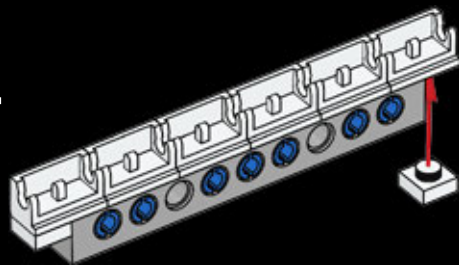

2x

Napoleon's final defeat at Waterloo is not included in the list of battles commemorated on the Arch.

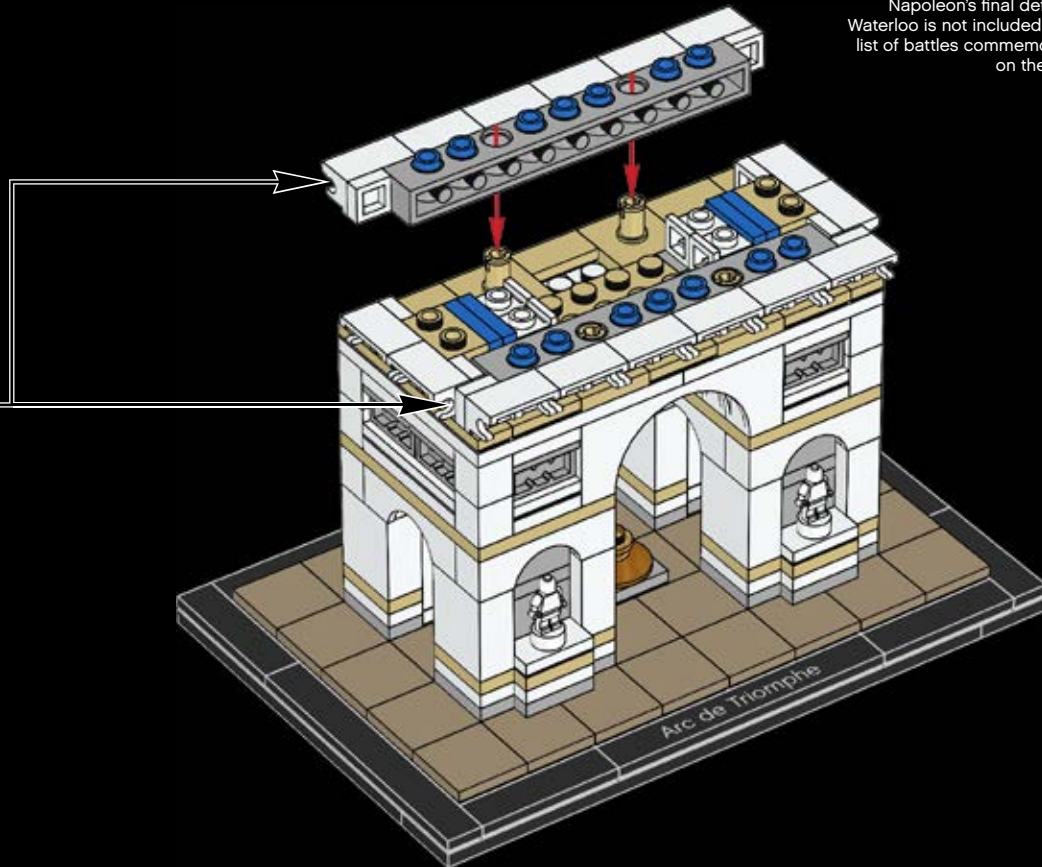

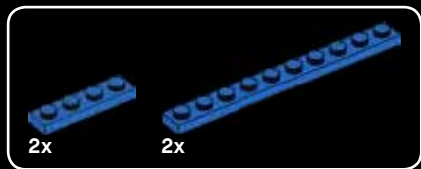

34

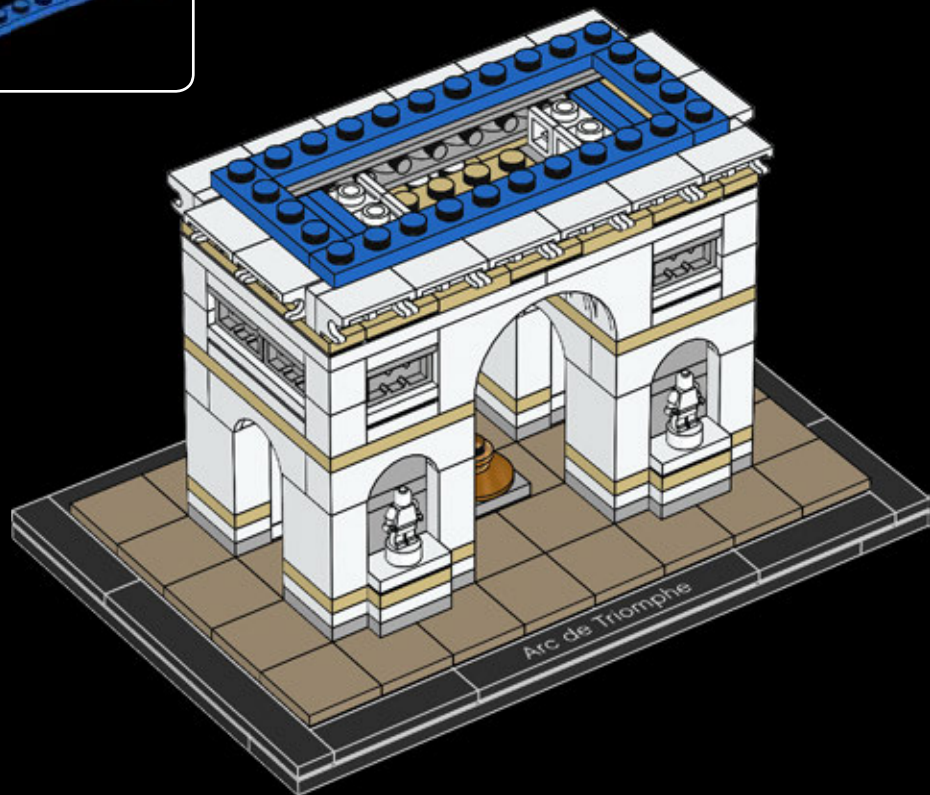

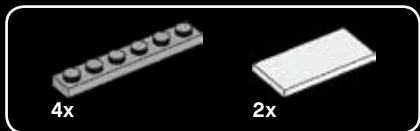

35

1



2



3

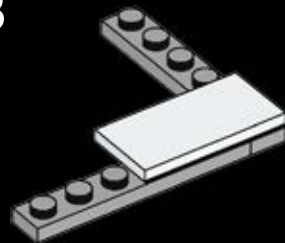

2x

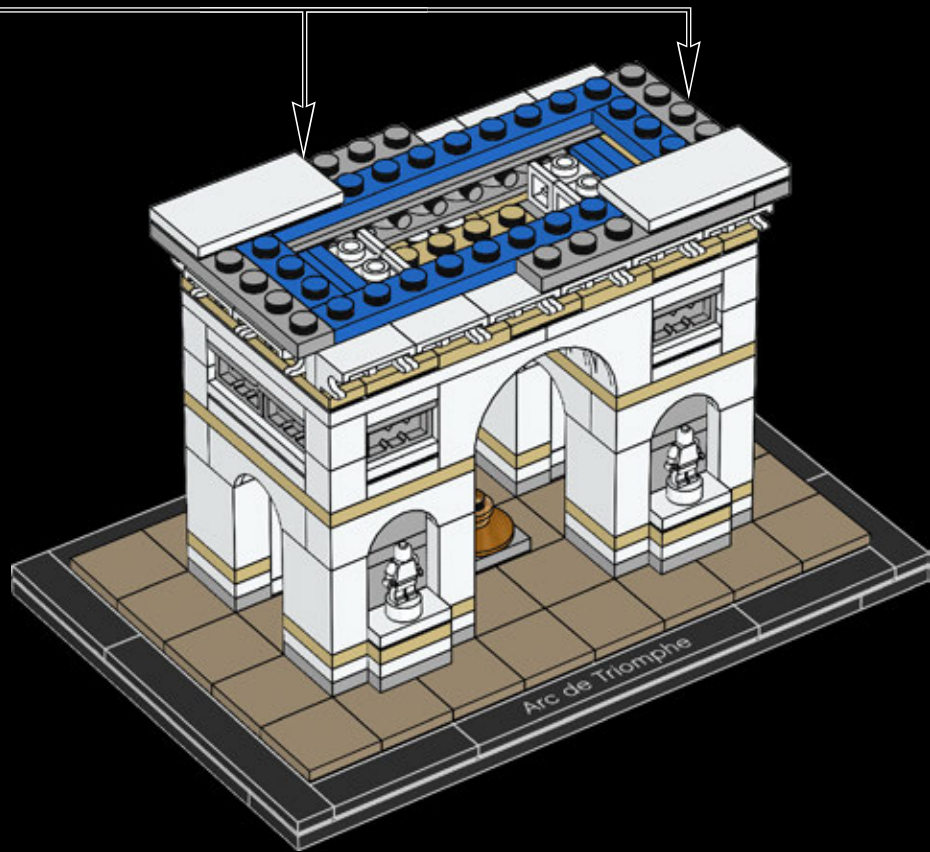



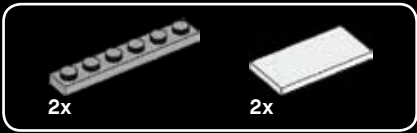

36

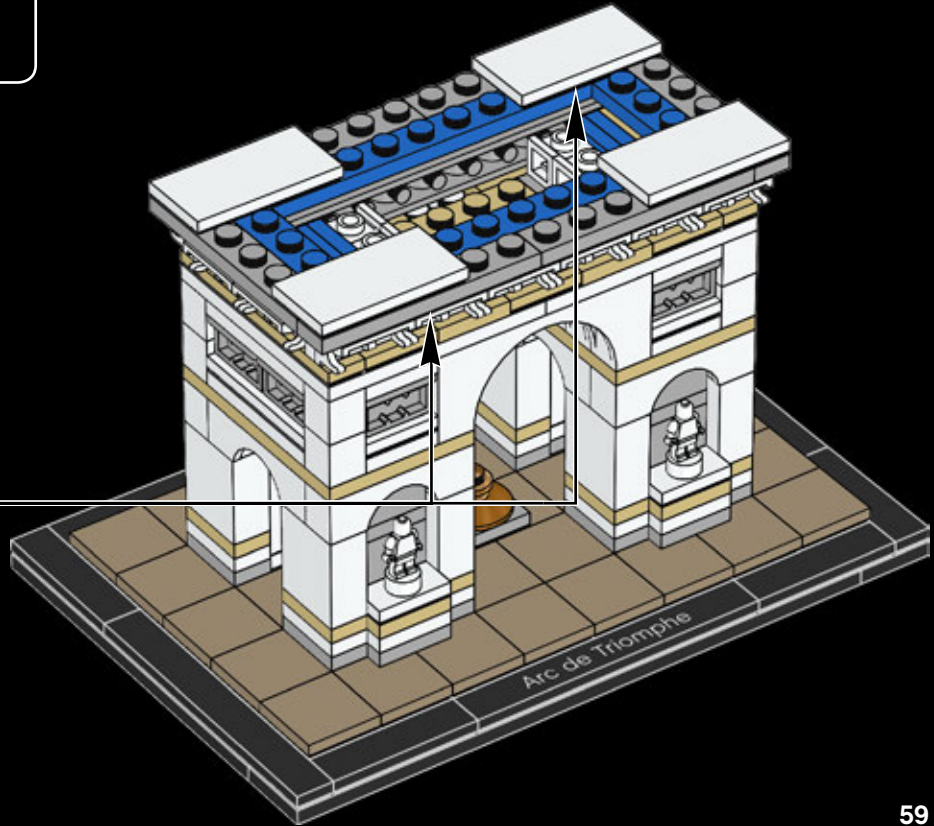
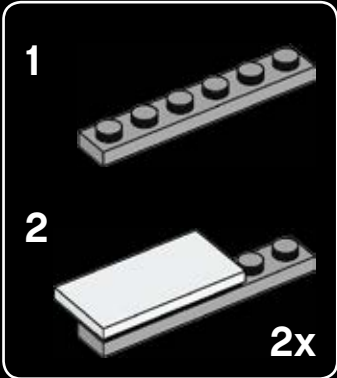



2x



4x

37



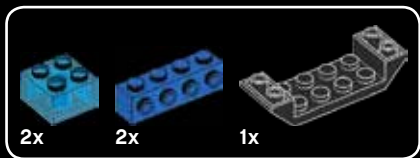

38

1

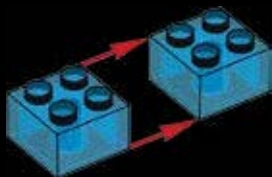

2

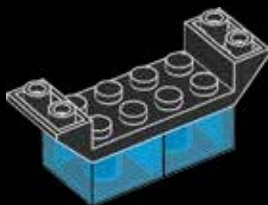

3



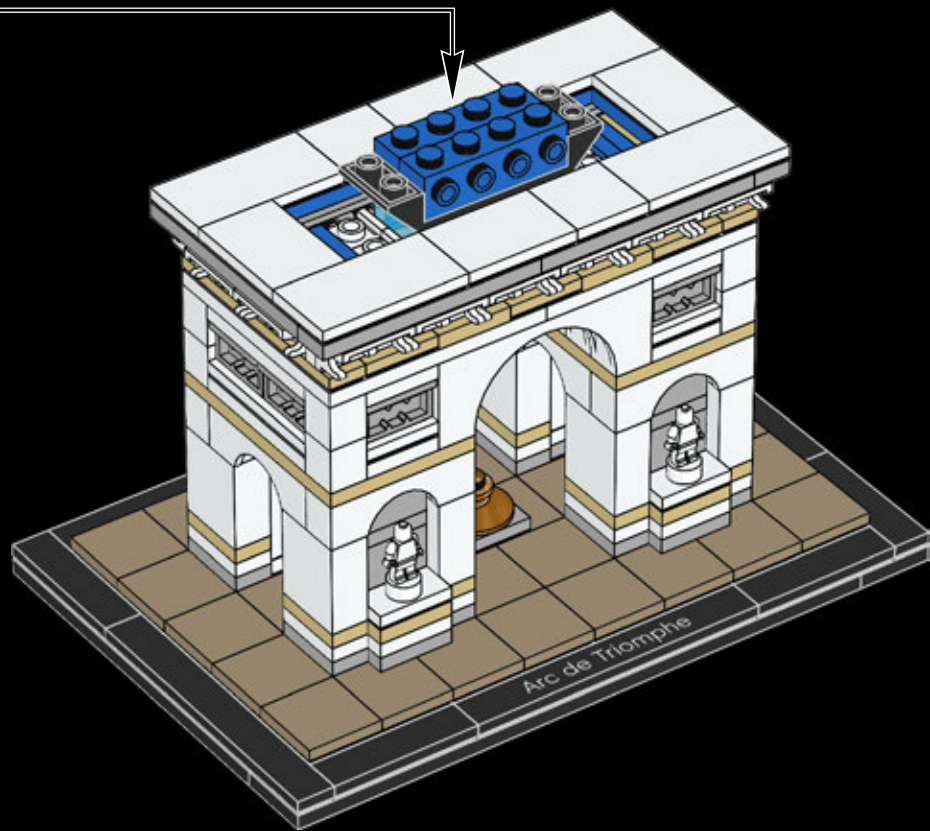



# 39

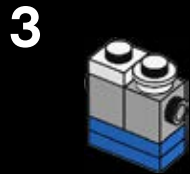
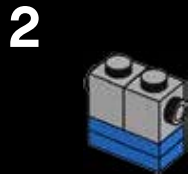
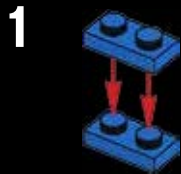

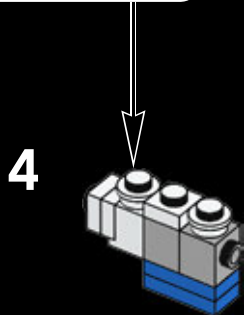
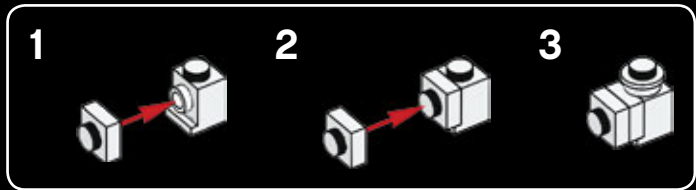

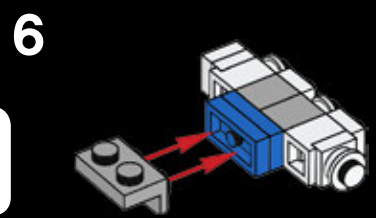
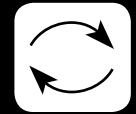
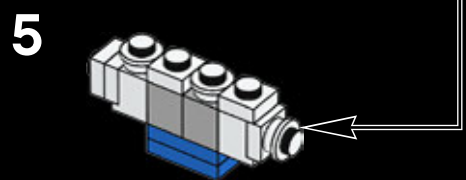
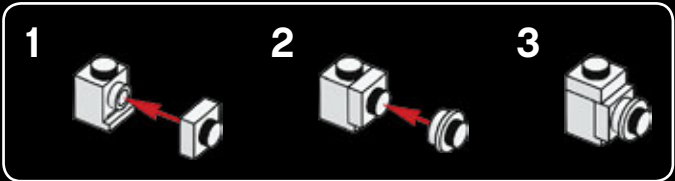

2x  
65

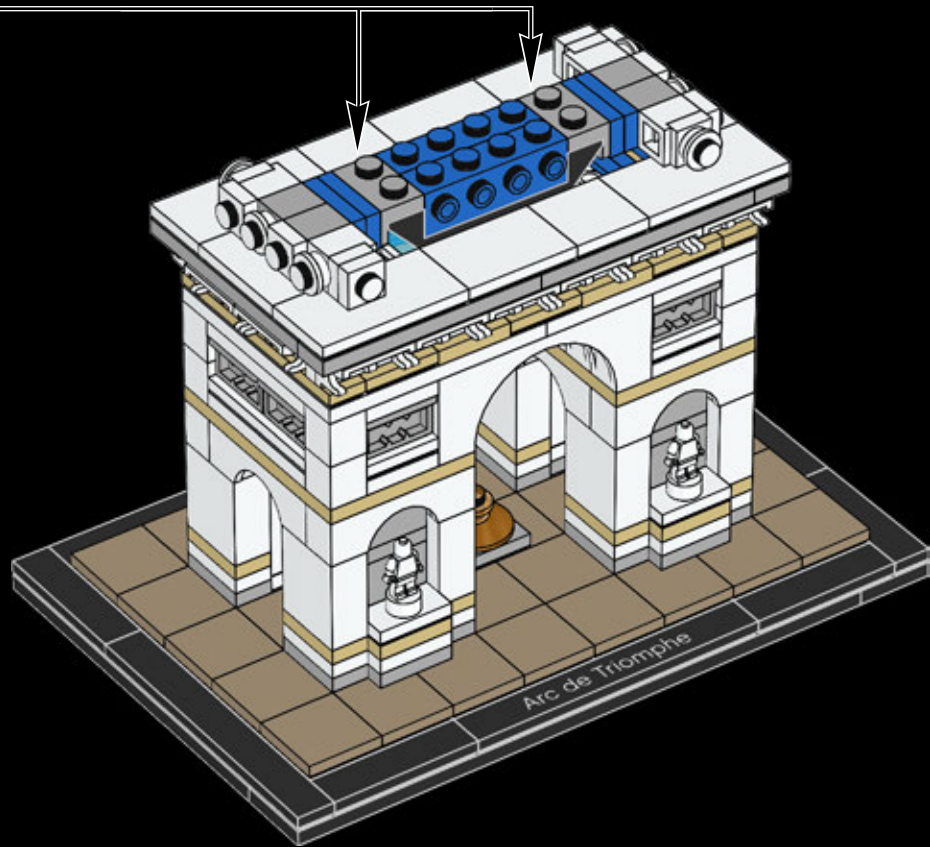



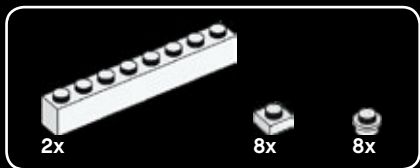

40

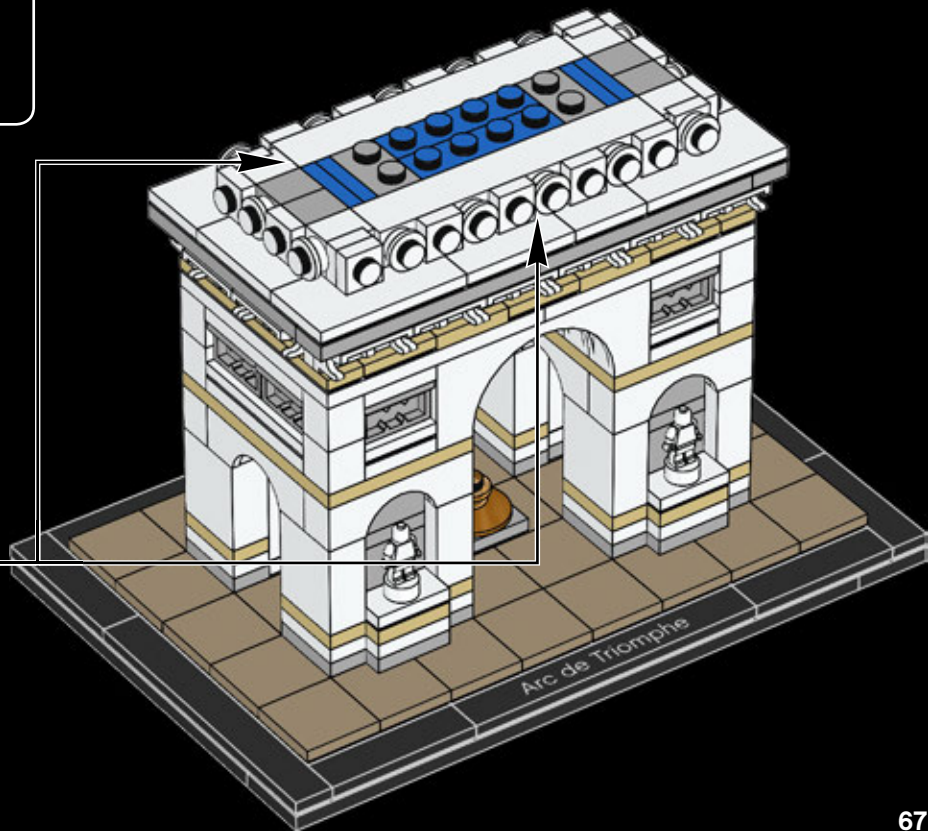
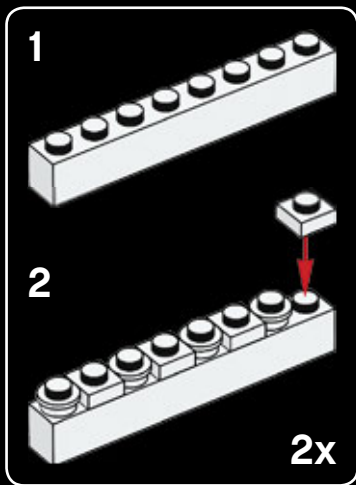

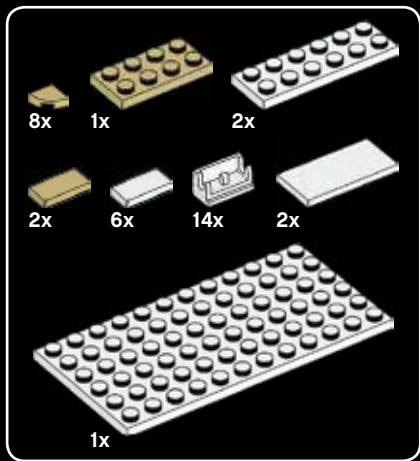
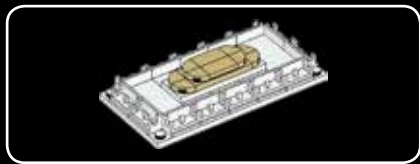

41

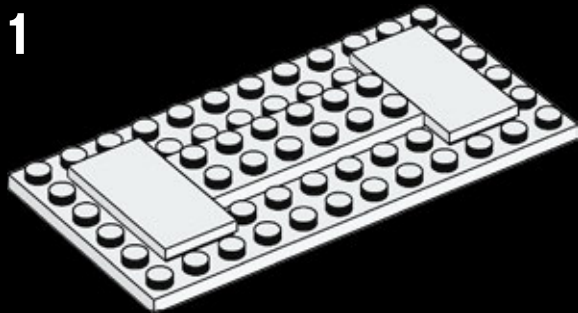

2

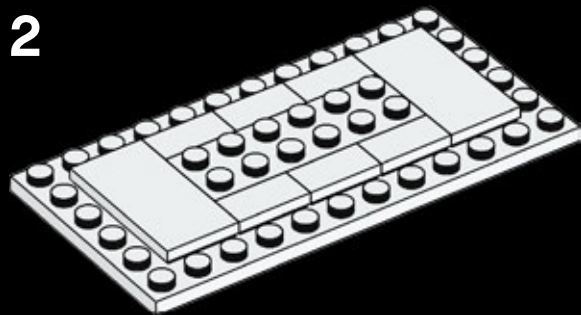

3

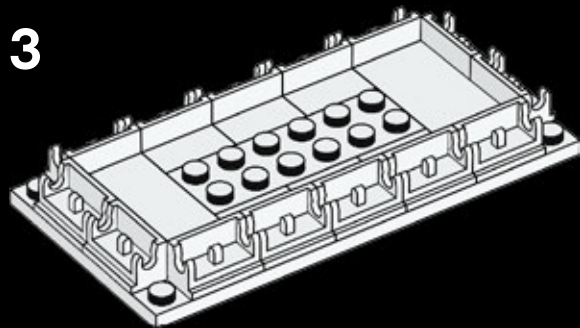

1



2



3



4

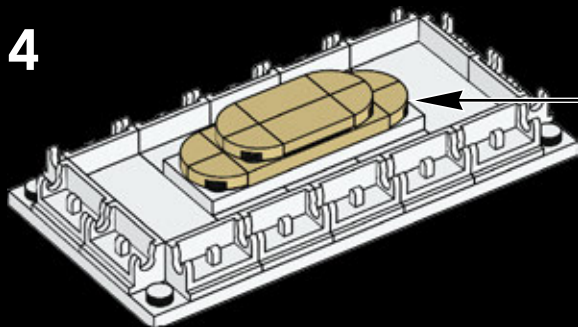

The Arc de Triomphe remains the second largest triumphal arch in the world.

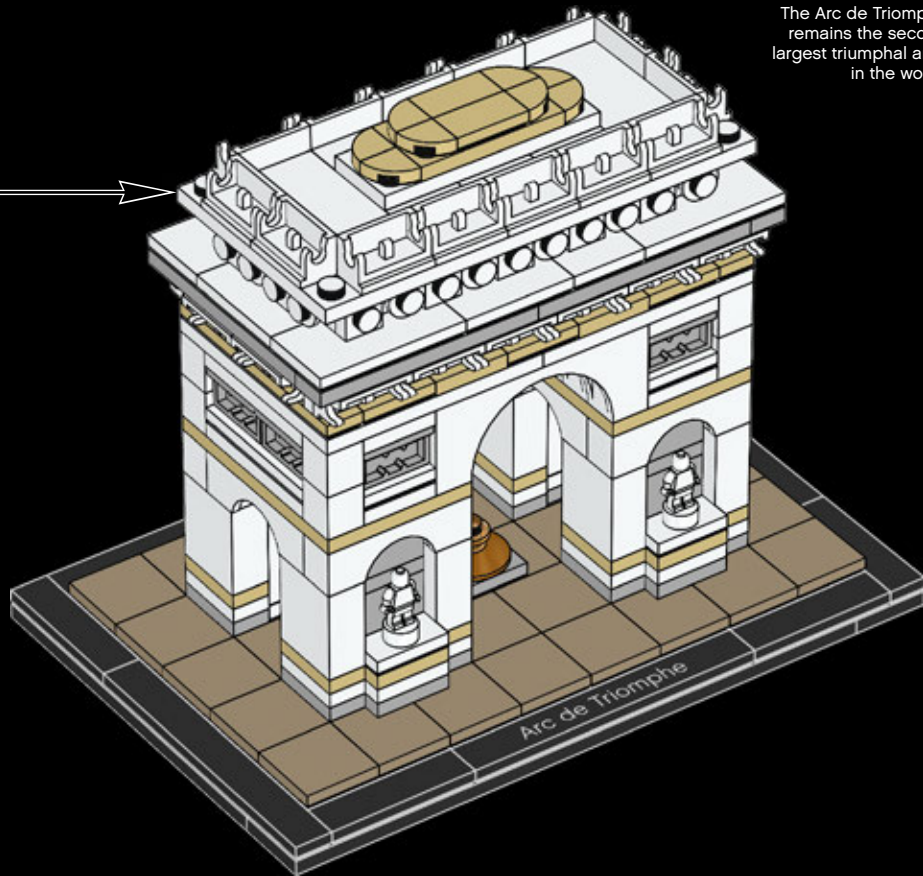





# LEGO® Architecture – do you like it?

The LEGO Group would like your opinion on the new product you have just purchased. Your feedback will help shape the future development of this product series. Please visit:

**[LEGO.com/productsurvey](https://www.lego.com/productsurvey)**

By completing our short feedback survey, you will be automatically entered into a drawing to win a LEGO® prize.



See website for official rules and details. Open to all countries where not prohibited.

LEGO and the LEGO logo are trademarks of the/son des marques de commerce du/son marcas registradas de LEGO Group. ©2017 The LEGO Group.

# LEGO® Architecture—then and now

There has always been a natural connection between the LEGO® brick and the world of architecture. Fans who build with LEGO elements instinctively develop an interest in the form and function of the structures they create. At the same time, many architects have discovered that LEGO bricks are the perfect way of physically expressing their creative ideas.

This connection was confirmed in the early 1960s with the launch of the LEGO 'Scale Model' line. It matched the spirit of the age where modern architects were redefining how houses look and people were taking an active interest in the design of their new homes. These sets were designed to be different from the normal, brightly colored LEGO boxes; they also included a book on architecture as a source of inspiration.

Decades later, architect and LEGO fan Adam Reed Tucker, revived the idea of expressing architecture using LEGO bricks and in partnership with the LEGO Group, launched the LEGO Architecture line that we know today.

His first models, and the original sets in the current LEGO Architecture series, were interpretations of famous skyscrapers from his hometown of Chicago. Since then LEGO Architecture has developed and evolved, first with well-known buildings from other cities in the United States, and now with iconic structures from Europe, the Middle East and Asia.

The introduction of our LEGO Architecture Studio set echoes the ambitions of the earlier LEGO 'Scale Model' line and widens the potential of the LEGO Architecture series. Now you can enjoy building and learning about specific landmark buildings, or create exciting architectural models from your own fantasy. An inspiring 270-page book, featuring a number of renowned architects from around the world, guides you through the principles of architecture and encourages you in your own creative building.





21050  
Studio

# References

Text credits:

[www.arcdetriompheparis.com](http://www.arcdetriompheparis.com)

Photo credits:

[www.shutterstock.com](http://www.shutterstock.com)

For further information please visit:

[www.arcdetriompheparis.com](http://www.arcdetriompheparis.com)

Customer Service

Kundenservice

Service Consommateurs

Servicio Al Consumidor

LEGO.com/service or dial



00800 5346 5555:



1-800-422-5346:





# Celebrate the world of architecture and collect all the models

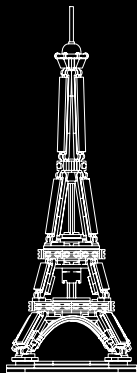

21019  
The Eiffel Tower

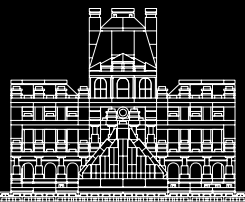

21024  
Louvre

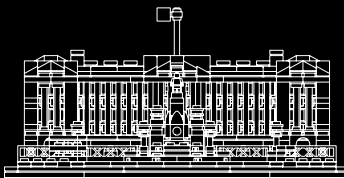

21029  
Buckingham Palace

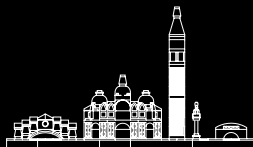

21026  
Venice



21027  
Berlin



21028  
New York City

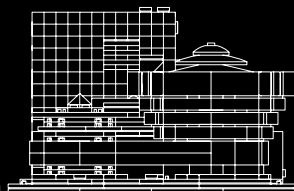

21035  
Solomon R. Guggenheim Museum®



21030  
United States Capitol Building

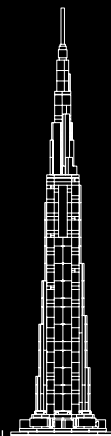

21031  
Burj Khalifa



21032  
Sydney



21033  
Chicago

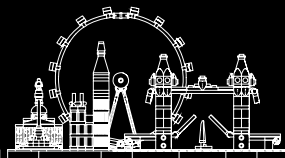

21034  
London



21032  
Sydney



21034  
London







21033  
Chicago



21019  
The Eiffel Tower





4x 6073432  
 14x 614101  
 8x 407001  
 26x 302401  
 8x 300501  
 8x 4113261  
 4x 6051511  
 20x 302301  
 30x 393701  
 10x 306901  
 4x 4249563

2x 306801  
 4x 6156667  
 2x 243101  
 4x 371001  
 8x 365901  
 10x 4560178  
 6x 6106183  
 2x 379501  
 2x 300801

4x 4558953  
 1x 6126082  
 1x 4211397  
 4x 6146223  
 6x 4211438  
 2x 4211374  
 2x 4144012  
 1x 4120020

4x 6015344  
 24x 4211398  
 20x 6066097  
 10x 4654582  
 4x 4211568

2x 4144387  
 14x 4143005  
 4x 6127662  
 8x 302323  
 2x 371023  
 2x 4212411  
 2x 447723

8x 6145570  
 8x 4114026  
 2x 6024495  
 8x 4113917  
 4x 6187580  
 4x 6132769  
 2x 4114309  
 2x 4157277  
 2x 4114001

1x 4222960  
 1x 6078236  
 2x 4496699  
 30x 4507045  
 4x 243126  
 1x 6131571

4x 416226  
 1x 6191892  
 3x 383226  
 4x 303026  
 2x 428226

  
**Customer Service**  
**Kundenservice**  
**Service Consommateurs**  
**Servicio Al Consumidor**

[LEGO.com/service](http://LEGO.com/service) or dial

 : 00800 5346 5555  
 : 1-800-422-5346



LEGO and the LEGO logo are  
trademarks of the LEGO Group.  
©2017 The LEGO Group. 6206288



[LEGO.com/architecture](https://www.lego.com/architecture)