

BRICK SKETCHES™

40428



The Joker™

Some time ago I was a part of an artists' group on a popular social media platform. Many of the artists were doing marker sketches on small cardstock as a way to engage with their fans. I thought this was a fantastic idea, but I wanted to put my own spin on it using LEGO® bricks. This led to the creation of the very first Brick Sketch. I posted it to my social media channels with some apprehension, not entirely sure how my fans would react. Thankfully, they loved the concept and wanted to see more!

After some experimenting, I nailed down the basics: Brick Sketches would be plate-based artwork that featured a front-facing character on a 12x16 canvas. Given that Brick Sketches are somewhat three-dimensional, it was also important that they have correct relief wherever possible; for example, the character's chin shouldn't extend further out than the nose. The challenge was to use LEGO pieces creatively to build detailed character artwork on a relatively small canvas.

Brick Sketches became far more popular than I ever expected. Fans loved suggesting new characters and often asked me to create instructions so that they could build their favorites. It was difficult to set aside the concept when I started working at the LEGO Group, but through an amazing series of events, Brick Sketches are now available from the LEGO Group itself. It's a dream come true.



LEGO® designer Chris McVeigh

The Joker™

Il y a quelque temps, je faisais partie d'un groupe d'artistes sur la plate-forme d'un média social très connu. De nombreux artistes réalisaient des croquis au marqueur sur de petits cartons pour interagir avec leurs fans. Cette idée me plaisait beaucoup, mais je voulais y apporter ma touche personnelle à l'aide de briques LEGO®. J'ai donc eu l'idée de créer le tout premier croquis en briques. Je l'ai publié sur mes réseaux sociaux avec une certaine appréhension, car je ne savais pas comment mes fans allaient réagir. Heureusement, ils ont adoré le concept et en ont redemandé !

Après quelques expérimentations, je me suis fixé des règles : les croquis en briques devaient être des œuvres montées sur une plaque et ils devaient représenter un personnage de face sur une toile de 12 x 16 tenons. Comme les croquis en briques sont tridimensionnels, il était également important qu'ils soient correctement proportionnés dans la mesure du possible. Le menton du personnage ne devait pas être plus long que le nez, par exemple. Le défi consistait à utiliser des pièces LEGO de manière créative pour construire des représentations détaillées de personnages sur une toile relativement petite.

Les croquis en briques ont eu beaucoup plus de succès que je ne l'aurais imaginé. Les fans adoraient me suggérer de nouveaux personnages et me demandaient souvent de créer des instructions pour pouvoir les construire eux-mêmes. Lorsque j'ai commencé à travailler pour le Groupe LEGO, j'ai eu du mal à mettre ce concept de côté, mais suite à un concours de circonstances incroyable, le Groupe LEGO a fini par proposer lui-même les croquis en briques. Un rêve est devenu réalité.



Le designer LEGO® Chris McVeigh

The Joker™

Hace tiempo, fui miembro de un grupo de artistas en una popular red social. Muchos de ellos hacían dibujos con marcadores en pequeños lienzos de cartulina para interactuar con sus fans. Me pareció una idea fantástica, pero quise darle mi propio toque personal usando bricks LEGO®. Eso fue lo que condujo a la creación del primer Brick Sketch. Lo publiqué en mis canales de las redes sociales con cierta desconfianza, sin estar del todo seguro de cómo reaccionarían mis fans. ¡Afortunadamente, les encantó el concepto y querían ver más!

Luego de experimentar un poco, definí lo básico: un Brick Sketch sería un diseño a base de placas que representaría a un personaje, de frente, sobre un lienzo de 12x16. Dado que los Brick Sketches son, en cierto modo, tridimensionales, también era importante recrear el relieve correcto donde fuera posible; por ejemplo, la barba de un personaje no debía sobresalir más que su nariz. El desafío consistía en usar piezas LEGO con creatividad para construir retratos detallados de personajes sobre un lienzo relativamente pequeño.

Los Brick Sketches acabaron haciéndose mucho más populares de lo que esperaba. A los fans les encantaba sugerir nuevos personajes y, a menudo, me pedían que creara las instrucciones necesarias para construir a sus favoritos. Fue difícil apartarme de la idea cuando empecé a trabajar en The LEGO Group. Sin embargo, luego de una sorprendente serie de acontecimientos, los Brick Sketches vuelven a estar disponibles, ahora oficialmente, como productos LEGO. Es un sueño hecho realidad.



El diseñador de LEGO® Chris McVeigh



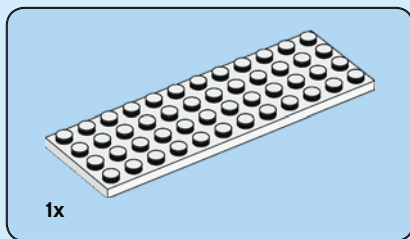

1

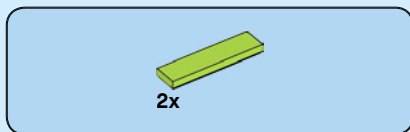
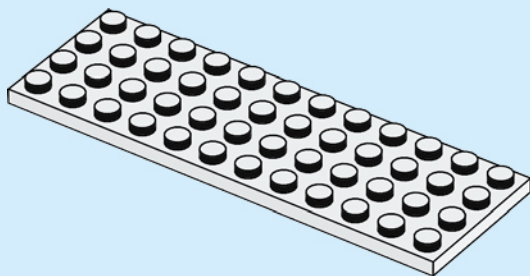

2

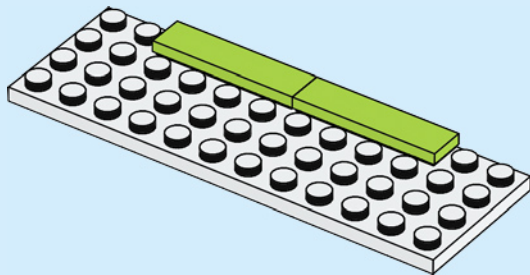



2x

3

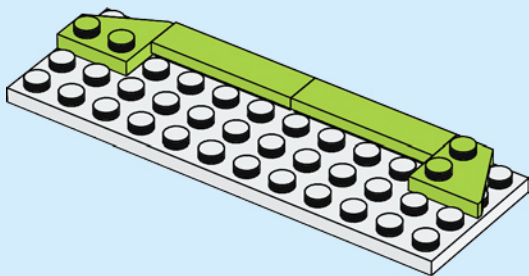

4x

4

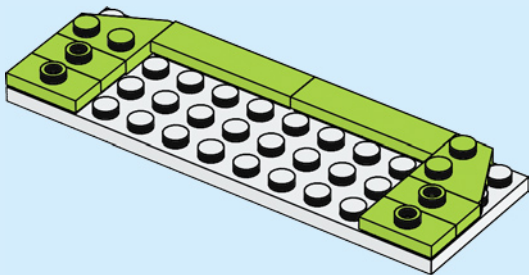

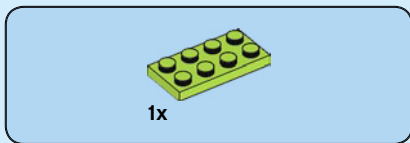

5

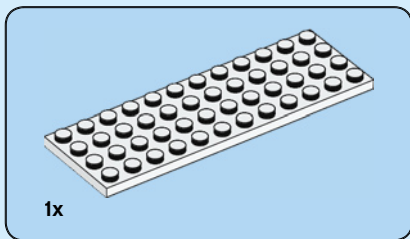
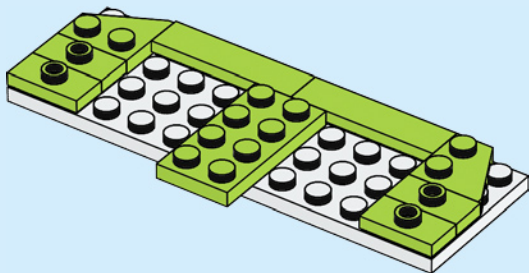

6

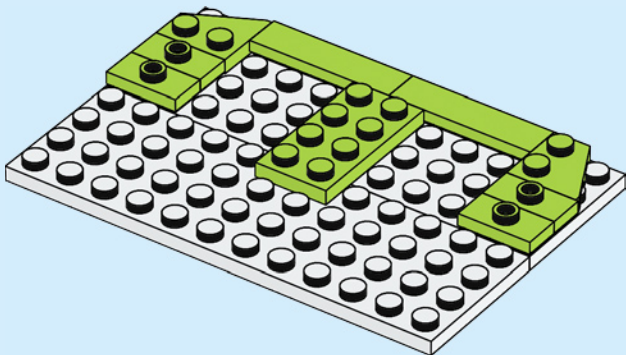

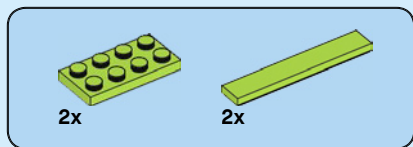

7

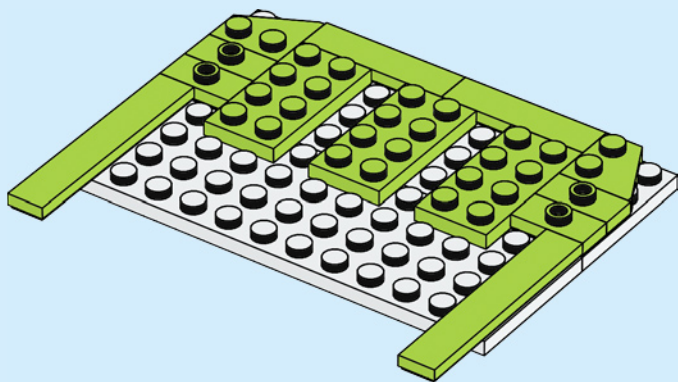

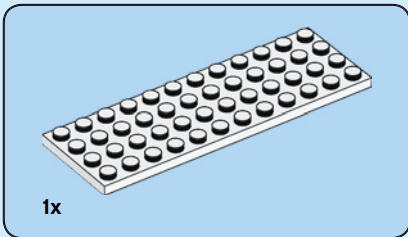

8

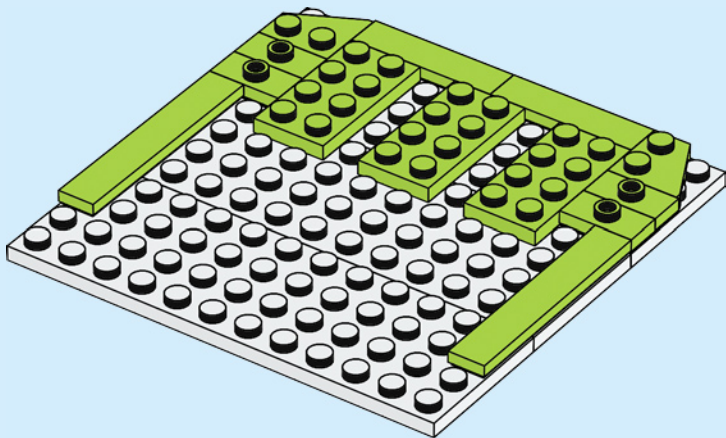

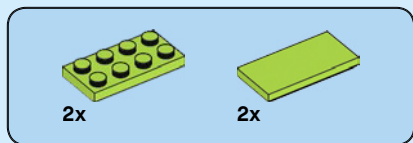

9

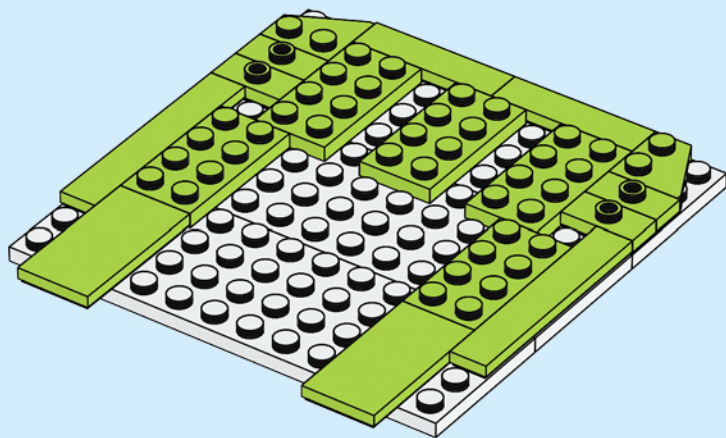

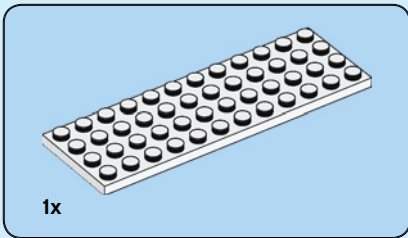

10

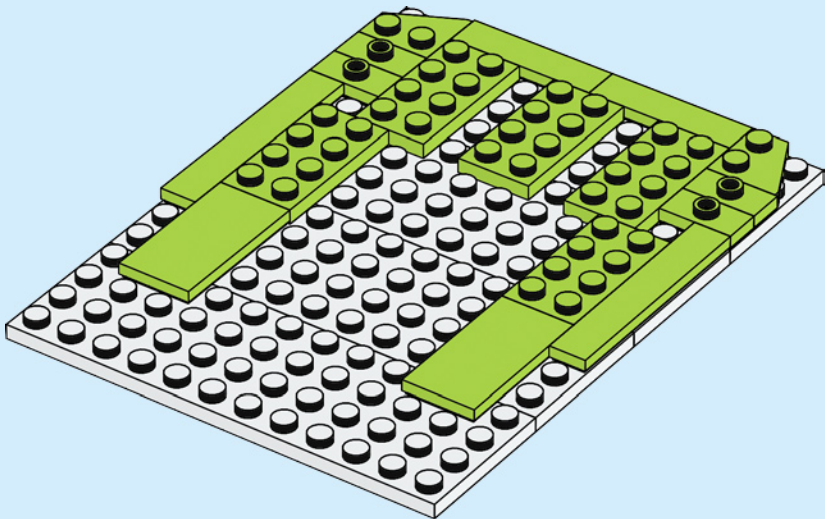



2x



2x

11

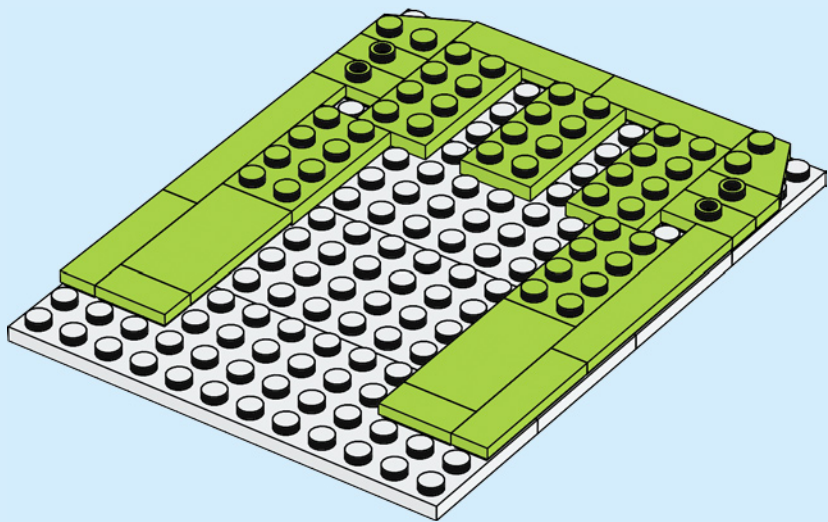



2x



2x

12

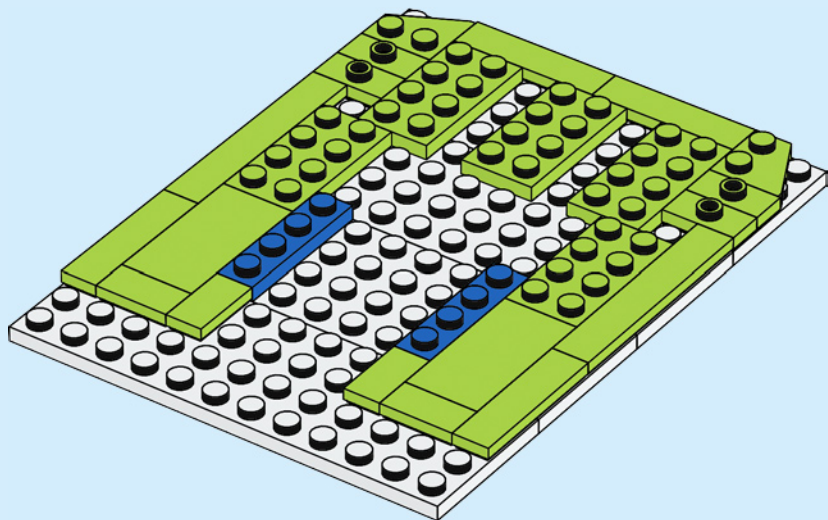

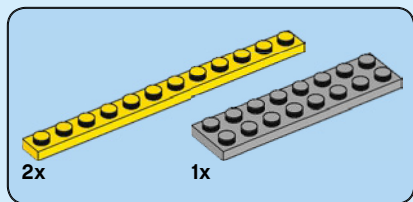

13

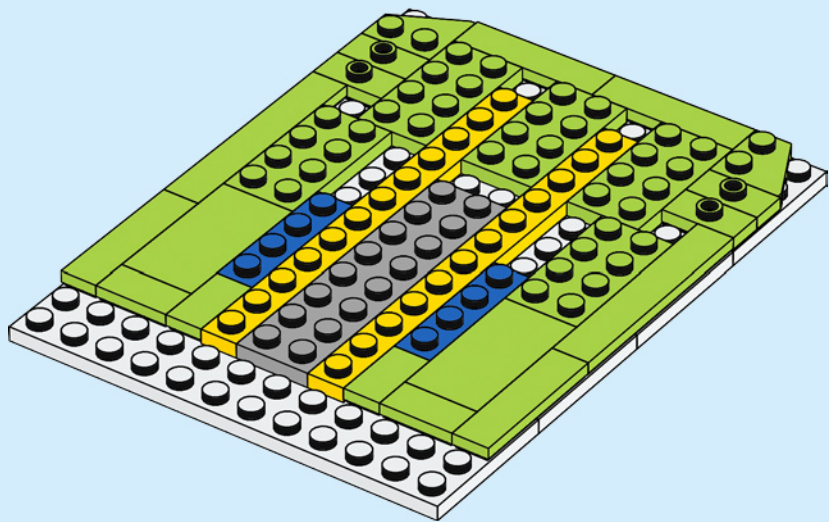

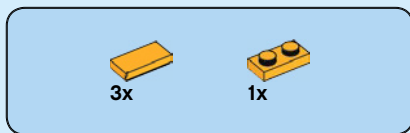

14

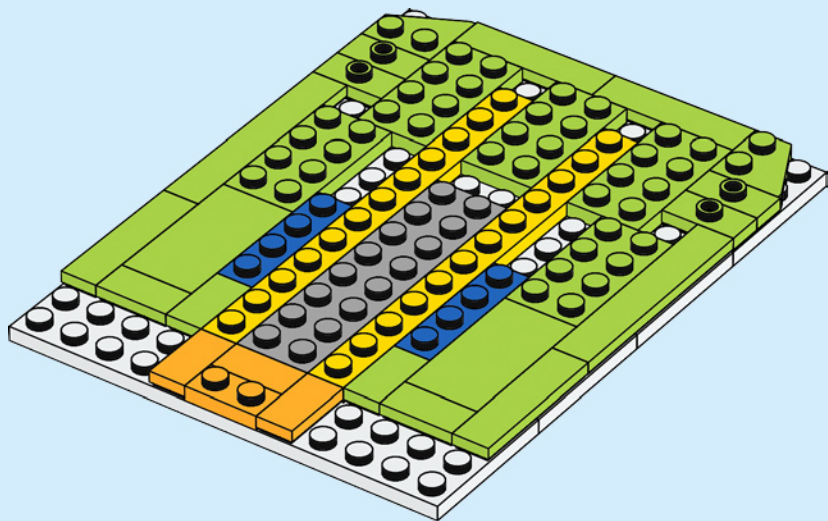



2x



2x

15

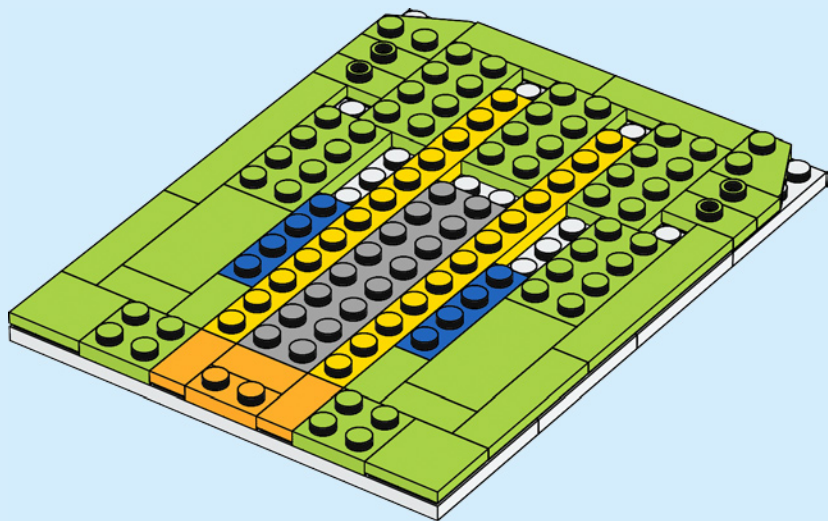



2x

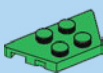

1x

16

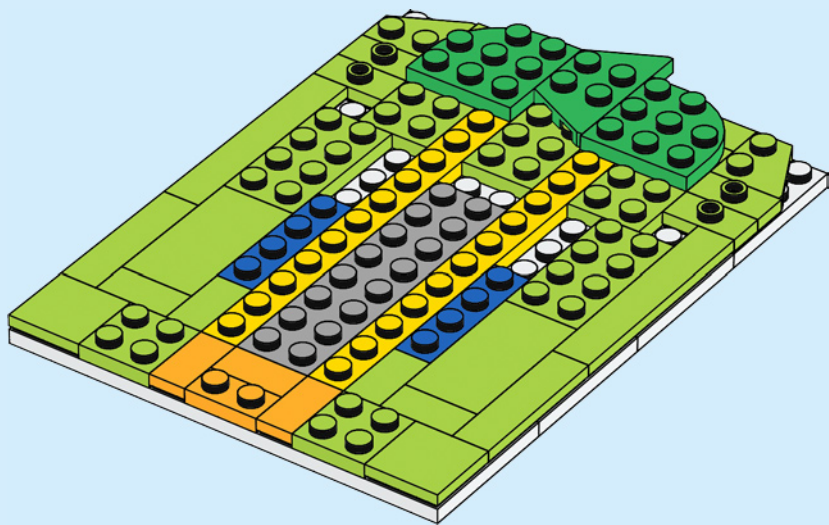



2x



2x

17

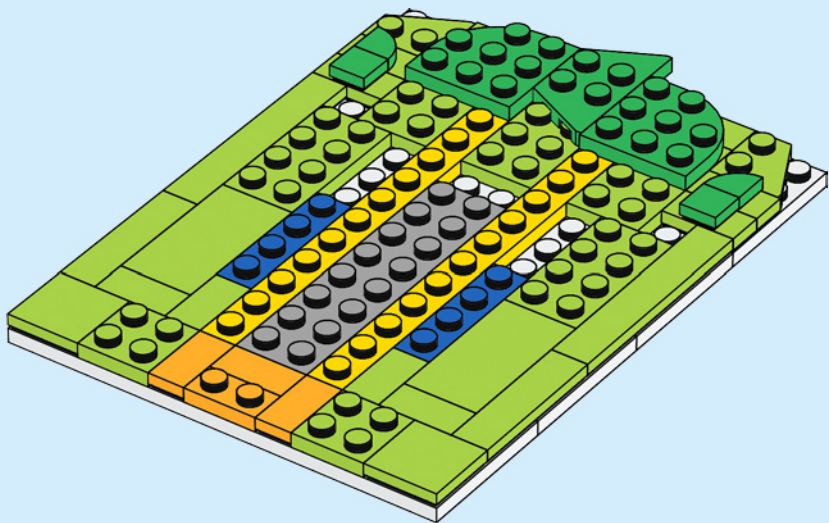

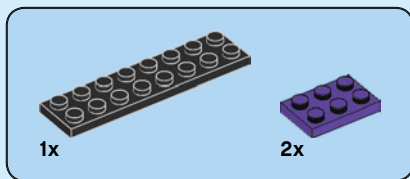

18

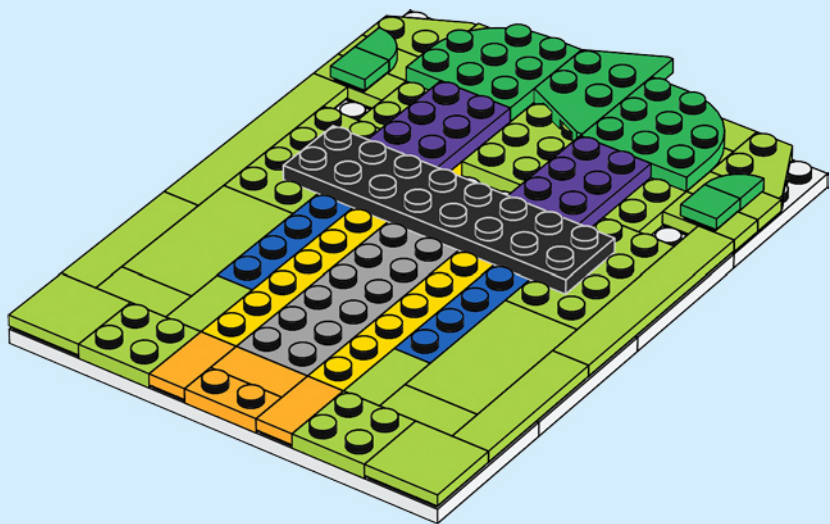

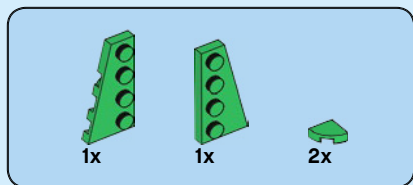

19

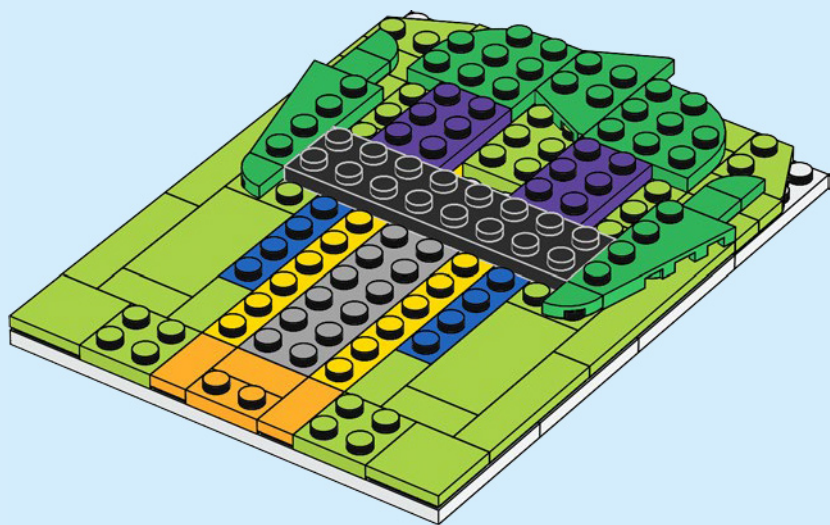

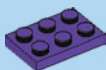

1x



2x

20

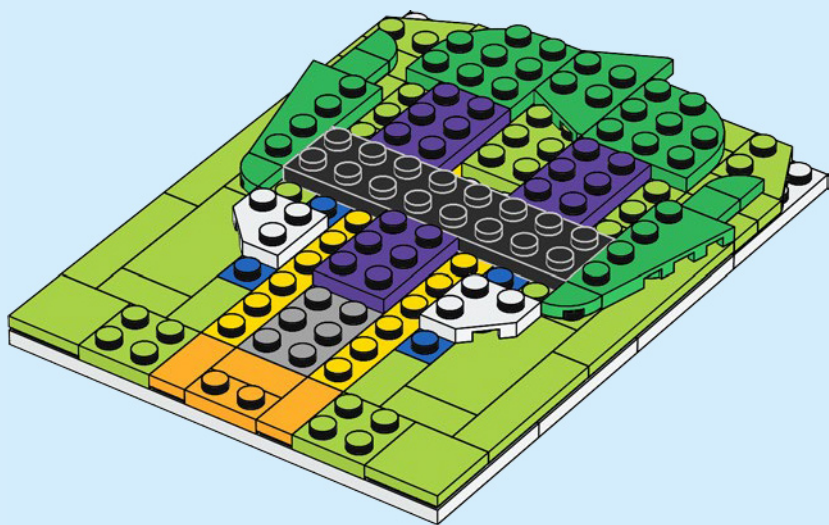

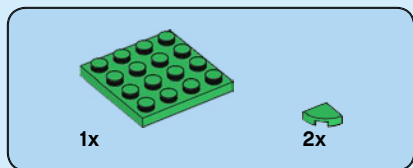

21

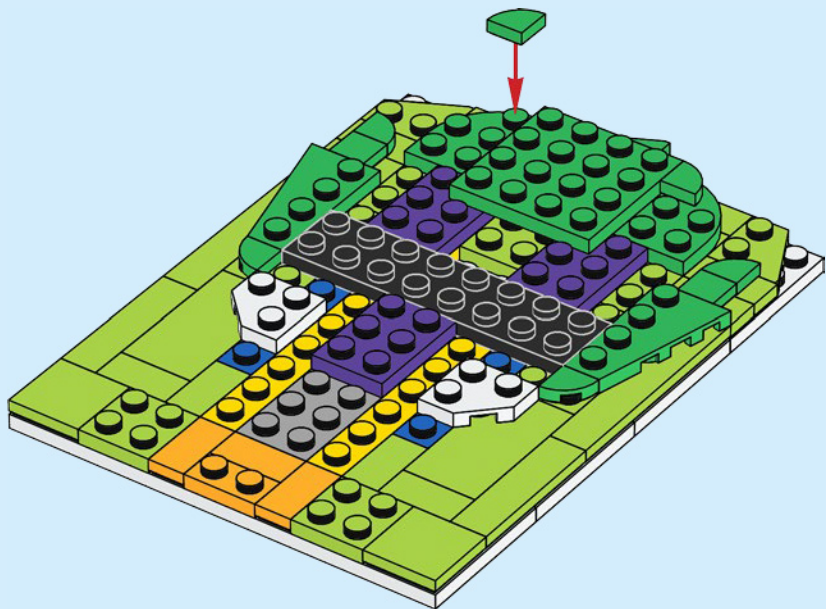



2x

22

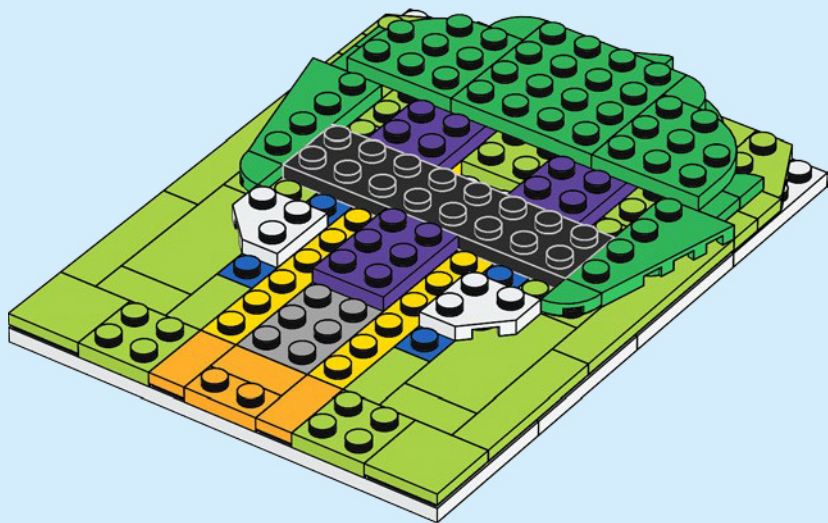

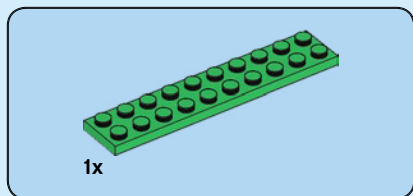

23

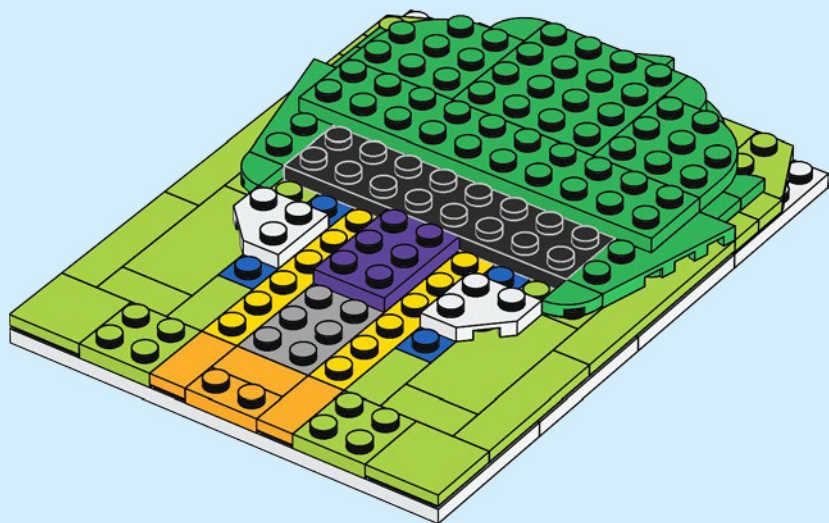



2x



2x

24

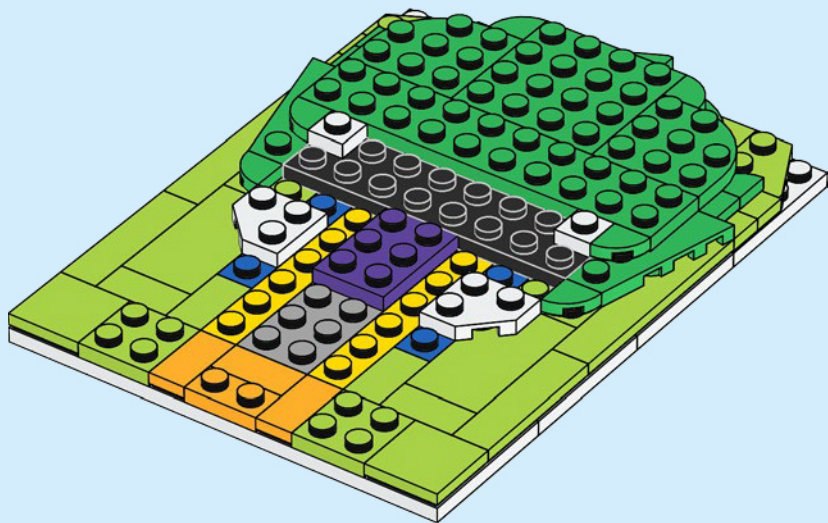

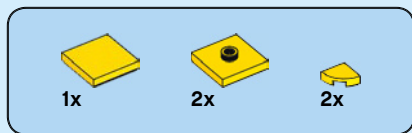

25

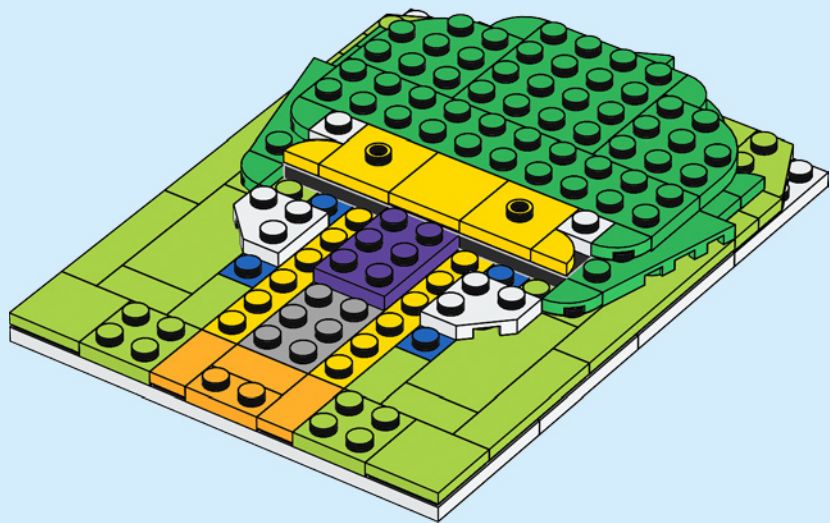

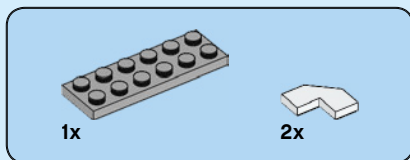

26

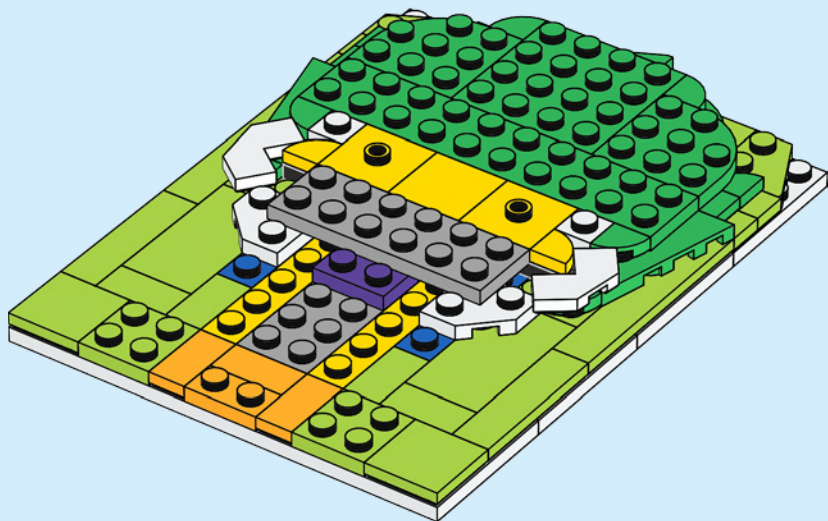



2x

27

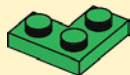

2x

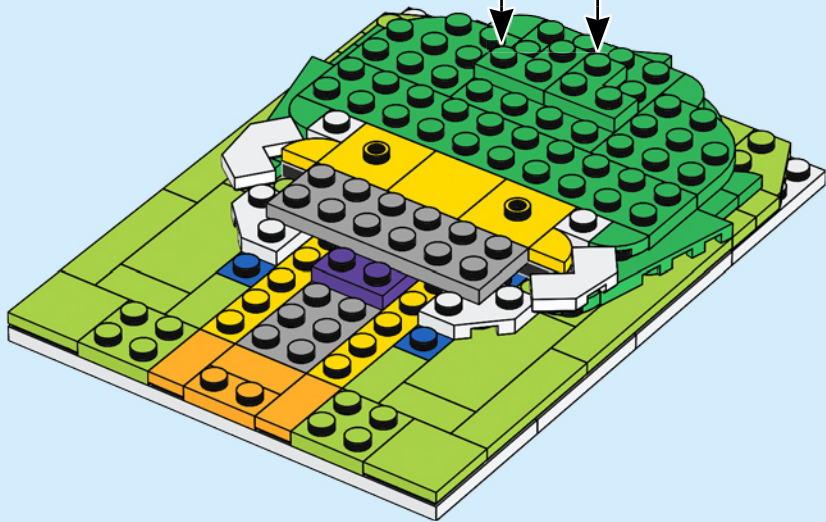



4x

28

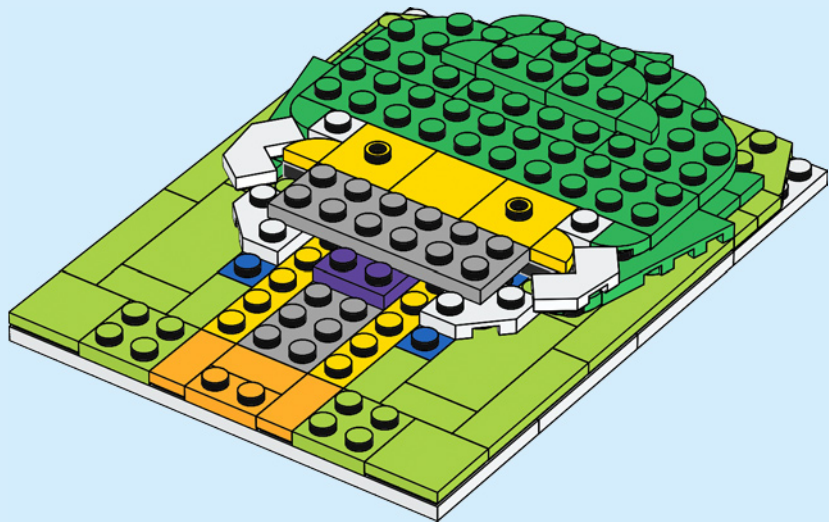



1x



2x

29

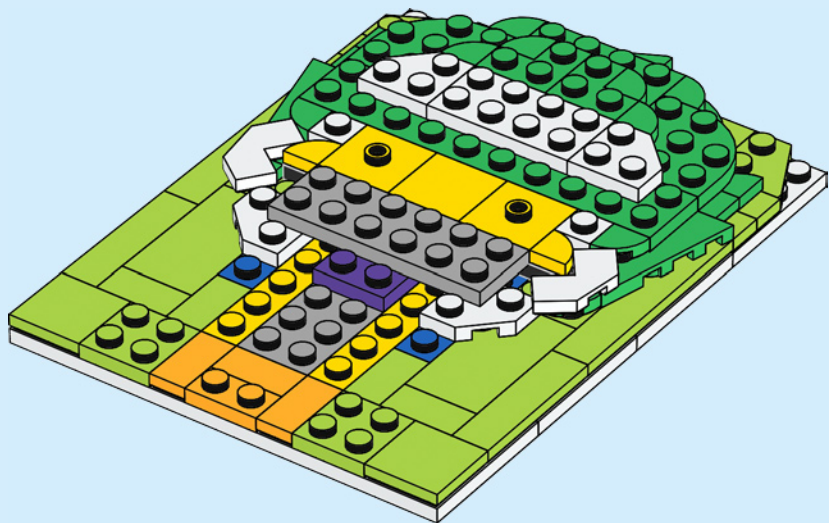

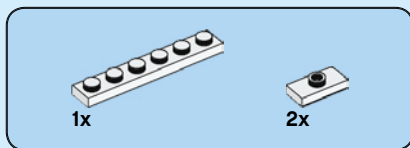

30

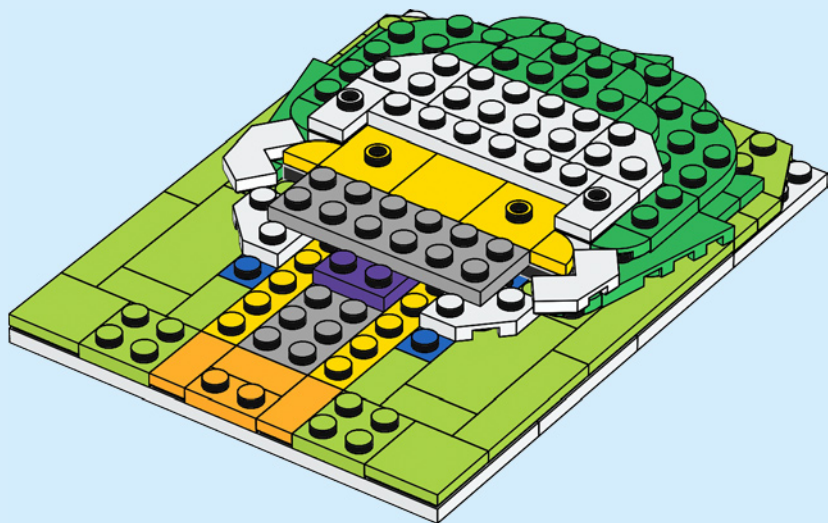



1x



1x



2x

31

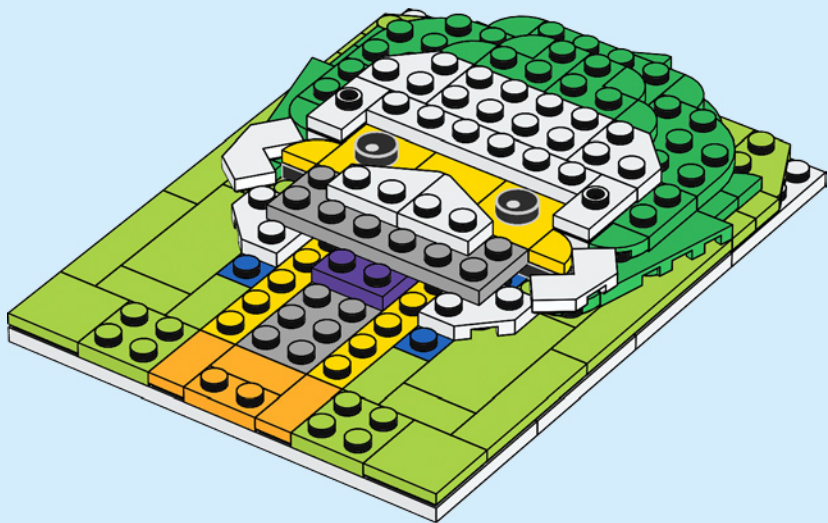

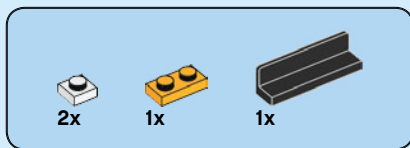

32

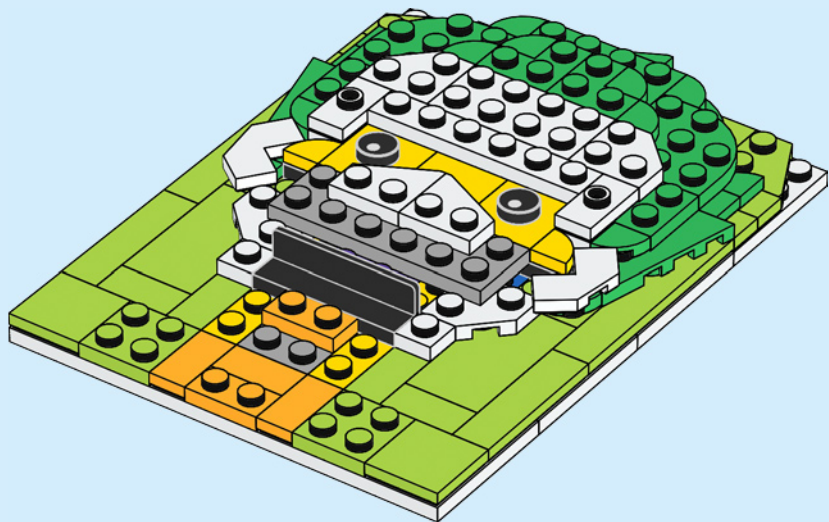



33

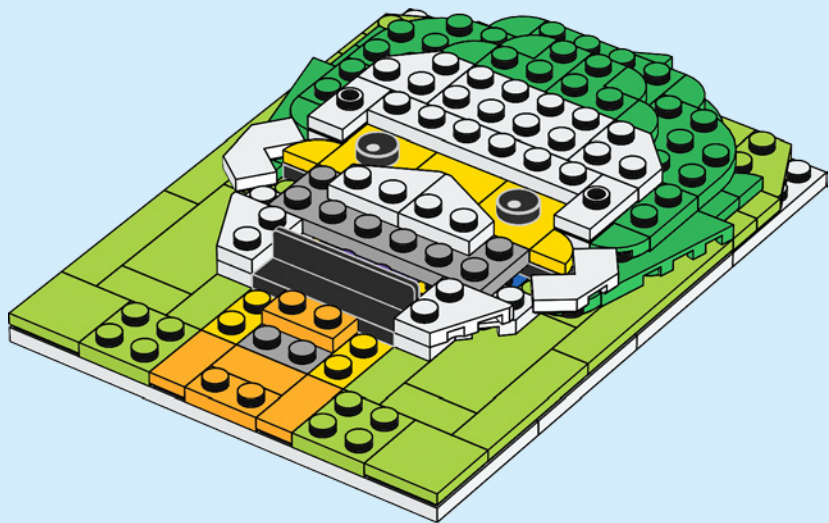

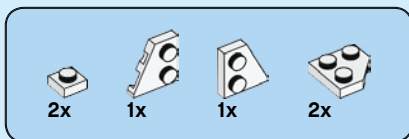

34

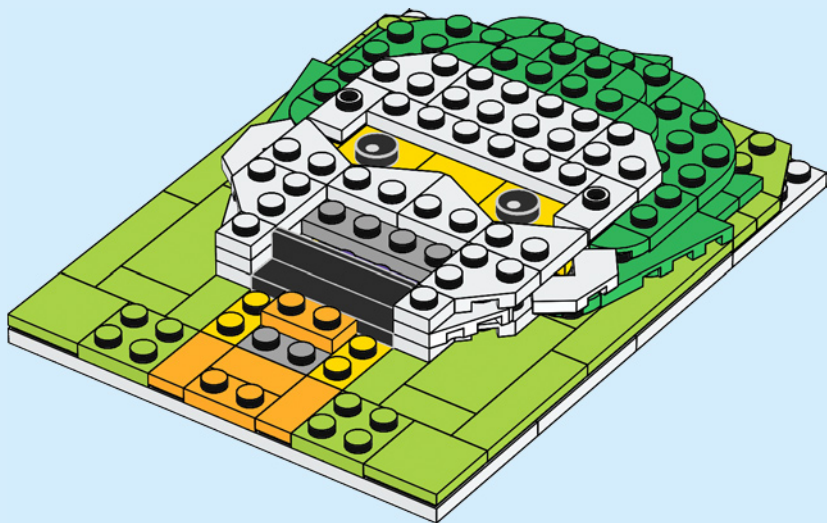



3x



3x

35

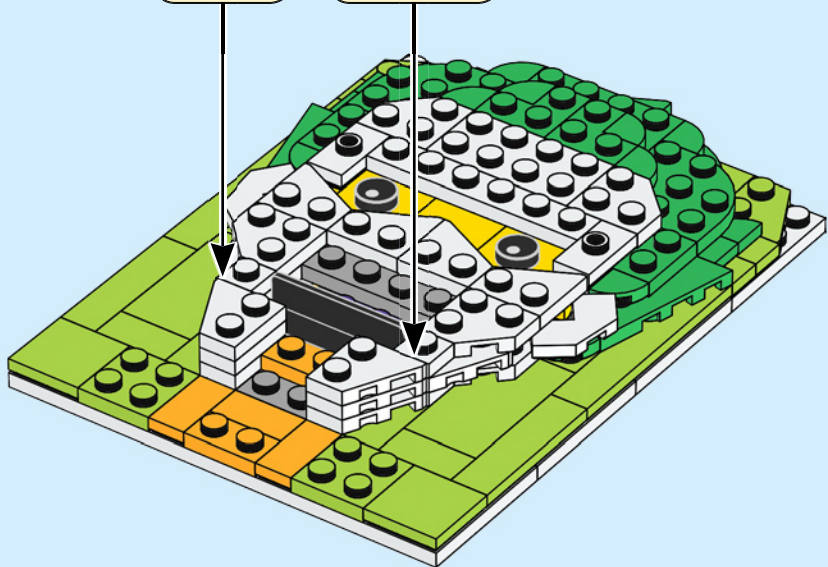
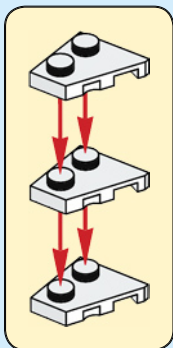
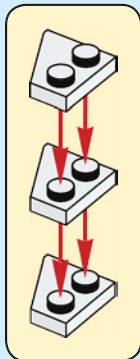

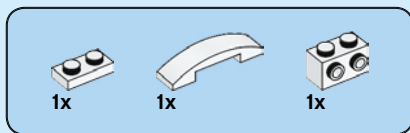

36

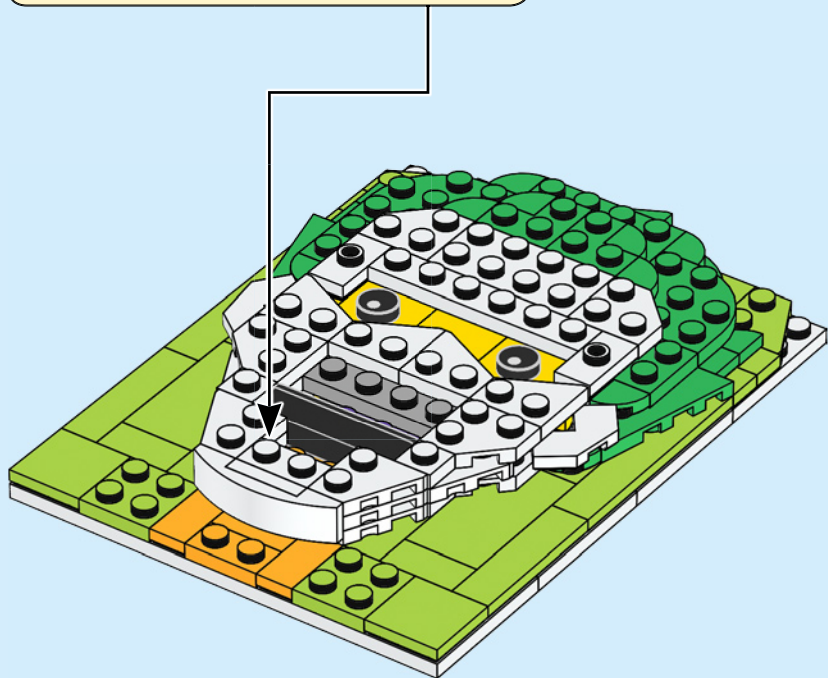
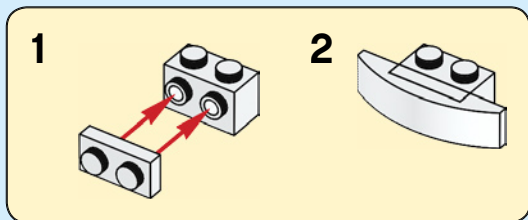



1x

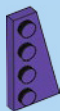

1x

37

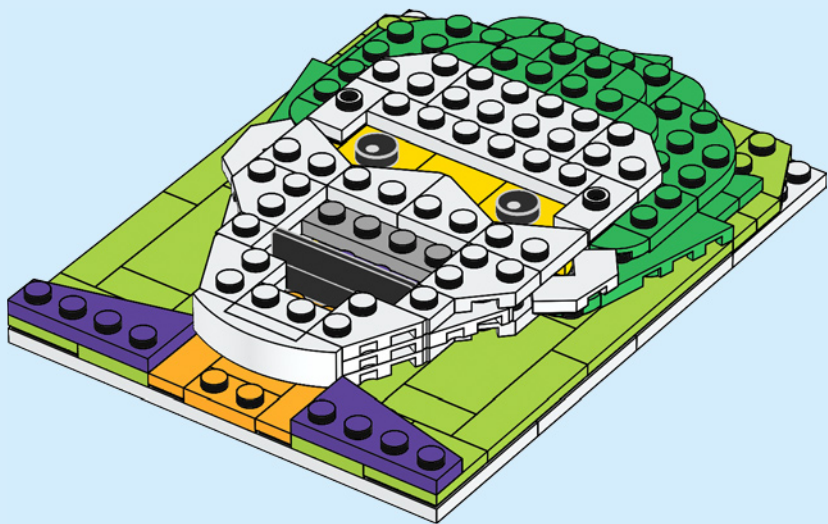



2x



2x

38

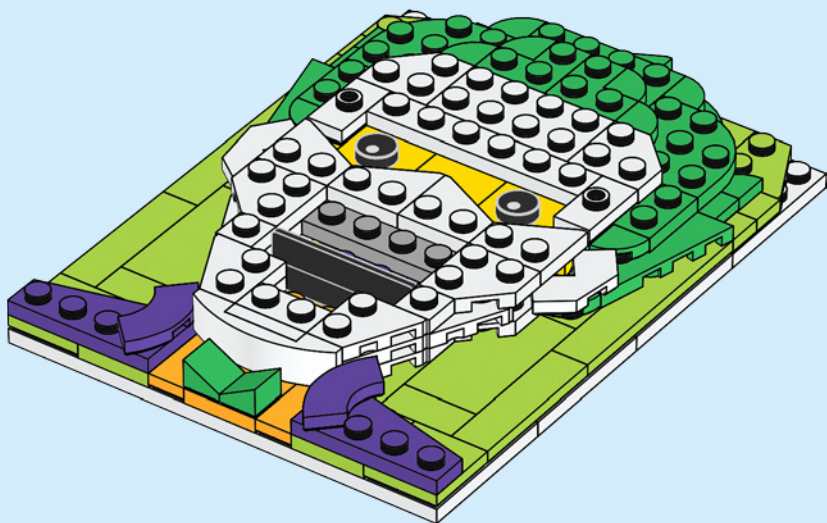

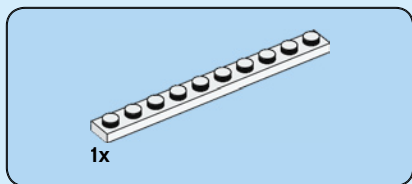

39

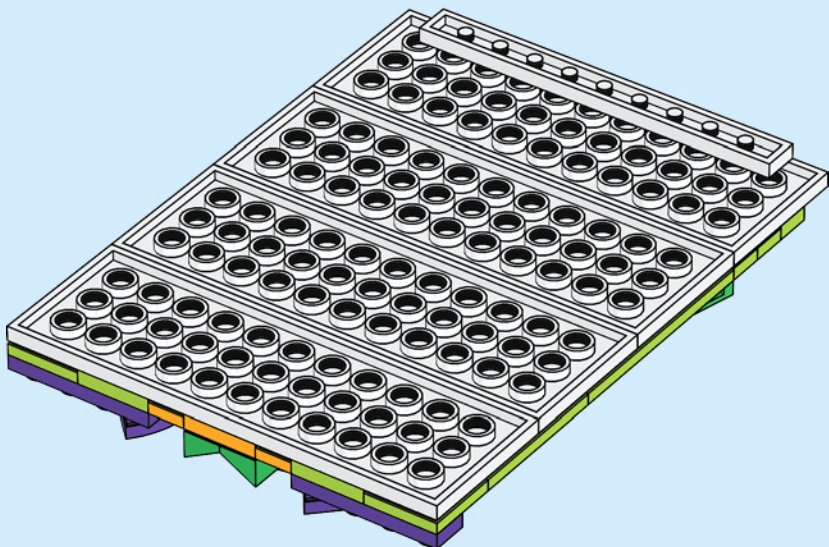
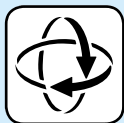

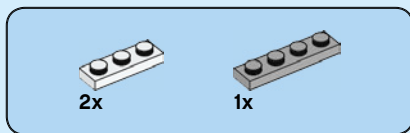

40

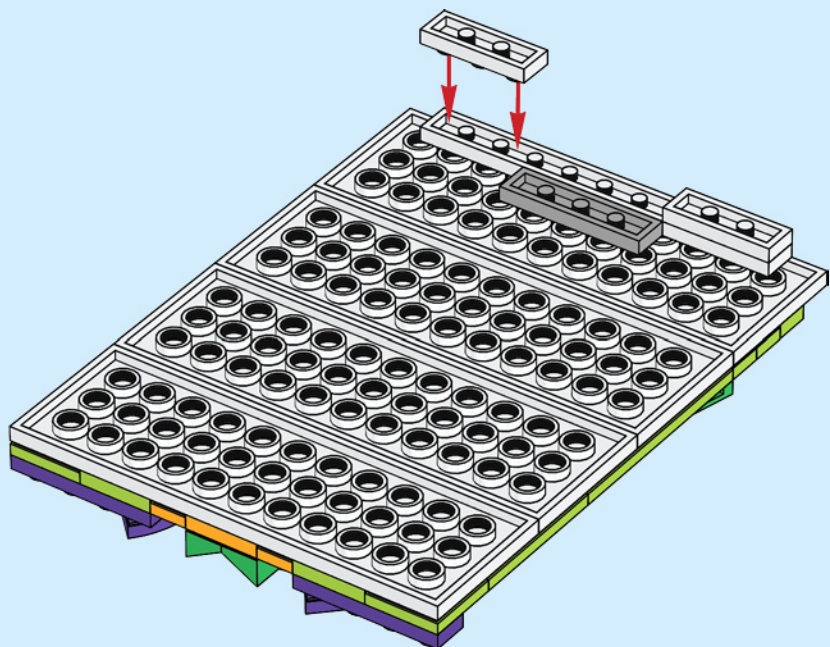



1x



2x

41

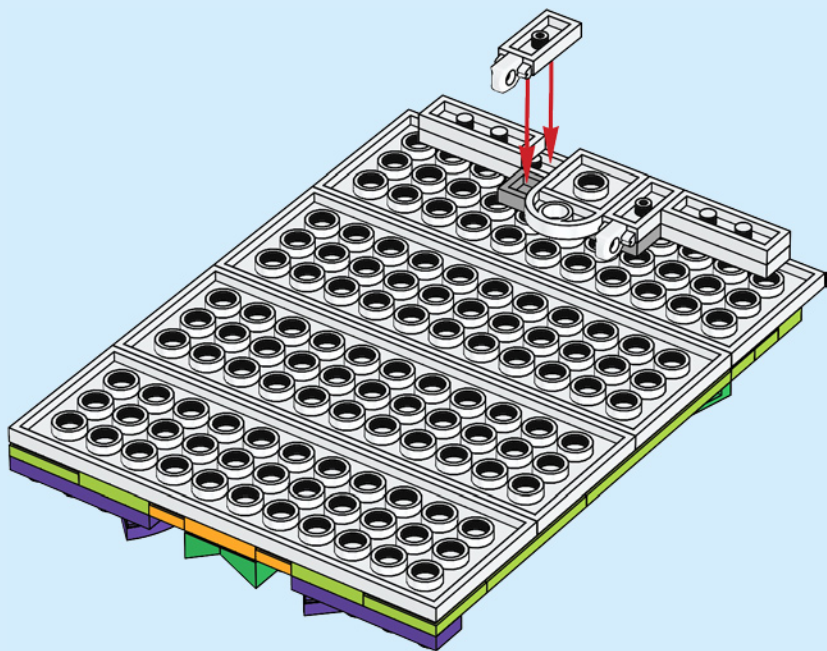

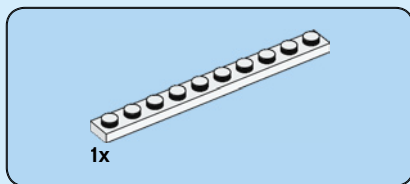

42

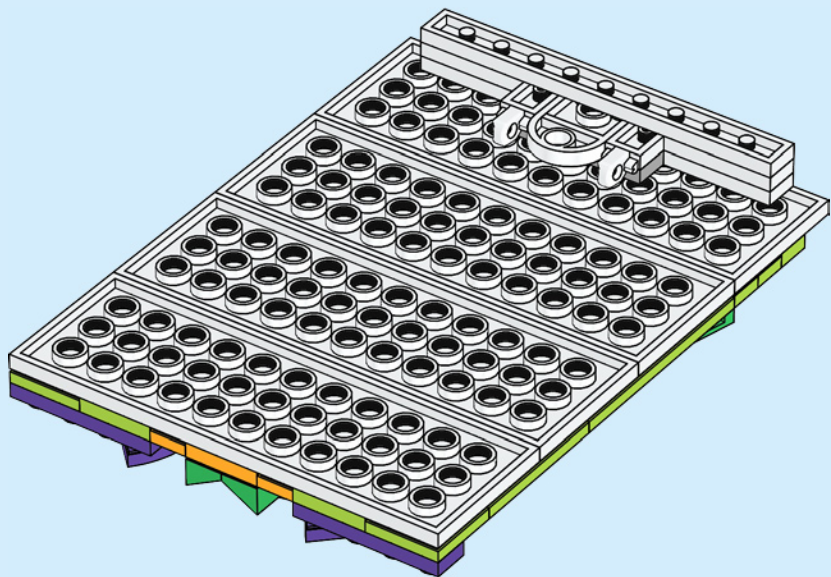

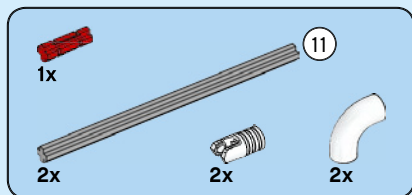

43

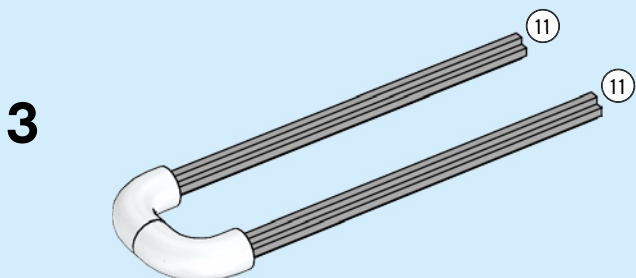
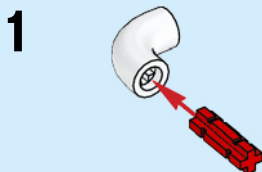

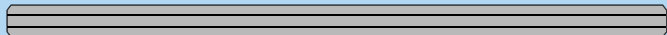

11

1:1

4

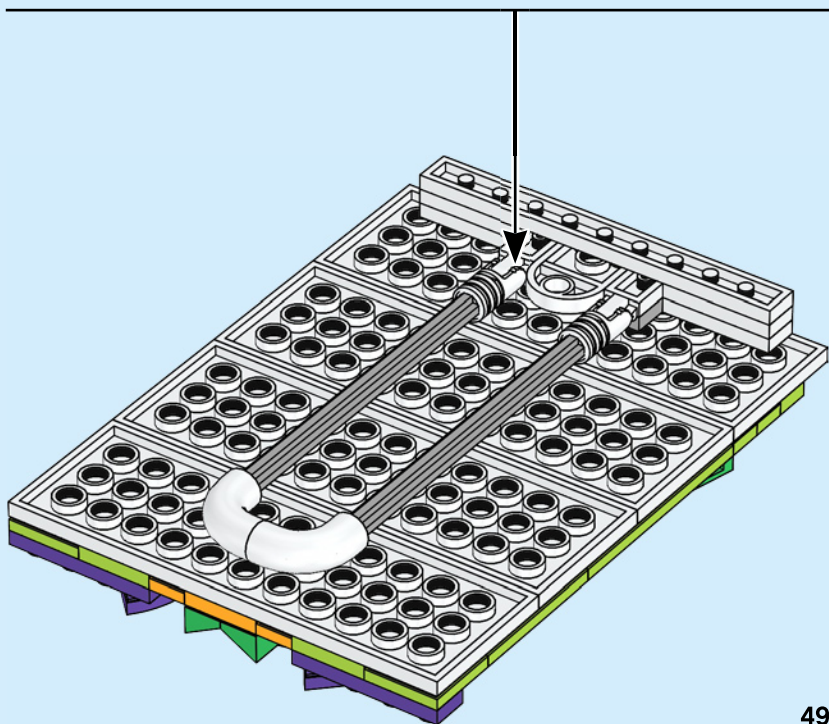
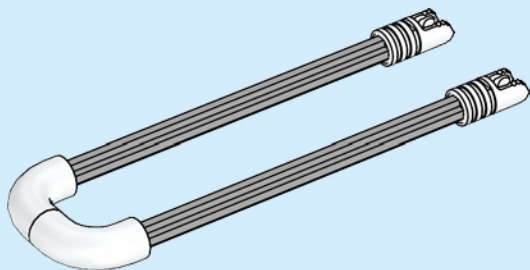

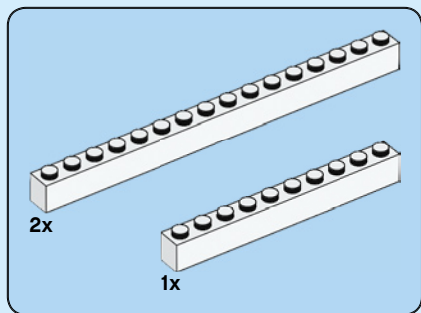

44

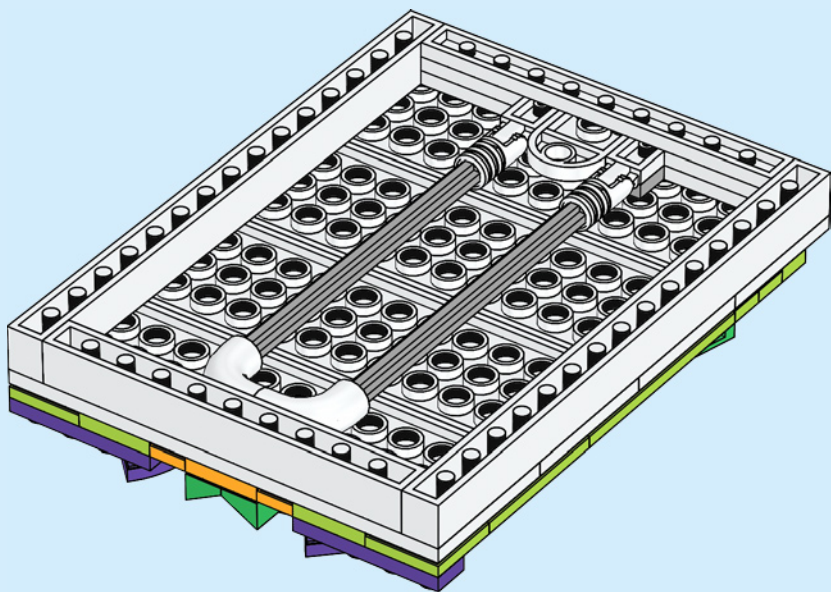



4x

45

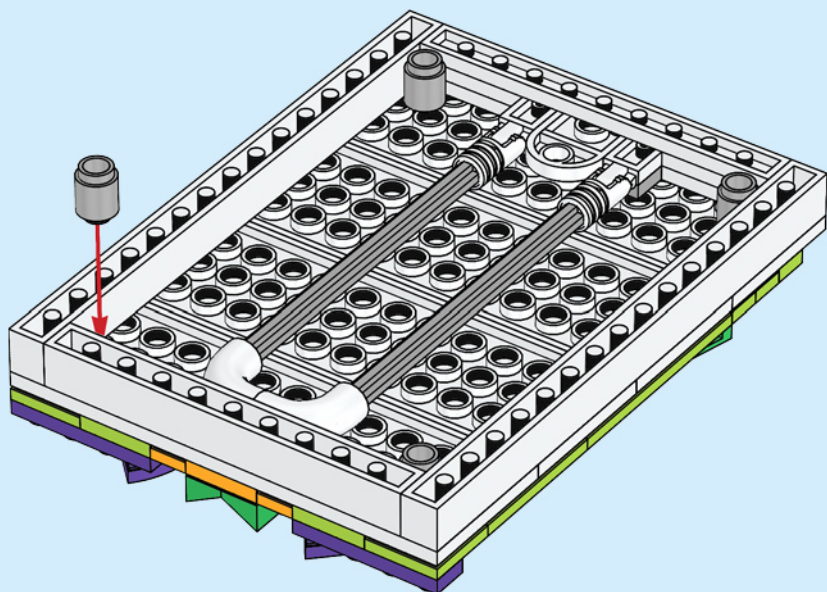



4x

46

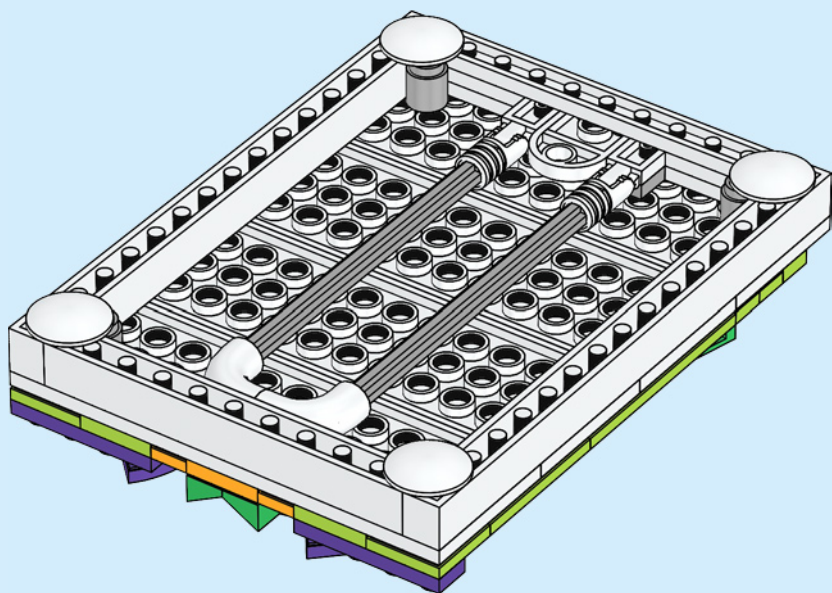

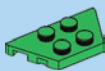

1x

47

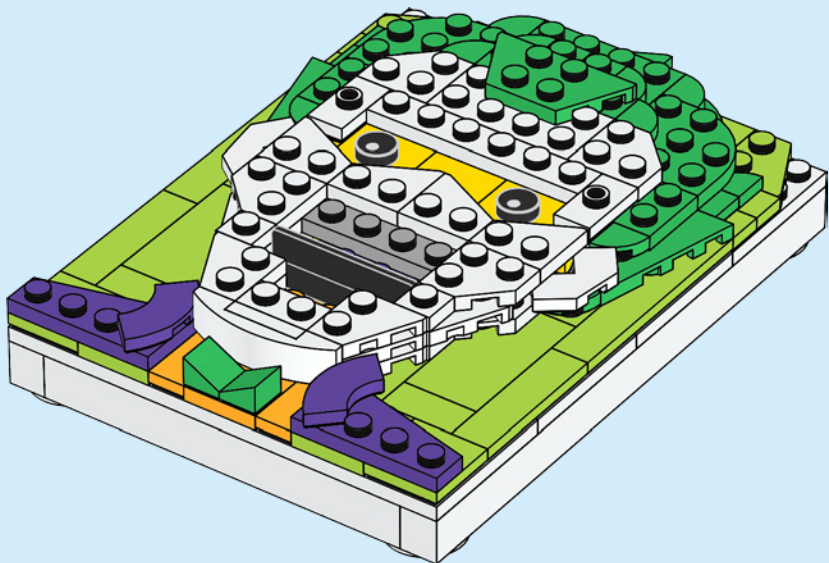



2x



2x

48

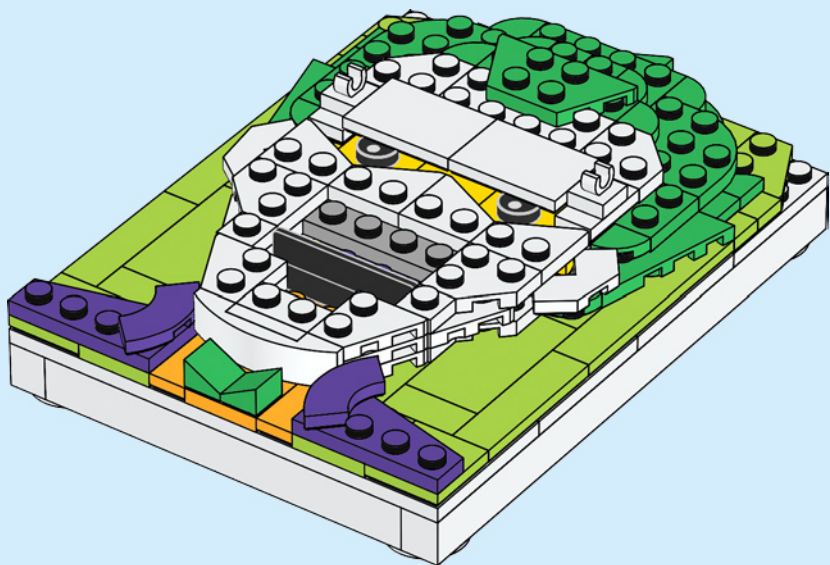

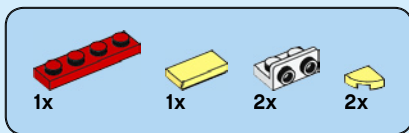

49

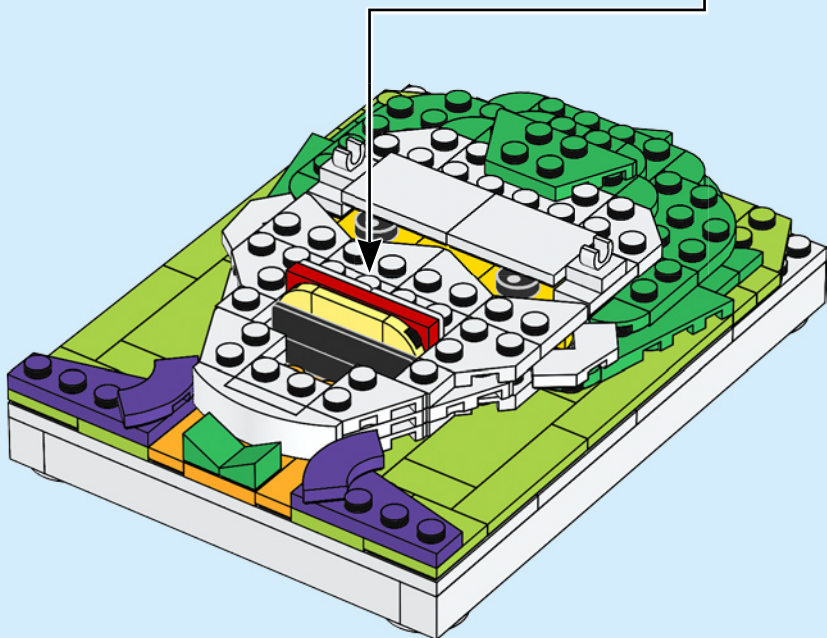
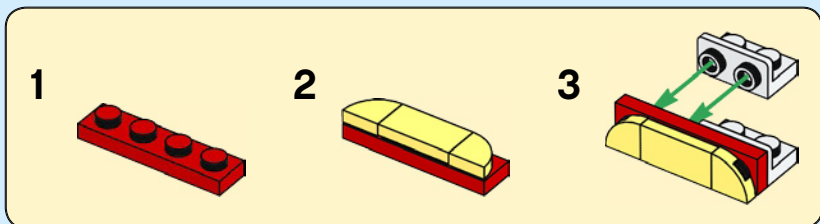



2x



2x



1x

50

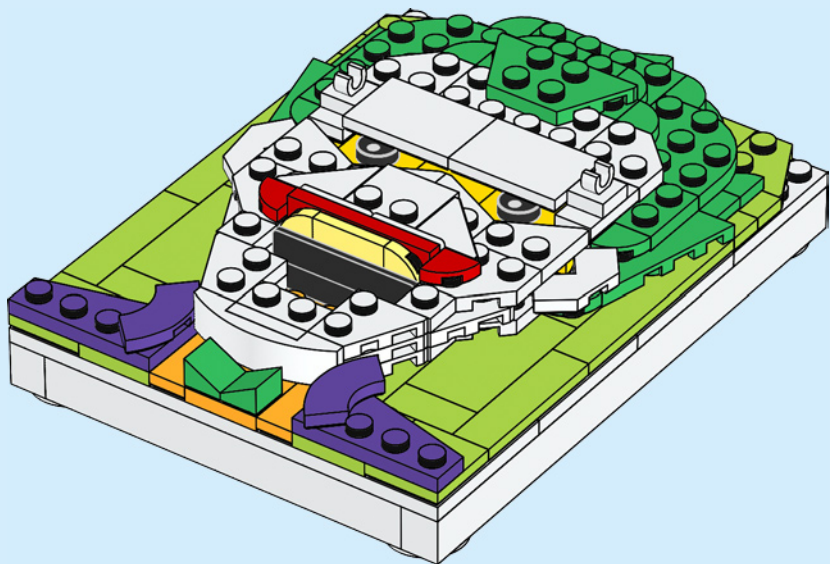

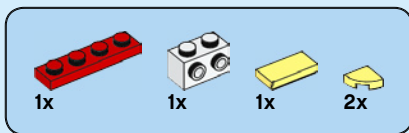

51

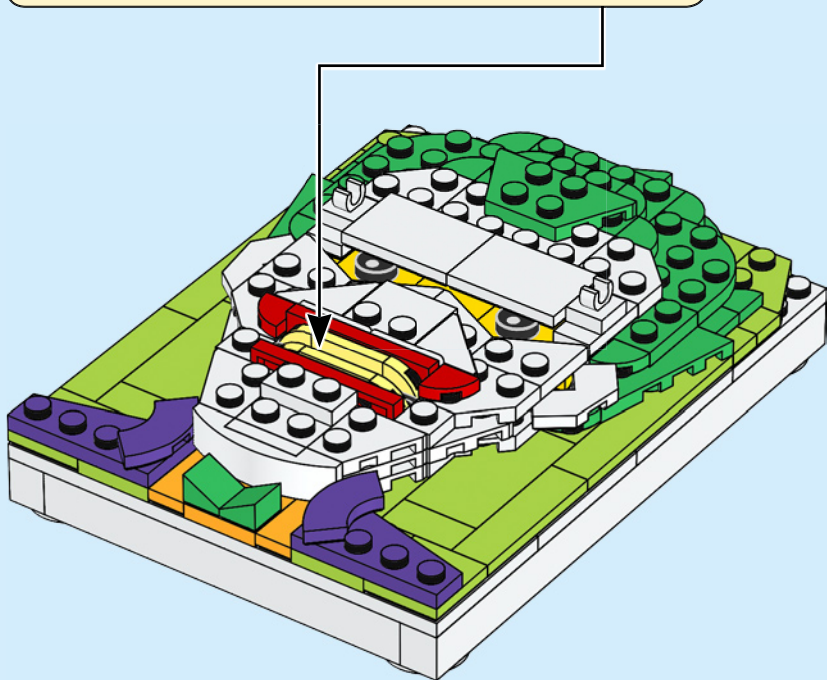
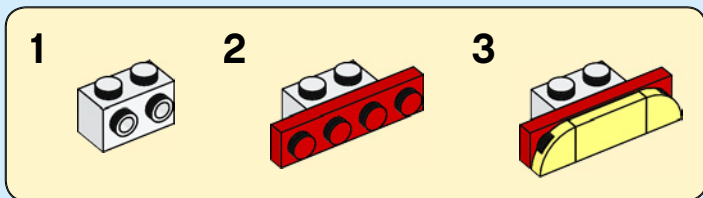



1x



2x

52

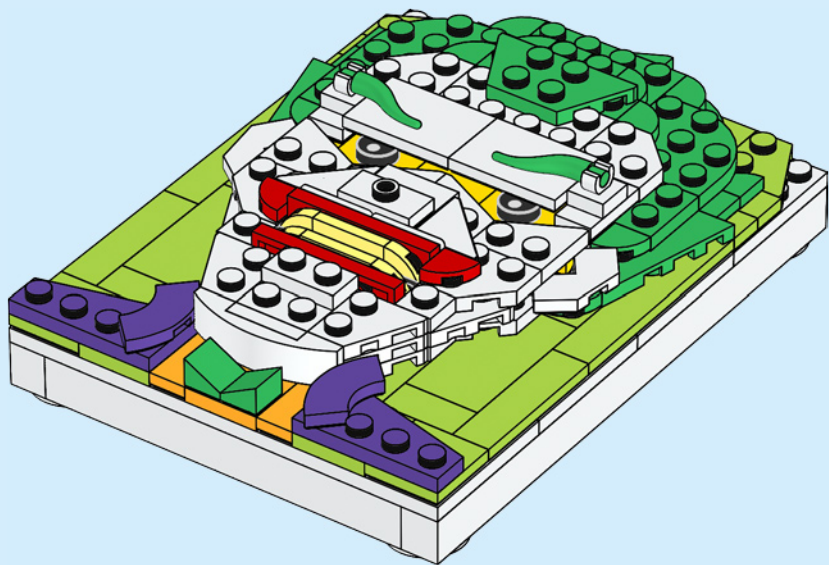

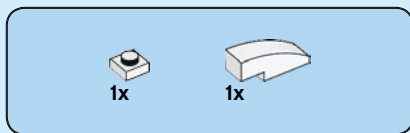

53

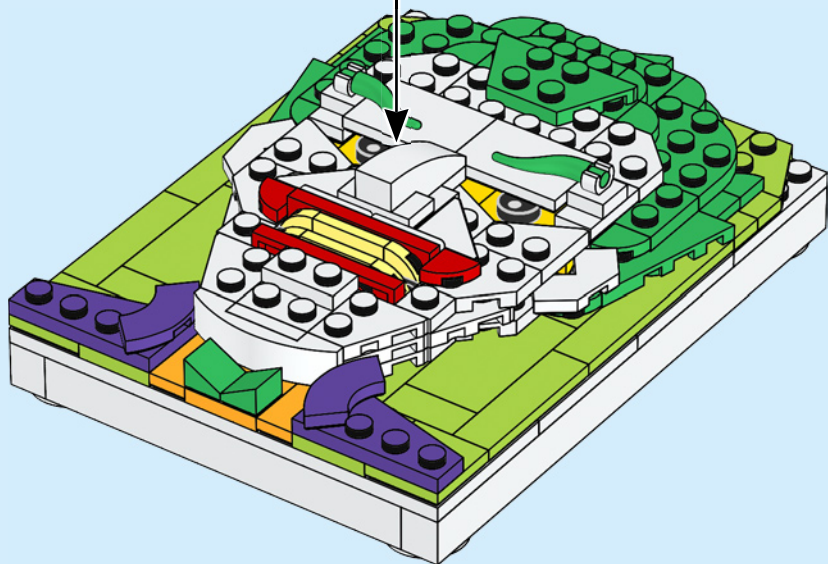
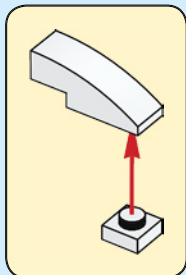

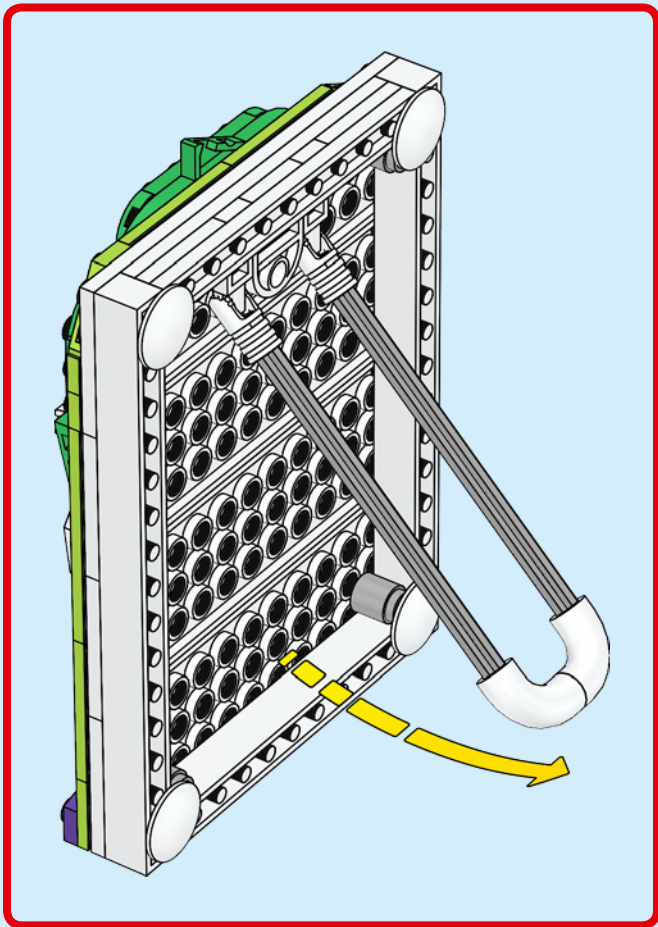

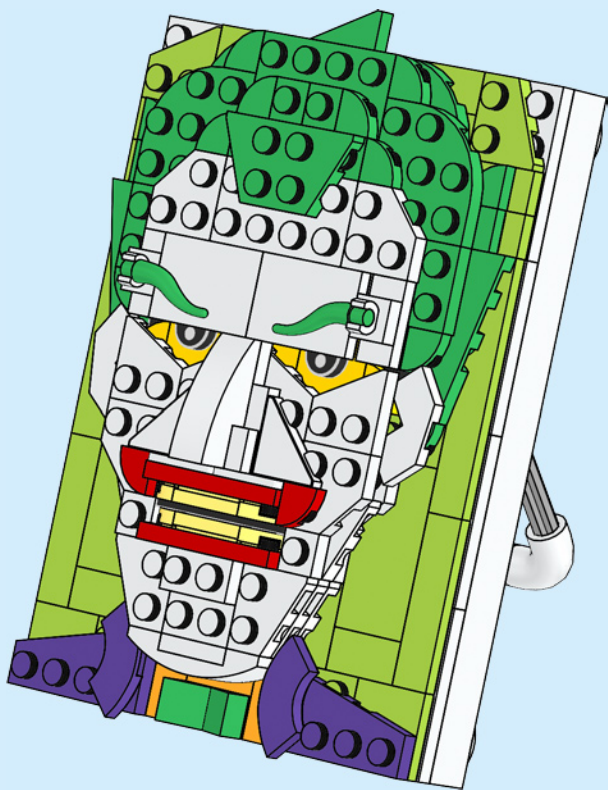

4x
6228969

2x
6061201

7x
302401

2x
6054551

6x
6132203

6x
6132204

4x
4278271

2x
6194851

2x
6271540

3x
6051511

2x
6058177

1x
302301

6x
6176240

2x
6070698

2x
6217875

2x
4183035

1x
6218822

2x
6168612

2x
362301

1x
4249112



1x
6089696



2x
6156667

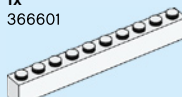

1x
6023806

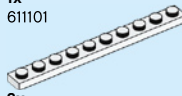

1x
302001

1x
366601

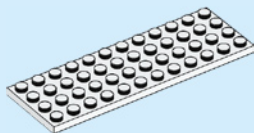
1x
611101

2x
447701

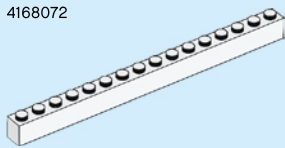
4x
4168072

2x
246501

2x
6170390

1x
4142865



2x
371021

2x
371023

2x
6195183

1x
306824

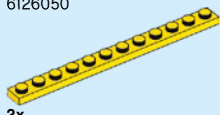

2x
6126050

2x
4514844

2x
6284072

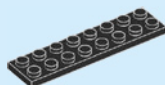

1x
6092570



1x
303426



2x
4558593



12x
6150607



2x
4546705



1x
4543259



1x
4543262



2x
6317551



2x
4157120



2x
6100220



4x
6062166

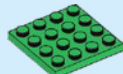

1x
4243821

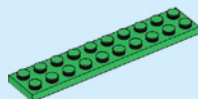

1x
383228



2x
6247210



4x
4500125



4x
6092592



2x
4537937



2x
4518611



4x
4164021



5x
4537936



2x
6212989



2x
6167465



2x
6028736



3x
4622062



4x
4211412



1x
4211445

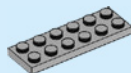

1x
4211452

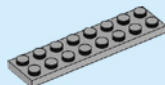

1x
4211406

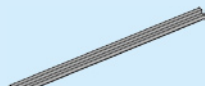

2x
6178172



1x
6211336



1x
6211334



2x
6198999



3x
4225142

11



Customer Service

Kundenservice

Service Consommateurs

Servicio Al Consumidor

LEGO.com/service or dial



: 00800 5346 5555

: 1-800-422-5346

WIN

GO TO WWW.LEGO.COM/PRODUCTFEEDBACK
AND GIVE US YOUR SHORT **FEEDBACK**
ABOUT THIS LEGO® SET FOR A CHANCE
TO WIN A COOL LEGO PRIZE.

Terms & Conditions apply



LEGO.com/productfeedback

GEWINNE

Erzähle uns auf
www.LEGO.com/productfeedback

etwas über die Erfahrungen, die du mit
diesem LEGO® Set gemacht hast, und
sichere dir die Chance auf einen coolen
LEGO Preis!

Es gelten die Teilnahmebedingungen

获取奖品

登录
www.LEGO.com/productfeedback

给出关于此乐高®套装的简短反馈，
就有机会获得炫酷乐高奖品

《条款及条件》适用

GAGNE

Rends-toi sur
www.LEGO.com/productfeedback

et donne-nous quelques commentaires
sur ce produit LEGO® pour avoir une
chance de gagner un prix LEGO !

Voir Conditions Générales

경품 당첨 기회

www.LEGO.com/productfeedback

페이지로 이동하여 이 레고® 세트에 대한
간략한 피드백을 보내 주시고 멋진 레고
경품을 탈 수 있는 기회도 잡으십시오

약관 적용

GANA

Visita
www.LEGO.com/productfeedback

y envíanos tu opinión acerca de este
set LEGO®. ¡Participarás en el sorteo
de un premio LEGO!

Términos y Condiciones aplicables

ЗАПОЛНИ АНКЕТУ И ПОЛУЧИ ПРИЗ

Перейди по ссылке
www.LEGO.com/productfeedback

ответь всего на несколько во-
просов об этом наборе LEGO®,
и у тебя появится шанс выиграть за-
мечательный приз от компании LEGO.

Применяются Условия и правила
участия

LEGO and the LEGO logo are trademarks of the/son des marques de commerce du/
son marcas registradas de LEGO Group. ©2020 The LEGO Group.



BATMAN and all related characters and elements © & ™ DC Comics.
WB SHIELD: © & ™ WBEI. (s20)

6327715