



**STAR
WARS**



Disney

Booklet available in English on
Heft in deutscher Sprache erhältlich auf
Livret disponible en français sur
Libretto disponibile in italiano su
Folleto en español disponible en
如需中文版手册, 请访问

A RITE OF PASSAGE FOR EVERY LEGO® STAR WARS™ FAN

Even after four decades, the Rebel Alliance keeps growing in our galaxy as the *Star Wars*™ saga continues to excite new generations of fans. And where would the Alliance be without X-wing starfighters? These reliable starships have brought formidable Imperial forces to their knees in movies as well as other series like *Star Wars Rebels*, *The Mandalorian* and *The Book of Boba Fett*. The most memorable scene is, perhaps, the trench run in *A New Hope*, when Luke Skywalker in his X-wing launches a successful attack on the Death Star. Just as this scene was a rite of passage for young Skywalker, building your first LEGO® X-wing starfighter is a special occasion for many fans. Whether you're new to the fleet or have piloted others before, we're honoured to have you on our team.

Enjoy building!



Jens Kronvold Frederiksen
Creative Director, LEGO® Star Wars™



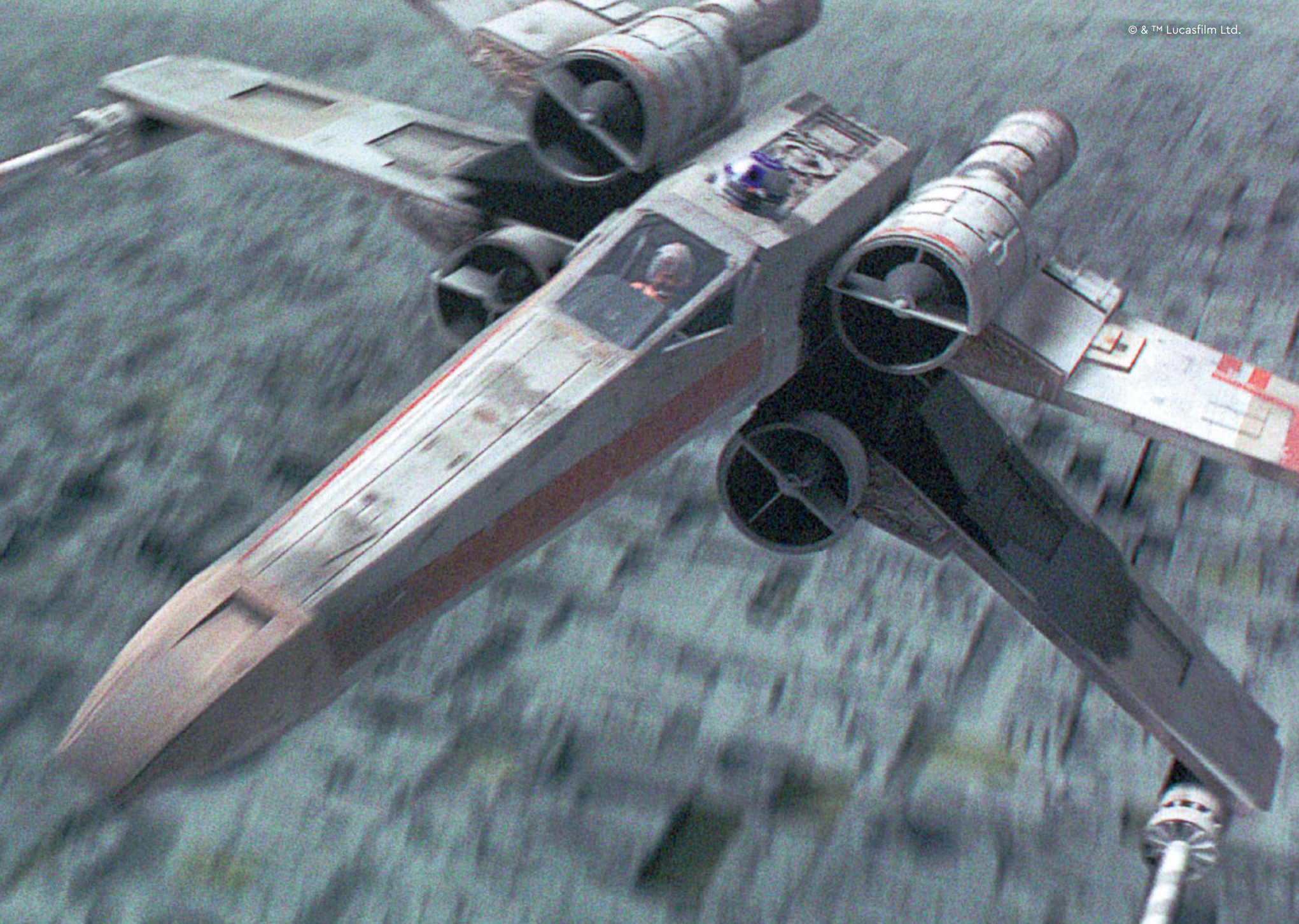



SPEED, PRECISION AND FIREPOWER

Like many other *Star Wars*™ starships and vehicles, X-wing starfighters are marked by the wear and tear of missions and battles. (As are their astromech droid co-pilots.) Nevertheless, these modestly sized crafts are no small feats of engineering and are favoured among Rebel pilots as sturdy, reliable and chock-full of character. Built for battle, with four laser cannons, two proton torpedo launchers and the ability to activate hyperdrive, they can manoeuvre with speed and precision and were instrumental in the successful evacuation of the Rebels' Echo Base on Hoth.

For the first movie scale models, Lucasfilm Ltd. model designers originally based the body of the X-wing starfighter on dragster car cockpits. While most scale models were created using plastic or metal, the X-wing starfighter models were carved out of wood and decorated to achieve the rugged look of aged starships riveted together, rather than a fleet of sleek, identical modern designs. It wasn't unusual for different models to be used to represent the same X-wing starfighter in various shots, and the full-scale models were highly detailed to add authenticity and depth to the closeup shots of Rebel pilots on the ground and in dogfights.



© & ™ Lucasfilm Ltd.



© & ™ Lucasfilm Ltd.

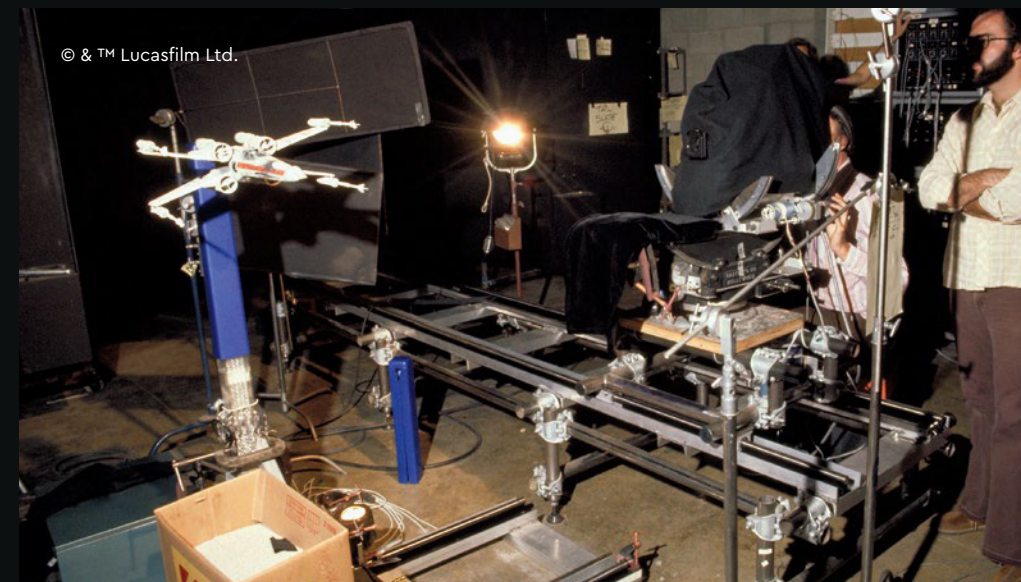

© & ™ Lucasfilm Ltd.



'RED FIVE STANDING BY.'

The T-65 X-wing starfighter is a mere 12.5 meters long and weighs 10 tons (metric). Fusial thrust engines generate a maximum speed of 1,050 kph and the smooth manoeuvring with the signature double wings gives pilots a clear advantage when dodging fire from enemy starships. The combination of a deflector shield projector and generator provides significant protection in battle, while torpedo launchers and laser cannons allow for precision attacks on fast-moving targets.

In case of crashes on swampy planets, or similar emergencies, the starfighter comes with a fully equipped survival kit including field rations to last the pilot a week. Letting an astromech droid serve as a combined navigation system and built-in mechanic is a stroke of genius by the Incom Corporation, as the droid may be used for multiple purposes on missions and on the ground – like transporting Death Star blueprints or disabling trash compactors.



MEET THE MODEL DESIGNER



Designer Henrik Andersen and
Creative Director Jens Kronvold Frederiksen
with the T-65 X-wing starfighter

'Every time we release a new LEGO® X-wing starfighter, we hear from *Star Wars*™ fans who want to share their excitement after they have built their first one. It's a familiar feeling. I have worked as a LEGO Model Designer for over 25 years now, and the first model I ever worked on was the first Ultimate Collector Series X-wing starfighter (set 7191 released in 2000). There are always new details or techniques to explore and, like their movie model counterparts, each version we have released has its own unique characteristics.'

'It was a high priority to decorate the cockpit. This is the first time we have done that. We developed new wing plates to get the correct angle on the rear edge of the wings. To increase the size of the engines, we created a new wall element, too. In the films, we see Luke in a few different variations of the cockpit of the legendary Red Five and we wanted to incorporate the best of these versions.'

Henrik Andersen
LEGO® *Star Wars*™ Designer

Designer Henrik Andersen with the new T-65 X-wing starfighter (left) and 7191 X-wing starfighter from 2000 (right)

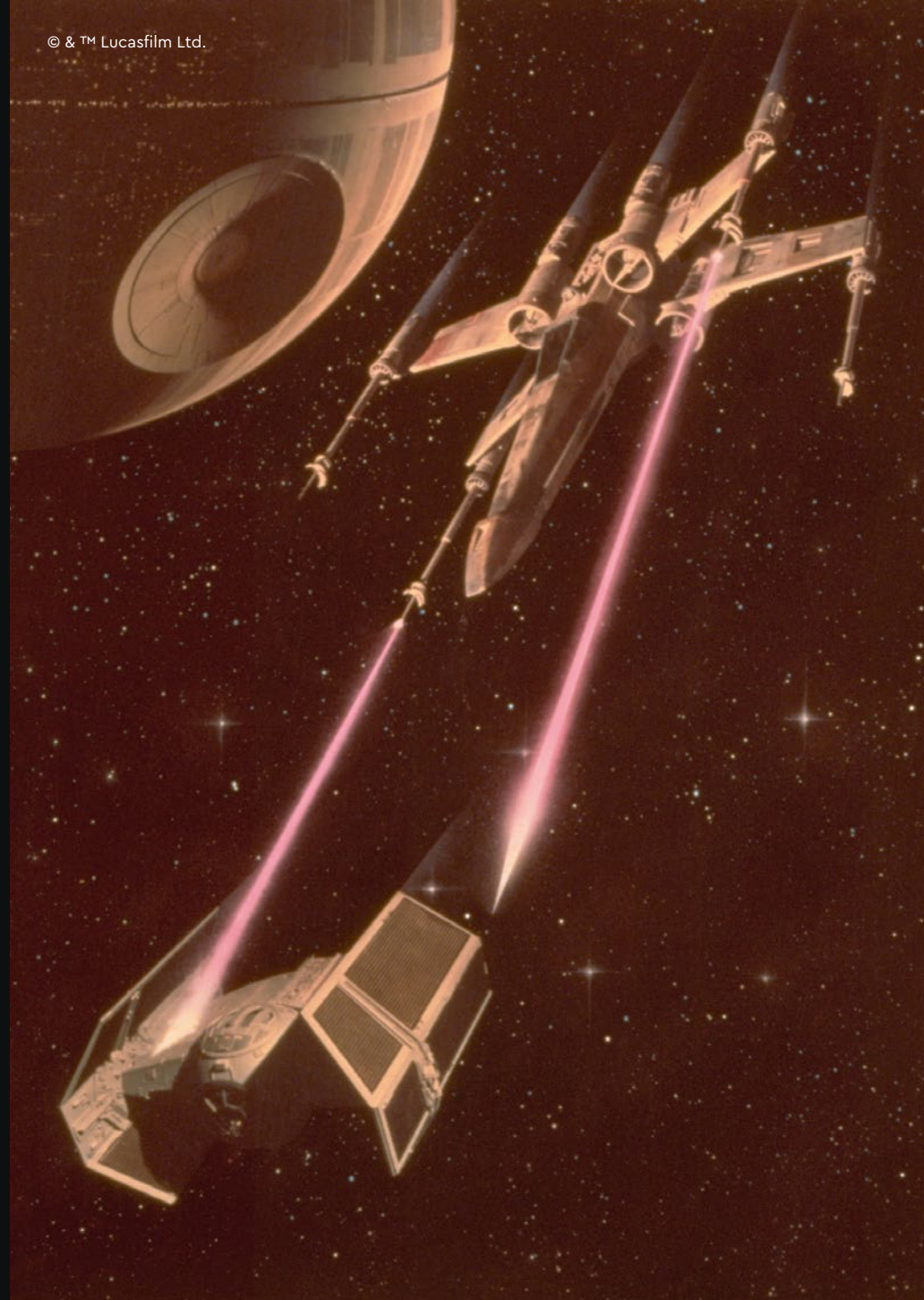

RECREATING AN ICONIC INCOM CORPORATION DESIGN

This set is a detailed display model of the X-wing starfighter Luke Skywalker pilots in the Original Trilogy and later in *The Mandalorian* series, incorporating key elements of each version:

- Opening canopy reveals the decorated cockpit
- Retractable targeting sight
- Folding wings function
- For the first time, the information plaque is decorated, replacing stickers previously used in Ultimate Collector Series
- New Luke Skywalker Rebel pilot uniform with new arm printing and new leg elements
- New engine construction
- Space for the R2-D2 minifigure in the socket behind the cockpit



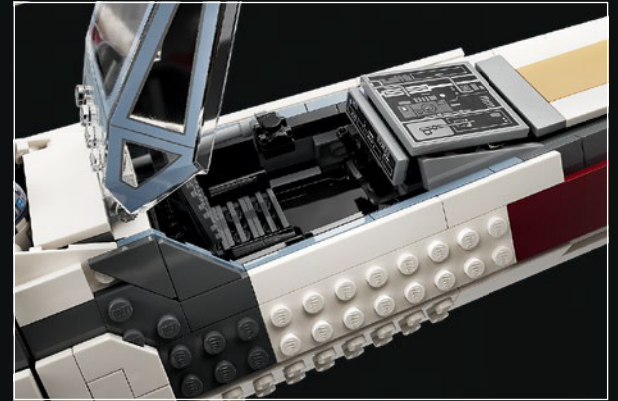
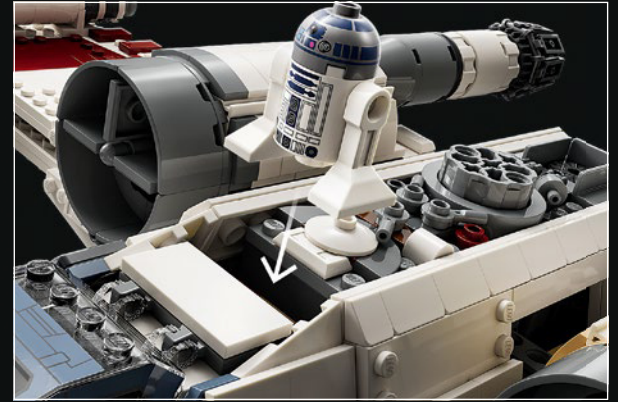

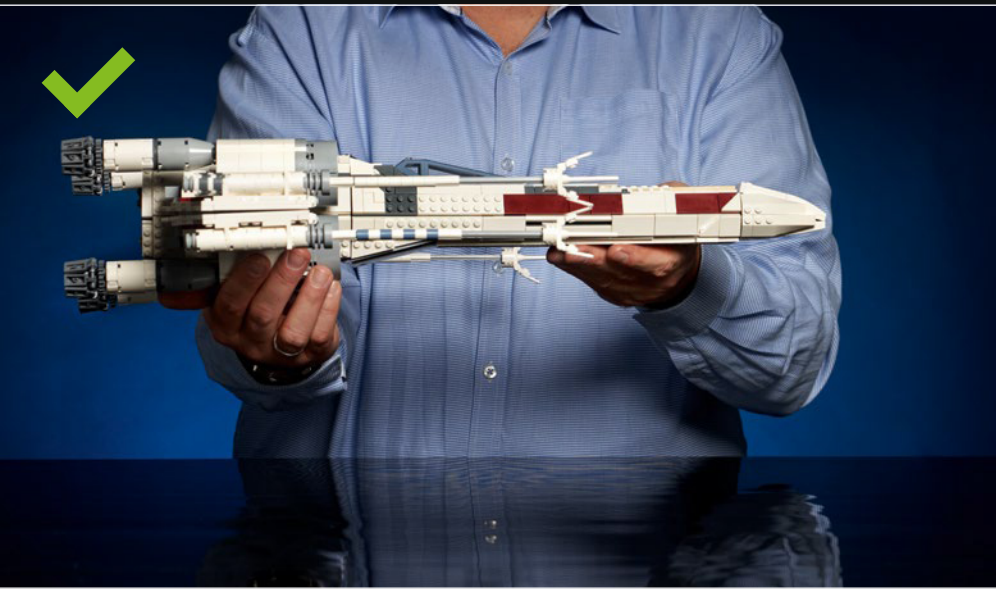



FR

**DONNEZ
OU
RECYCLEZ**



ASSOCIATION
OU



MAGASIN
OU



DÉCHÈTERIE

Adresses sur quefairedemesdechets.fr



LEGO.com/sustainable-packaging

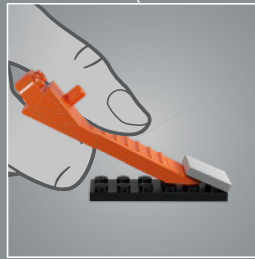
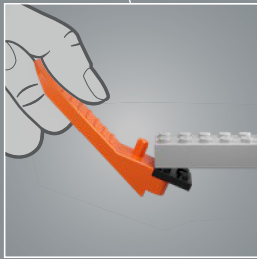
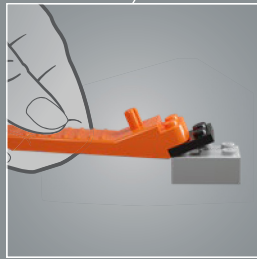
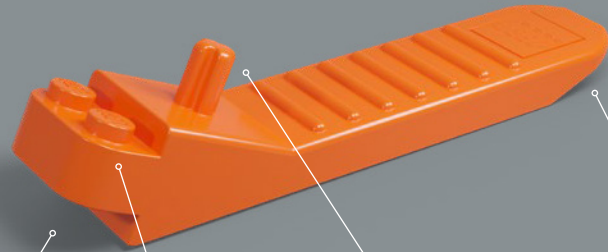

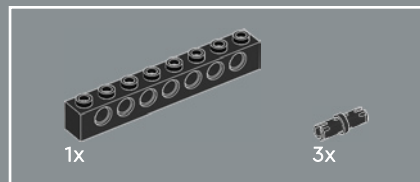

1

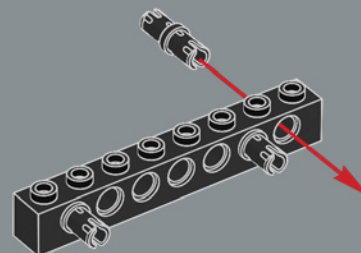

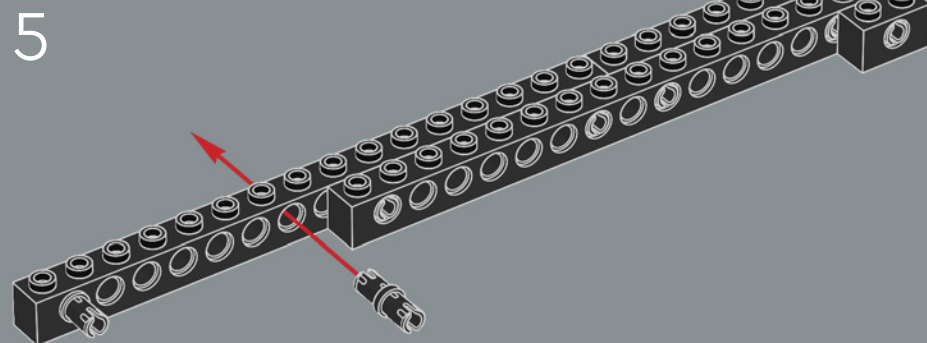
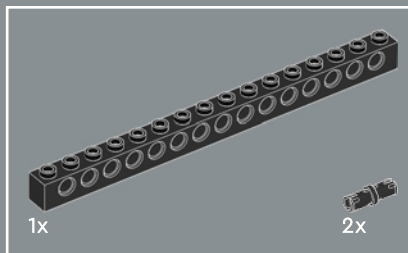
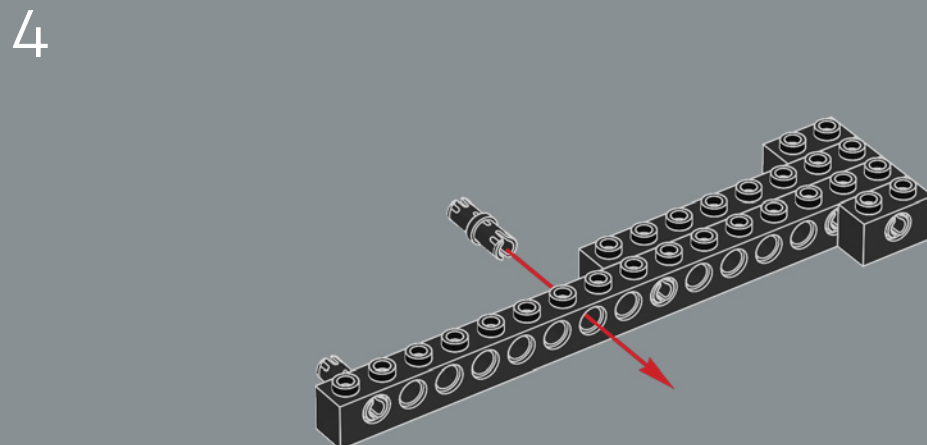
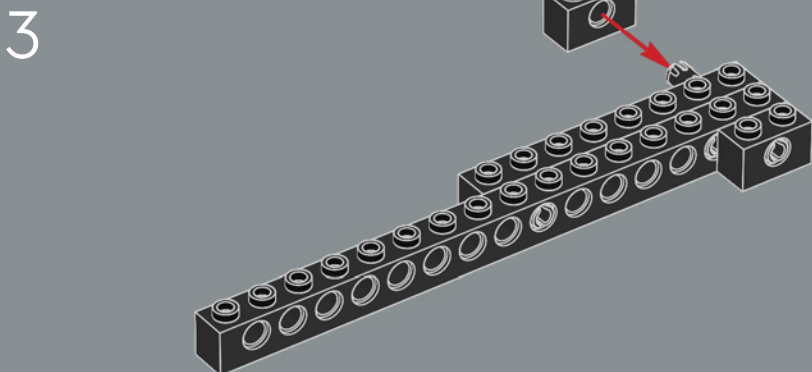
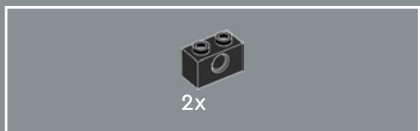
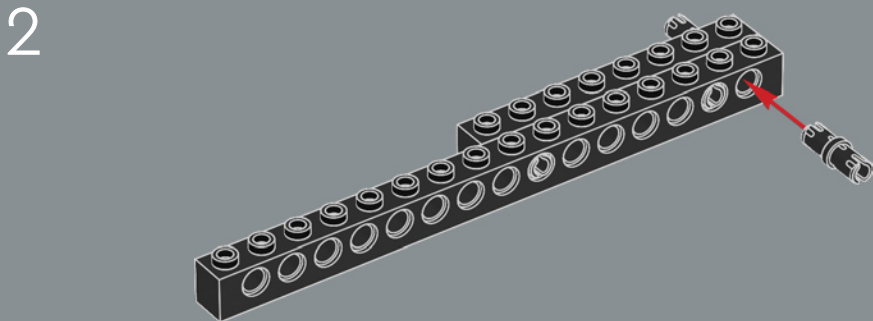
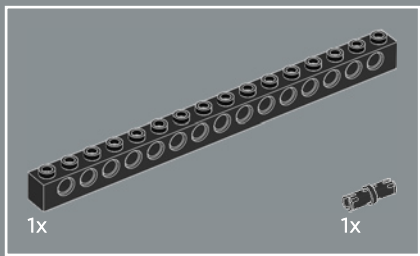

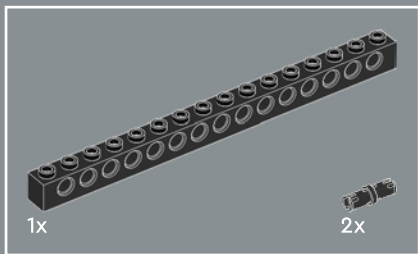

6

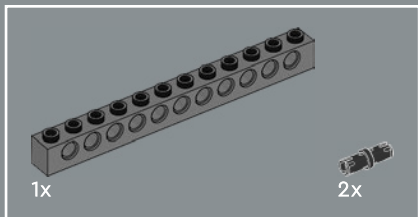
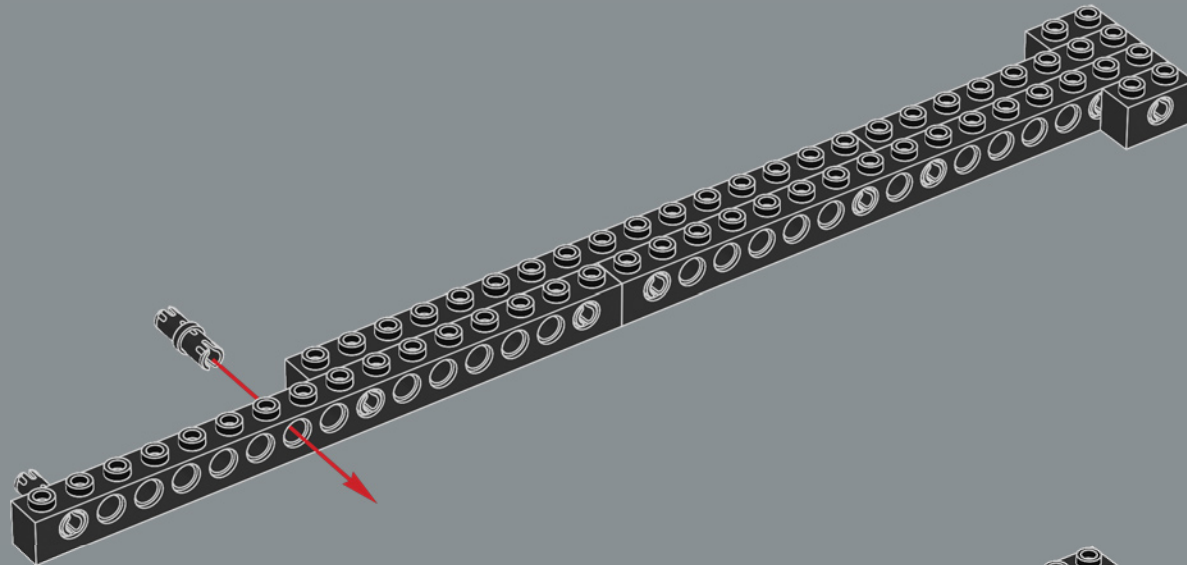

7

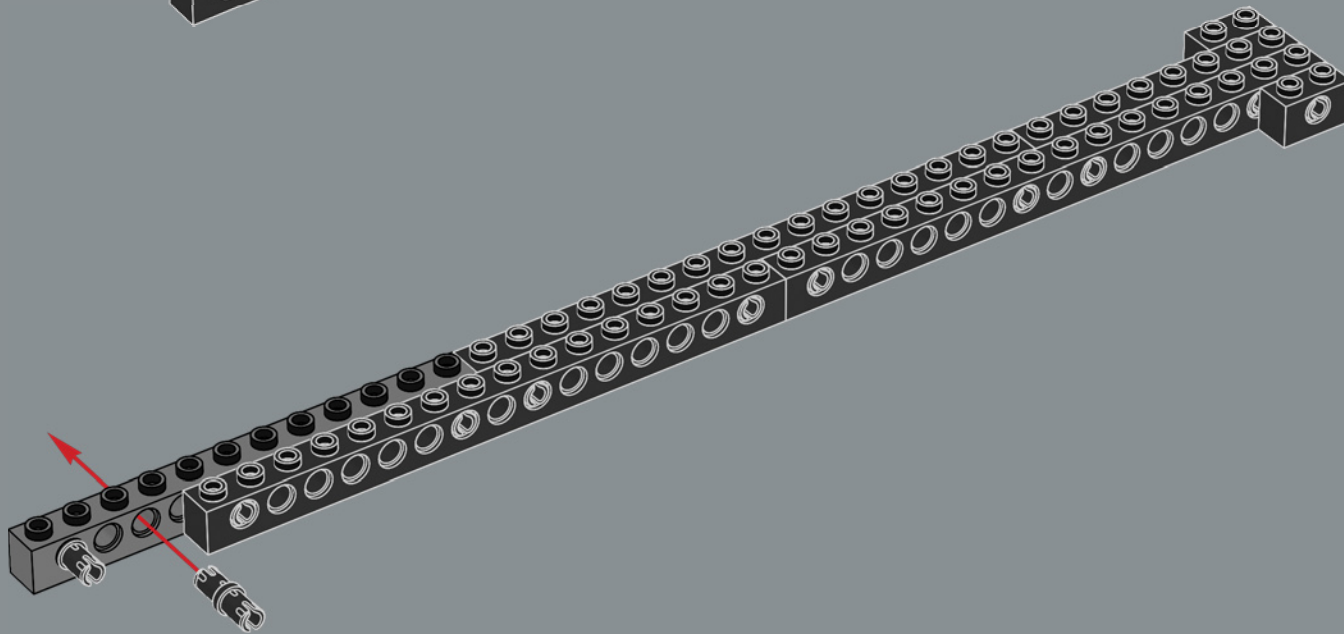

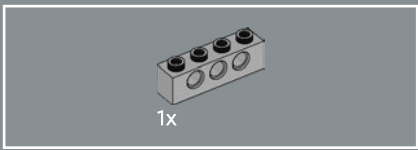

8

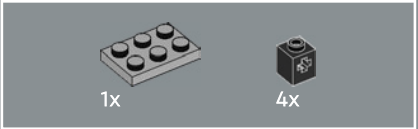
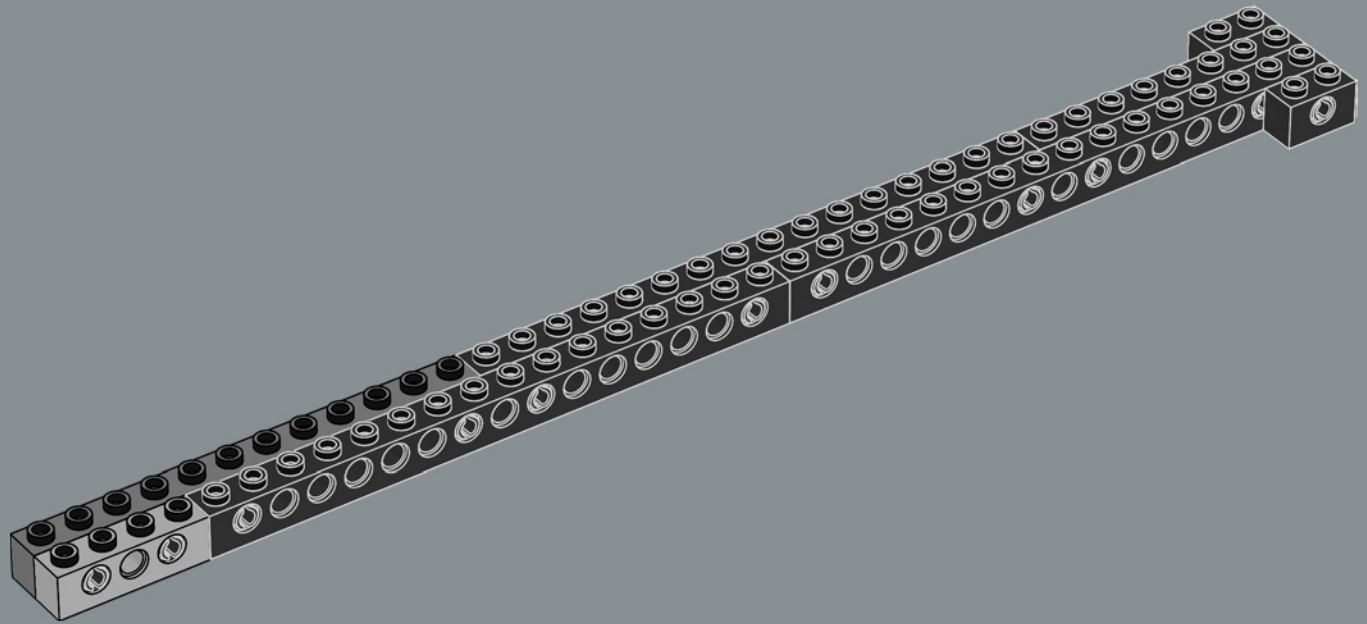

9

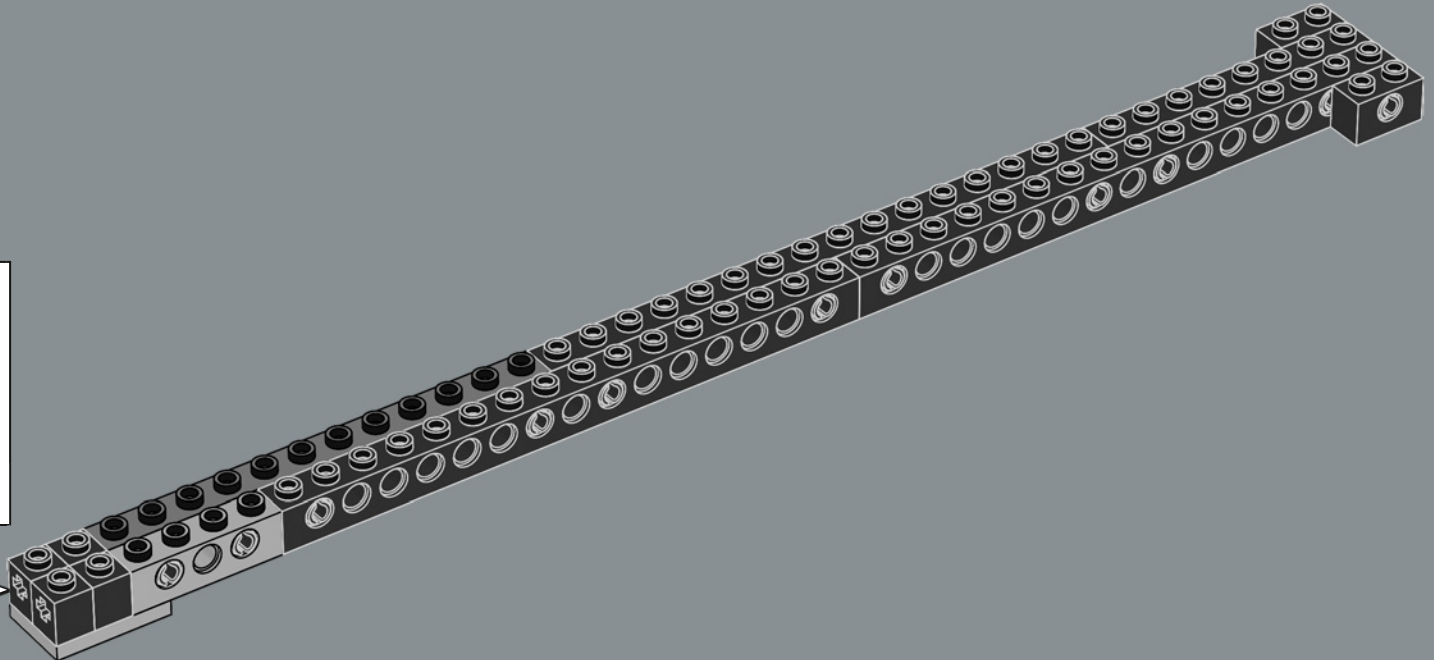
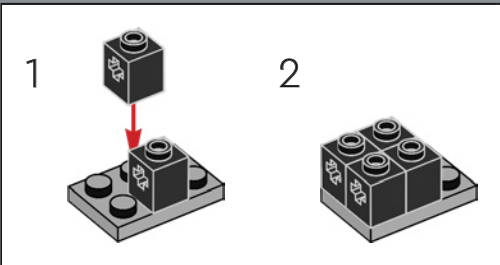

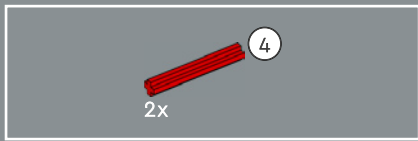

10

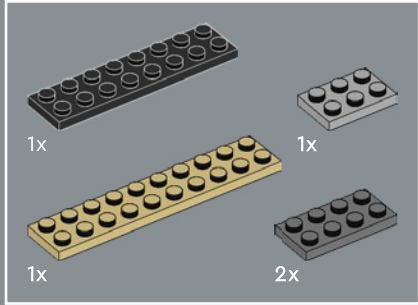
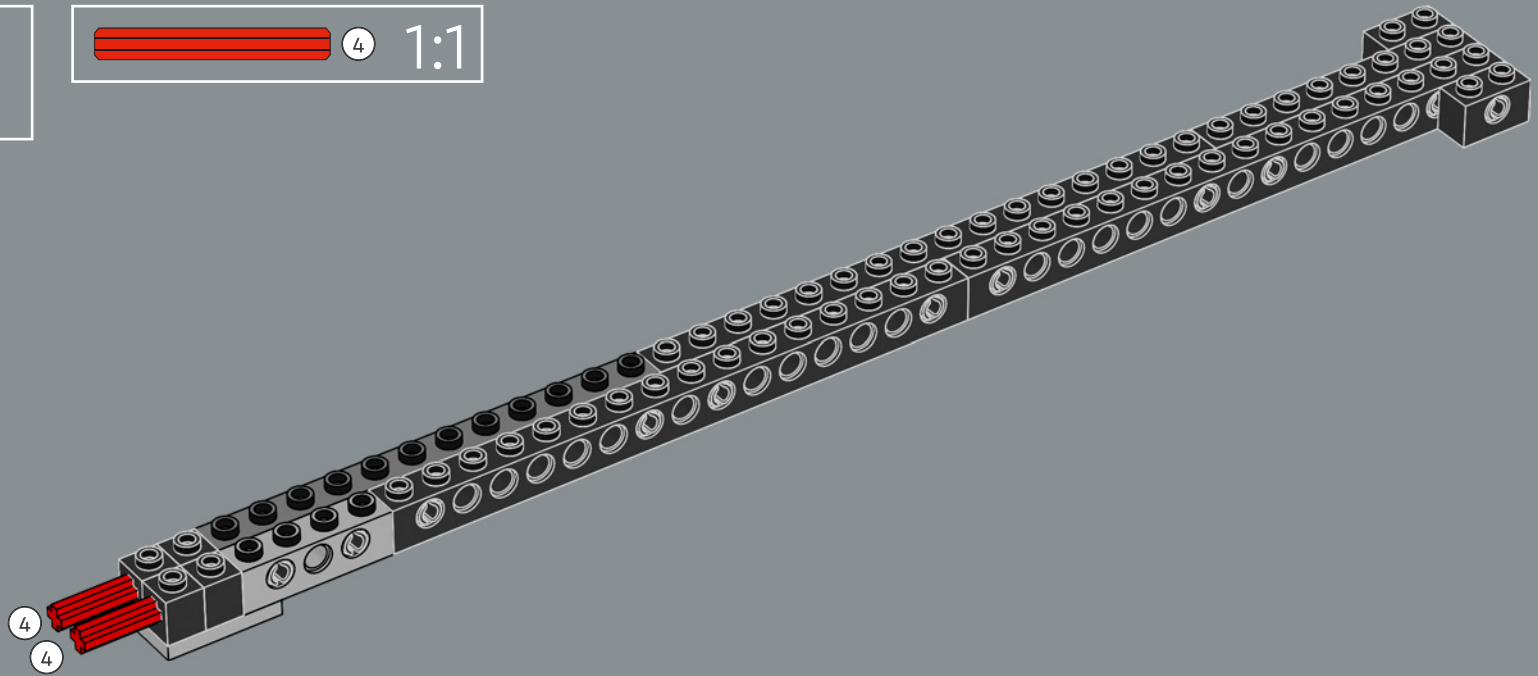

11

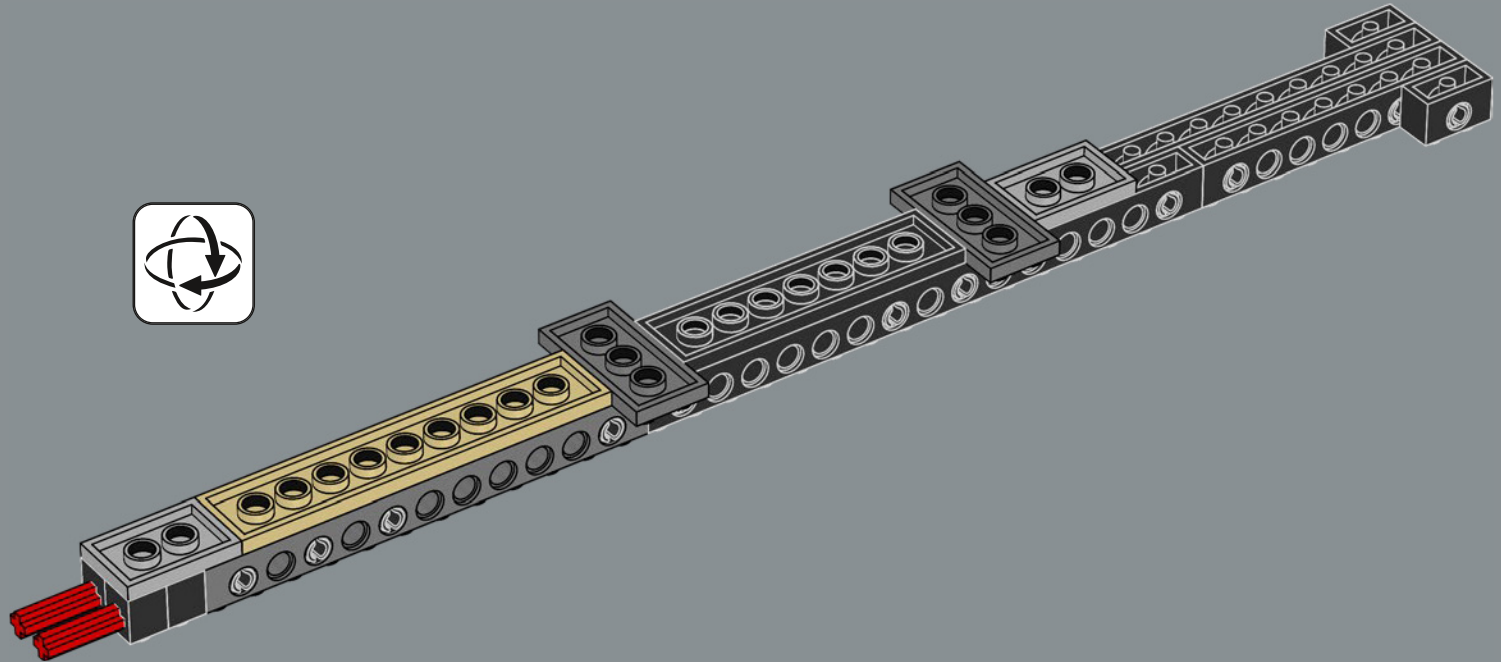

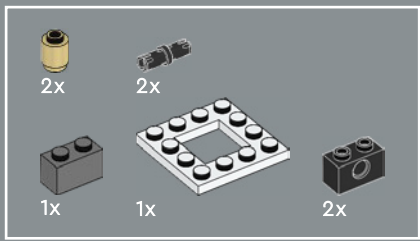

12

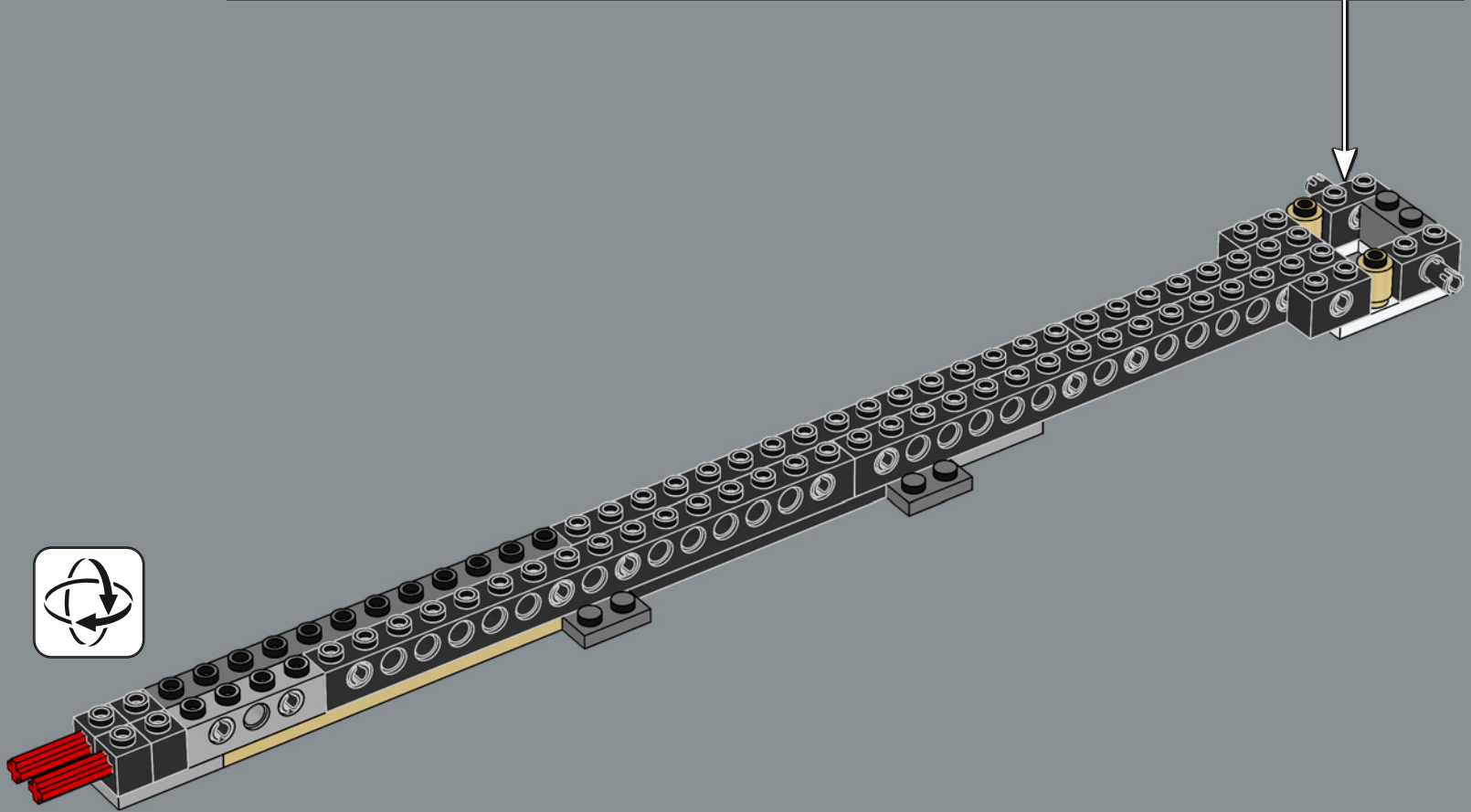
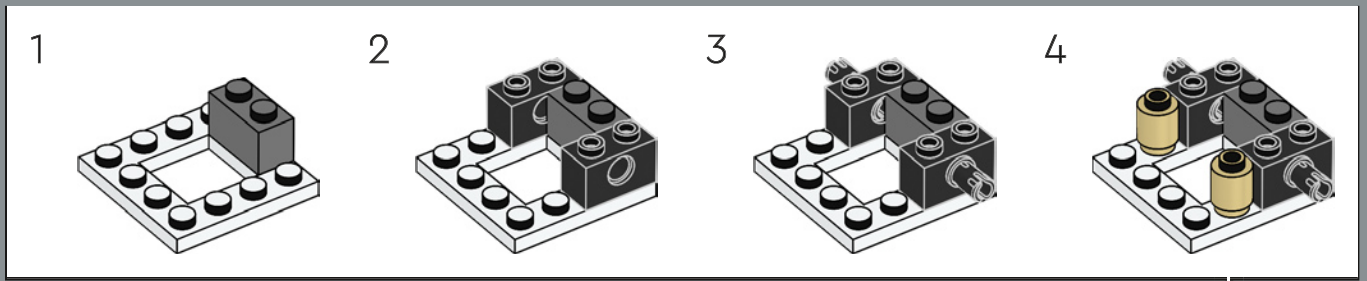

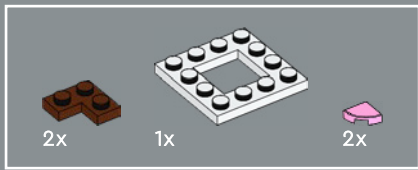

13

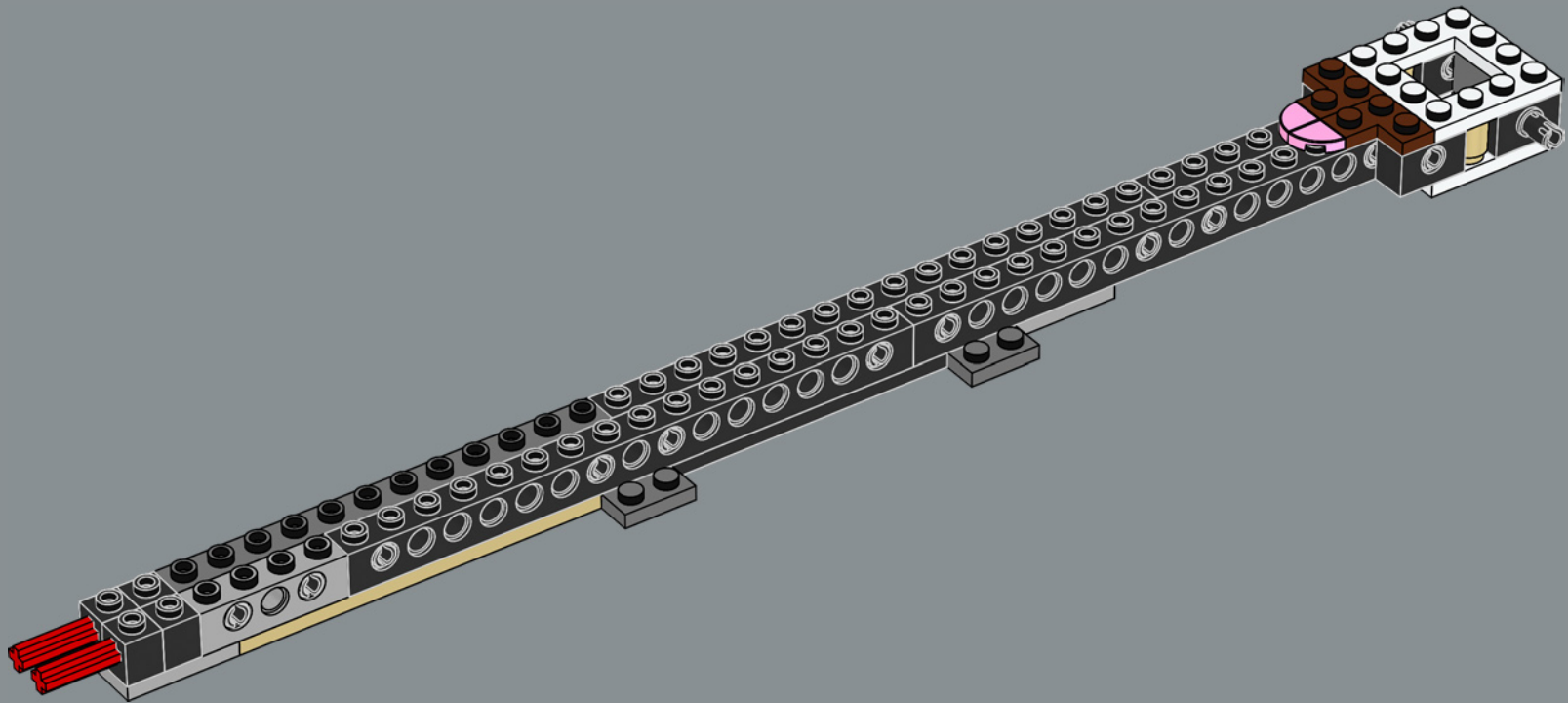

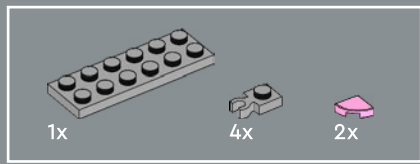

14

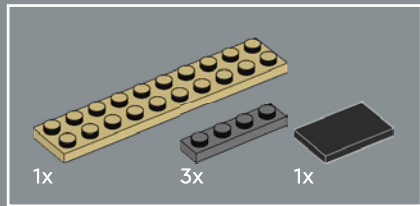
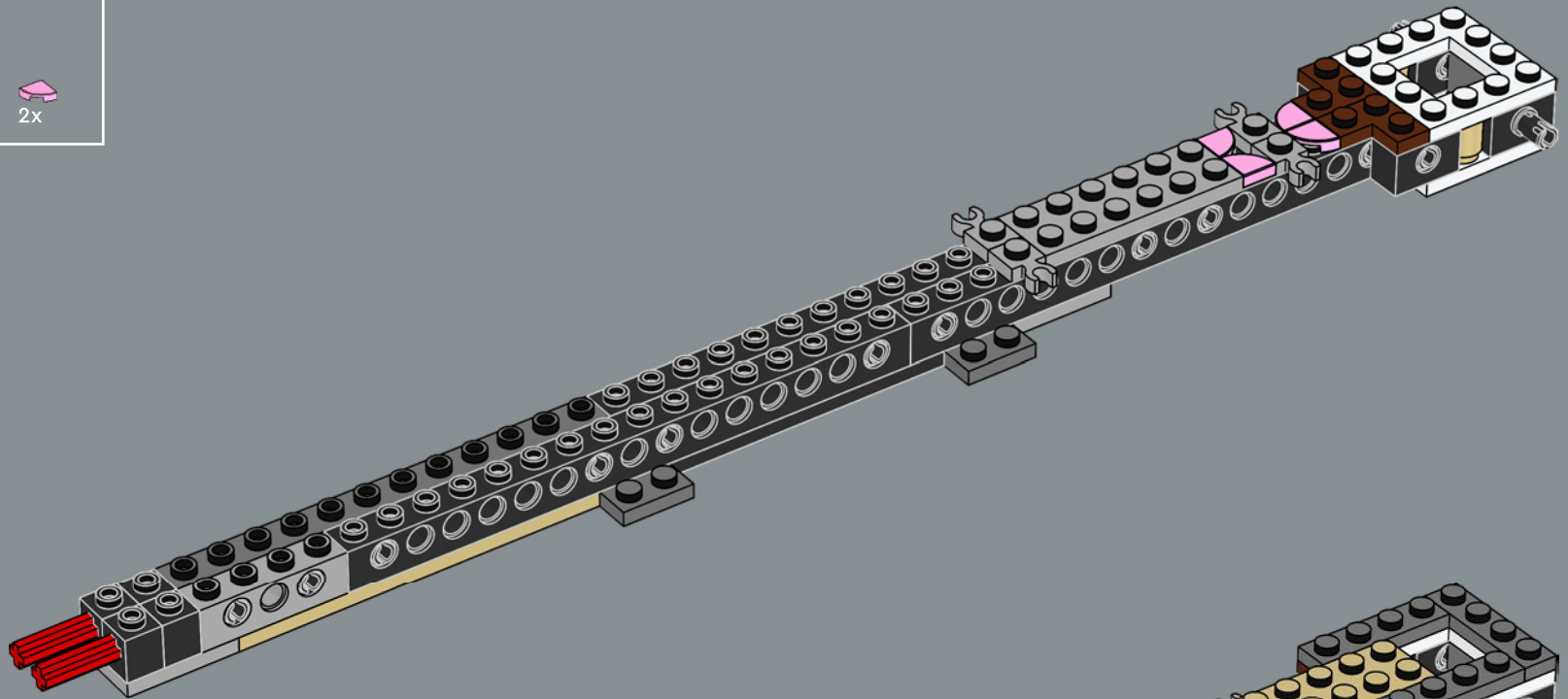

15

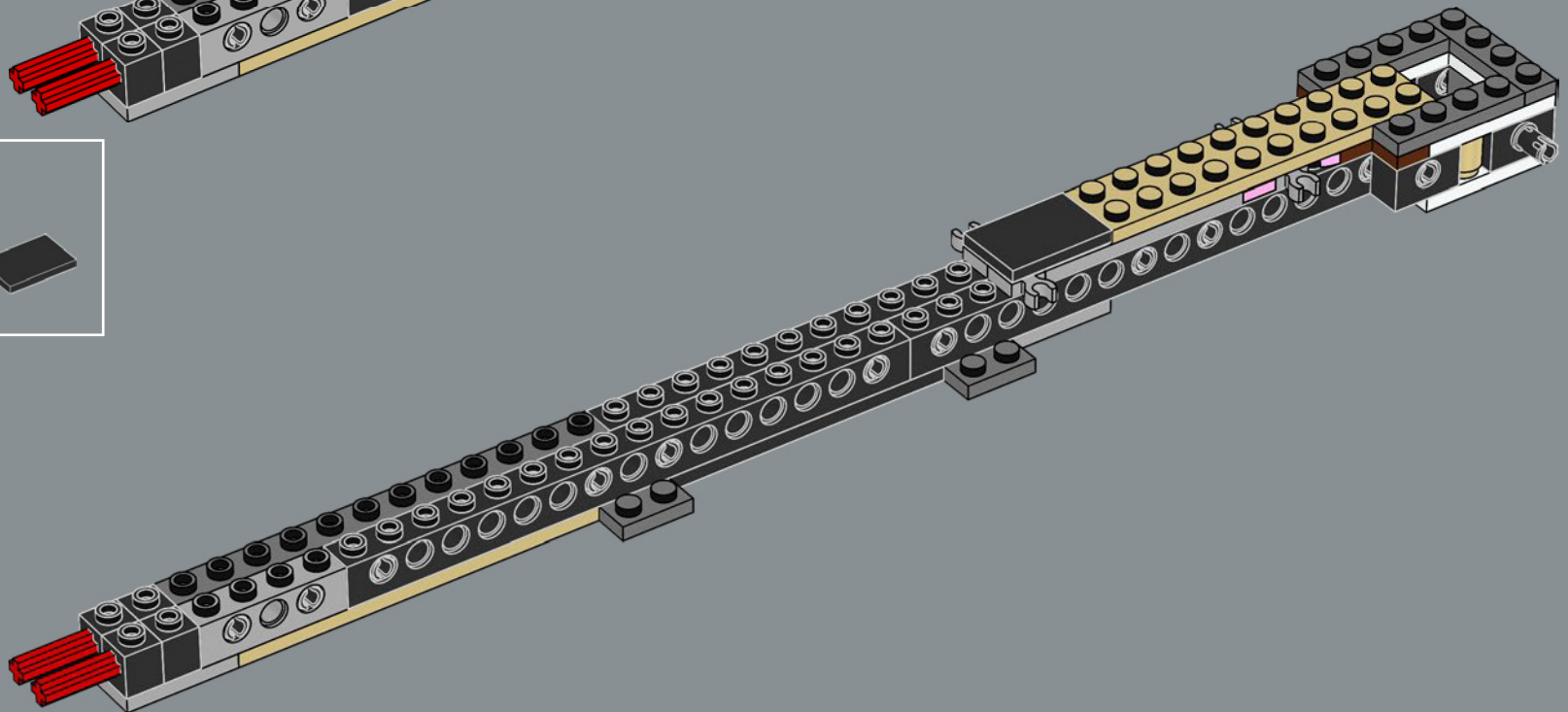

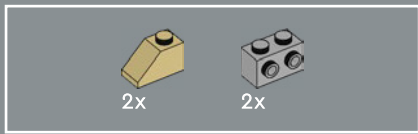

16

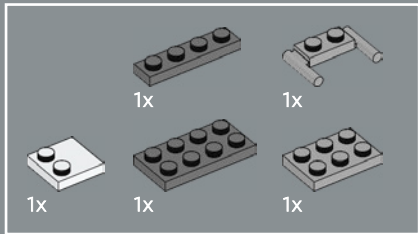
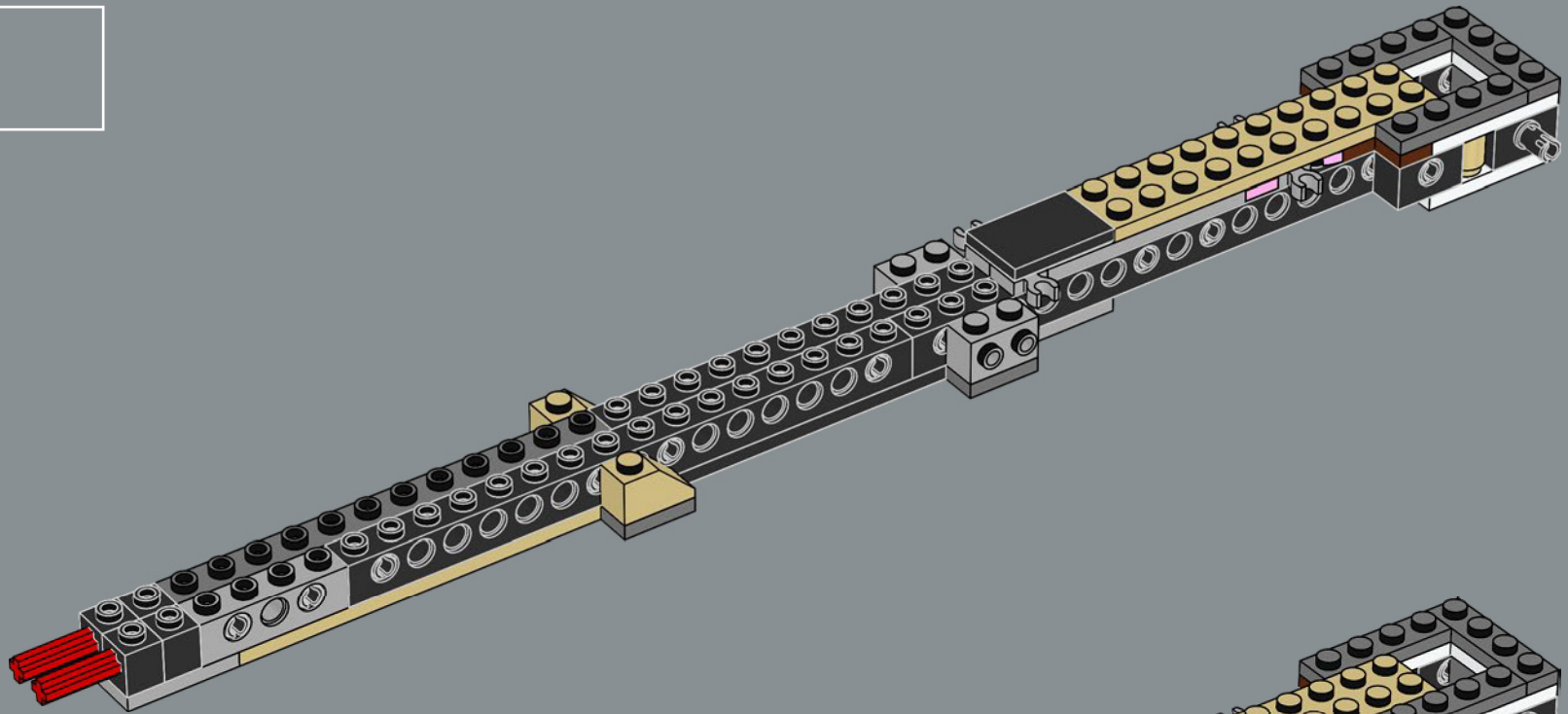

17

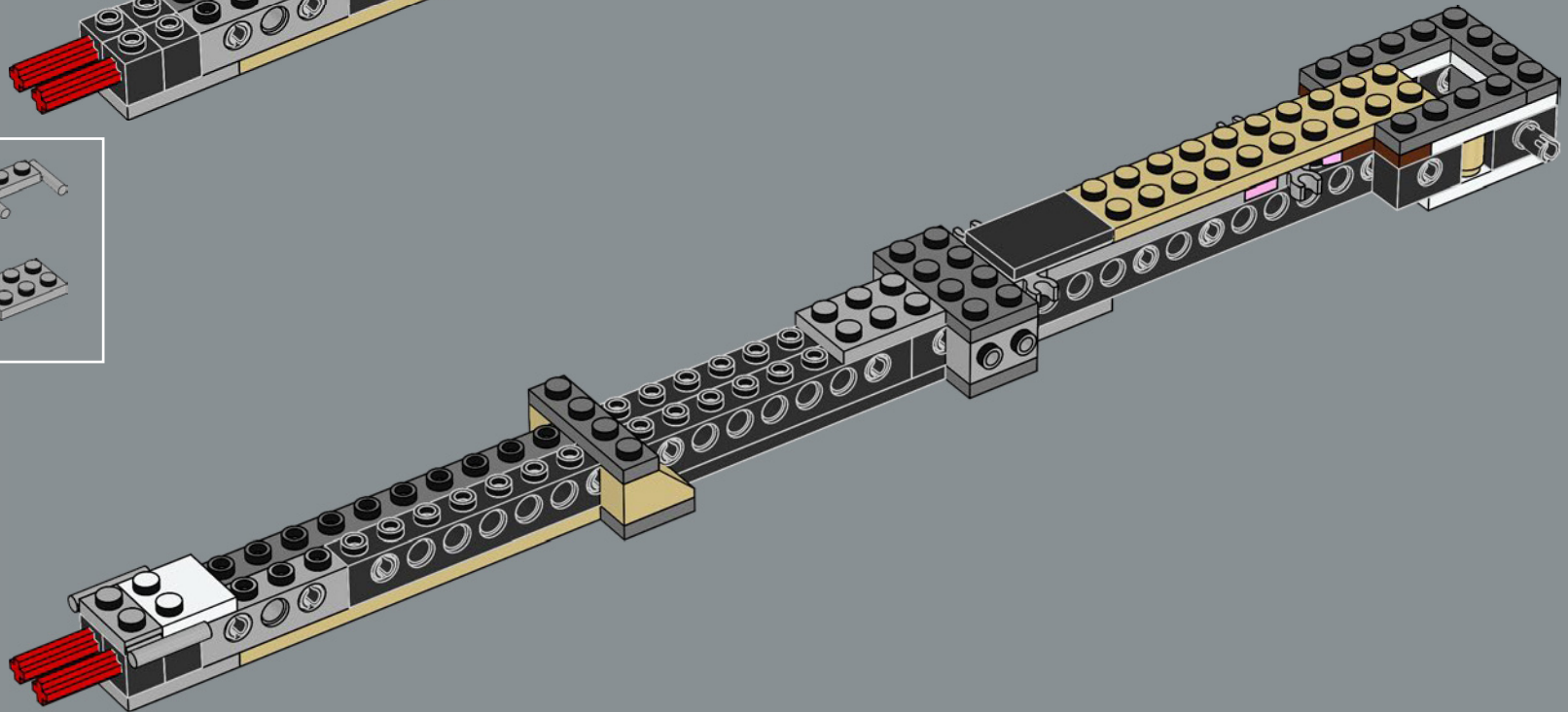

18

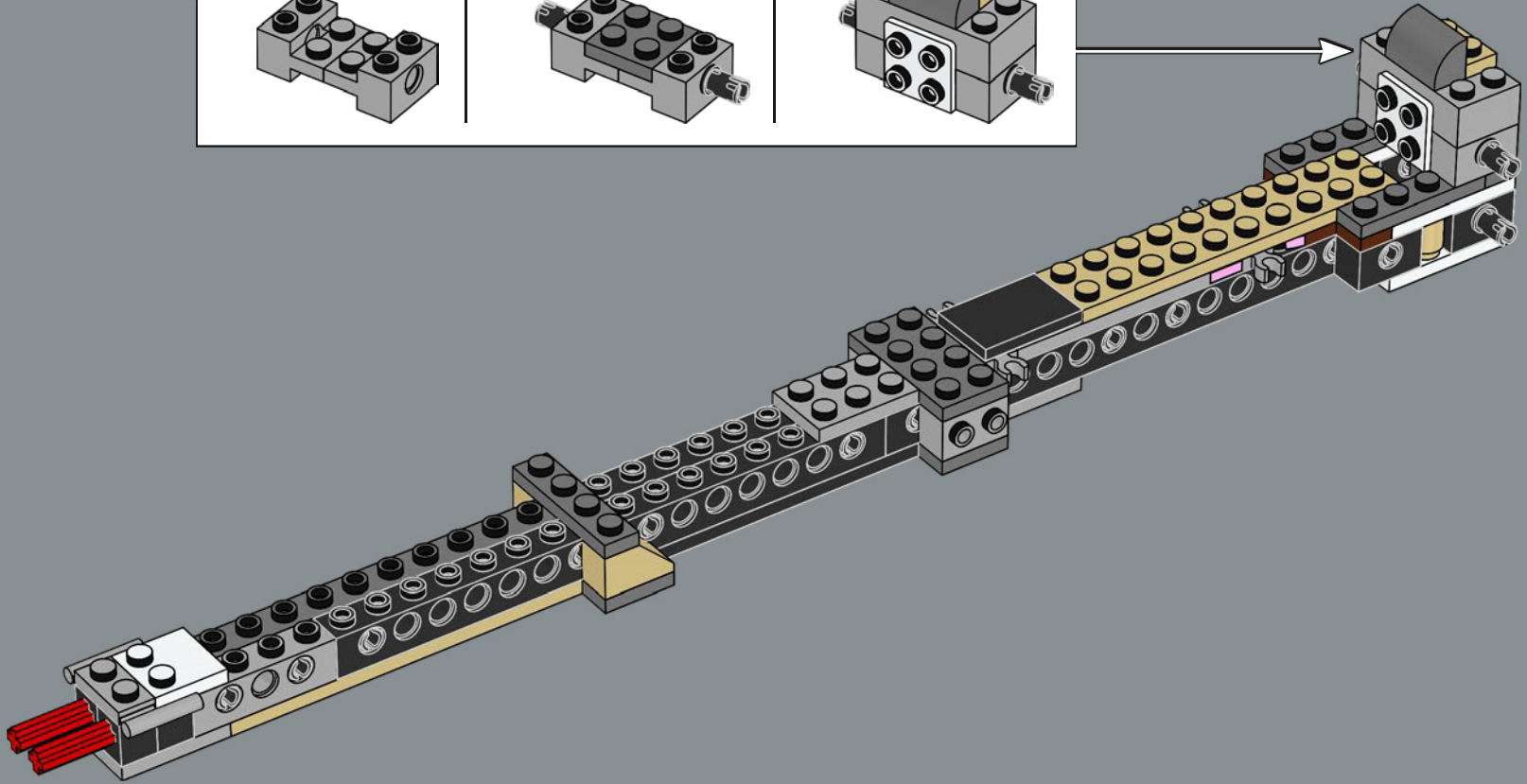
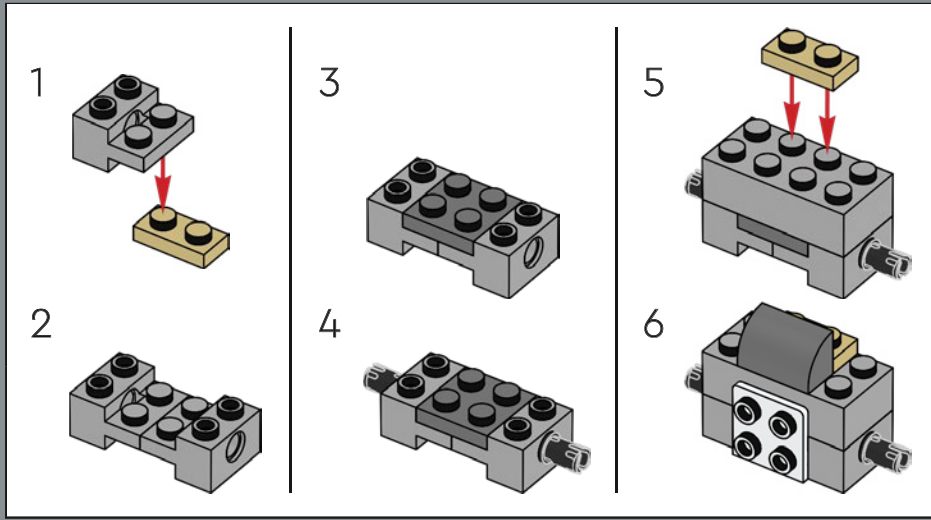
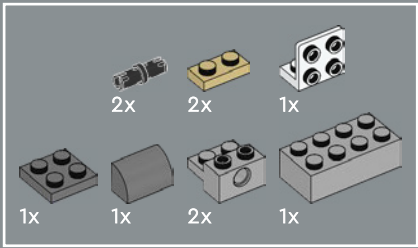

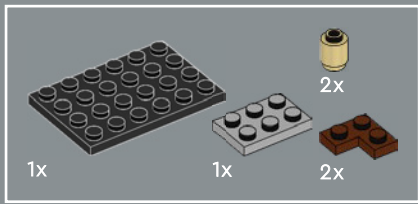

19

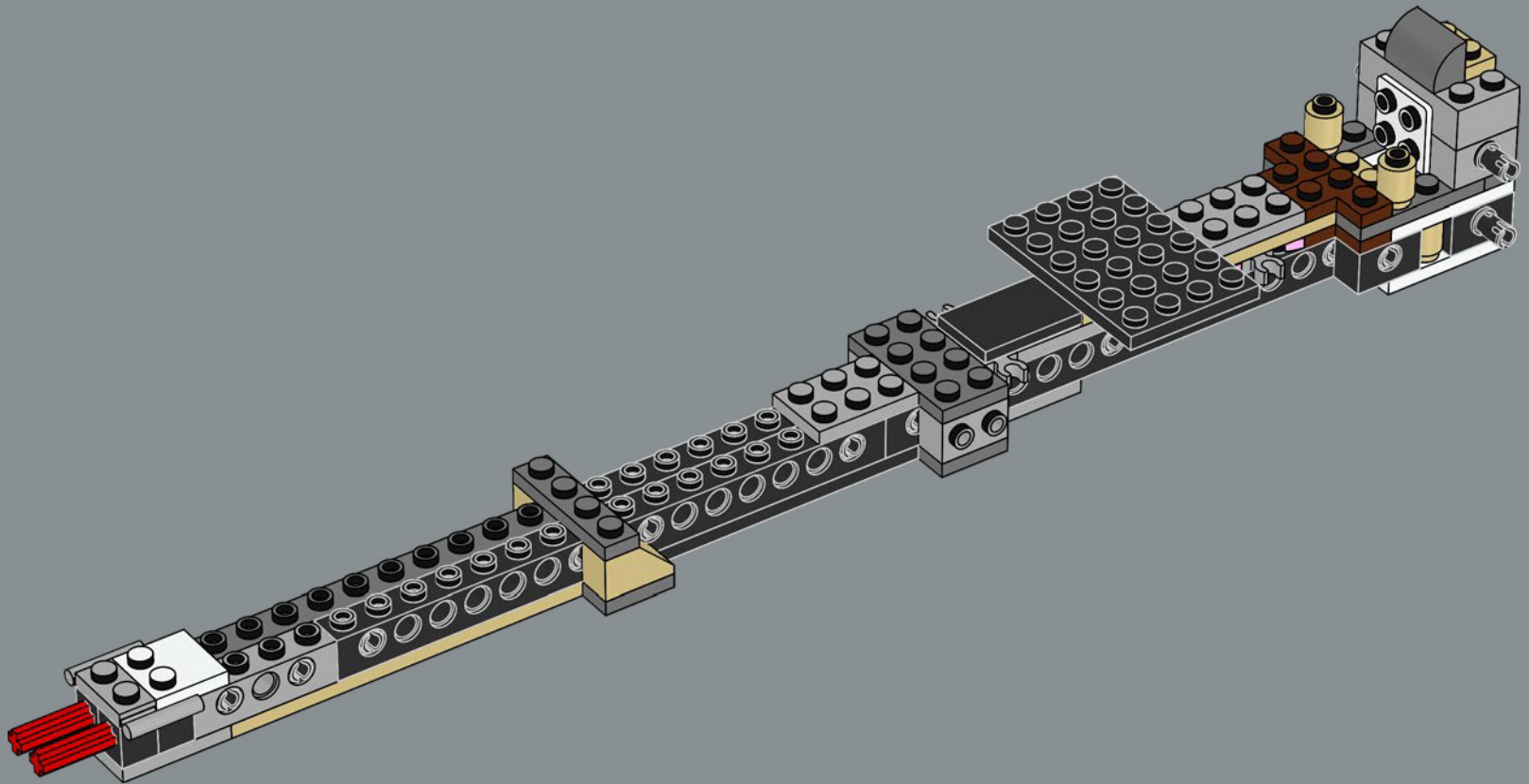

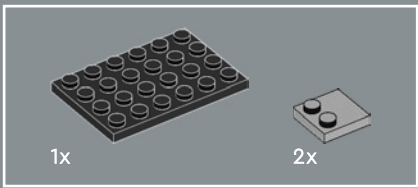

20

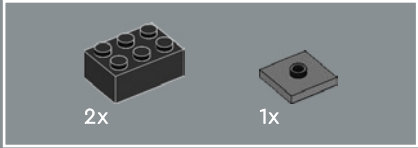
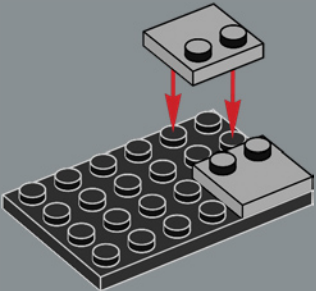

21

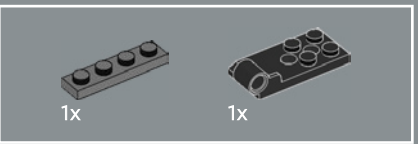
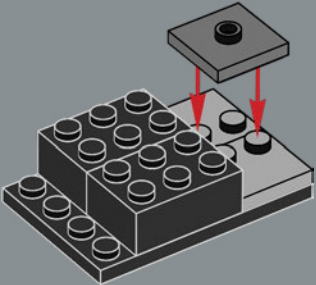

22

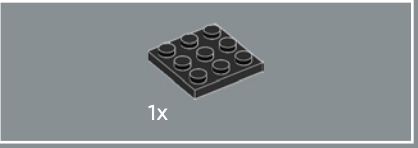
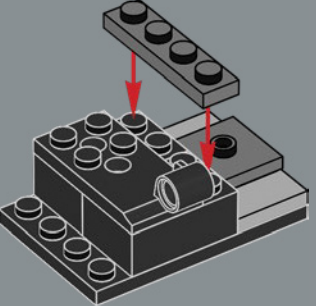

23

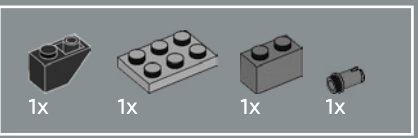
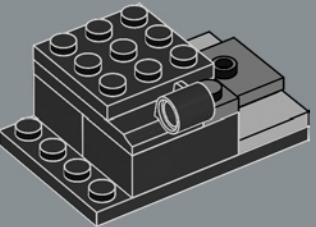

24

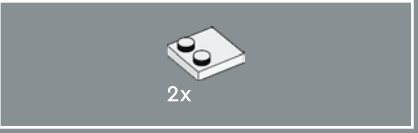
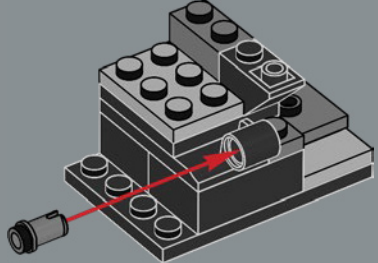

25

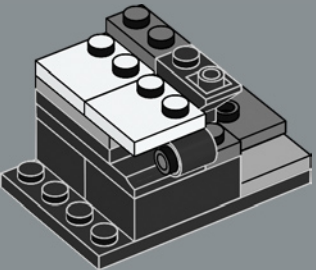

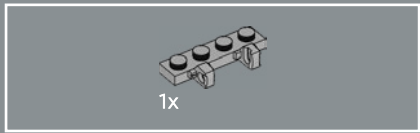

26

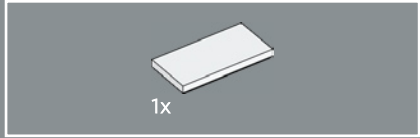
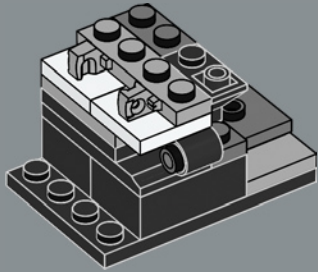

27

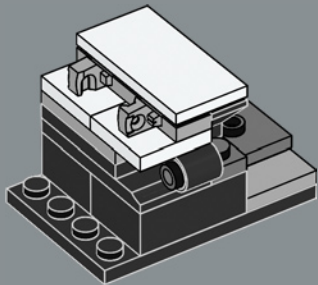

28

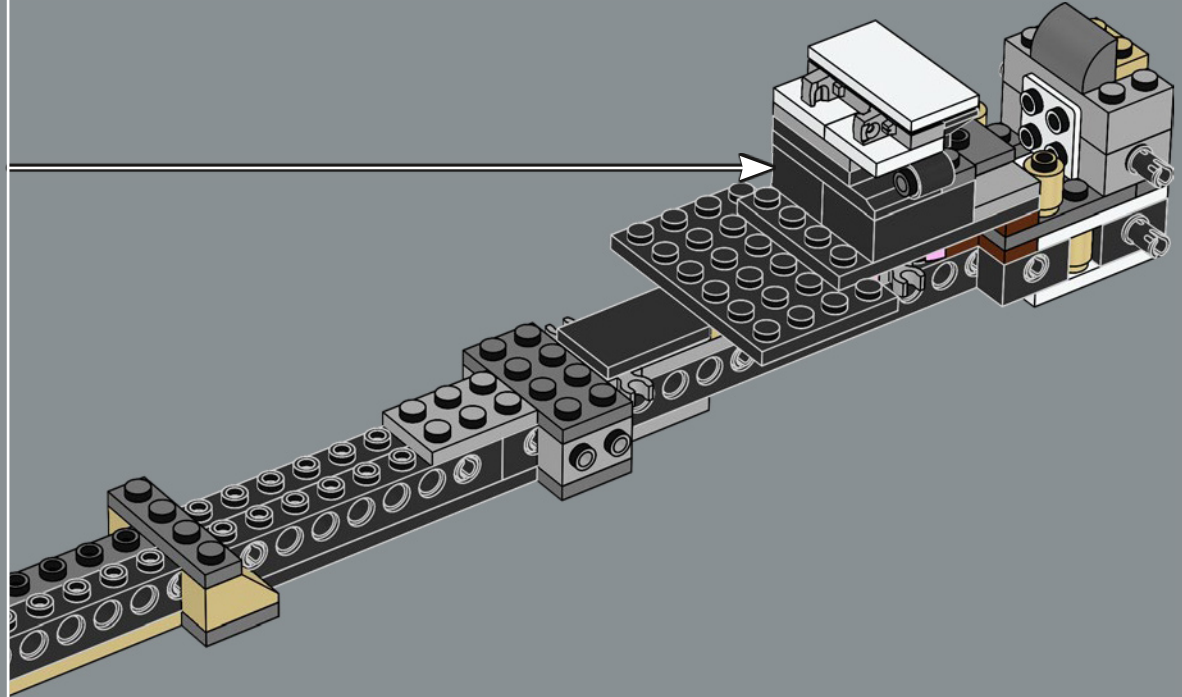



3x



4x

29

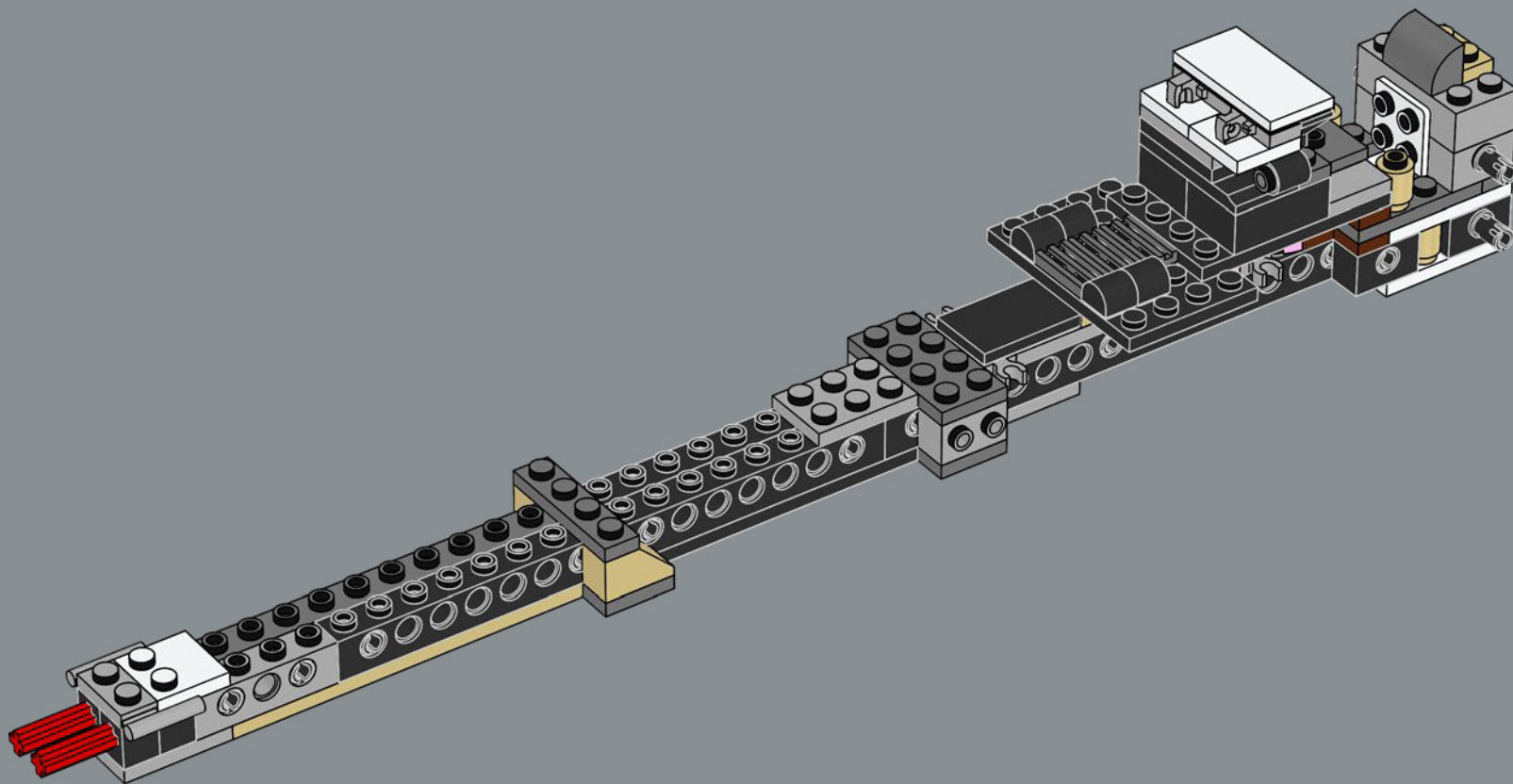

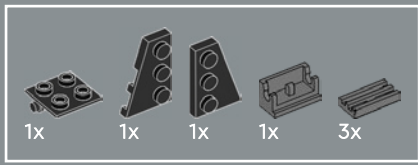

30

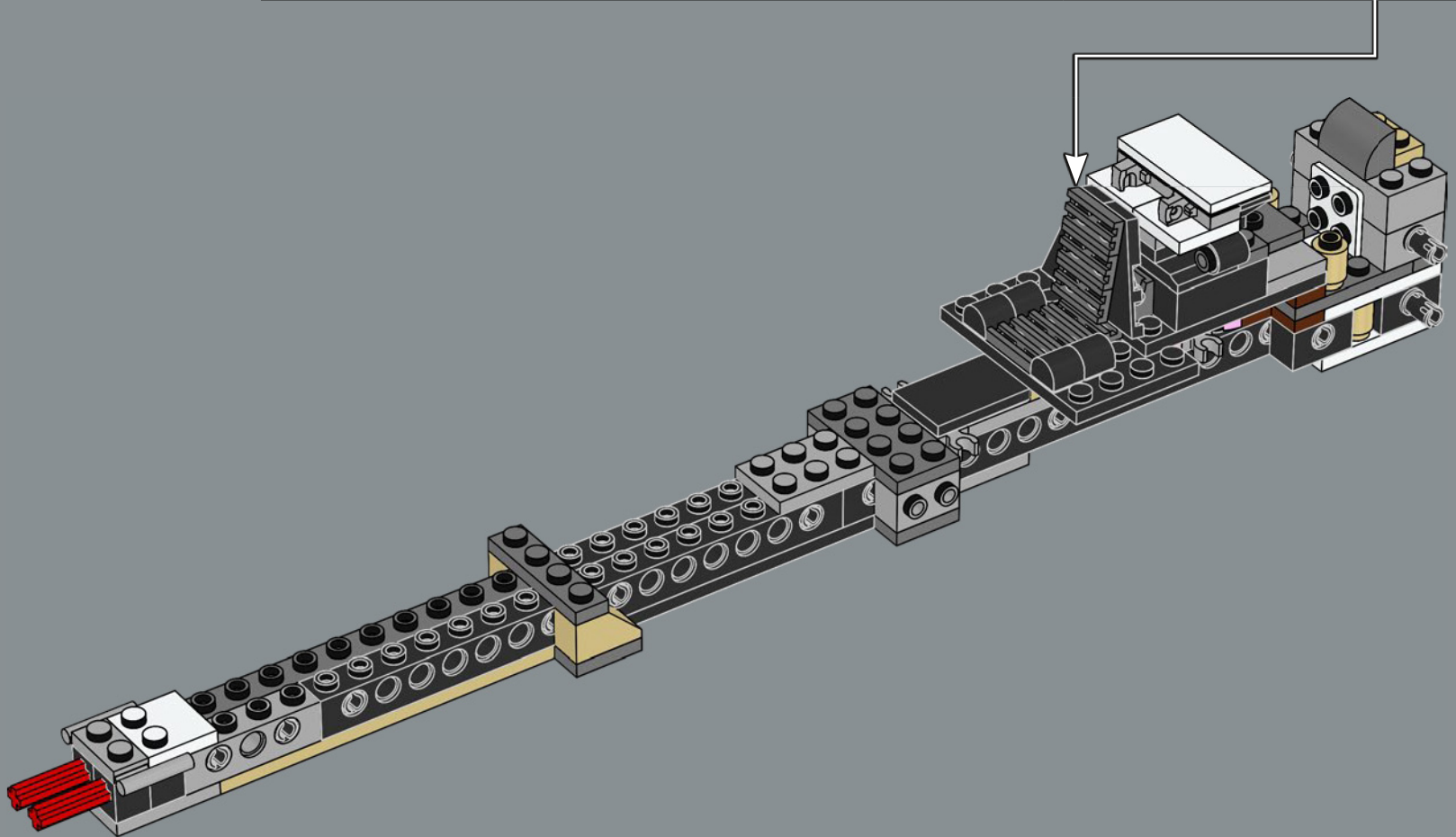
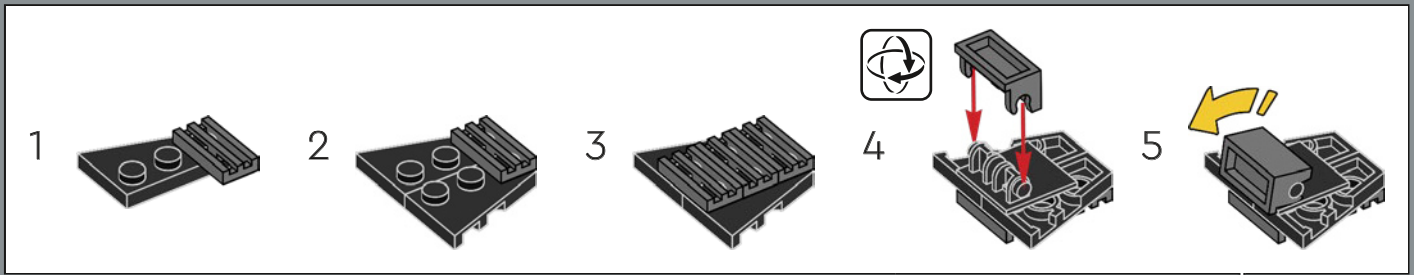

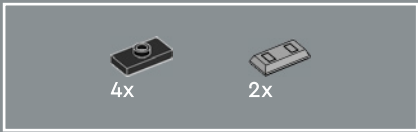

31

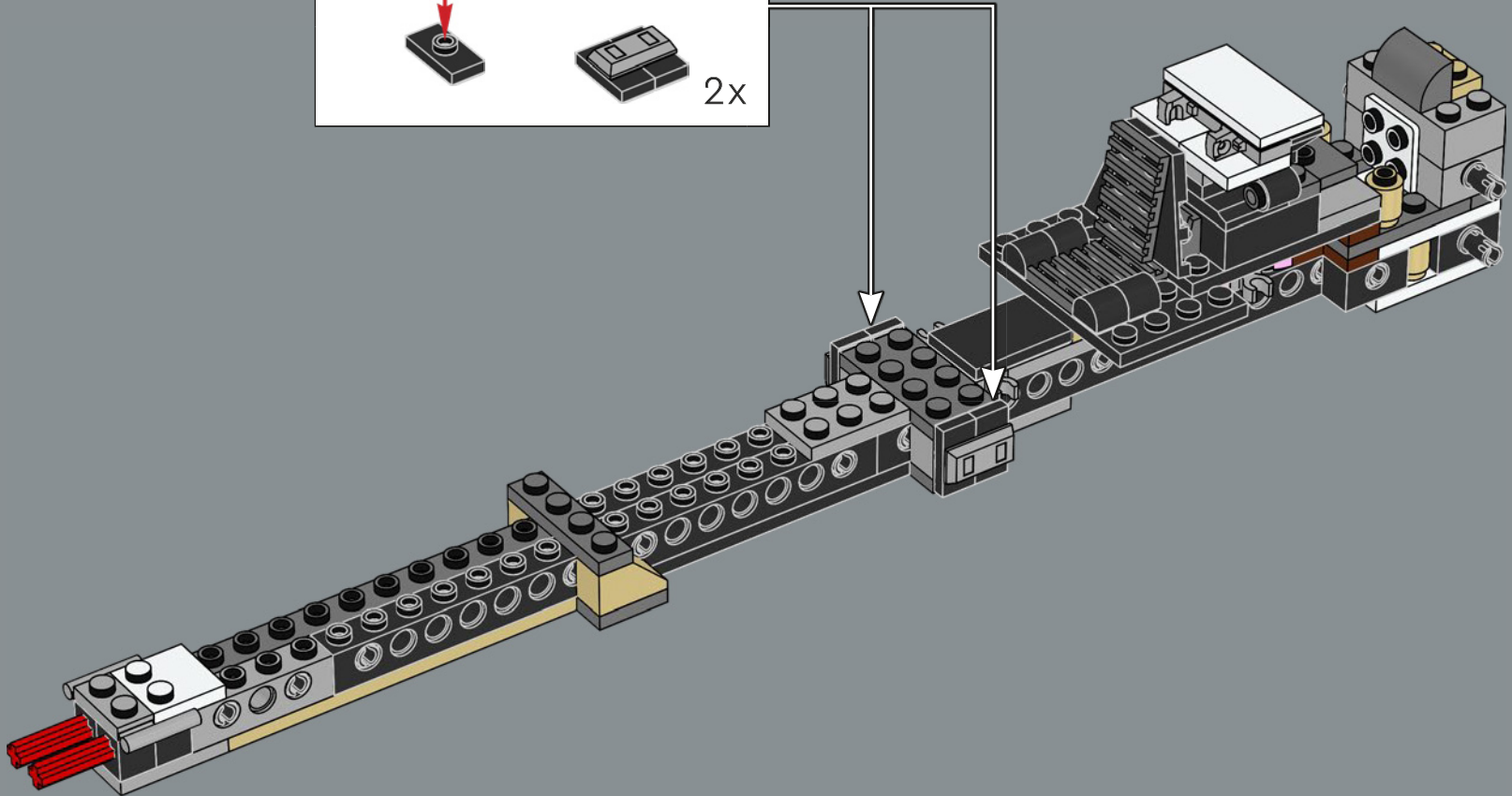
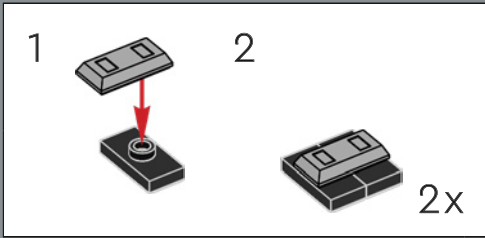

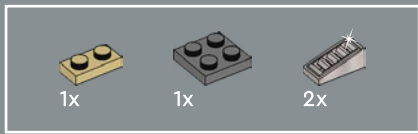

32

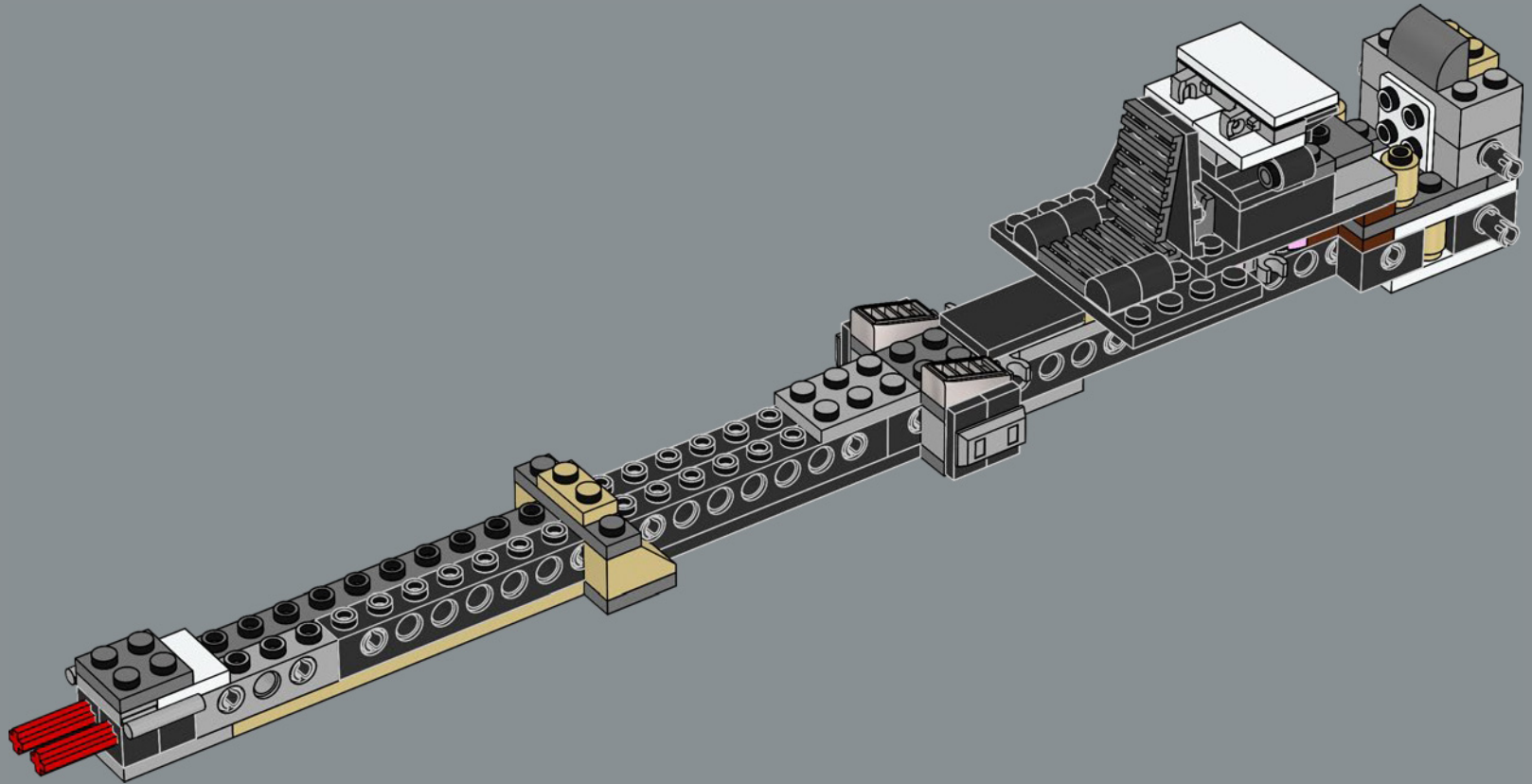

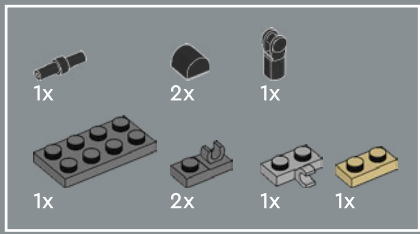

33

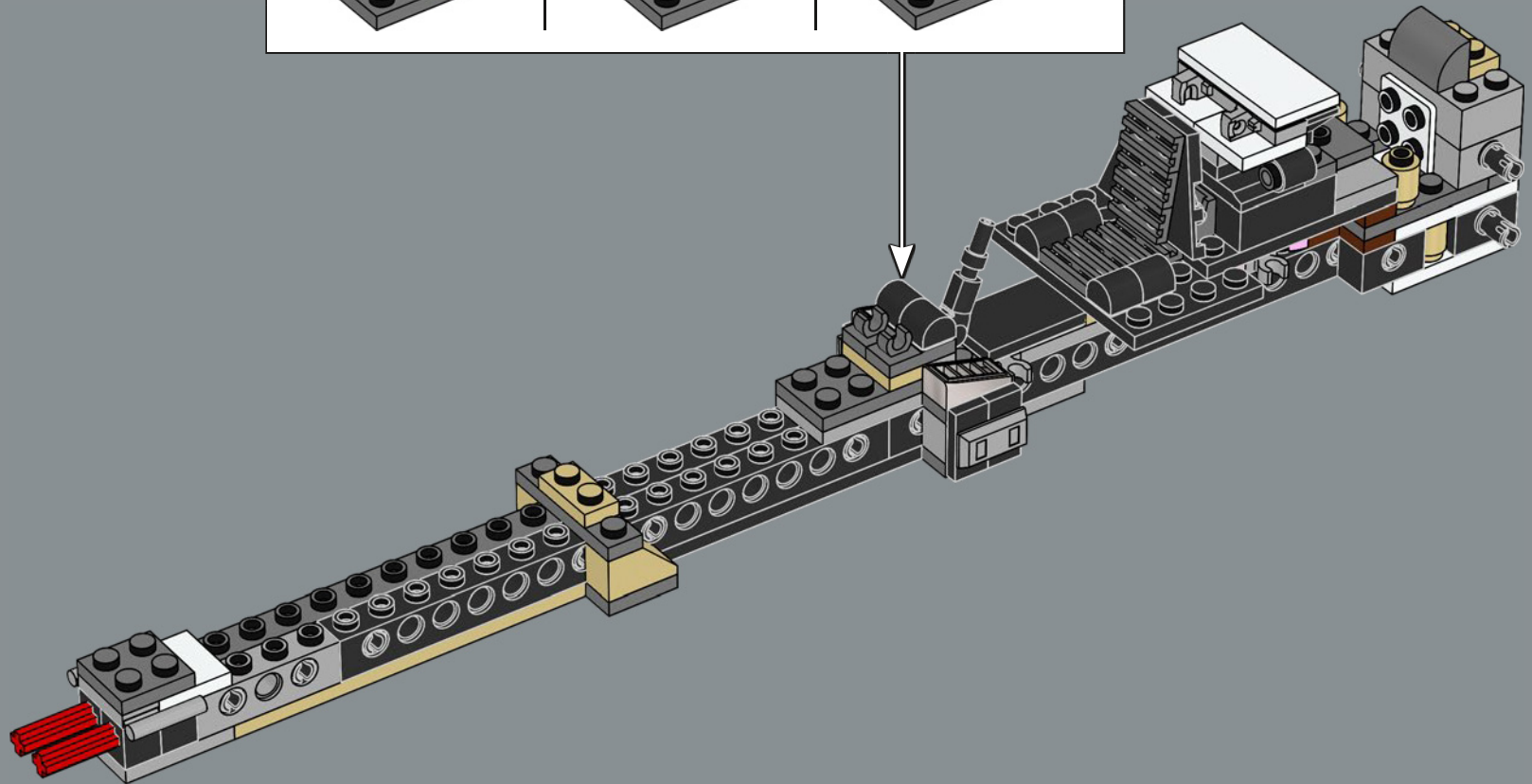
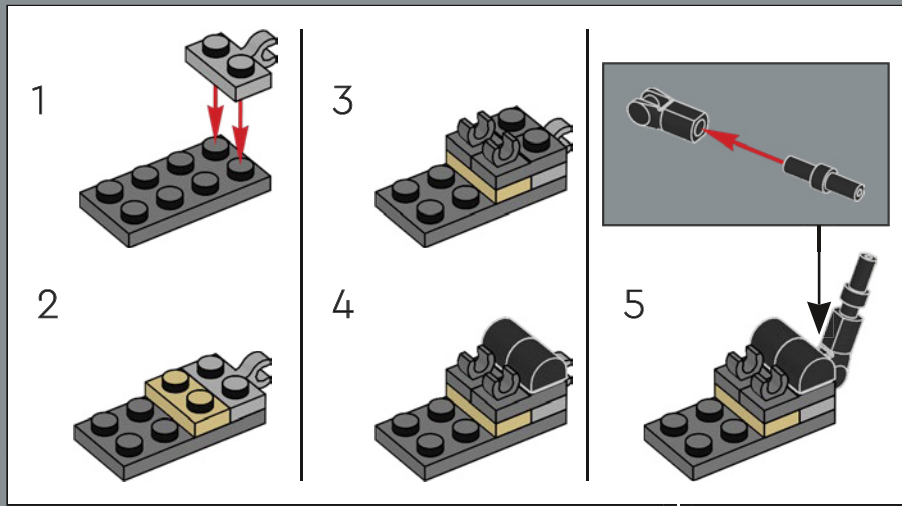

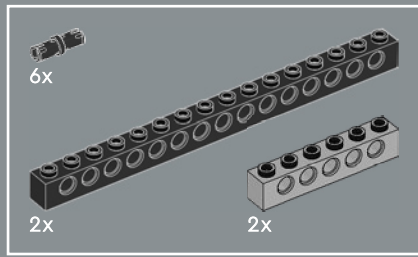

34

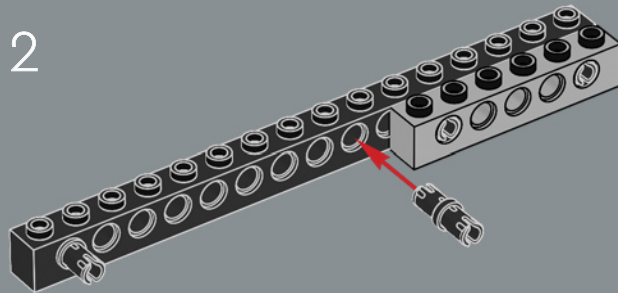
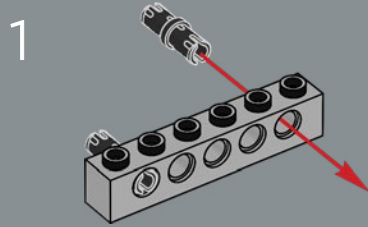

3

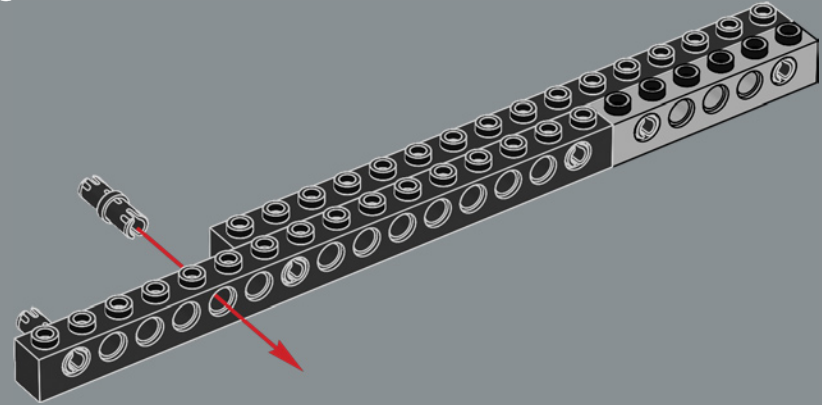

4

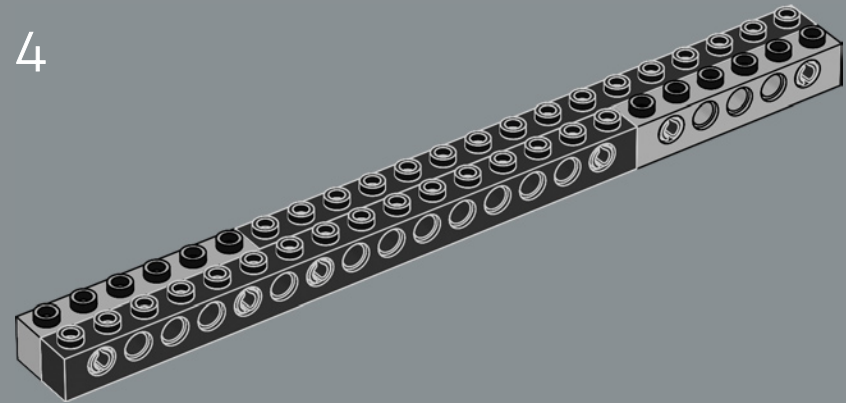

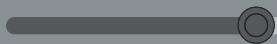
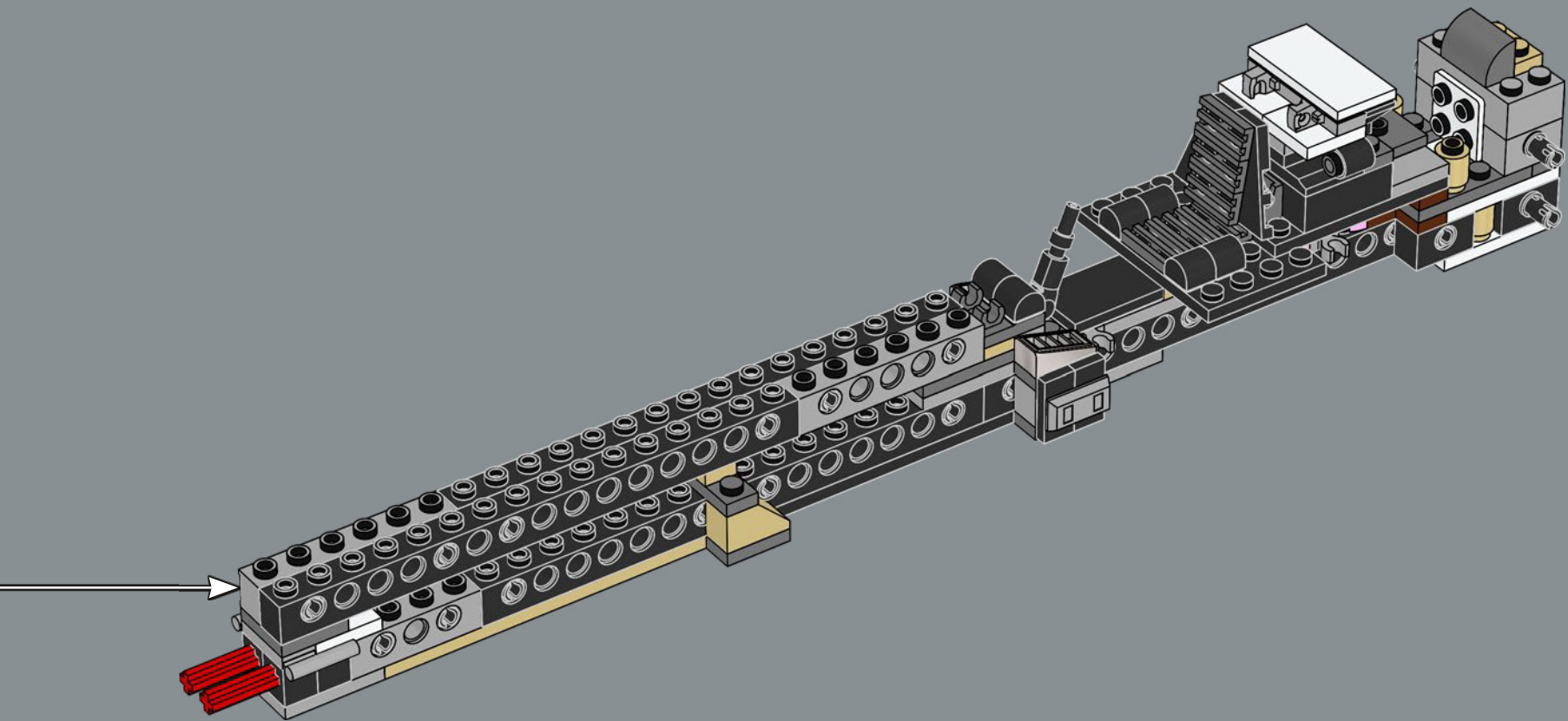



35

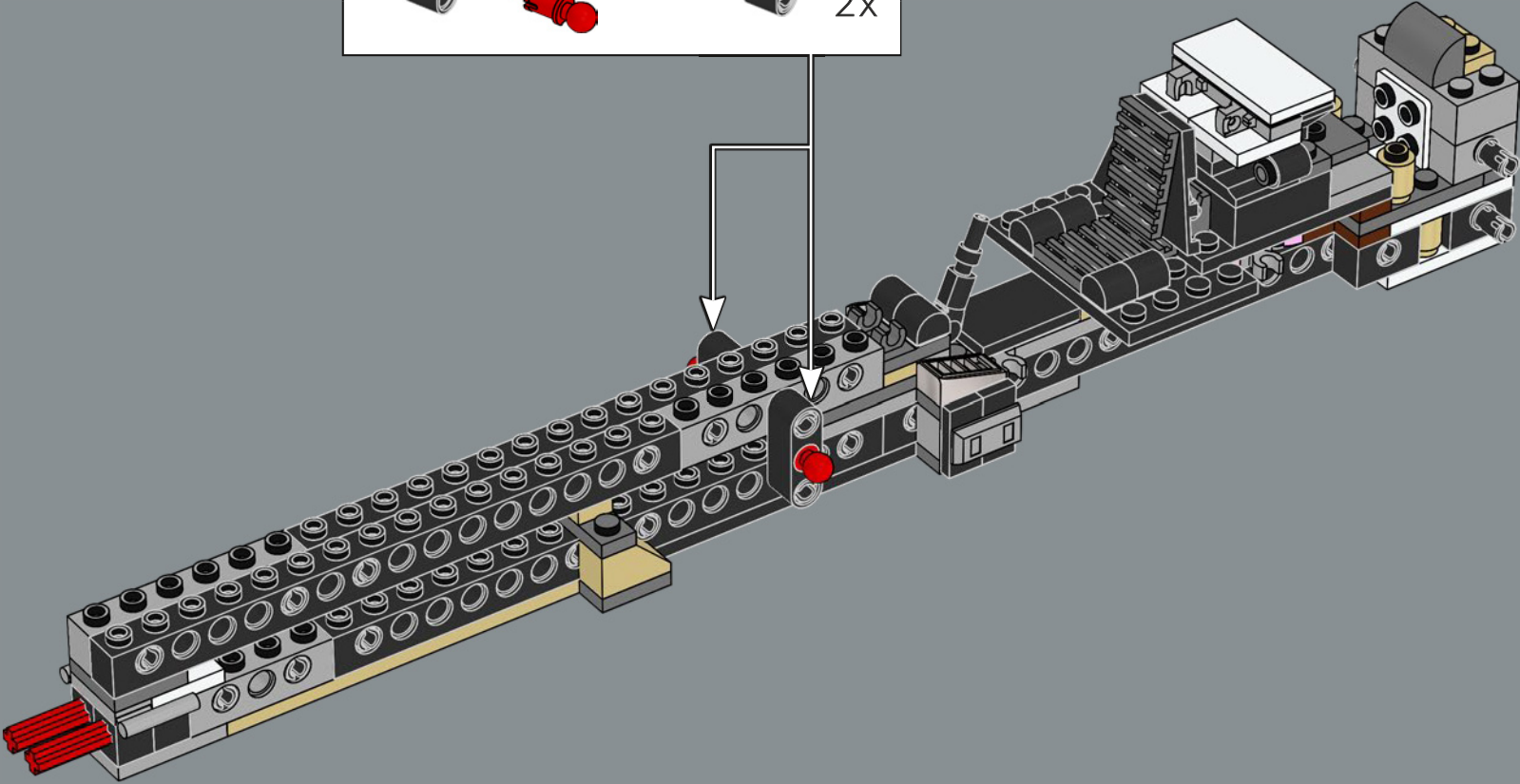
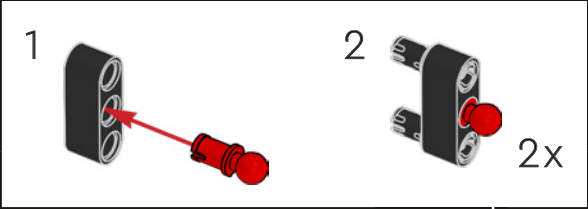

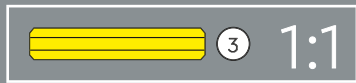
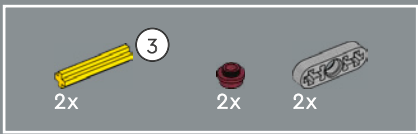

36

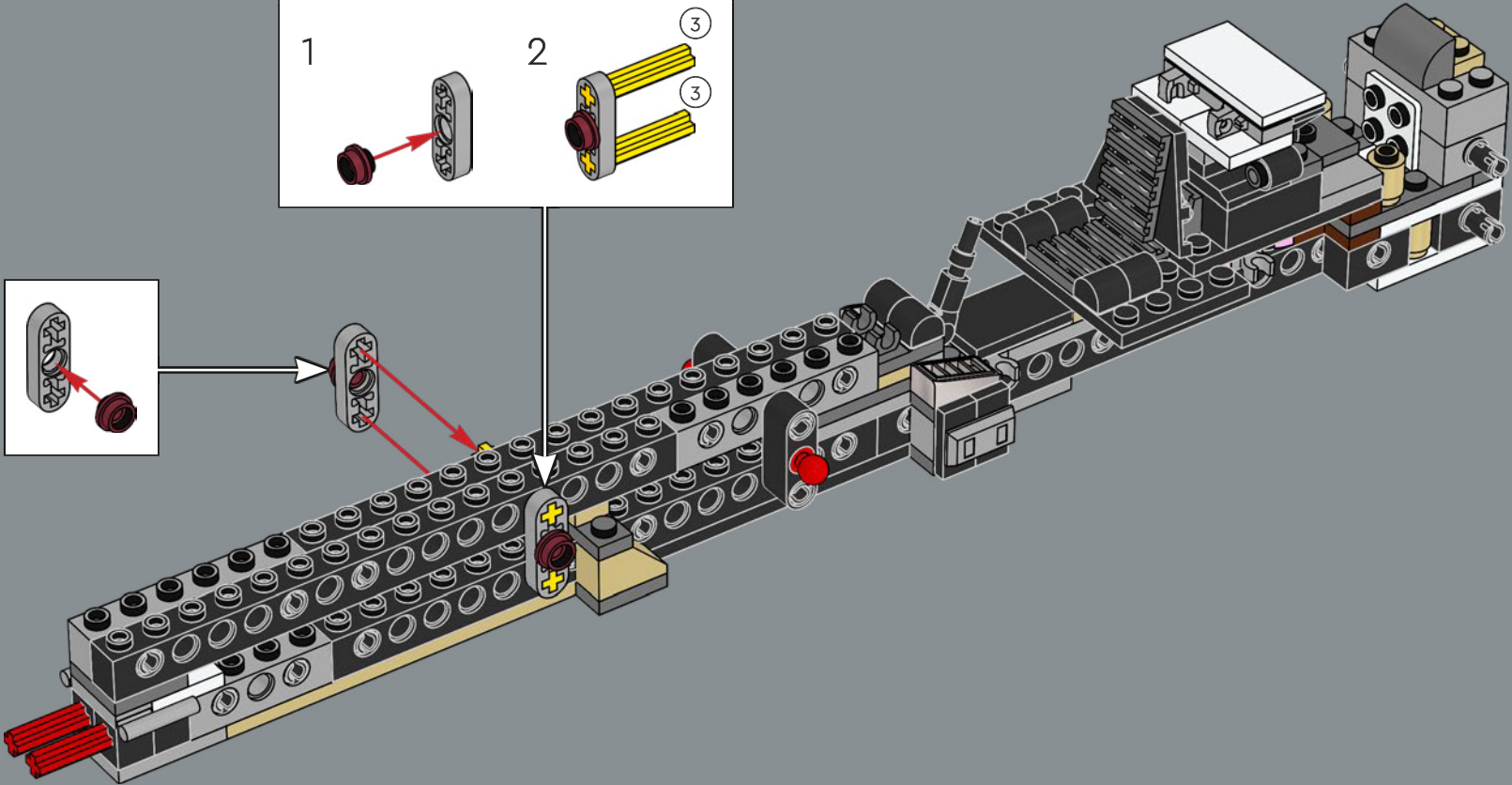
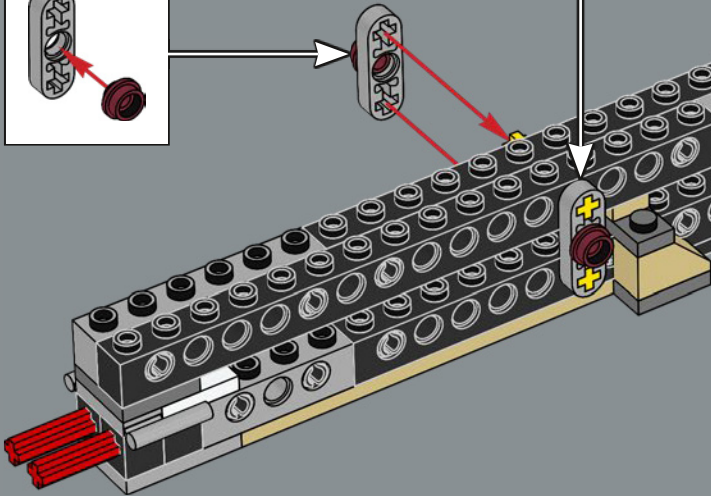
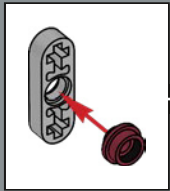
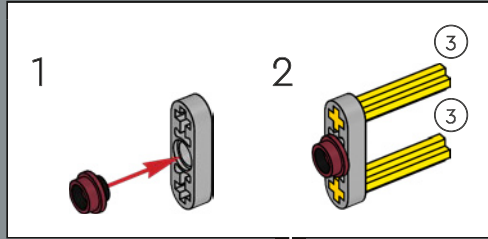

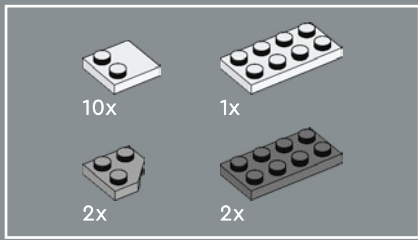

37

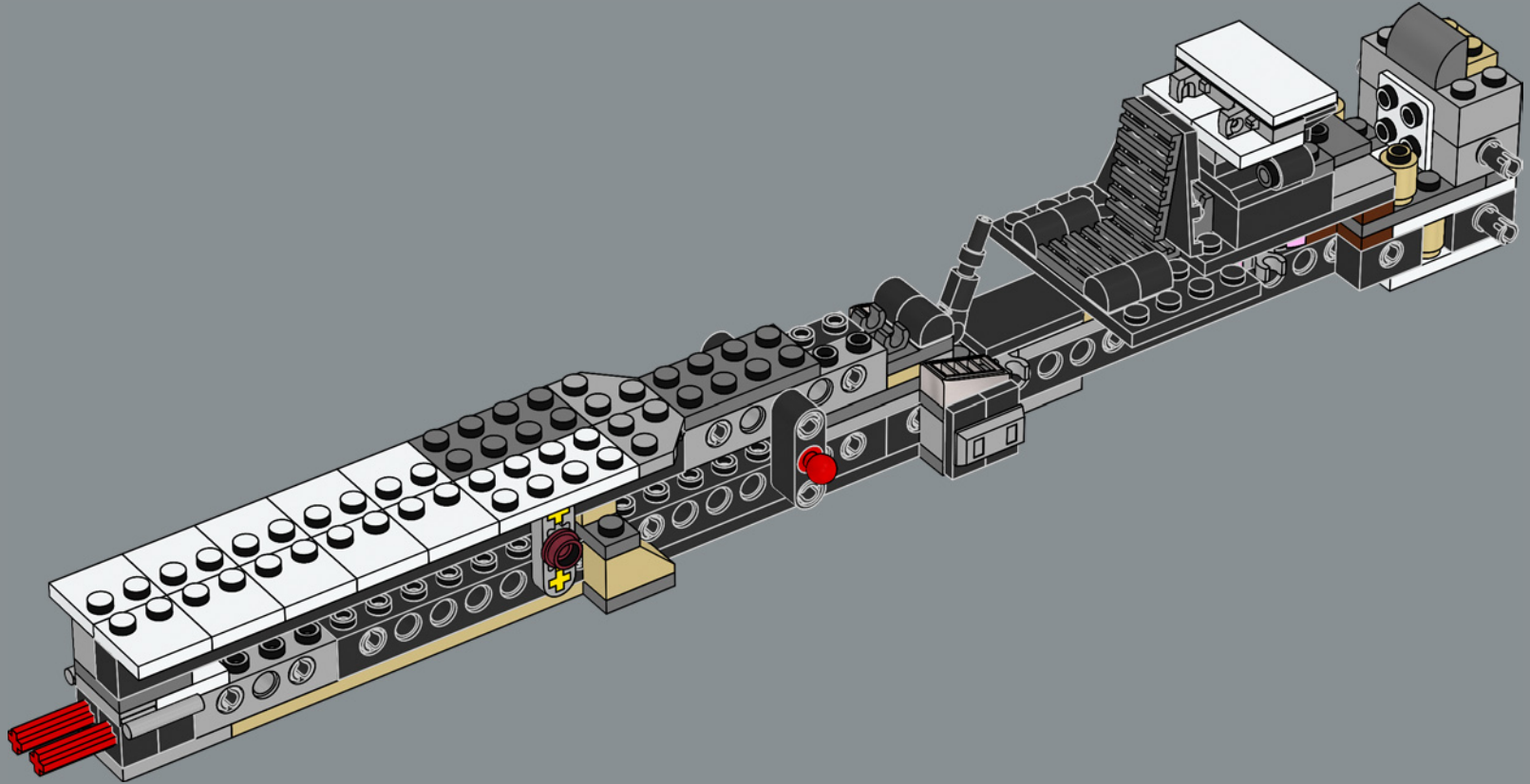

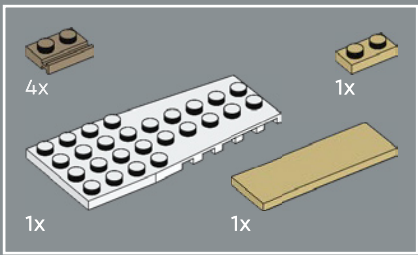

38

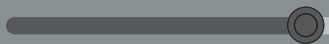
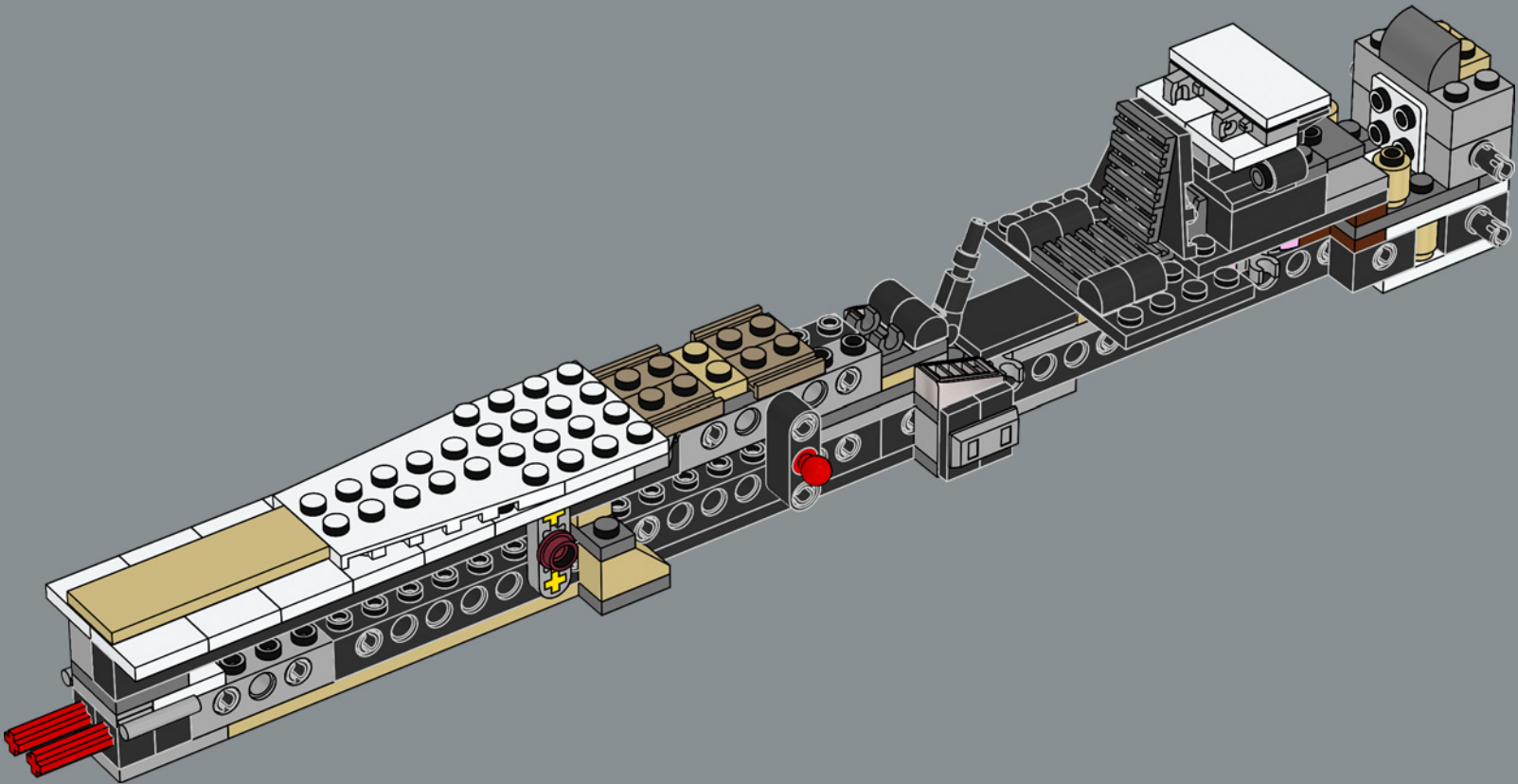

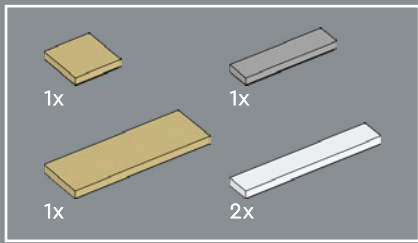

39

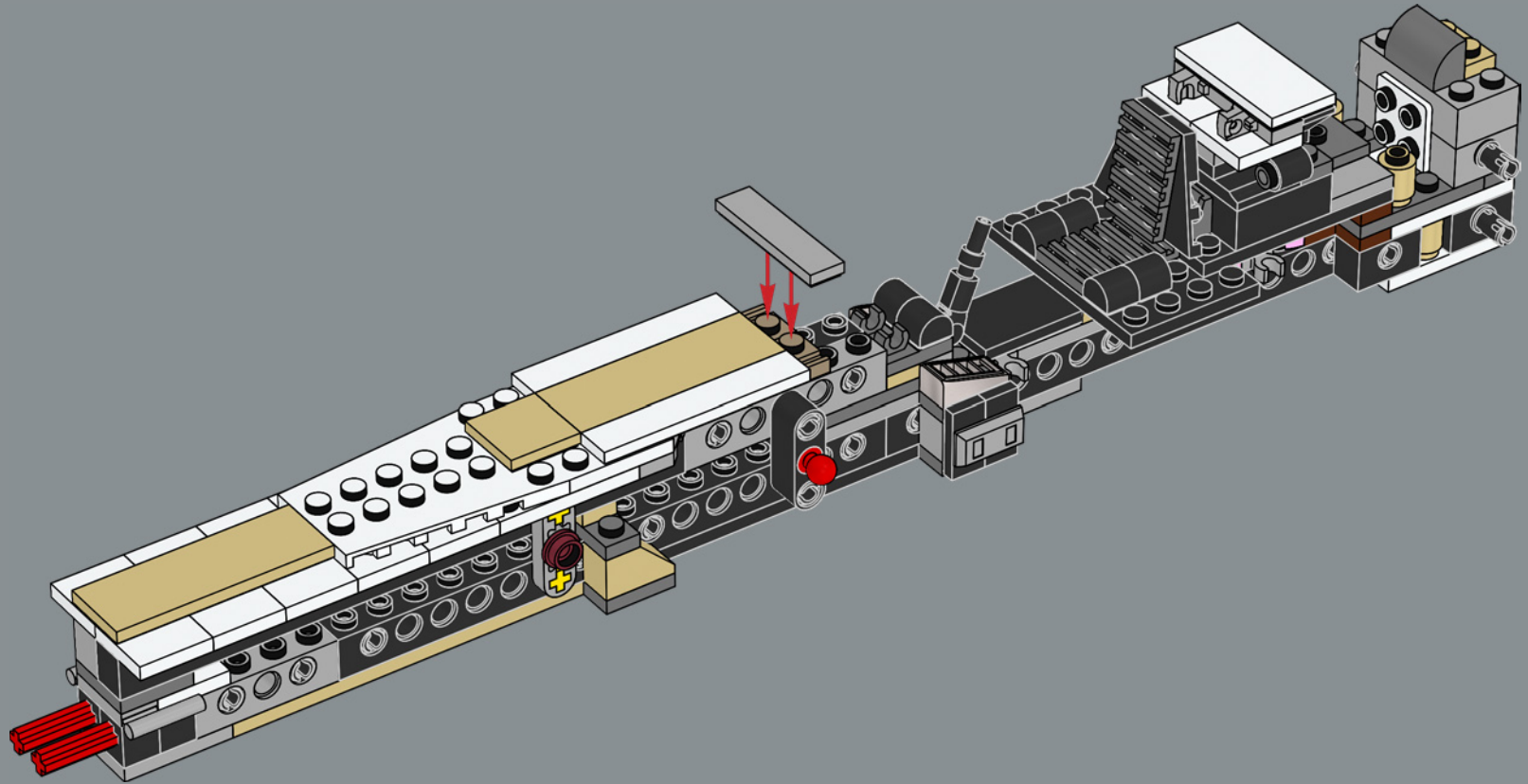

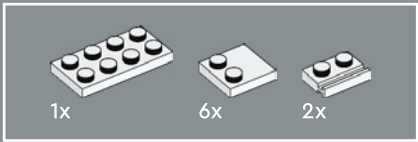

40

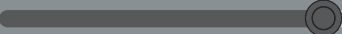
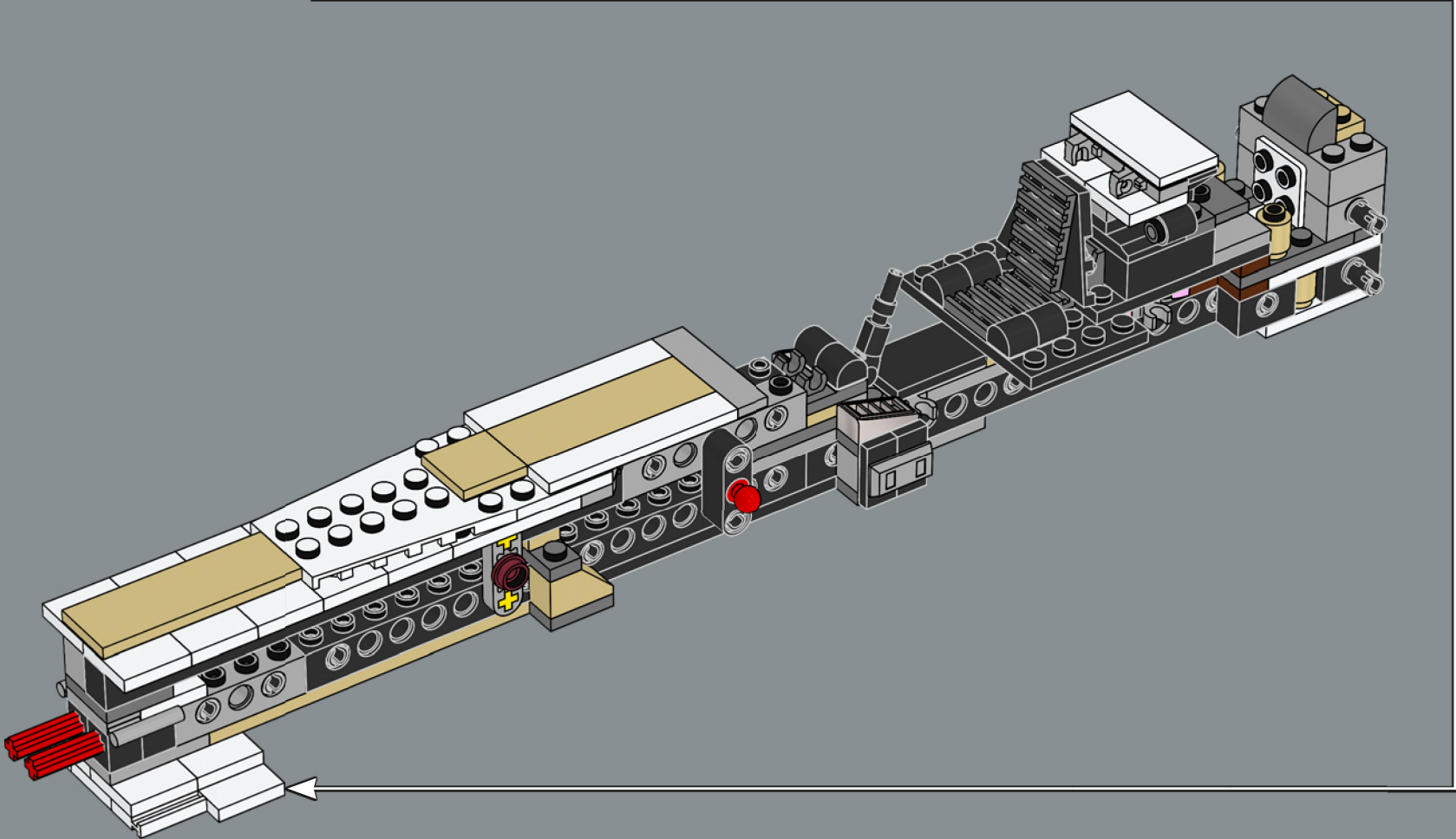
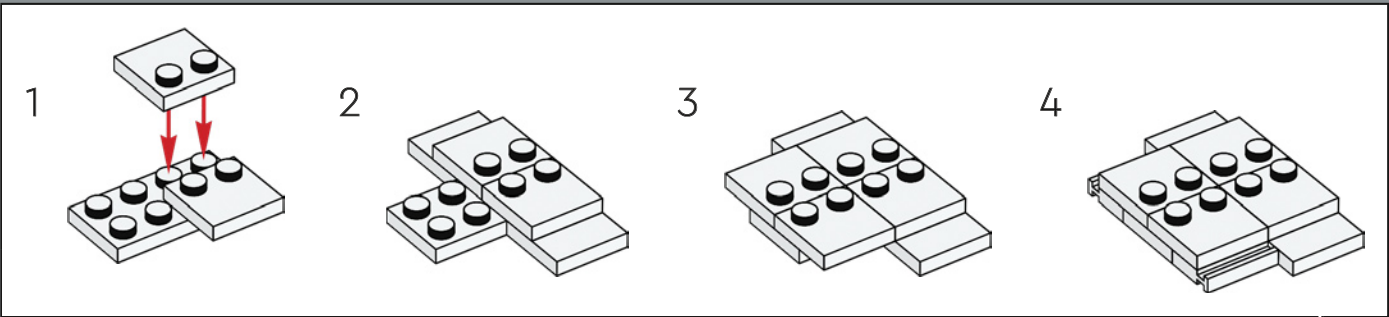

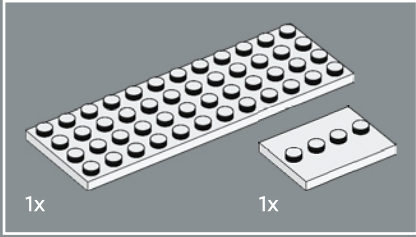
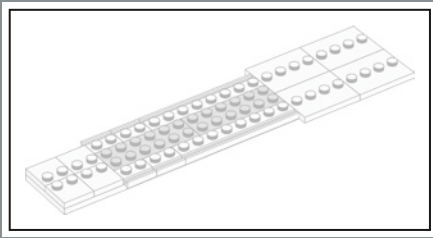

41

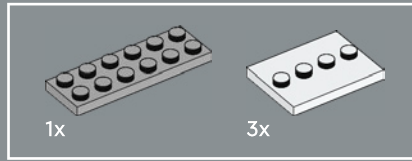
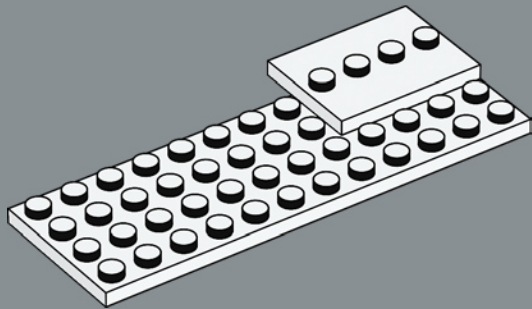

42

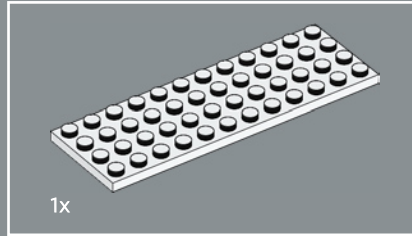
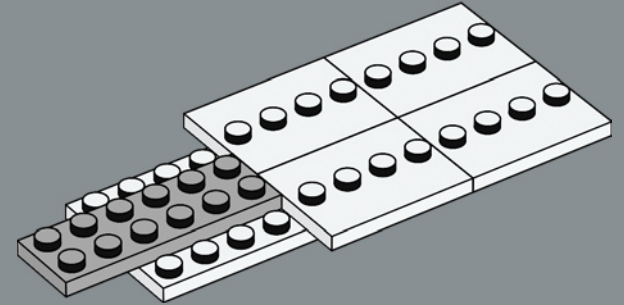

43

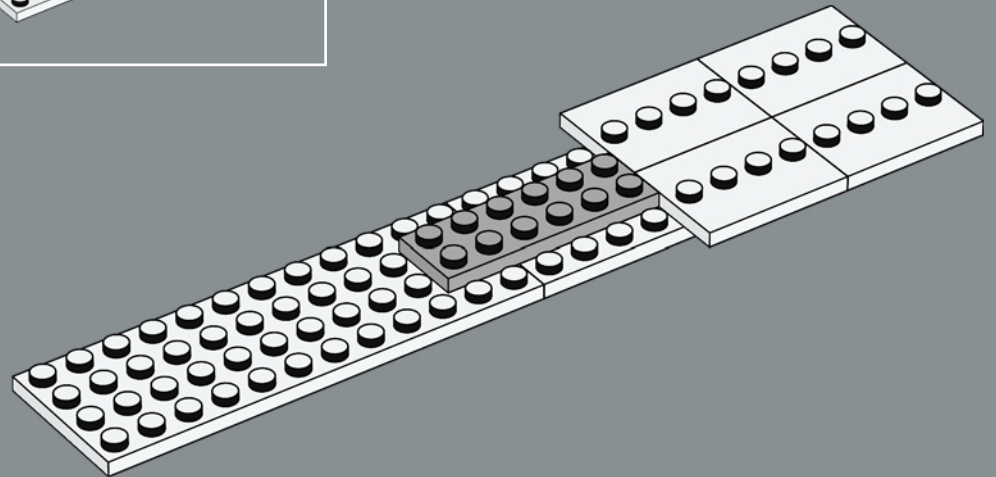

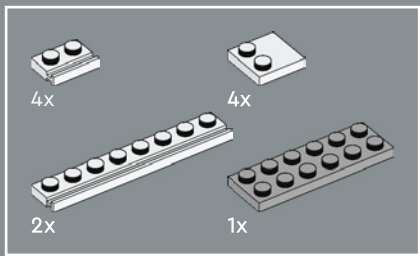

44

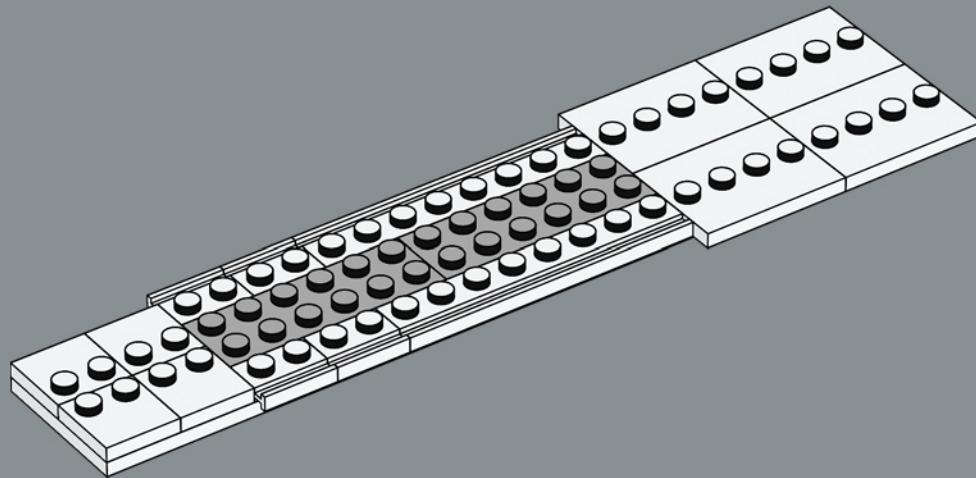

45

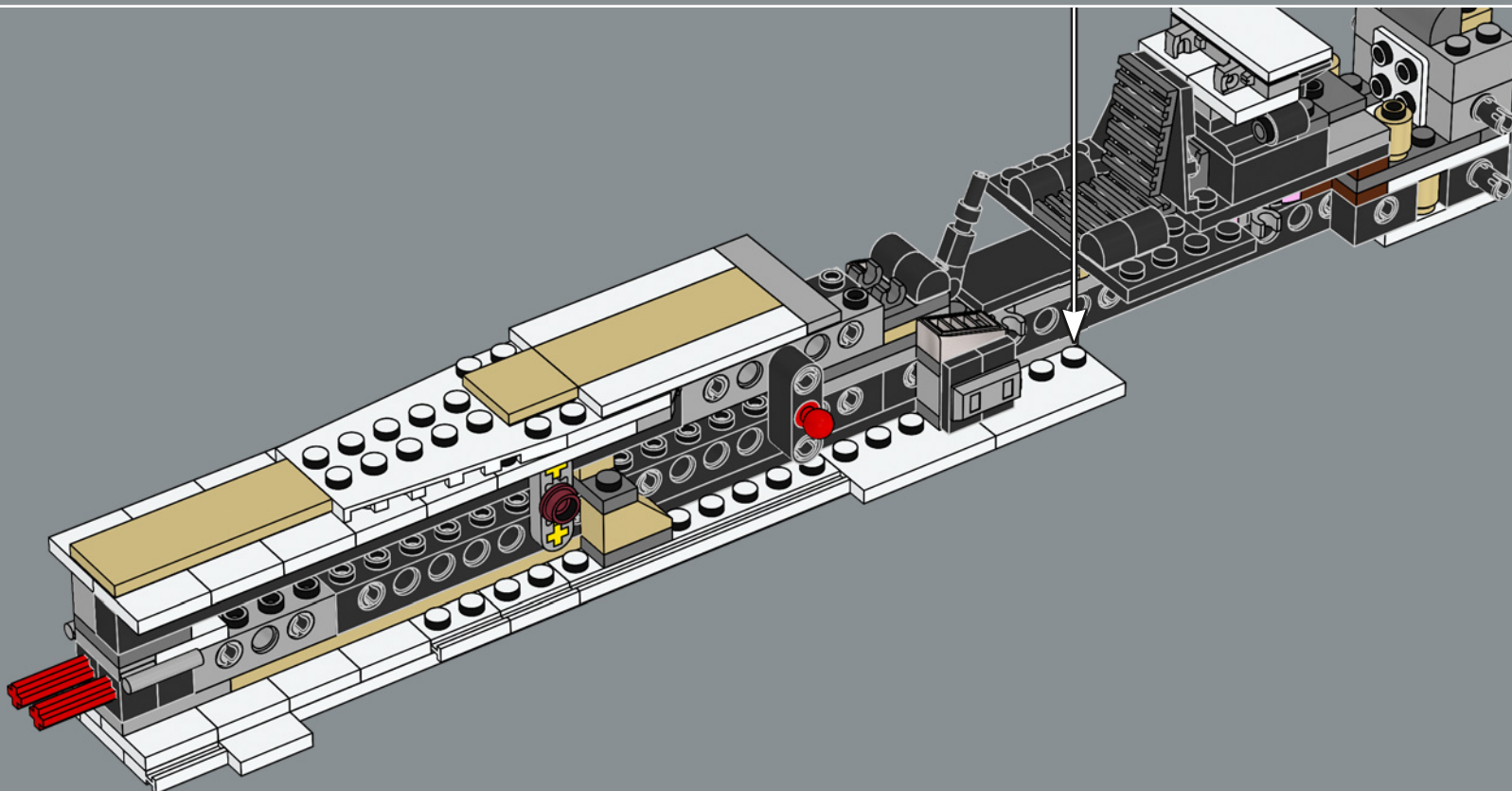

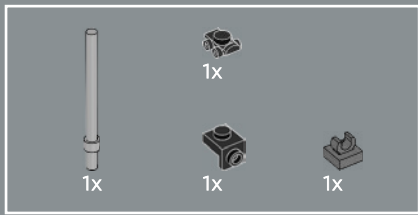

46

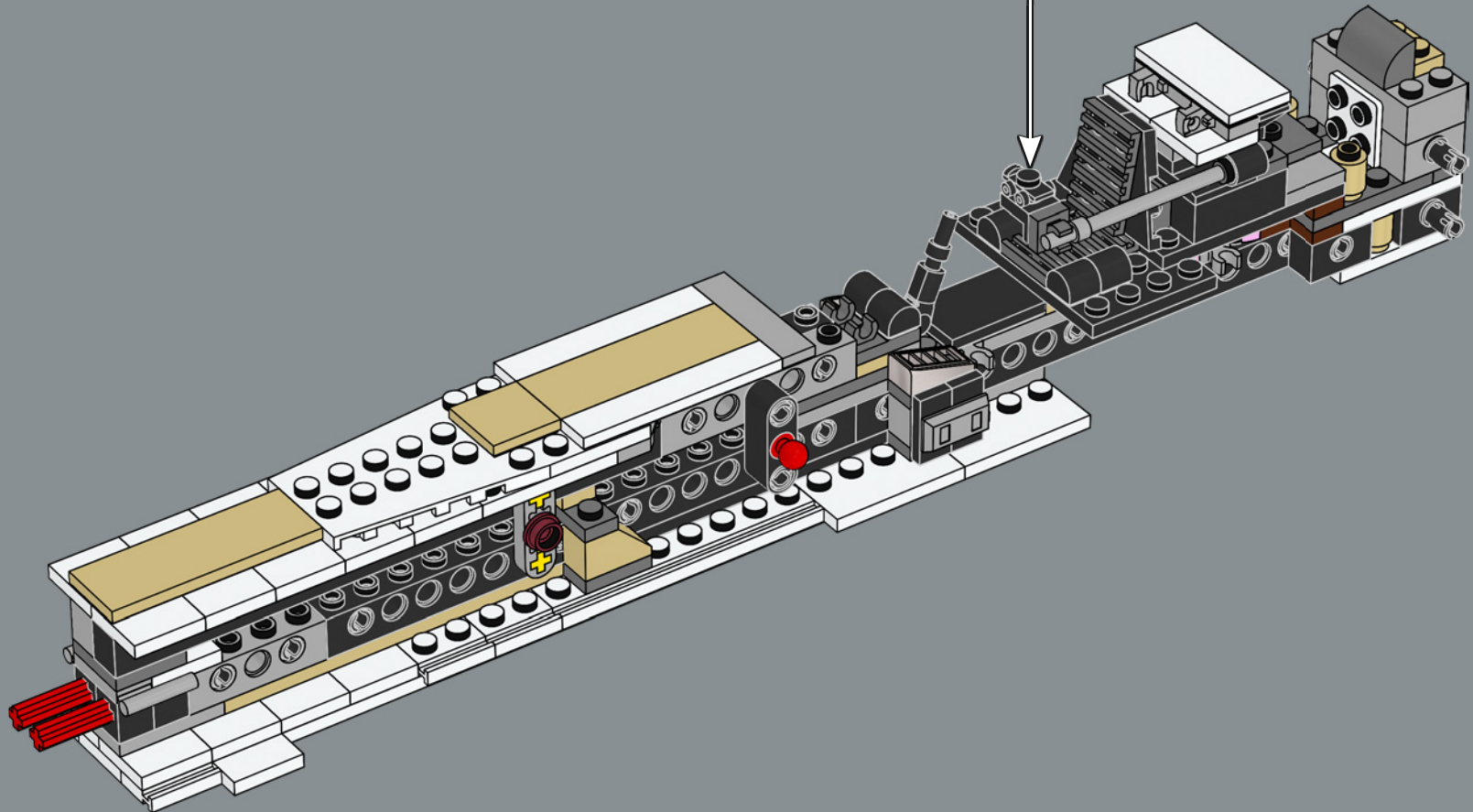
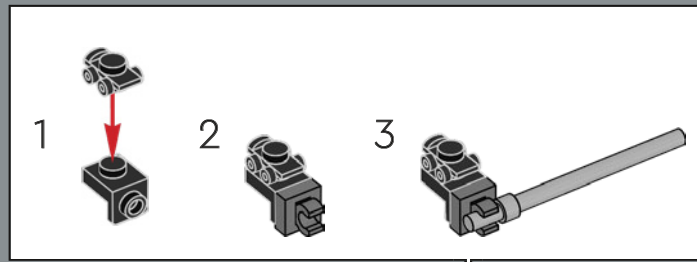

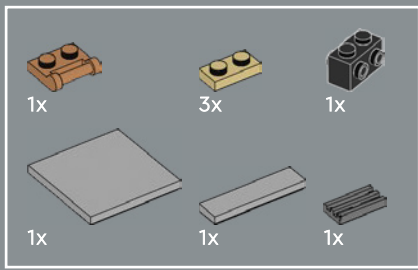

47

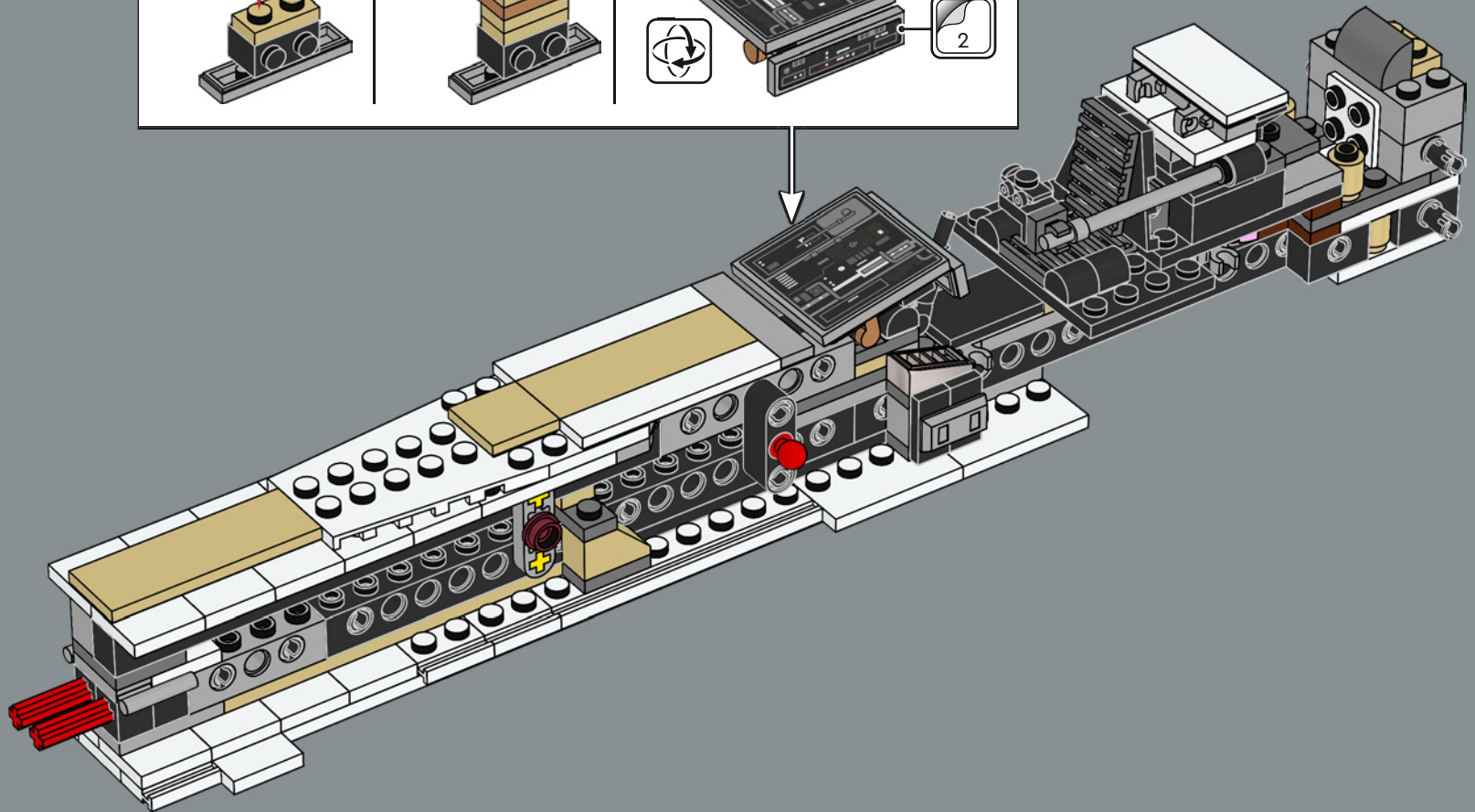
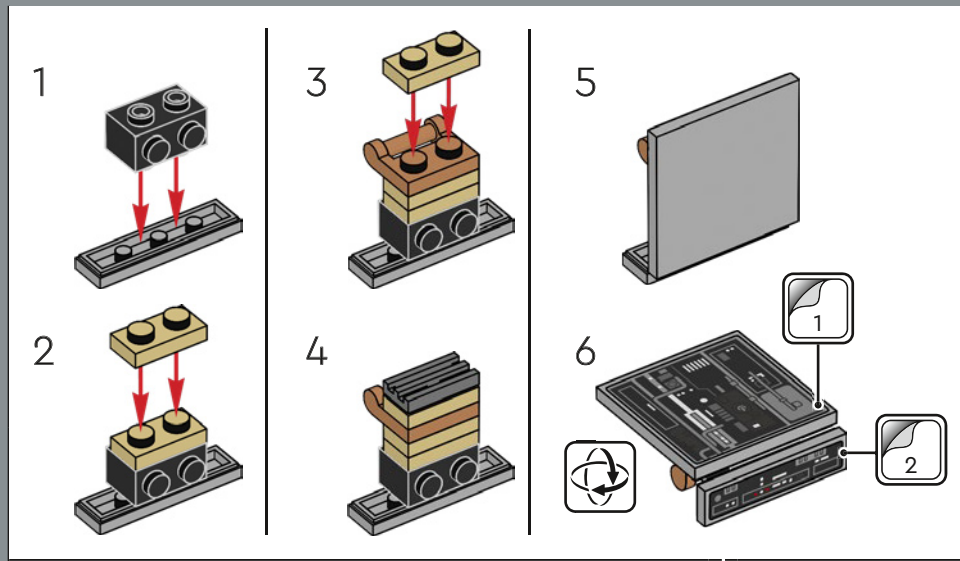

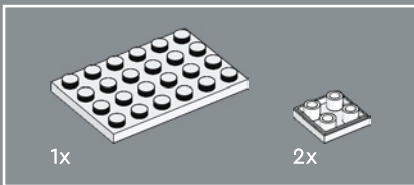
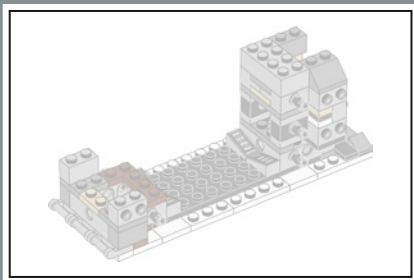

48

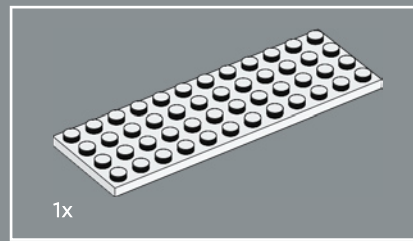
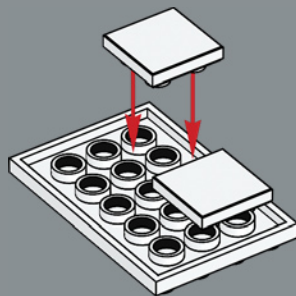

49

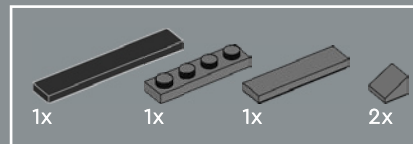
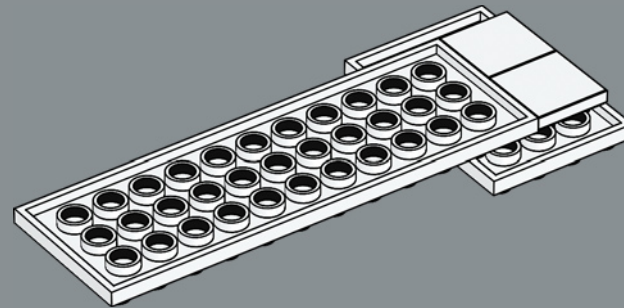

50

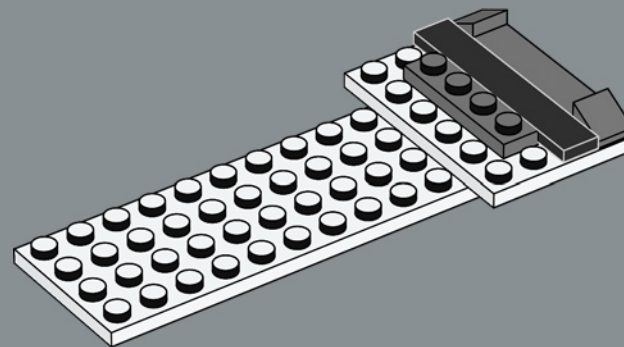

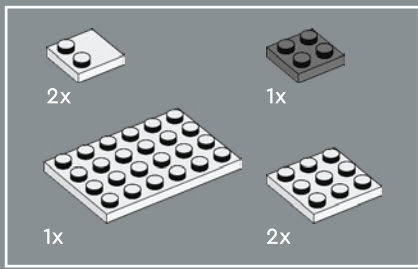

51

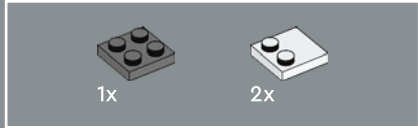
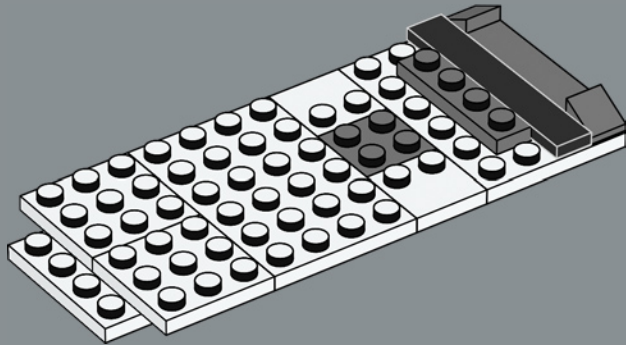

52

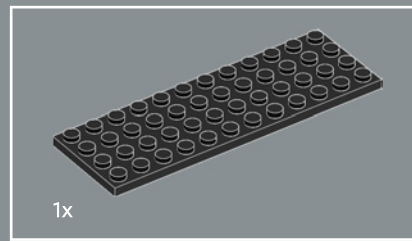
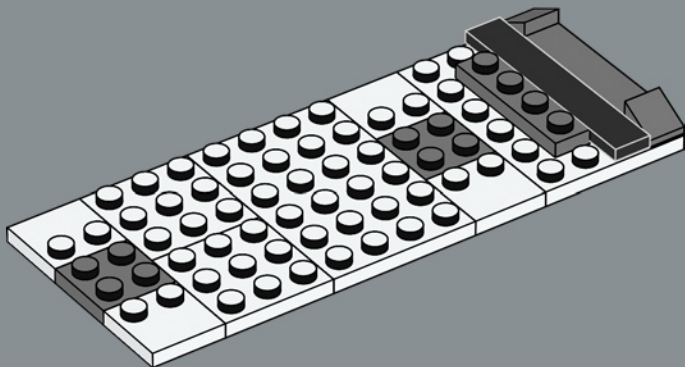

53

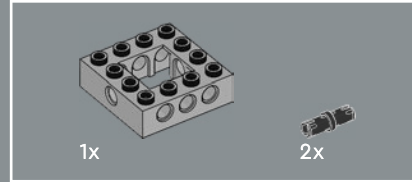
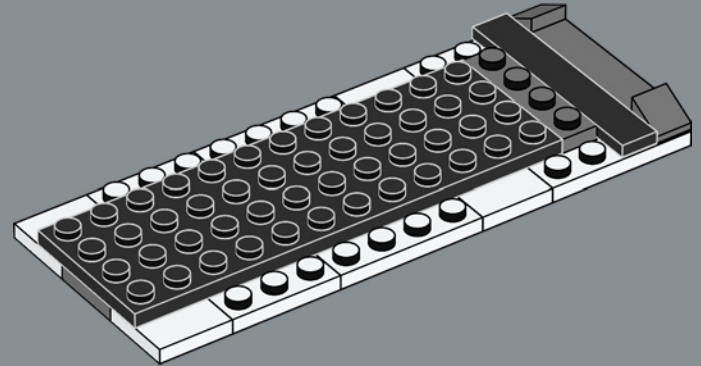

54

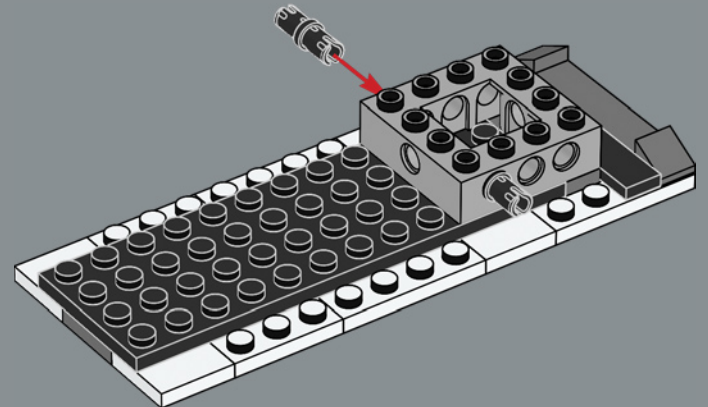

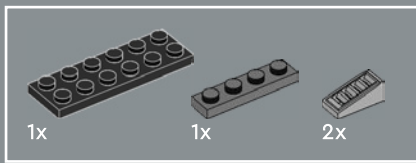

55

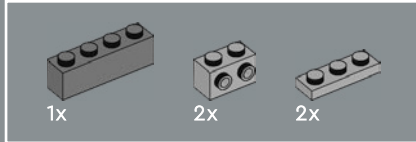
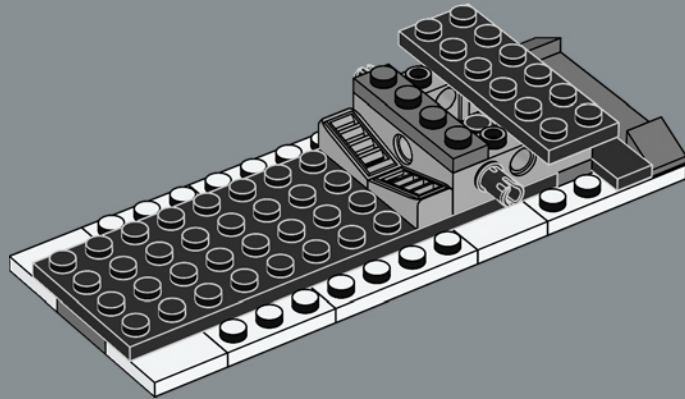

56

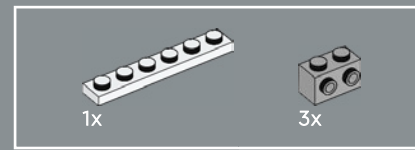
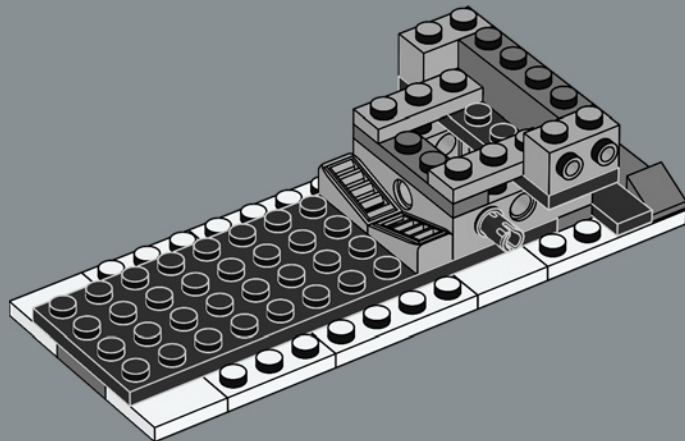

57

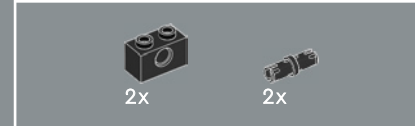
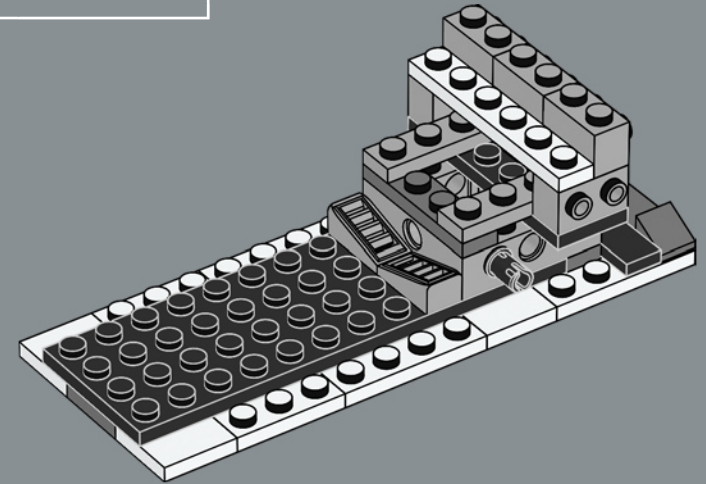

58

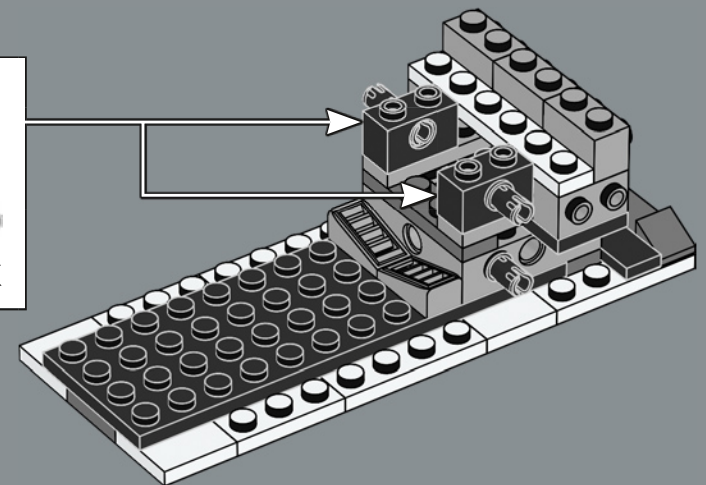
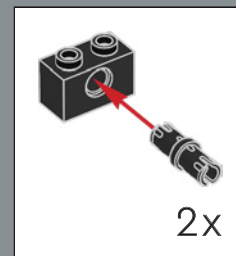

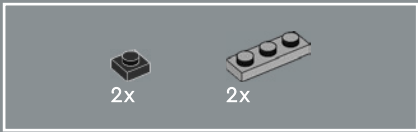

59

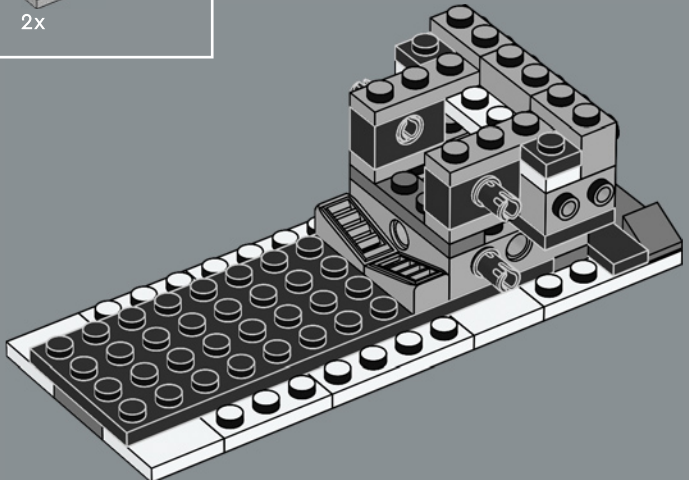

61

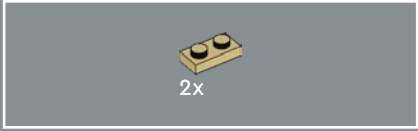
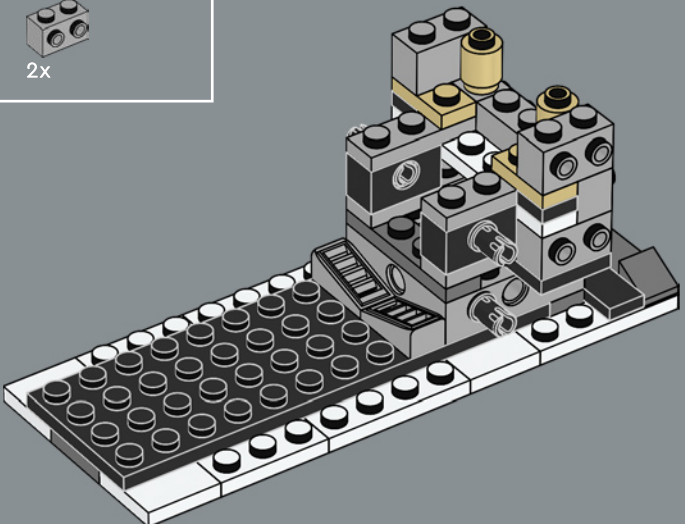

60

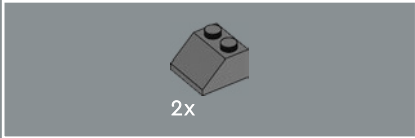
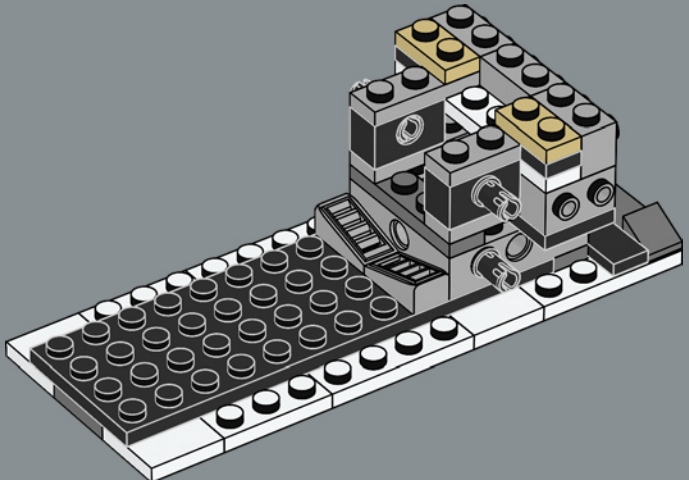

62

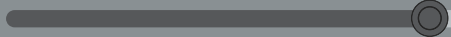
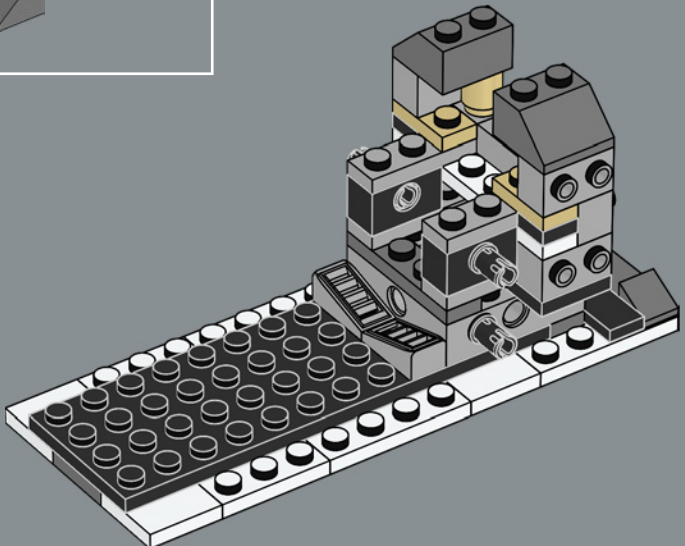

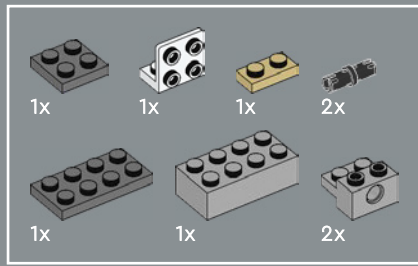

63

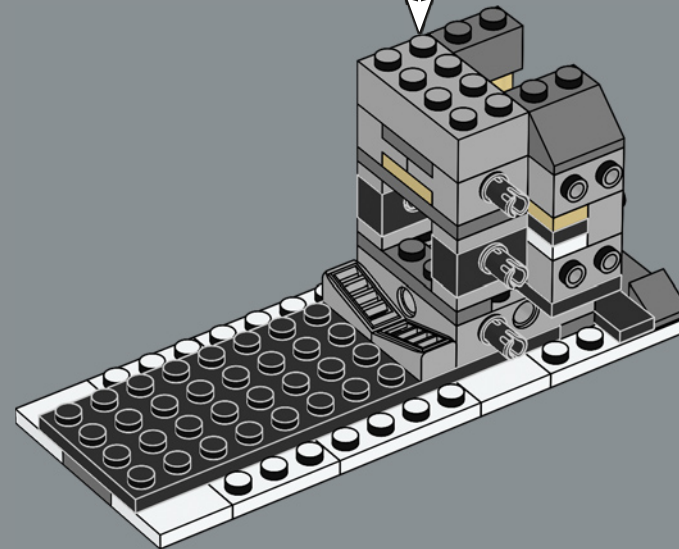
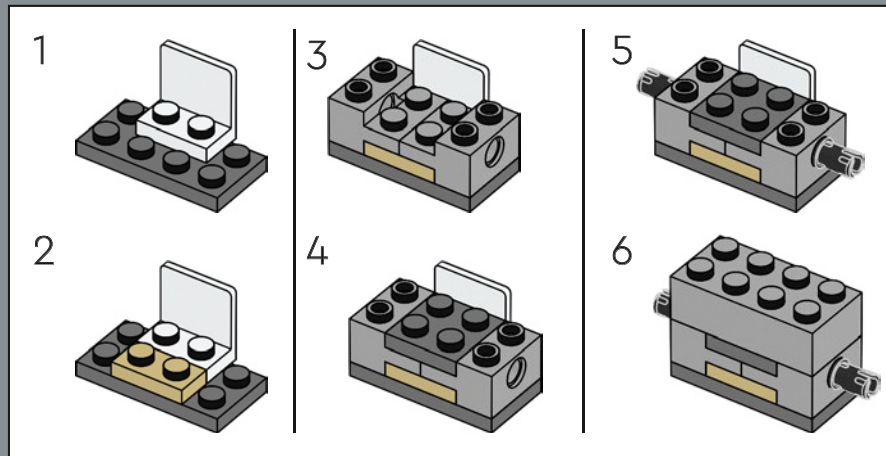

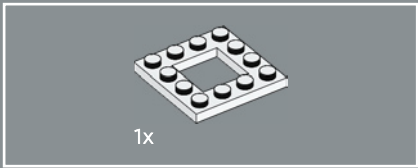

1x

64

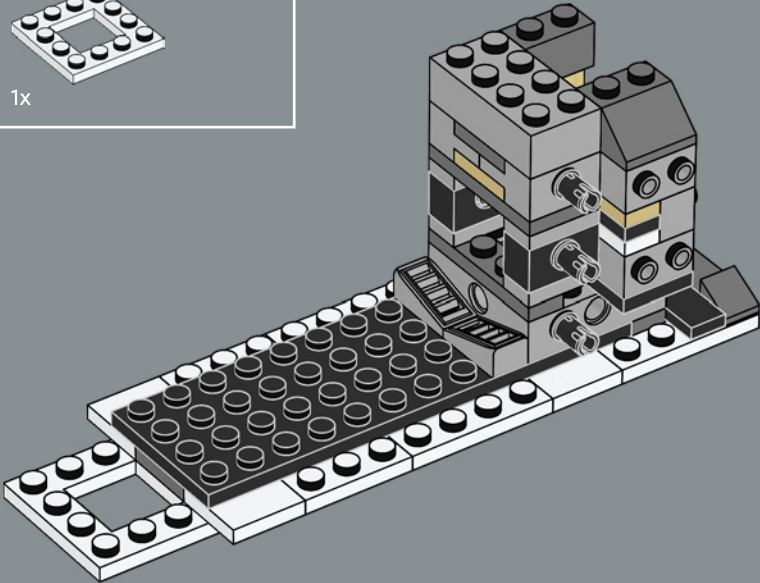

2x

3x

66

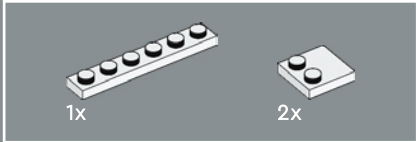
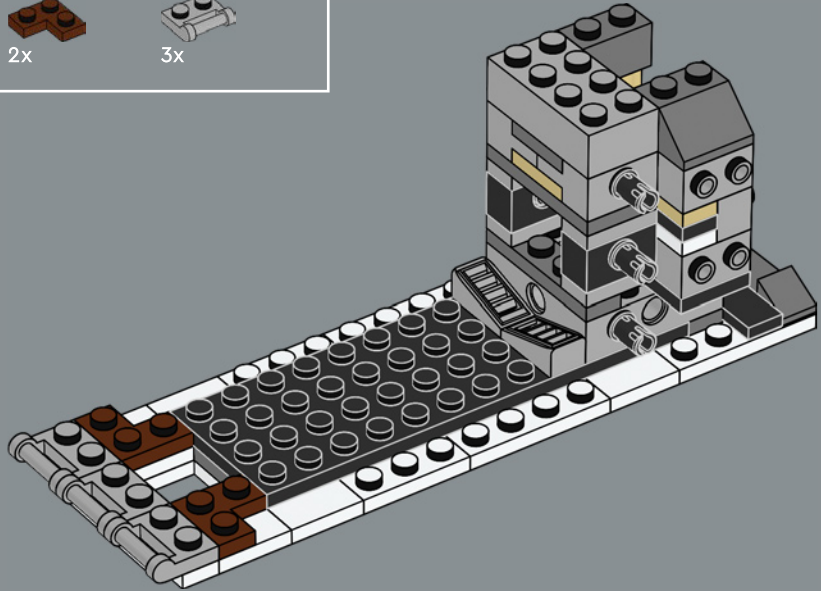

1x

2x

65

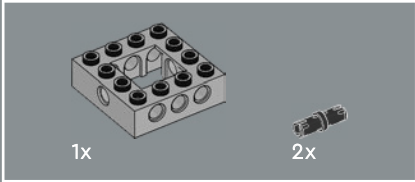
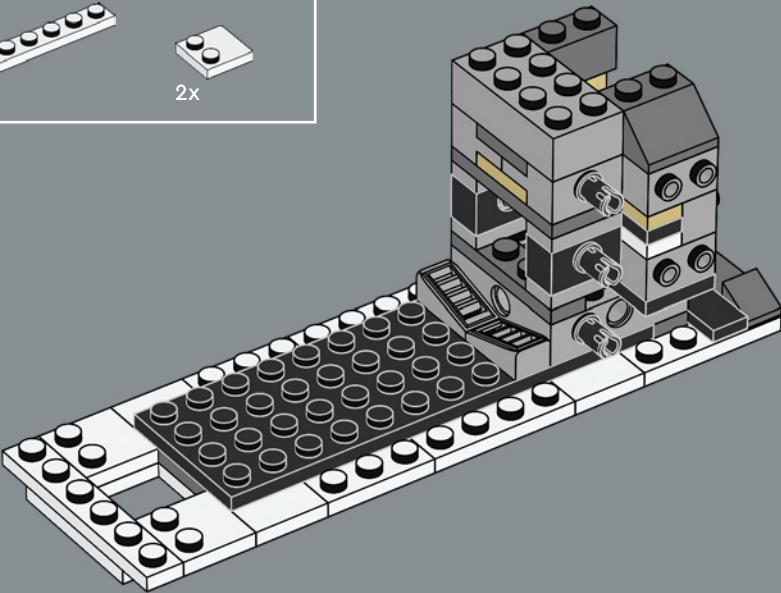

1x

2x

67

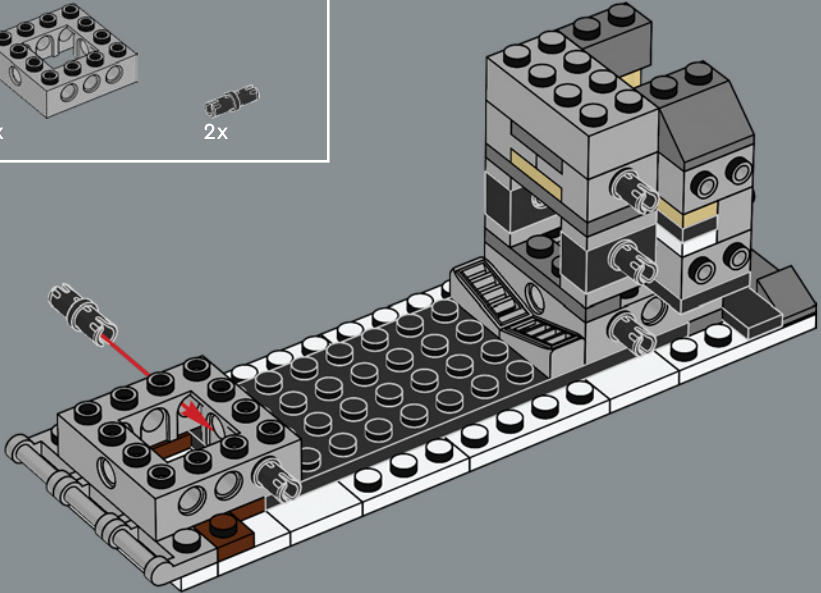

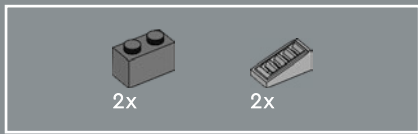

68

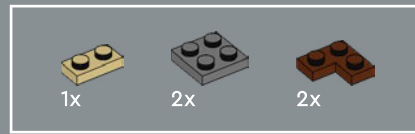
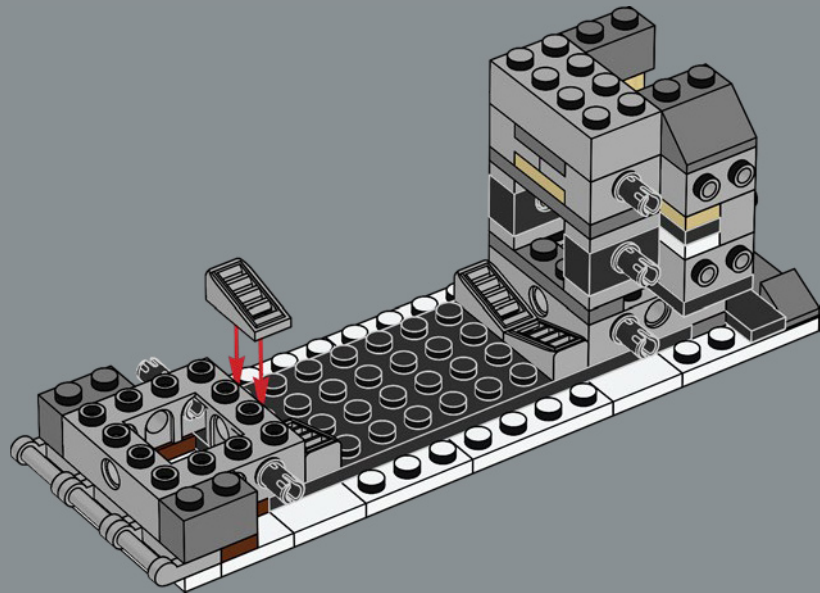

69

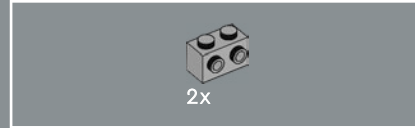
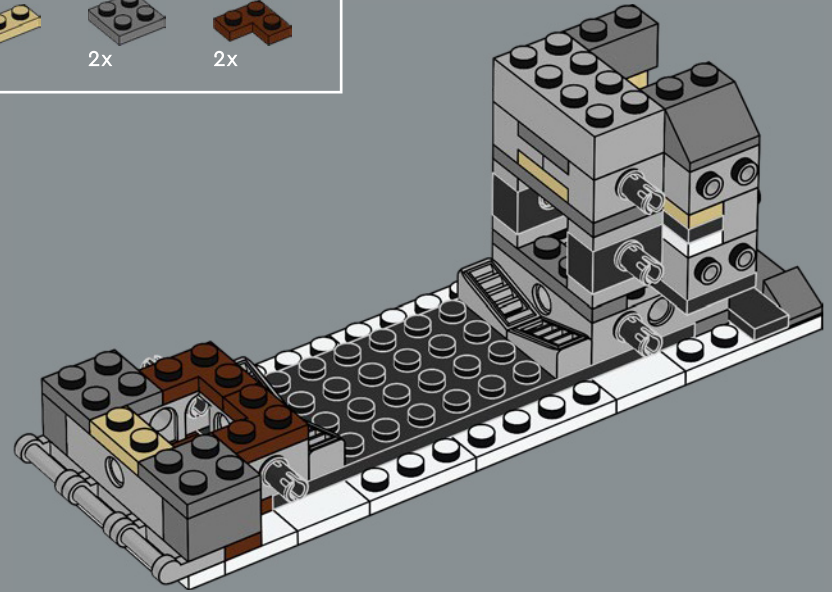

70

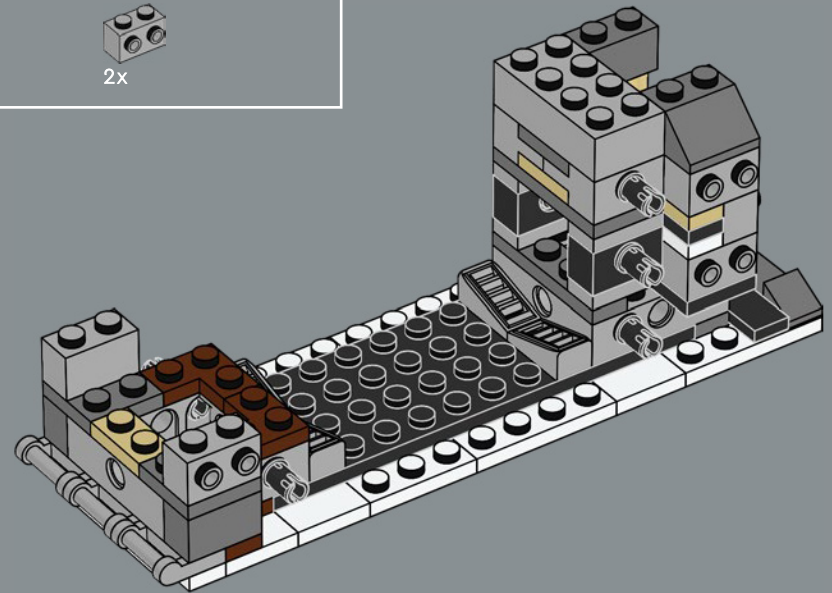

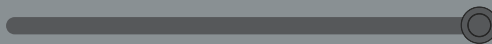
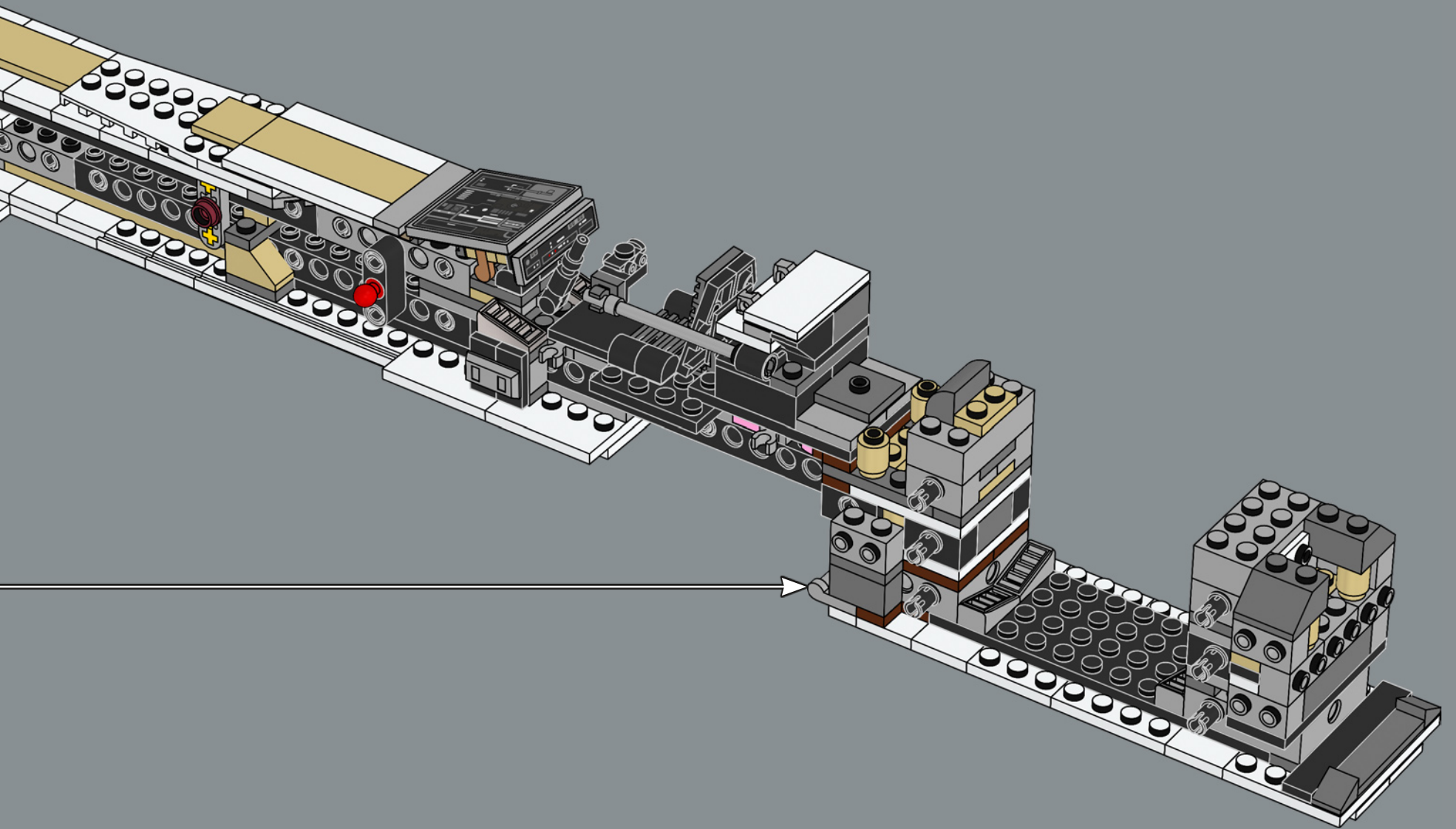

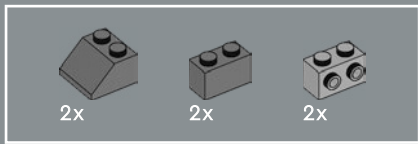

72

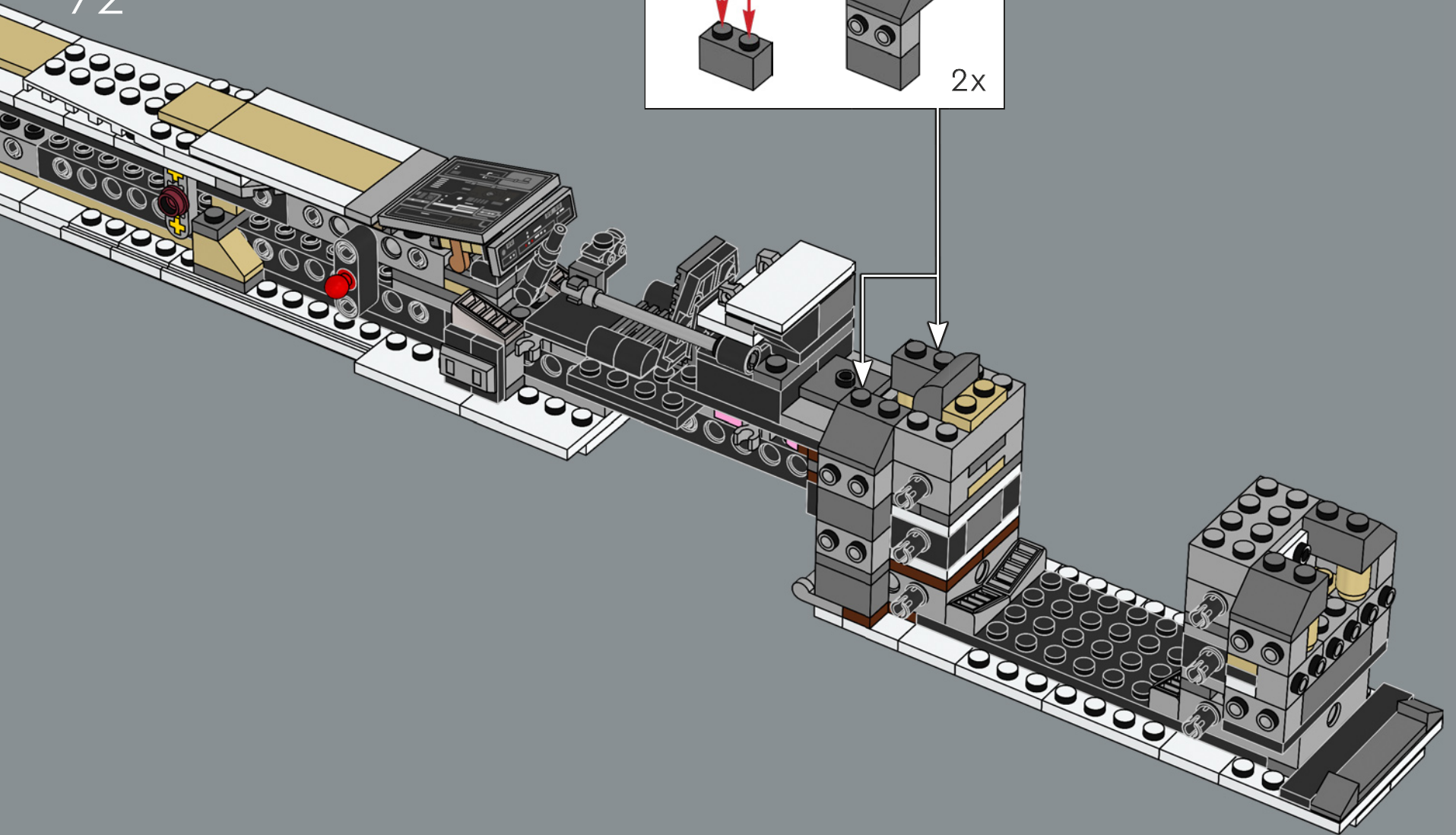
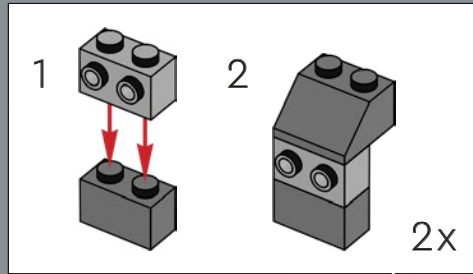

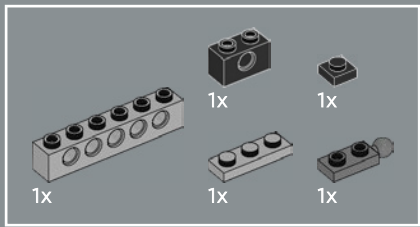

73

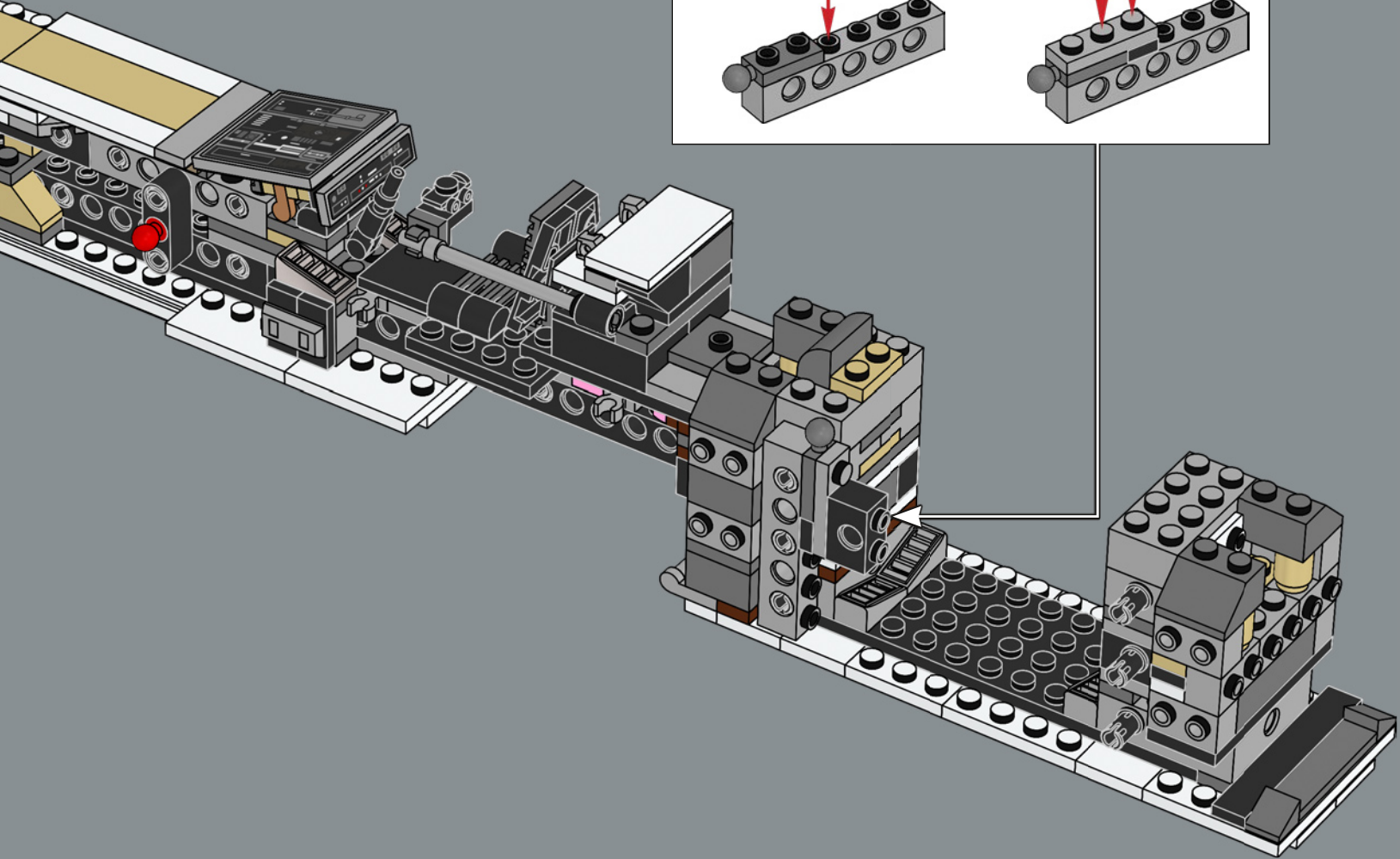
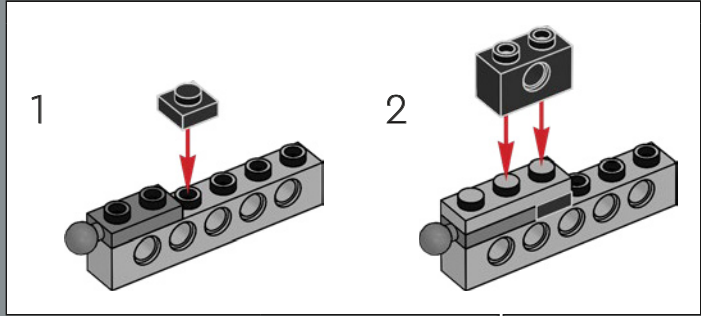

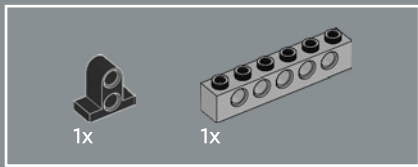

74

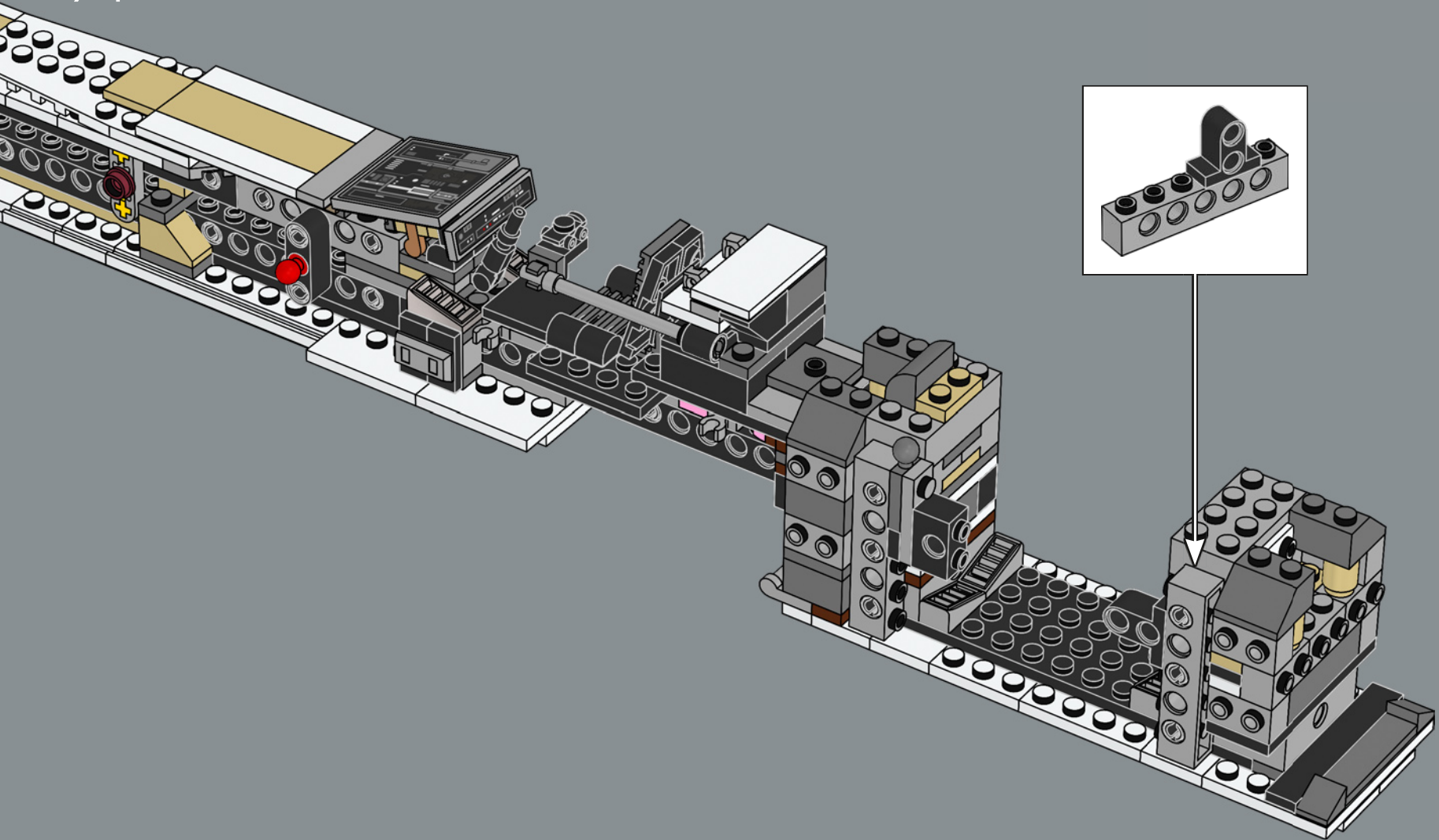



4x

75

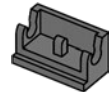
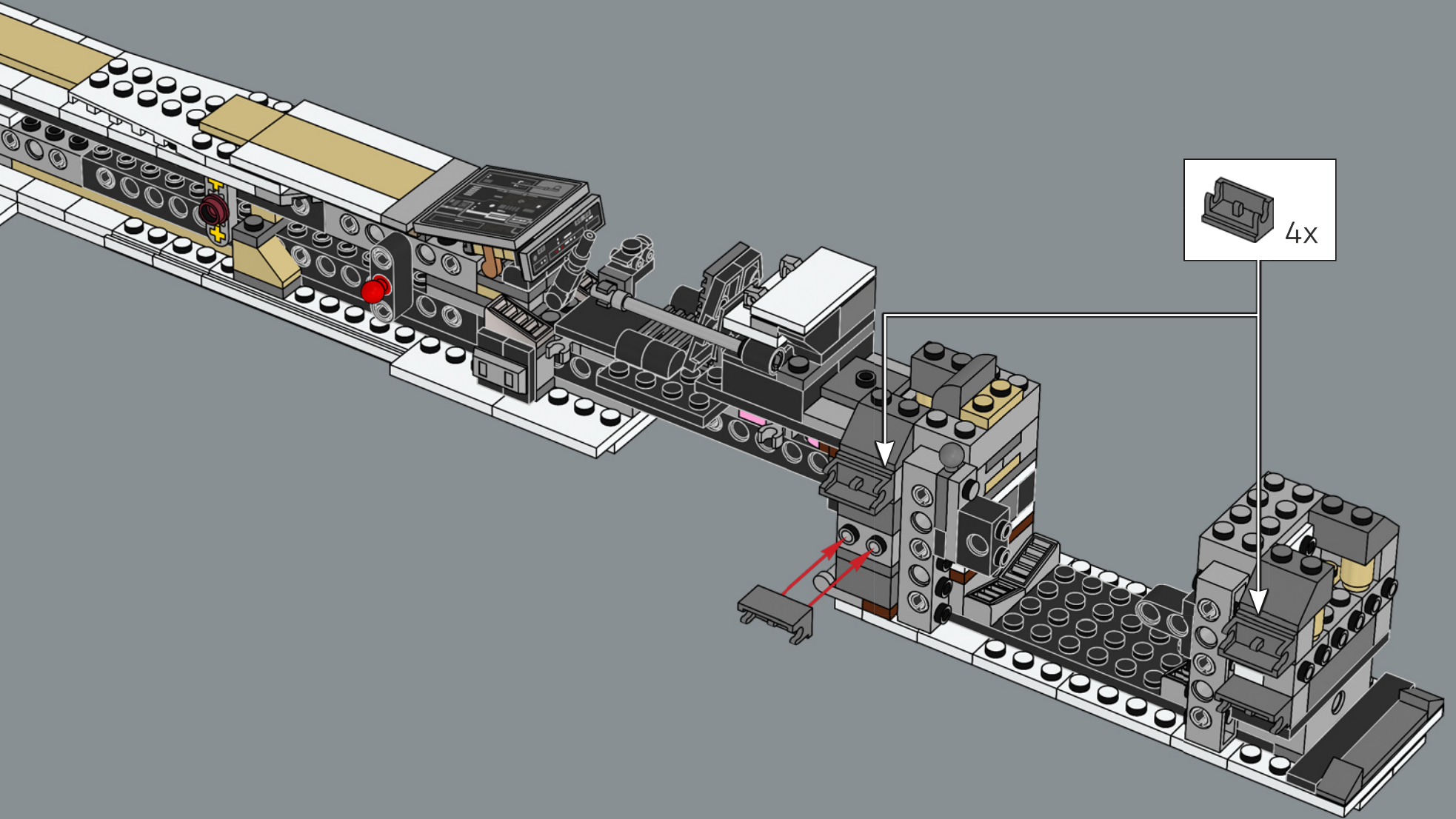

4x

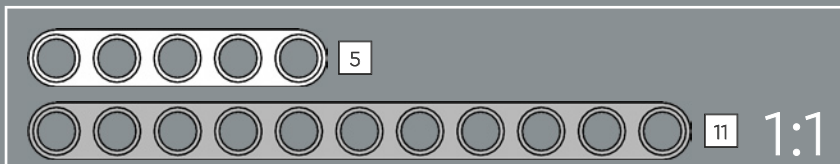
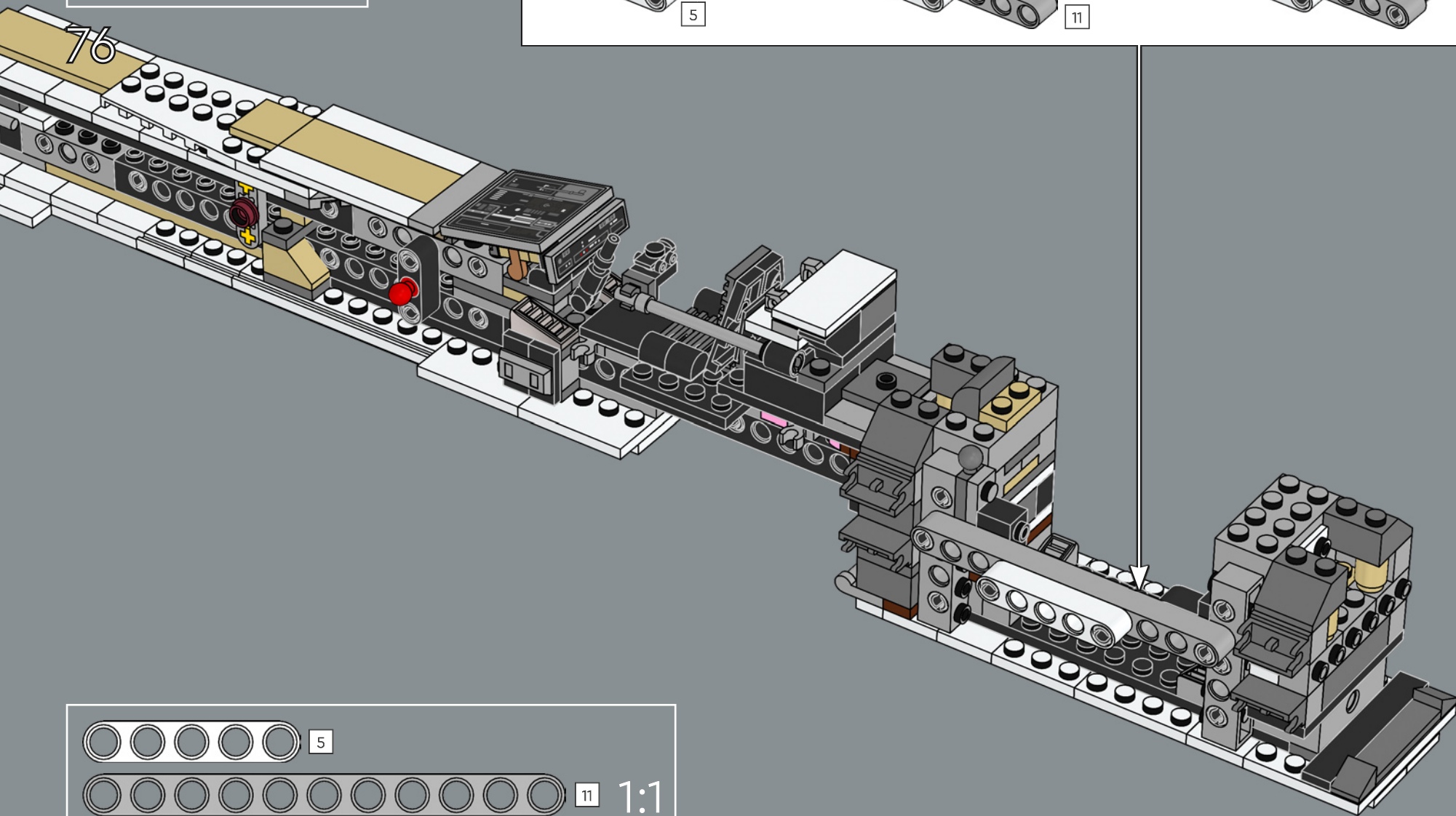
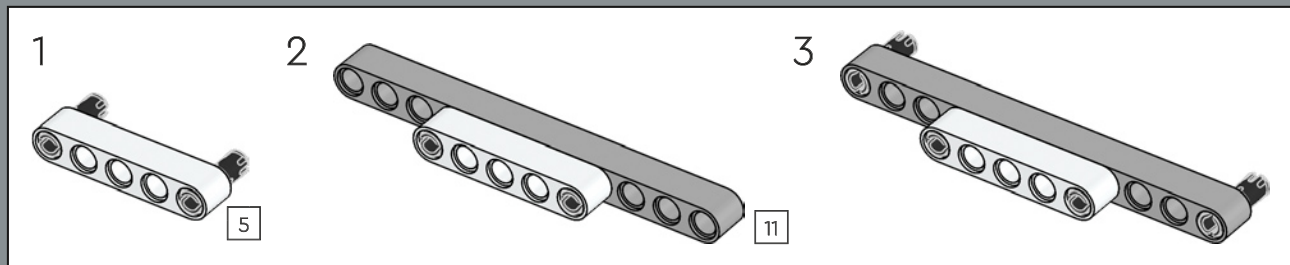
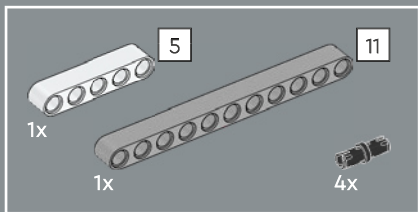

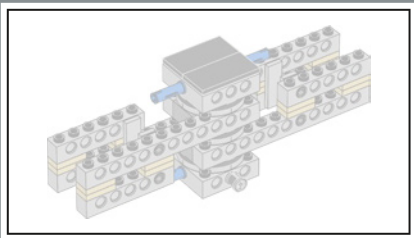

77

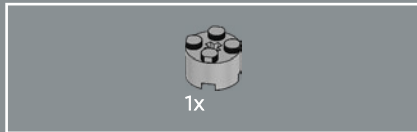
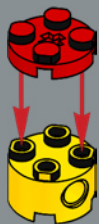

78

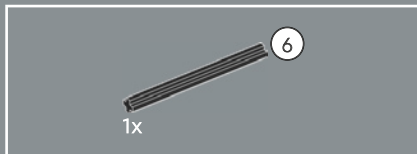

79

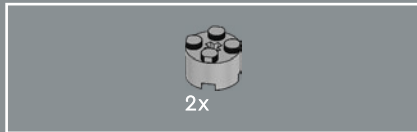
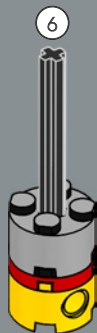

80

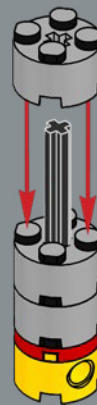

81



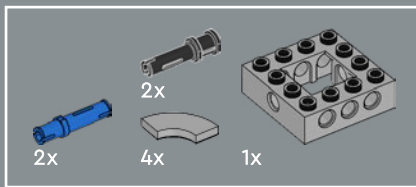

82

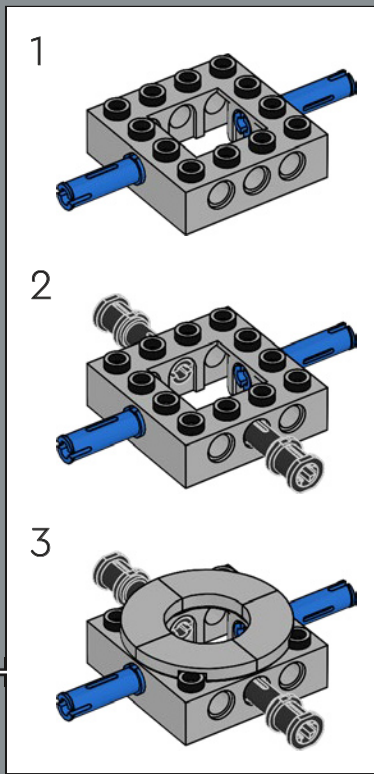
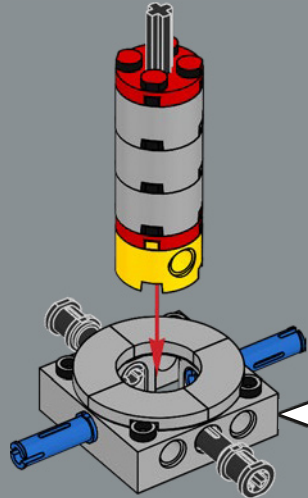

83

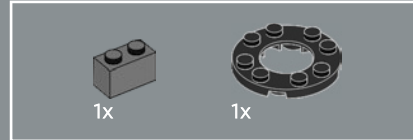
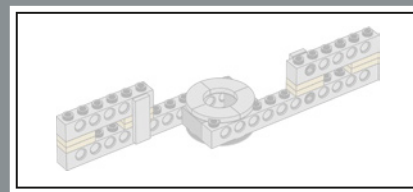
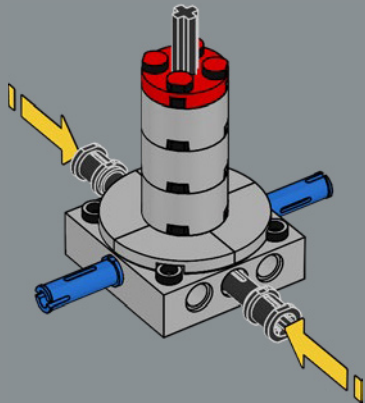

84

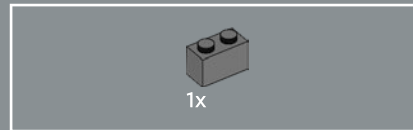
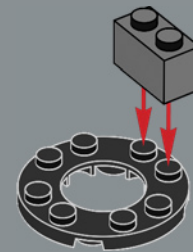

85

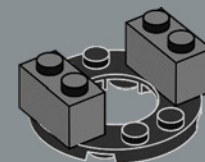

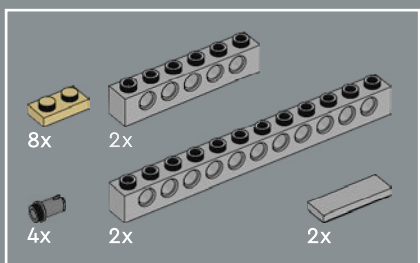

86

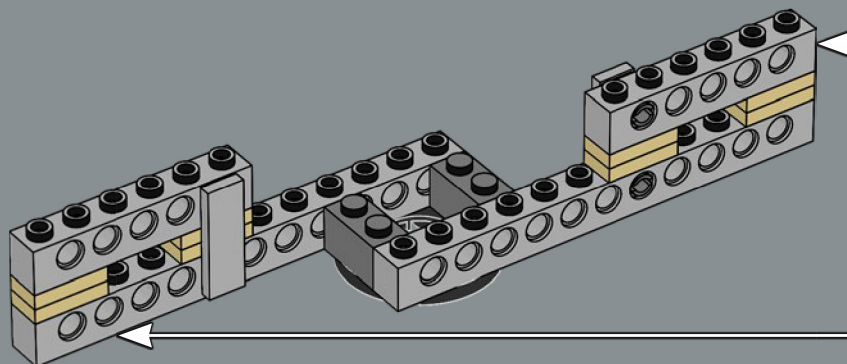
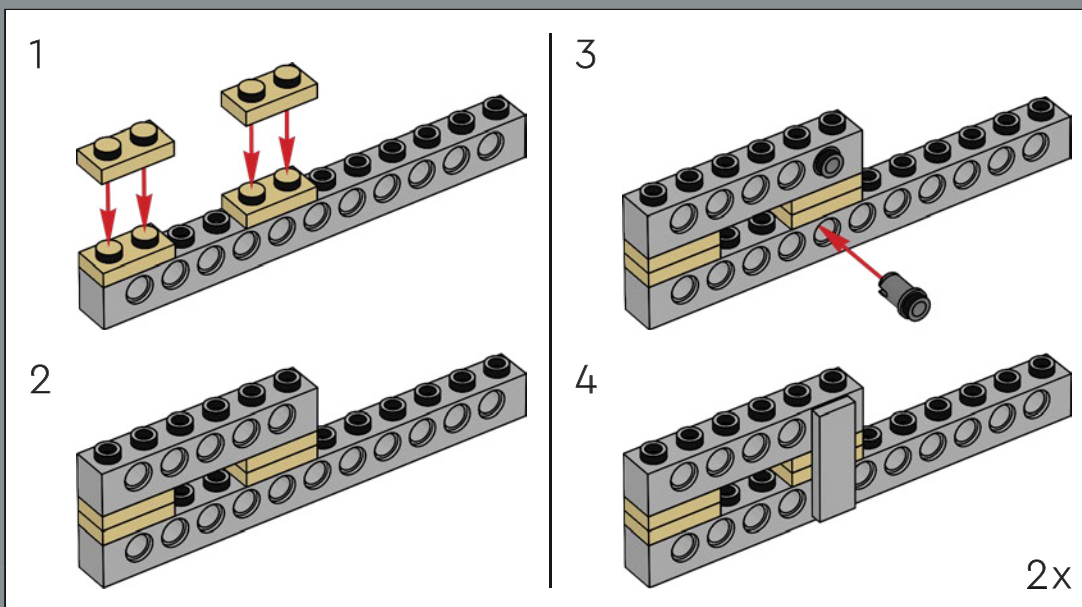

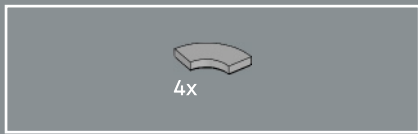

87

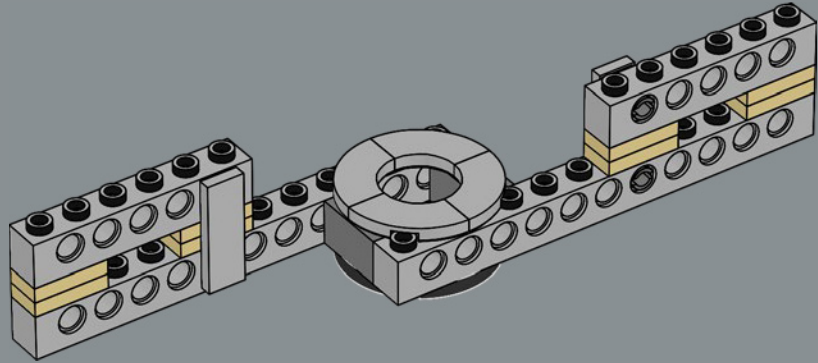

88

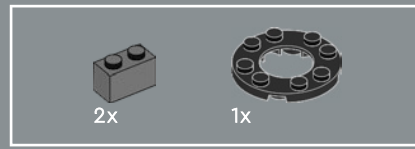
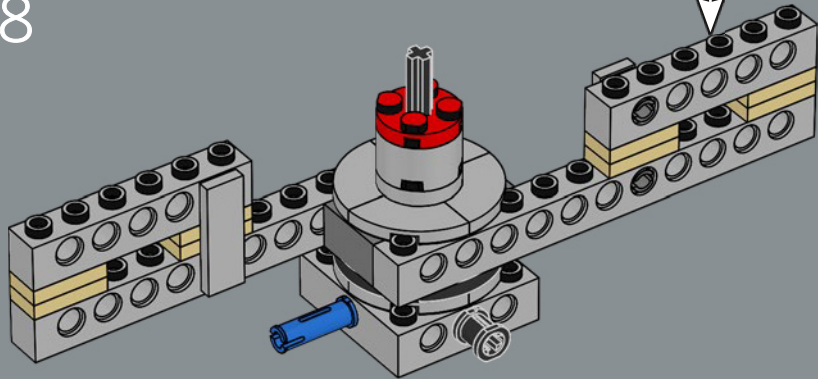

89

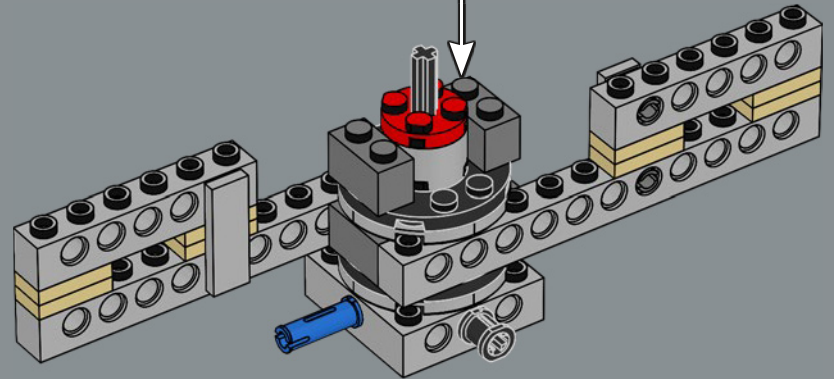
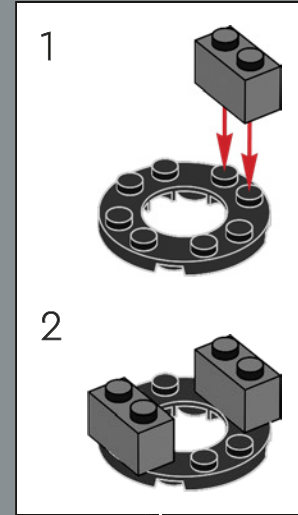

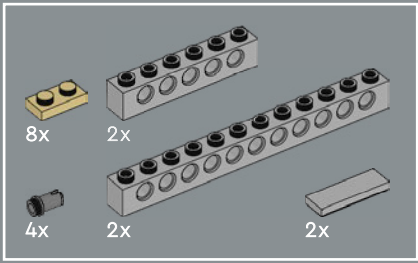

90

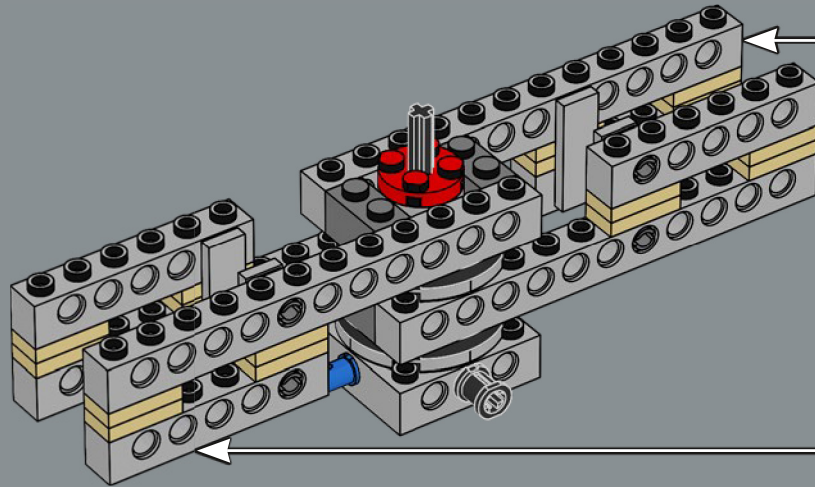
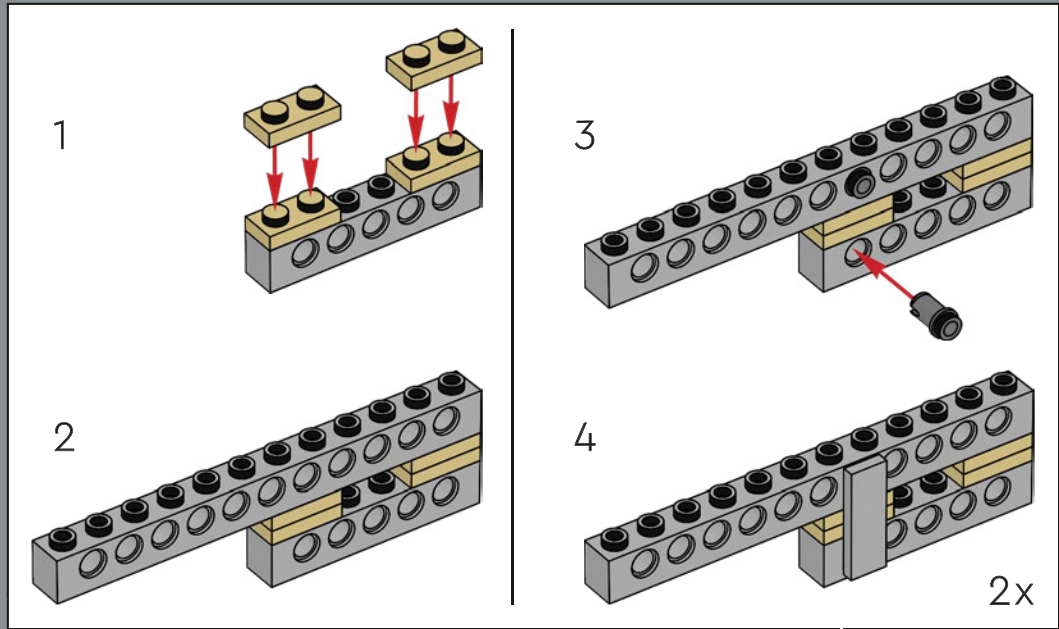

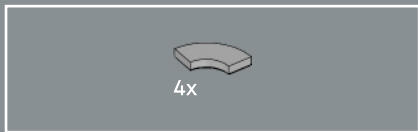

91

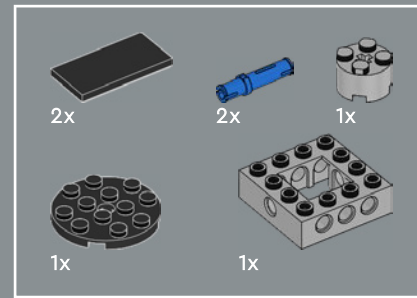
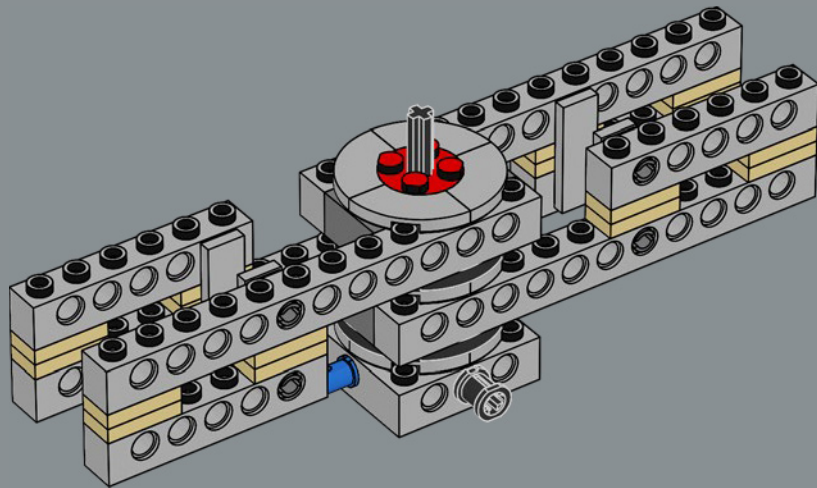

92

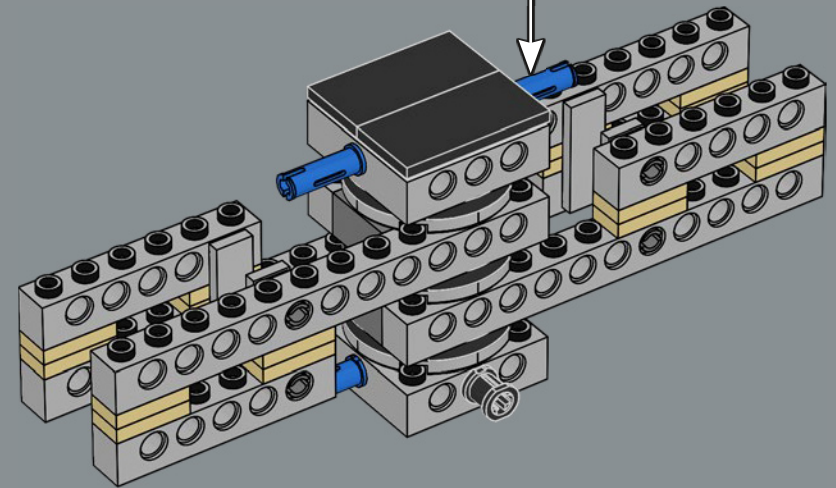
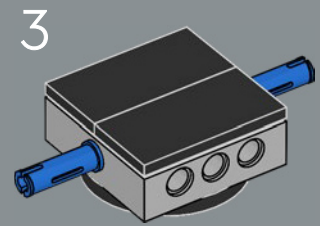
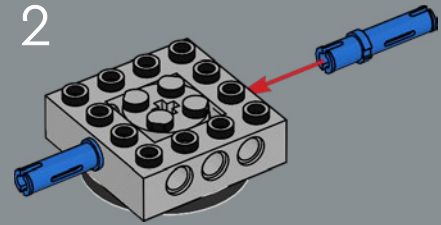
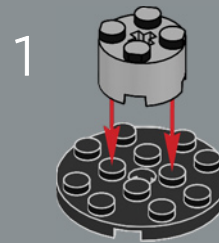

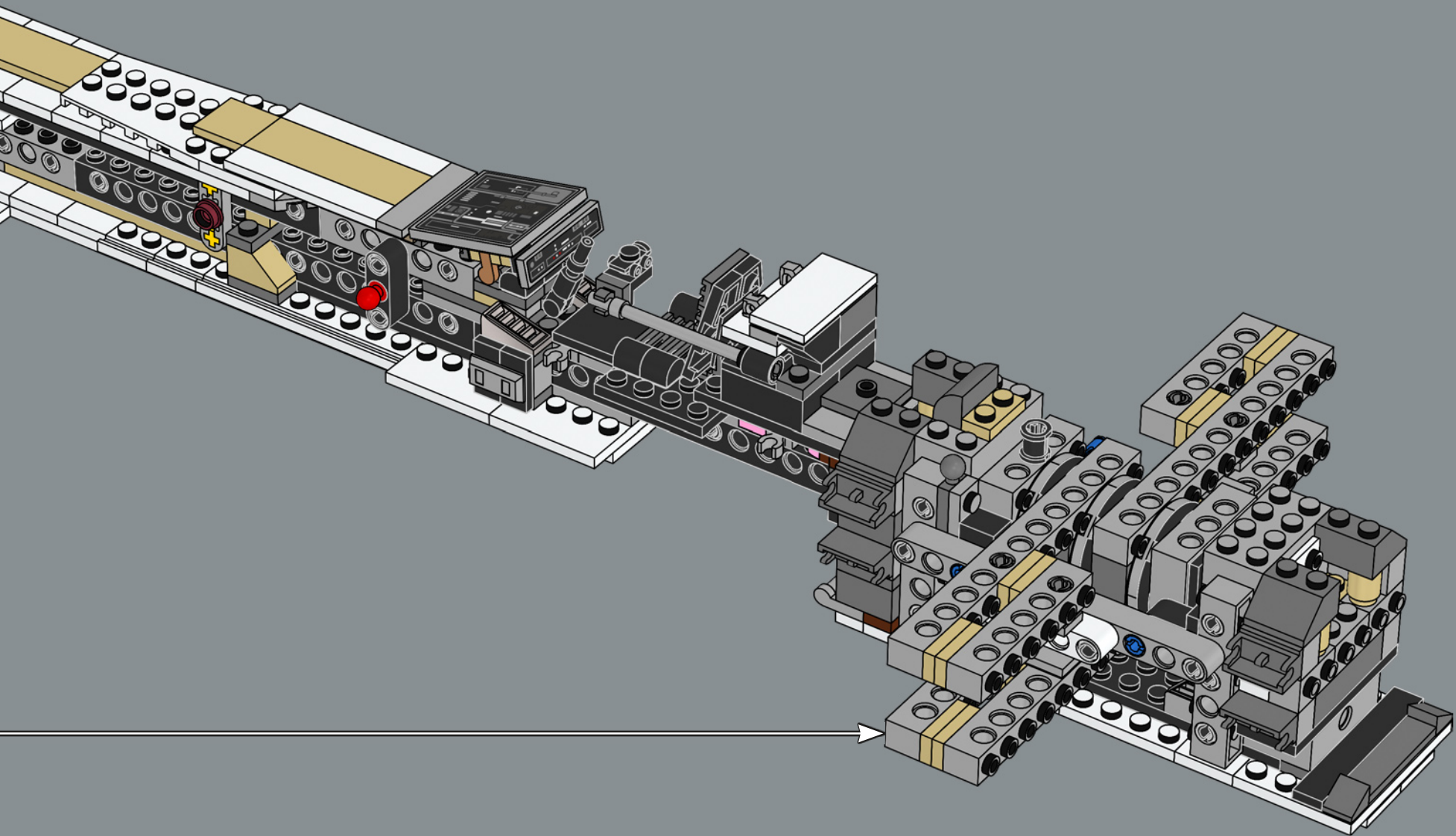

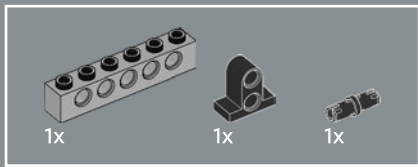

94

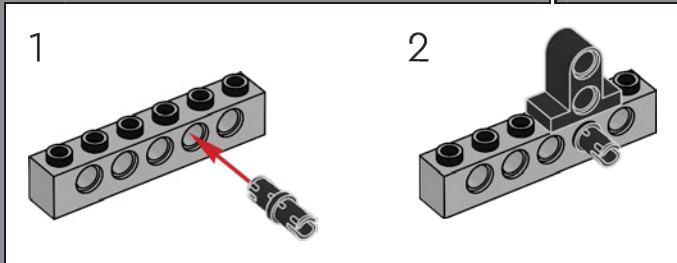
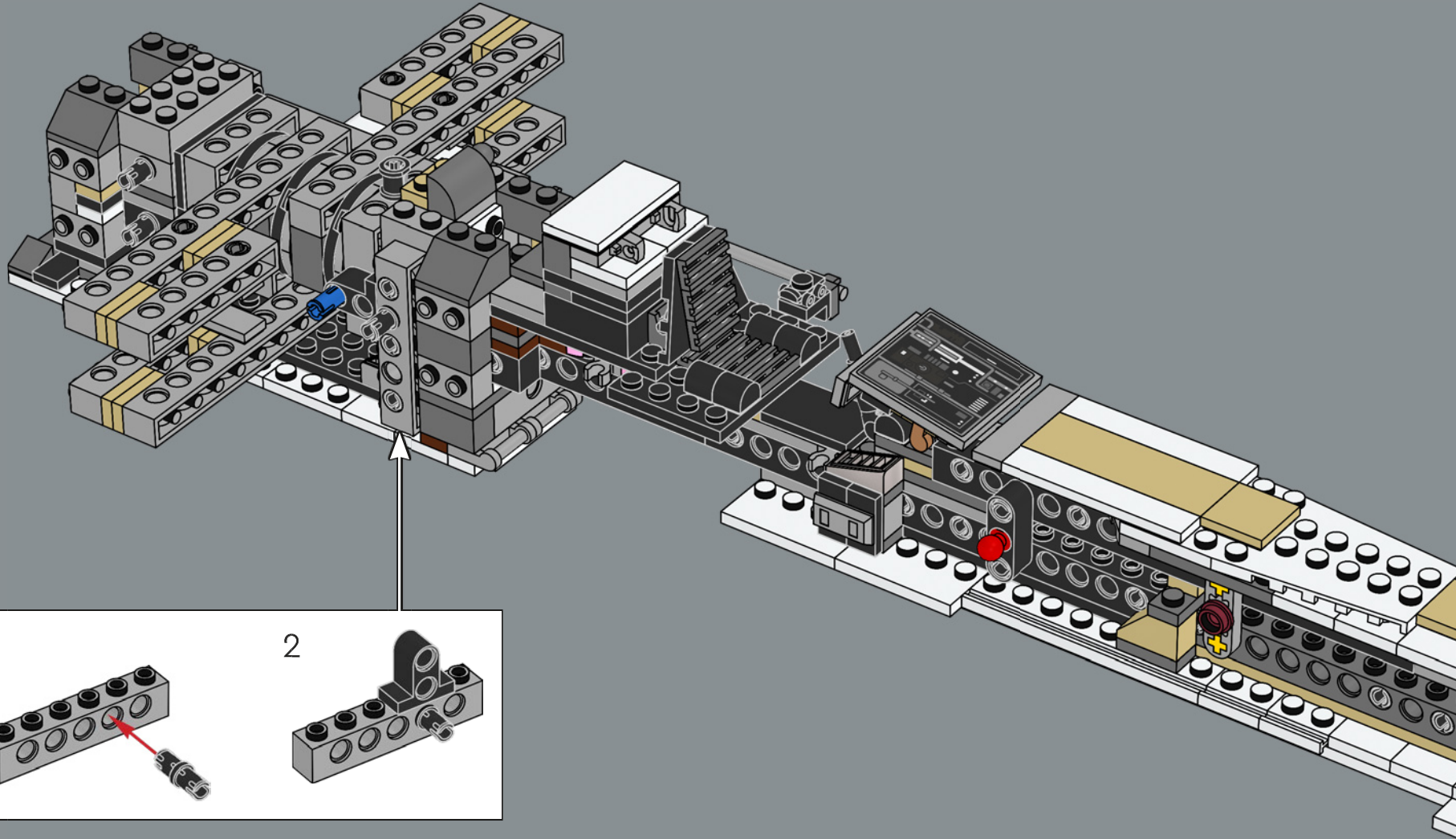

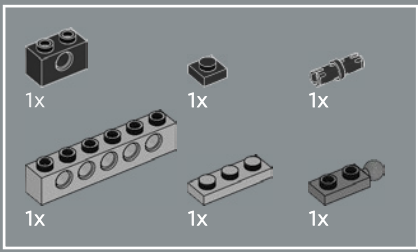

95

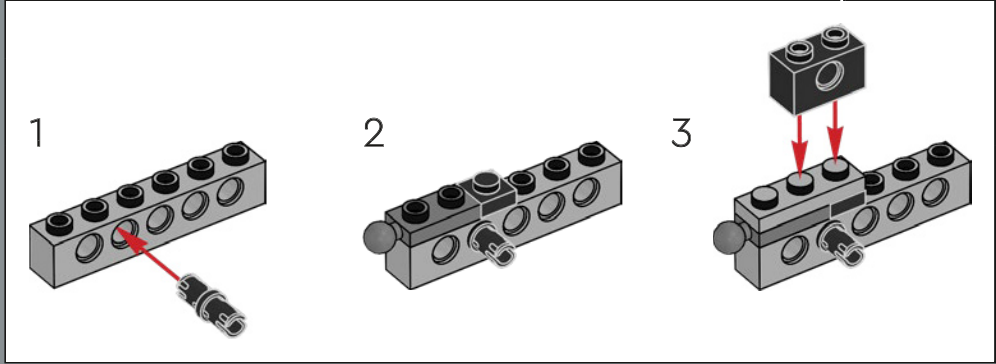
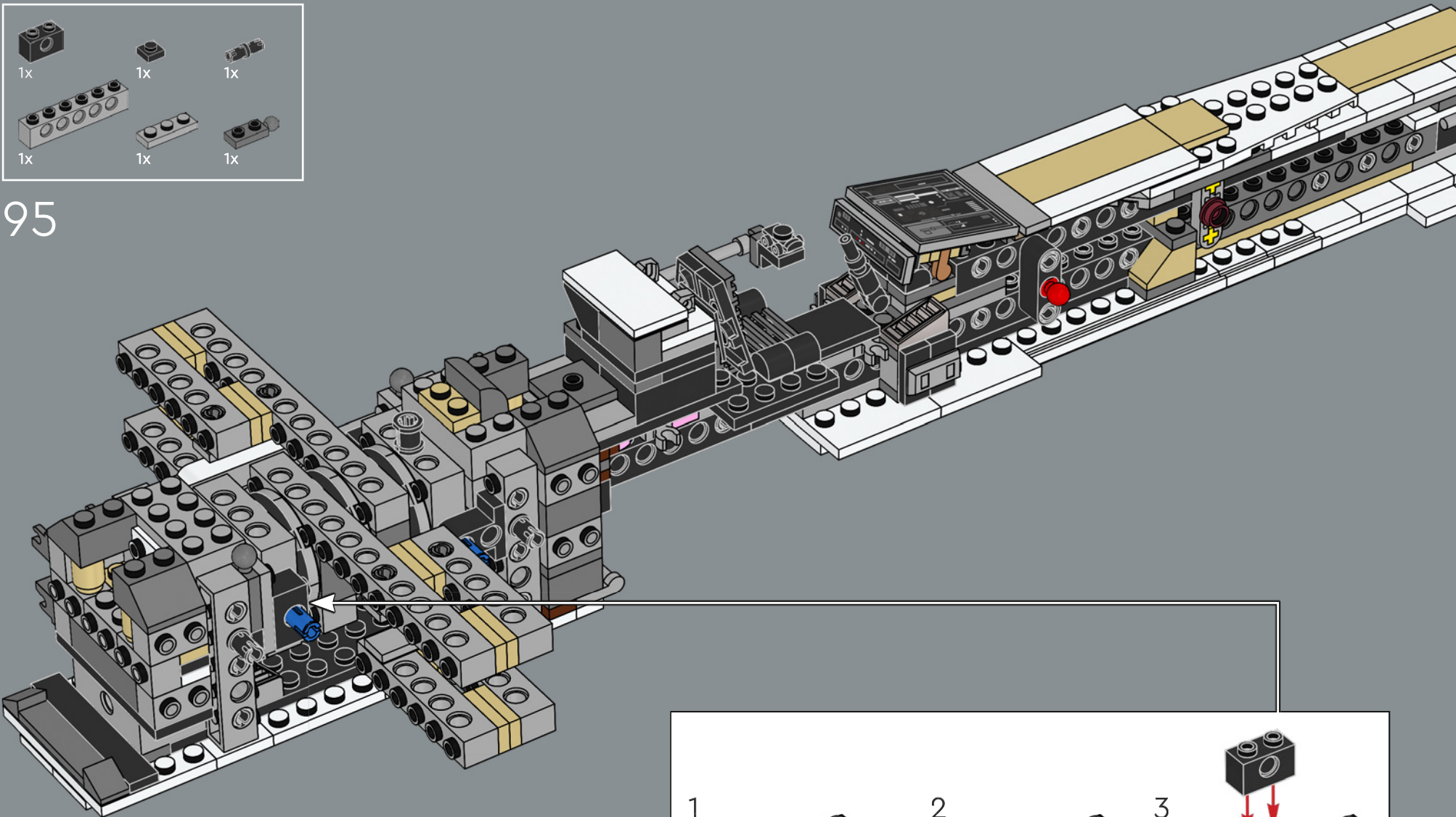

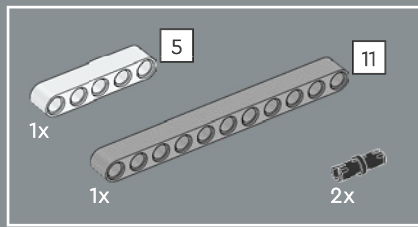

96

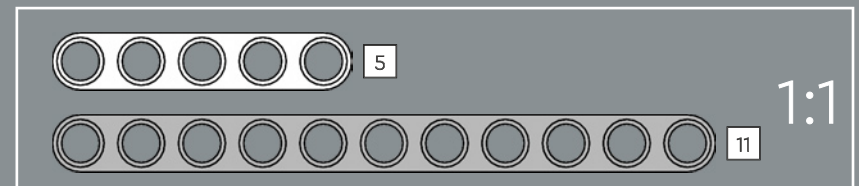
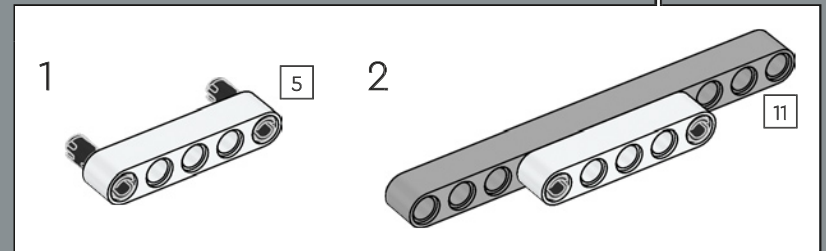
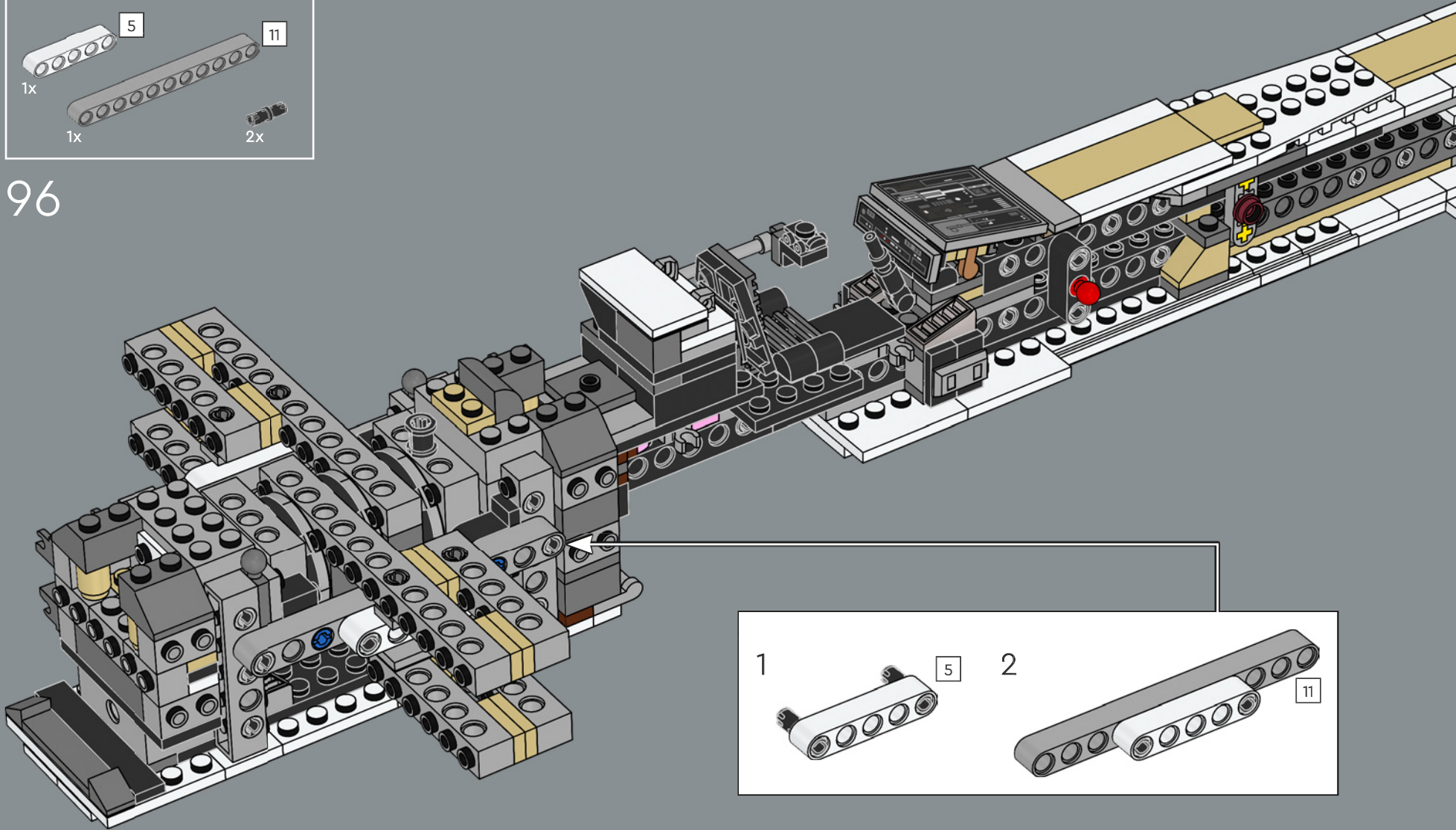



4x

97

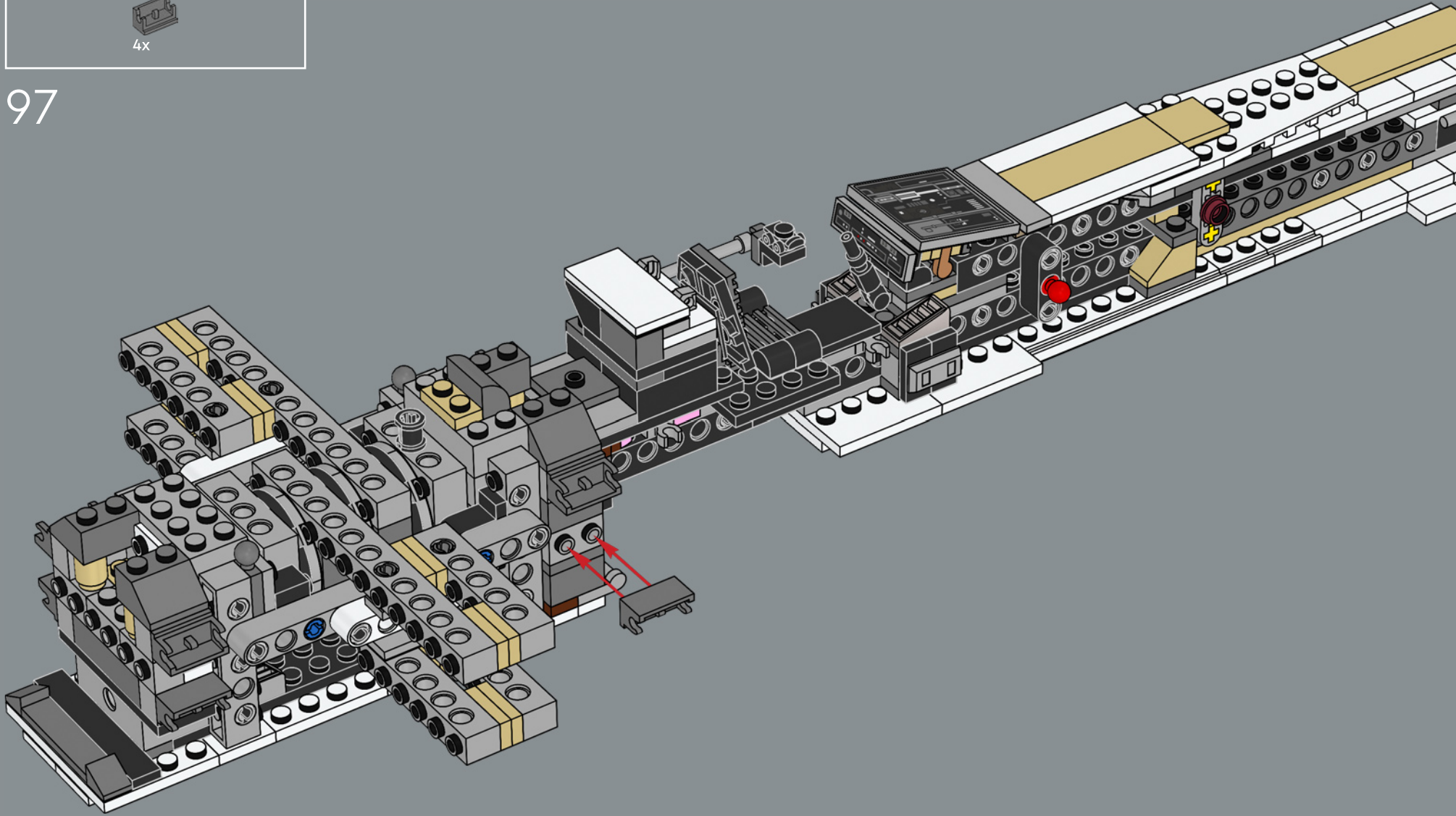



98

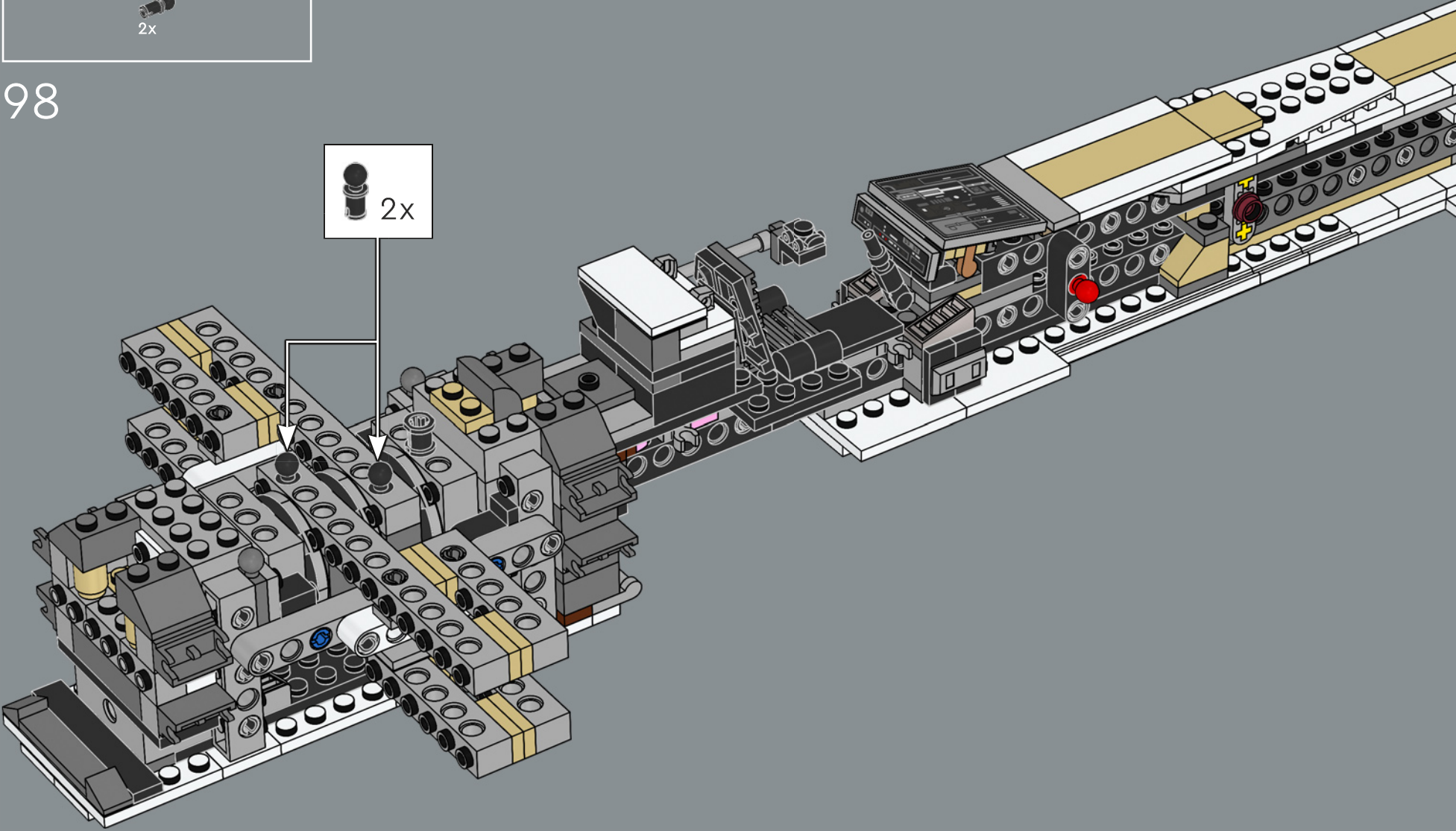

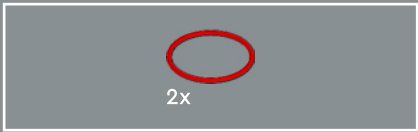

99

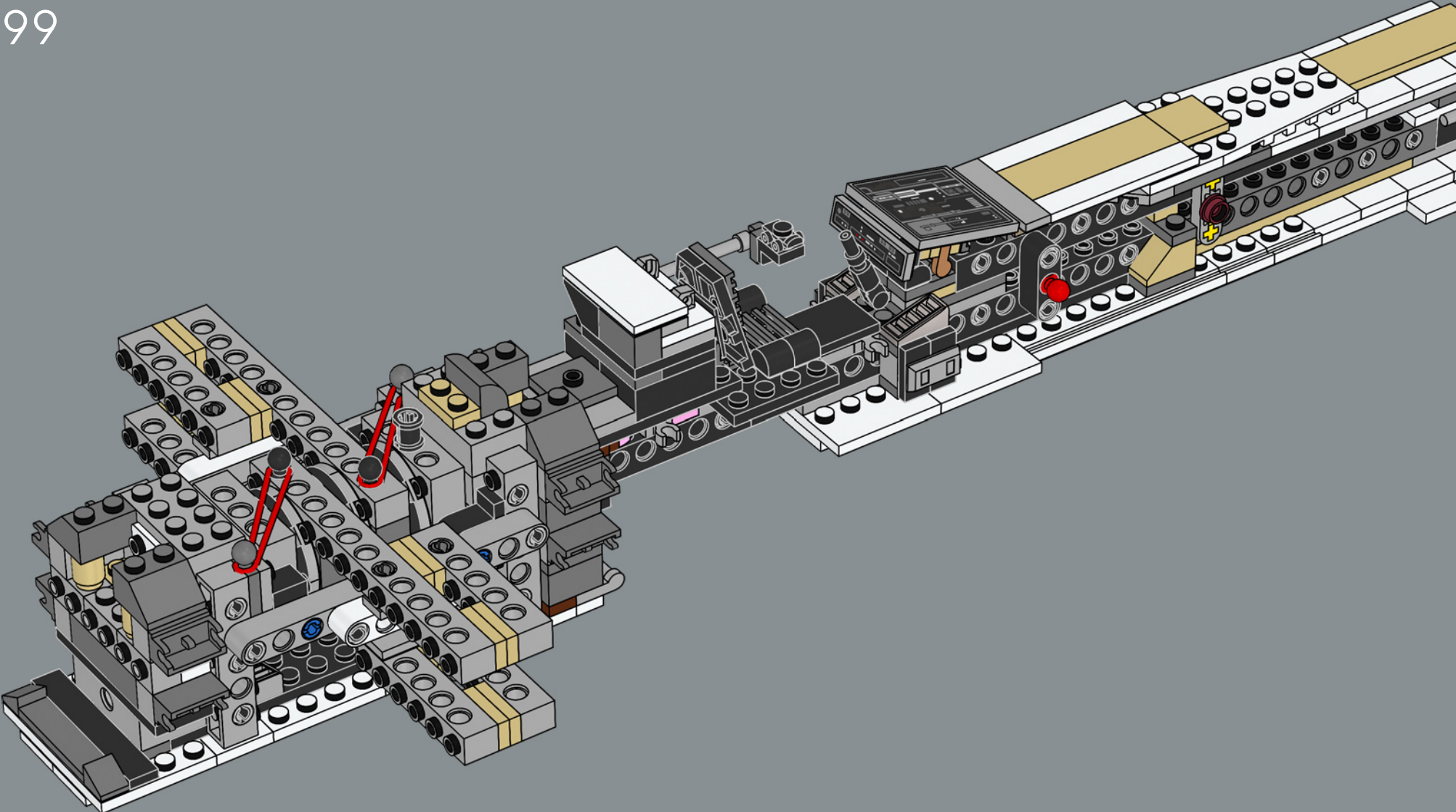

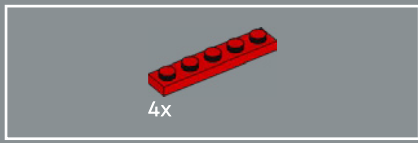

100

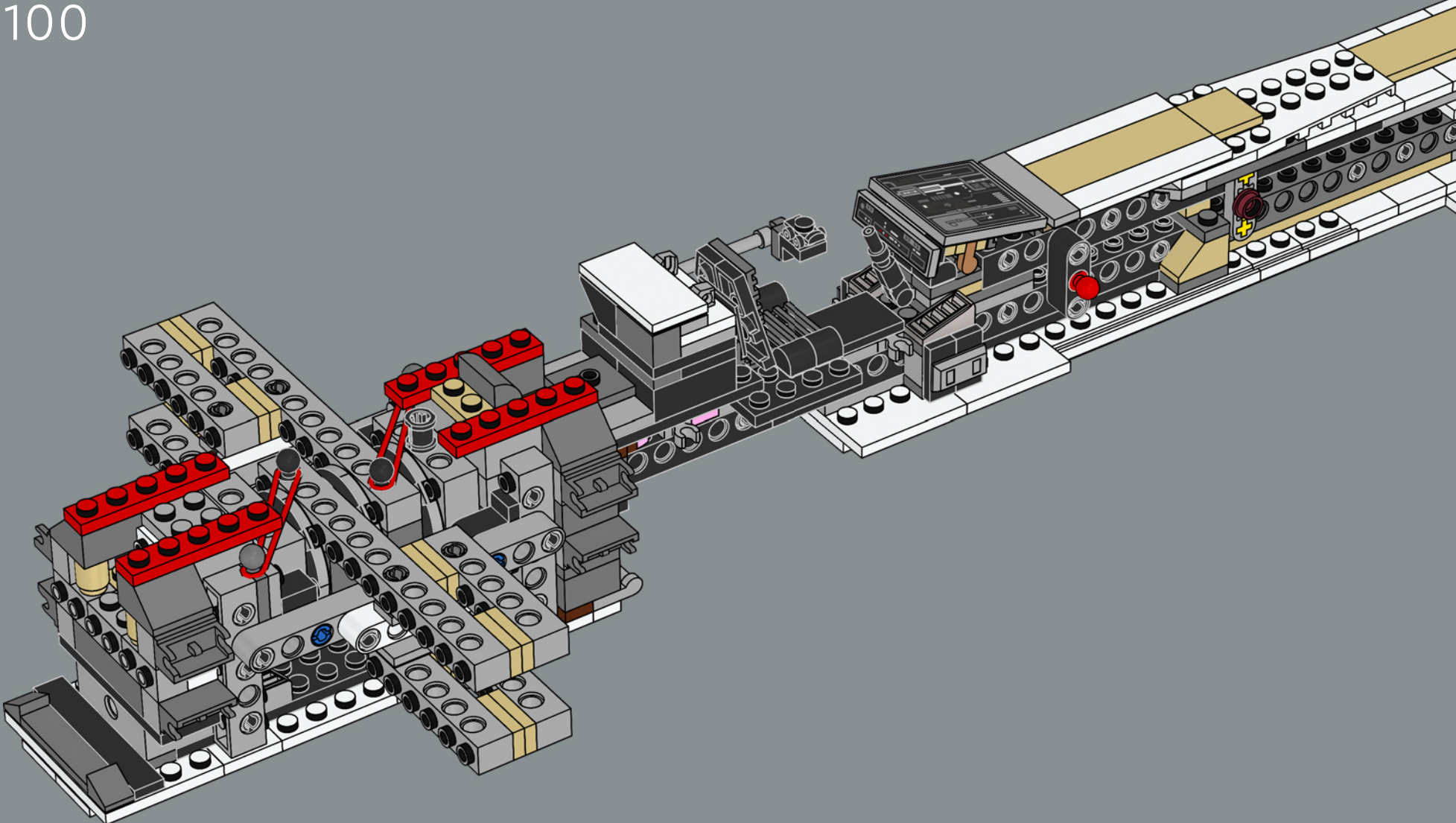

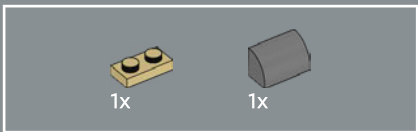

101

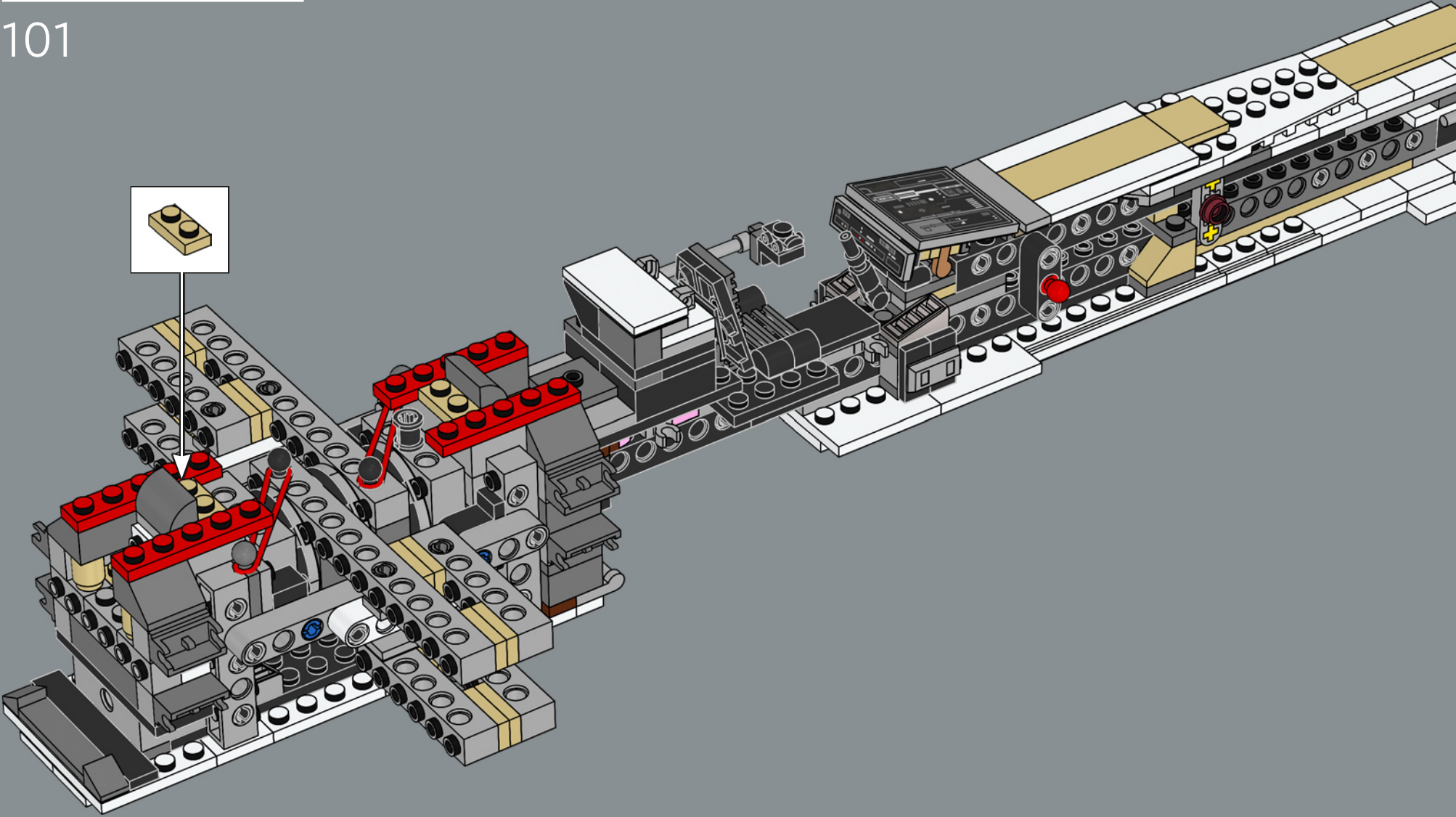

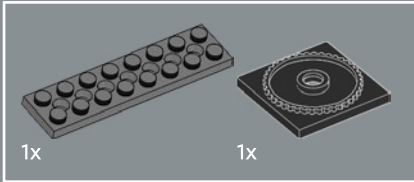
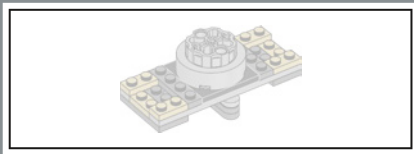

102

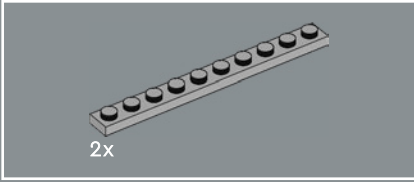
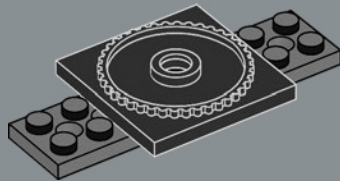

103

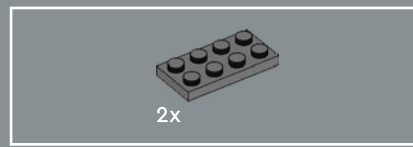
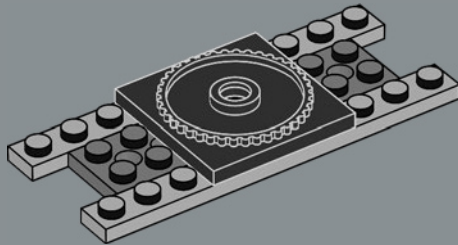

104

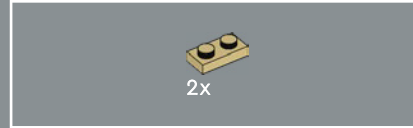
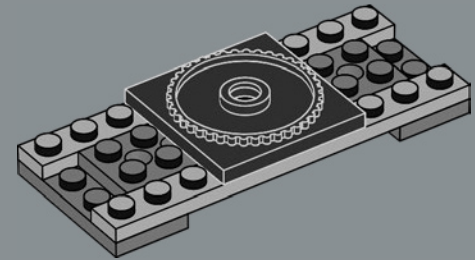

105

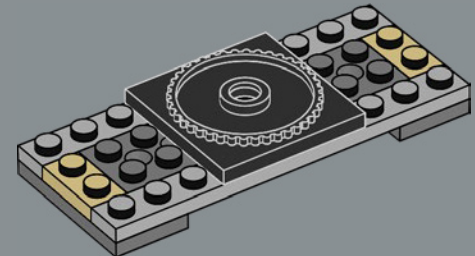

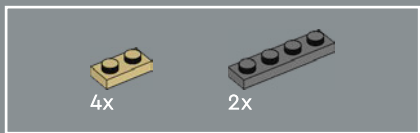

106

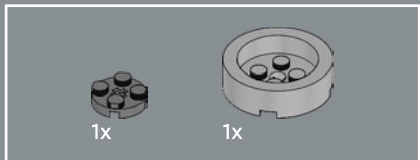
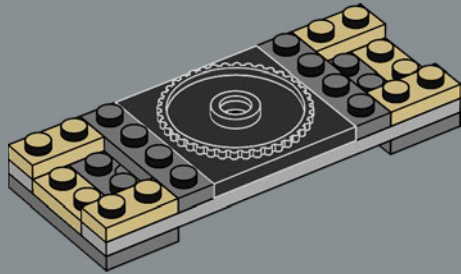

107

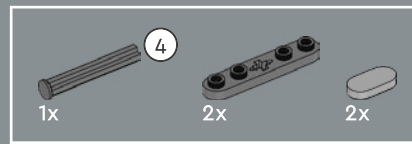
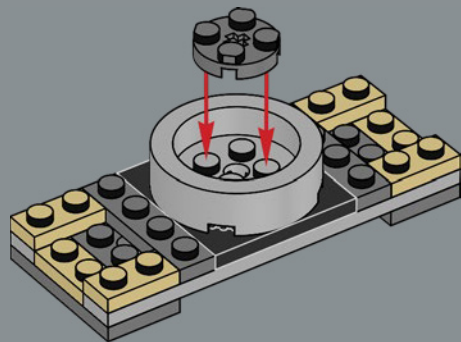

108

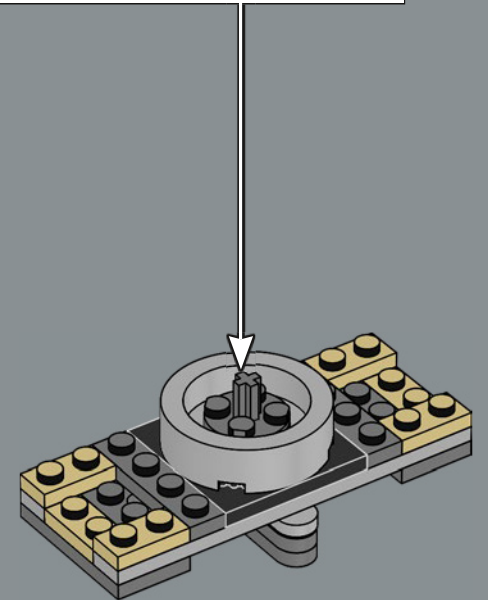
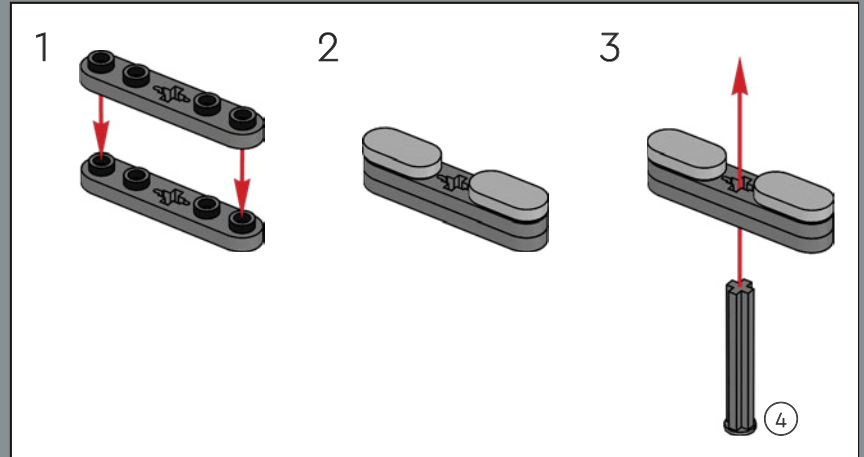

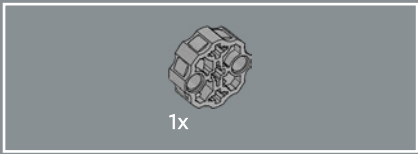

109

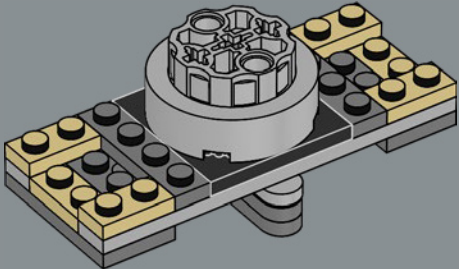

110

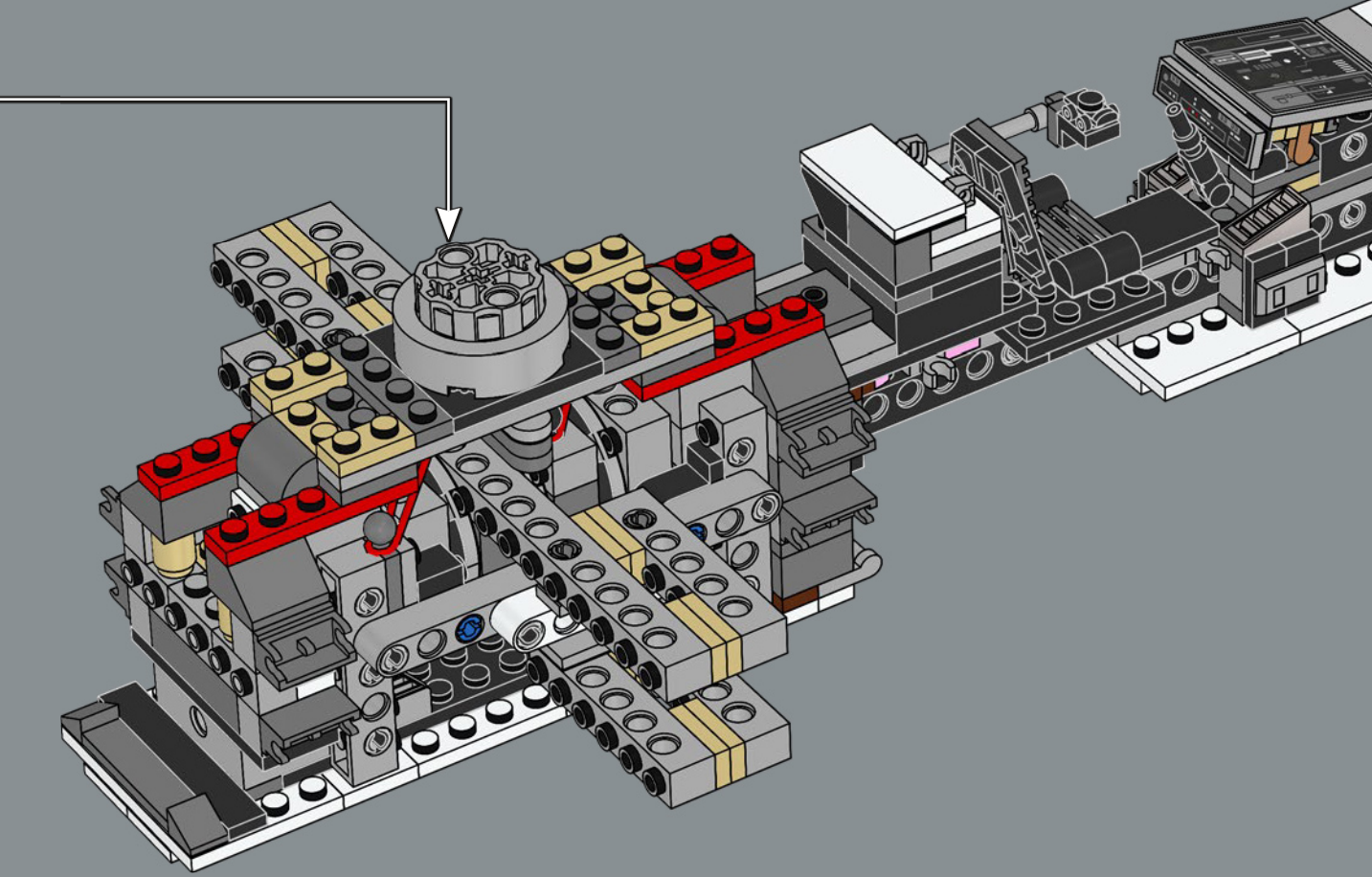

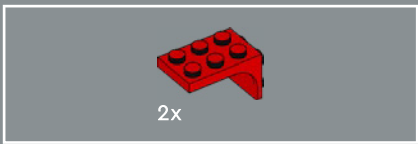

111

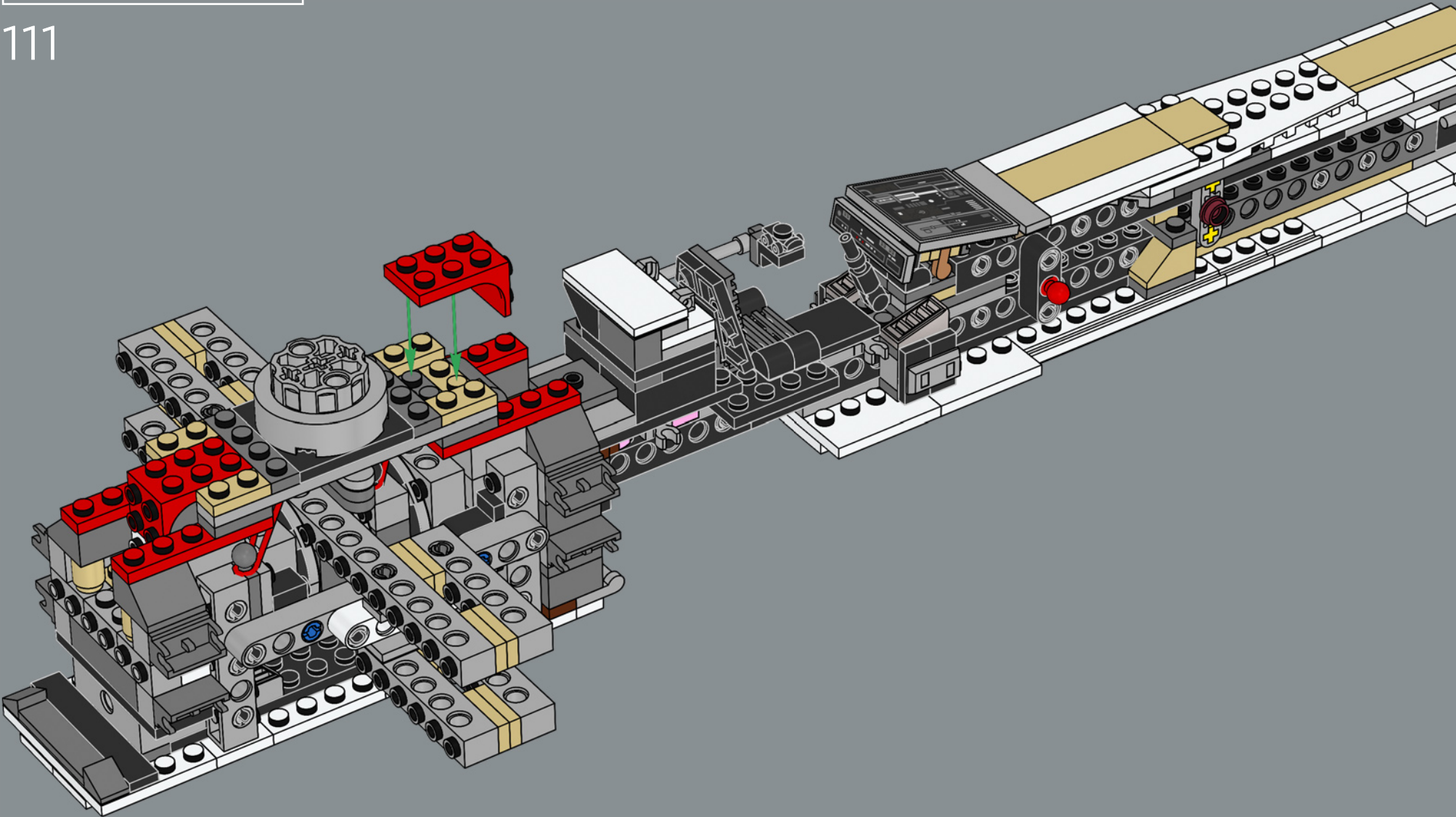

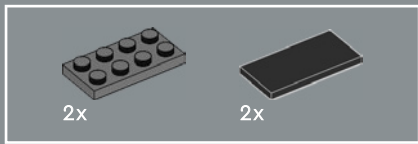

112

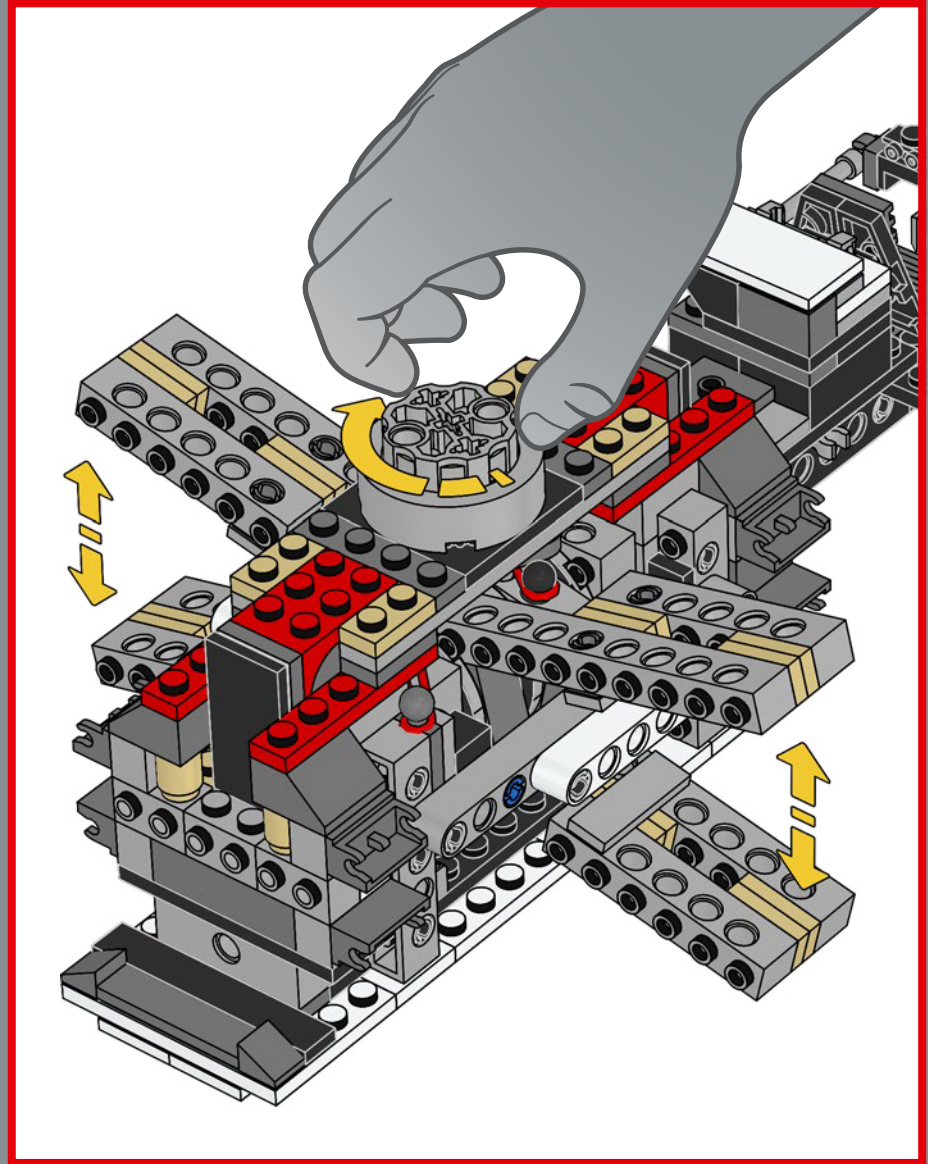
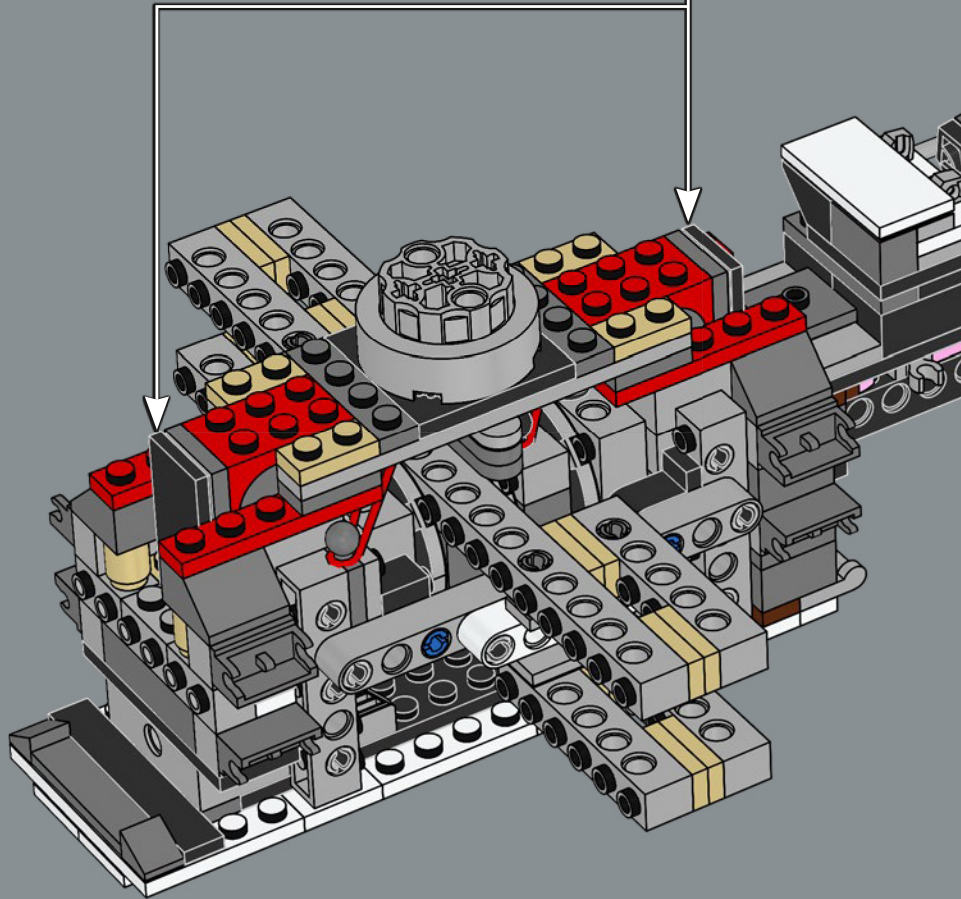
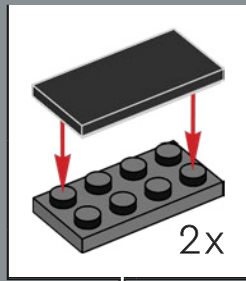

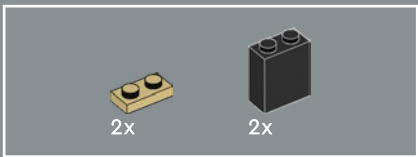

113

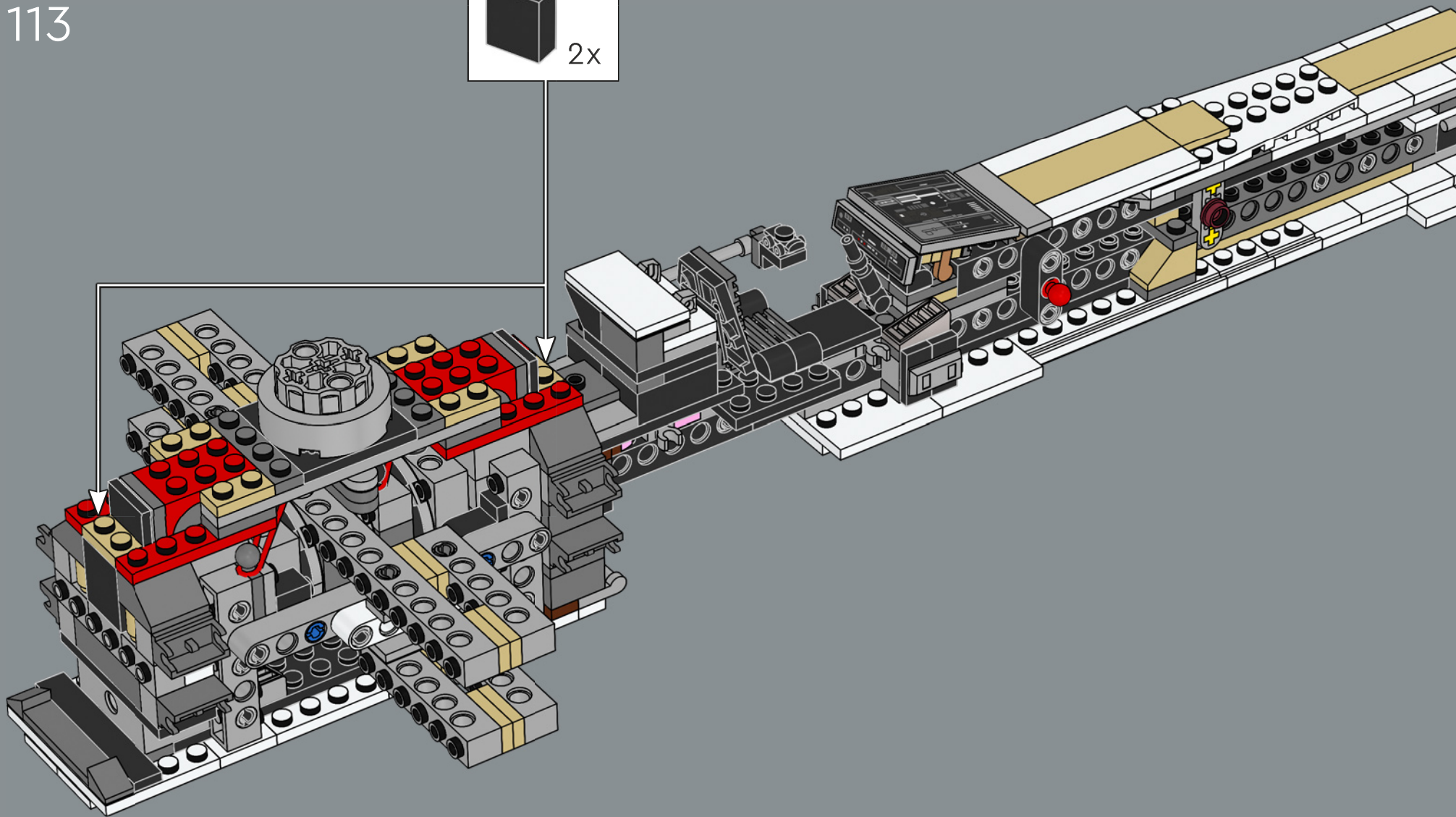
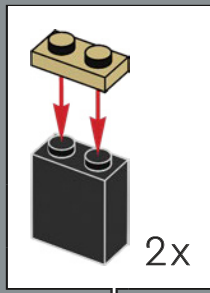

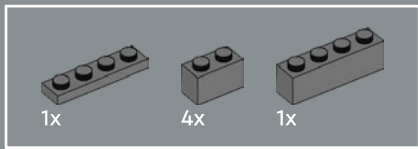

114

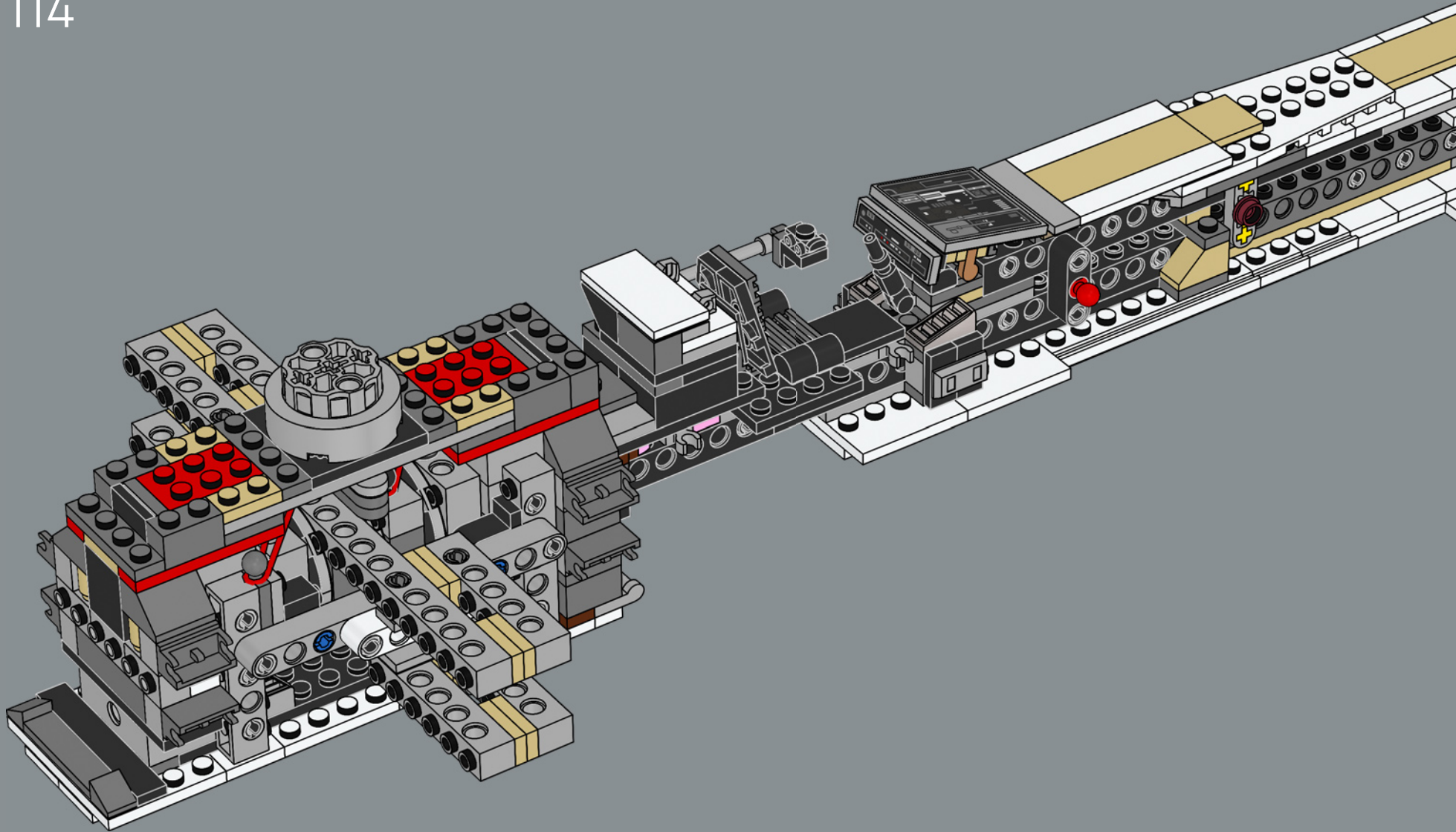

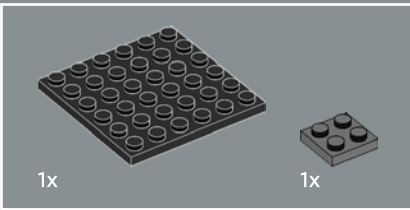
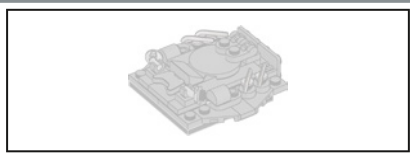

115

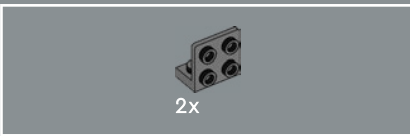
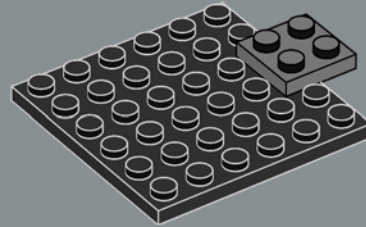

116

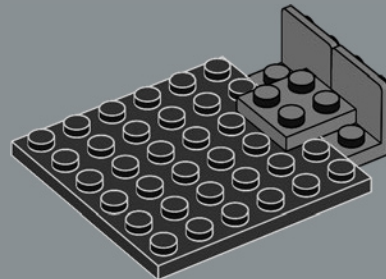

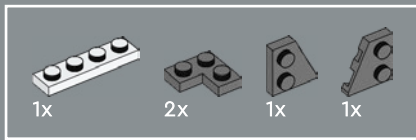

117

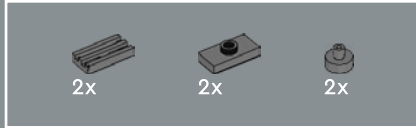
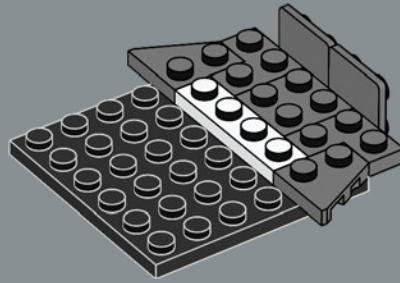

118

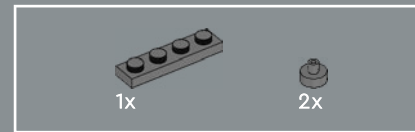
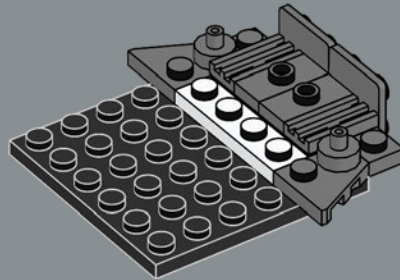

119

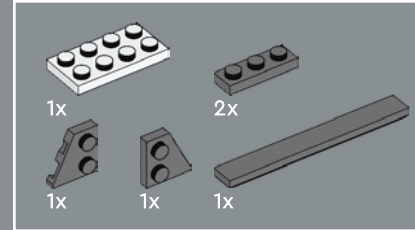
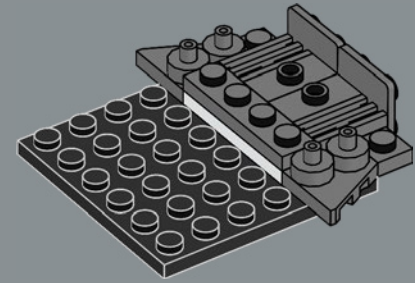

120

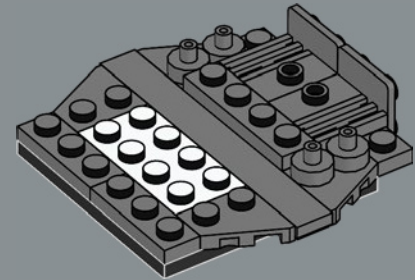

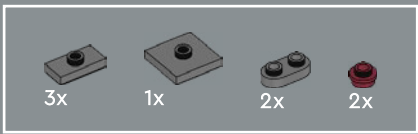

121

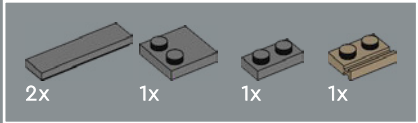
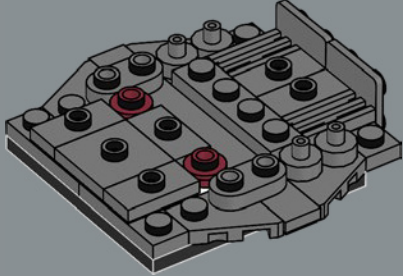

122

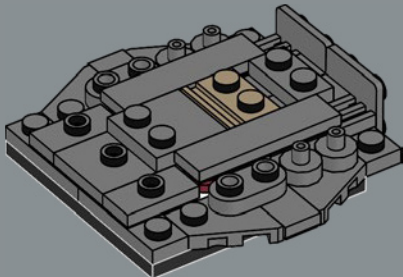

123

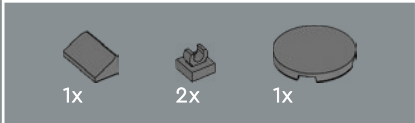
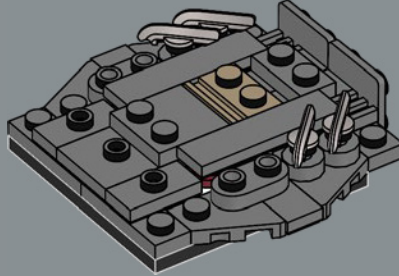

124

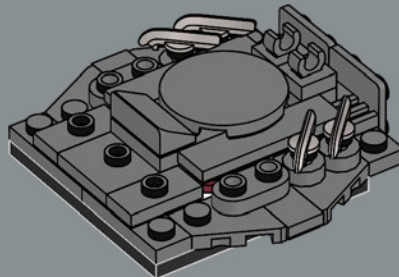

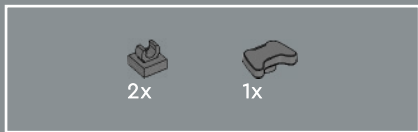

125

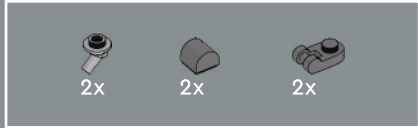
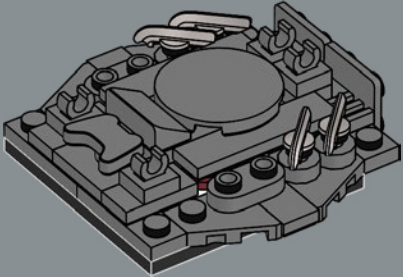

126

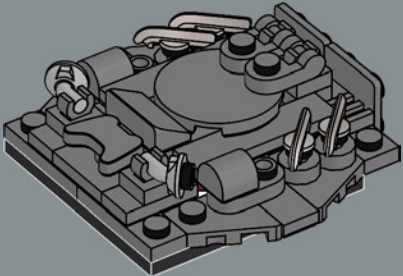

127

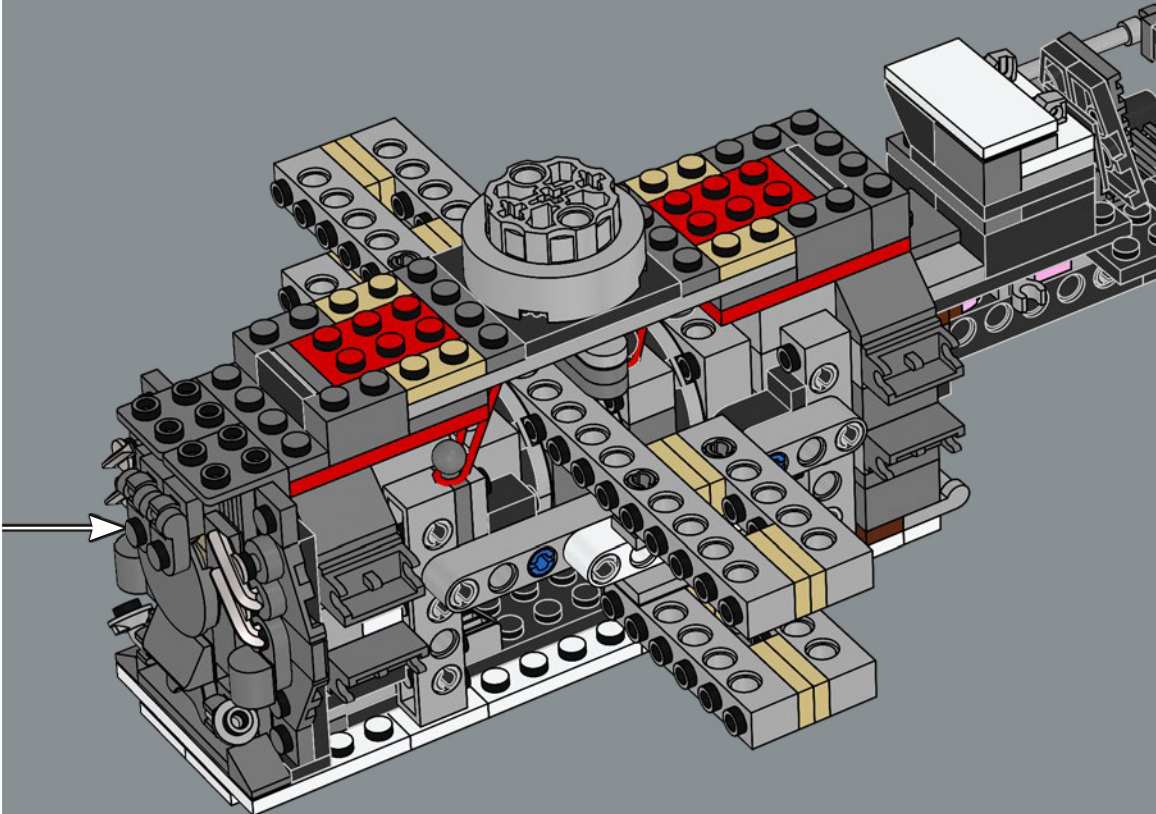

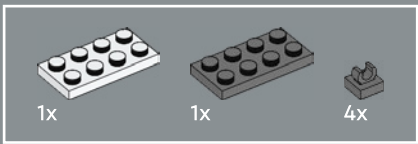

128

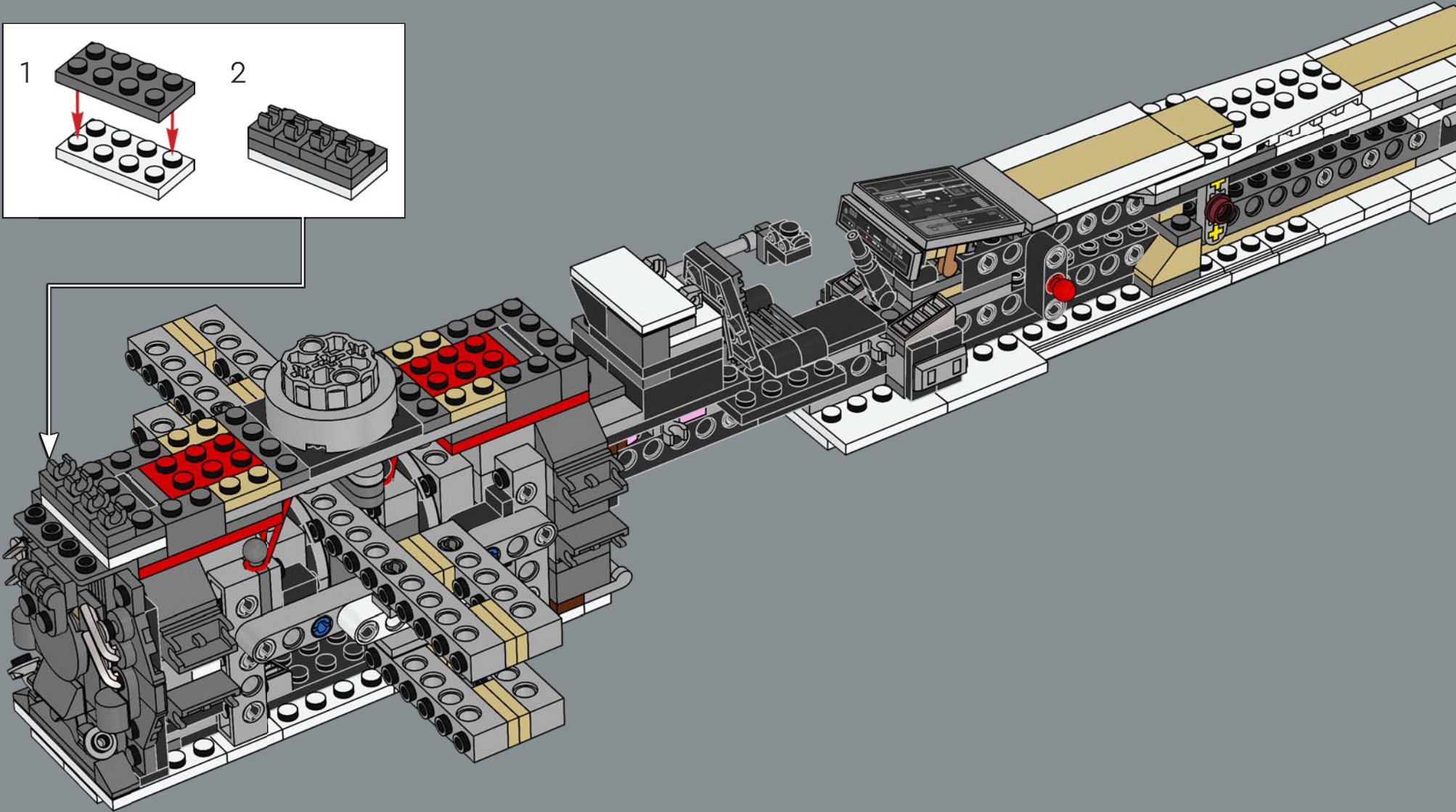
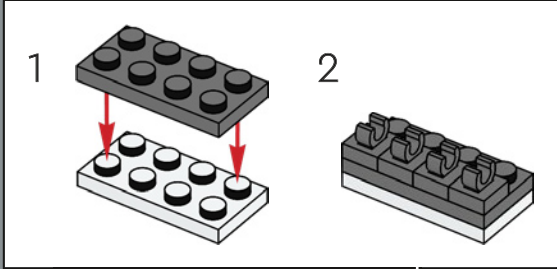

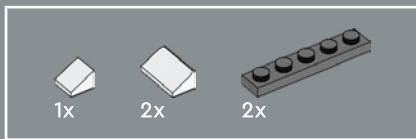

129

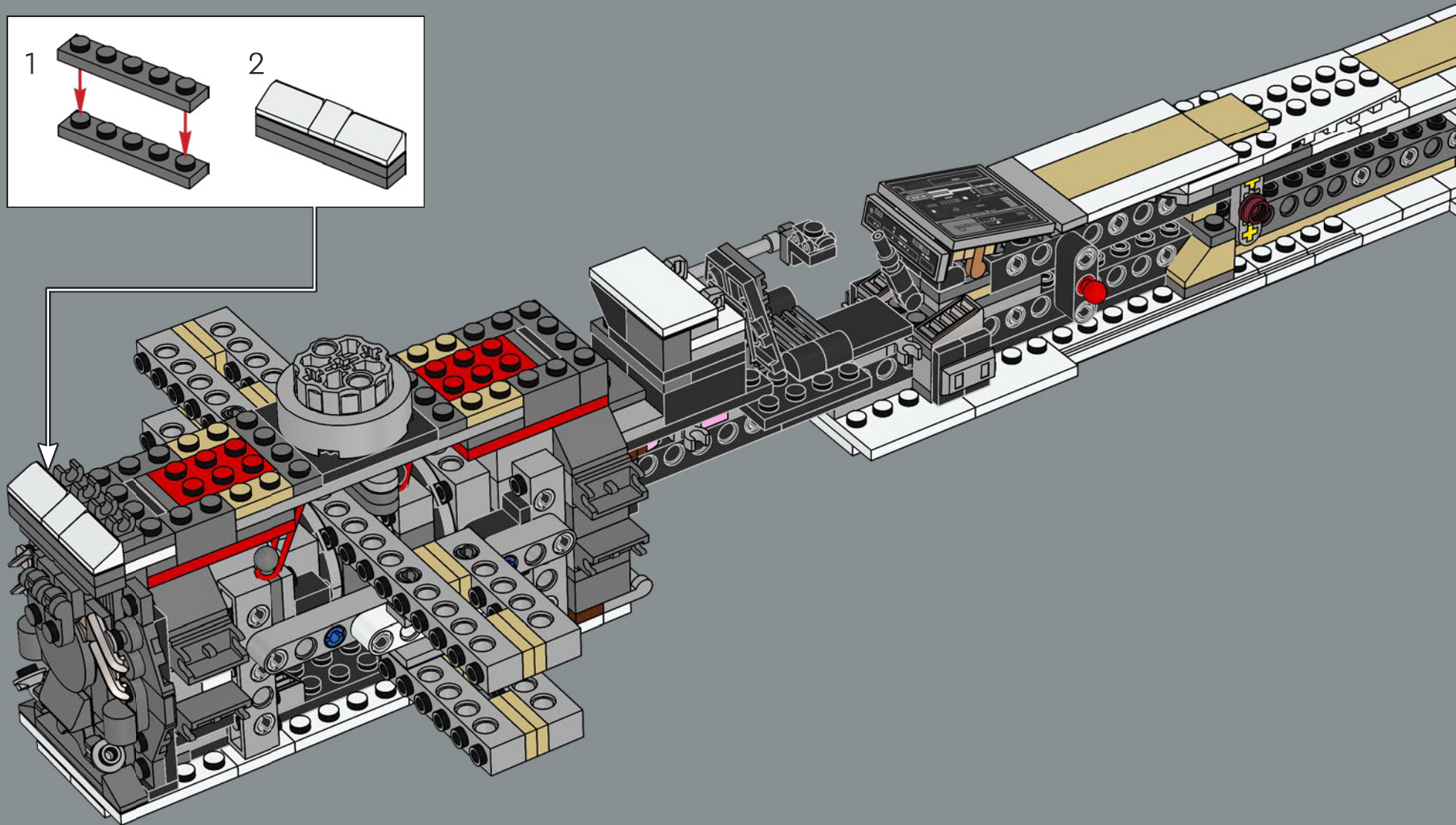
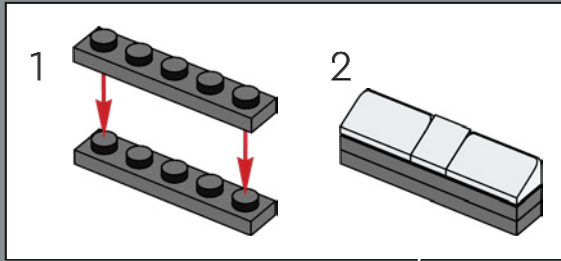

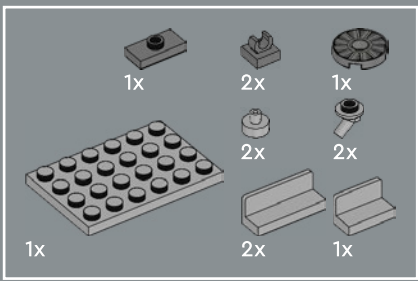

130

1

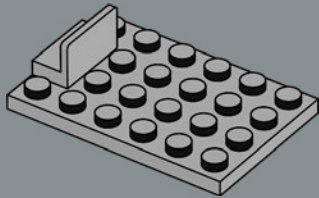

2

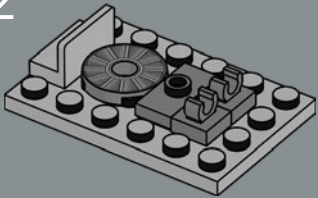

3

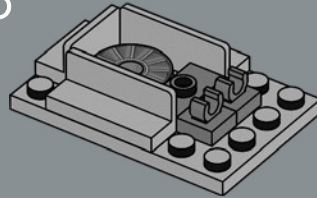

4

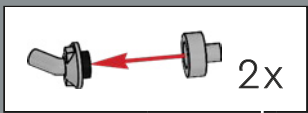
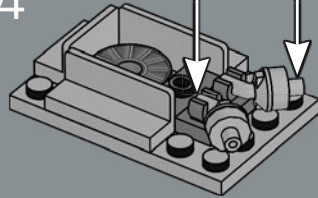

2x

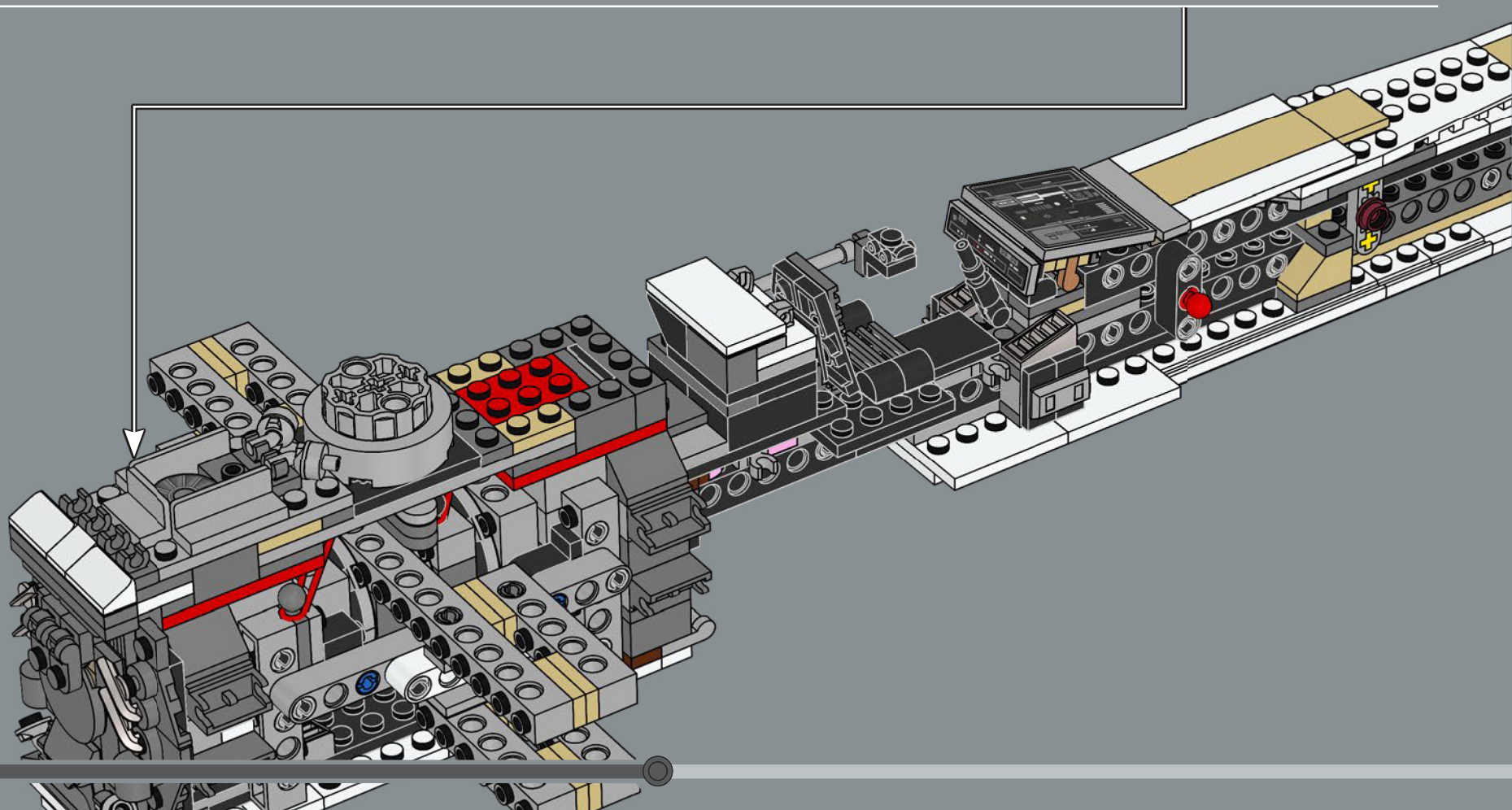

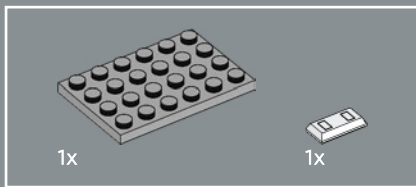

131

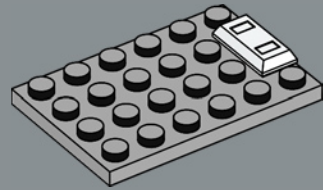

132

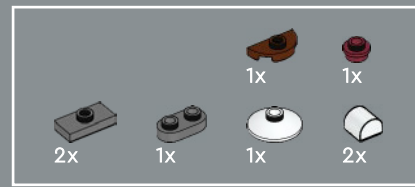
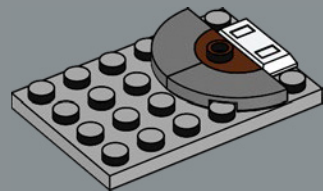

133

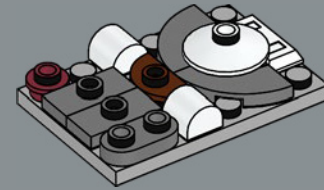

134

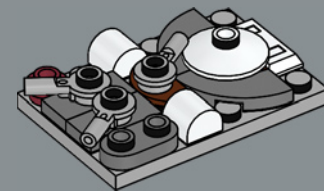

135

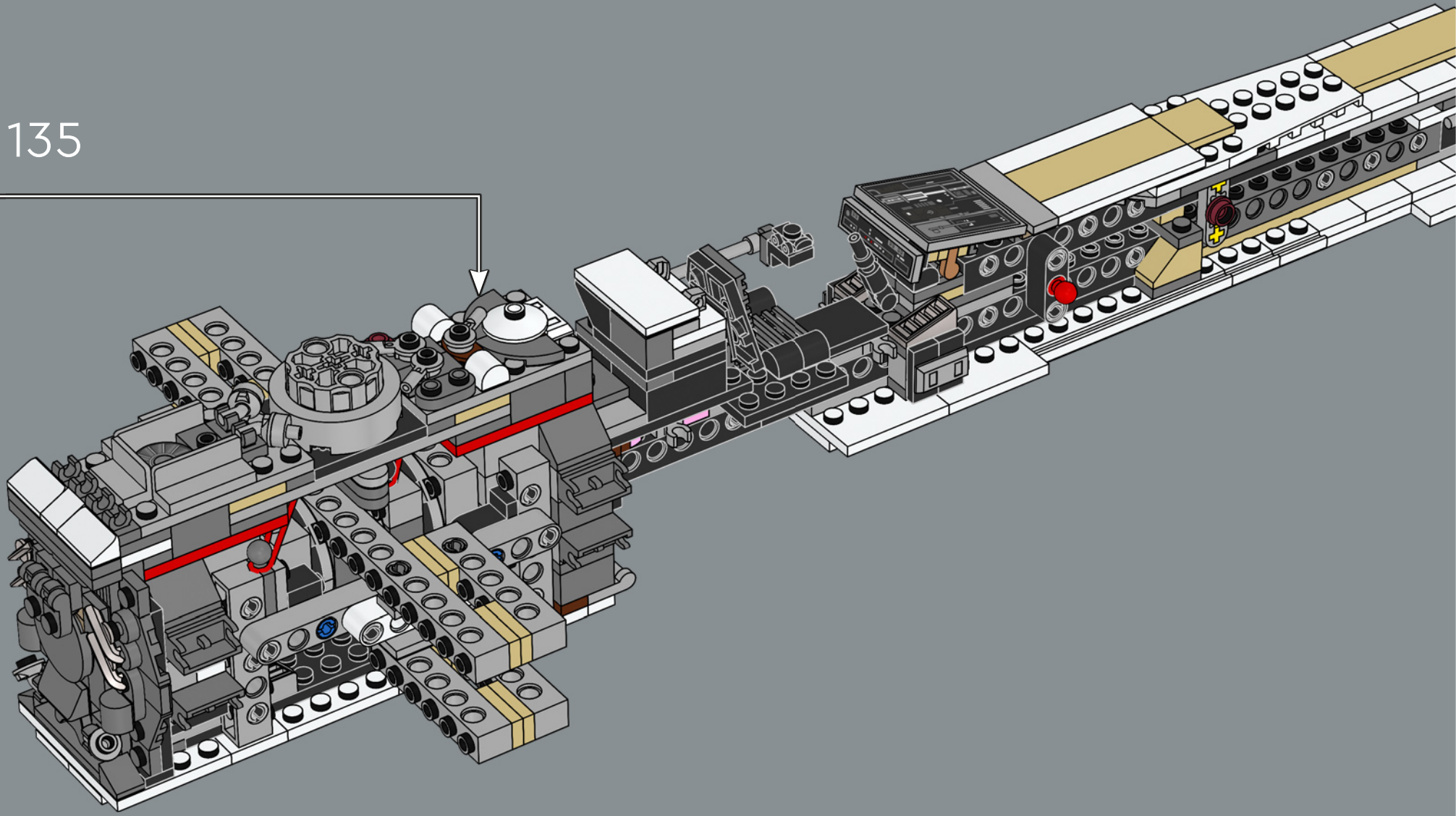

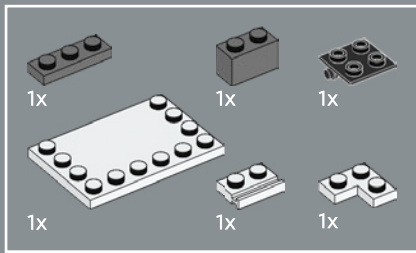

136

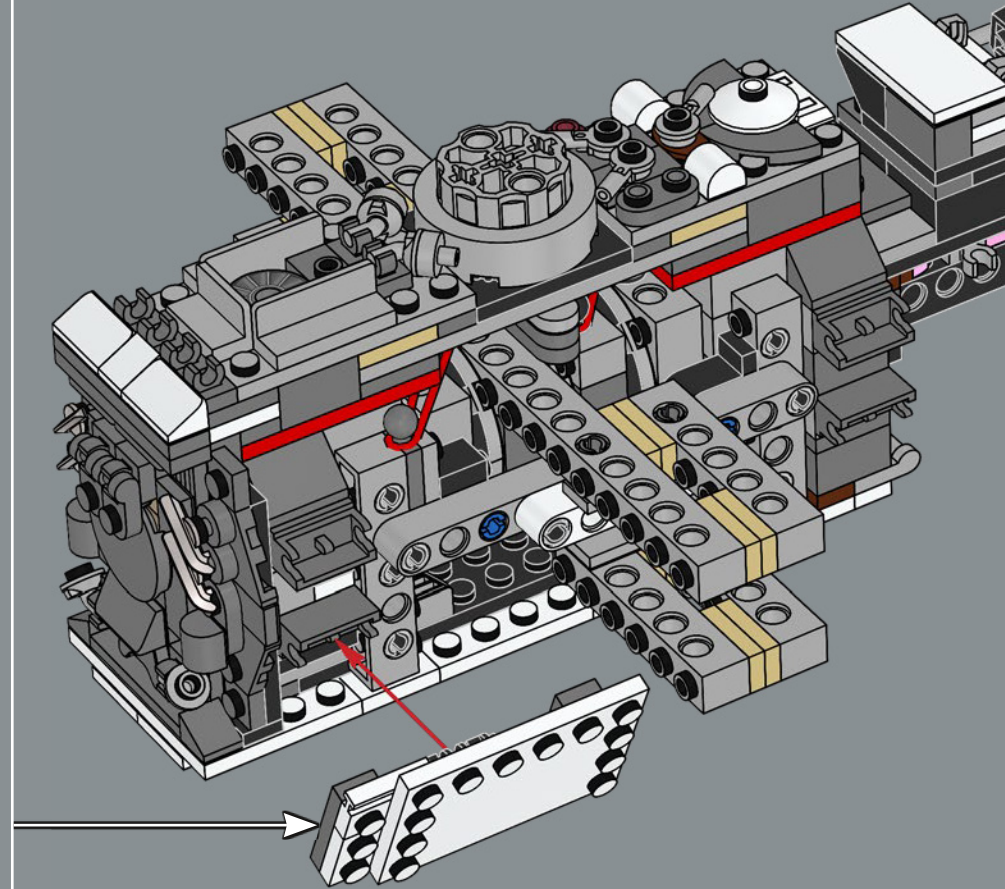
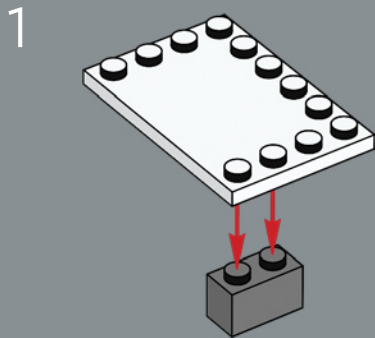
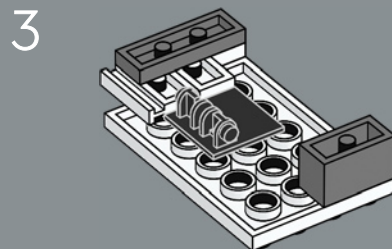
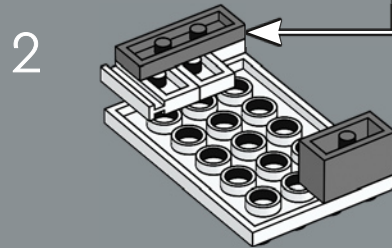
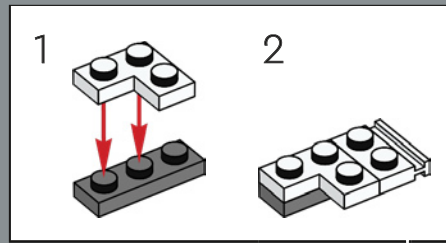

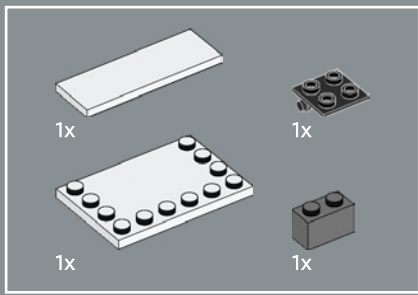

137

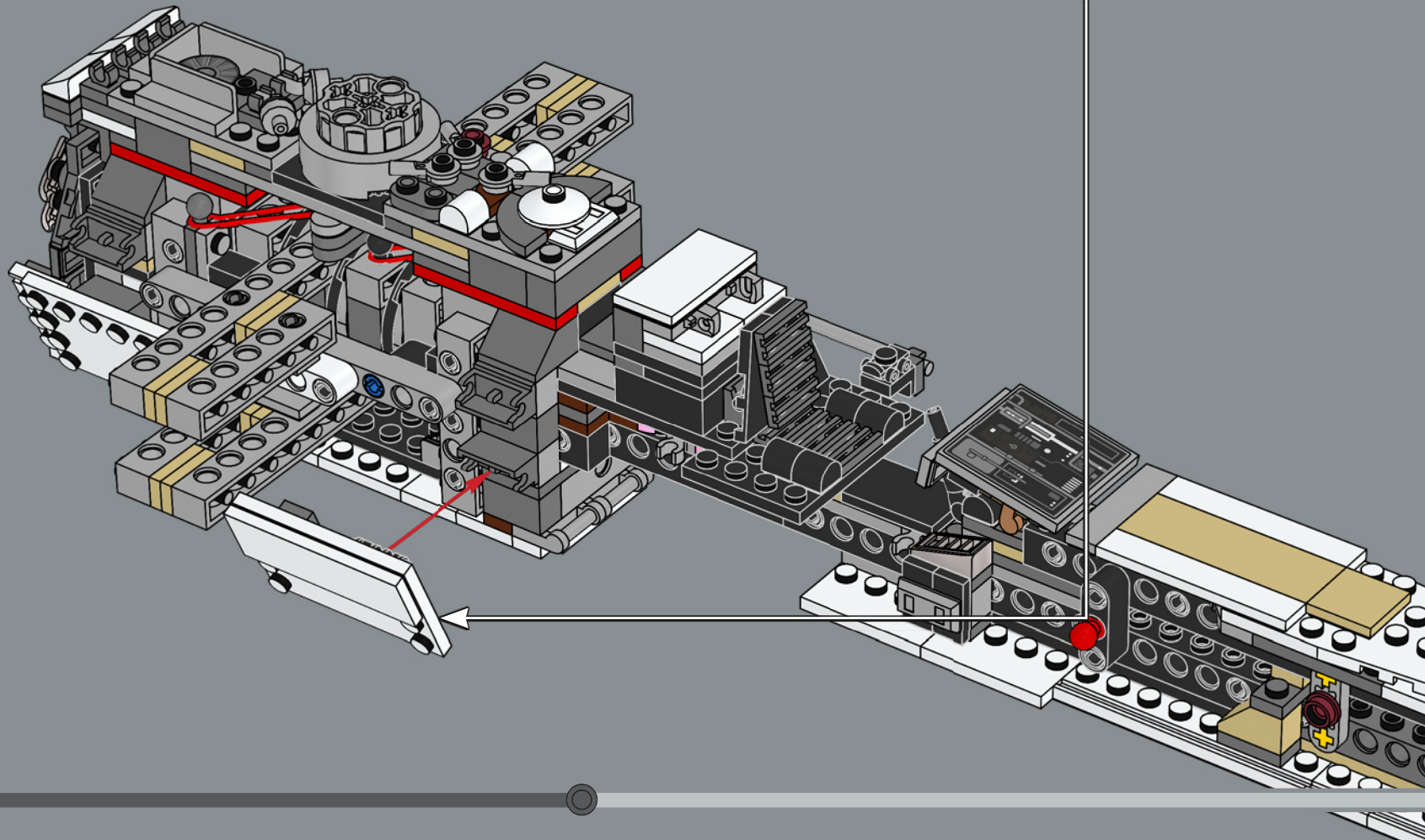
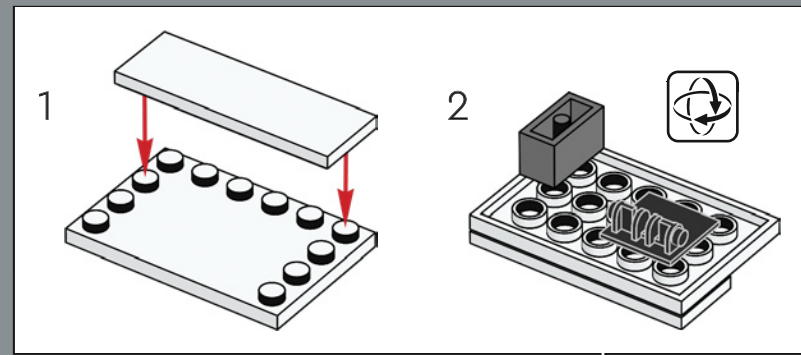

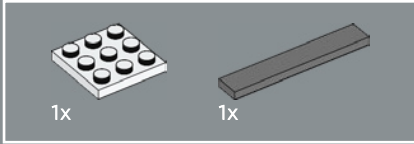
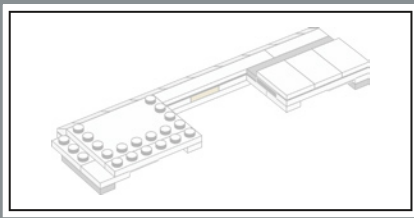

138

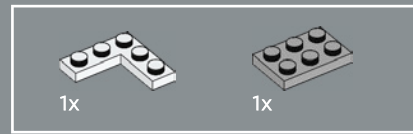
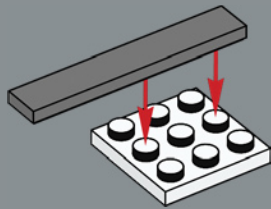

139

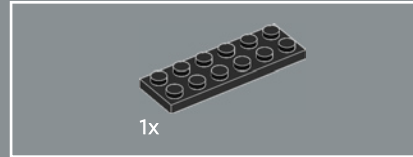
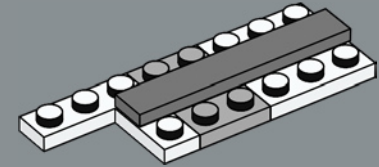

140

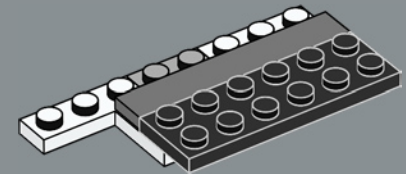



2x

141

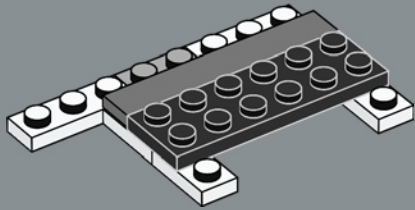

3x

143

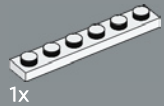
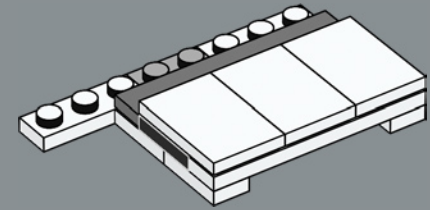

1x

142

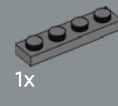
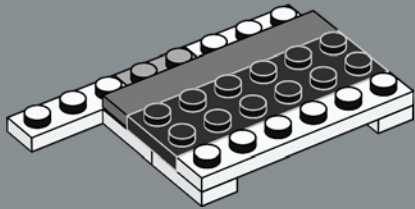

1x



1x

144

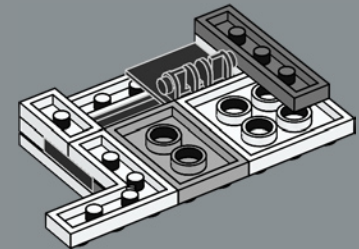

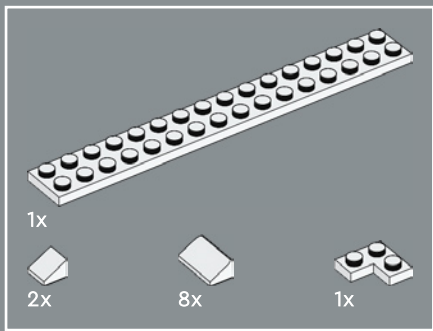

145

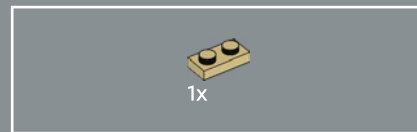
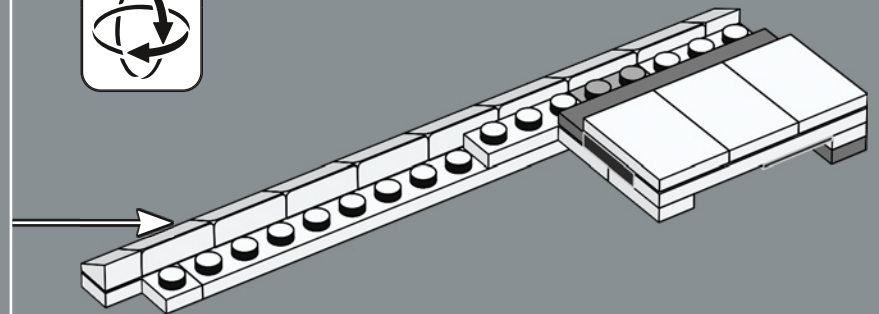
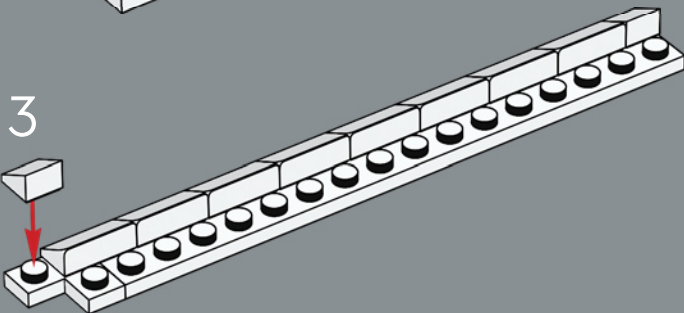
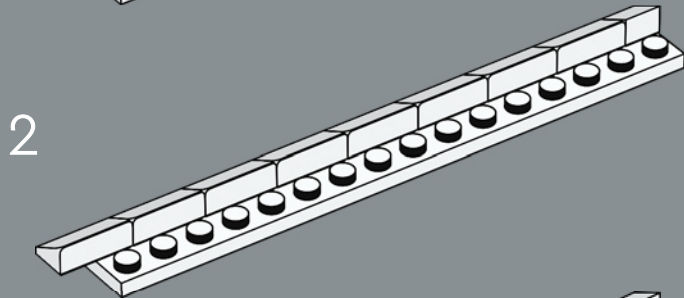
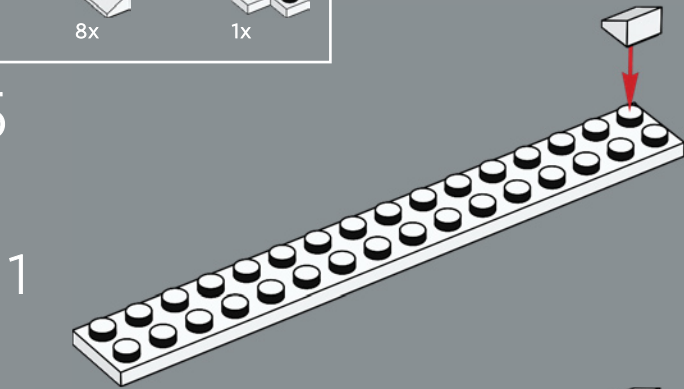

146

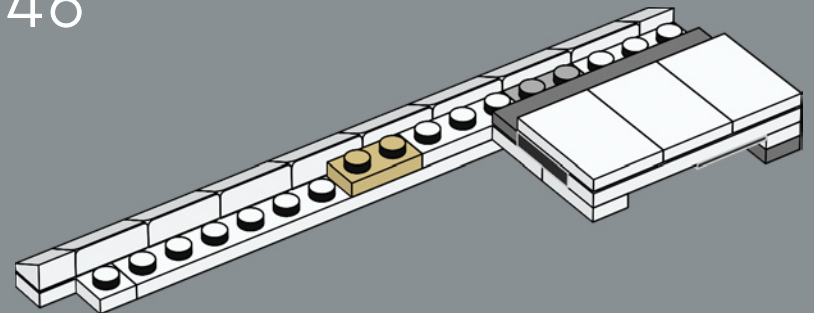

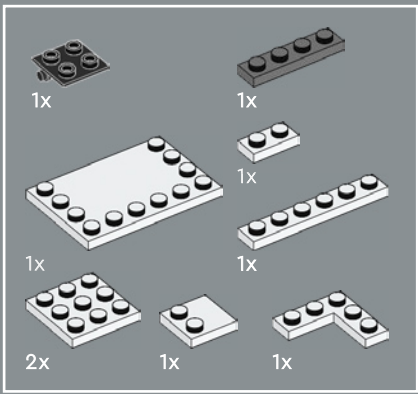

147

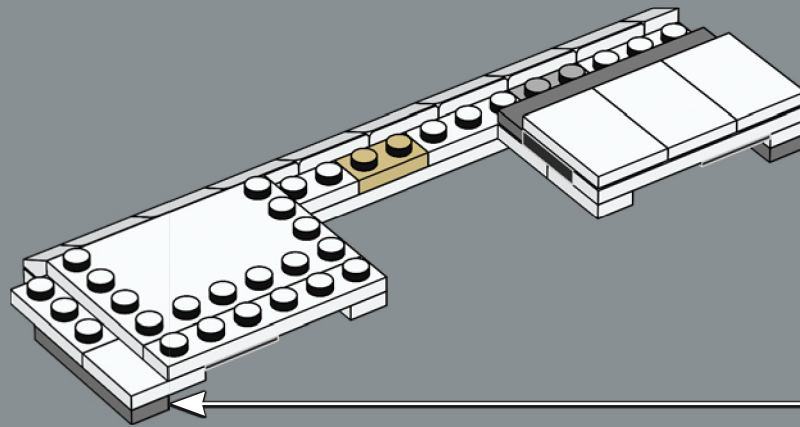
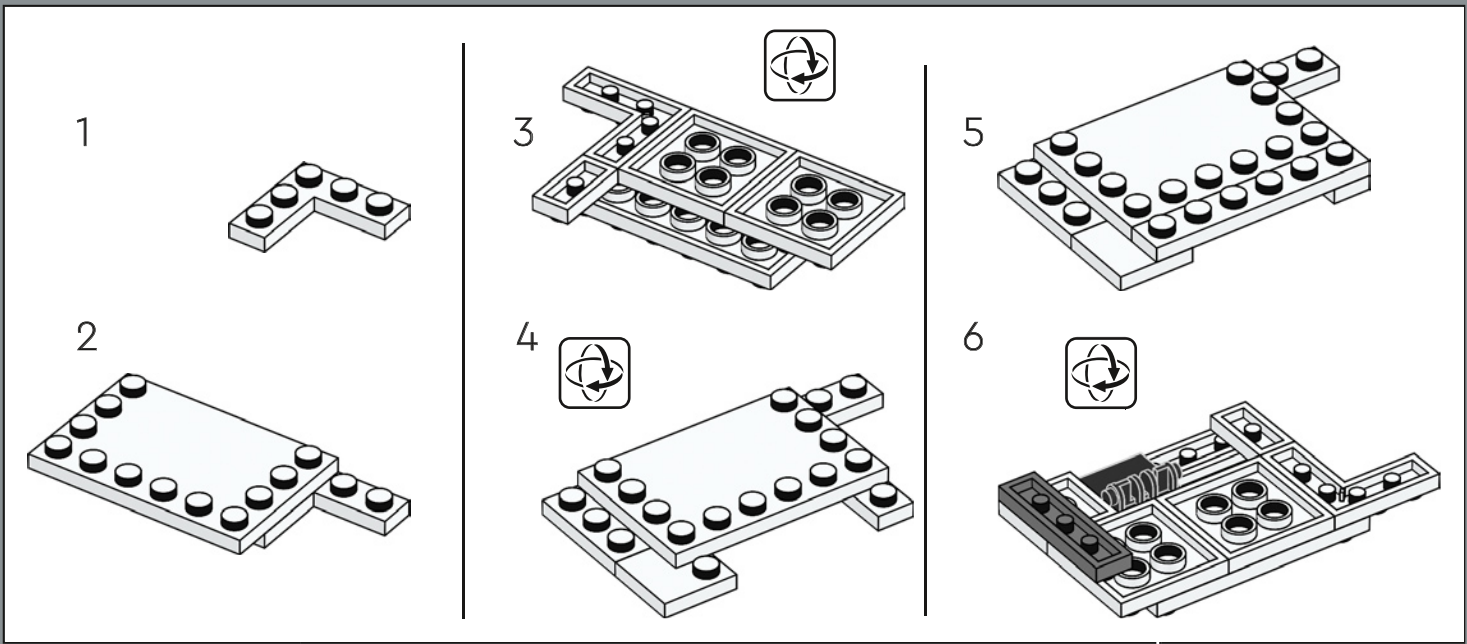

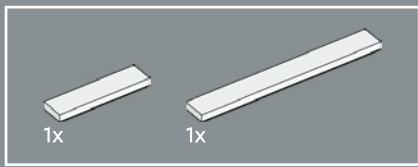

148

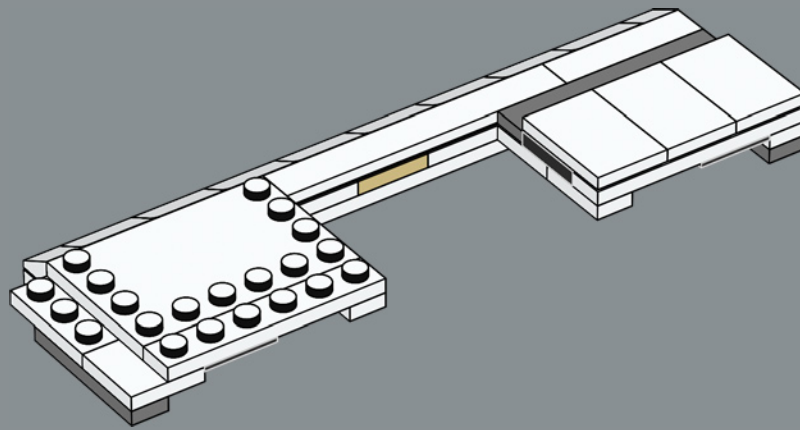

149

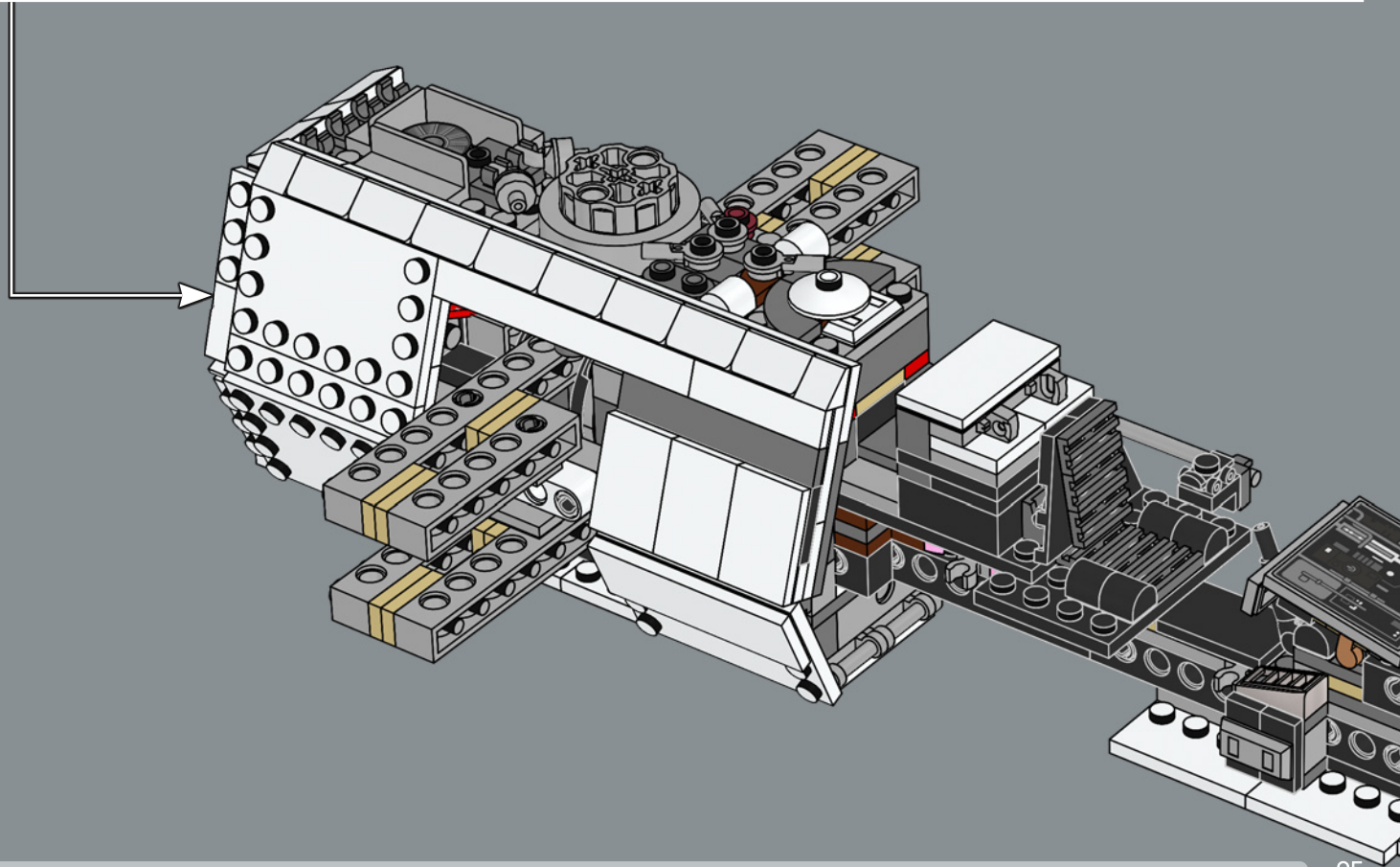

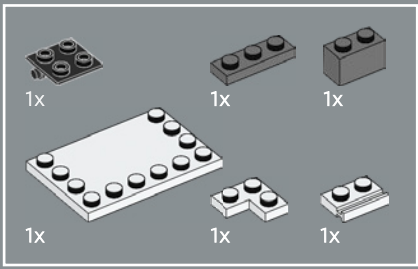

150

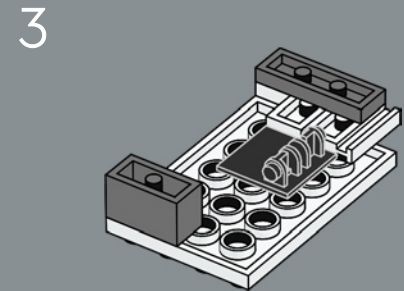
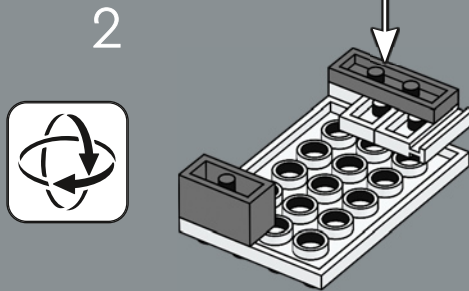
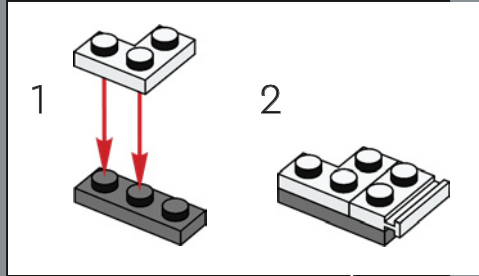
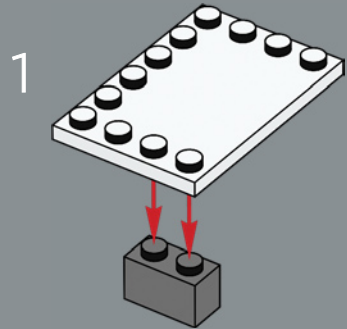

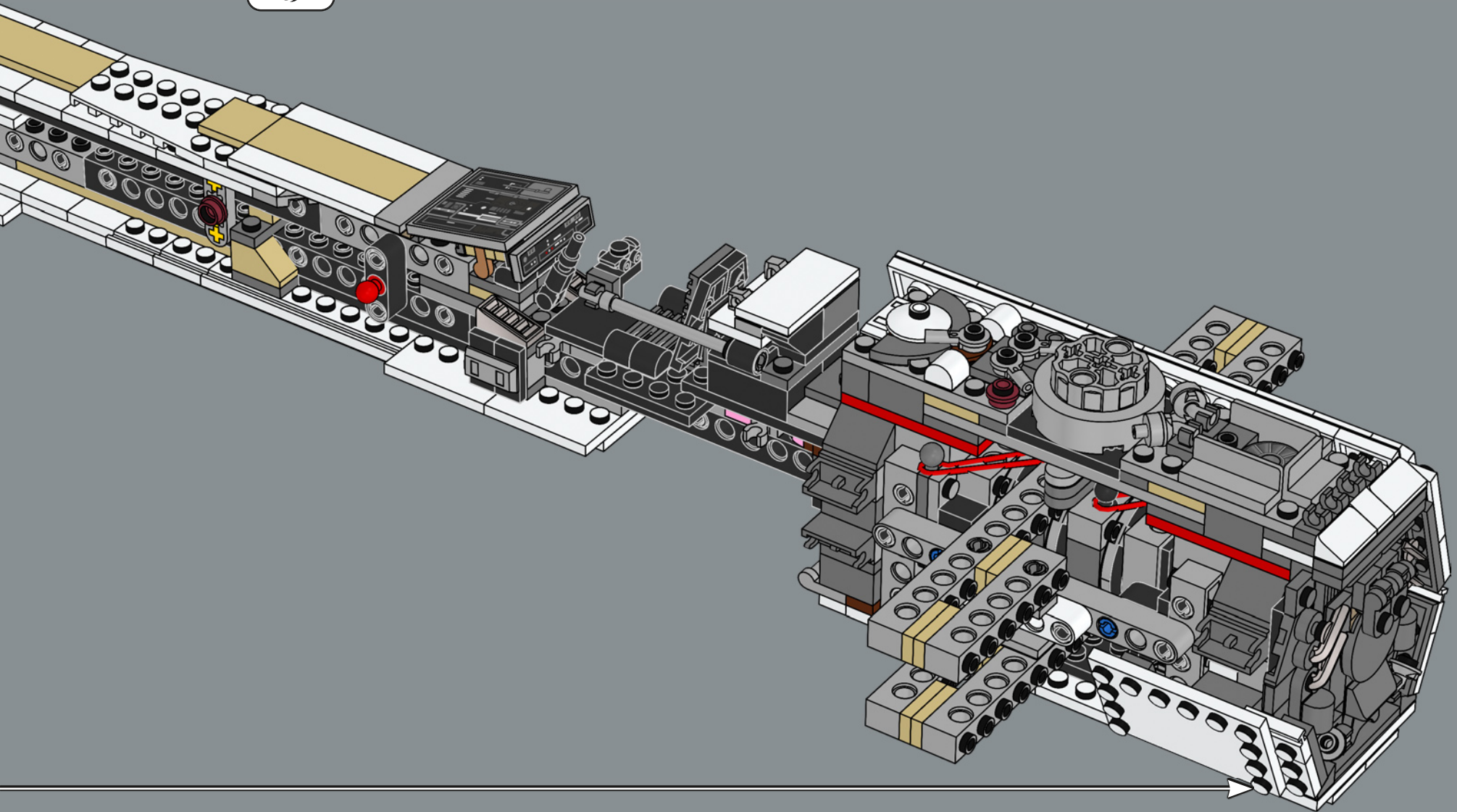

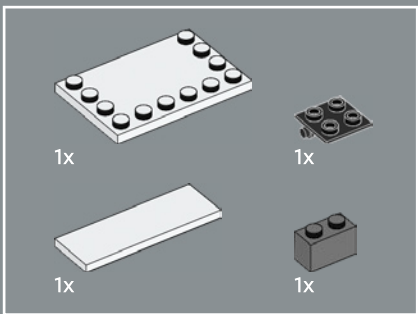

151

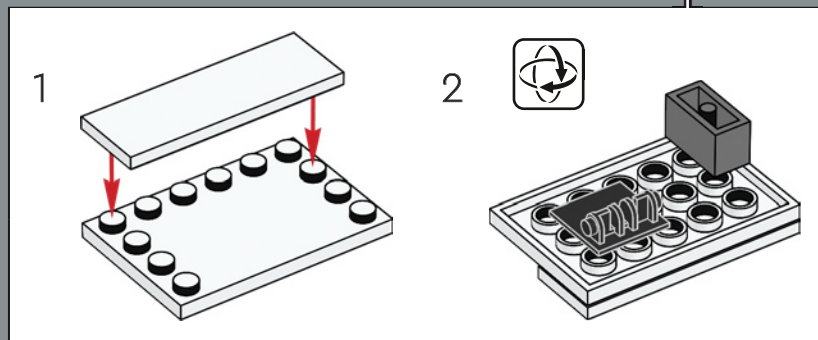
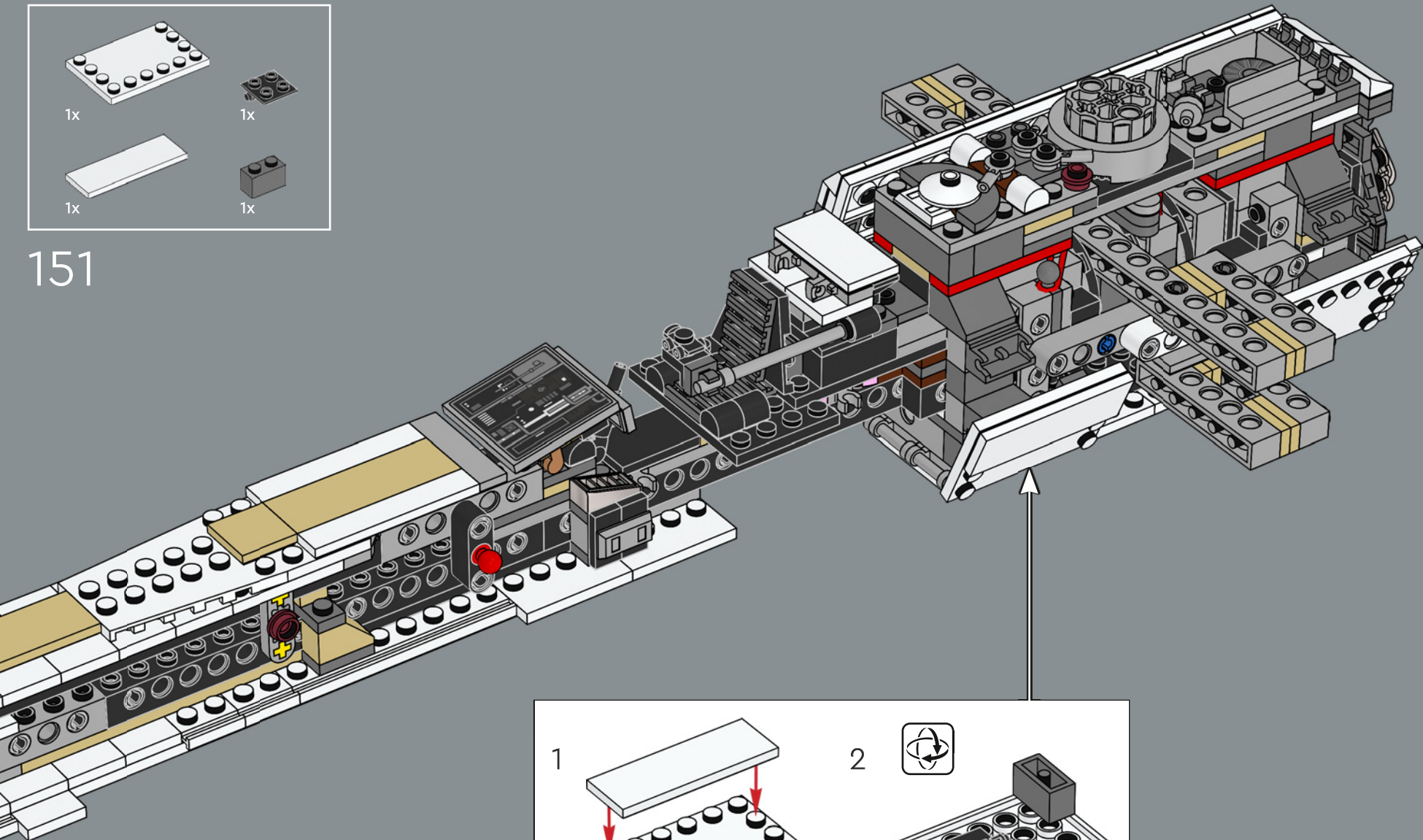

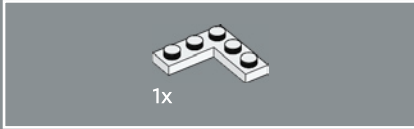
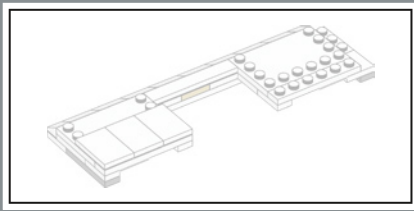

152

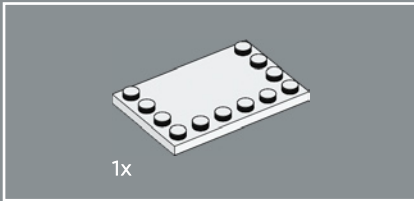

153

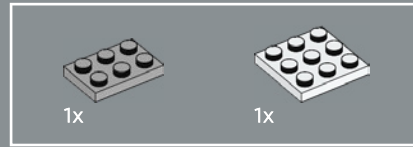
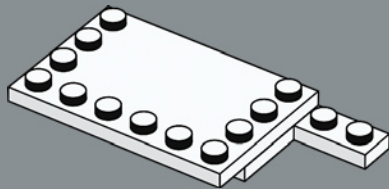

154

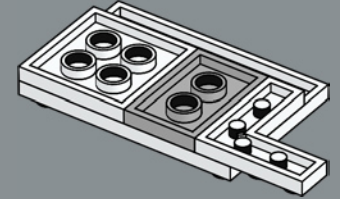

155

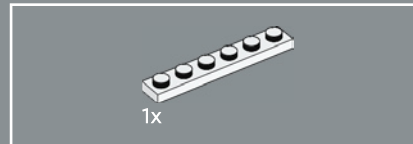
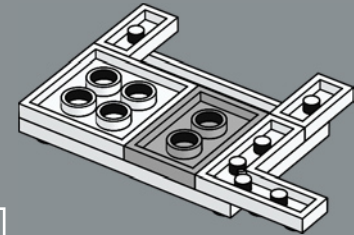

156

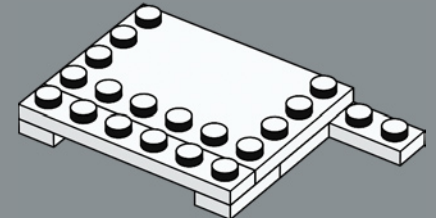

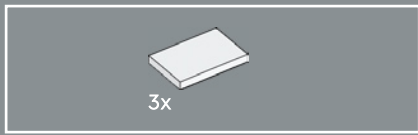

157

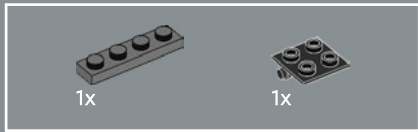
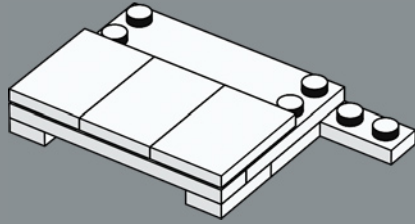

158

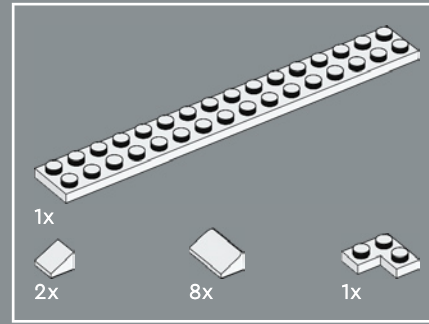
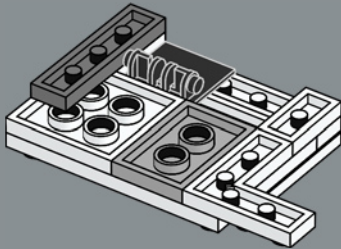

159

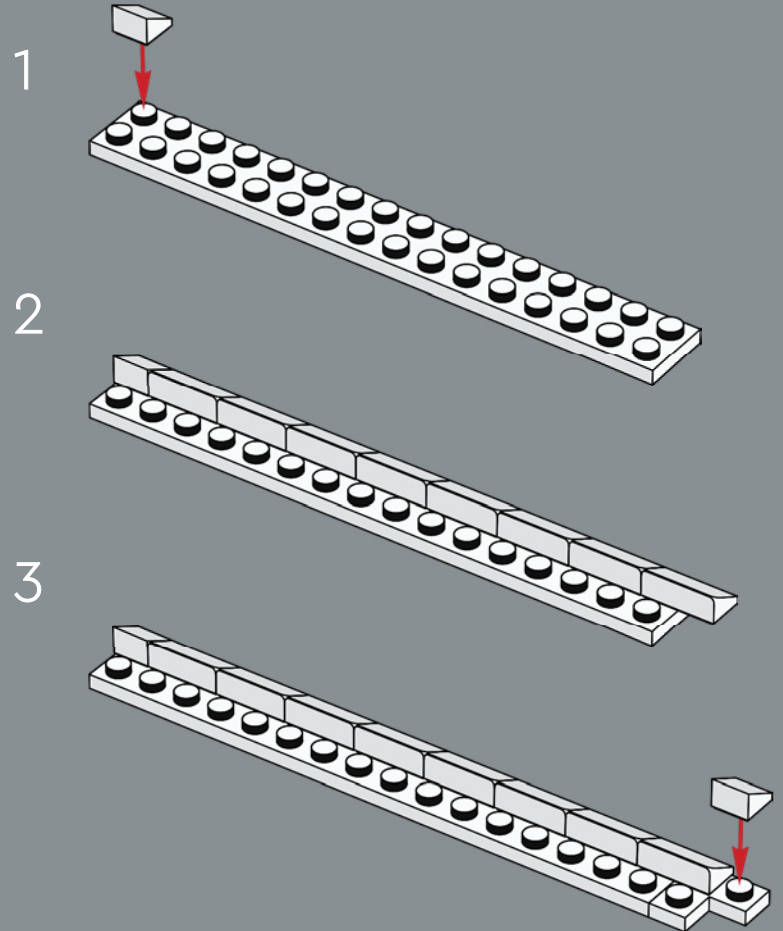

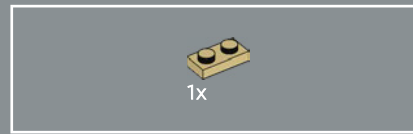
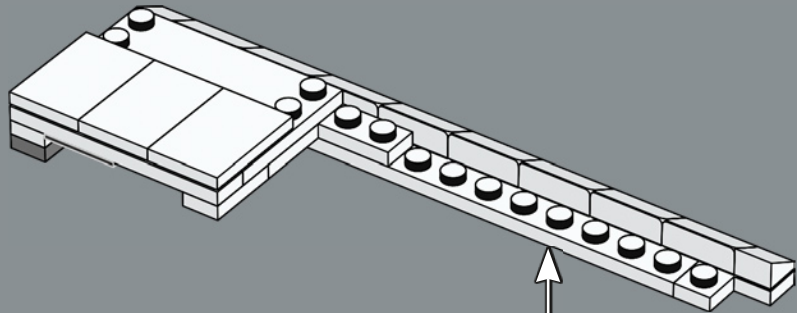

160

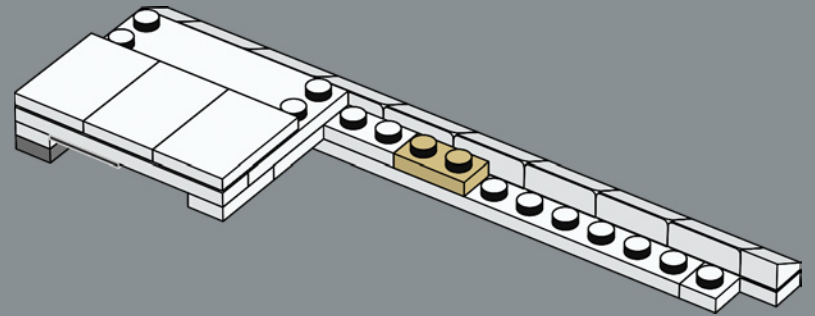

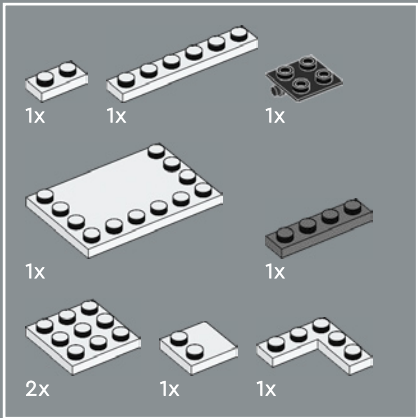

161

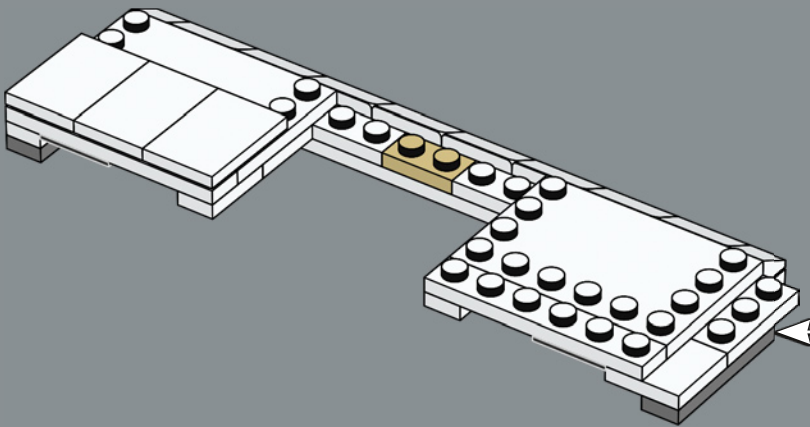
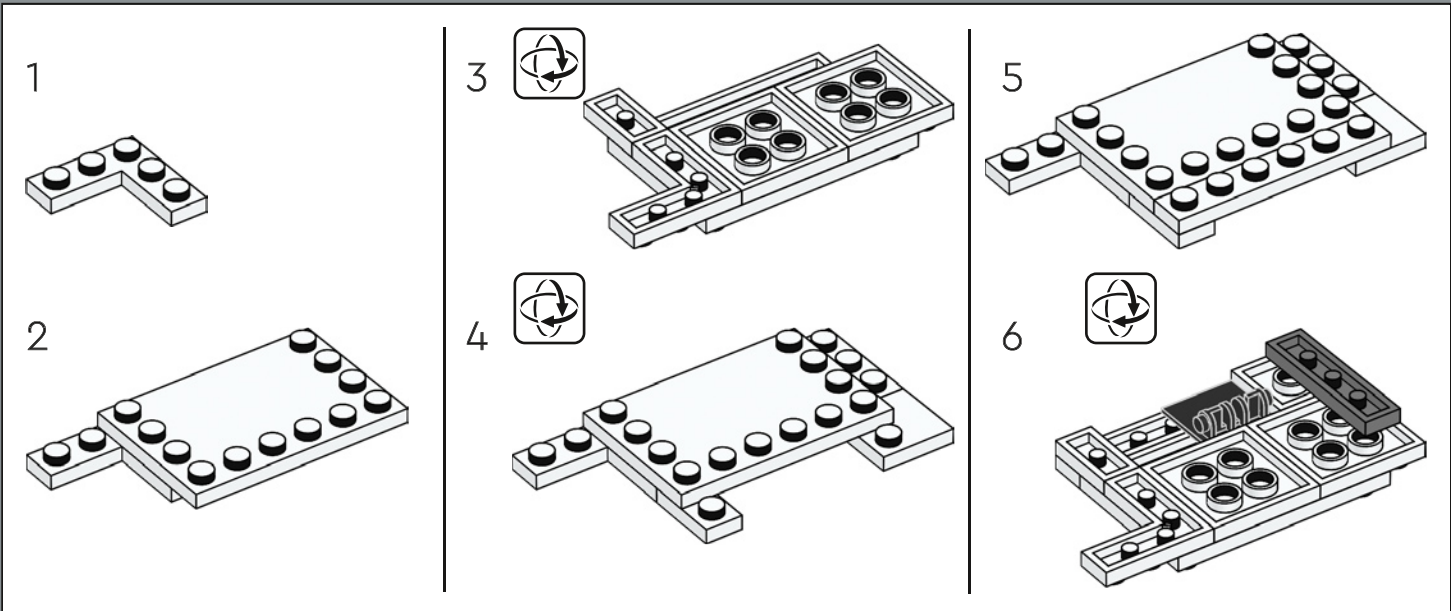

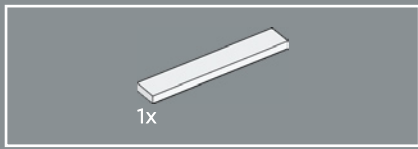

162

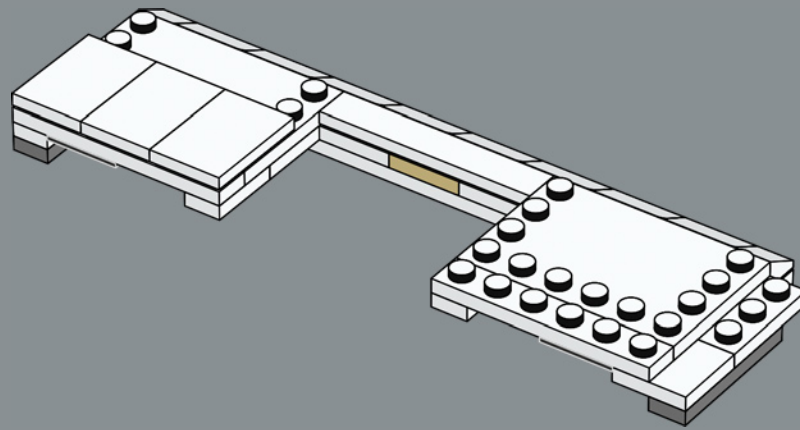

163

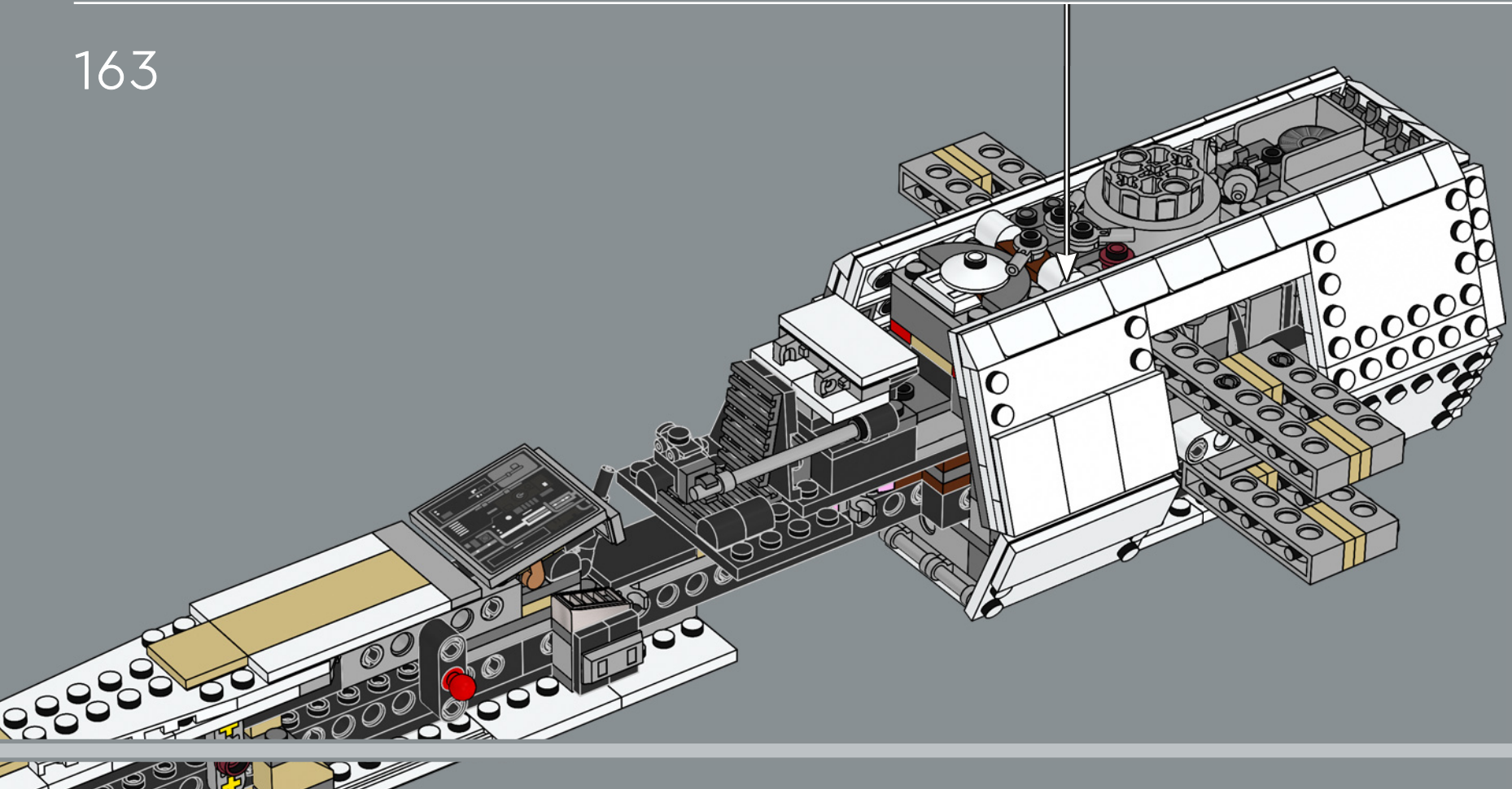

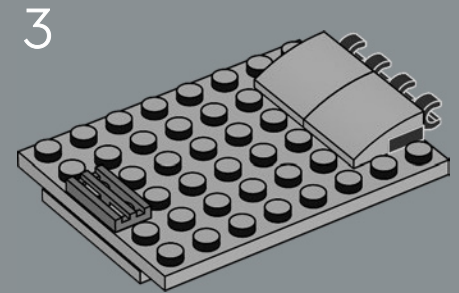
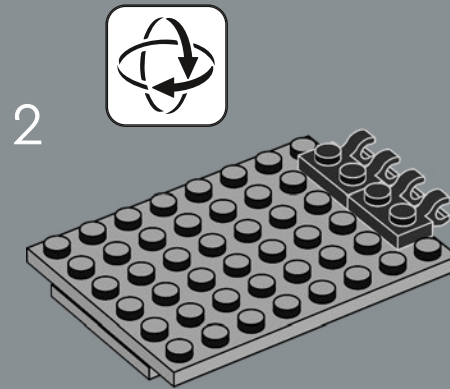
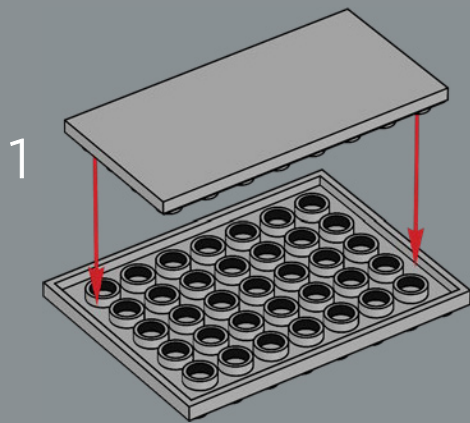
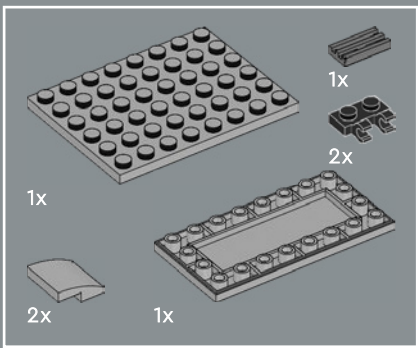

164

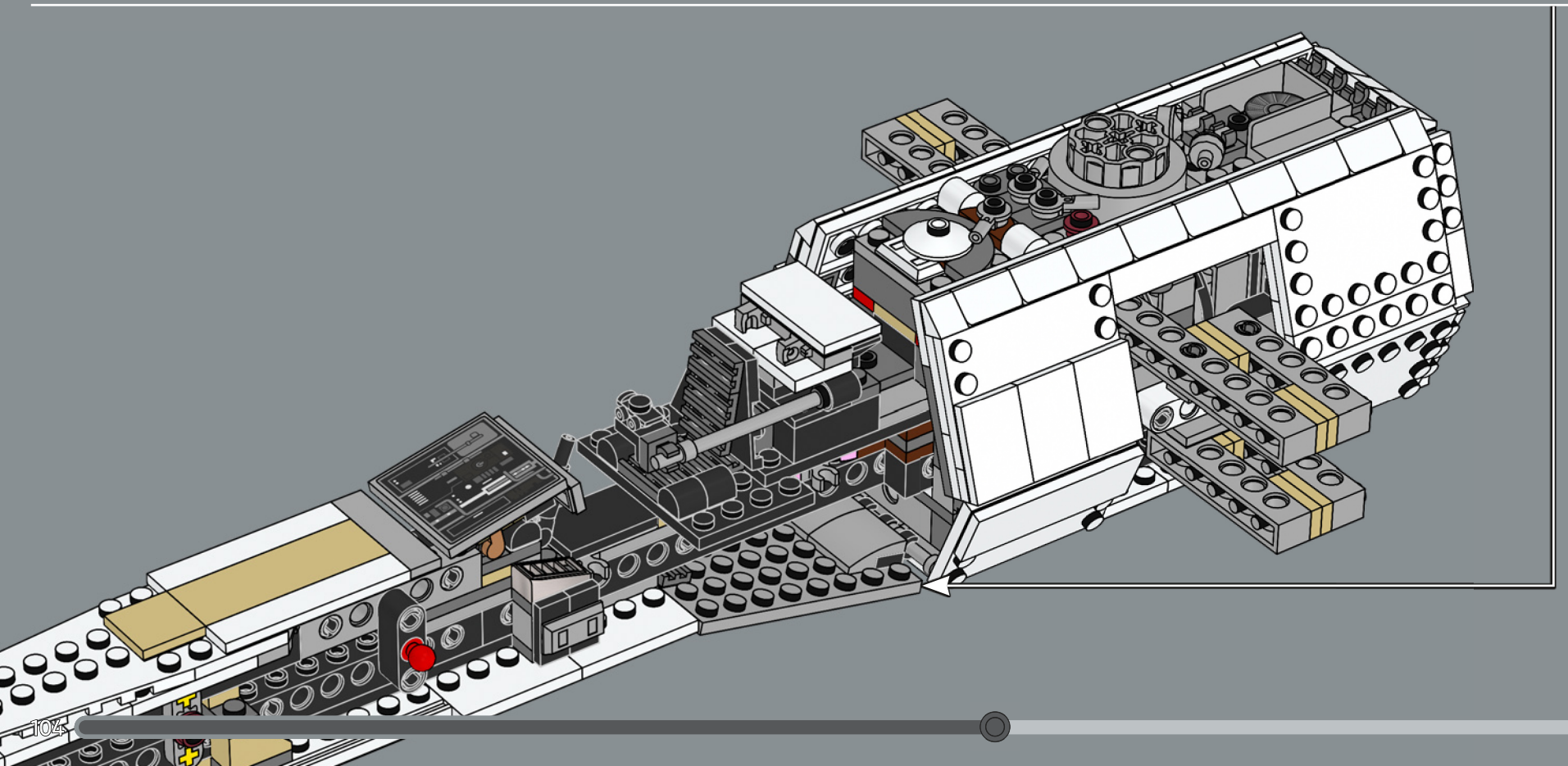

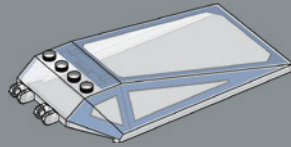
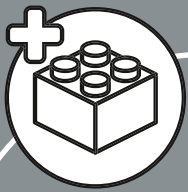

1x

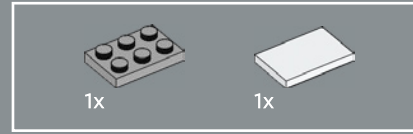
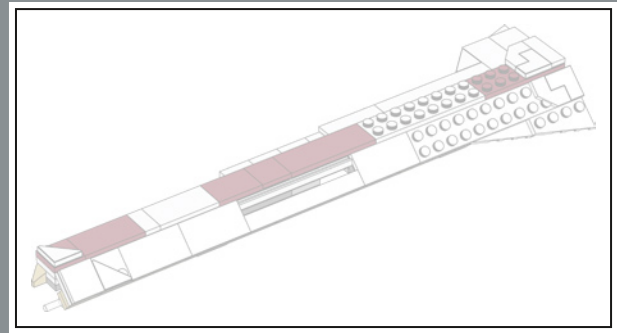

1x

1x

165

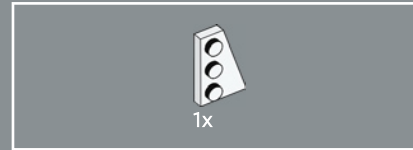
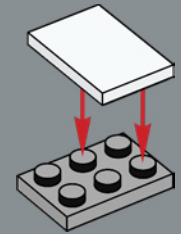

1x

166

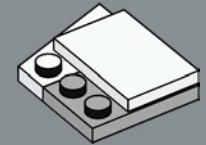

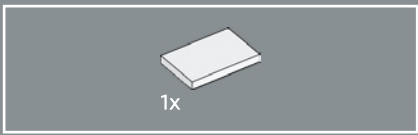

167

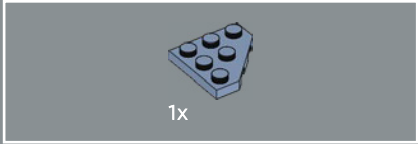
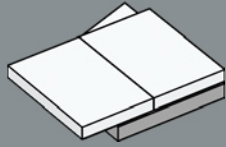

168

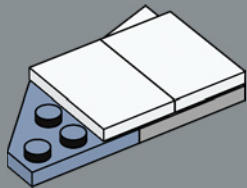

169

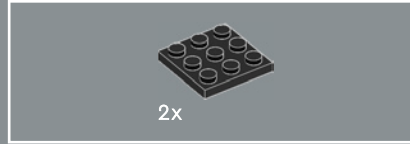
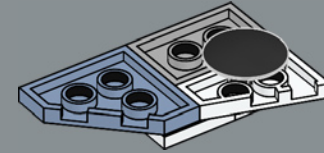

170

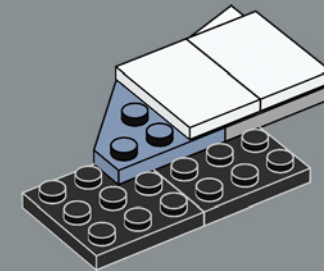

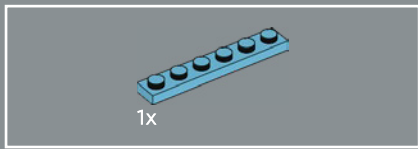

171

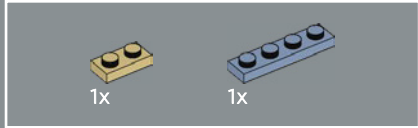
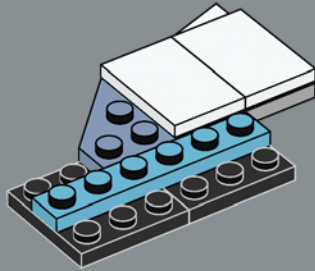

172

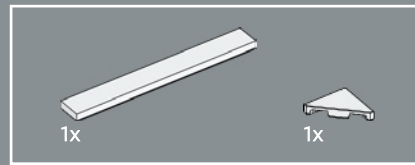
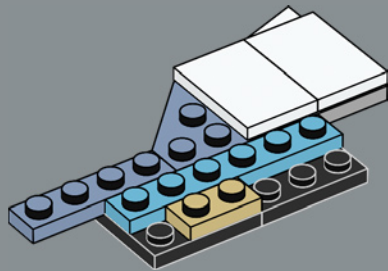

173

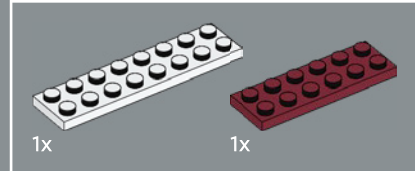
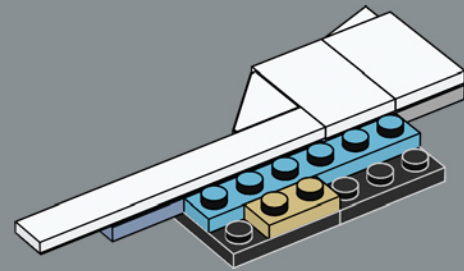

174

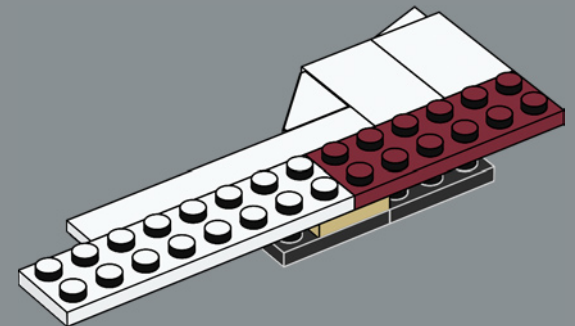



175

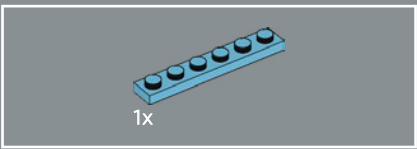
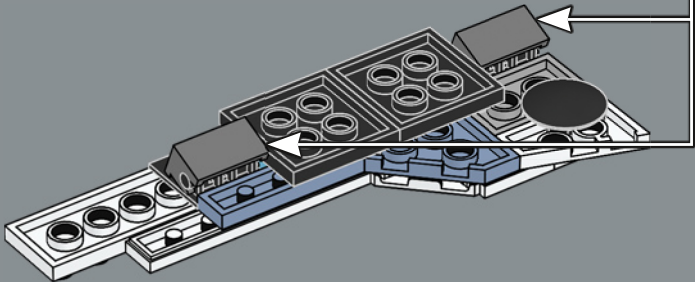
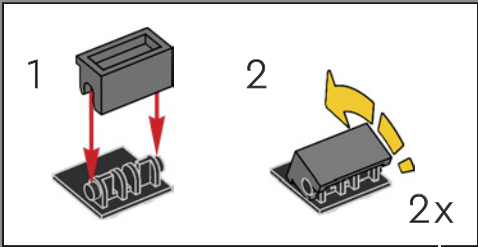

176

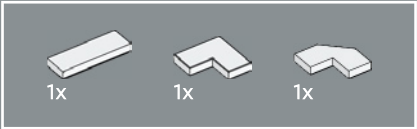
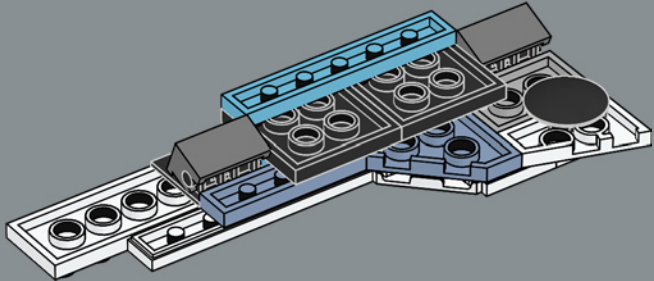

177

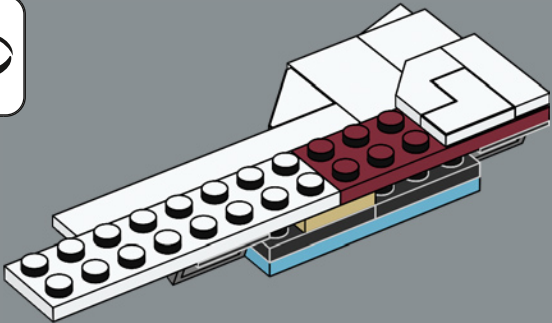

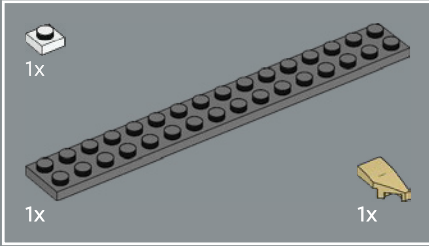
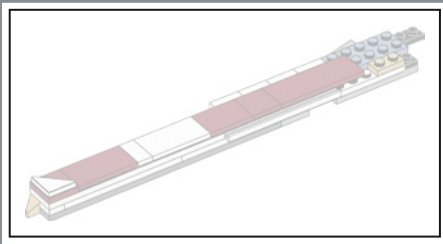

178

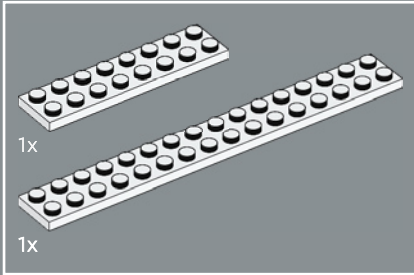
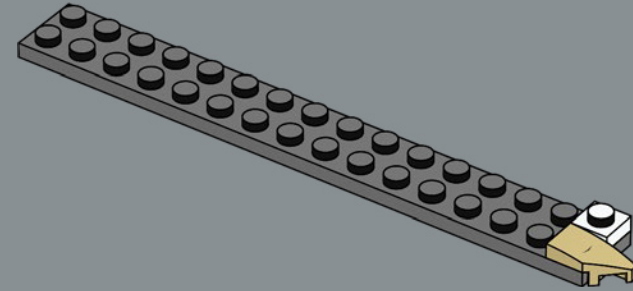

179

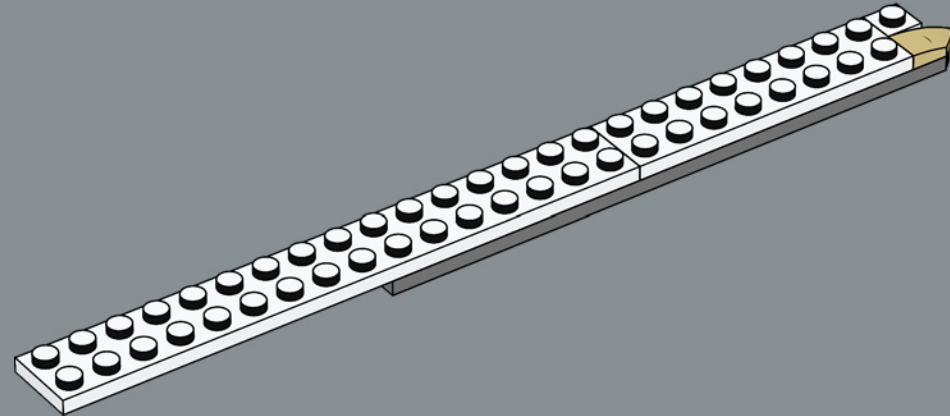

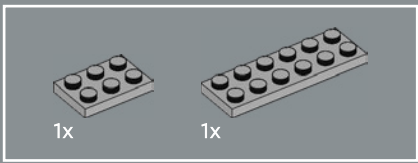

180

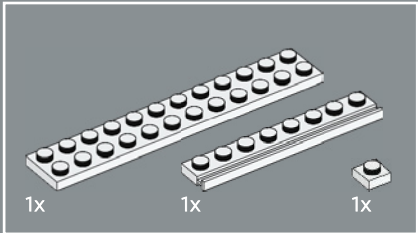
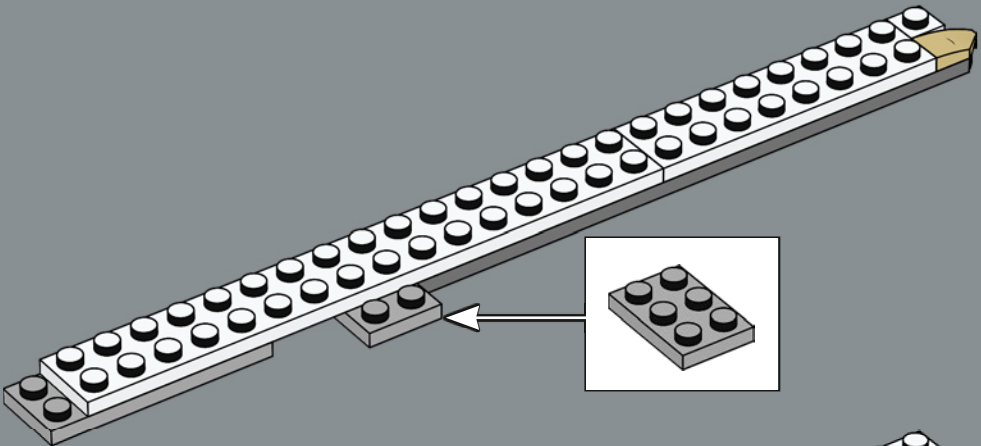

181

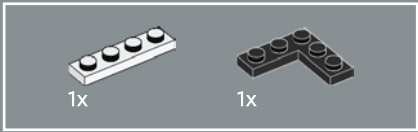
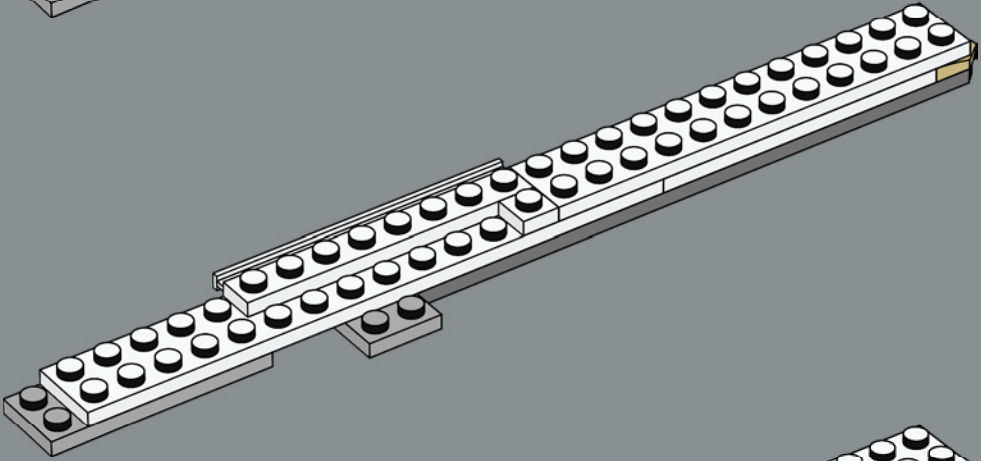

182

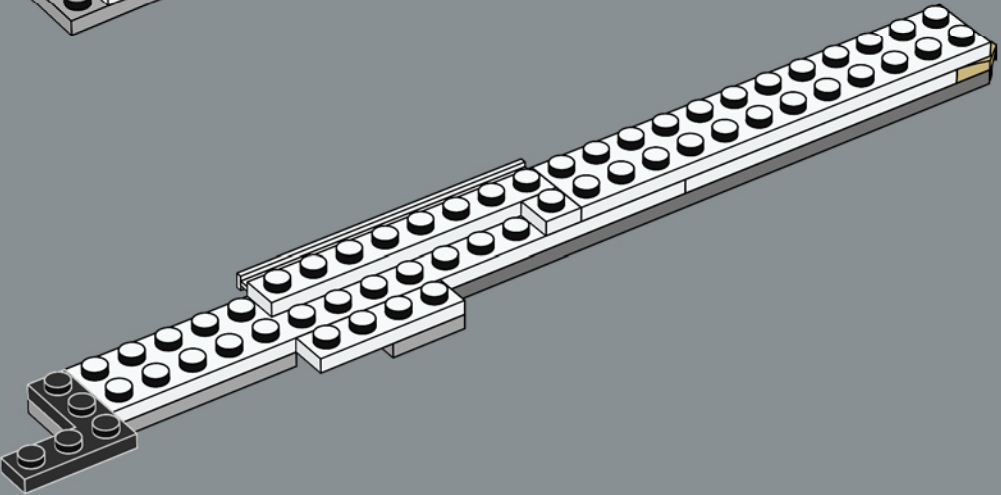

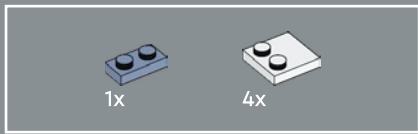

183

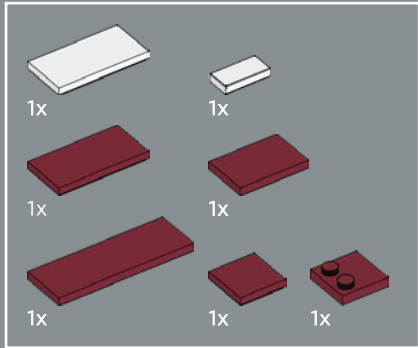
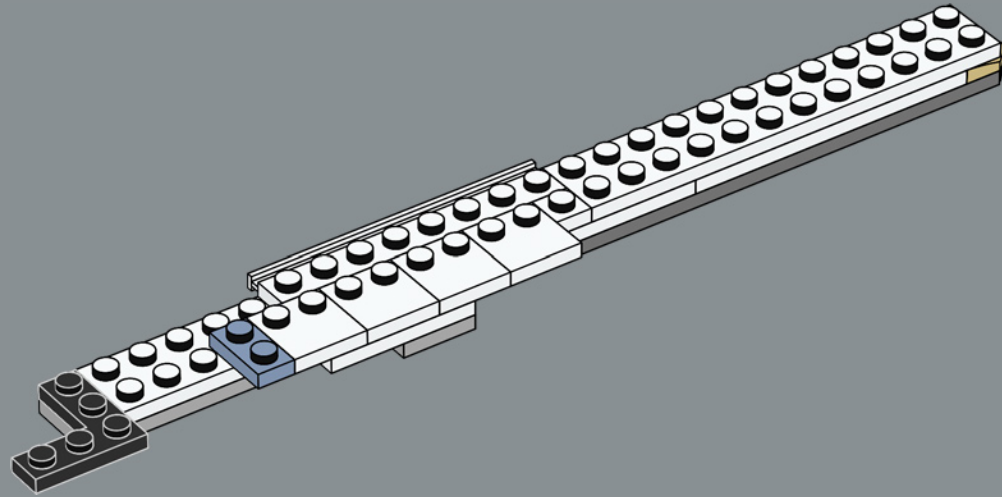

184

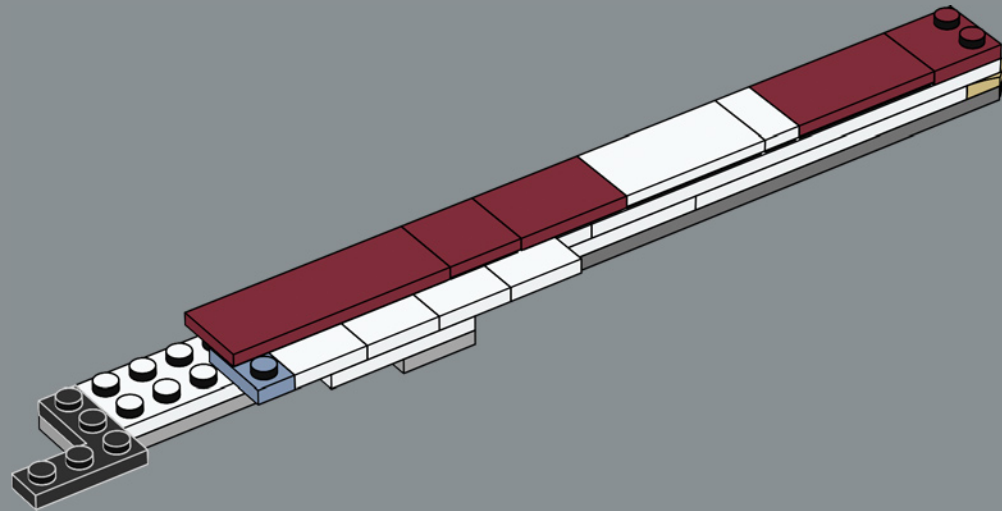

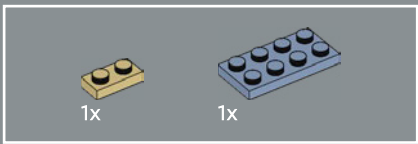

185

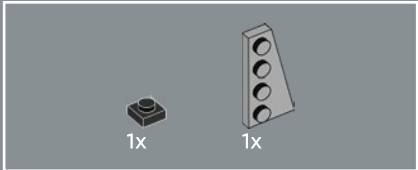
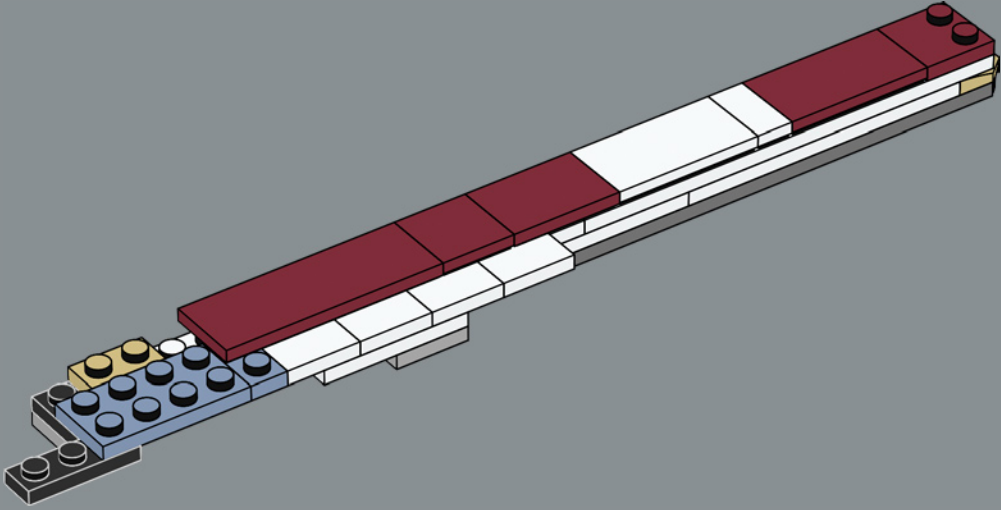

186

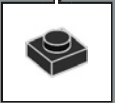
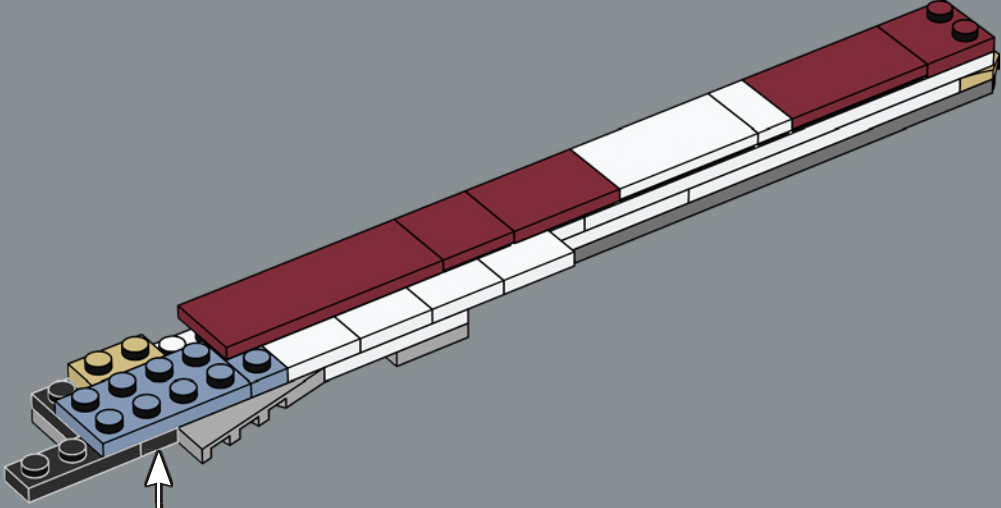



187

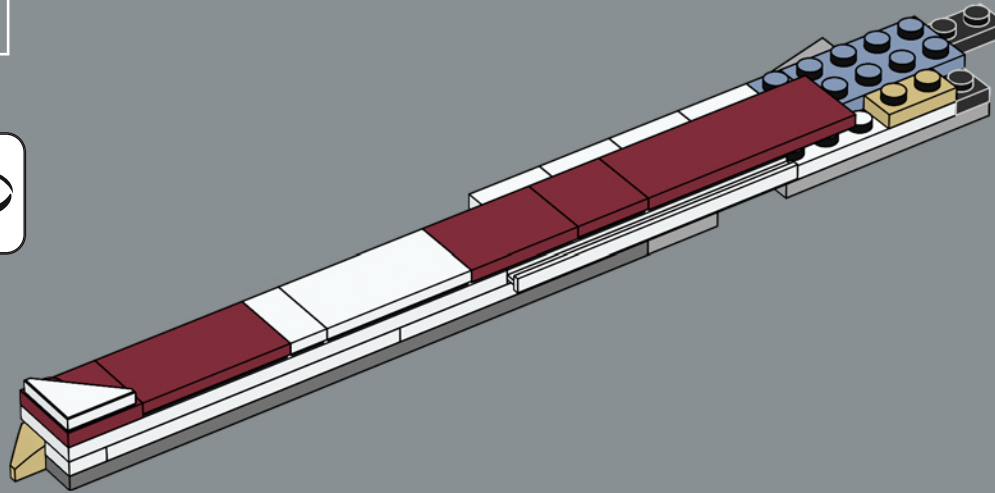

188

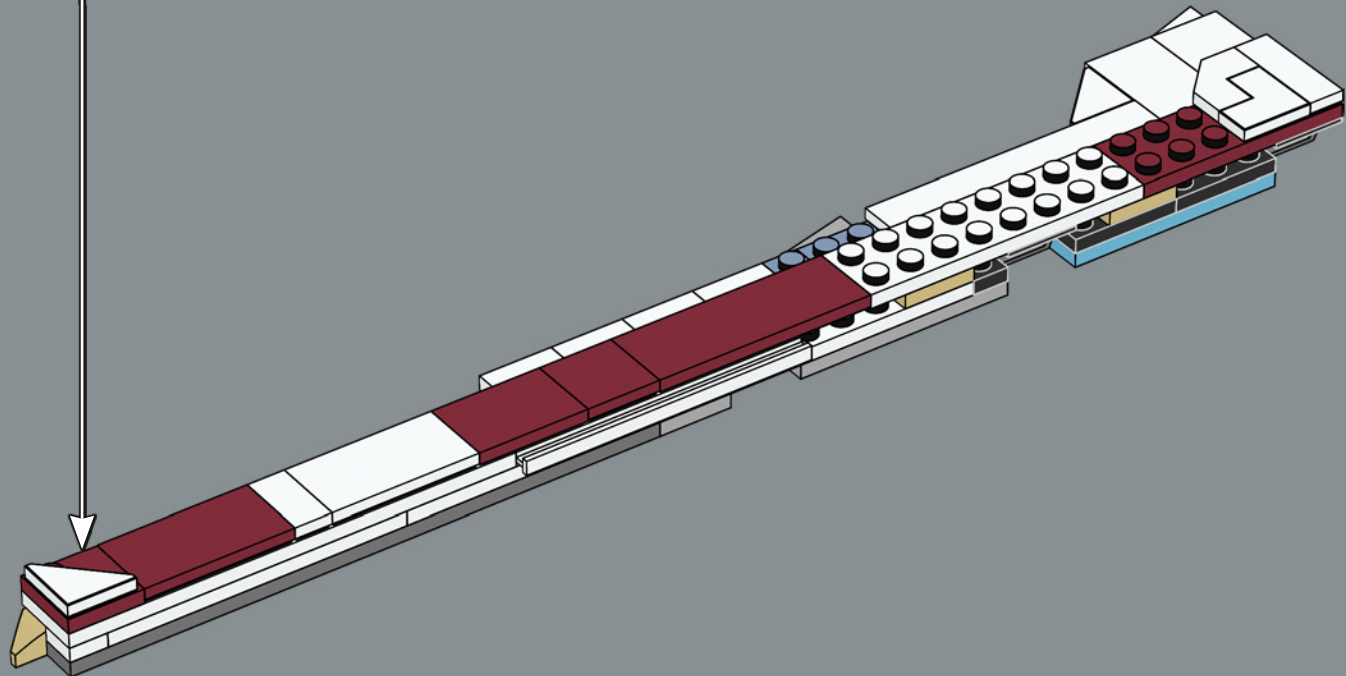

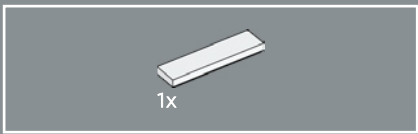

189

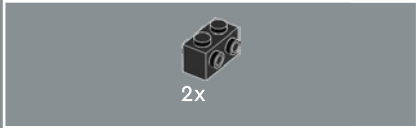
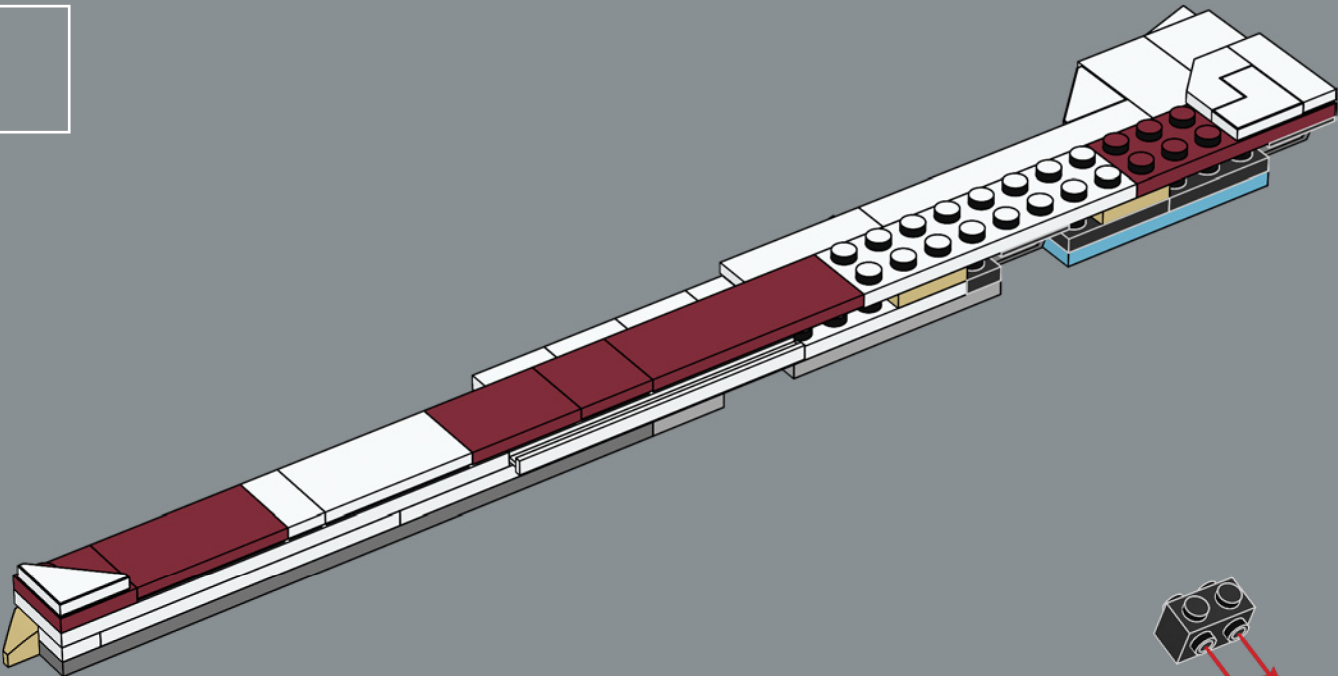

190

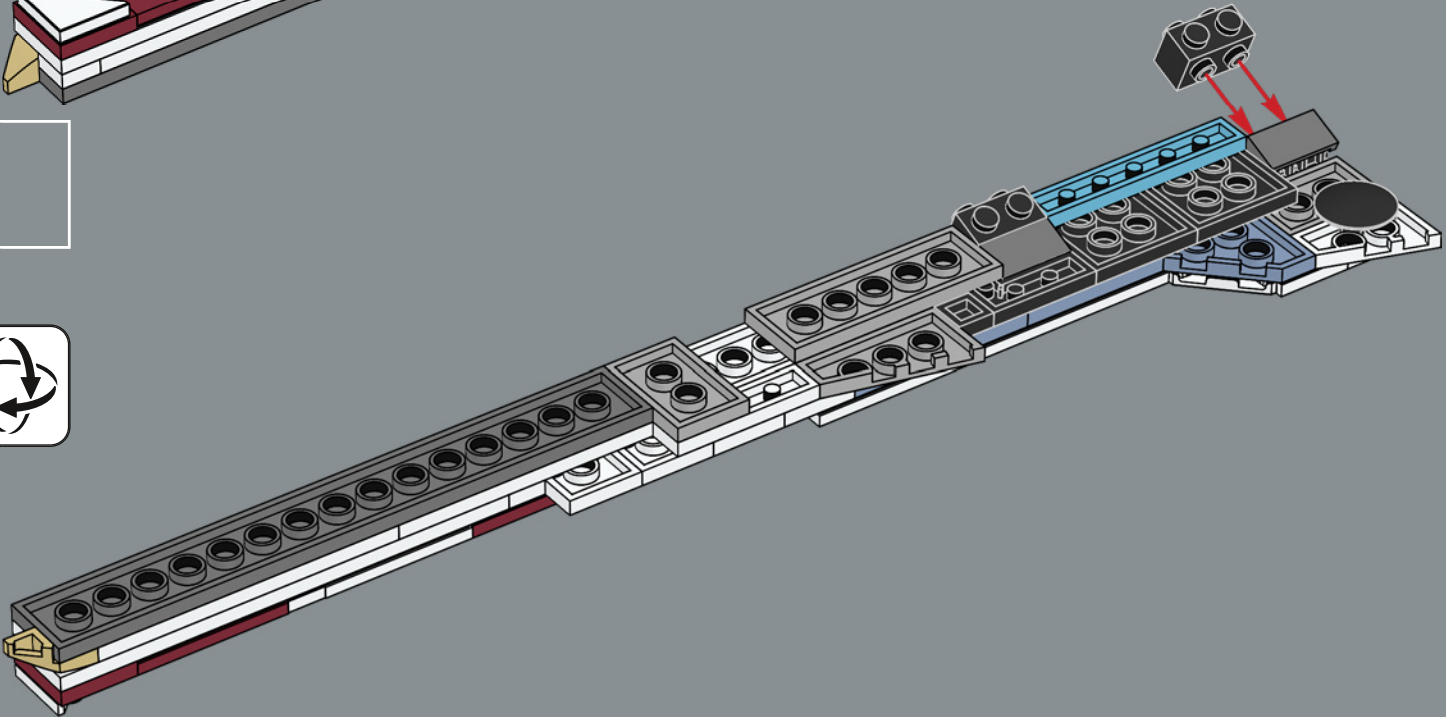

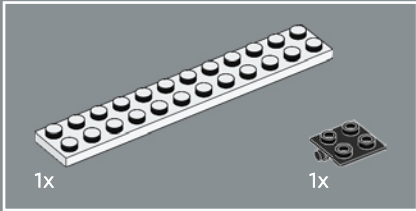
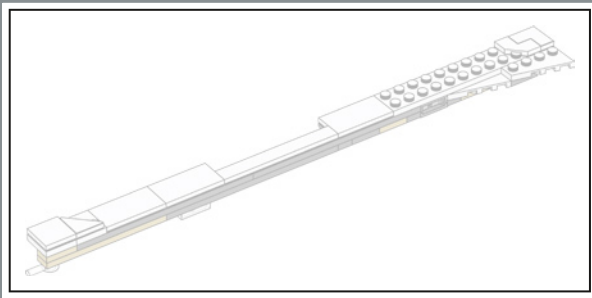

191

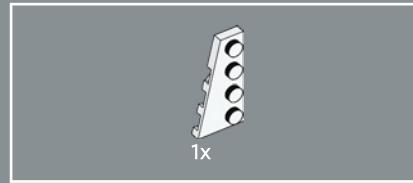
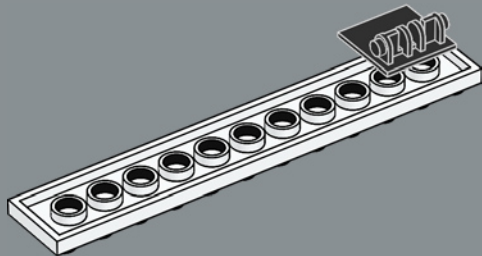

192

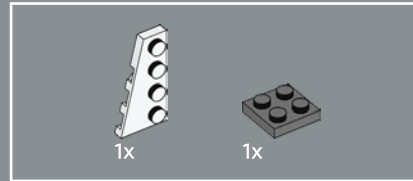
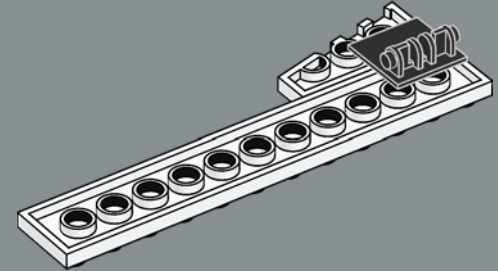

193

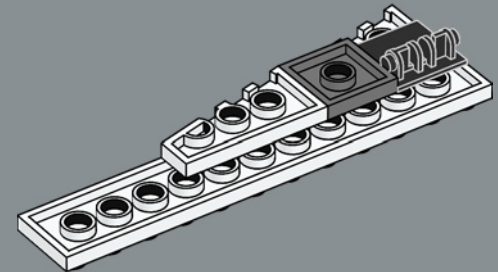

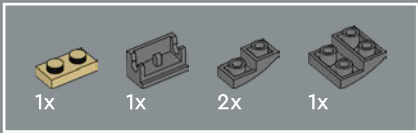

194

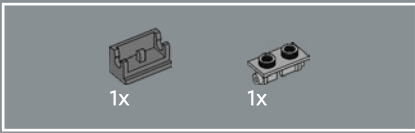
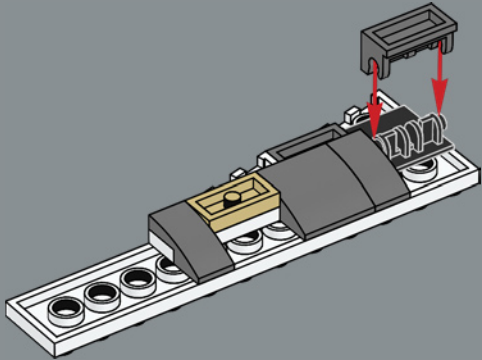

195

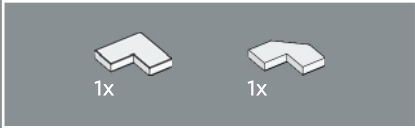
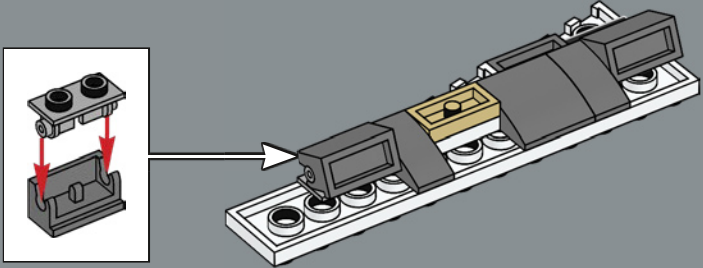

196

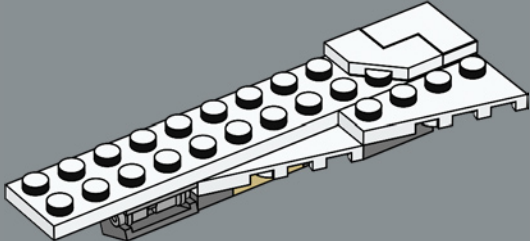

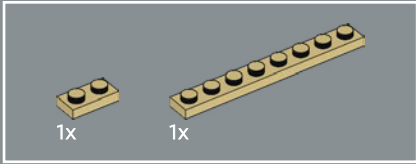
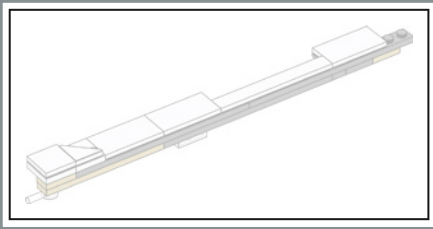

197

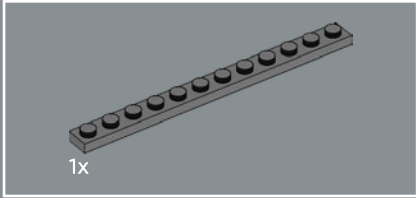
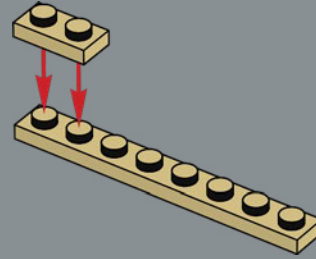

198

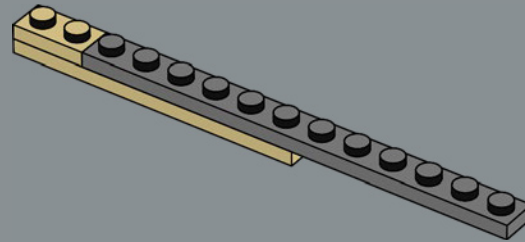

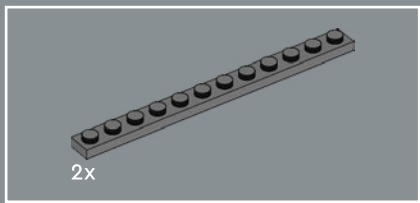

199

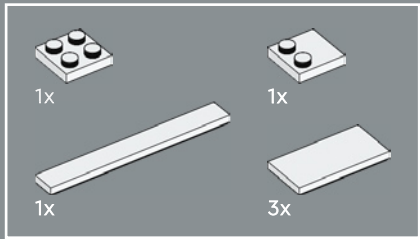

200

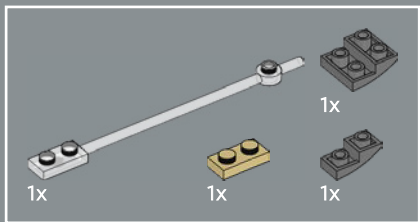

201

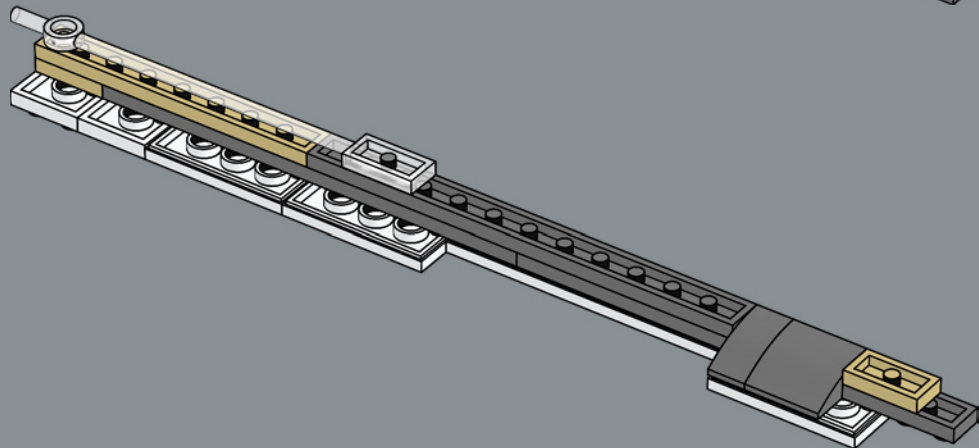
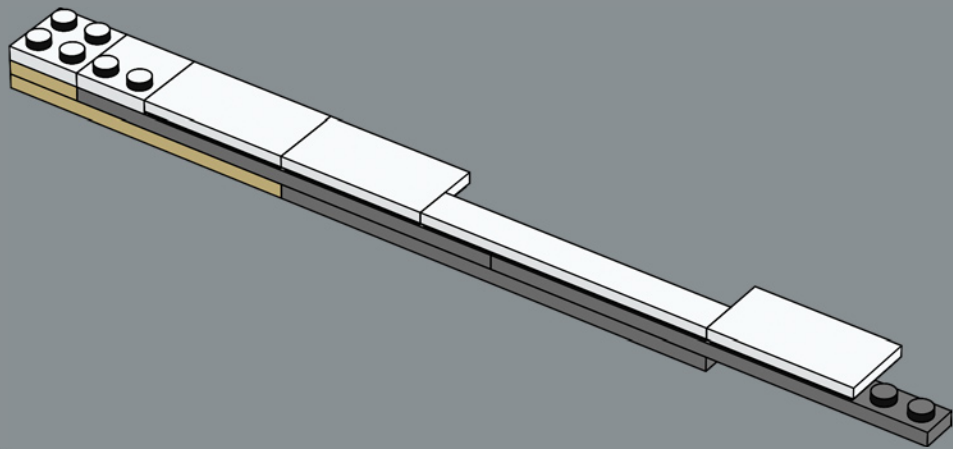
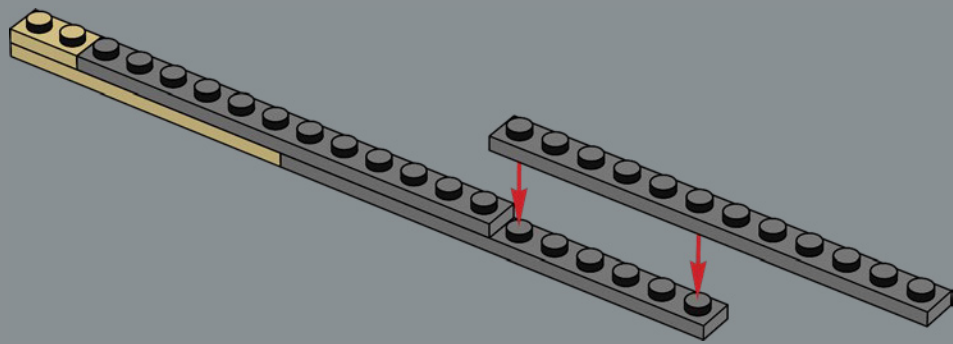

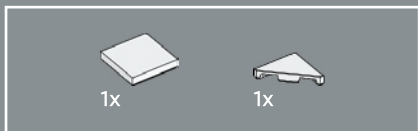

202

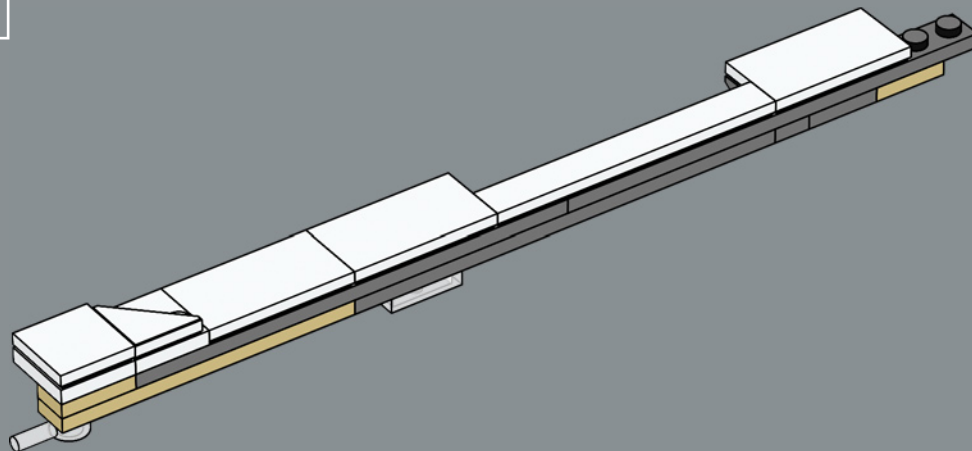

203

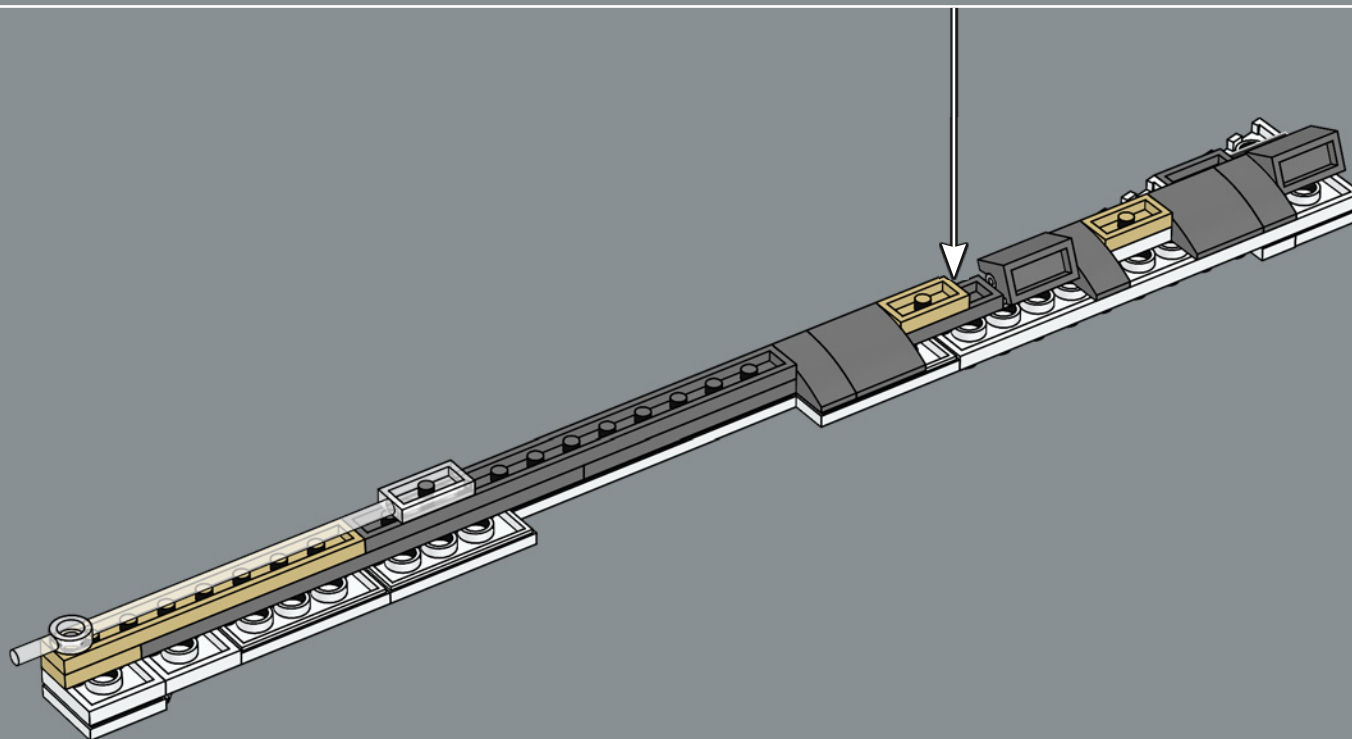



1x

204

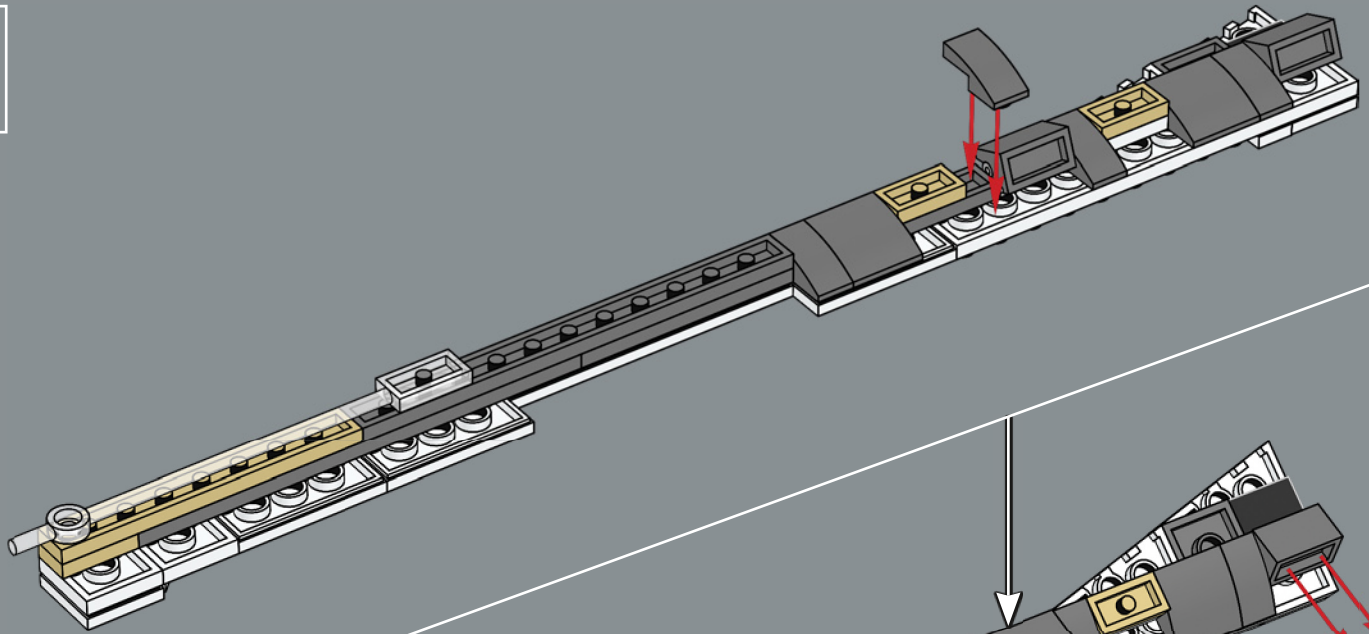

205

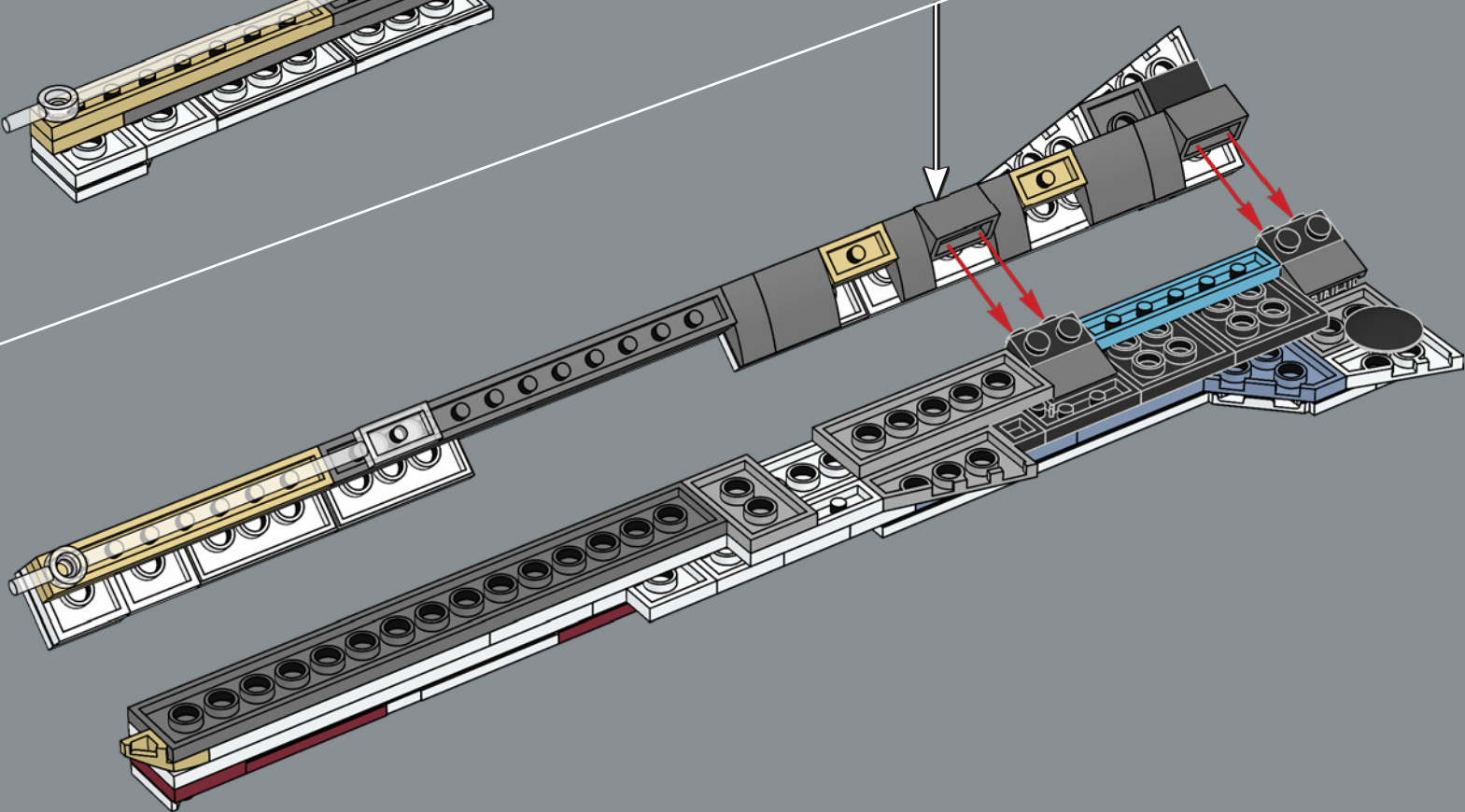

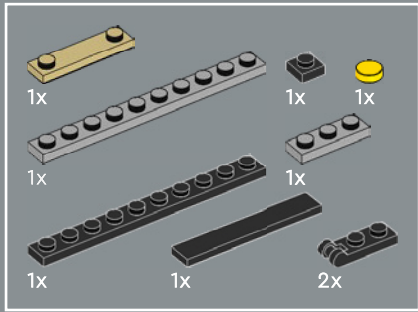

206

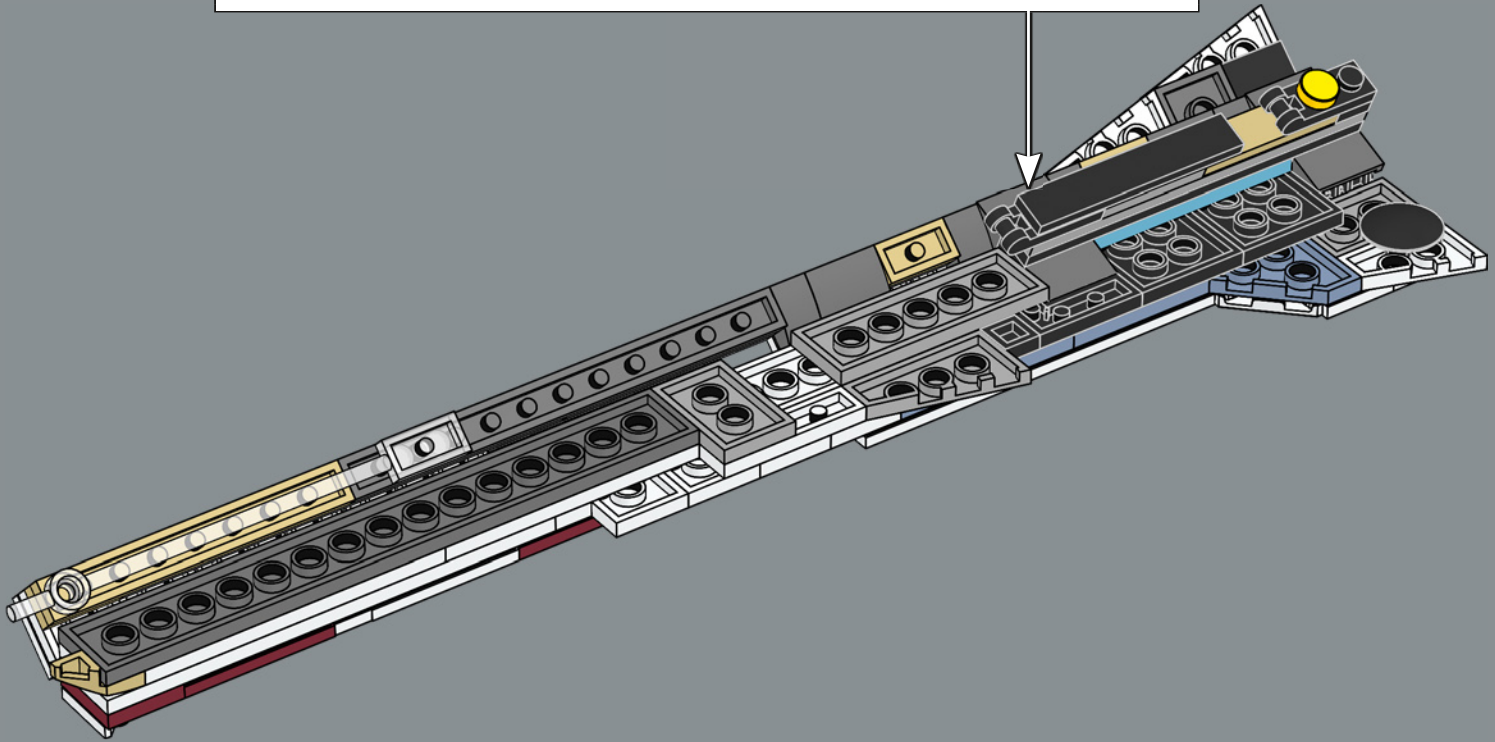
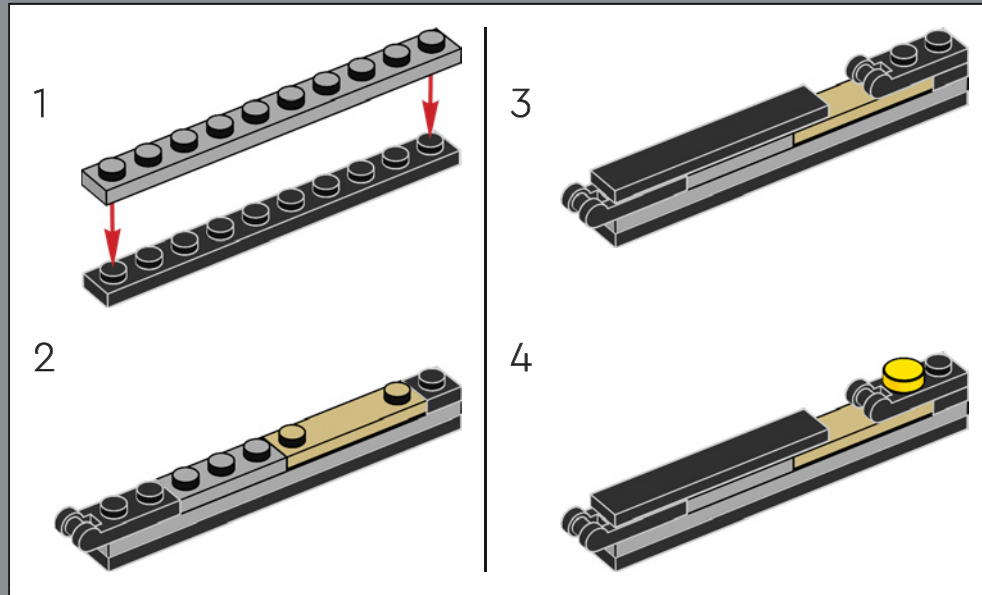

207

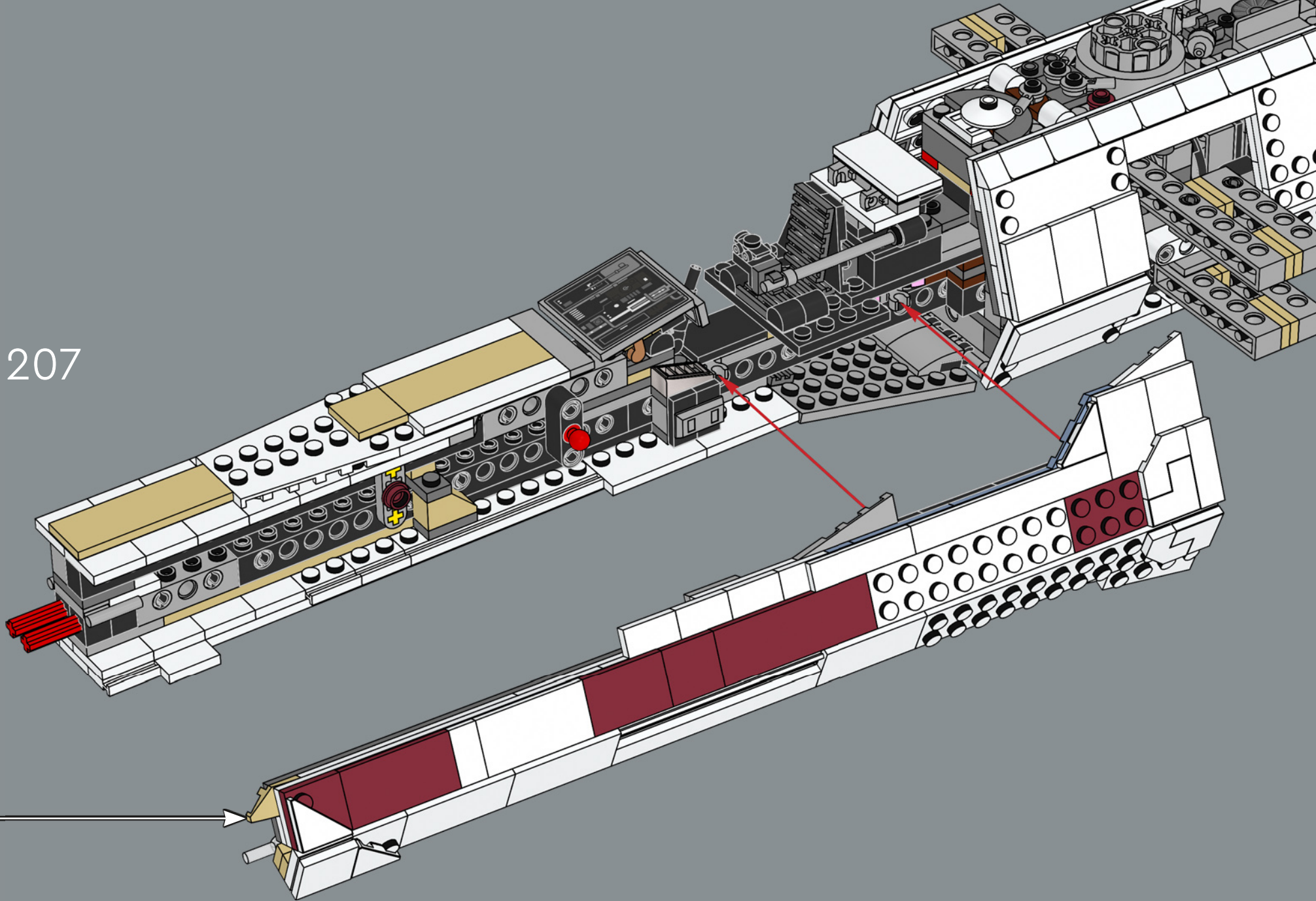

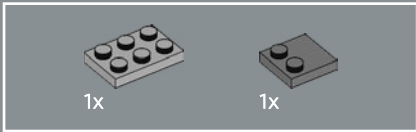
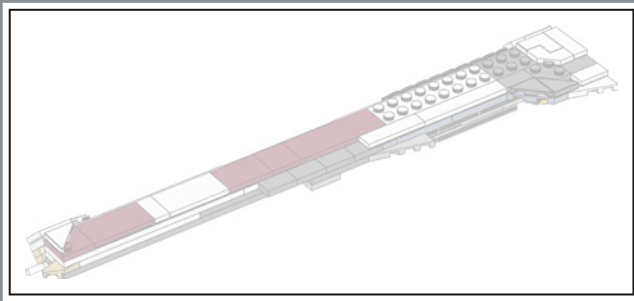

208

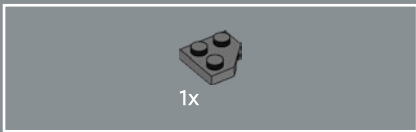
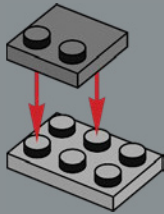

209

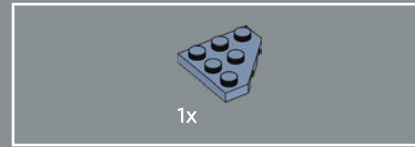
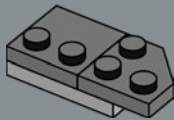

210

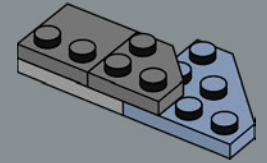

211

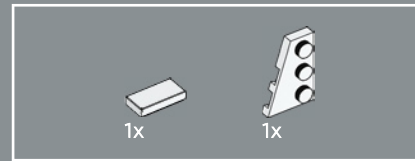
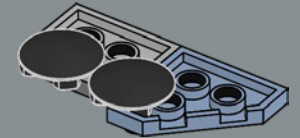

212

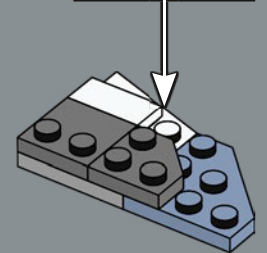
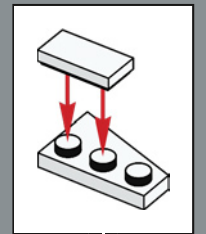



1x

213

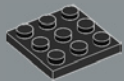
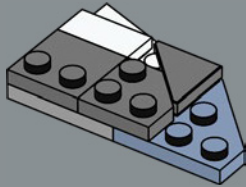

2x

214

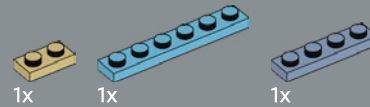
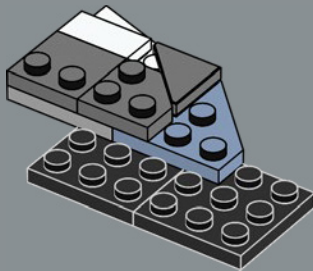

1x

1x

1x

215

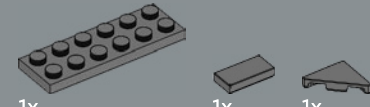
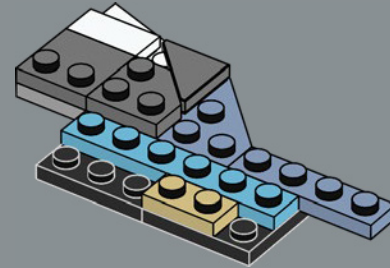

1x

1x

1x

216

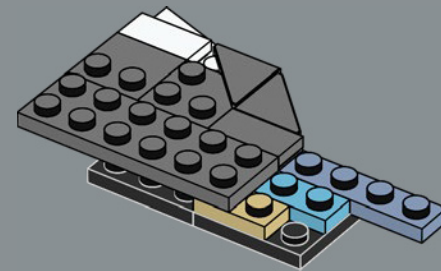

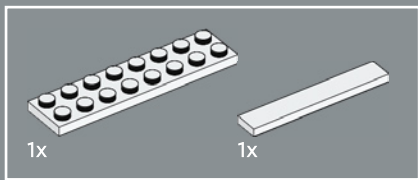

217

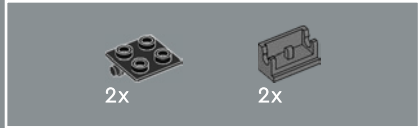
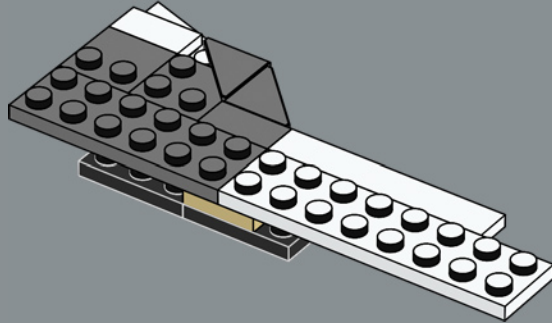

218

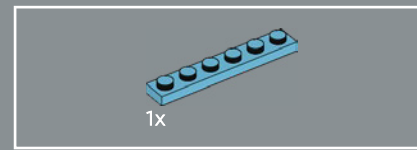
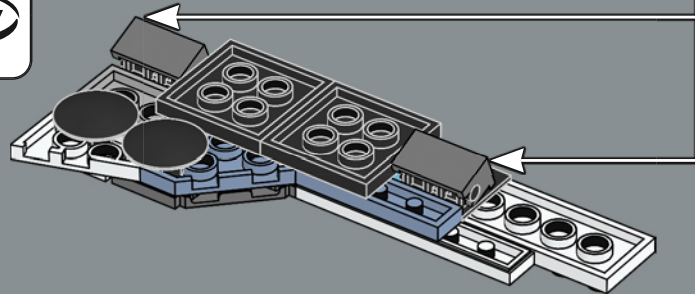
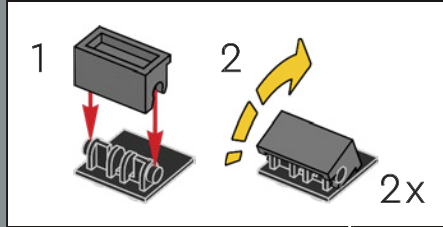

219

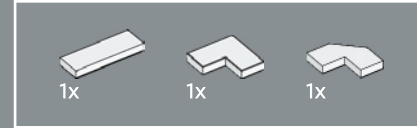
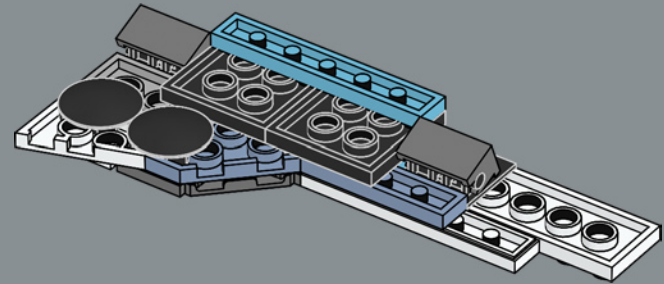

220

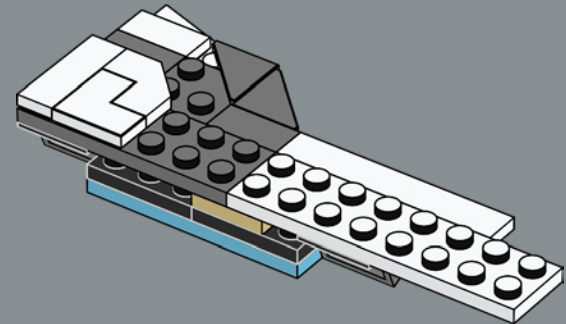

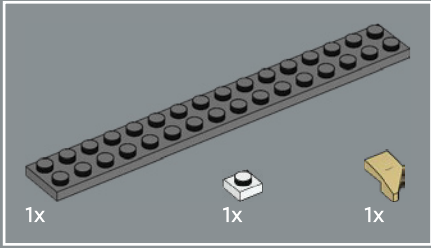
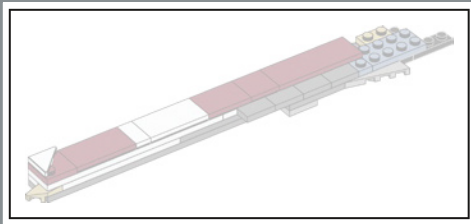

221

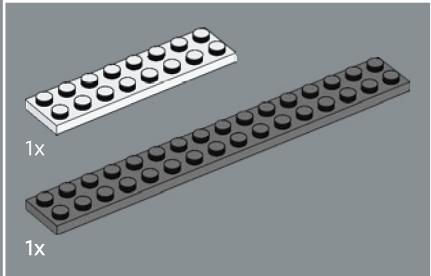
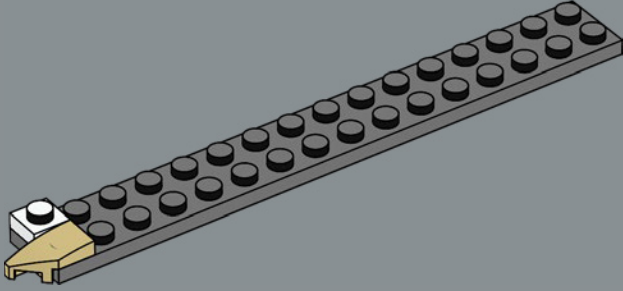

222

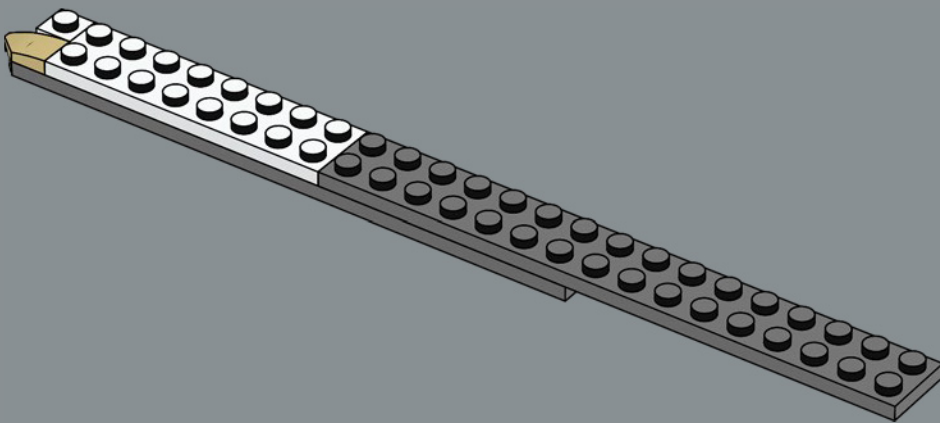

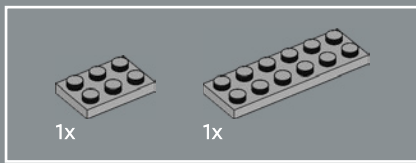

223

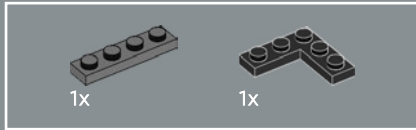

224

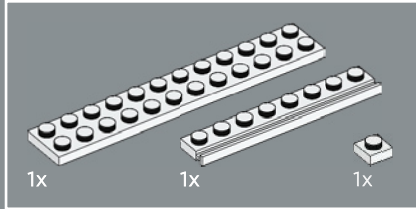

225

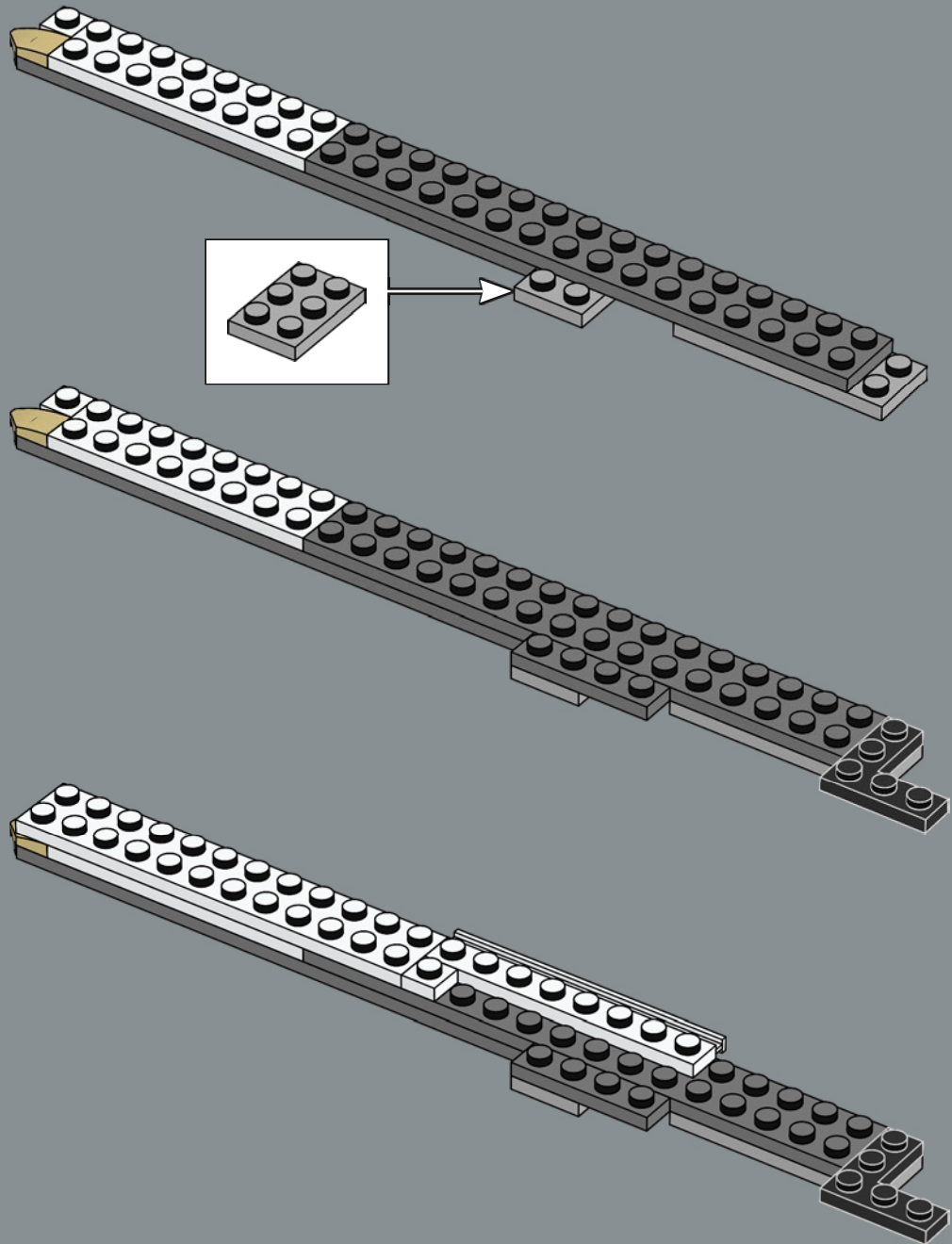

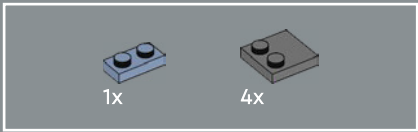

226

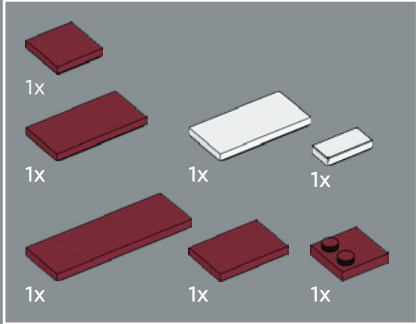
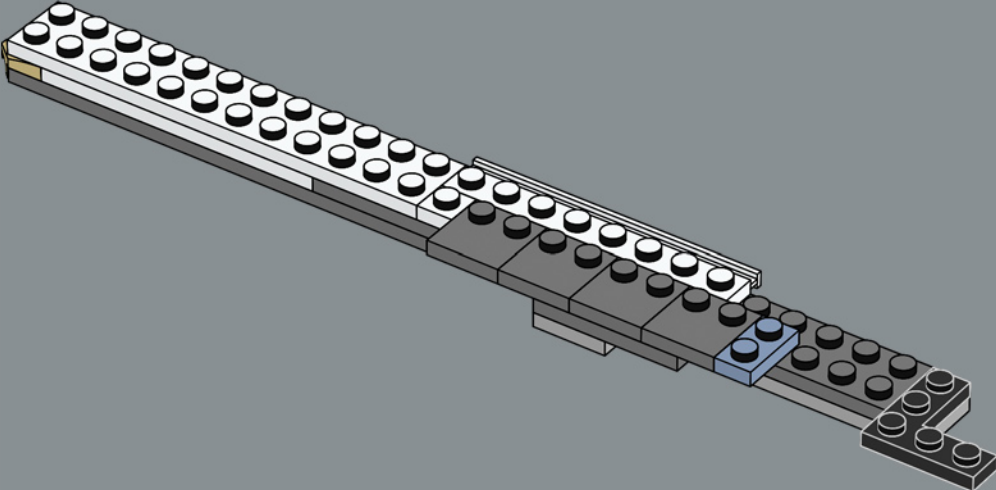

227

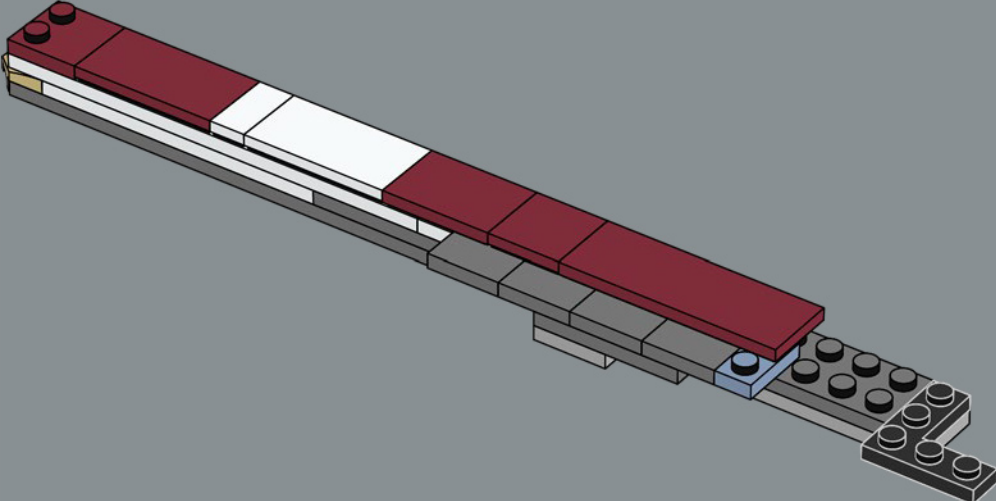

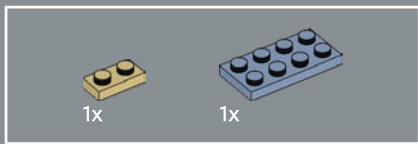

228

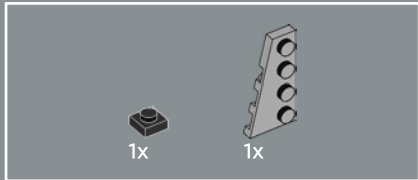
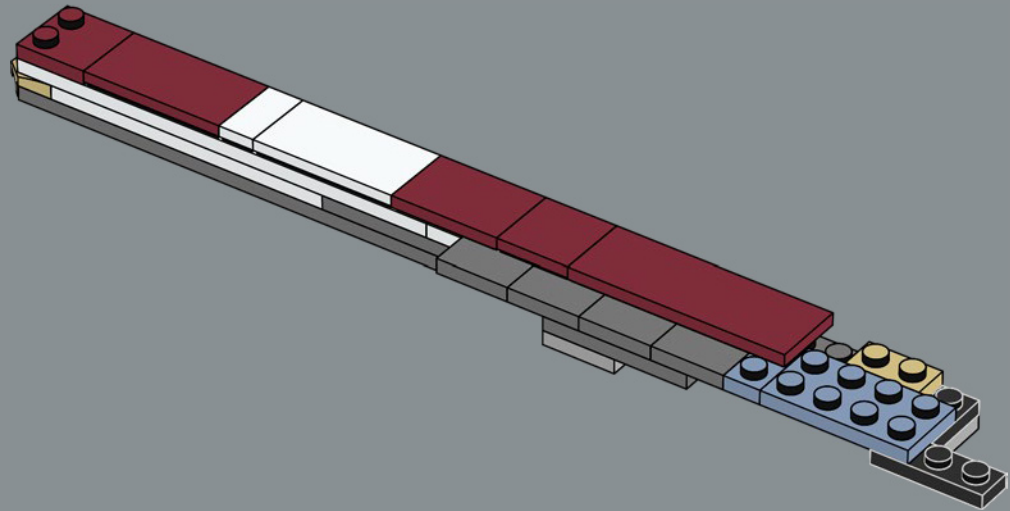

229

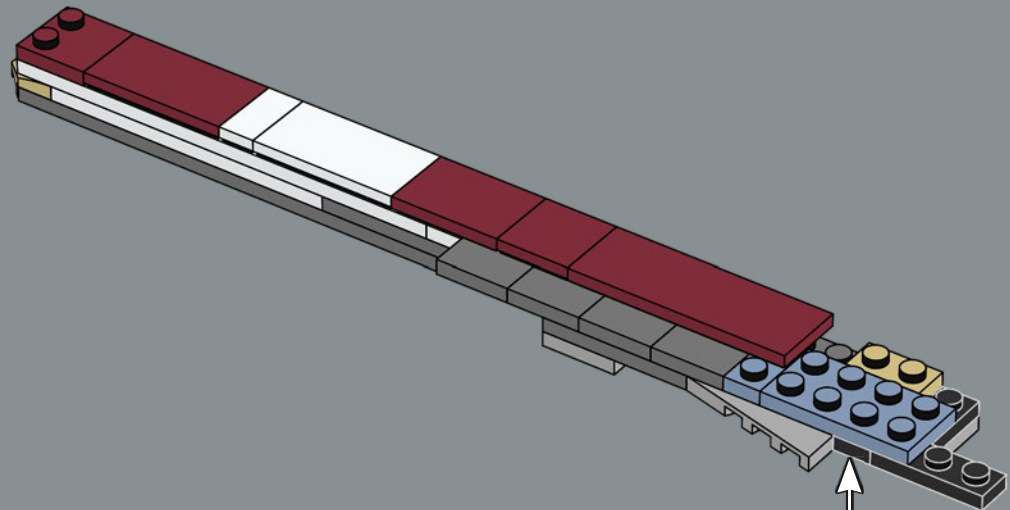



1x

230

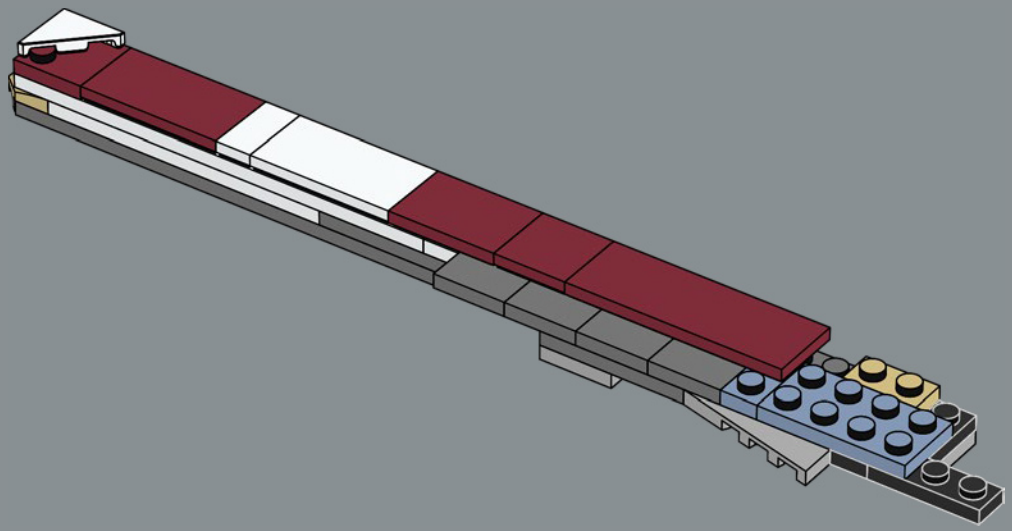

231

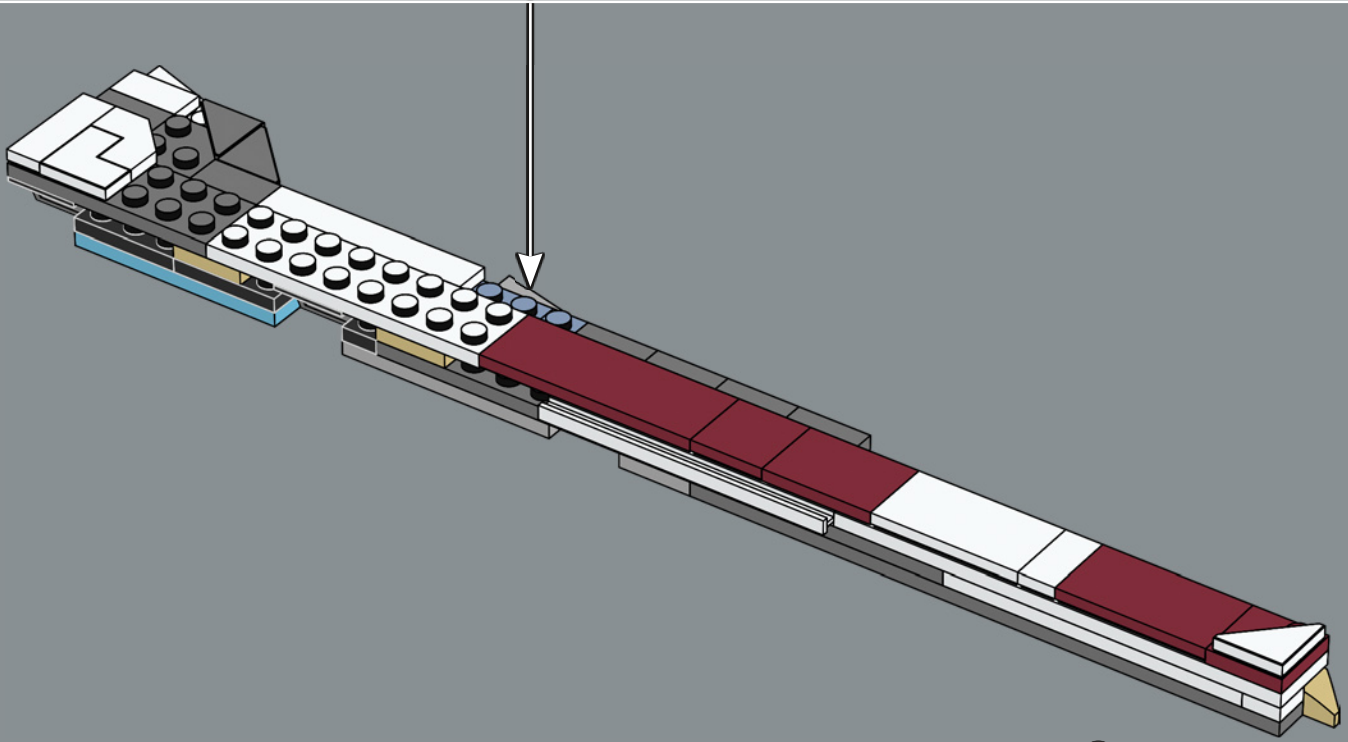

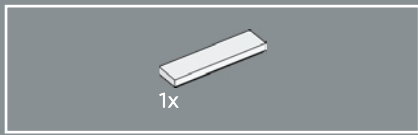

232

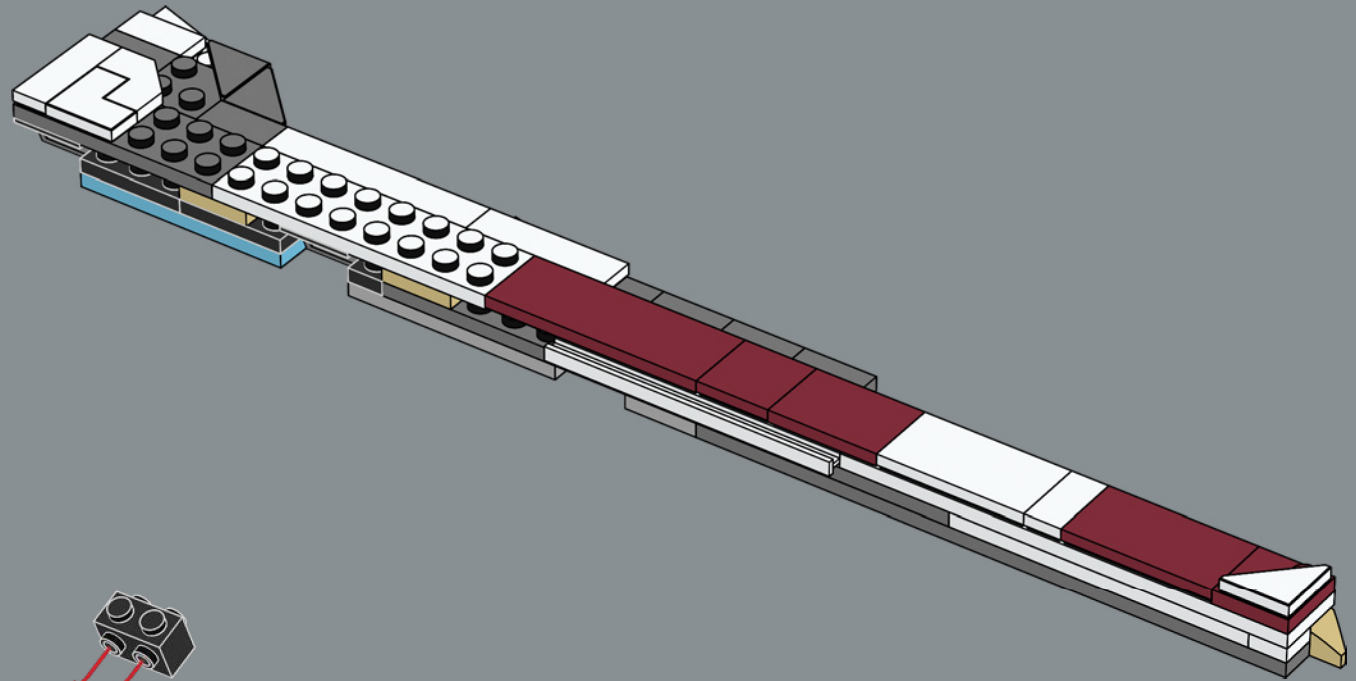

233

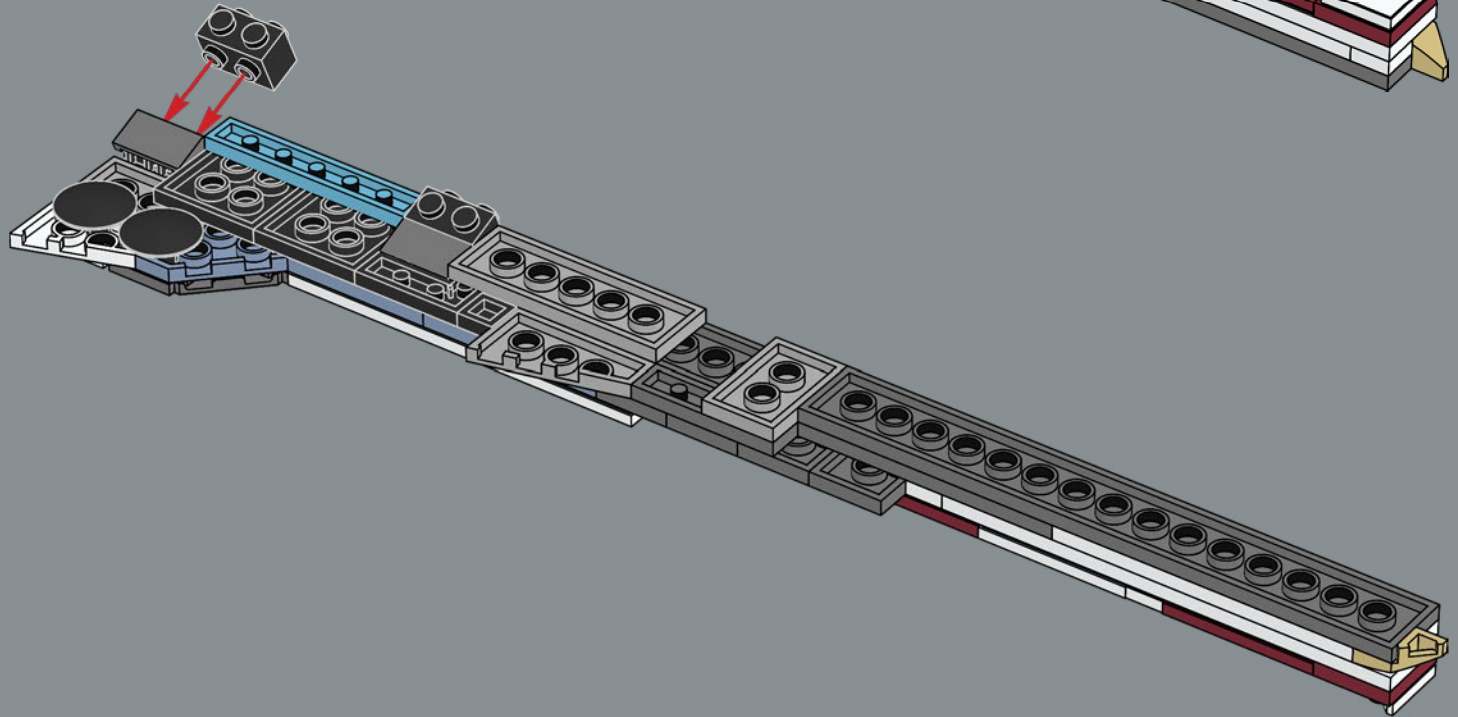

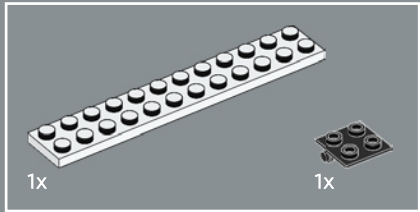
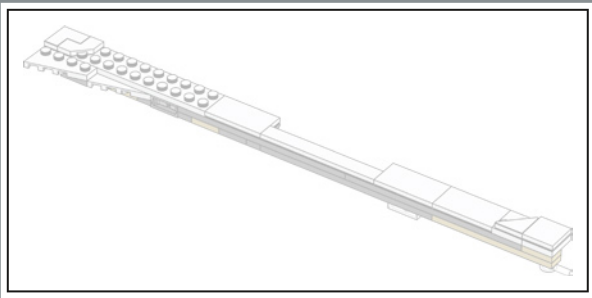

234

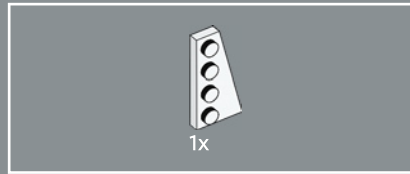
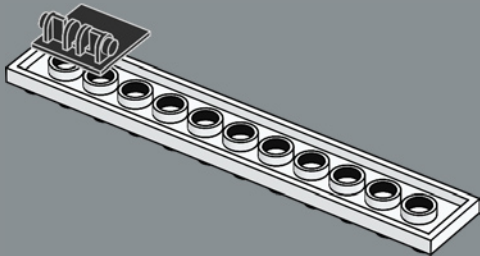

235

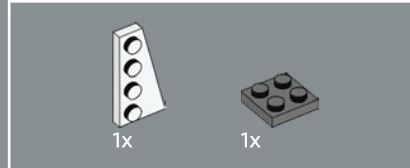
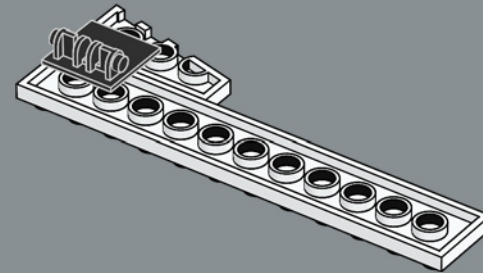

236

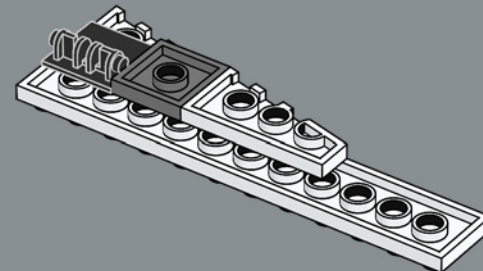

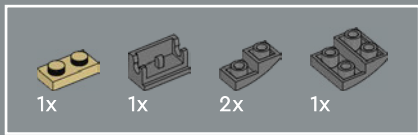

237

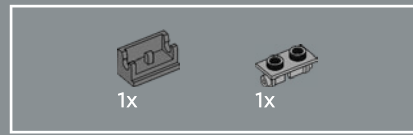
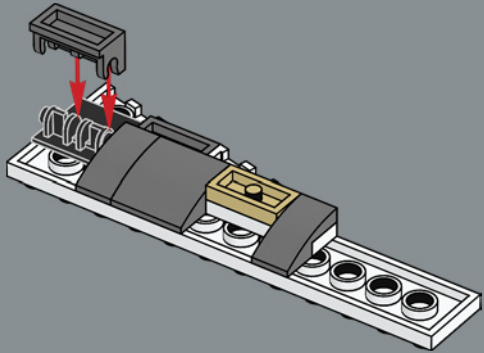

238

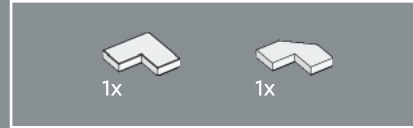
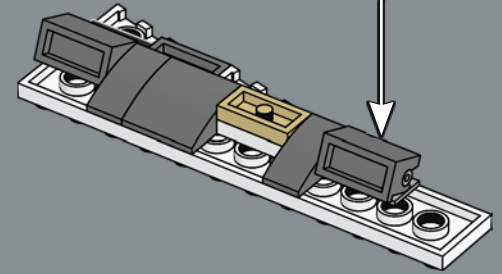
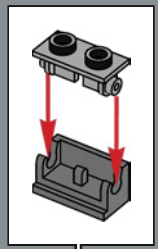

239

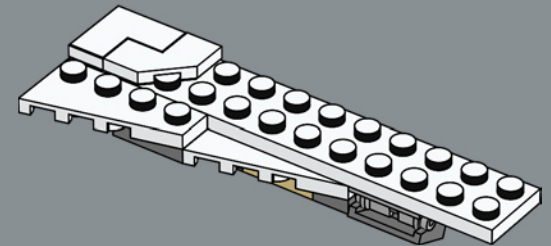

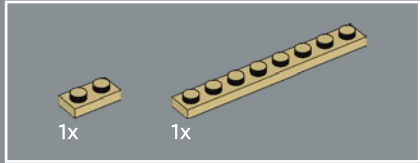
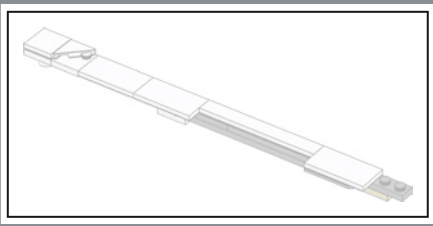

240

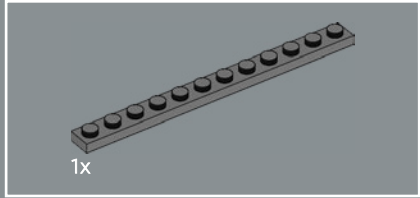
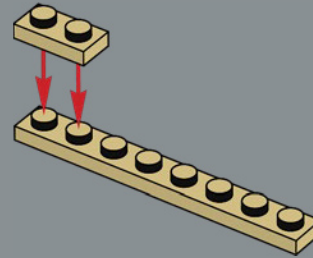

241

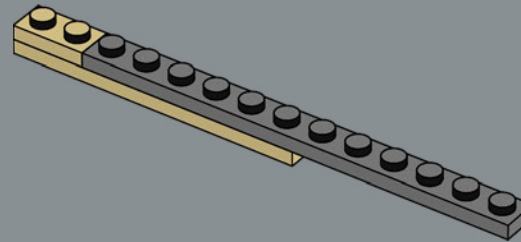

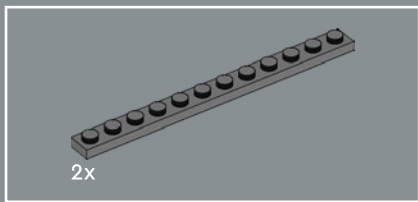

242

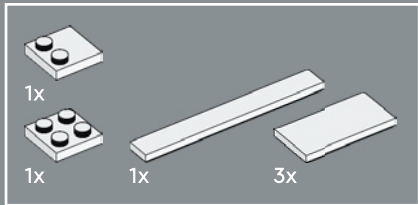
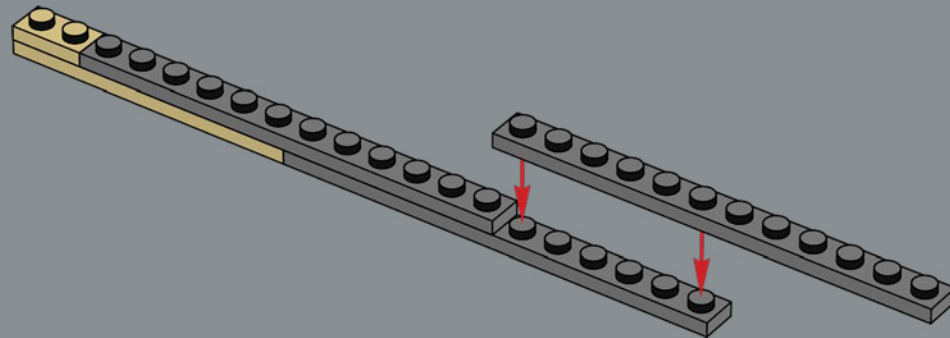

243

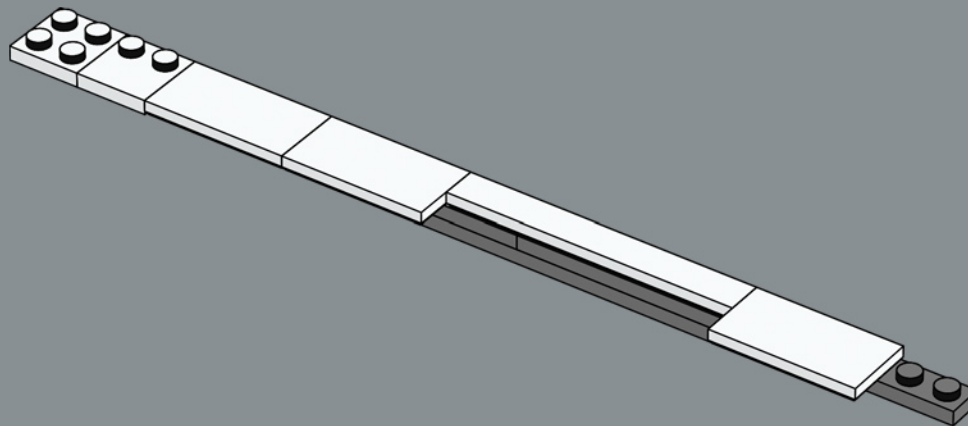

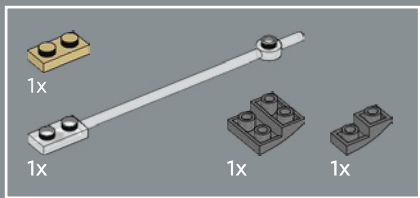

244

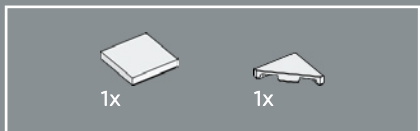
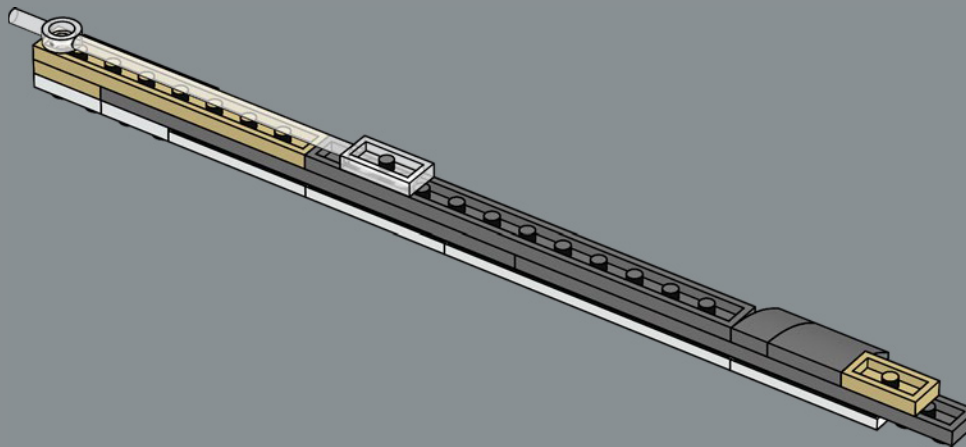

245

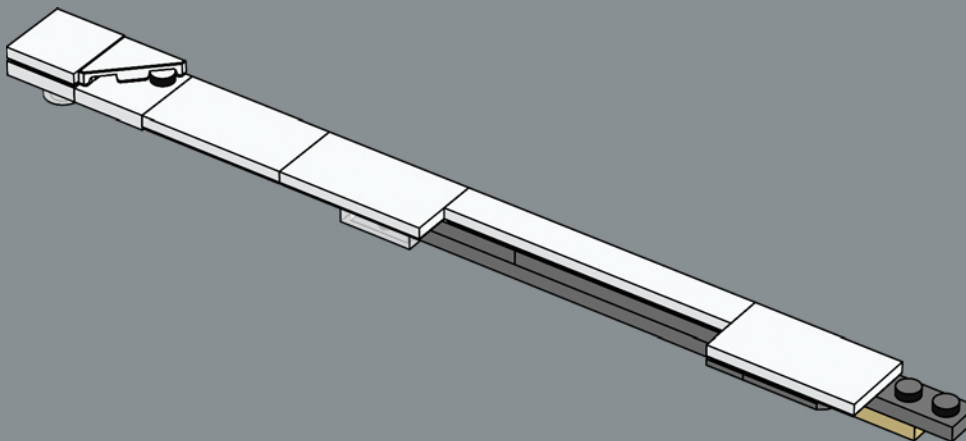

246

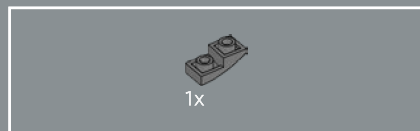
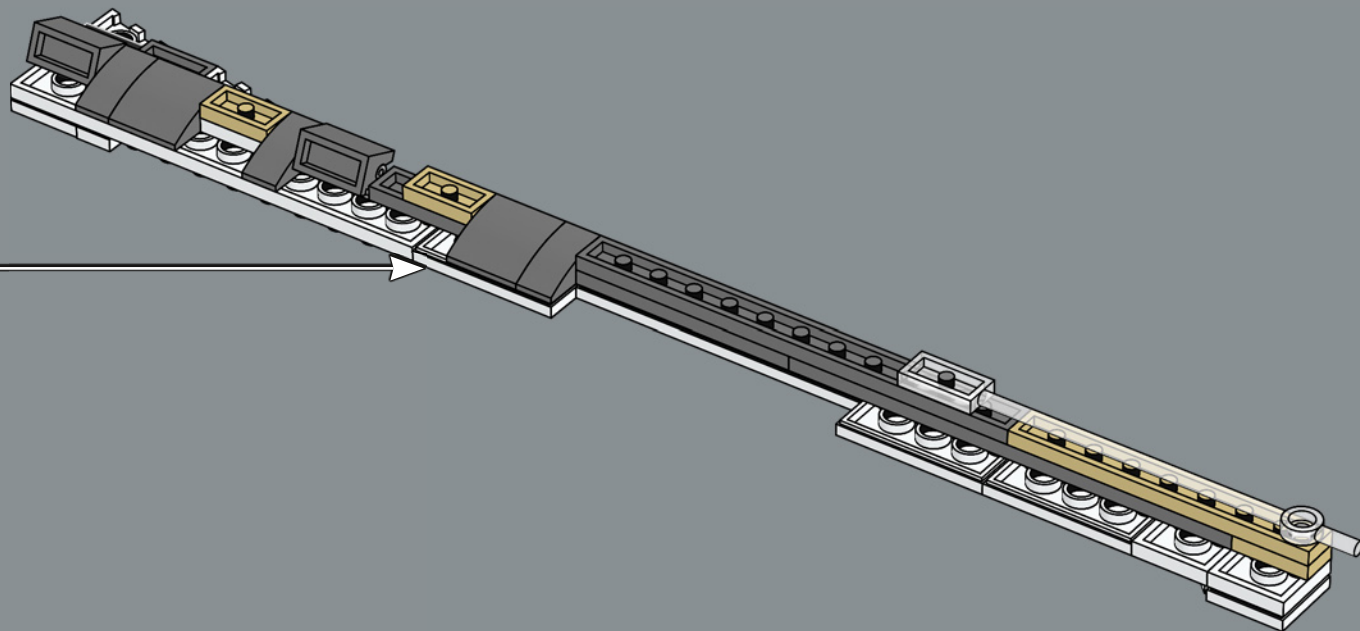

247

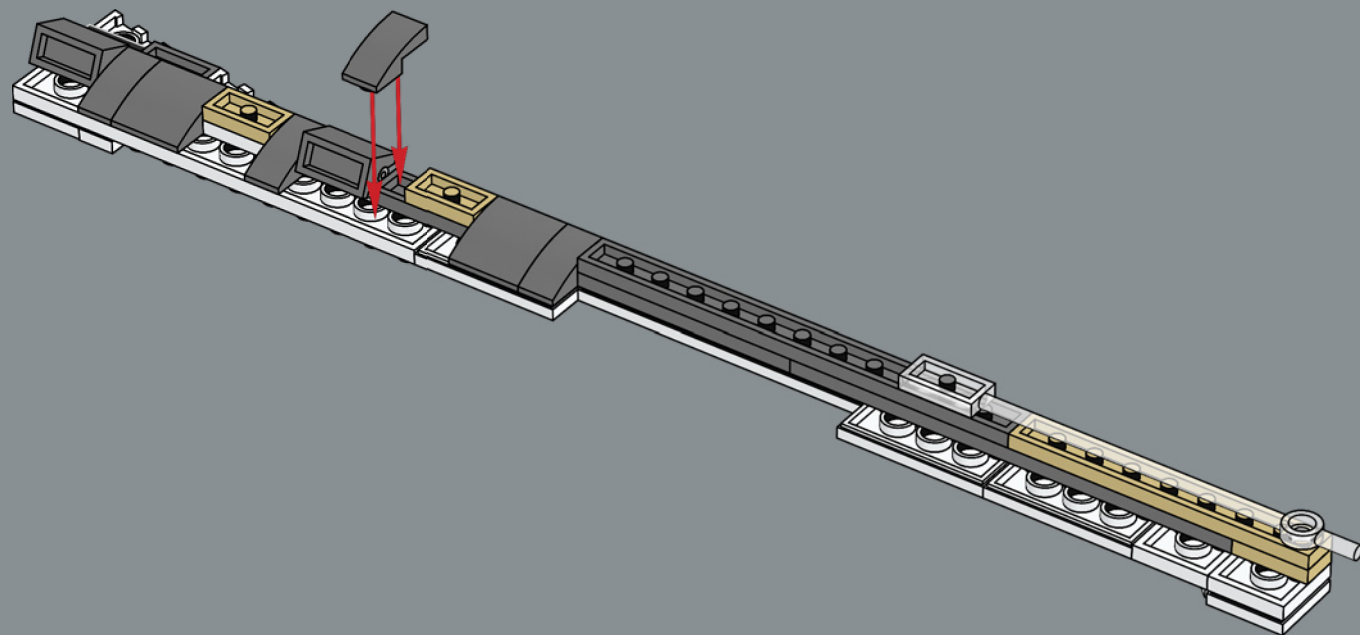

248

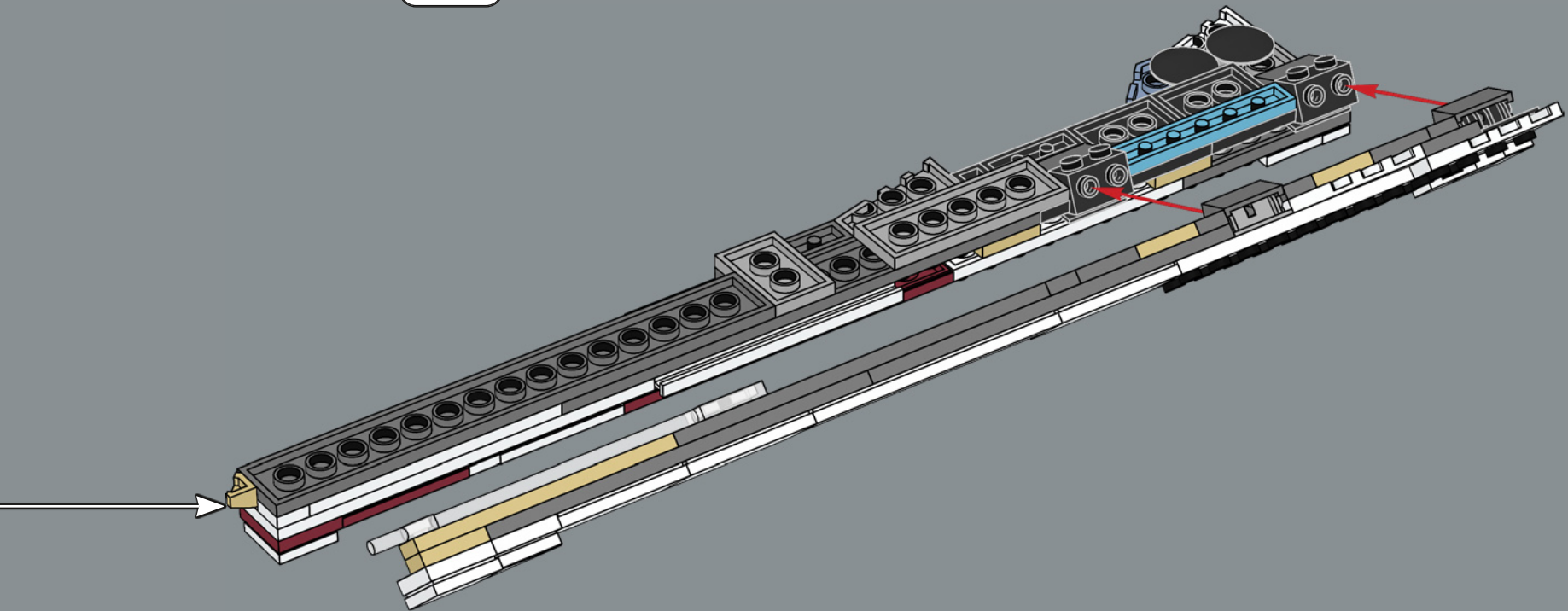

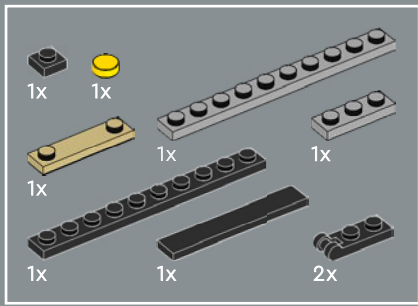

249

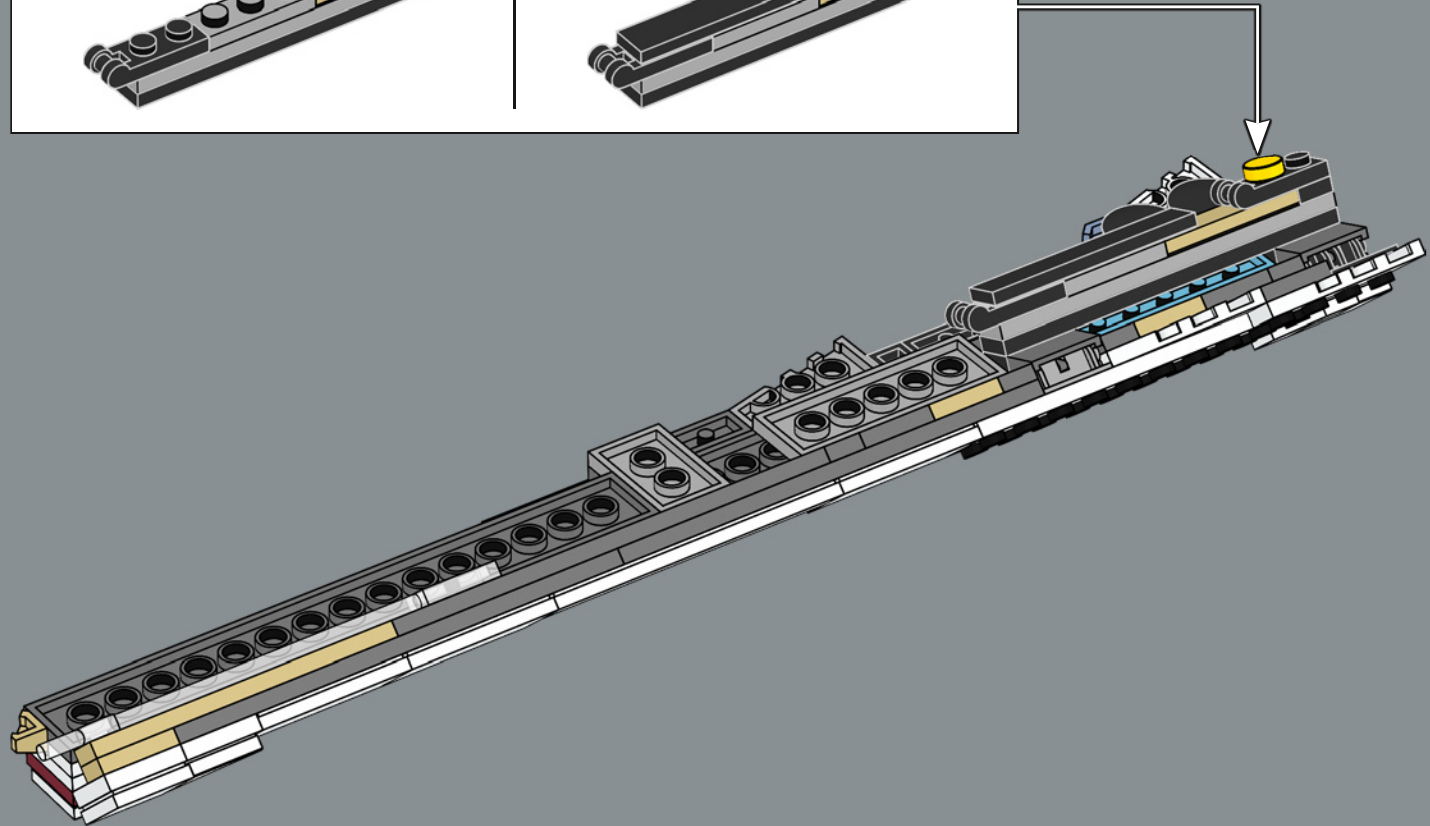
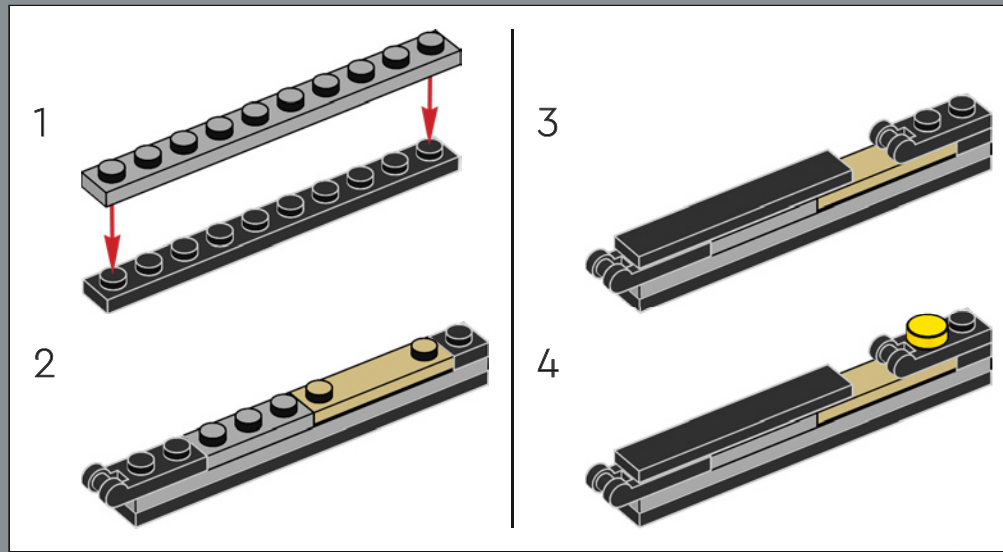

250

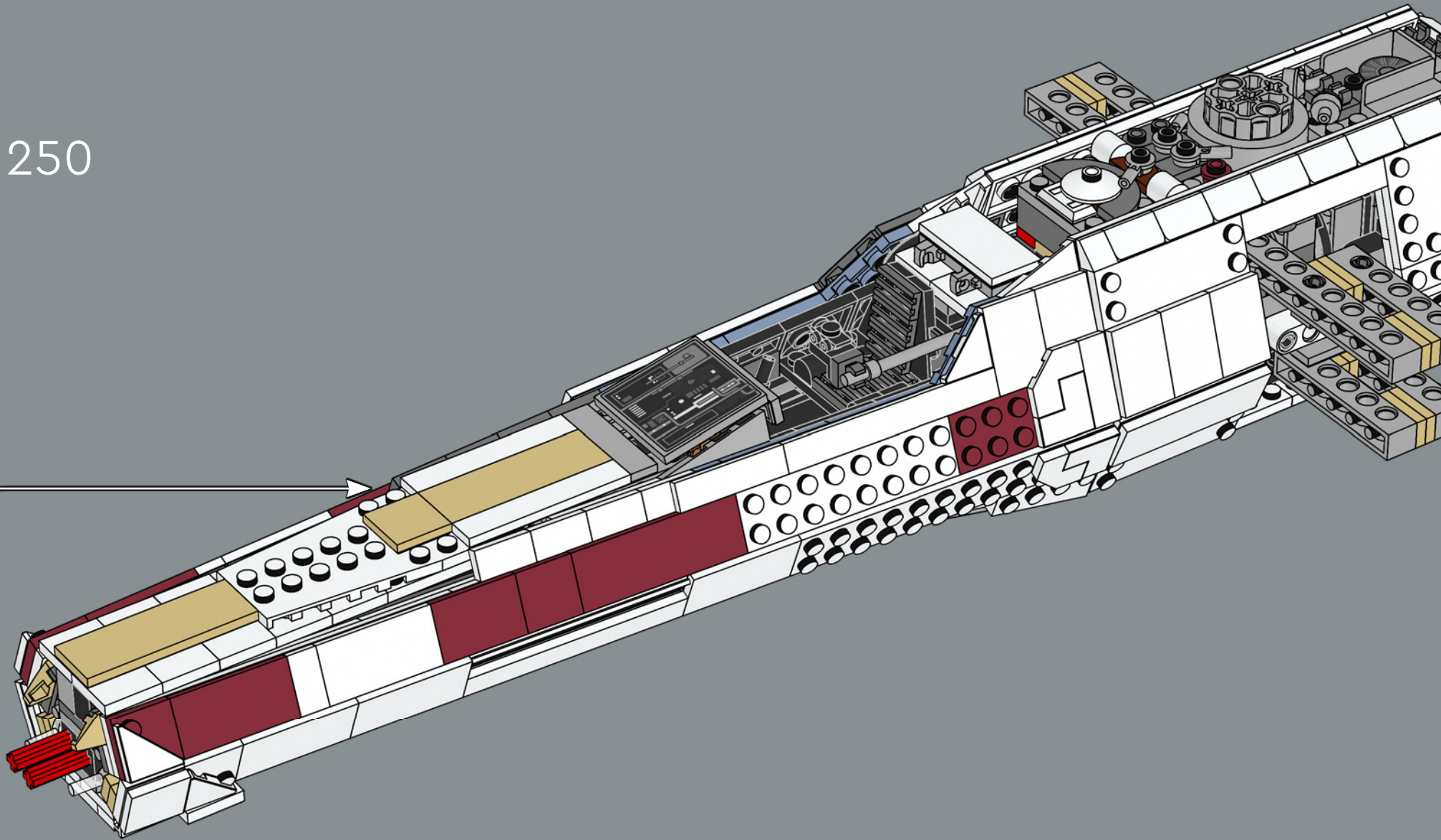

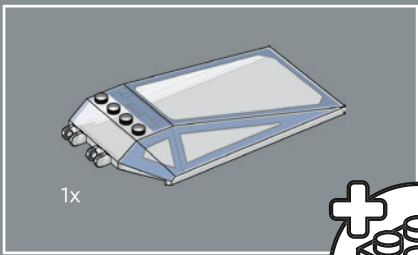

251

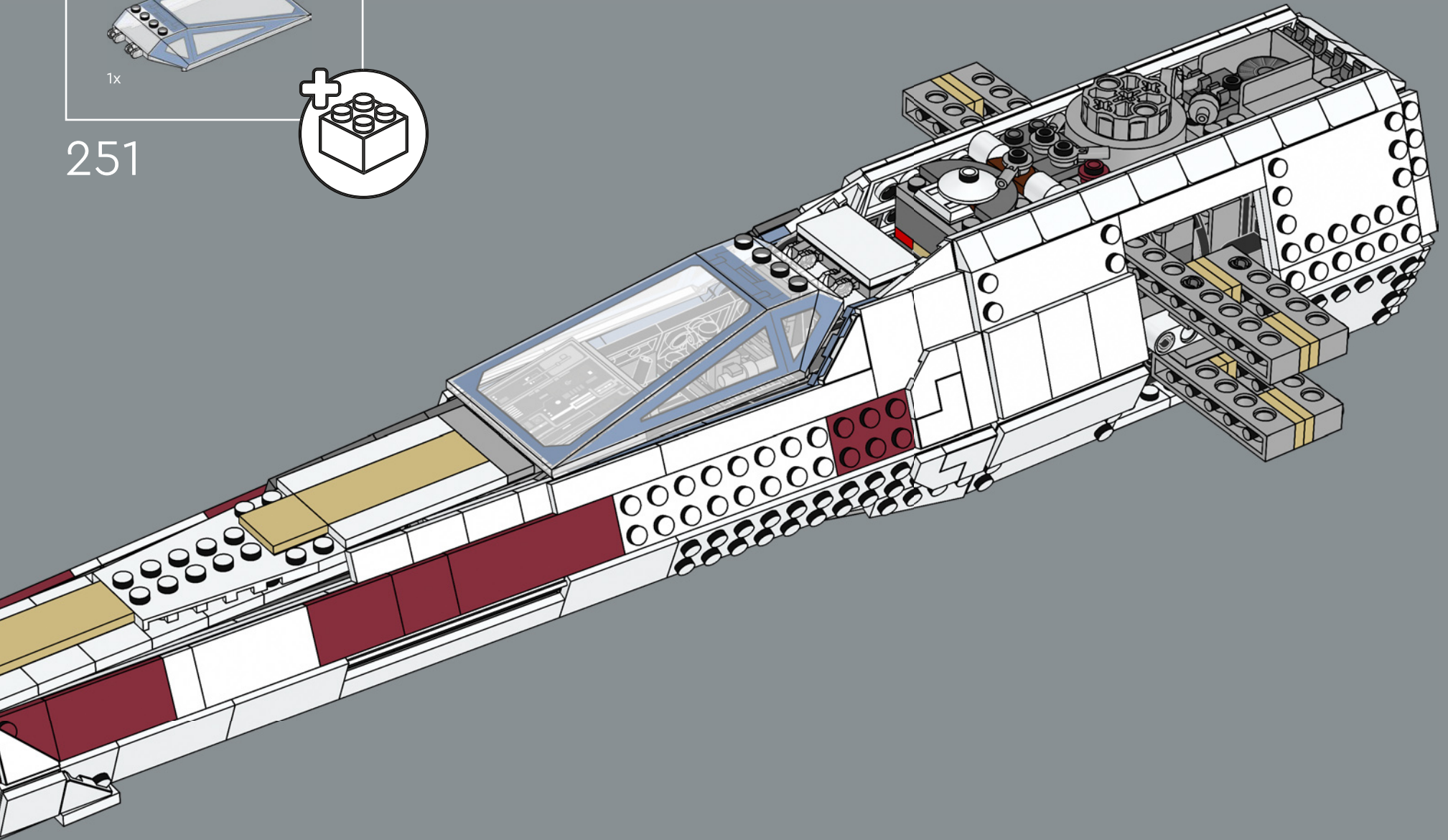
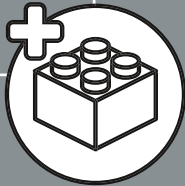

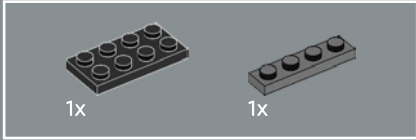
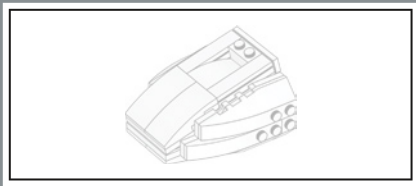

252

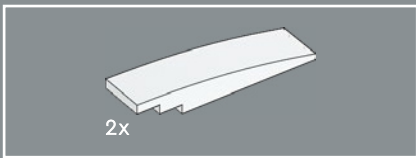
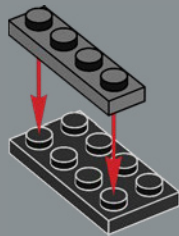

253

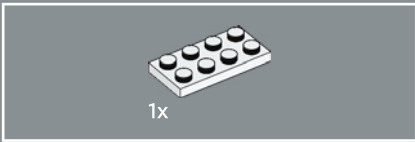
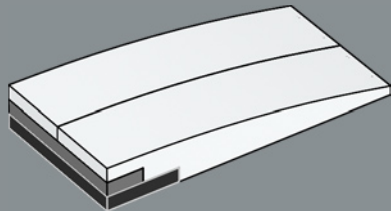

254

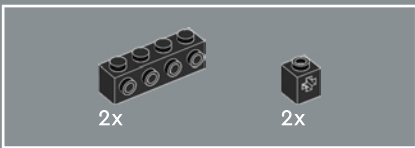
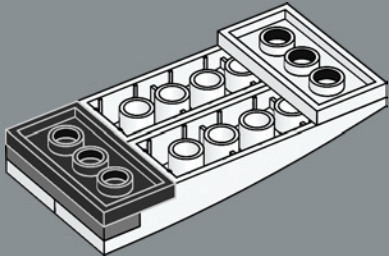

255

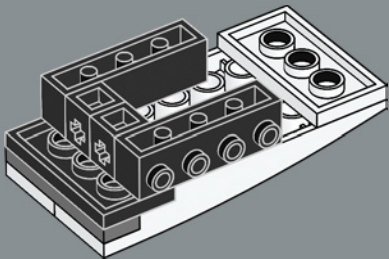

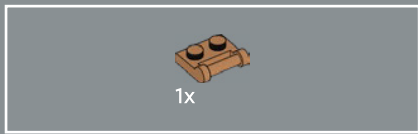

256

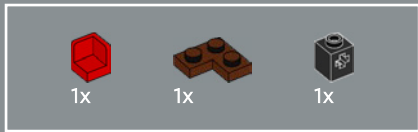
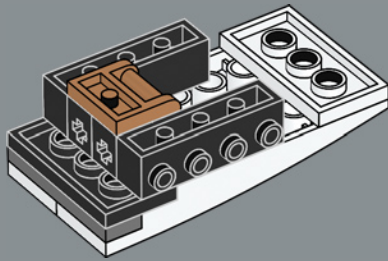

257

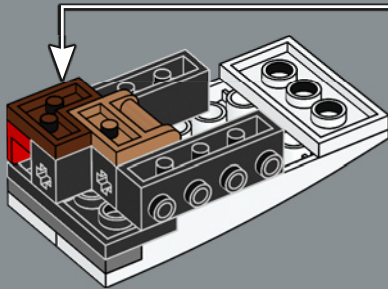
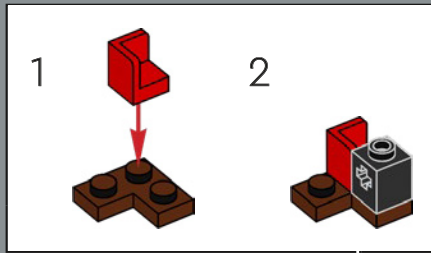

258

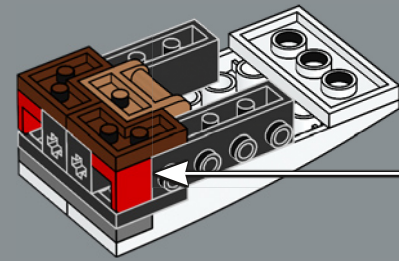
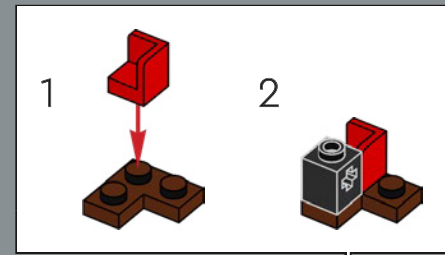

259

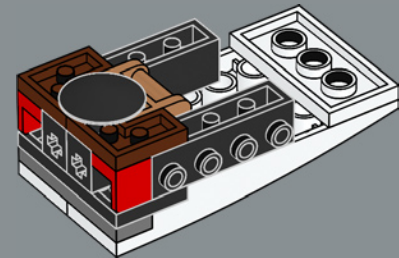

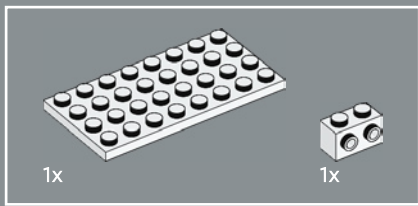

260

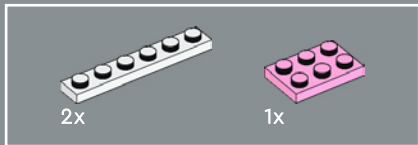
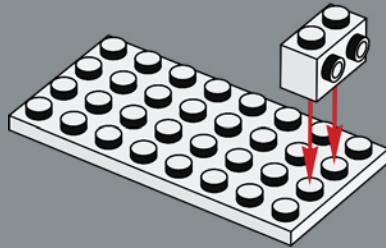

261

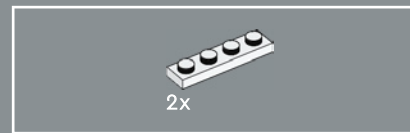
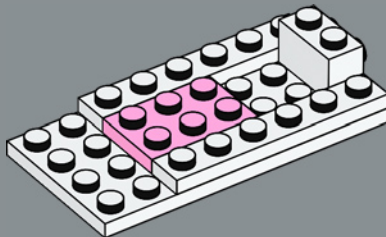

262

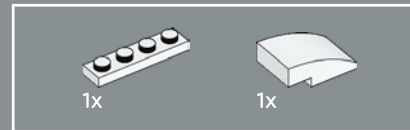
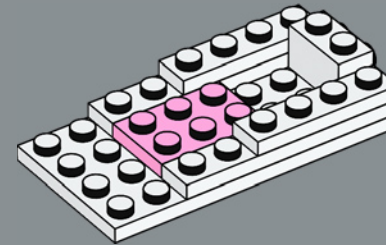

263

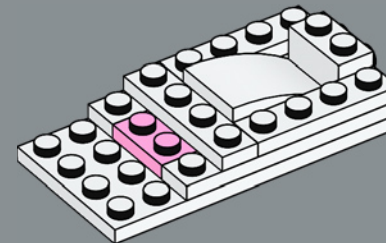

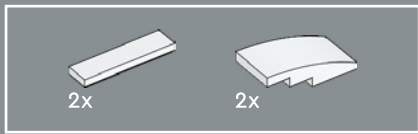

264

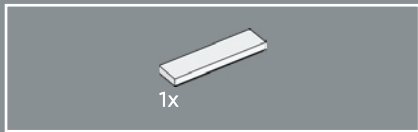
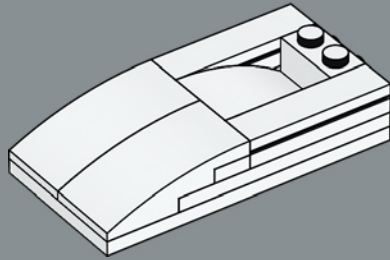

265

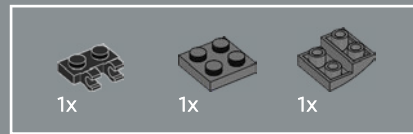
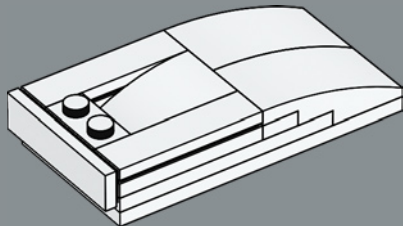

266

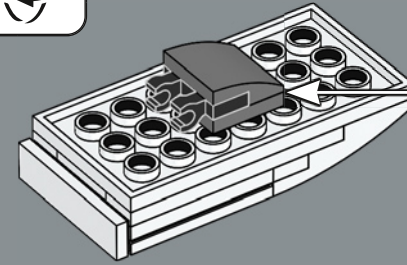
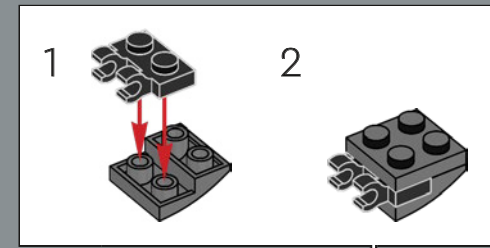

267

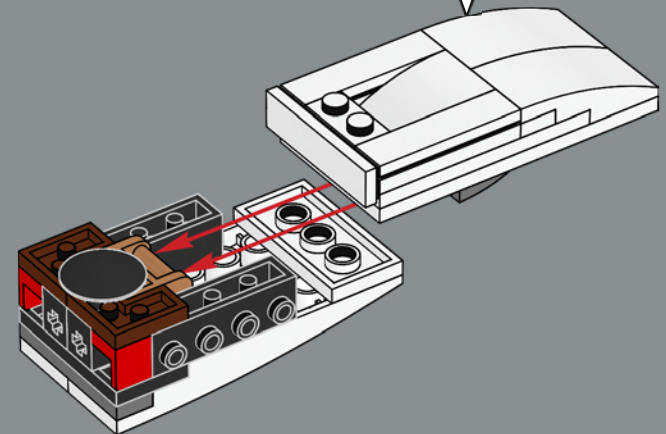

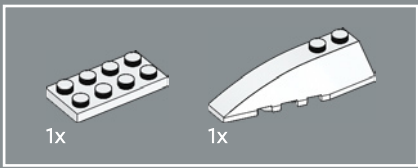

268

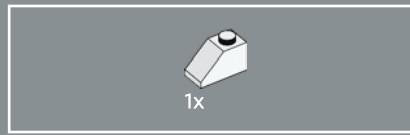
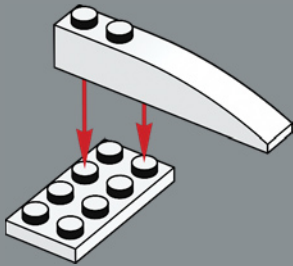

269

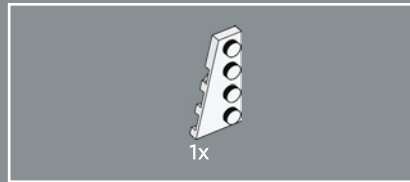
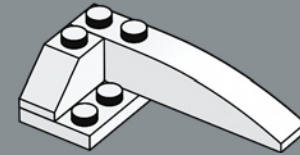

270

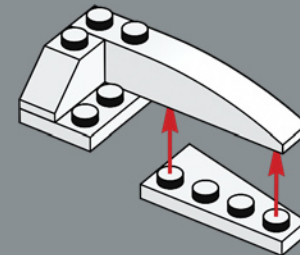

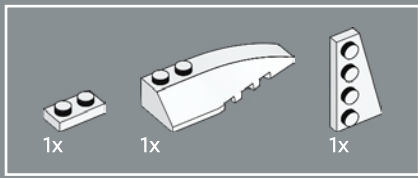

271

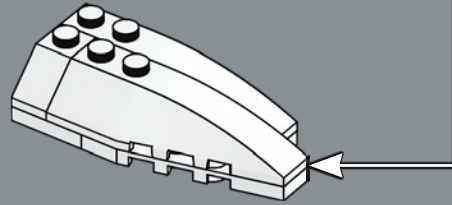
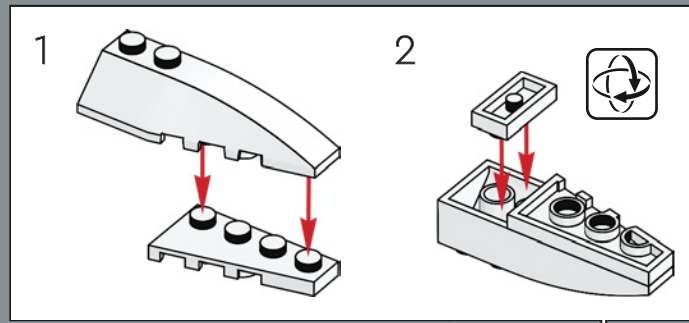

272

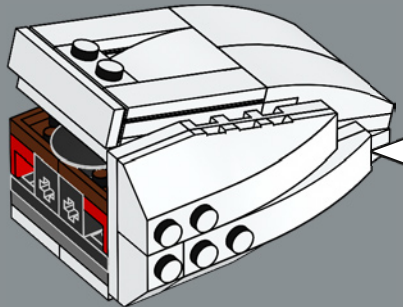

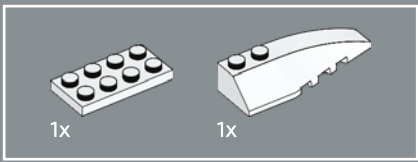

273

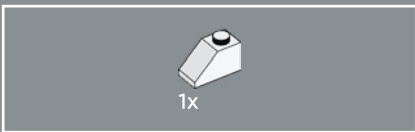
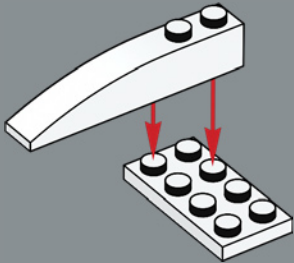

274

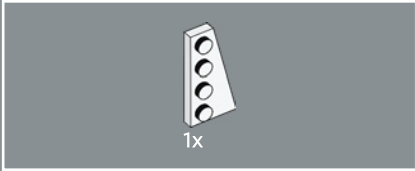
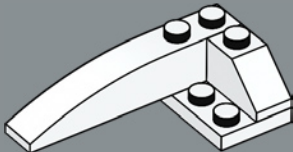

275

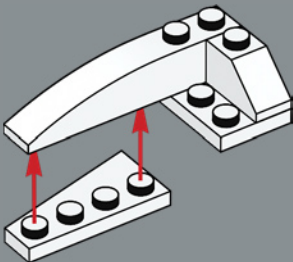

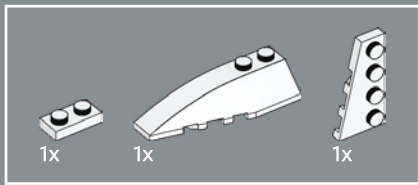

276

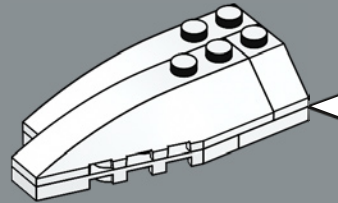
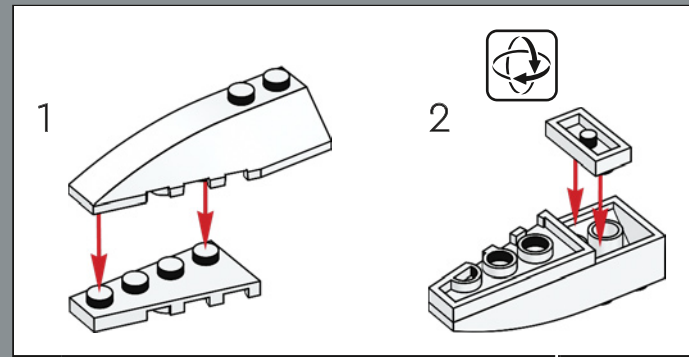

277

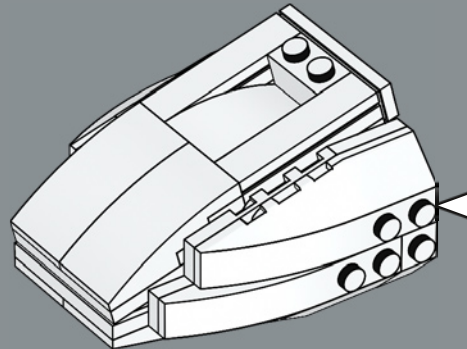

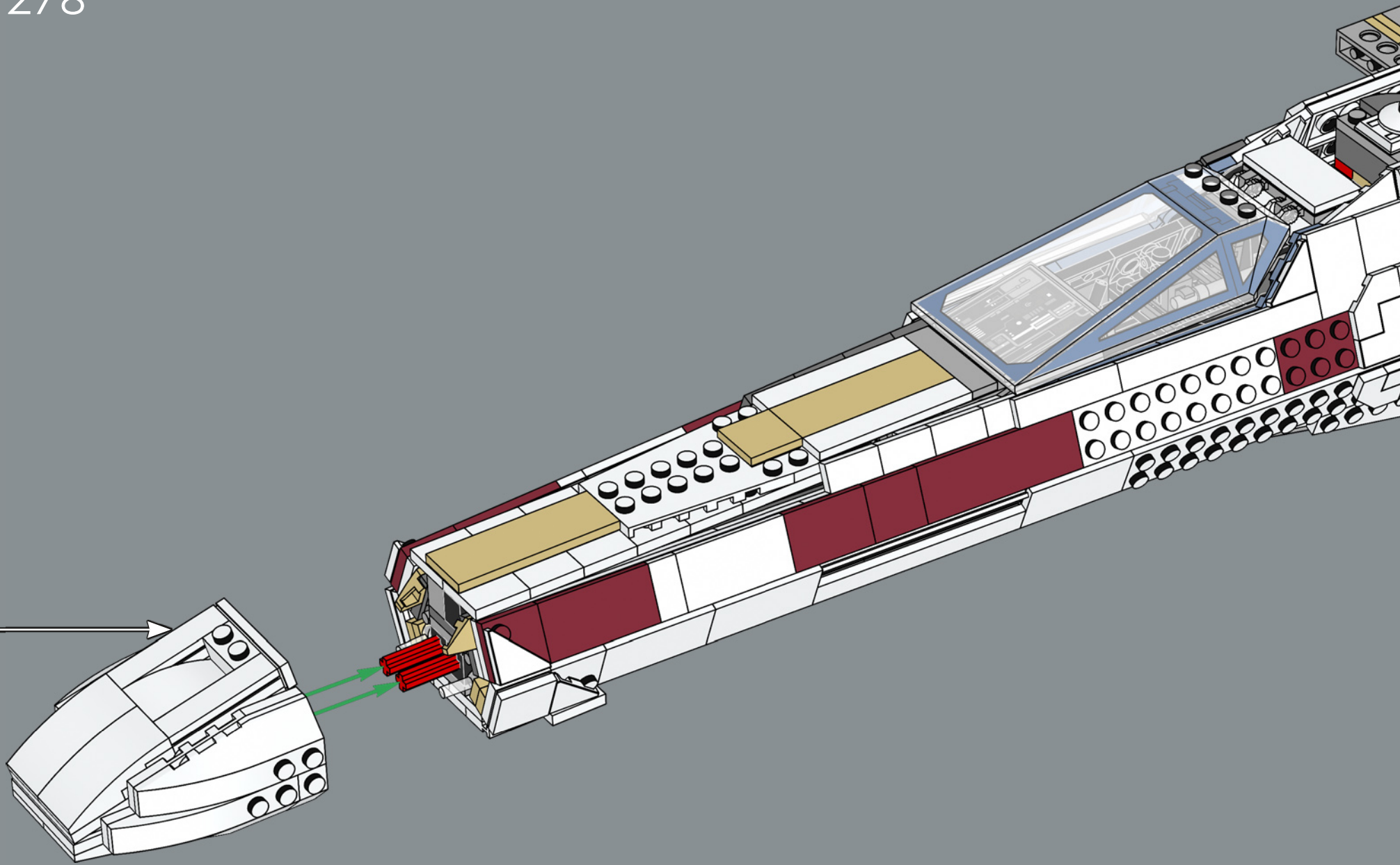

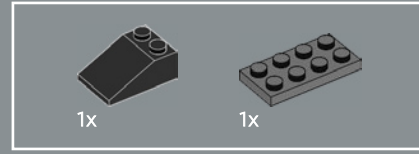
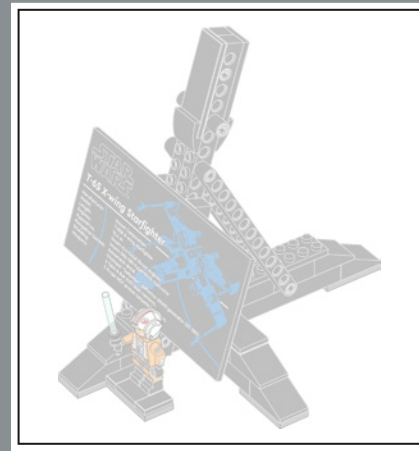
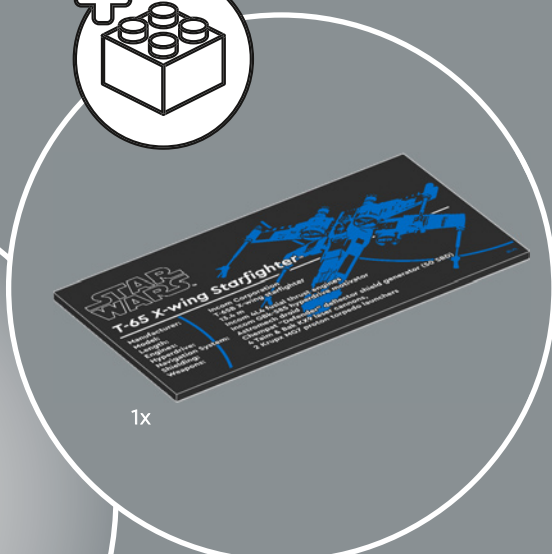
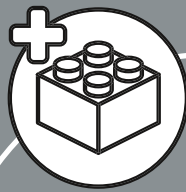

279

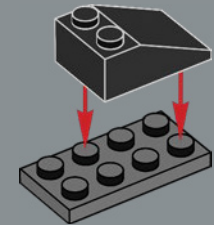

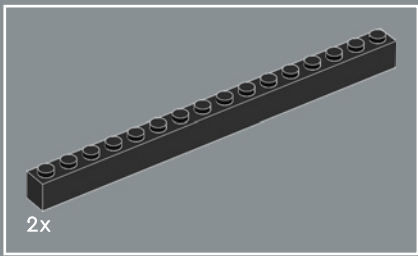

280

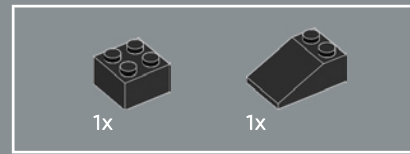
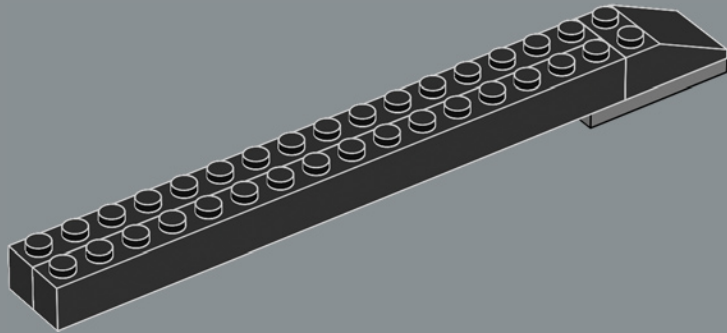

281

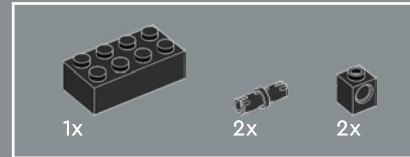
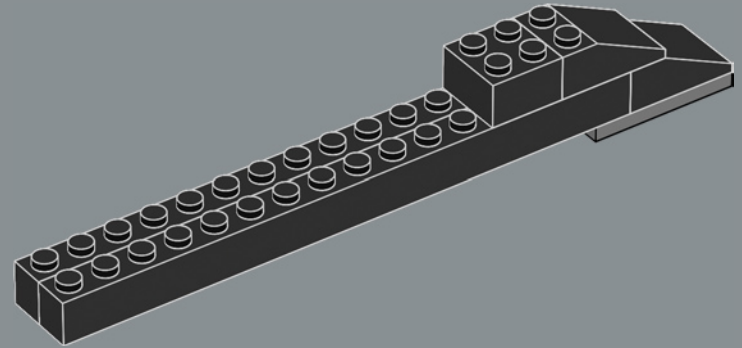

282

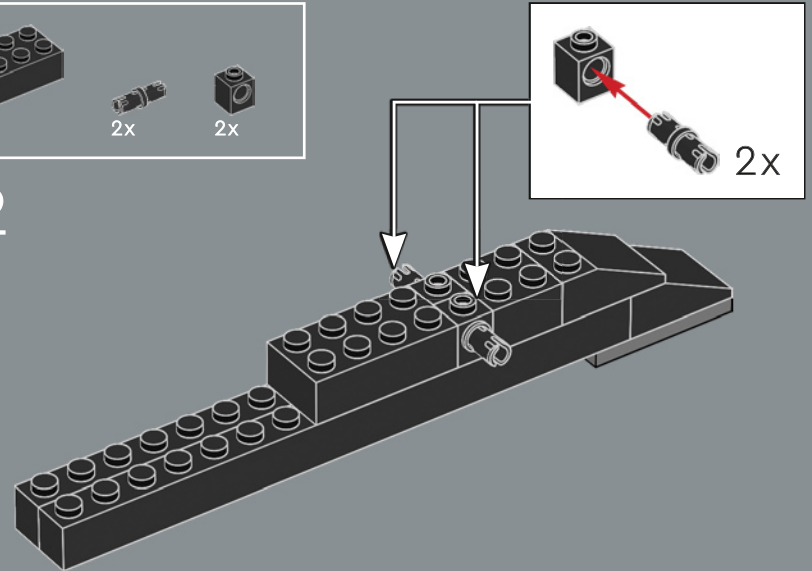

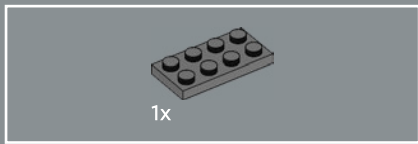

283

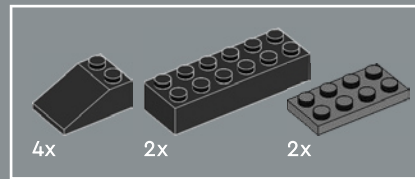
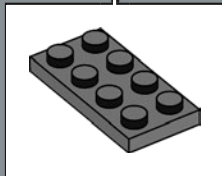
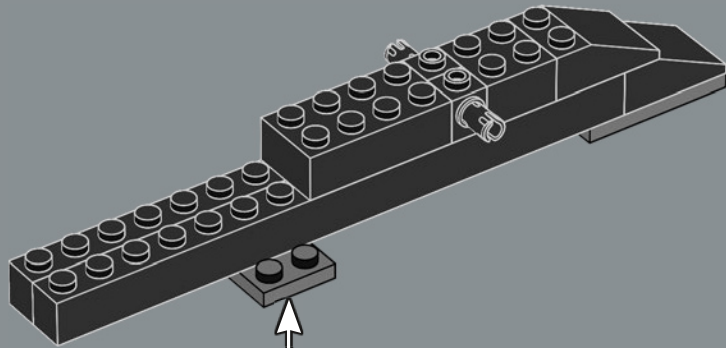

284

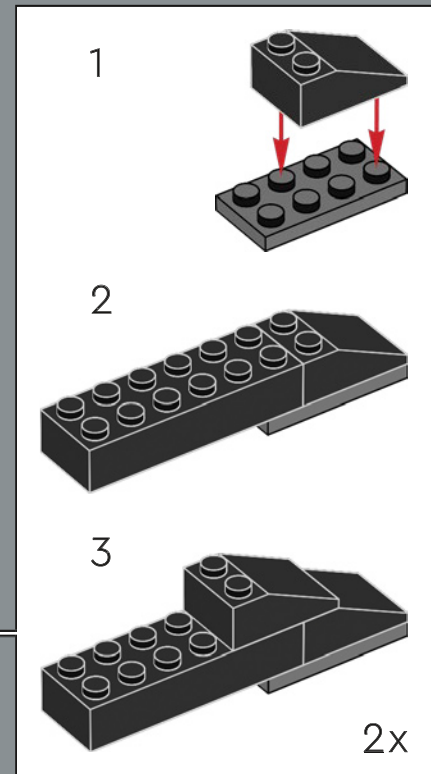
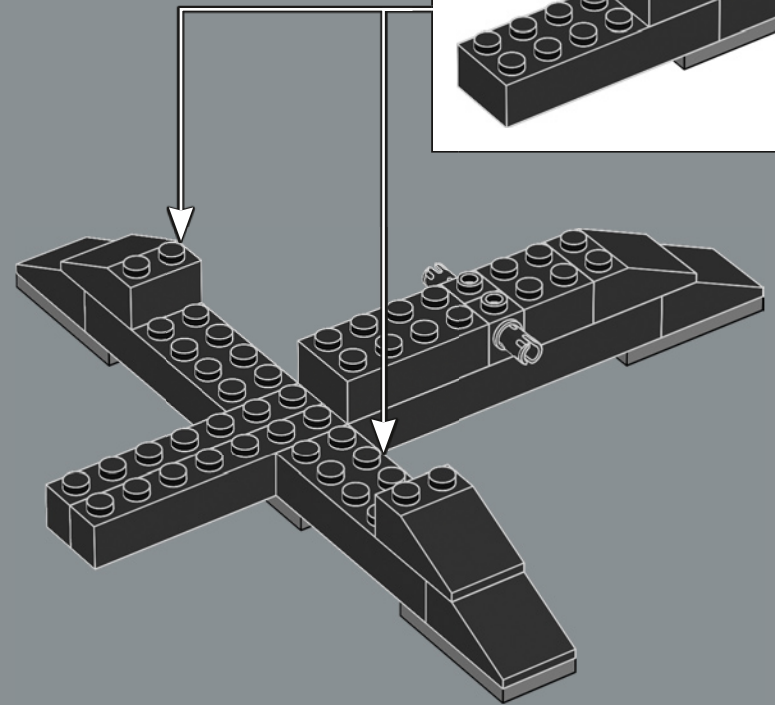

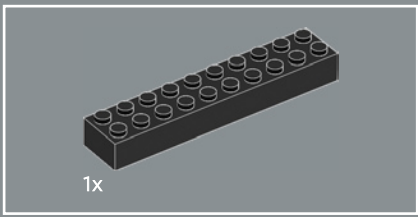

285

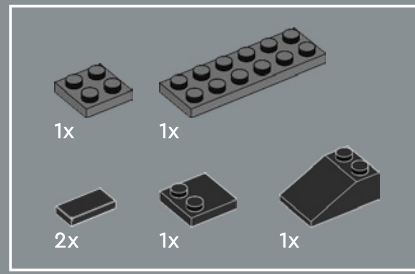

286

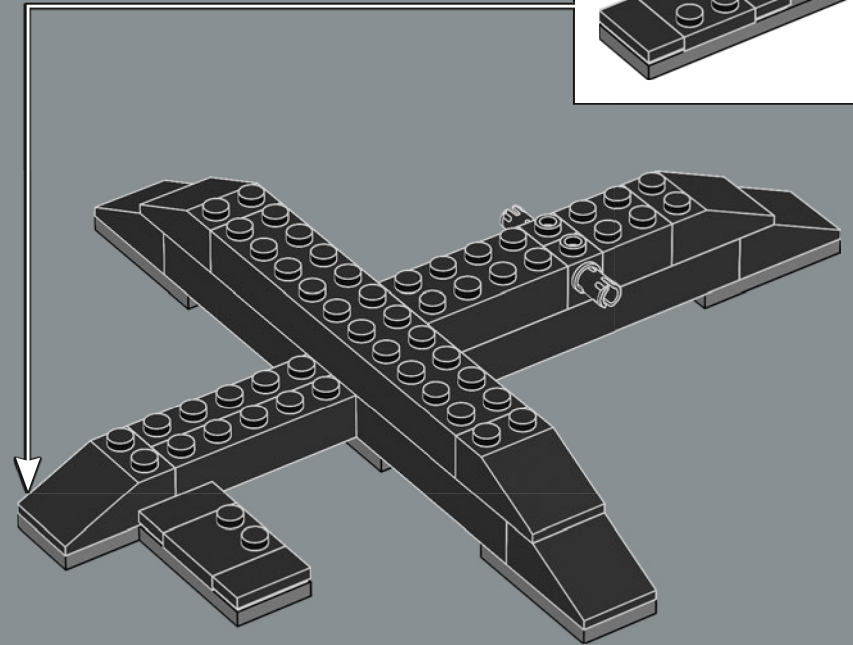
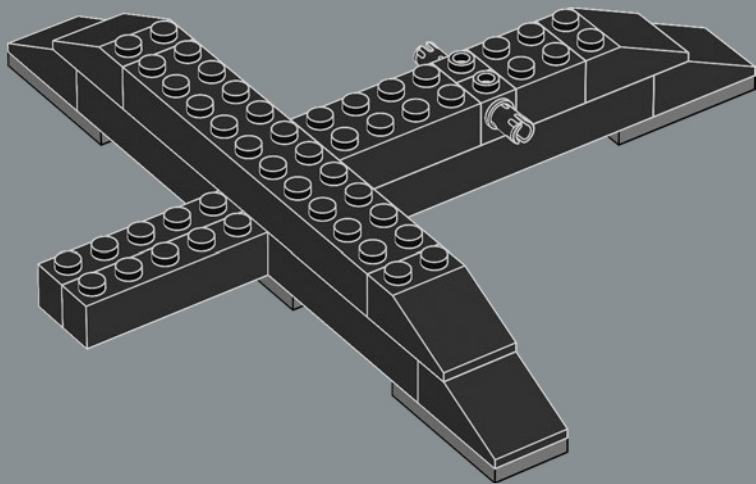
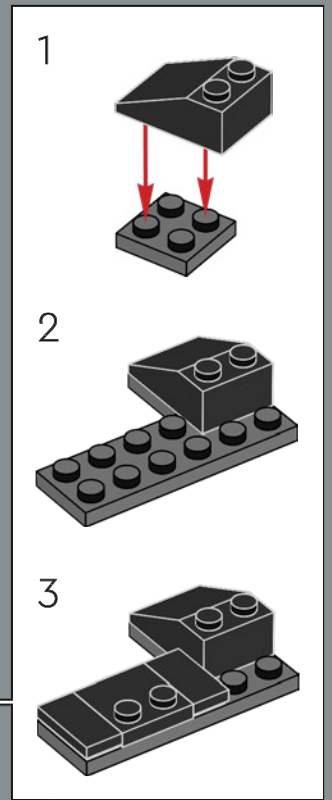

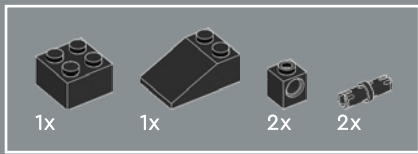

287

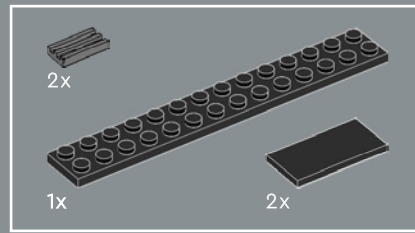
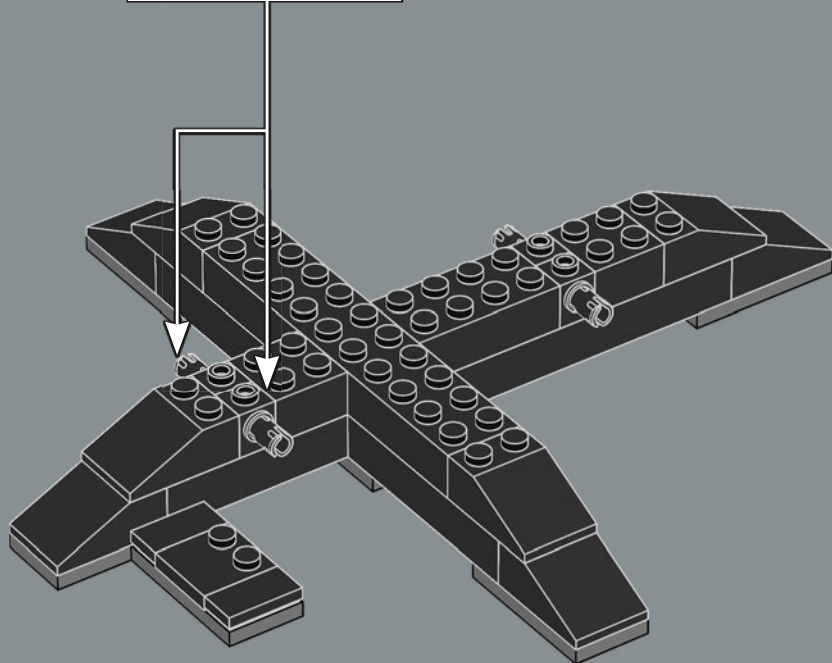
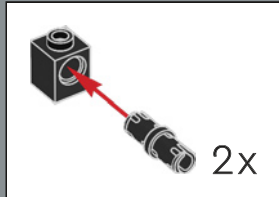

288

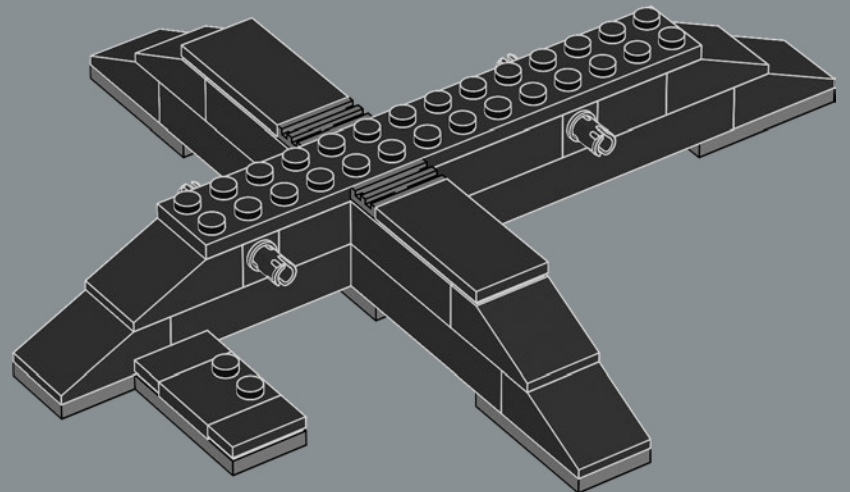

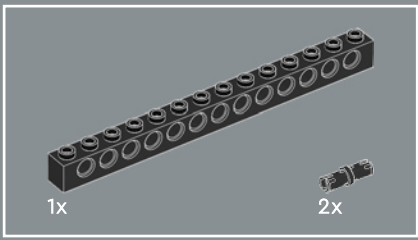

289

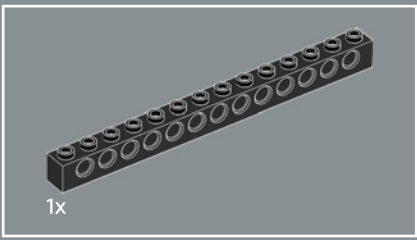
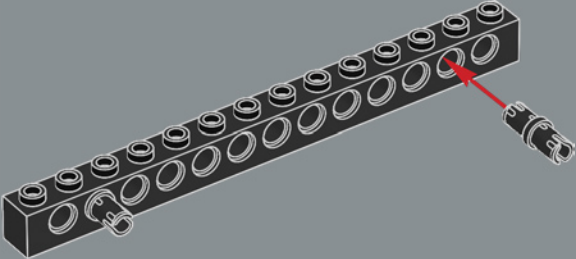

290

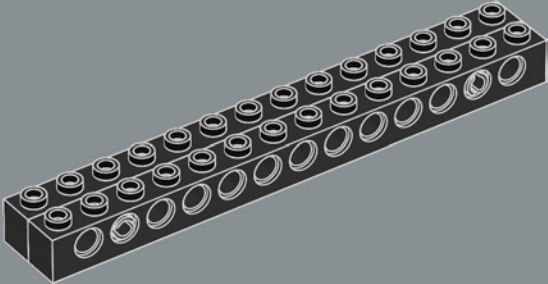

291

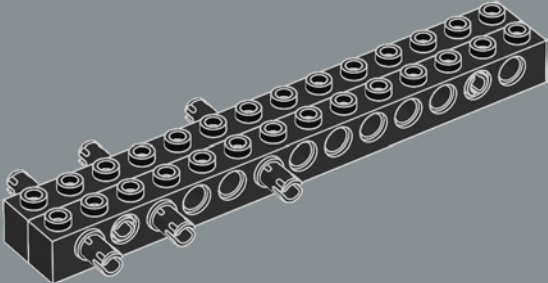

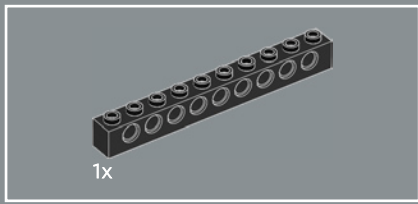

292

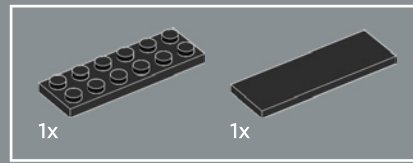
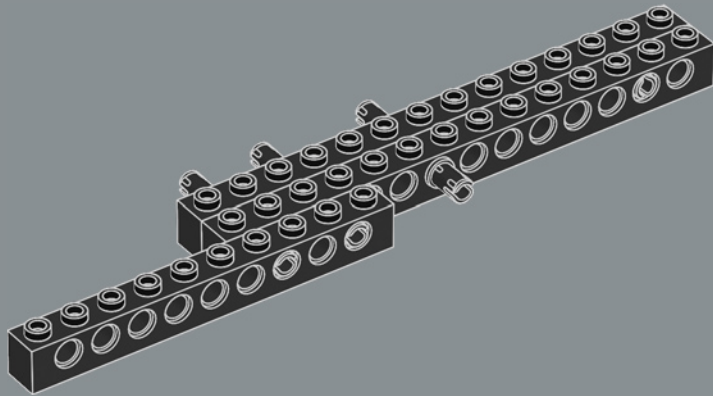

293

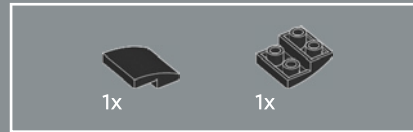
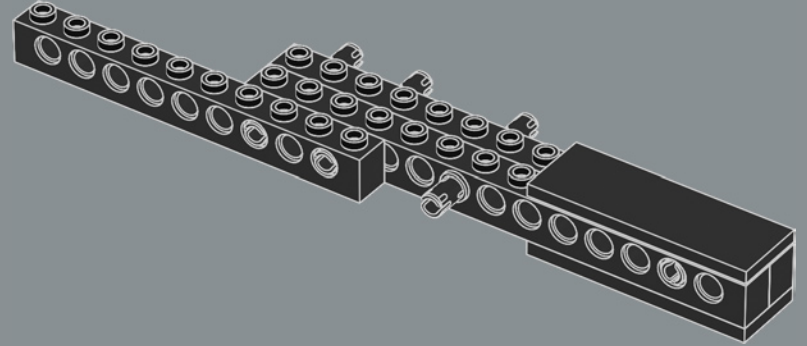

294

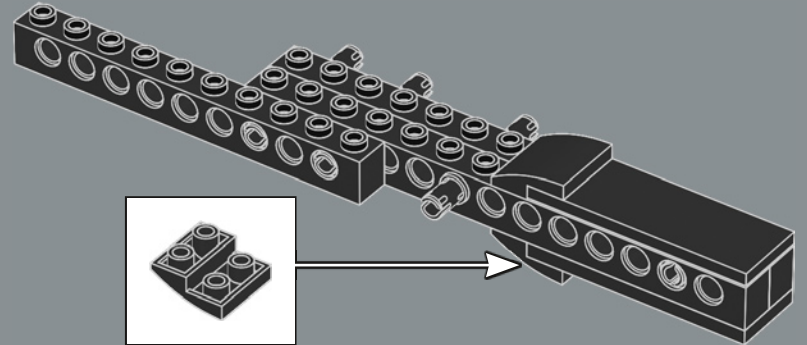

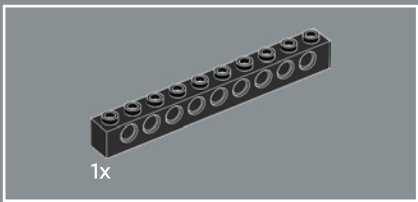

295

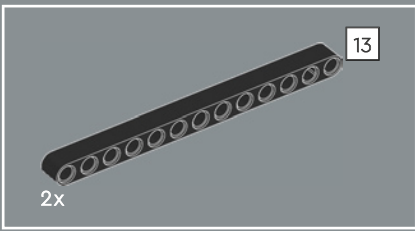
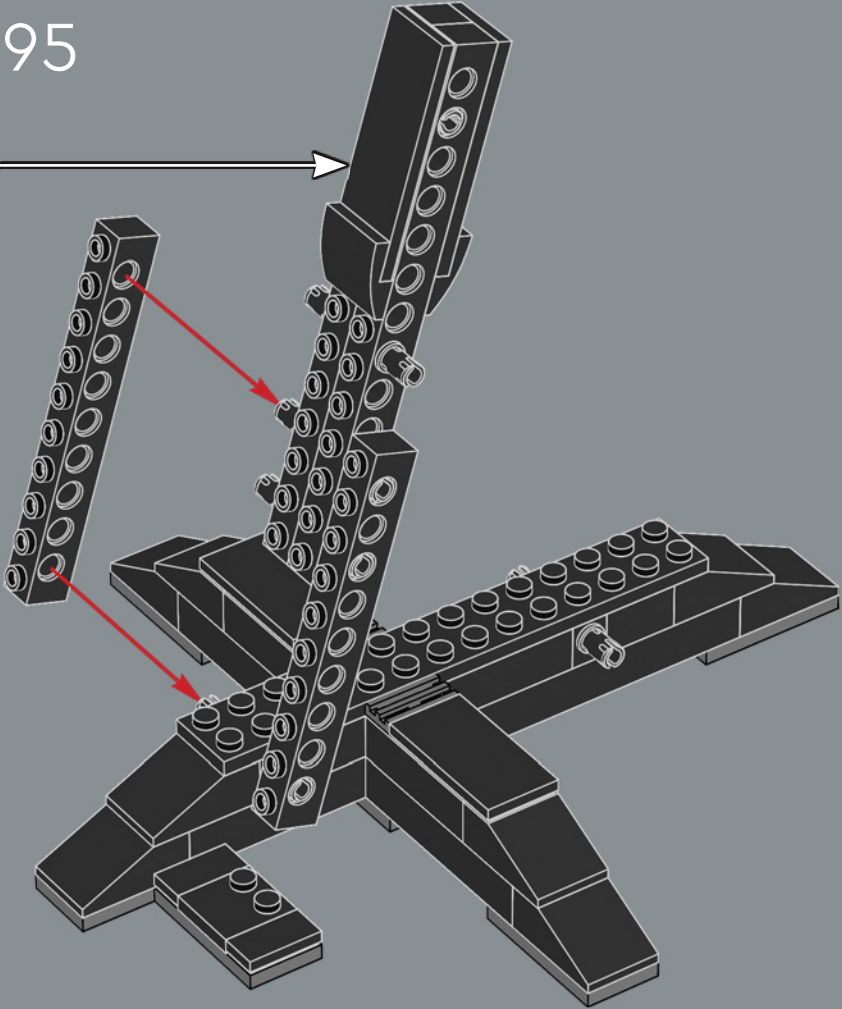

296

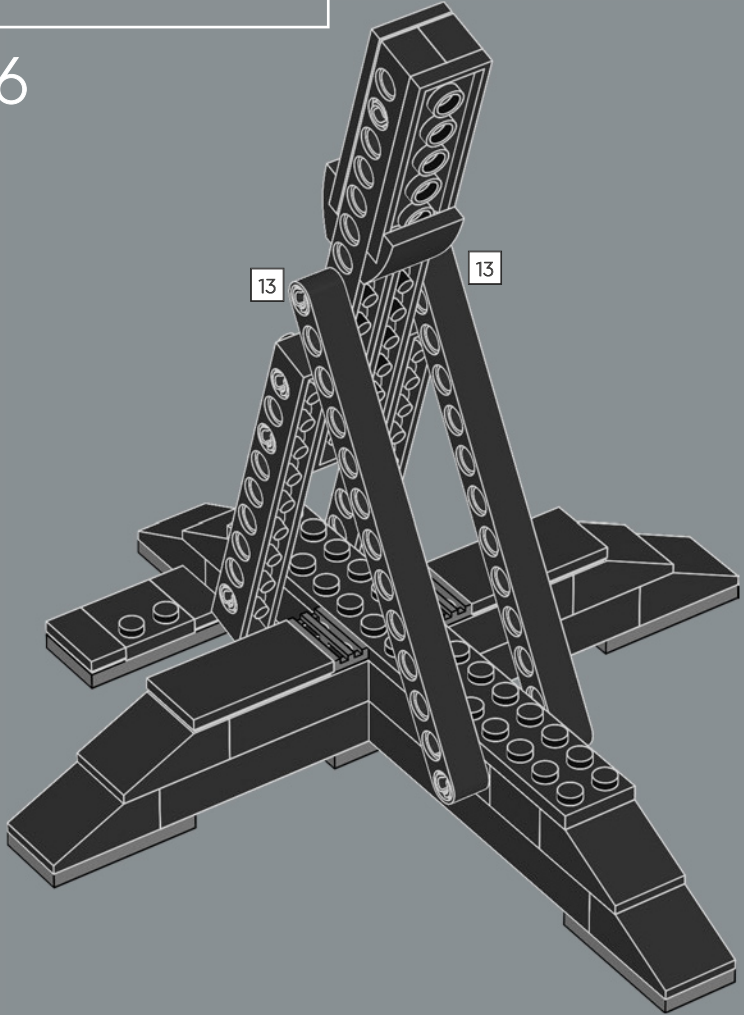



297

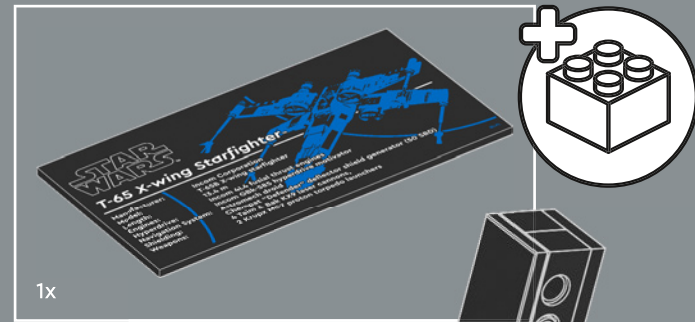
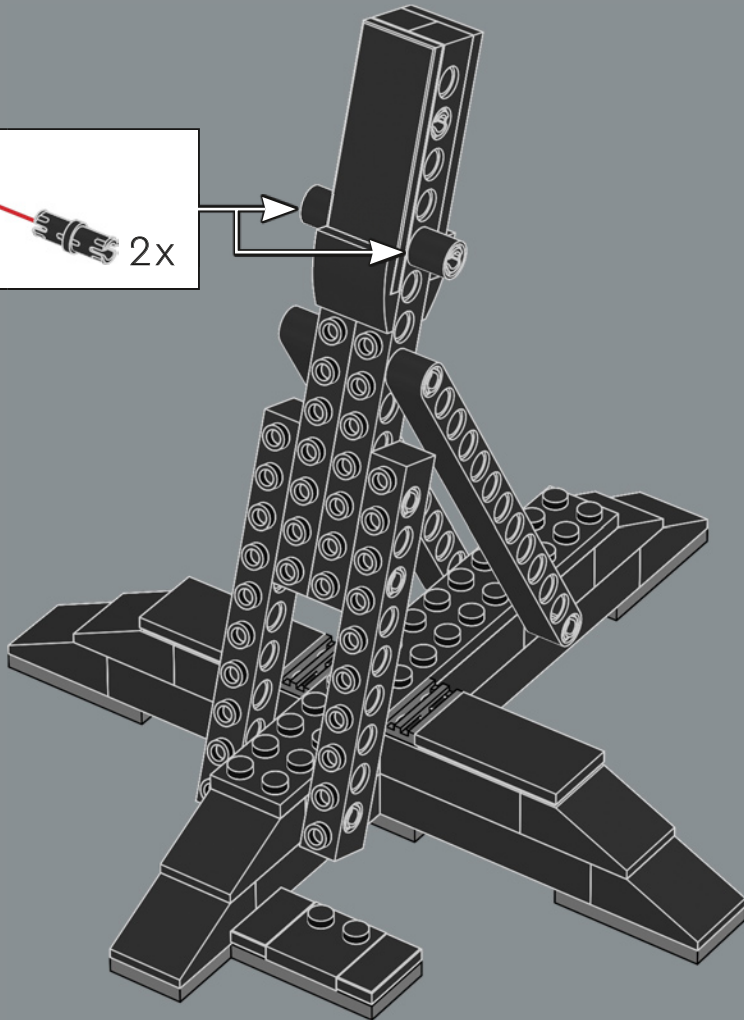
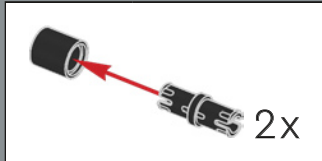

298

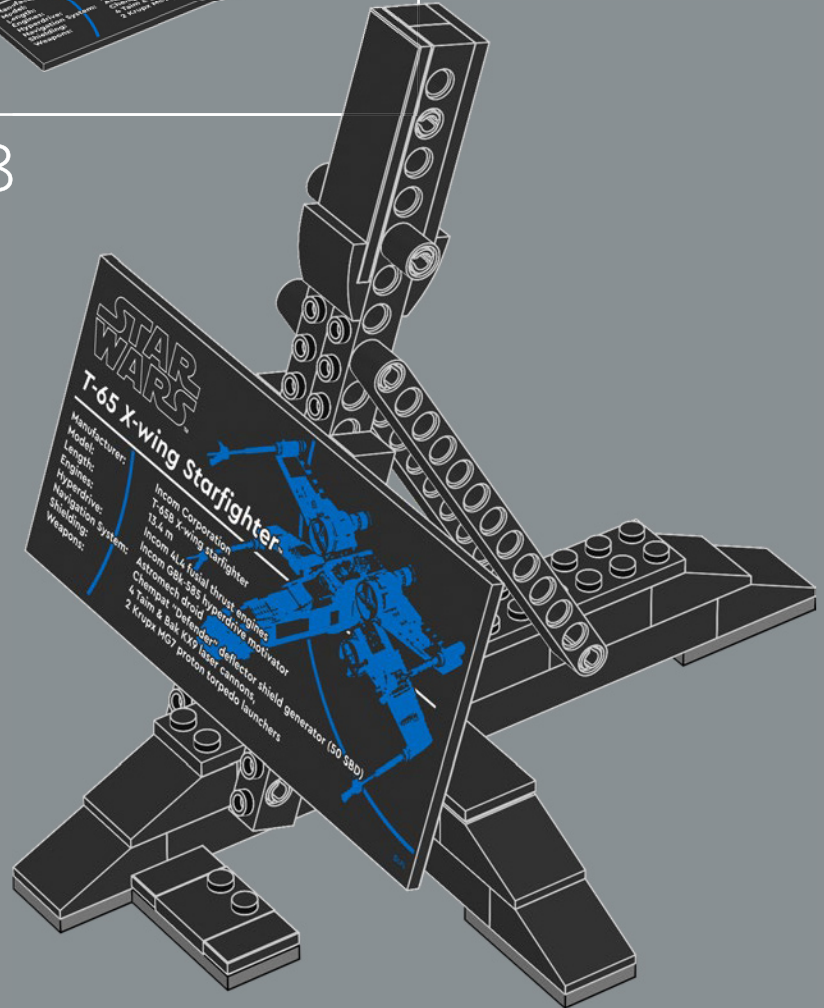

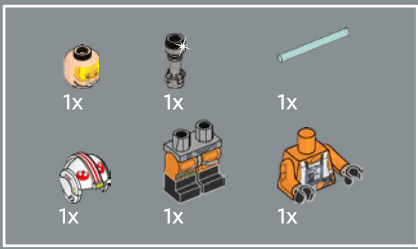

299

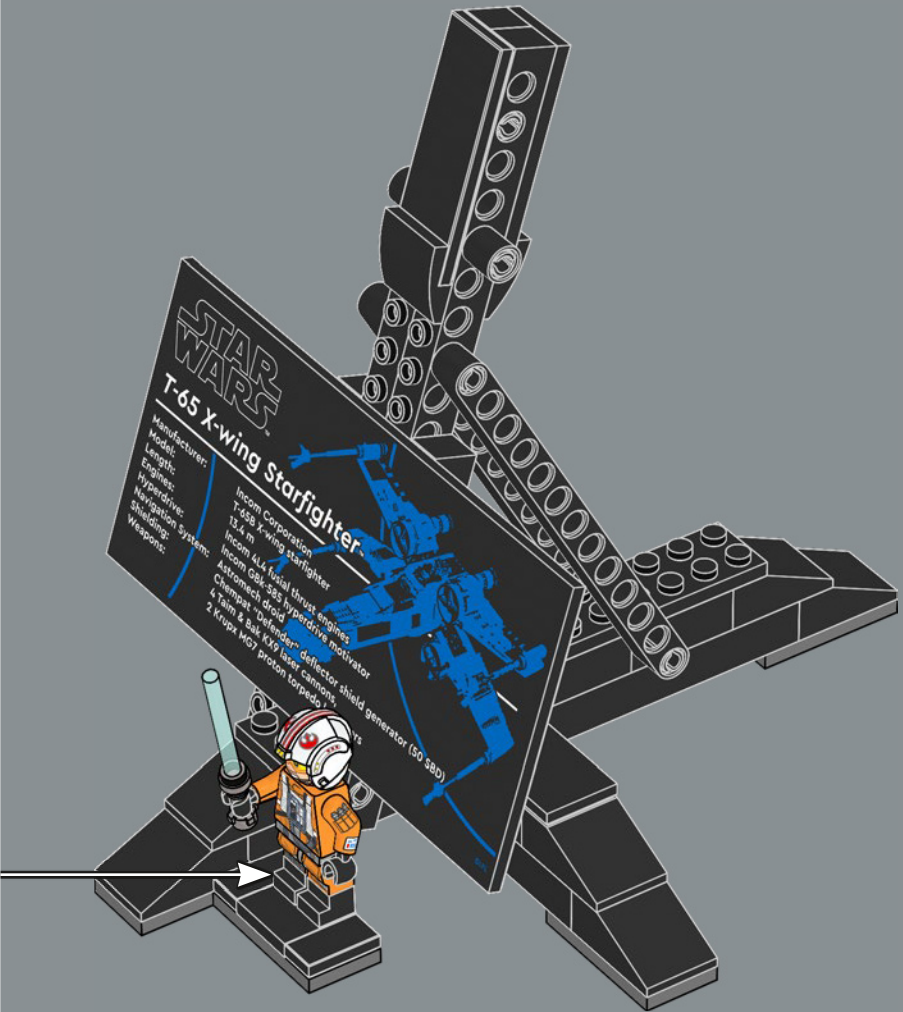
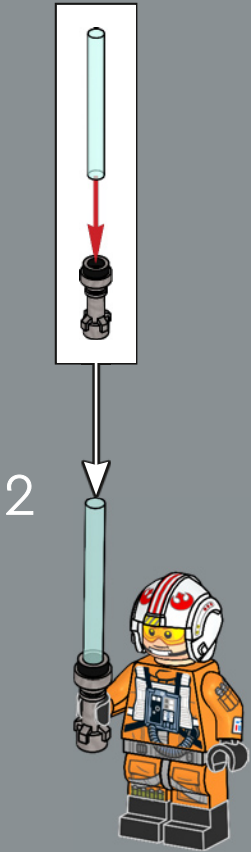
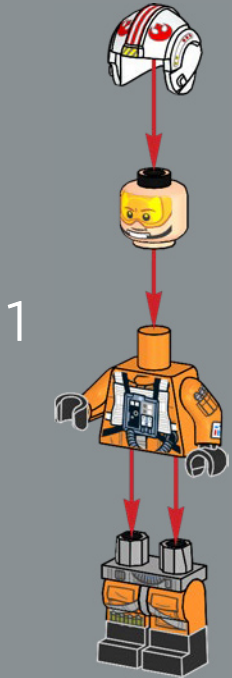

300

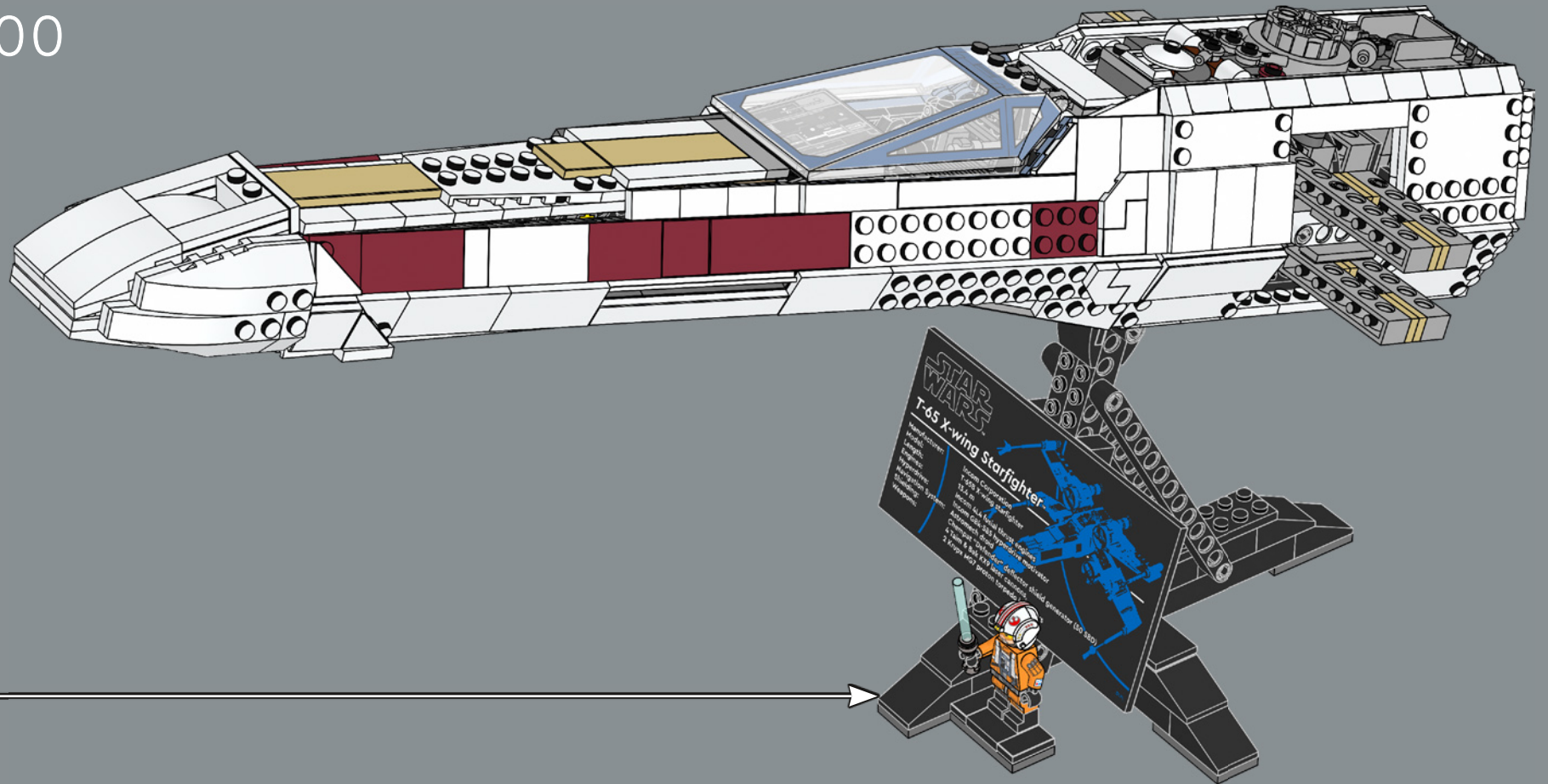



301

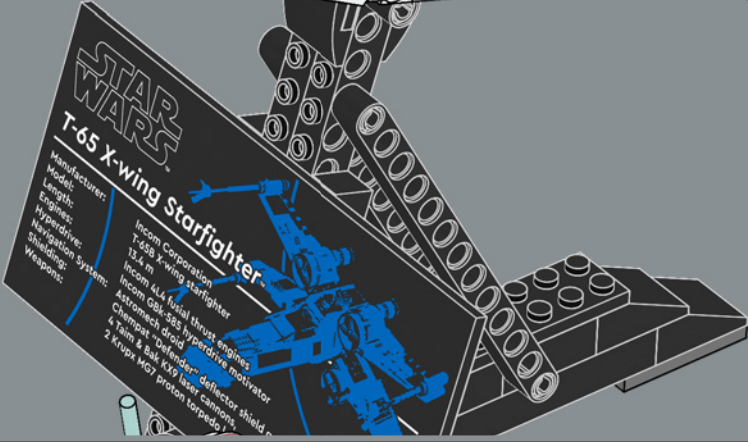
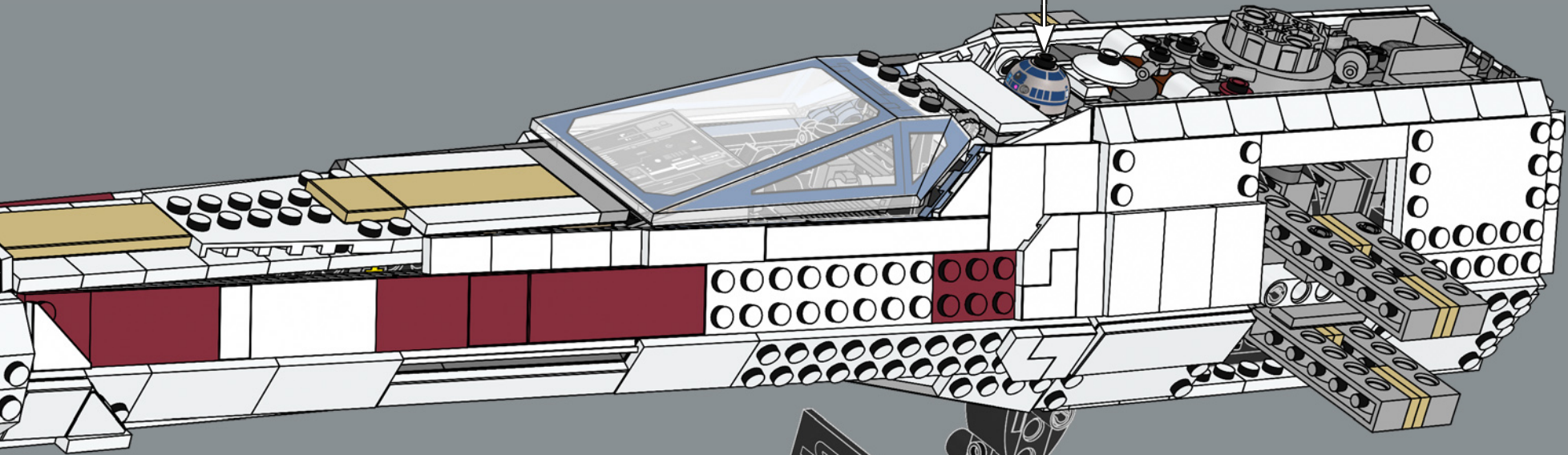
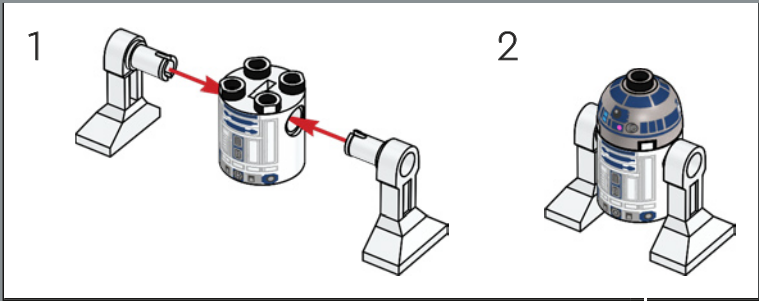

302

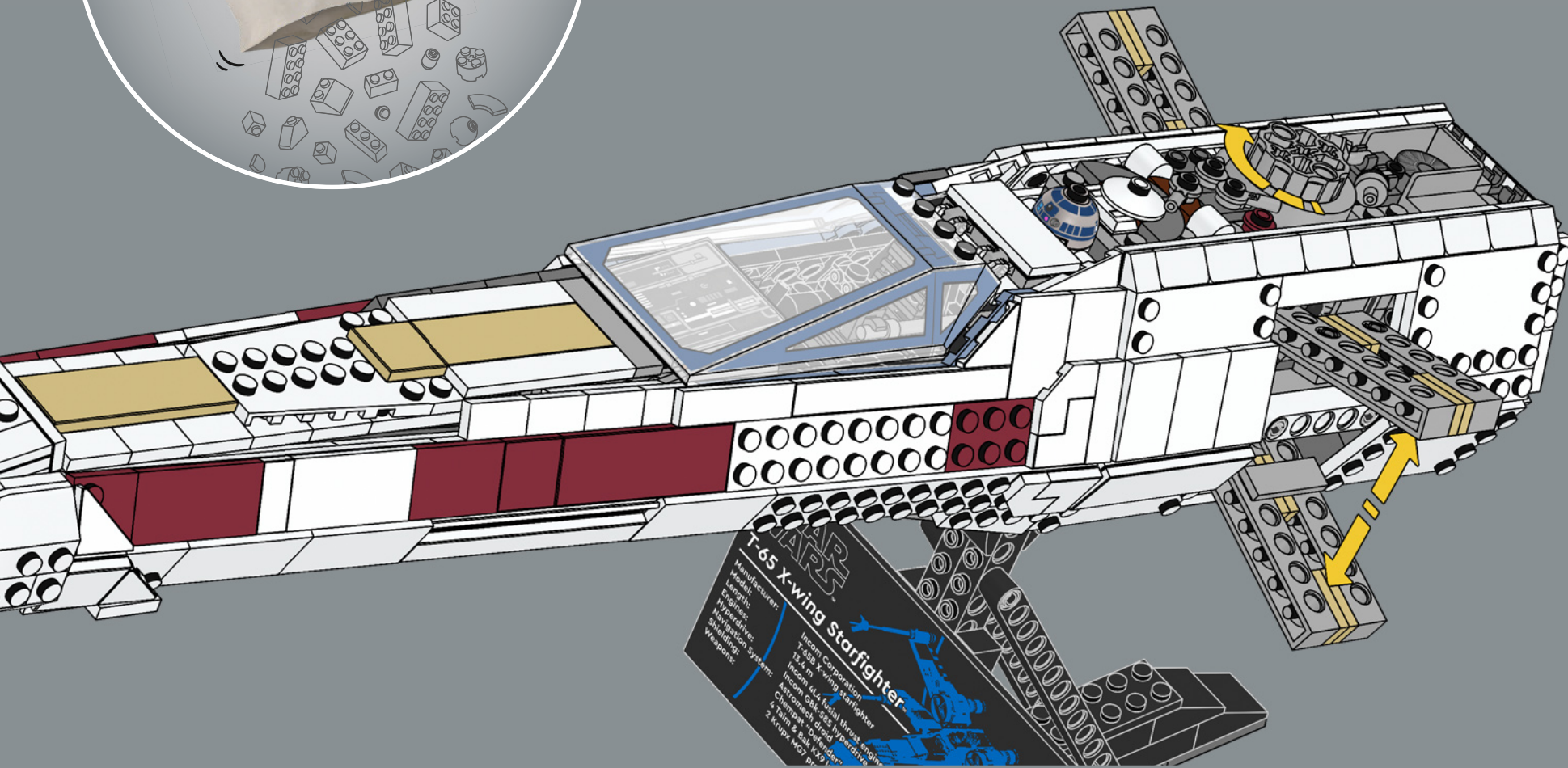

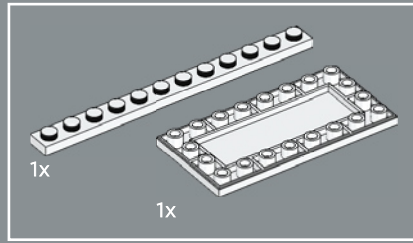
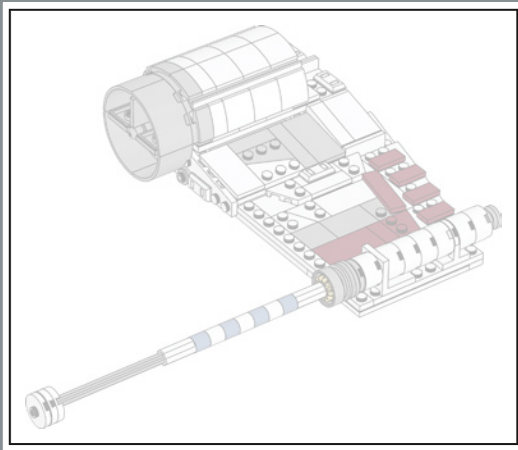

303

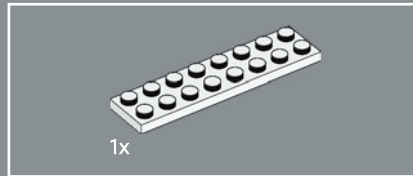
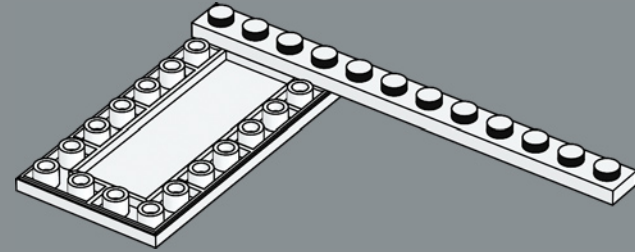

304

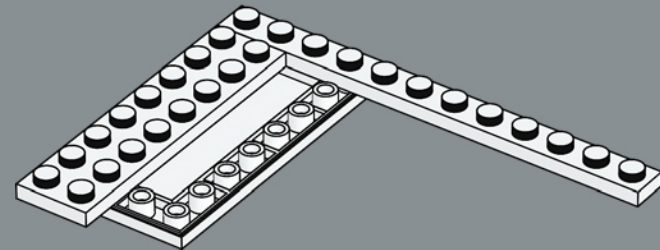

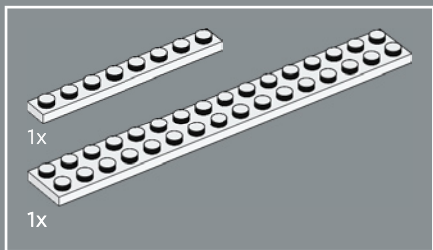

305

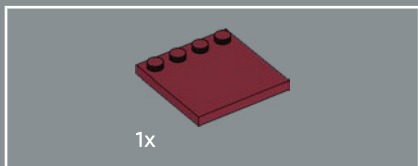
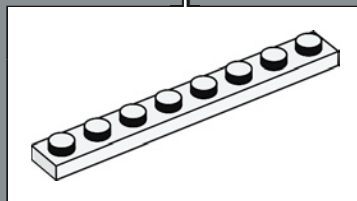
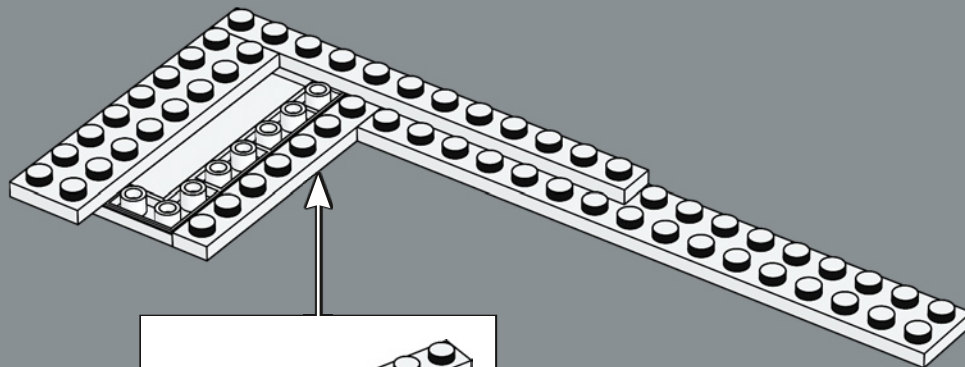

306

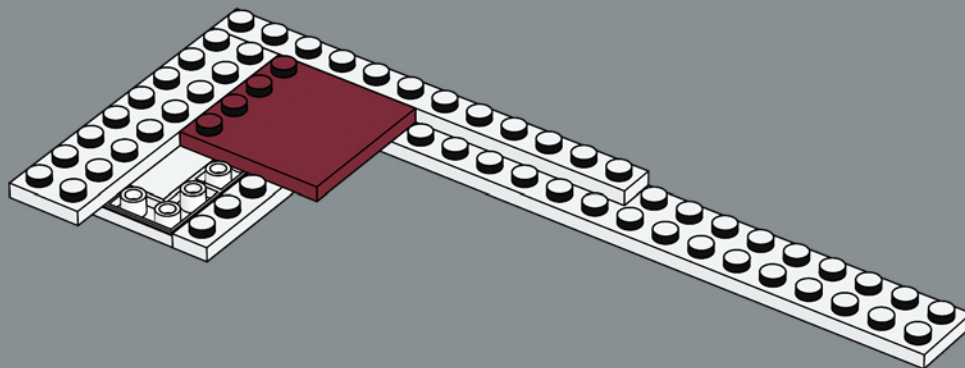

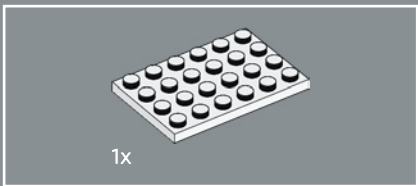

307

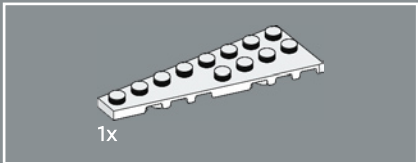
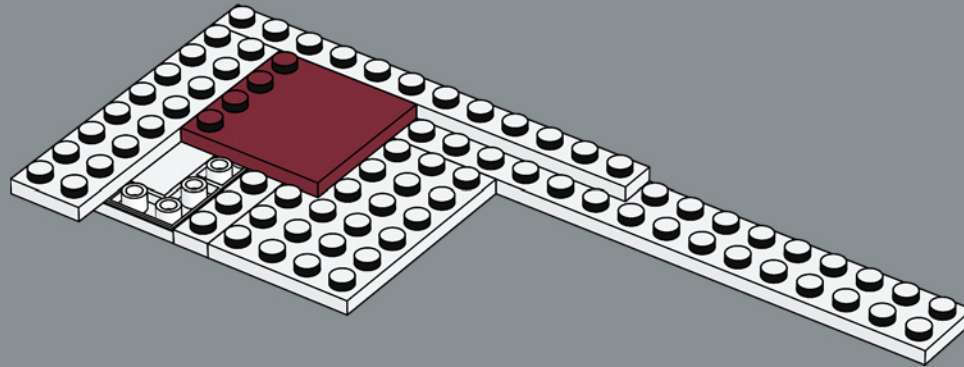

308

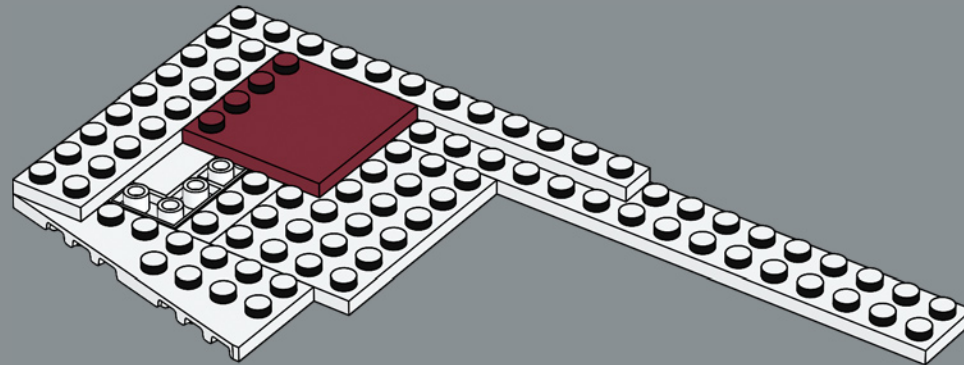

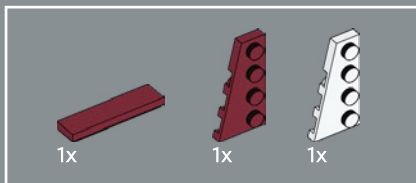

309

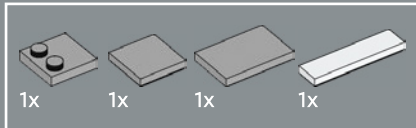
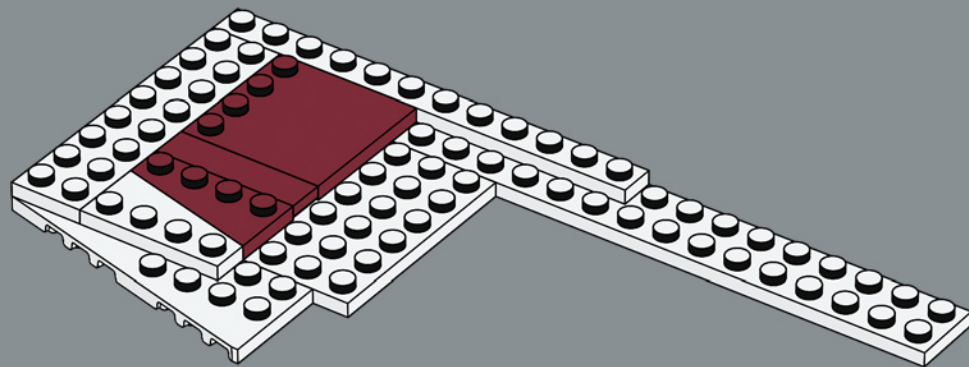

310

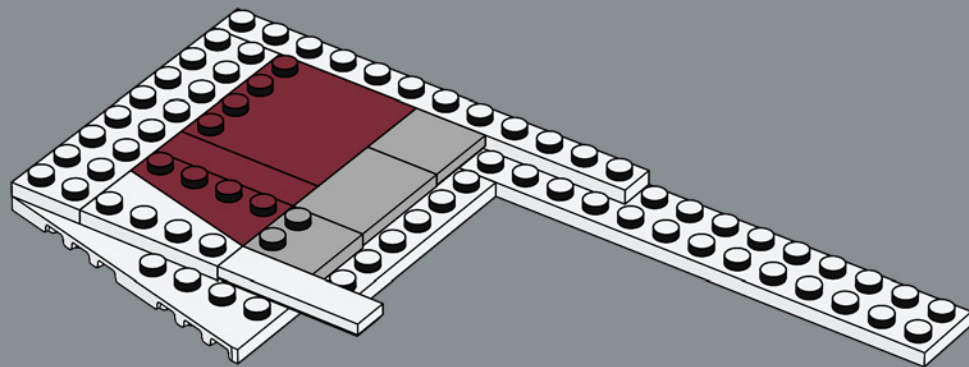

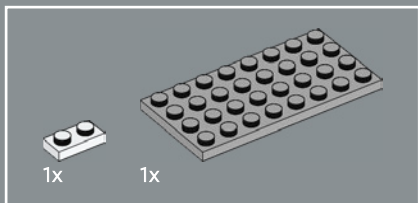

311

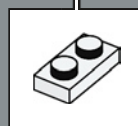
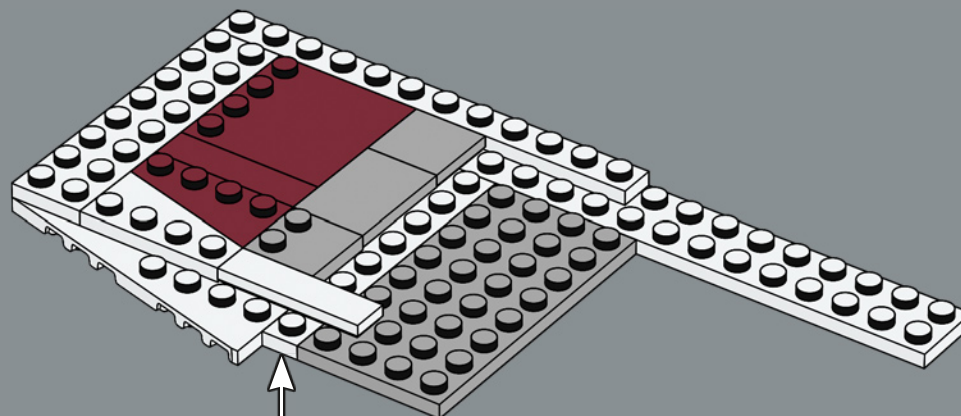

312

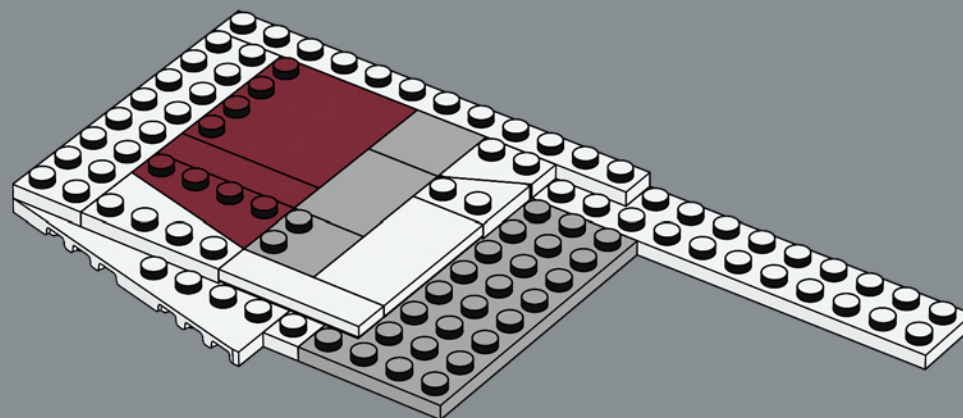

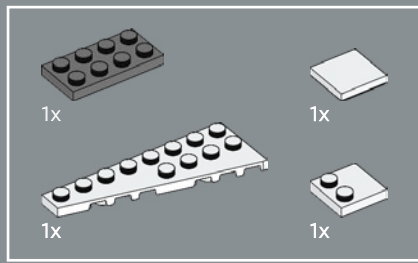

313

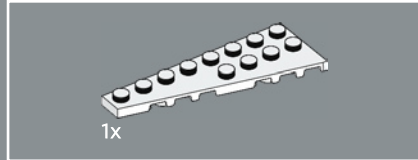
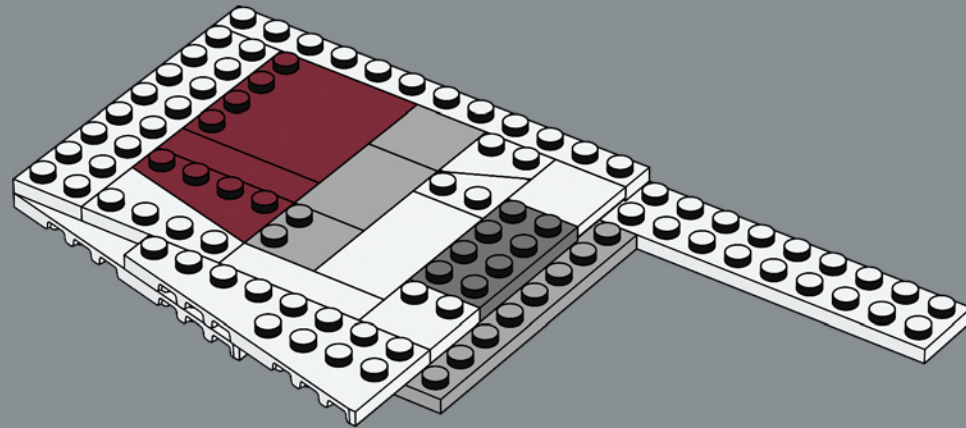

314

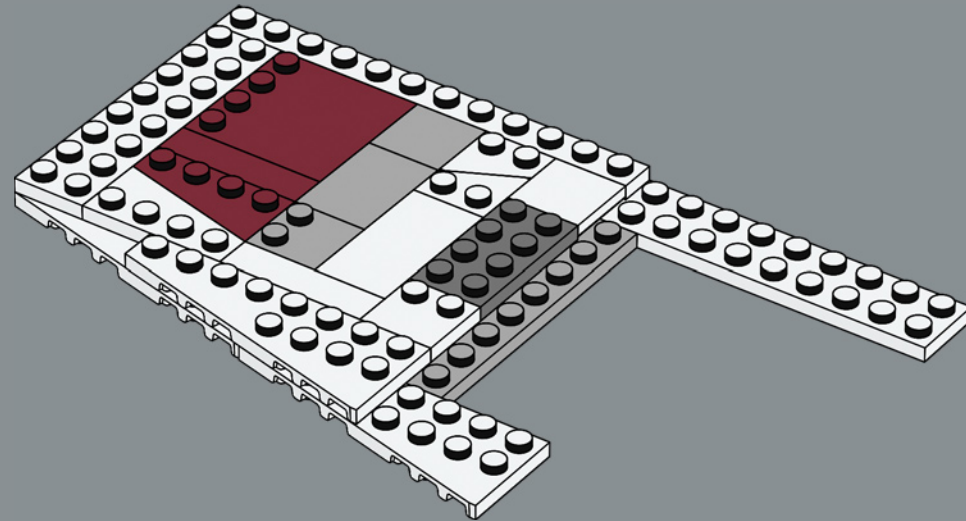

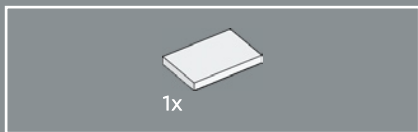

315

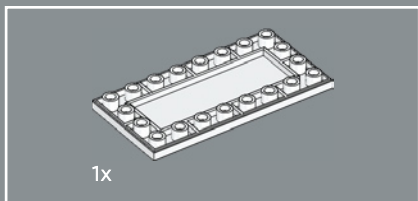
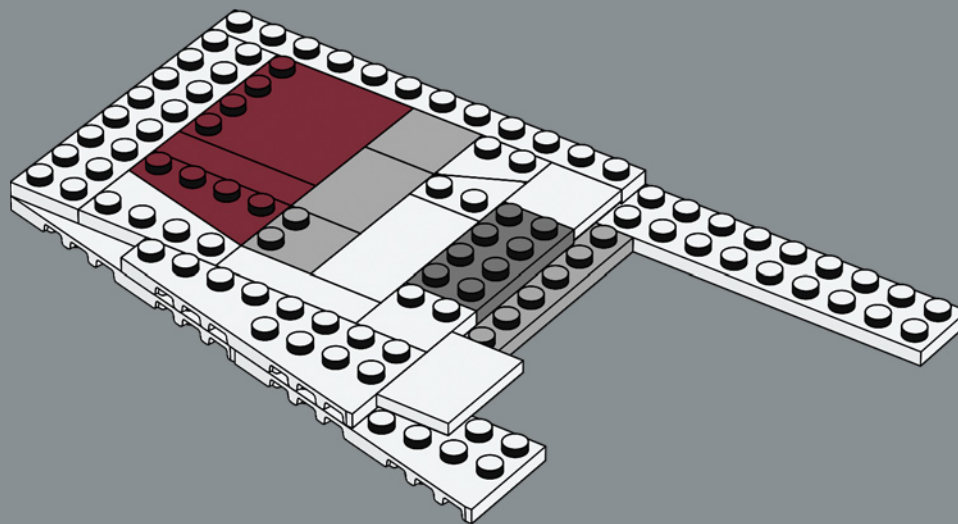

316

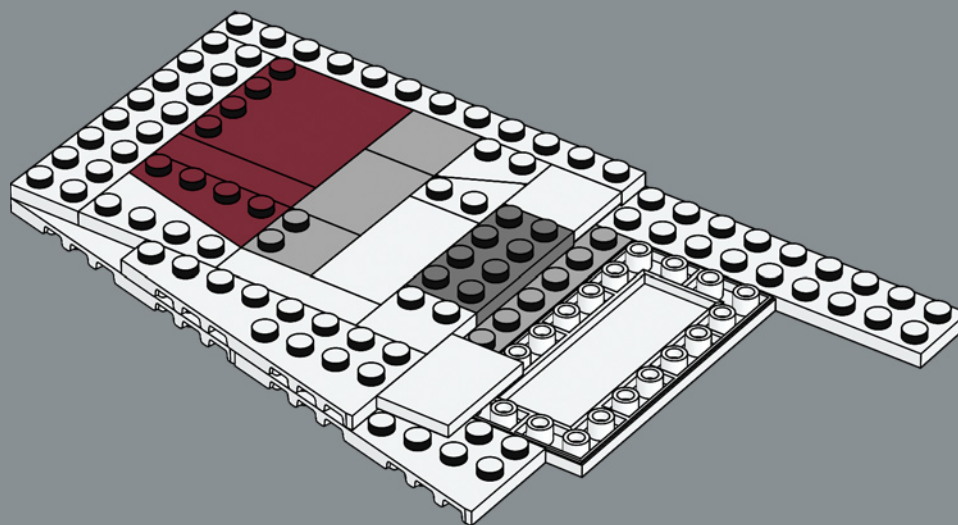

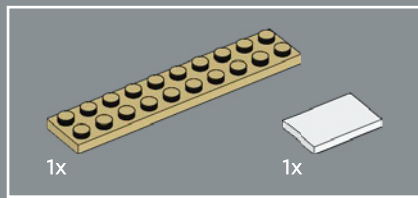

317

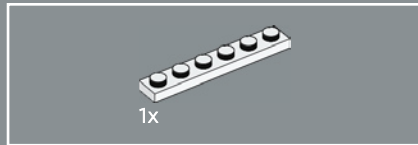
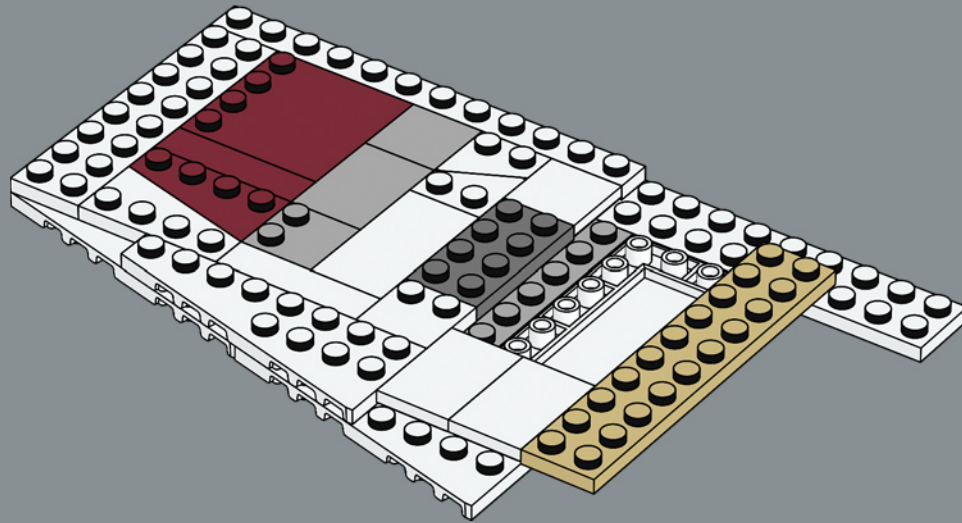

318

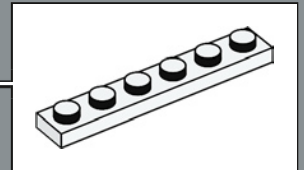
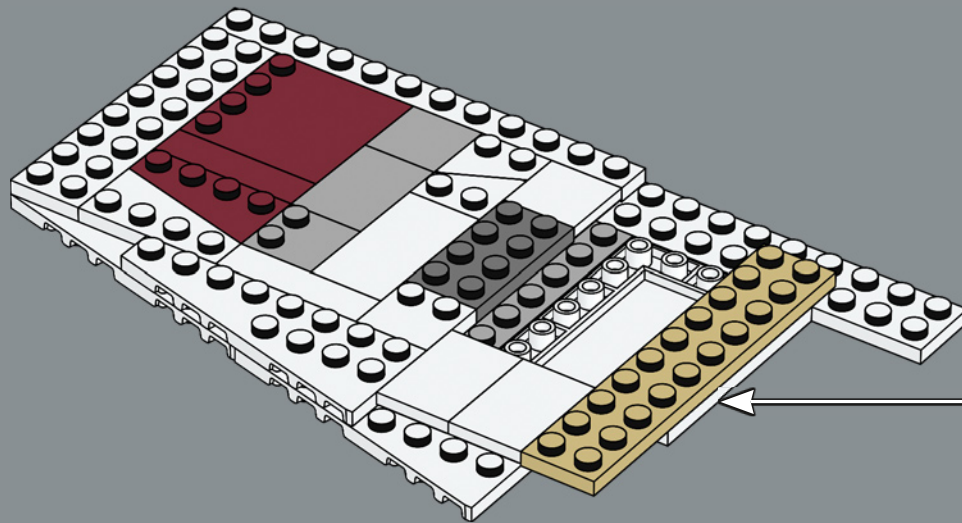

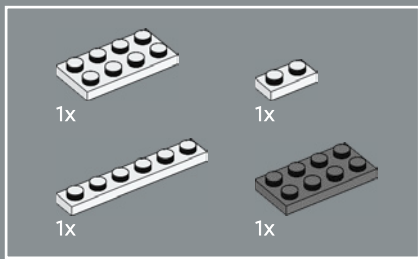

319

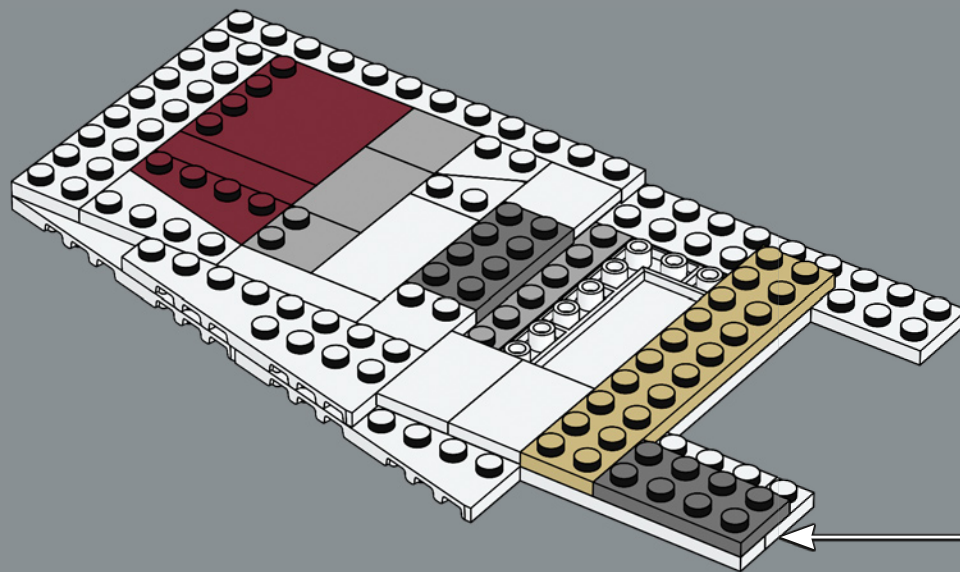
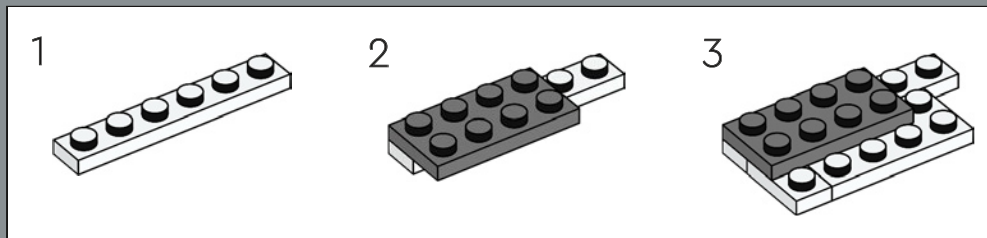

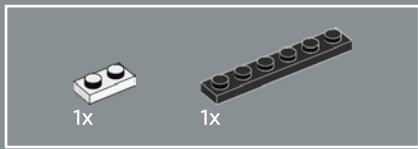

320

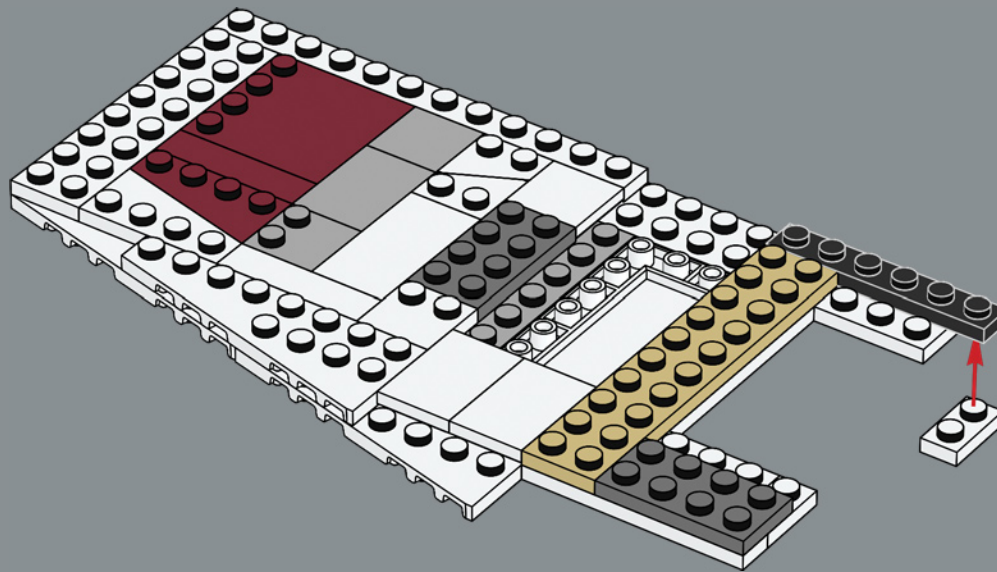

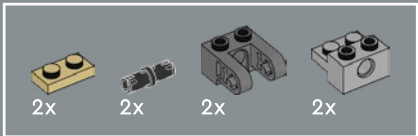

321

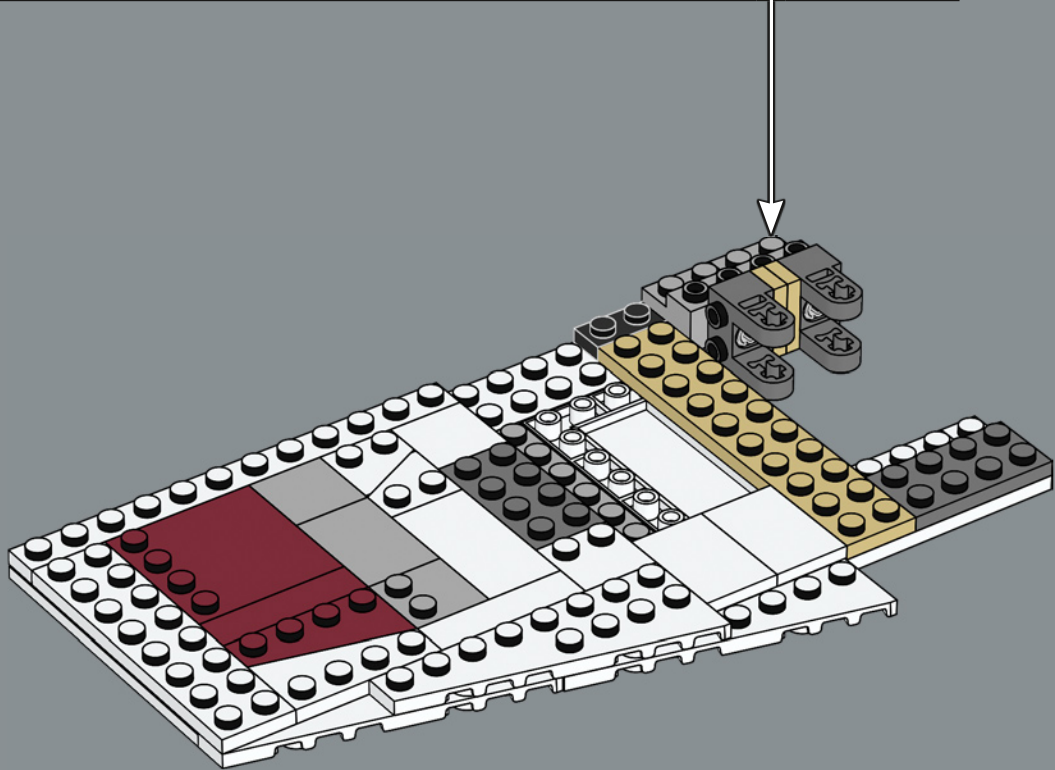
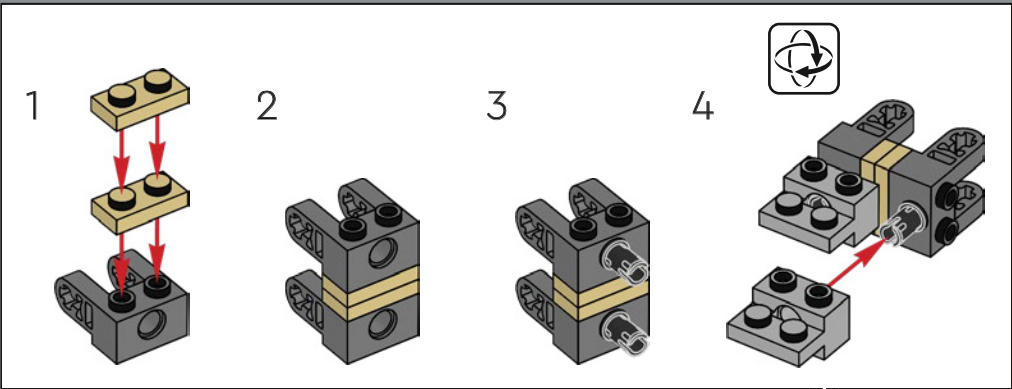

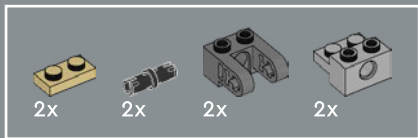

322

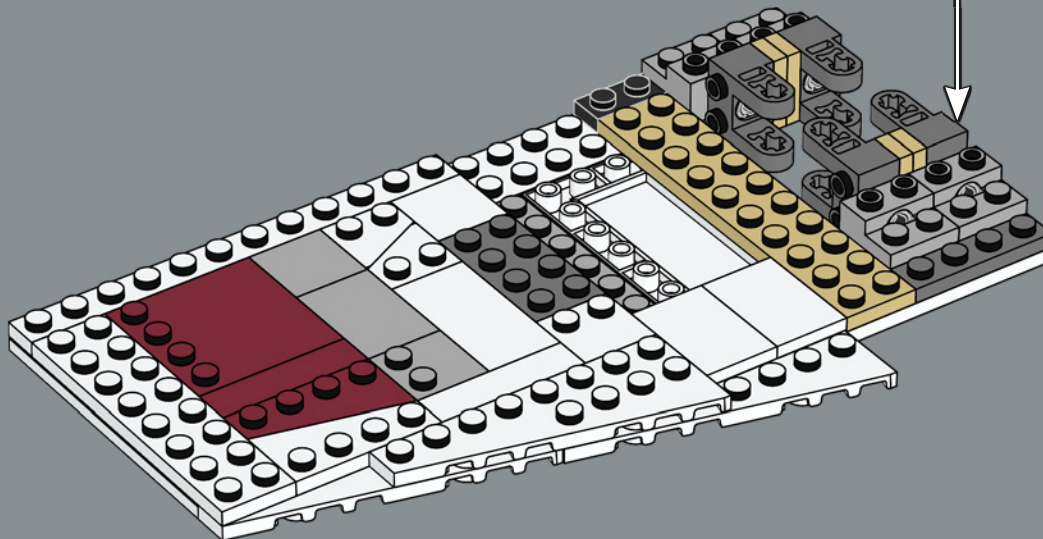
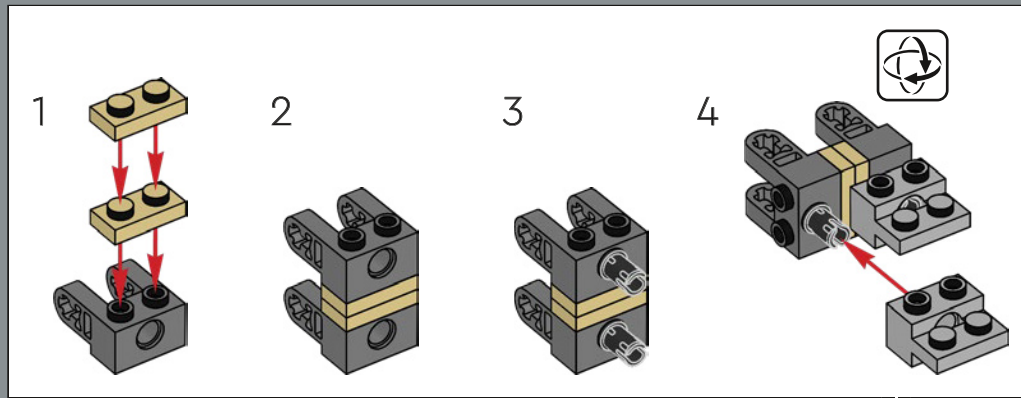

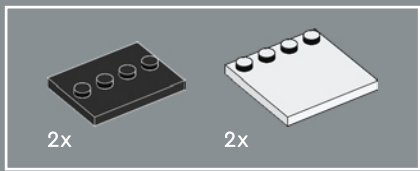

323

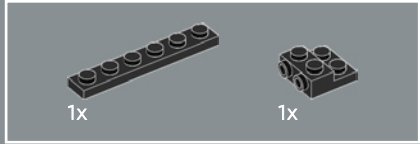
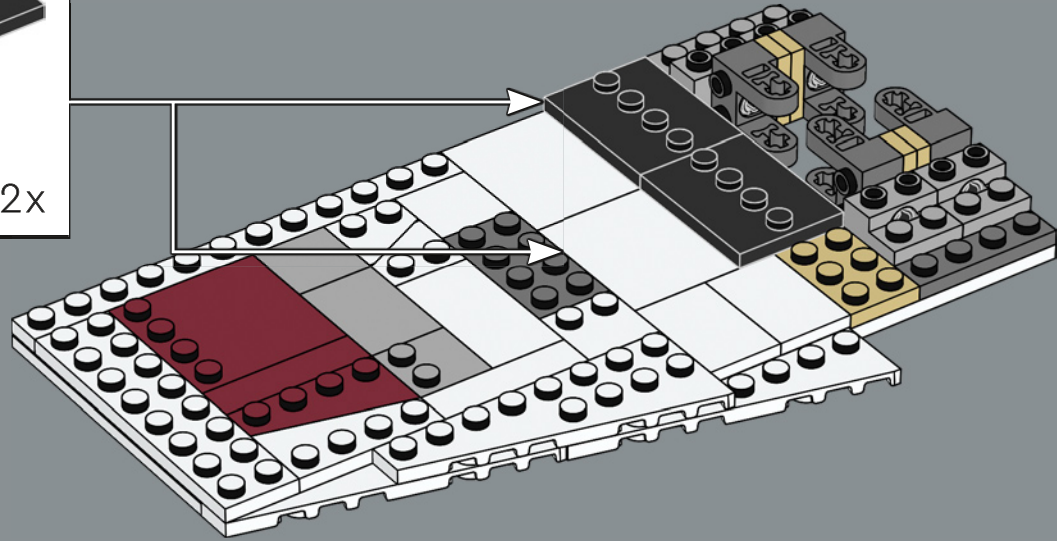
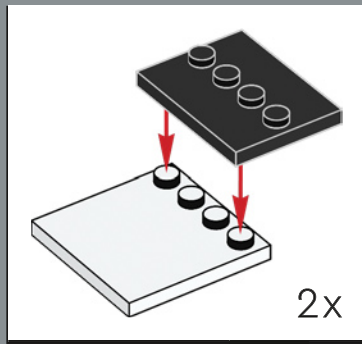

324

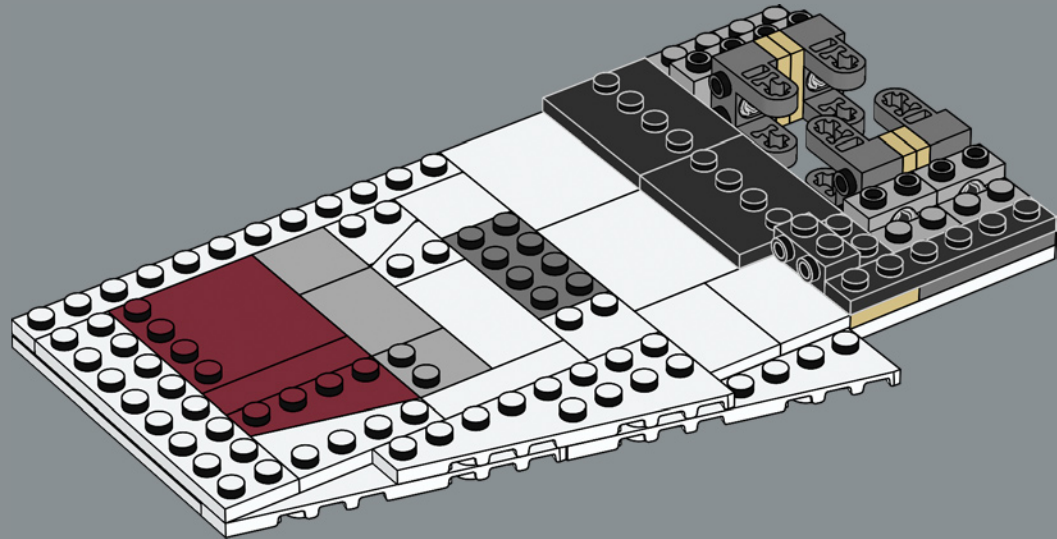

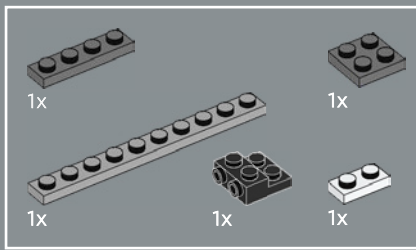

325

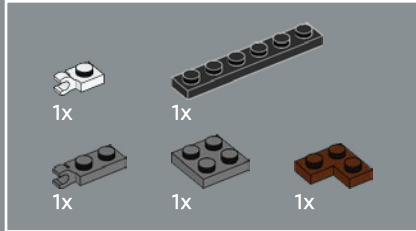
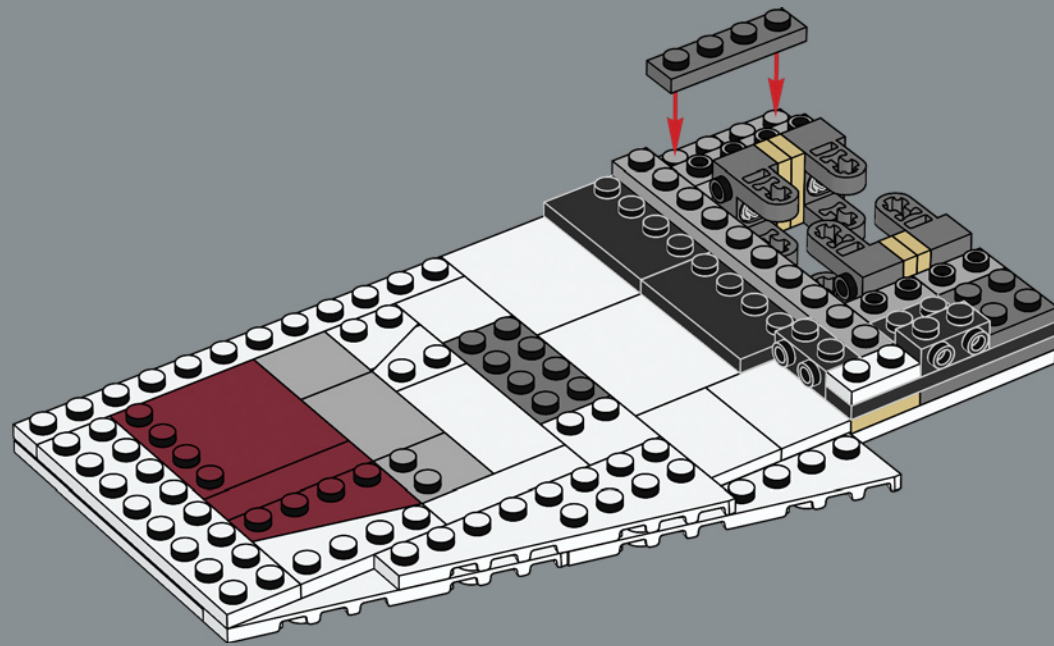

326

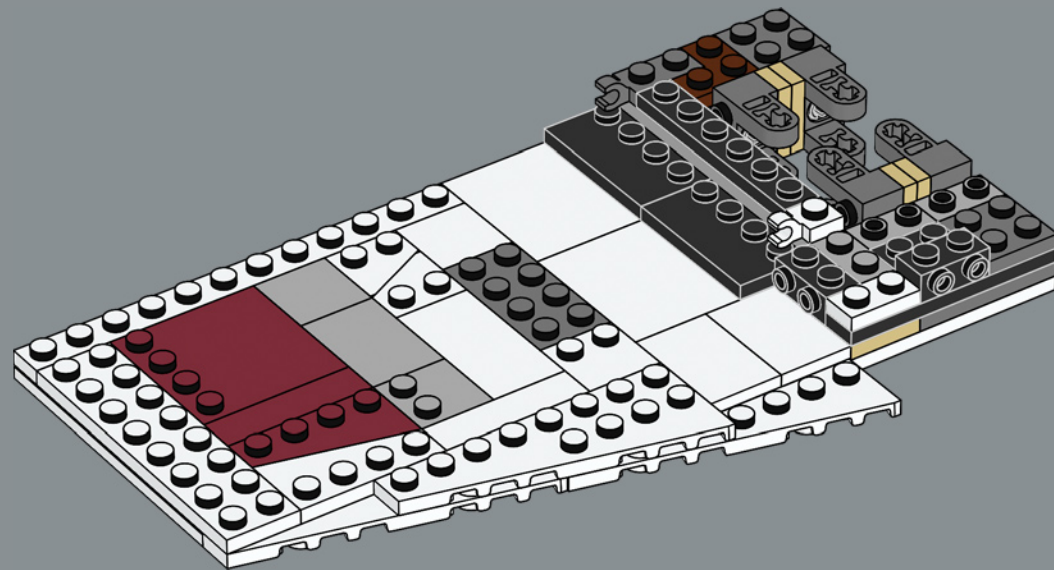

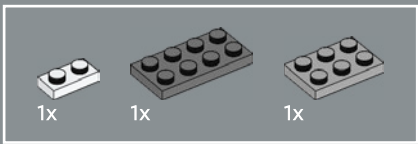

327

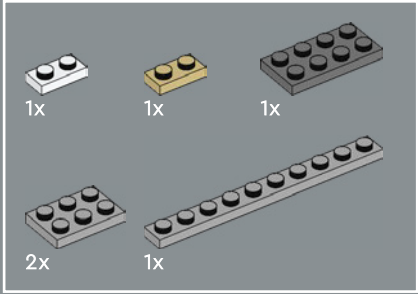
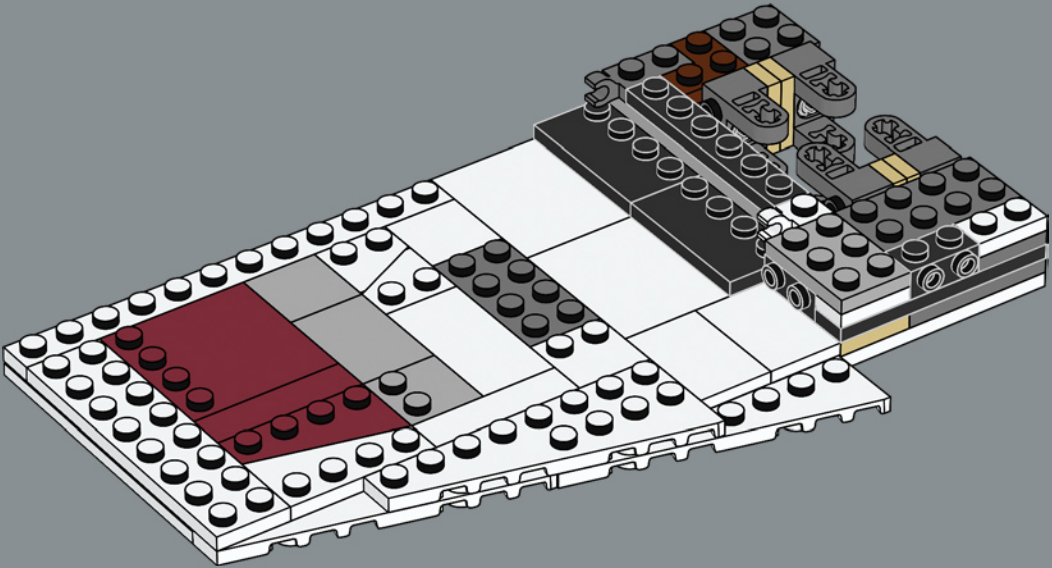

328

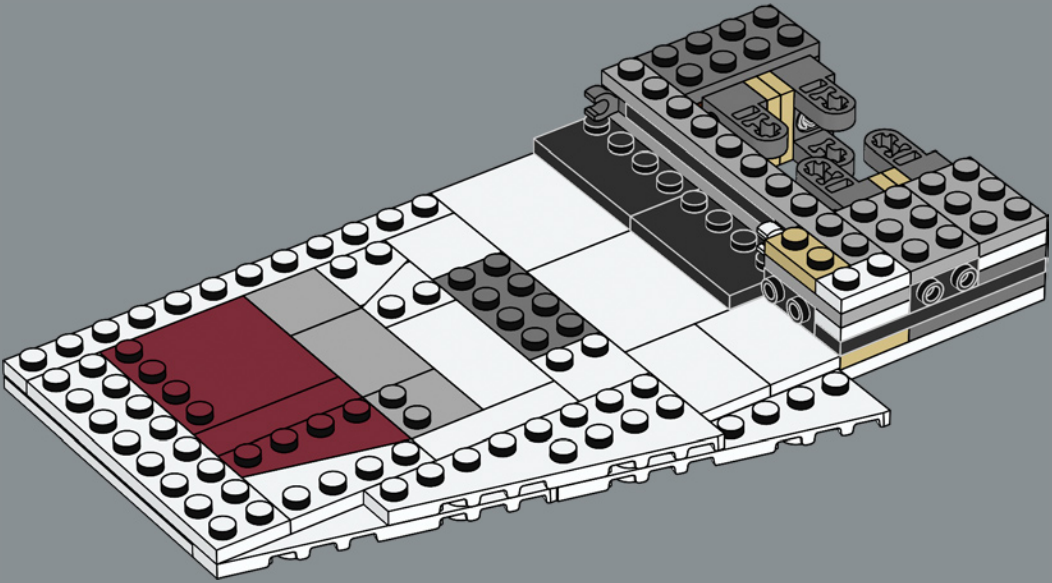

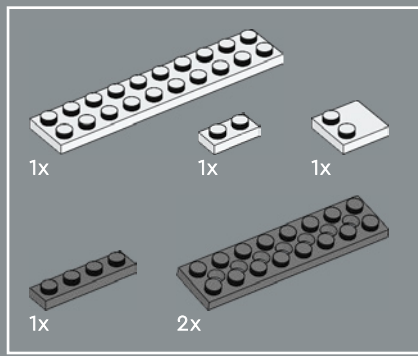

329

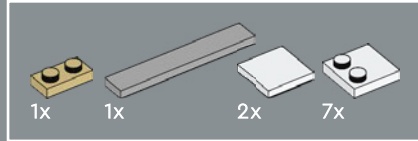
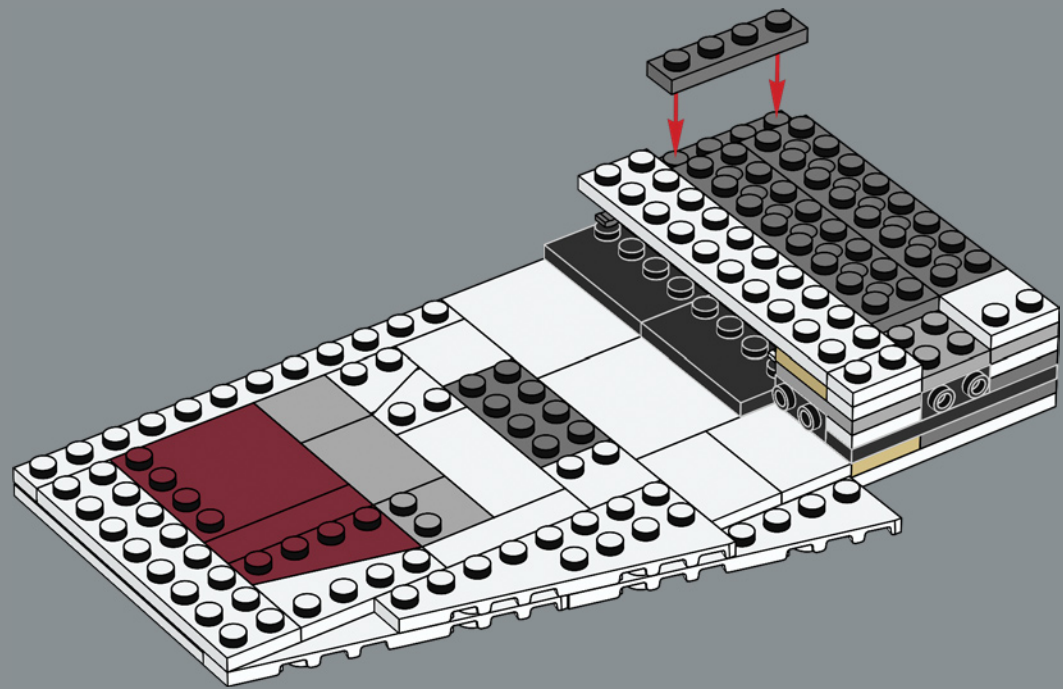

330

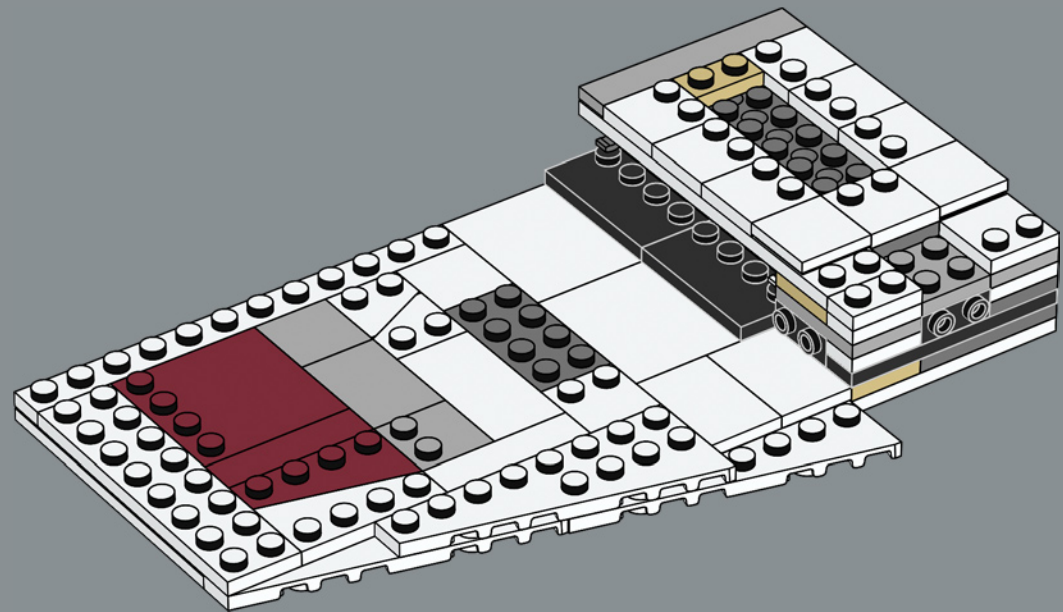

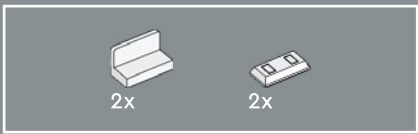

331

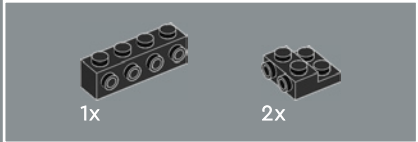
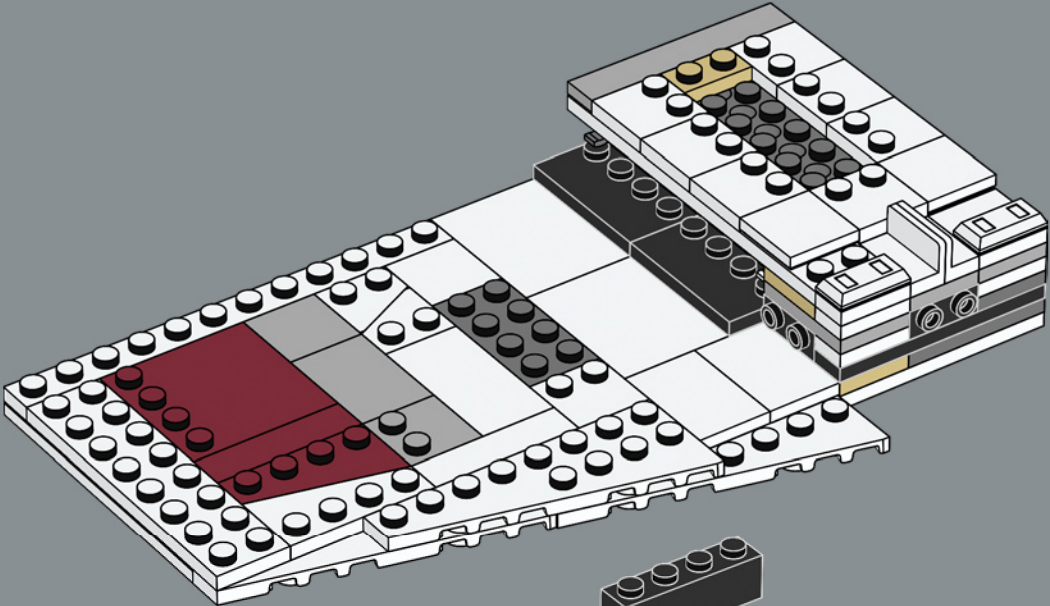

332

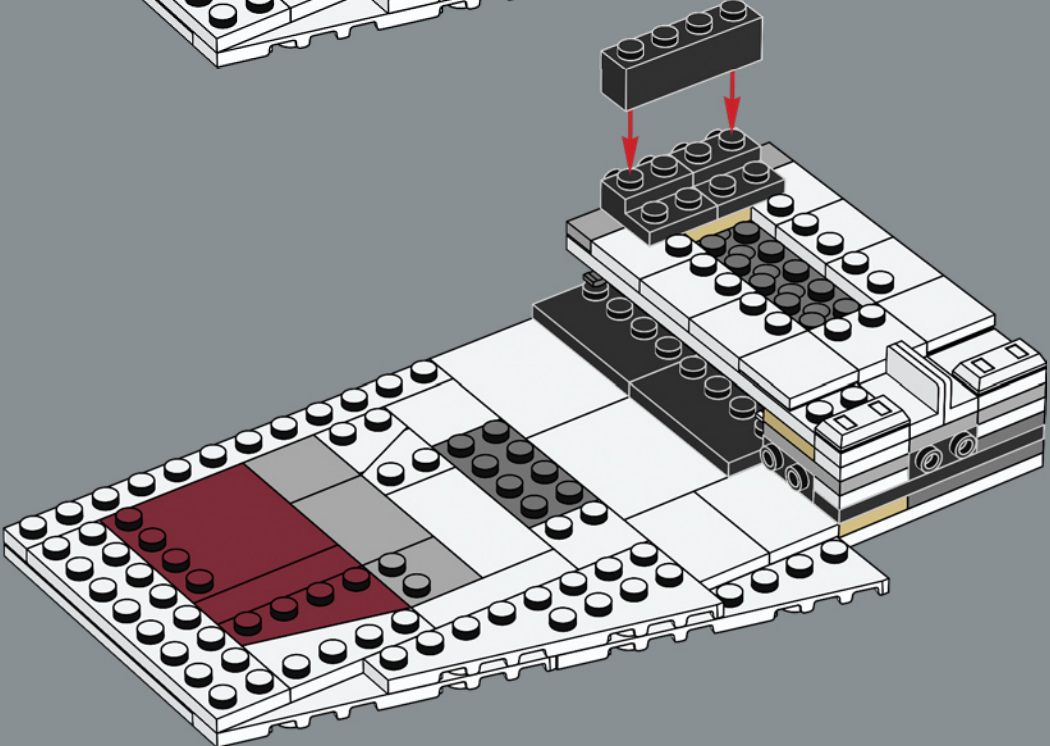

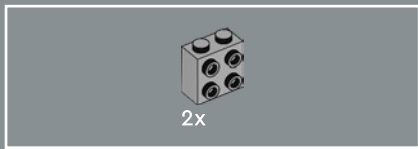

333

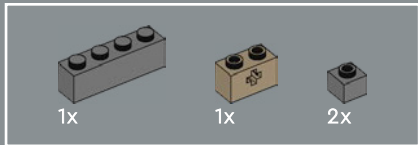
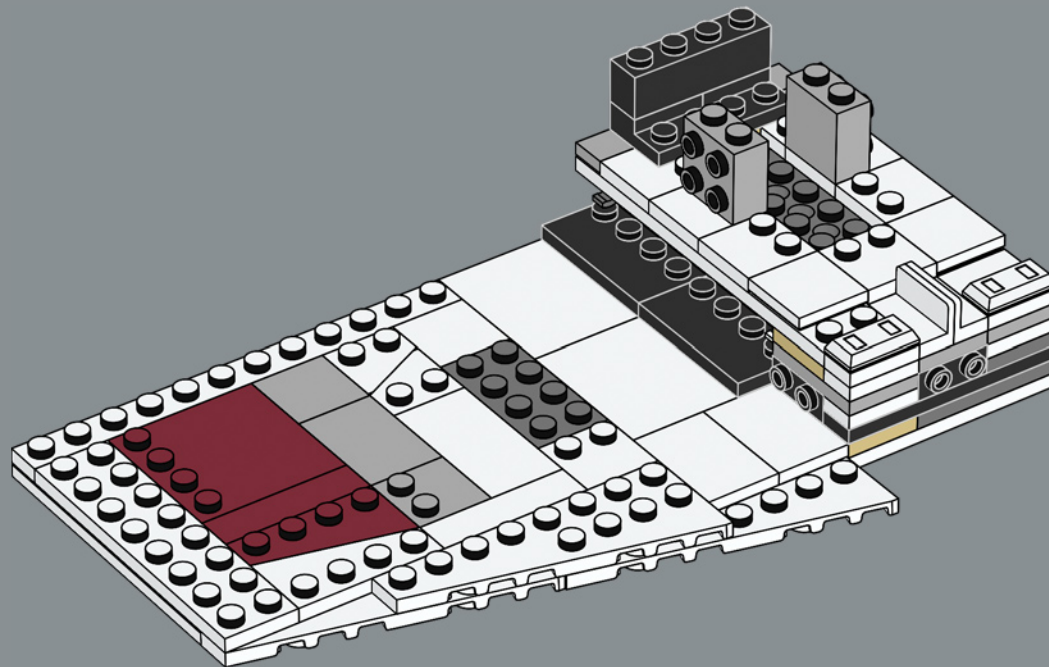

334

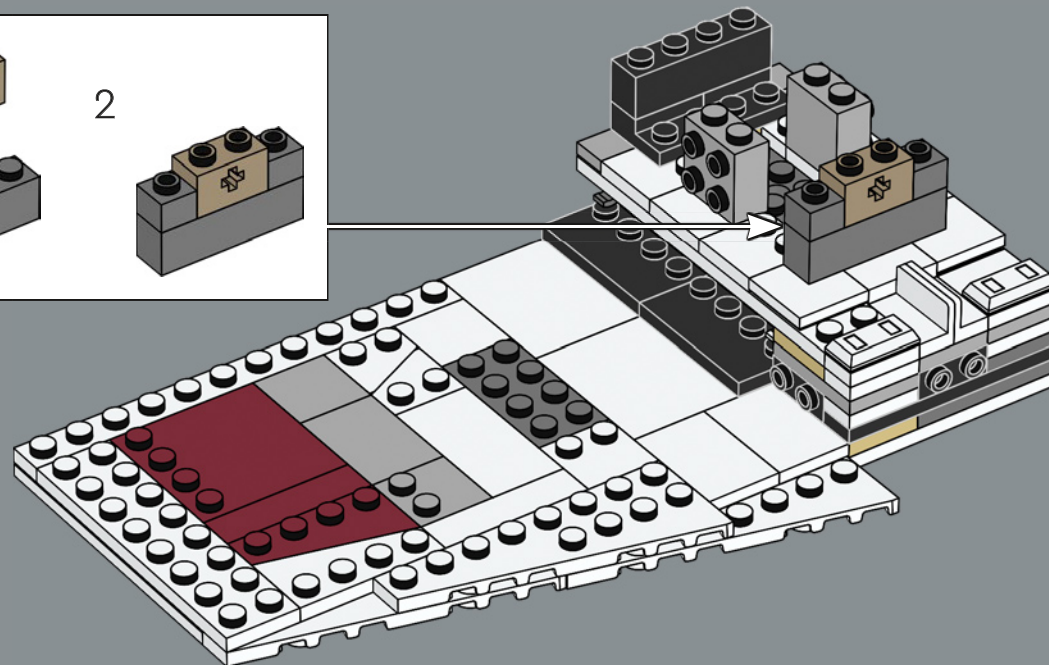
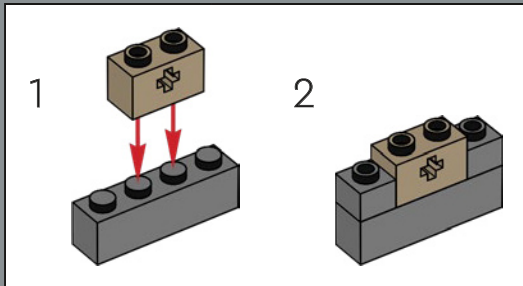

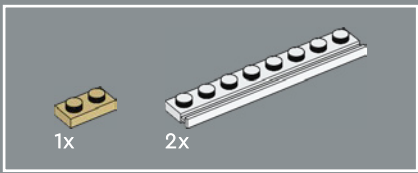

335

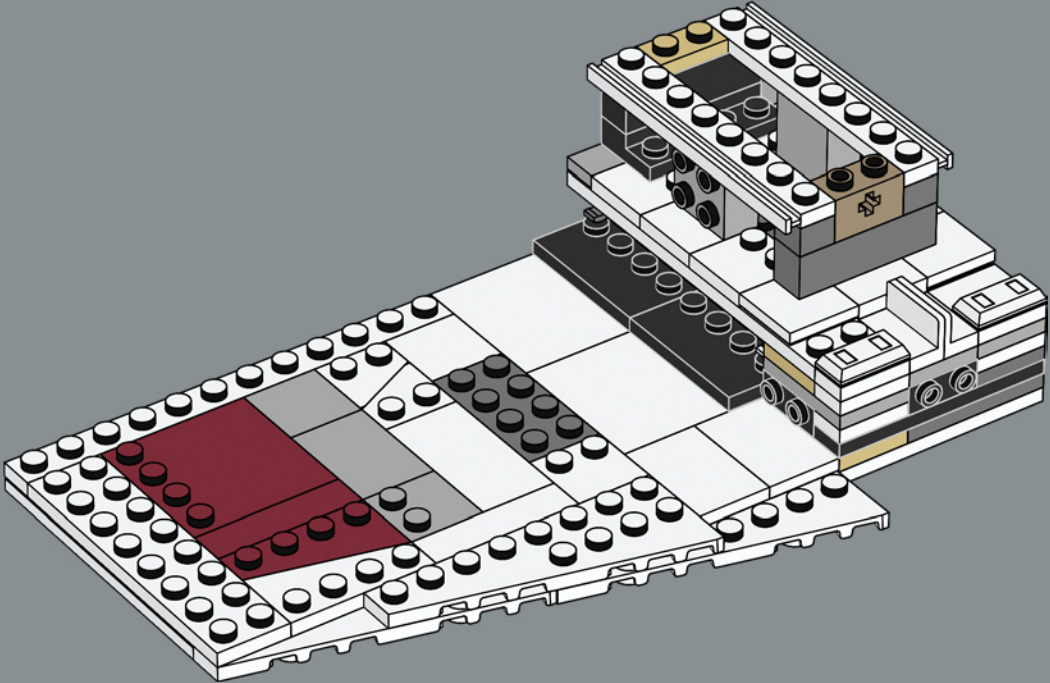

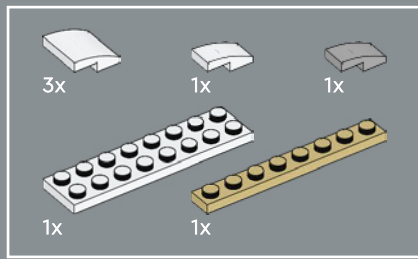

336

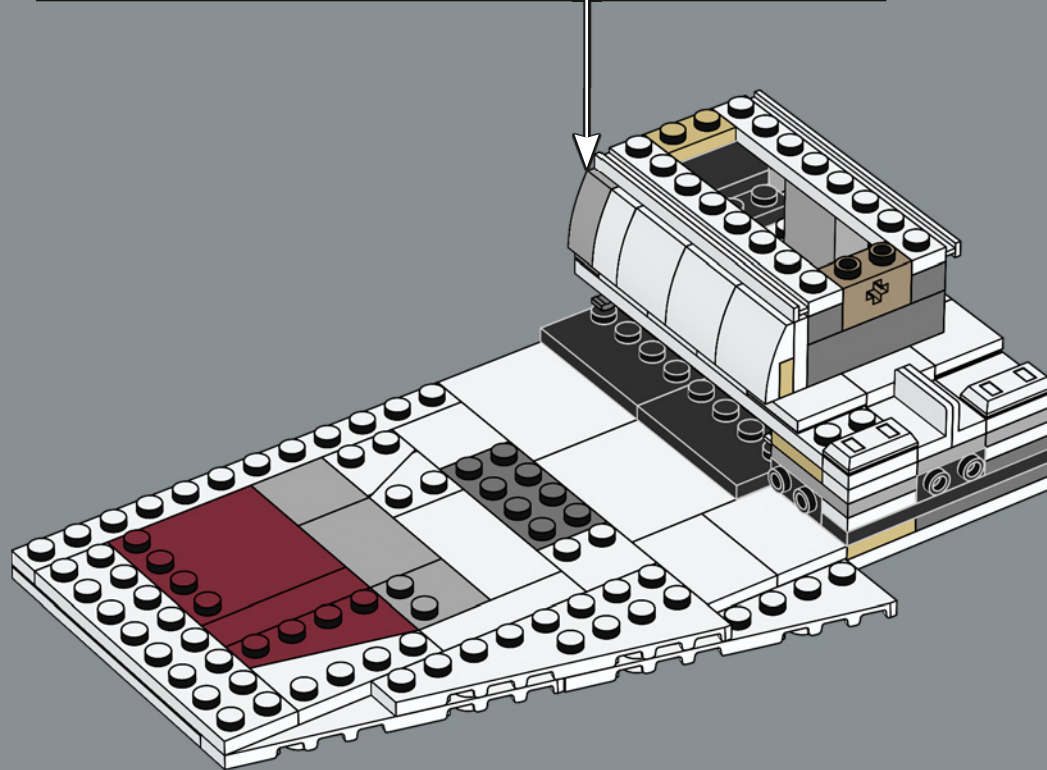
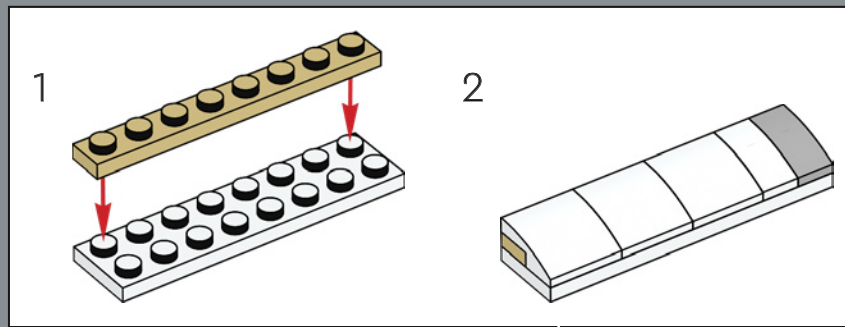

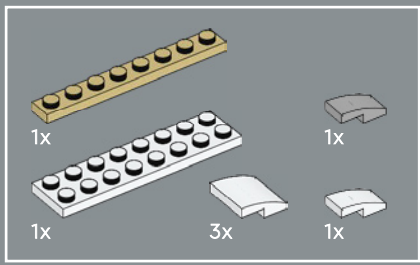

337

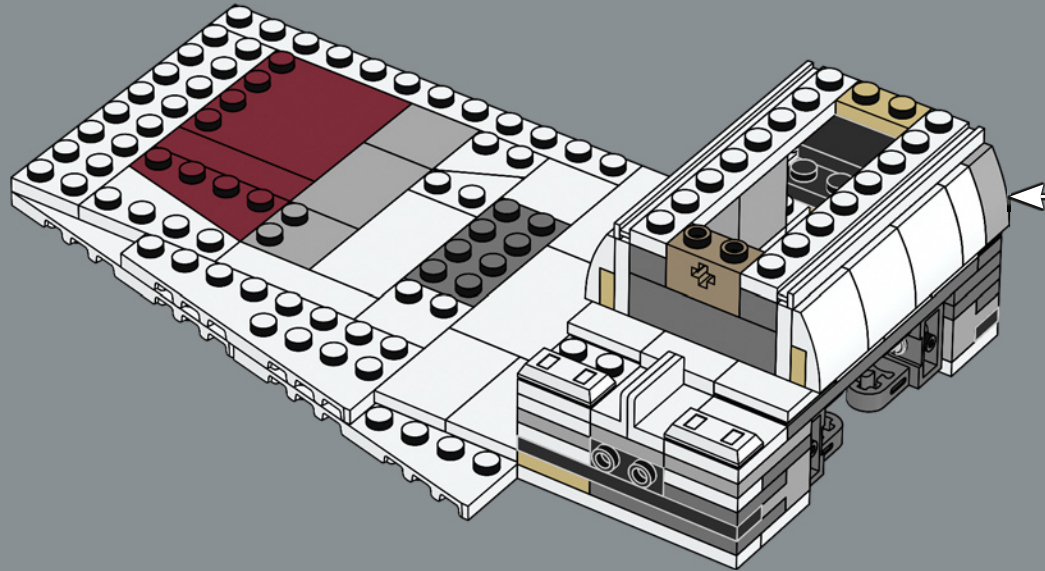
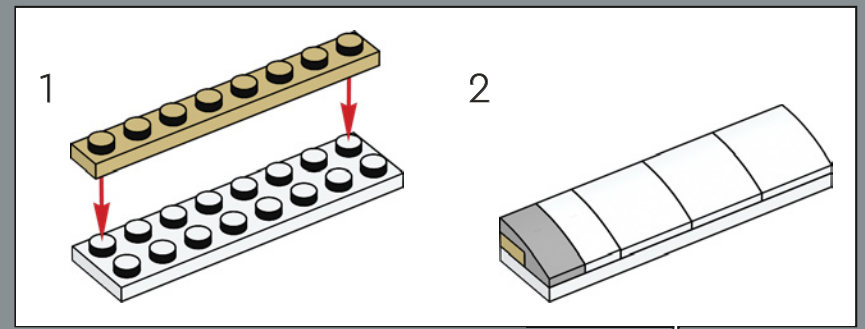

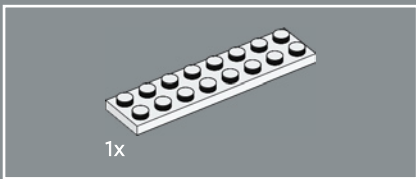

338

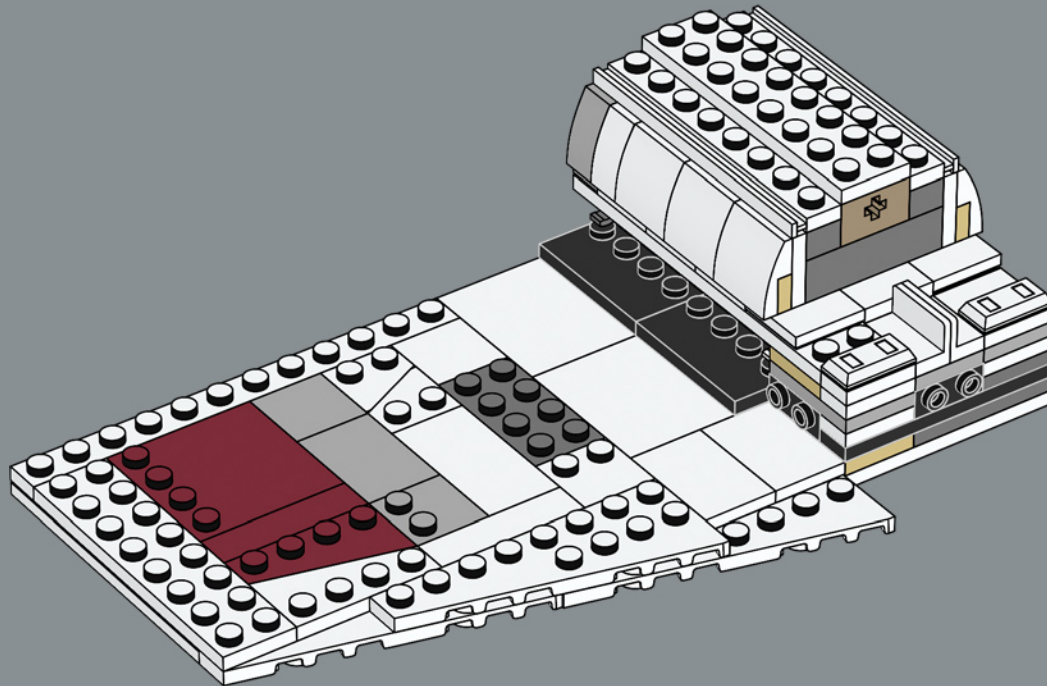



339

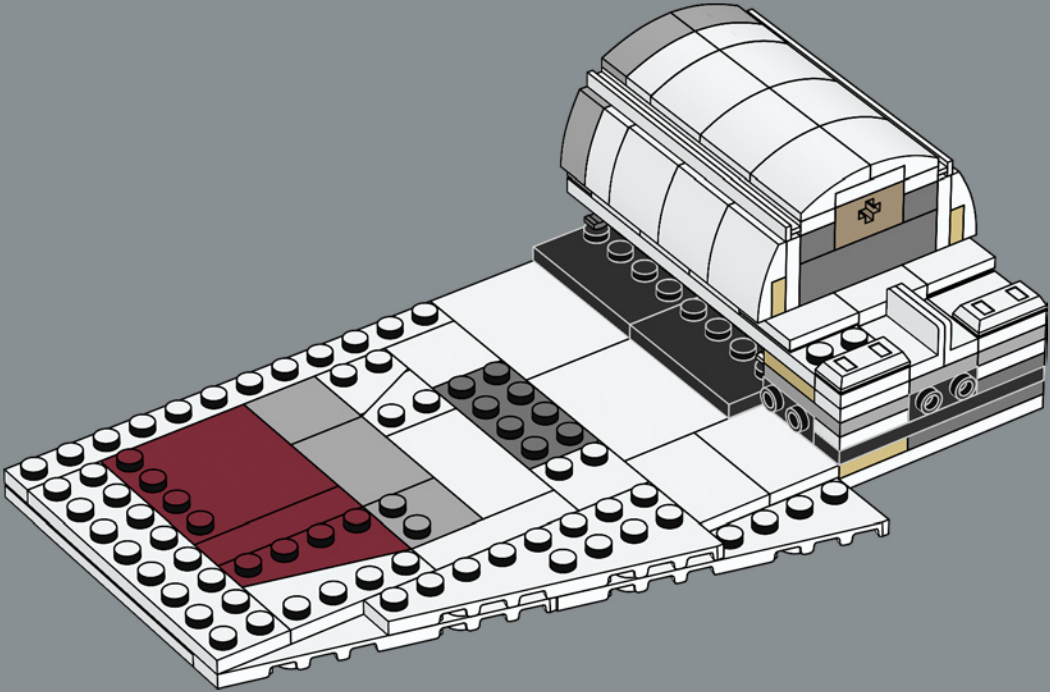

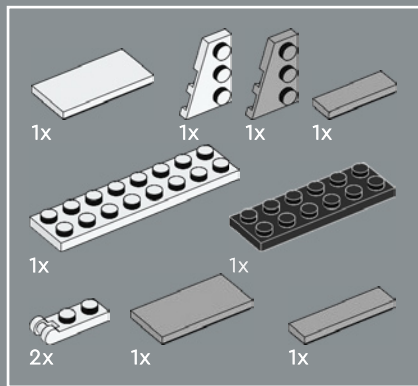

340

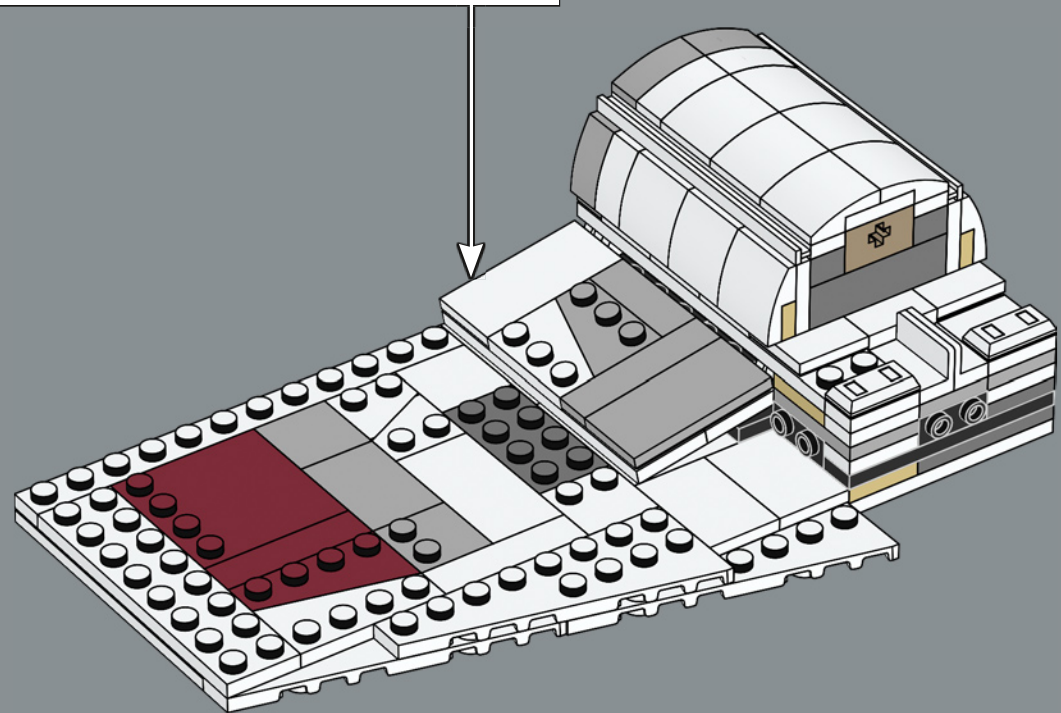
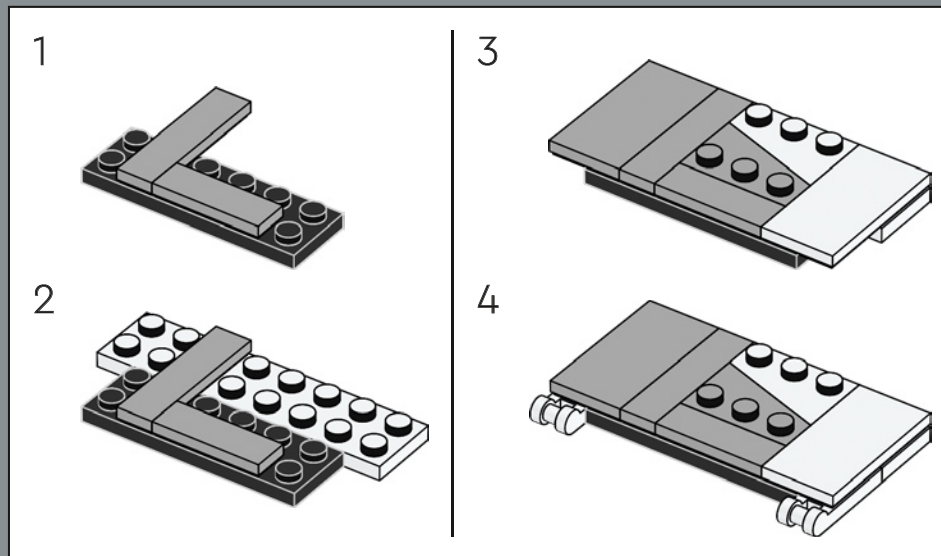

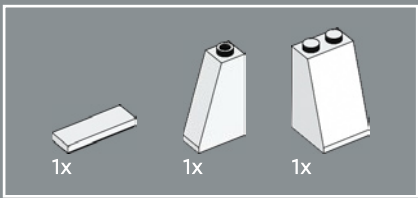

341

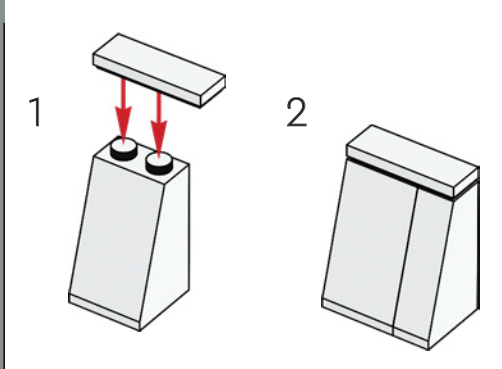
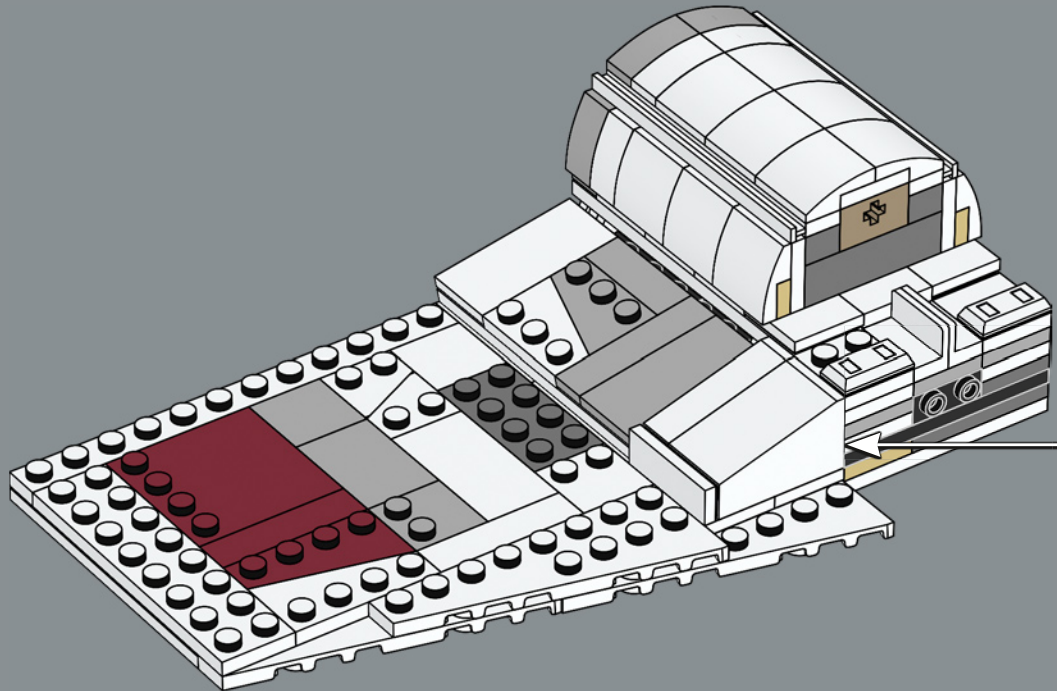

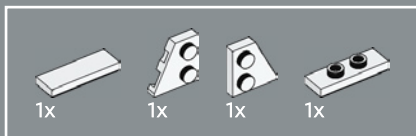

342

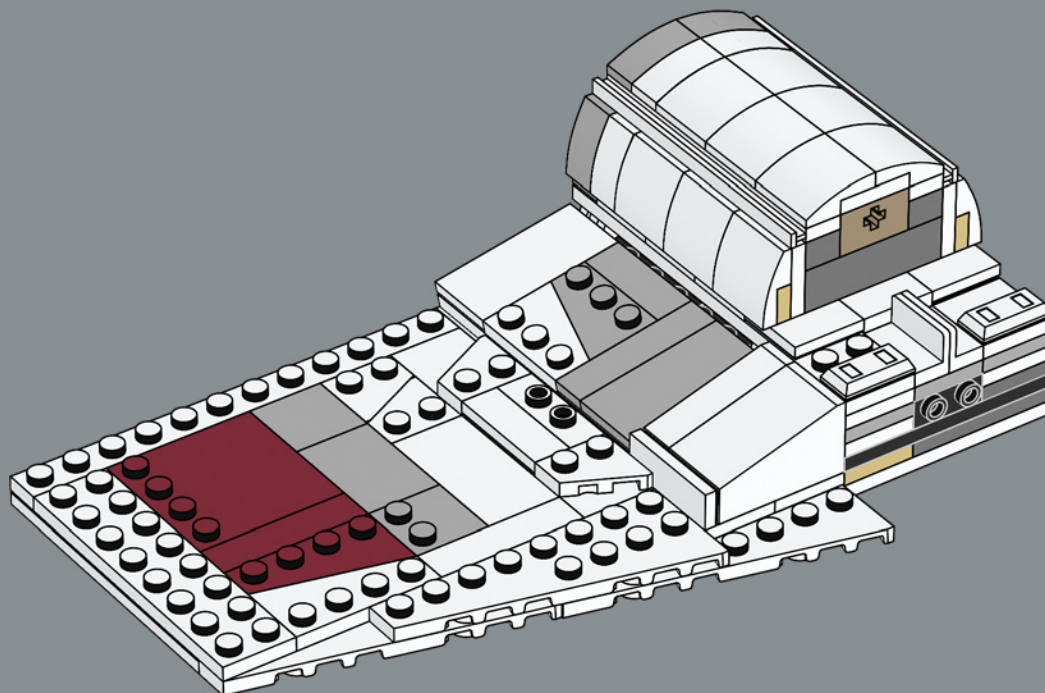

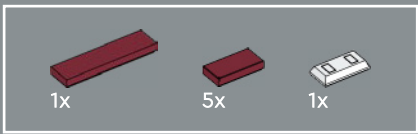

343

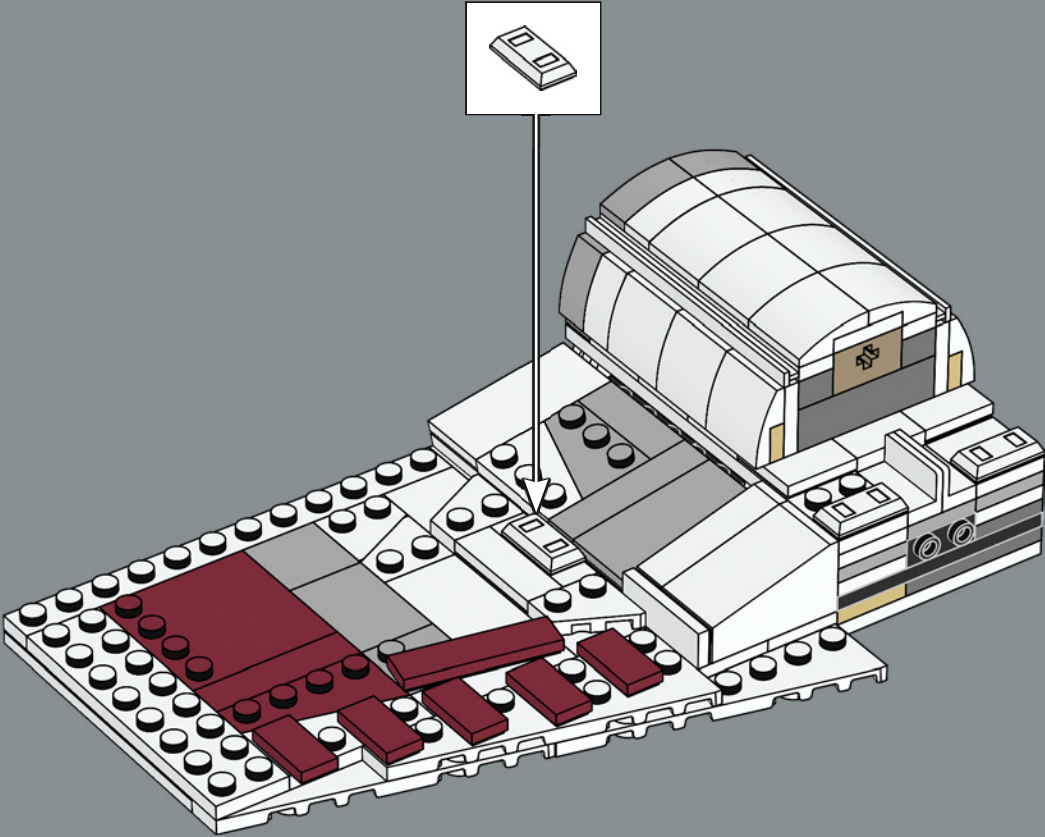

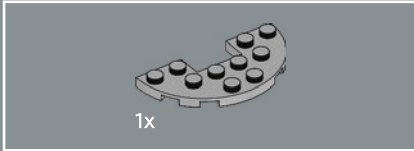
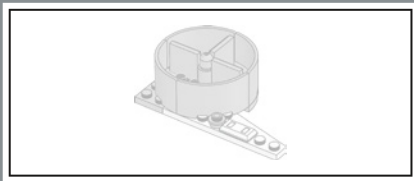

1x

344

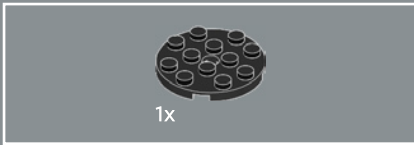
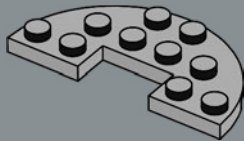

1x

345

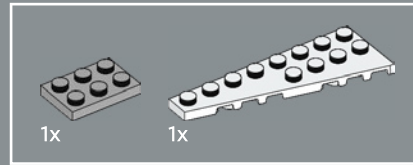
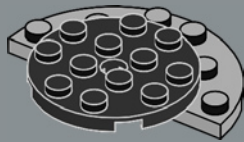

1x

1x

346

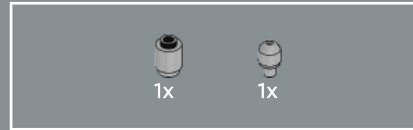
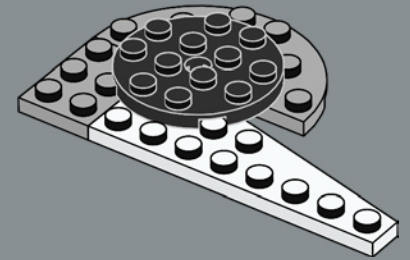

1x

1x

347

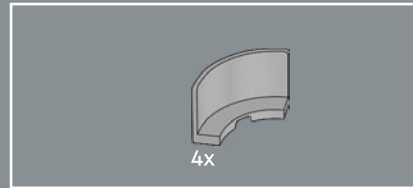
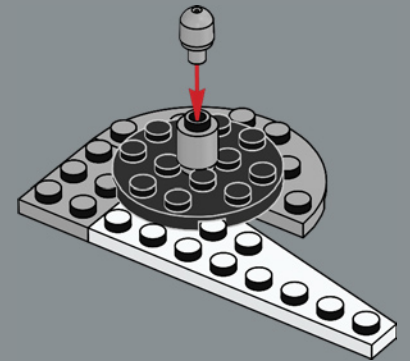

4x

348

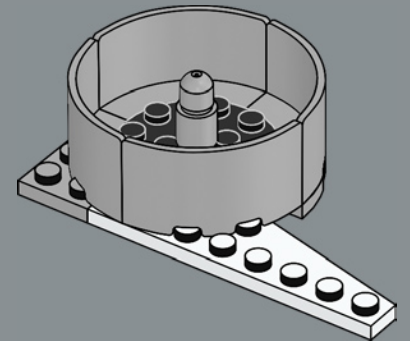

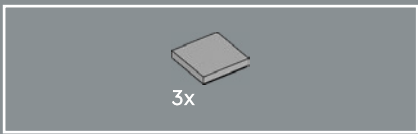

349

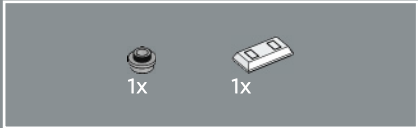
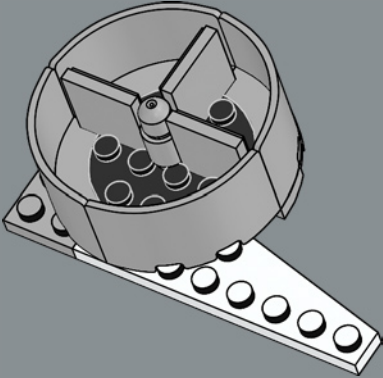

350

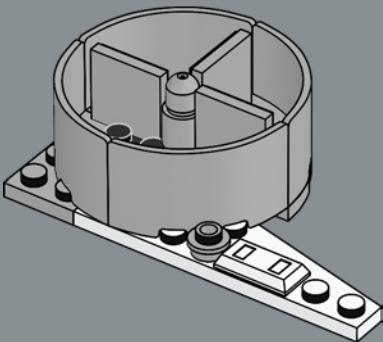

351

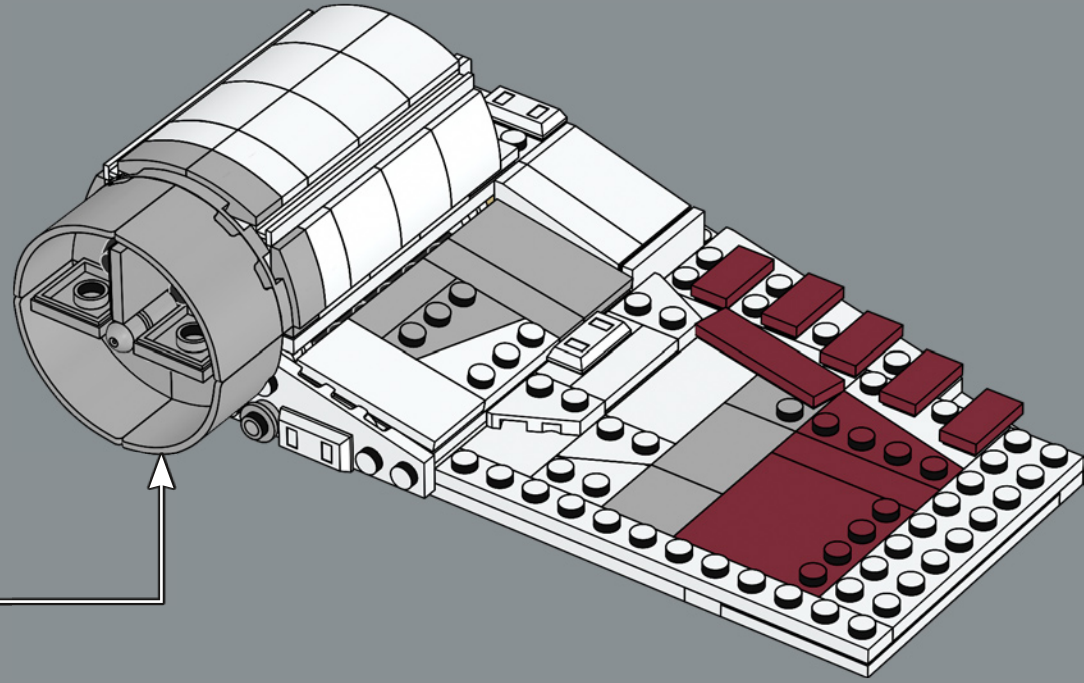

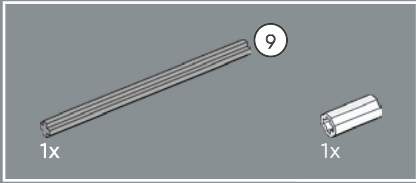
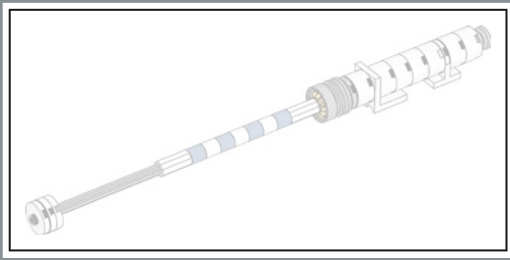

352

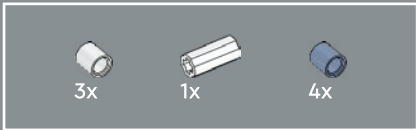
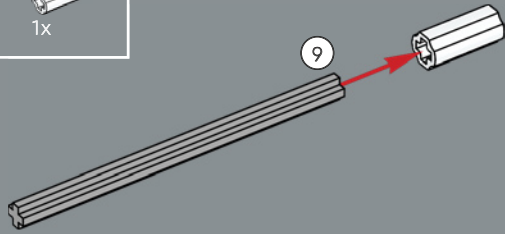

353

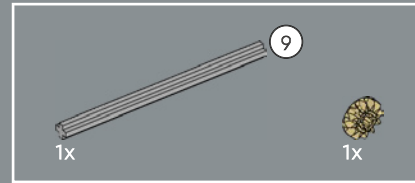
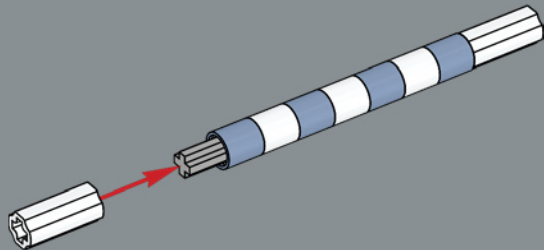

354

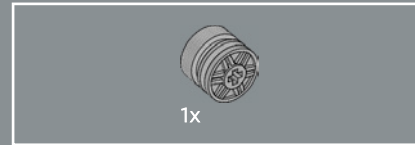
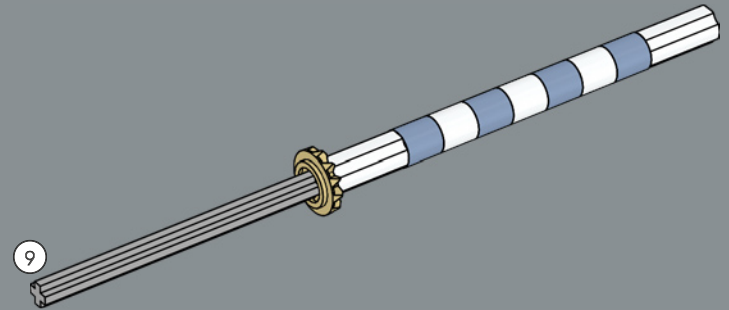

355

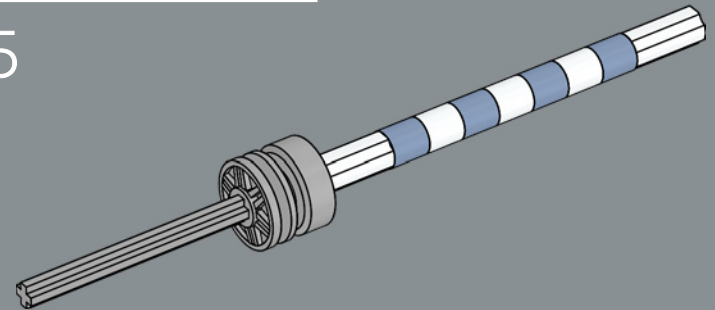

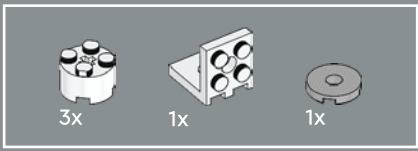

356

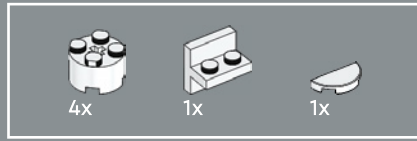
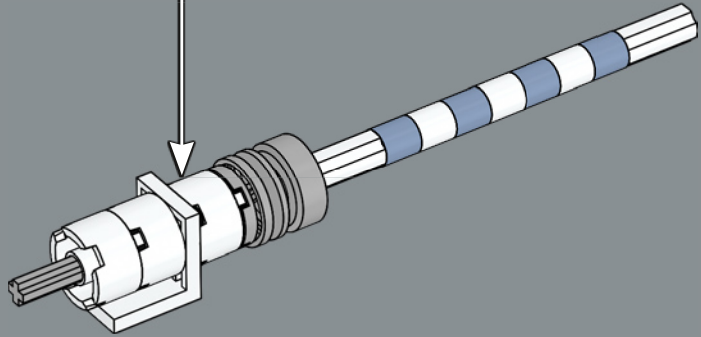
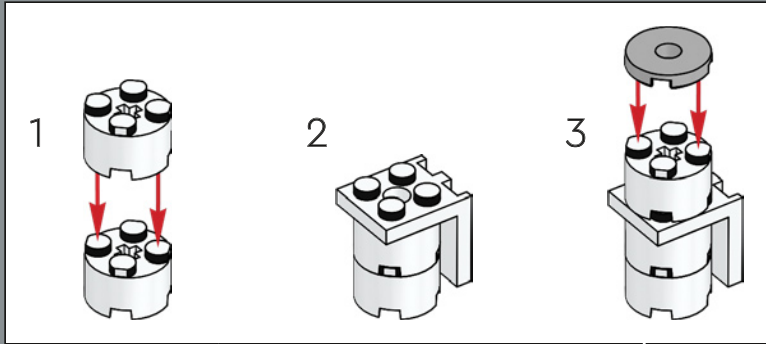

357

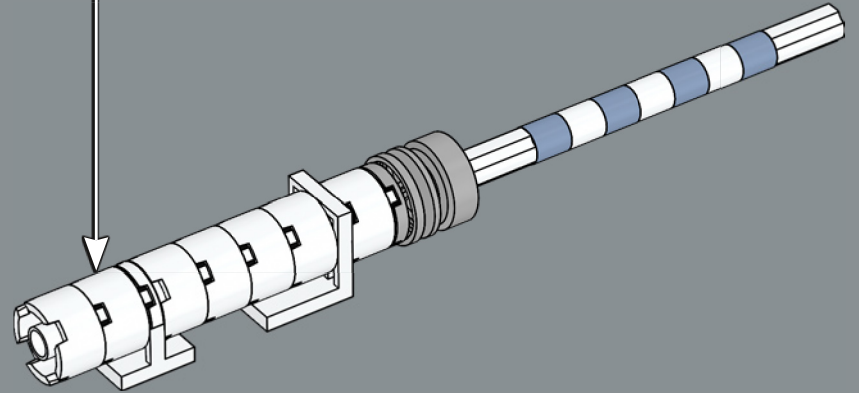
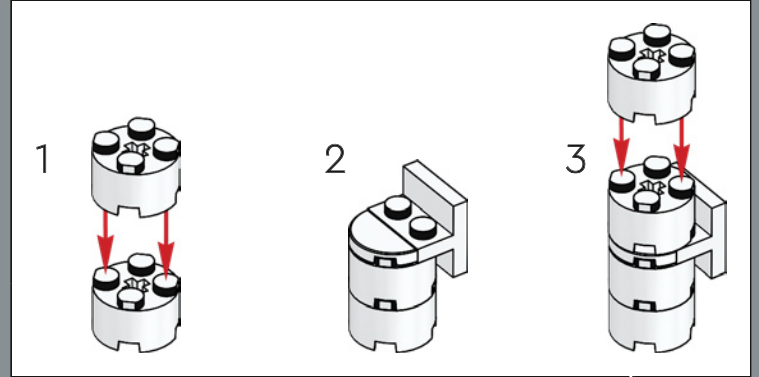

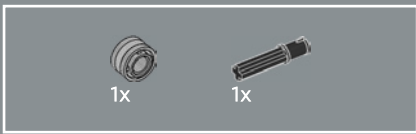

358

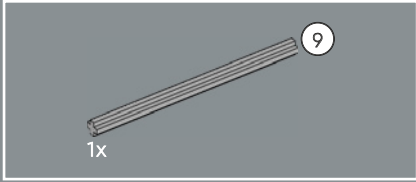
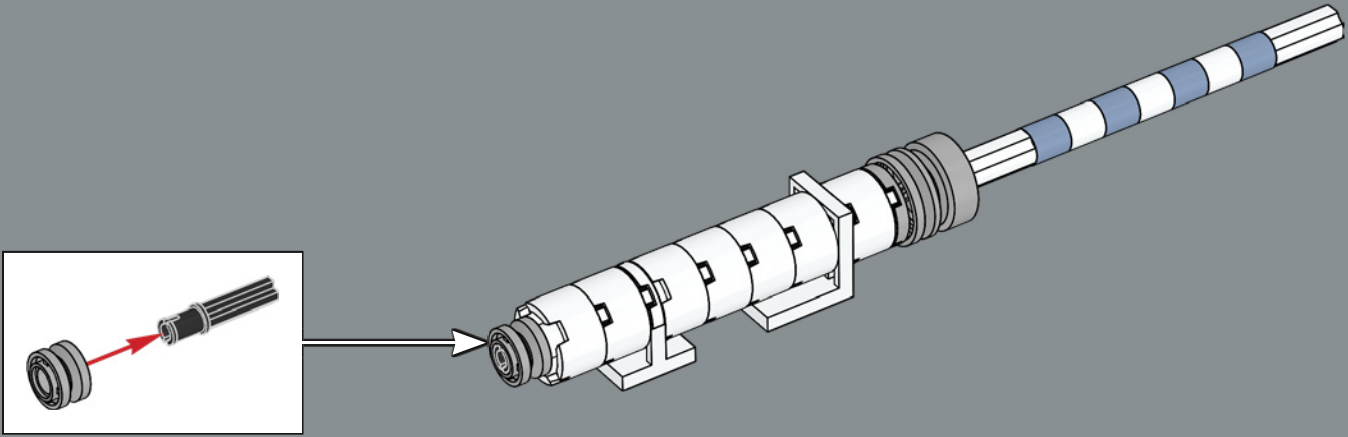

359

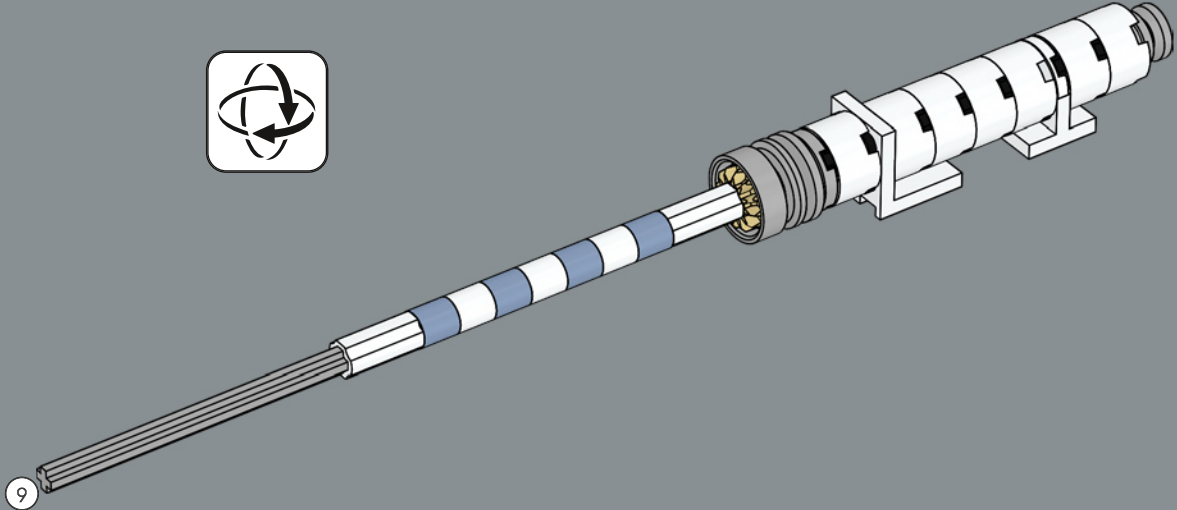

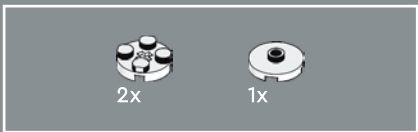

360

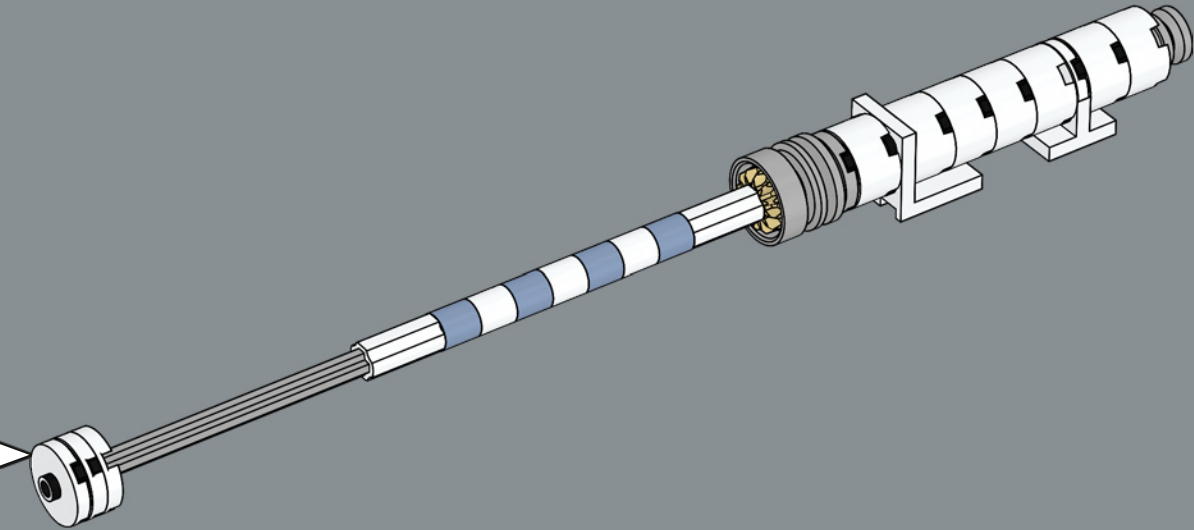
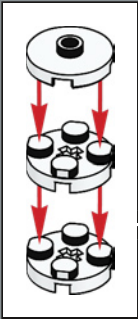

361

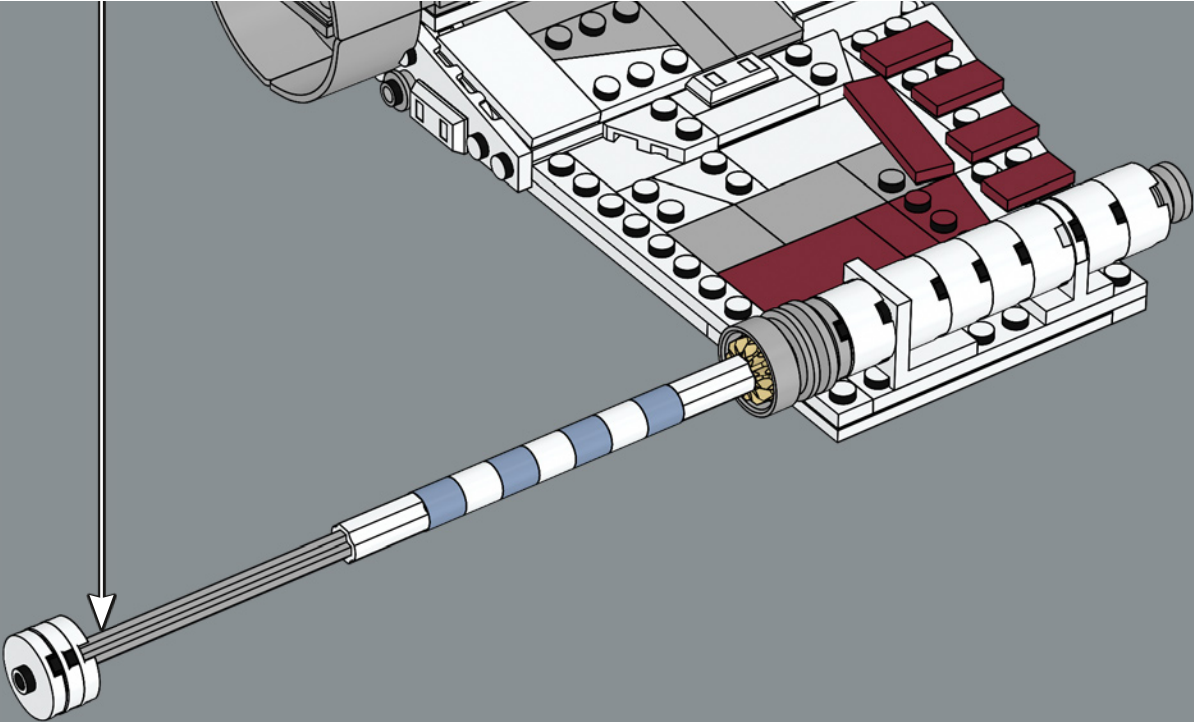

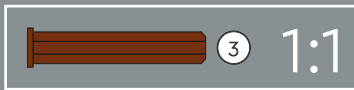
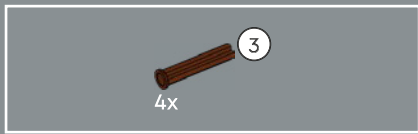

362

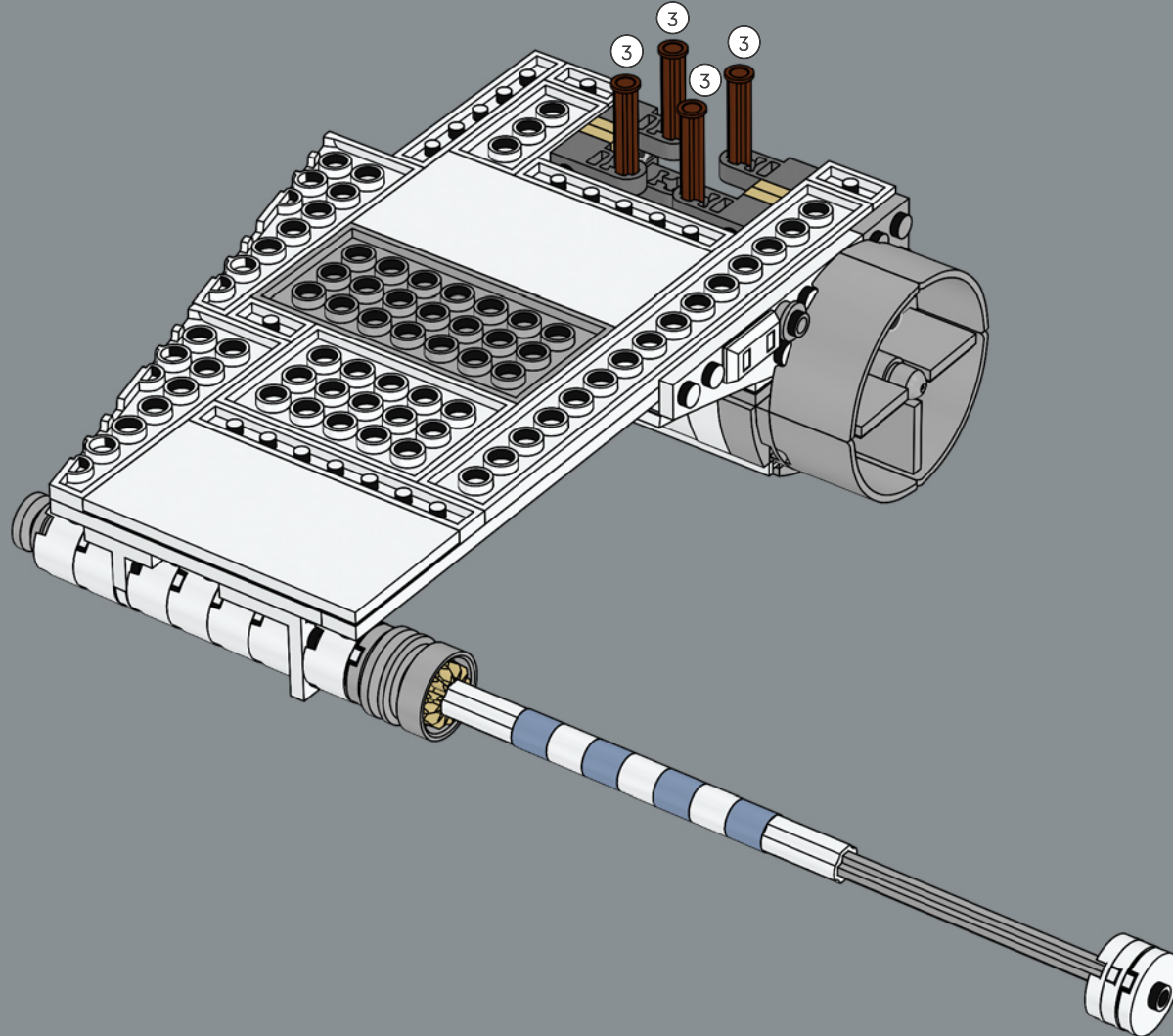

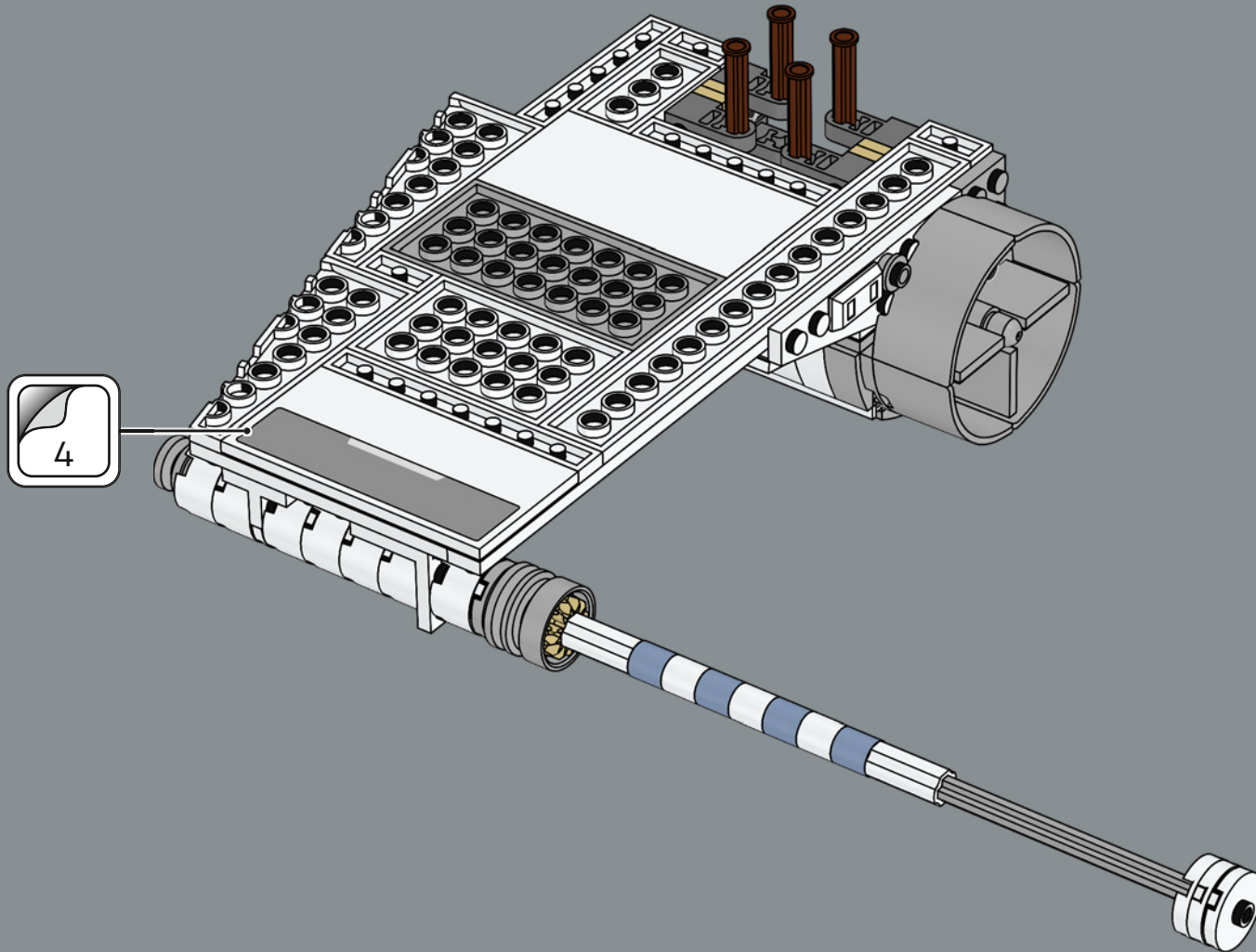

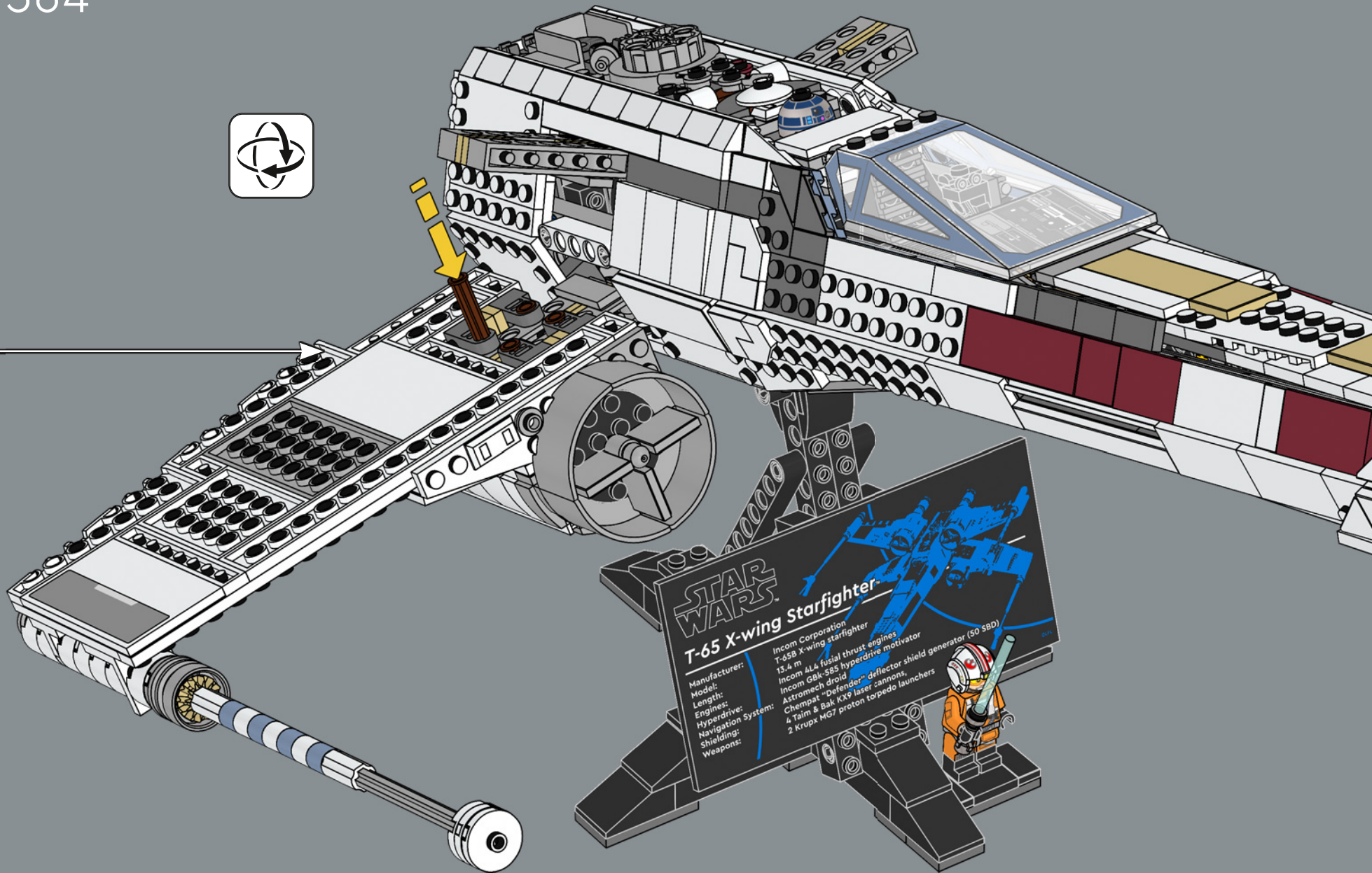

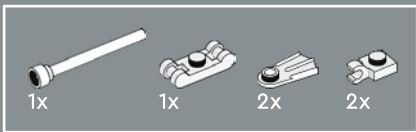

365

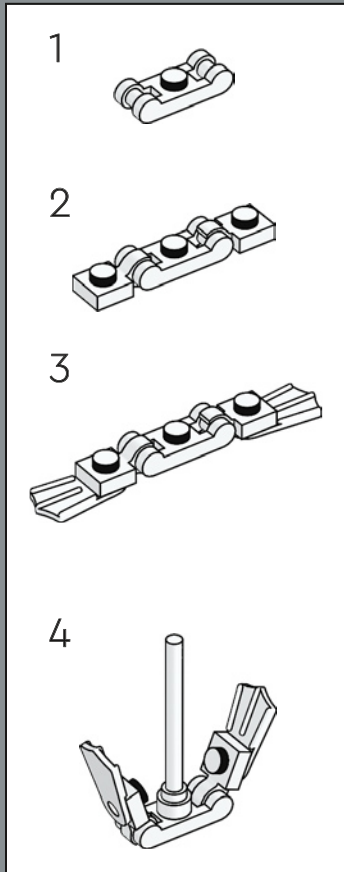
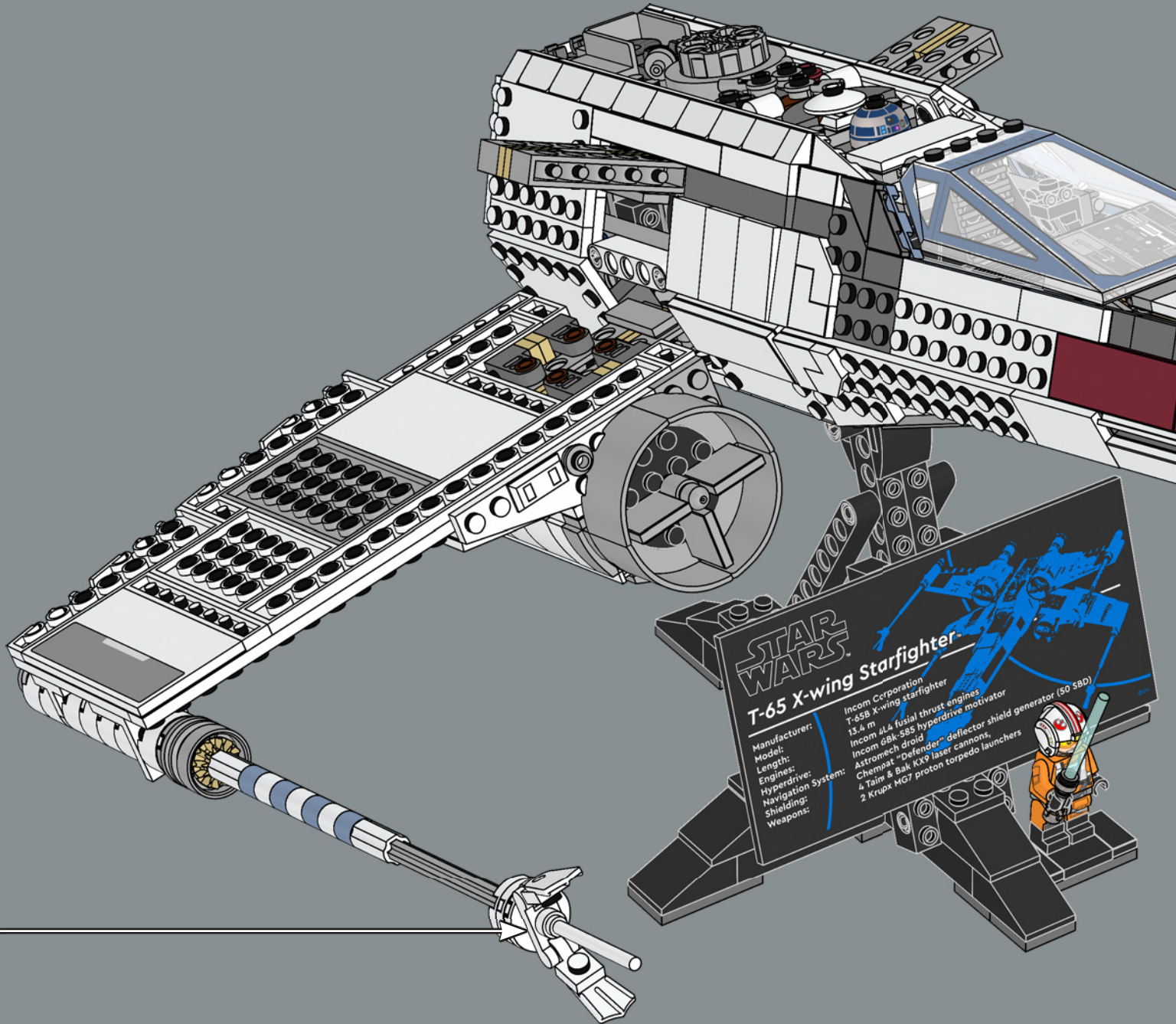

STAR WARS
T-65 X-wing starfighter

Manufacturer: Incom Corporation
 Model: T-65B X-wing starfighter
 Length: 13.4 m
 Engines: Incom 4L4 fusial thrust engines
 Hyperdrive: Incom 68K-585 hyperdrive motivator
 Navigation System: Astromech droid
 Shielding: Chemsbat "Defender" deflector shield generator (50 SBD) & Taim & Bak KY9 laser cannons
 Weapons: 4 Taim & Bak KY9 proton cannons, 2 Krupx MG7 proton torpedo launchers

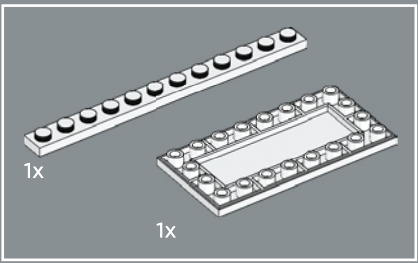

366

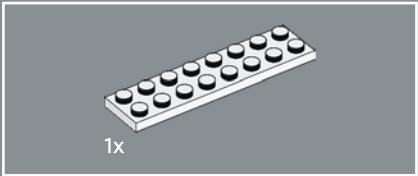
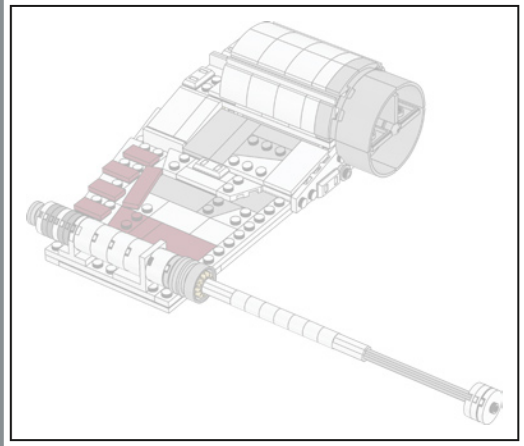
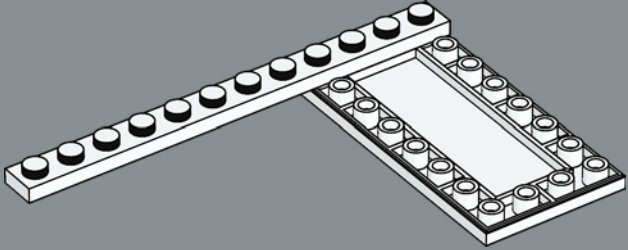

367

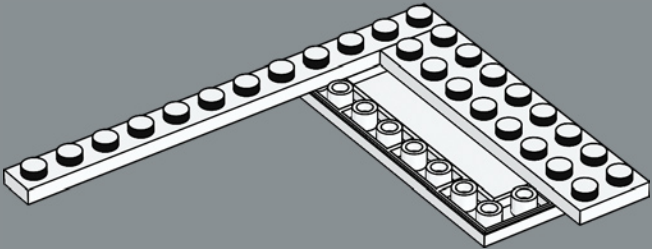

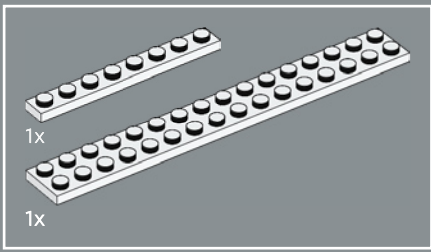

368

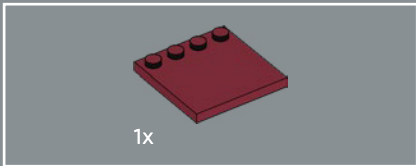
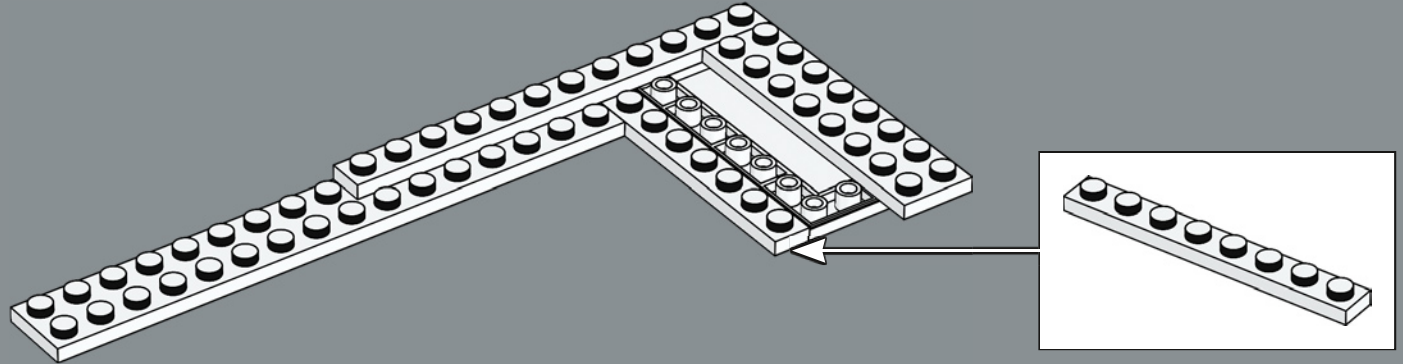

369

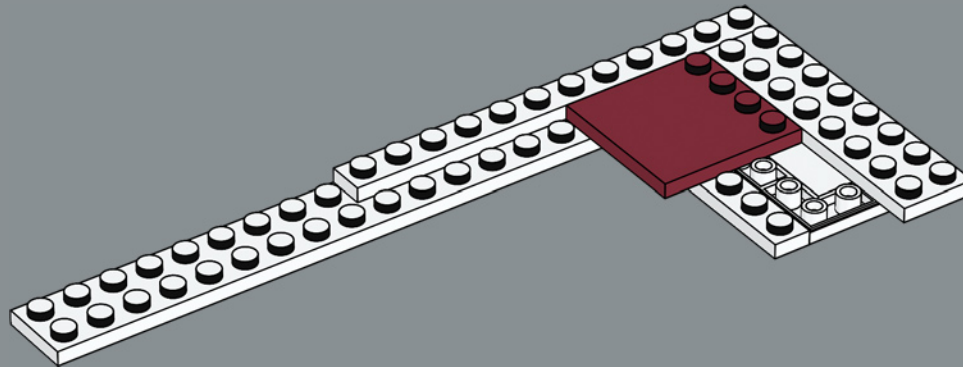

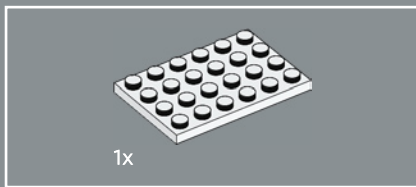

370

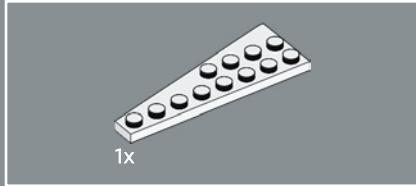
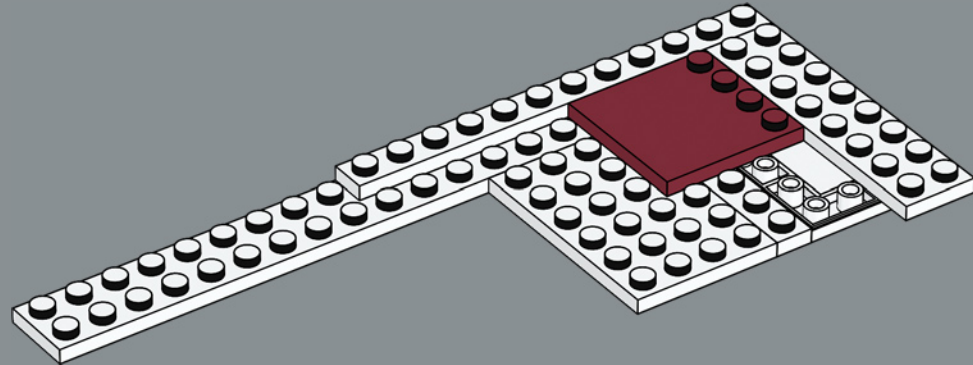

371

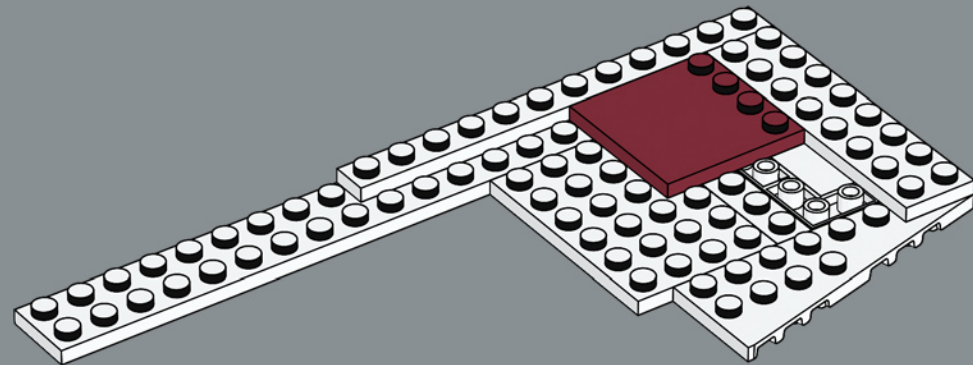

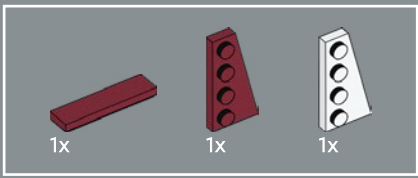

372

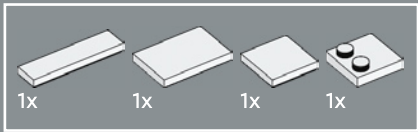
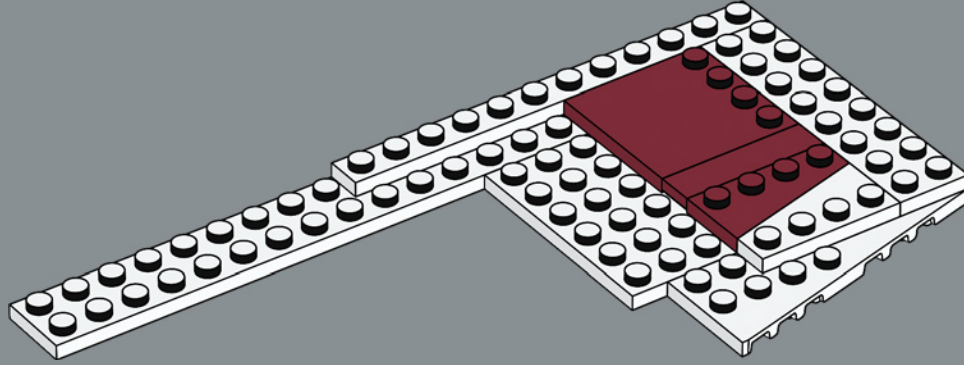

373

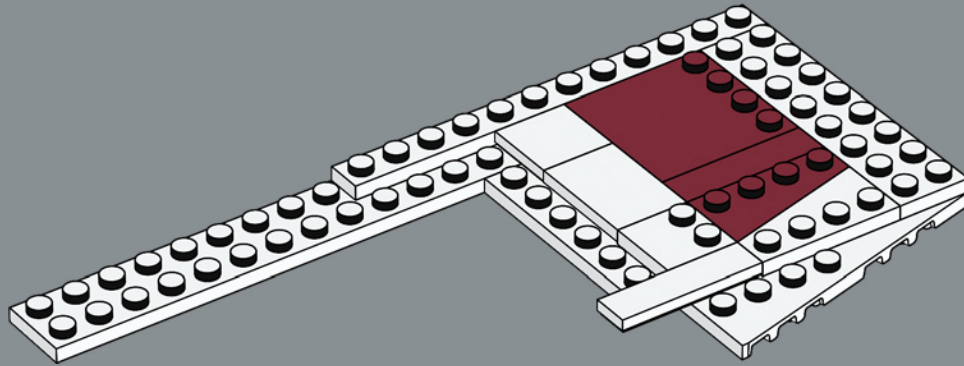

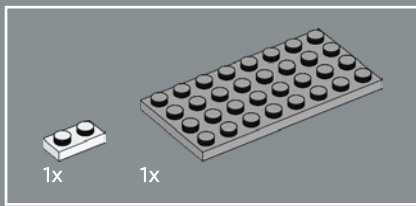

374

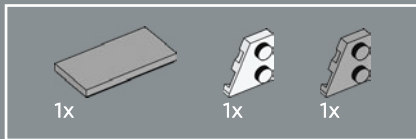
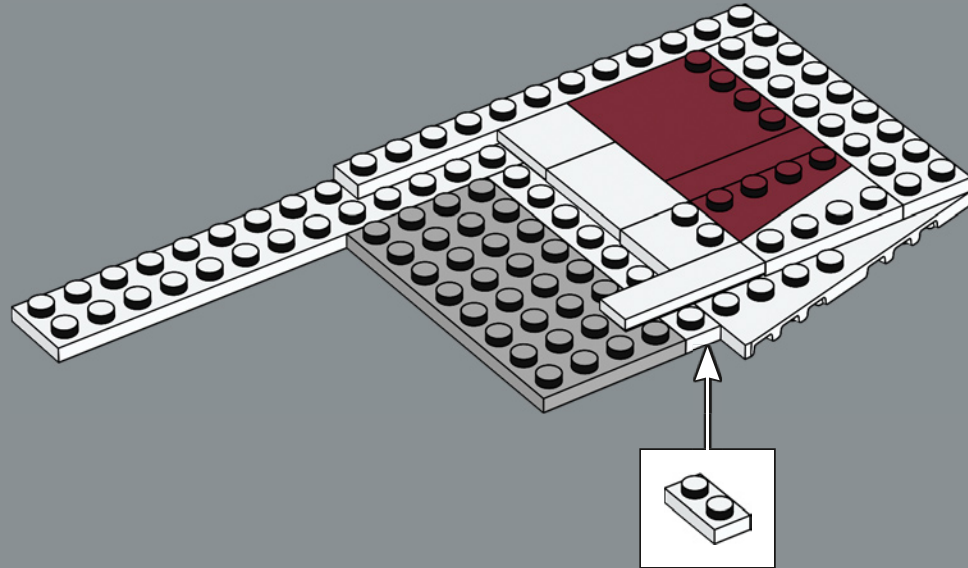

375

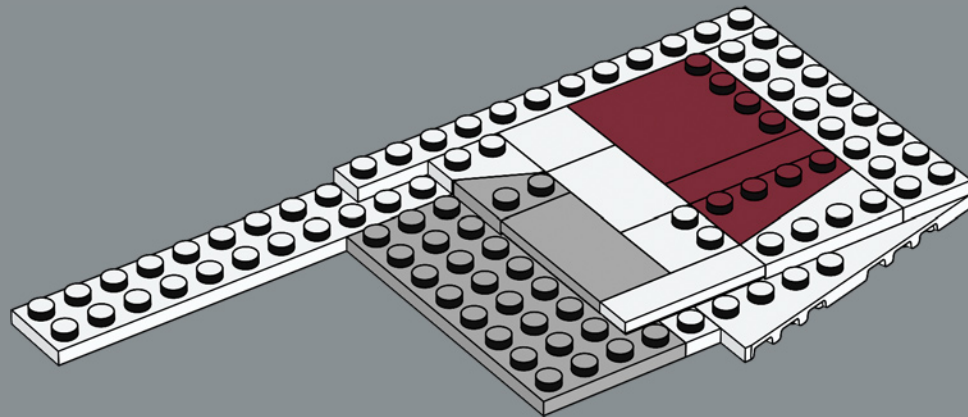

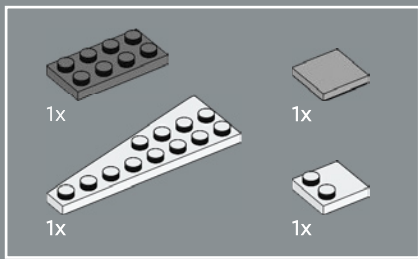

376

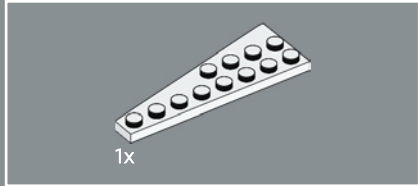
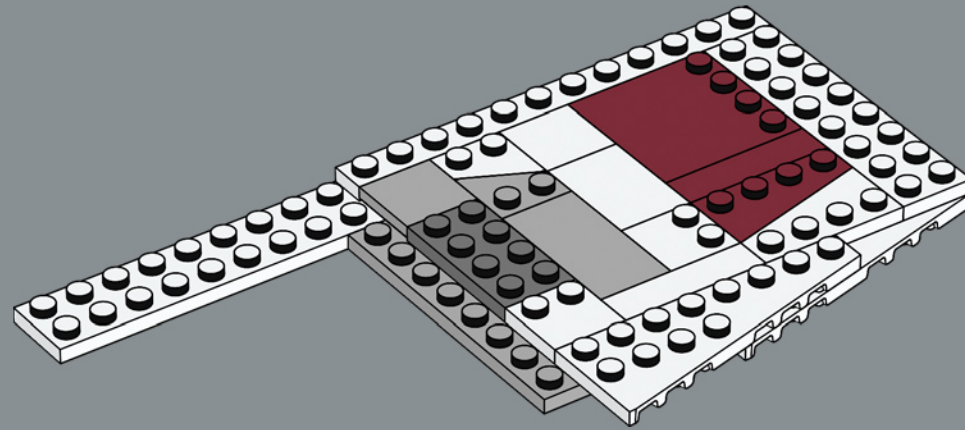

377

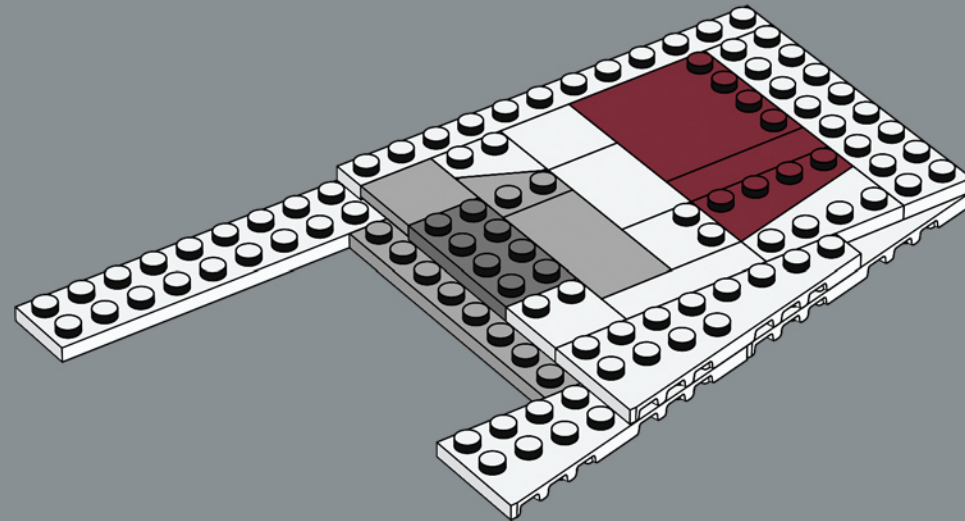



378

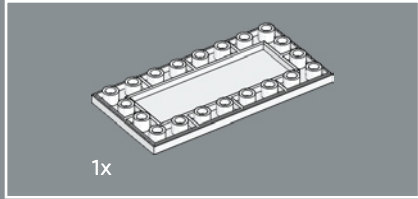
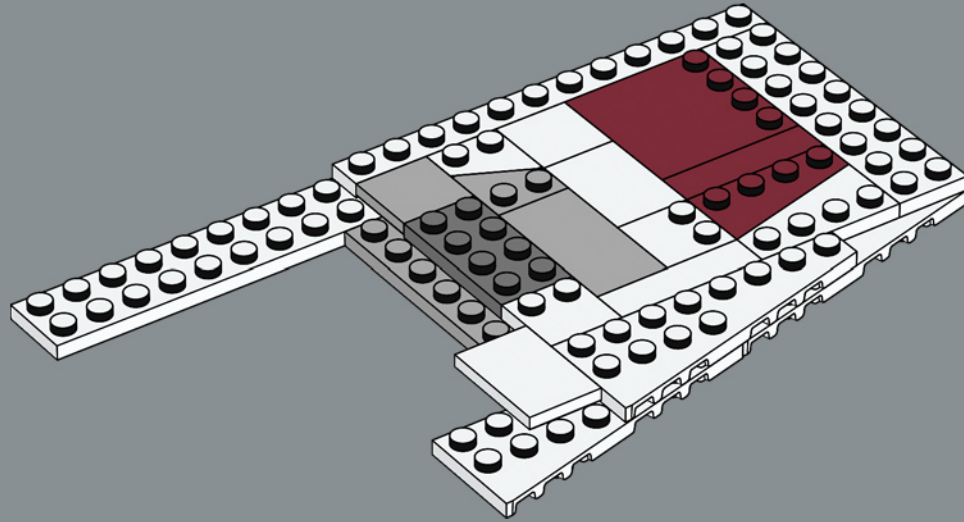

379

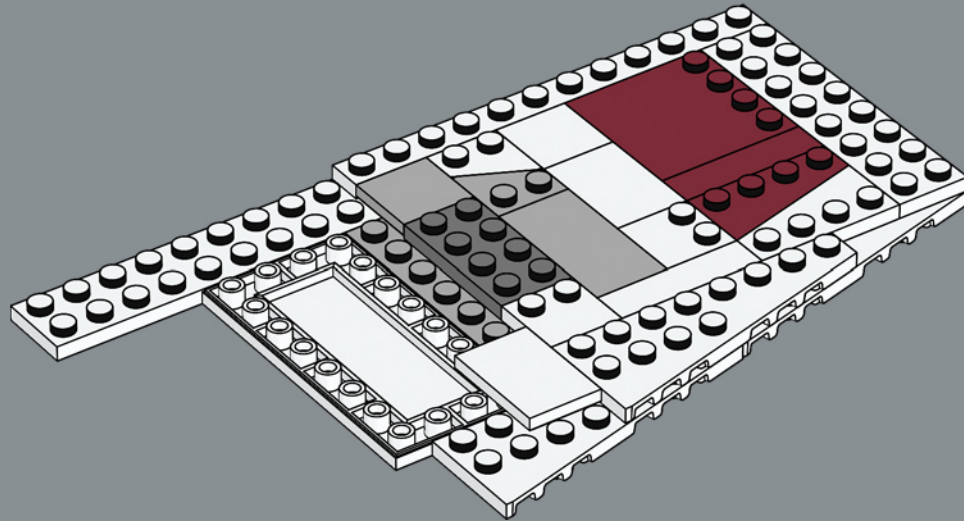

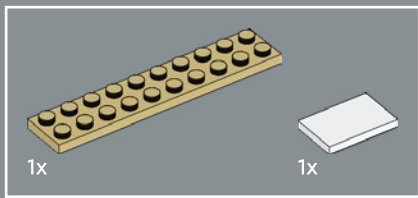

380

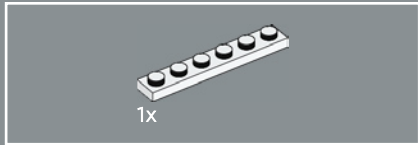
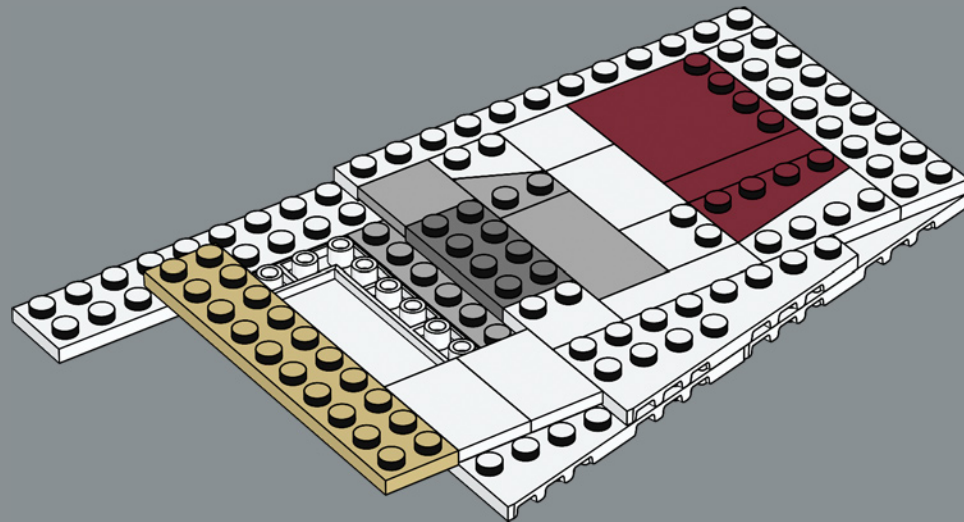

381

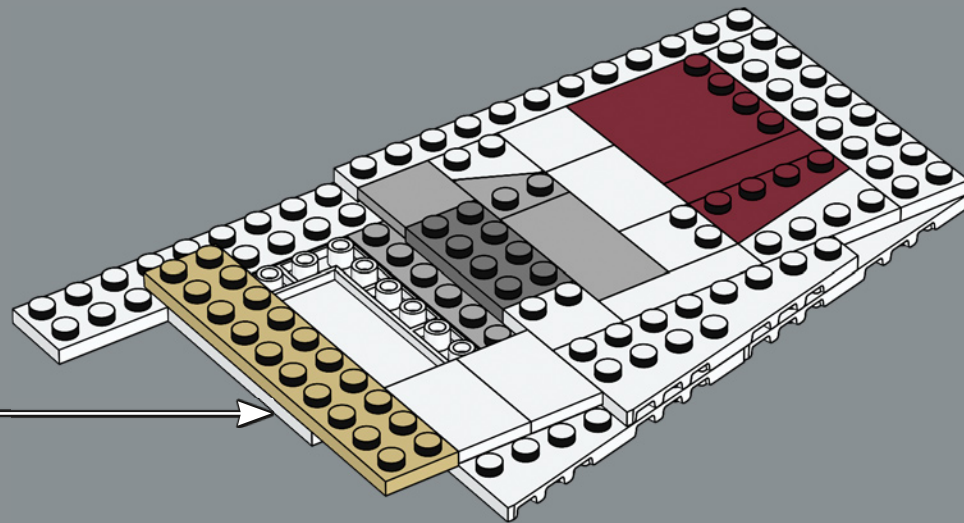
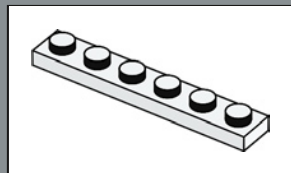

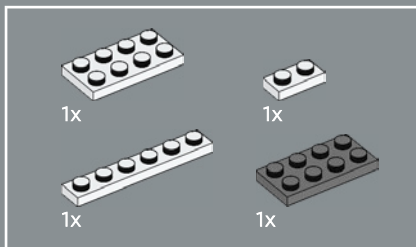

382

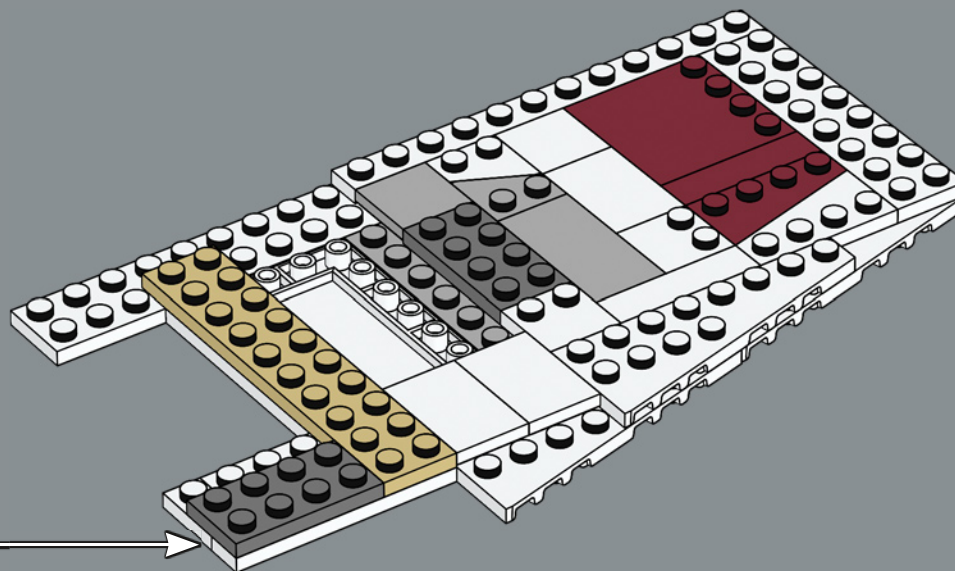
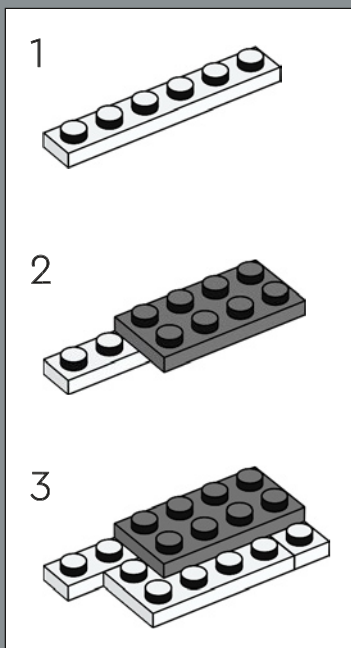

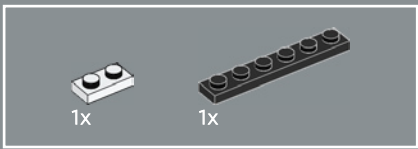

383

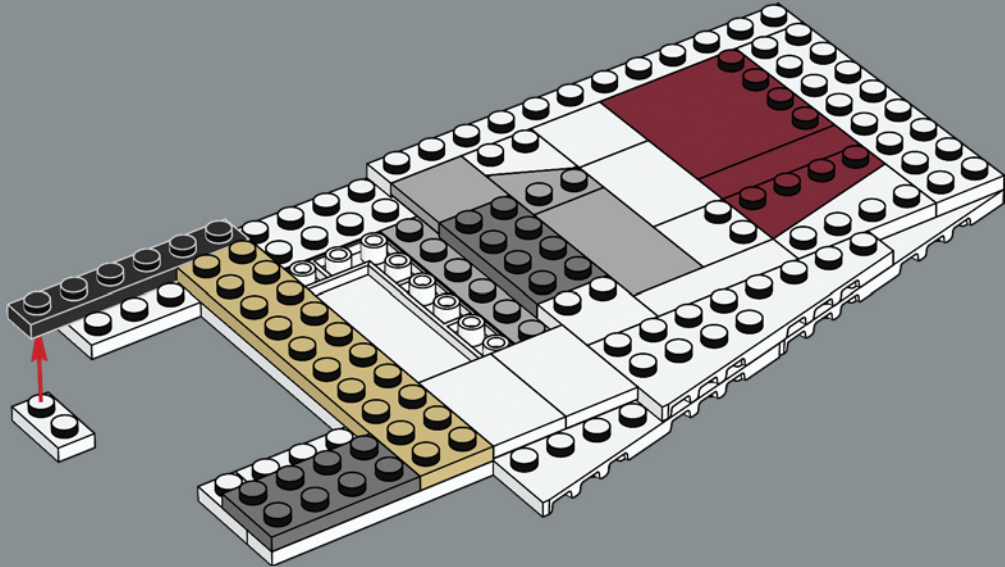

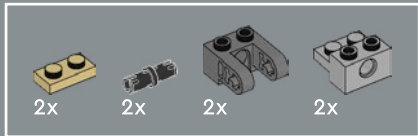

384

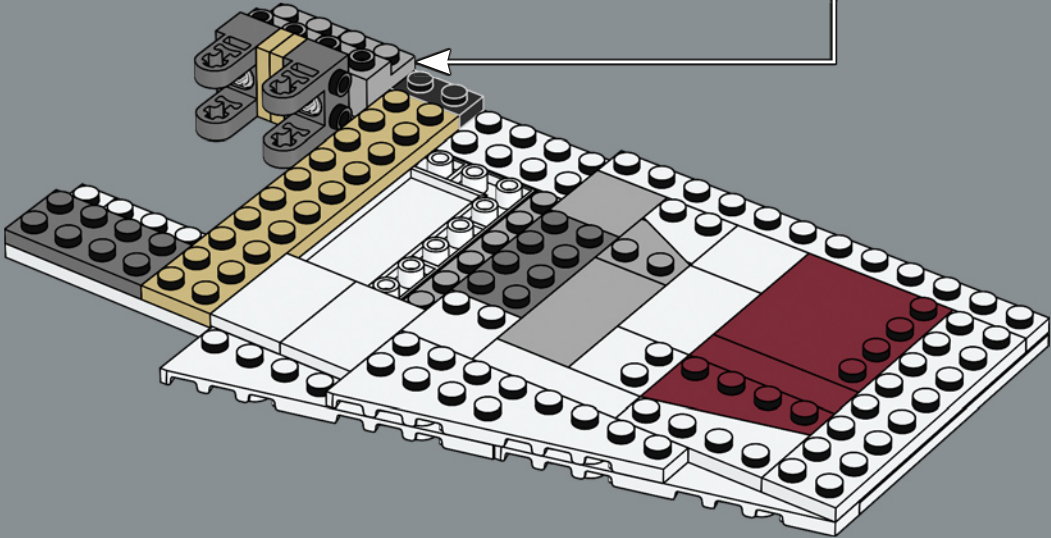
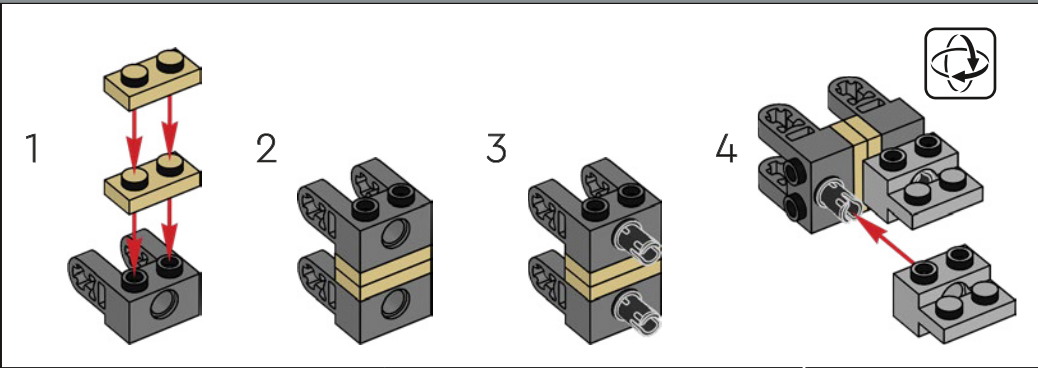

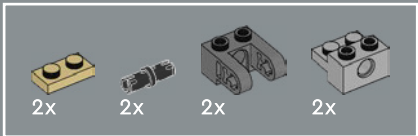

385

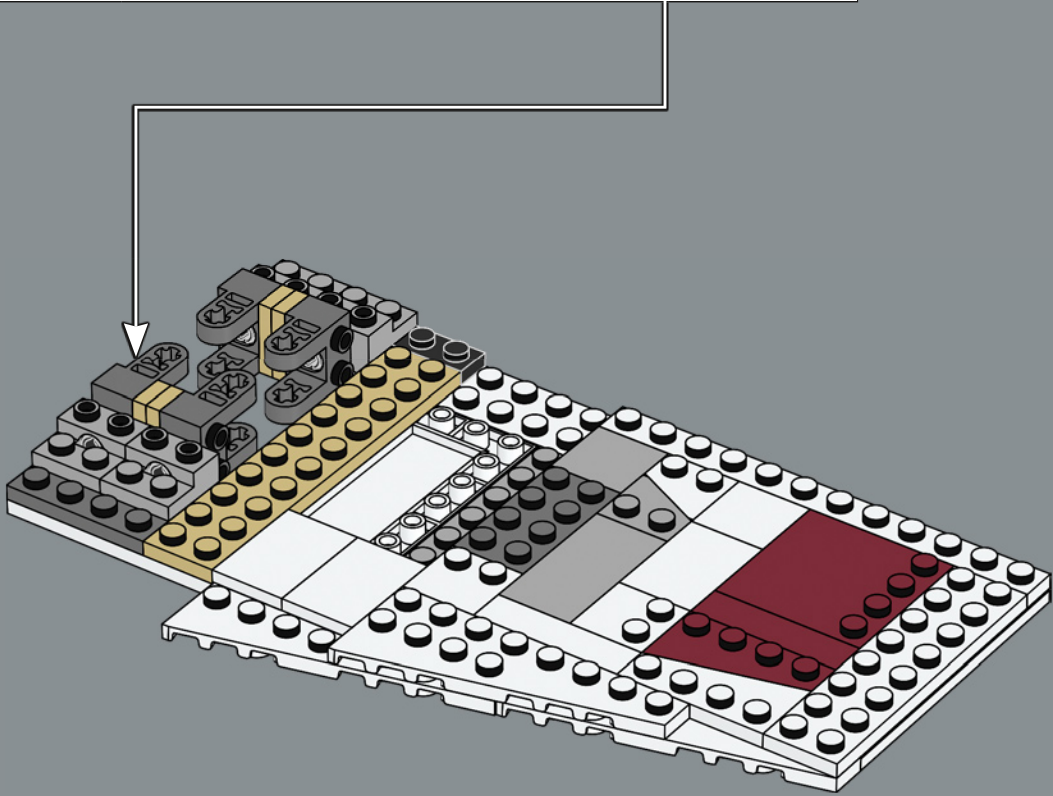
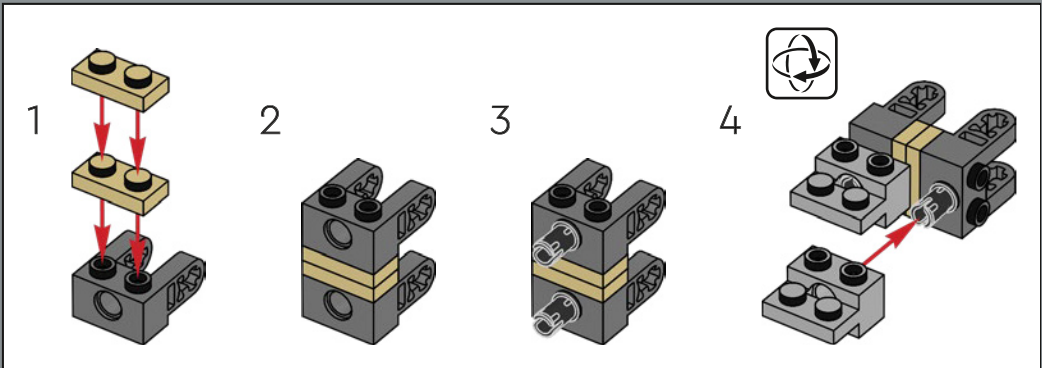

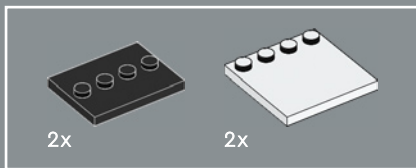

386

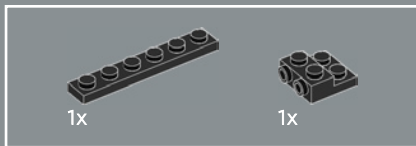
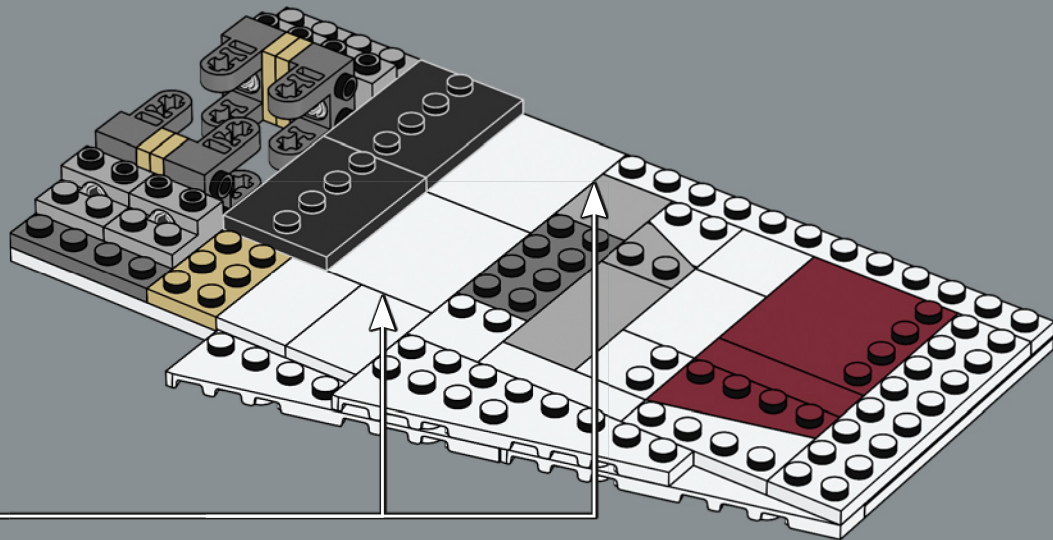
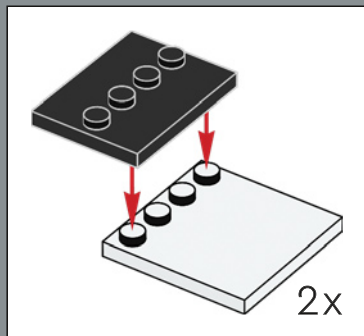

387

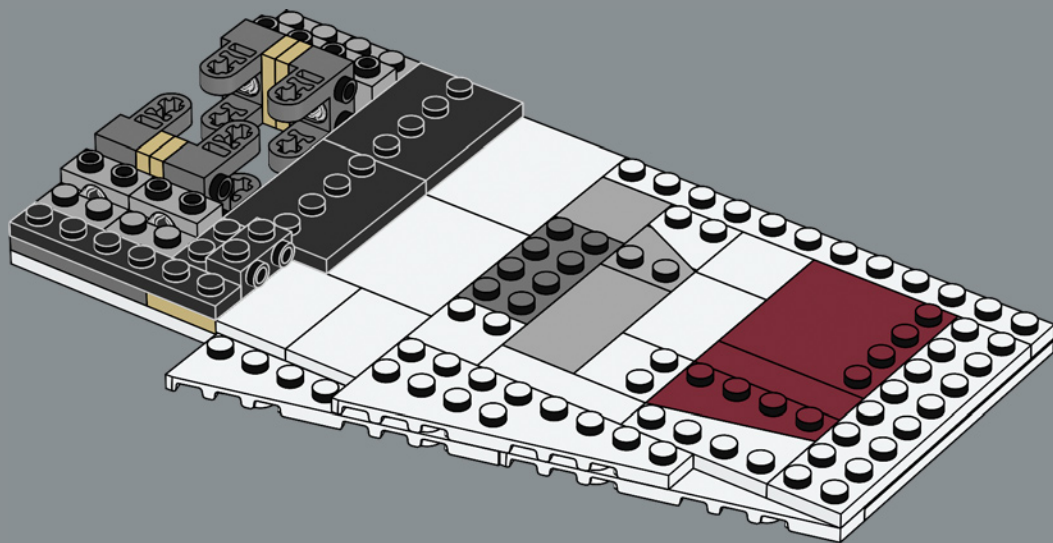

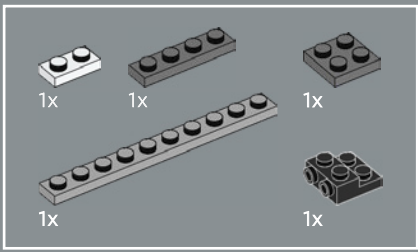

388

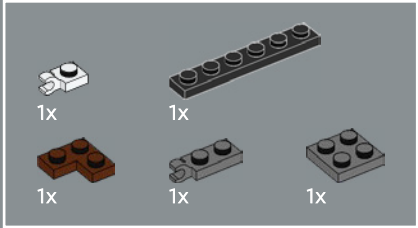
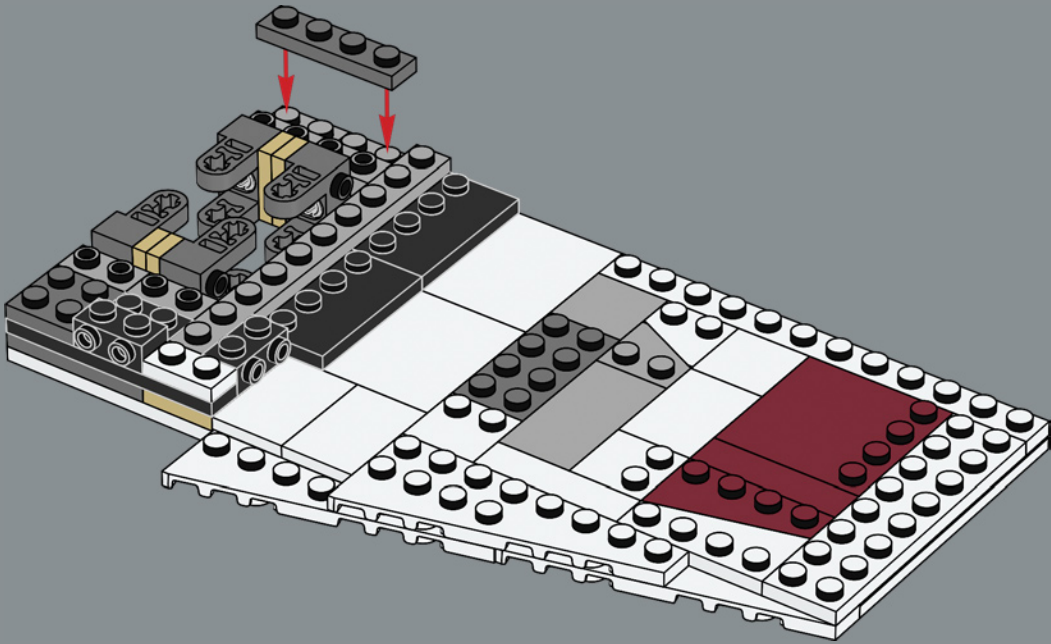

389

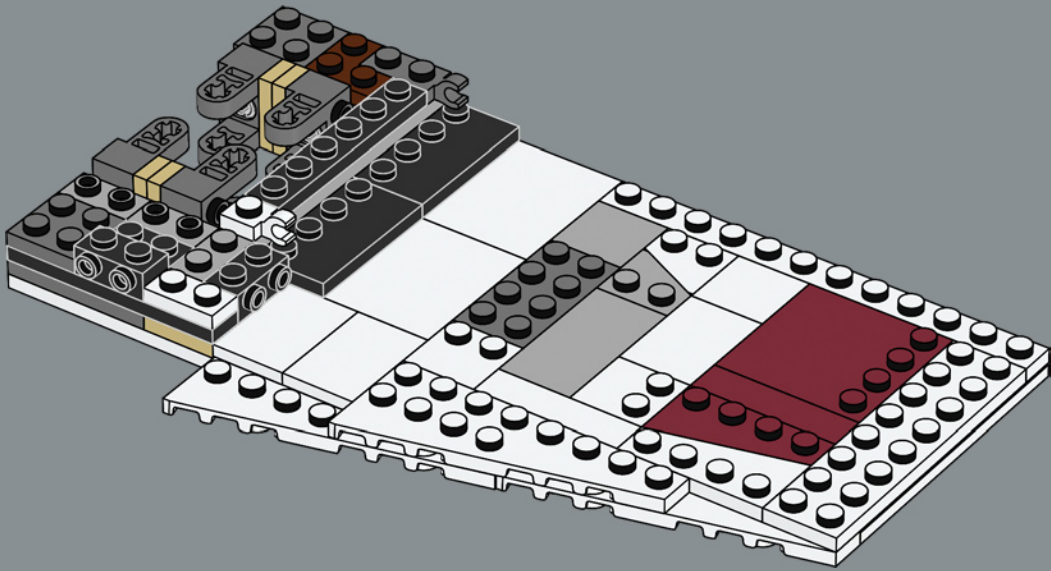

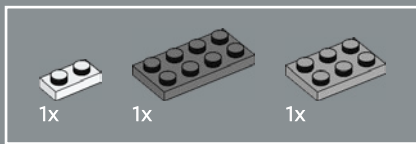

390

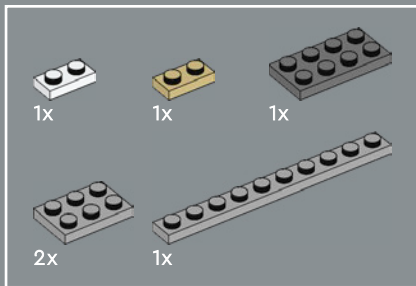
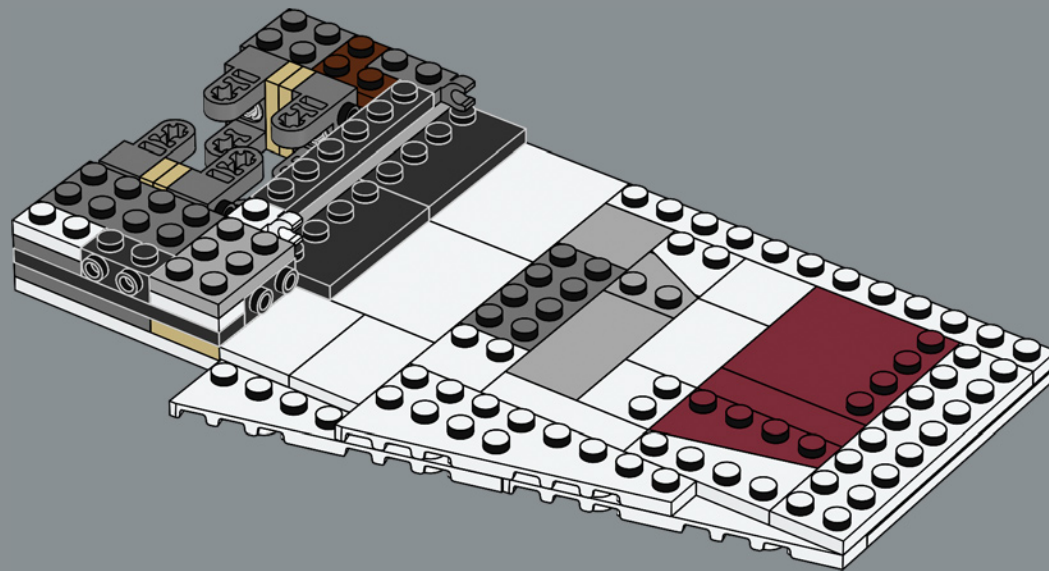

391

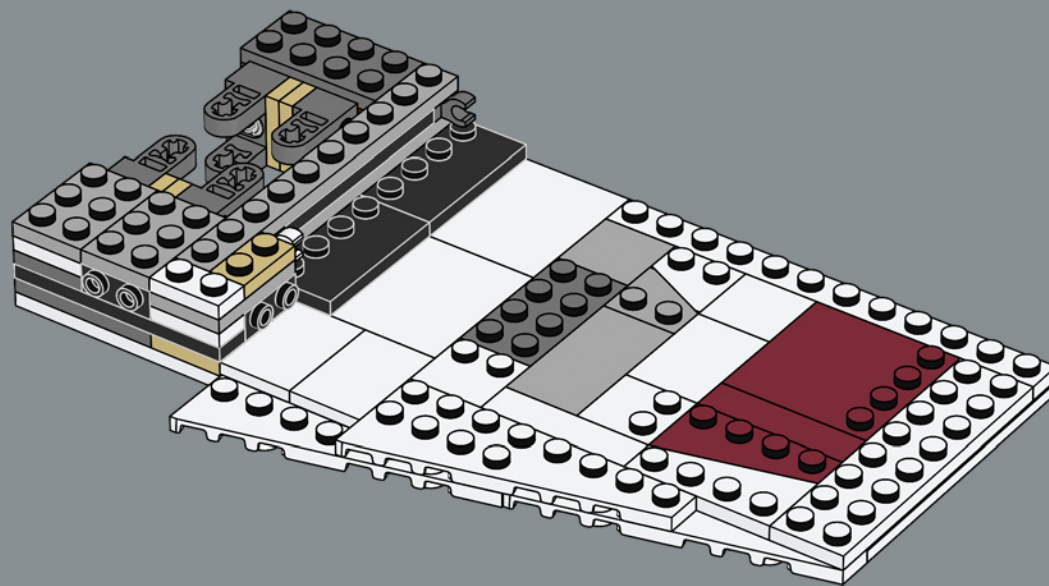

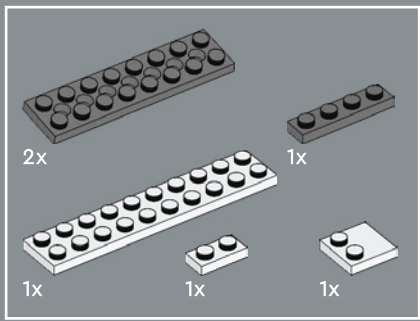

392

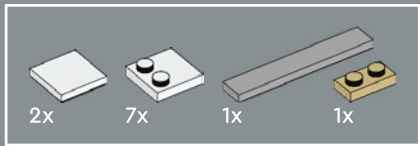
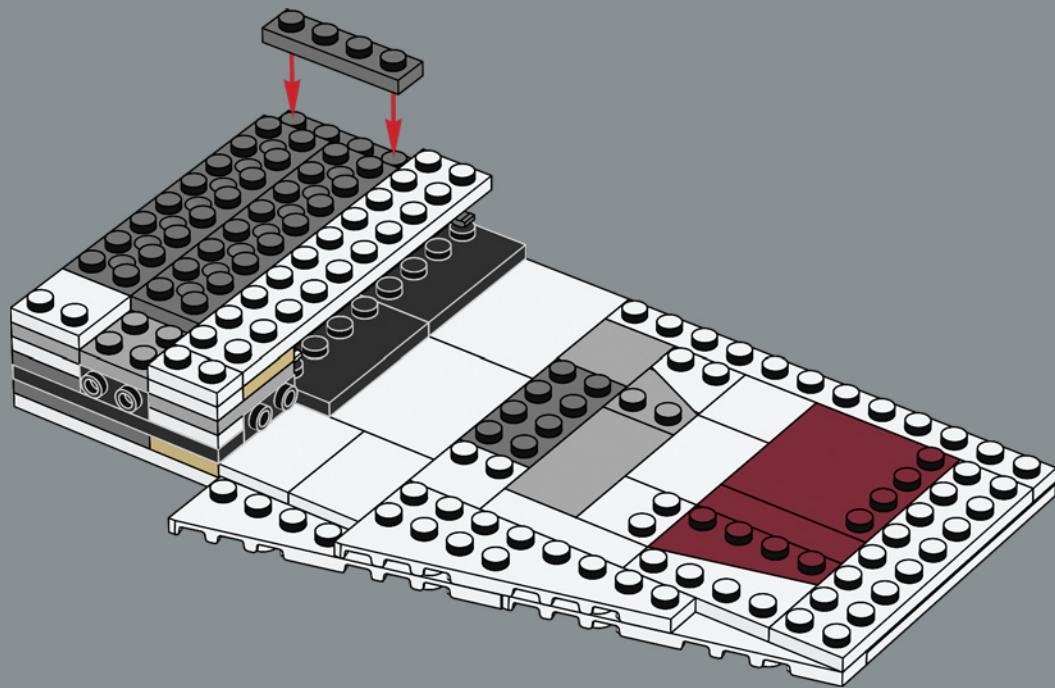

393

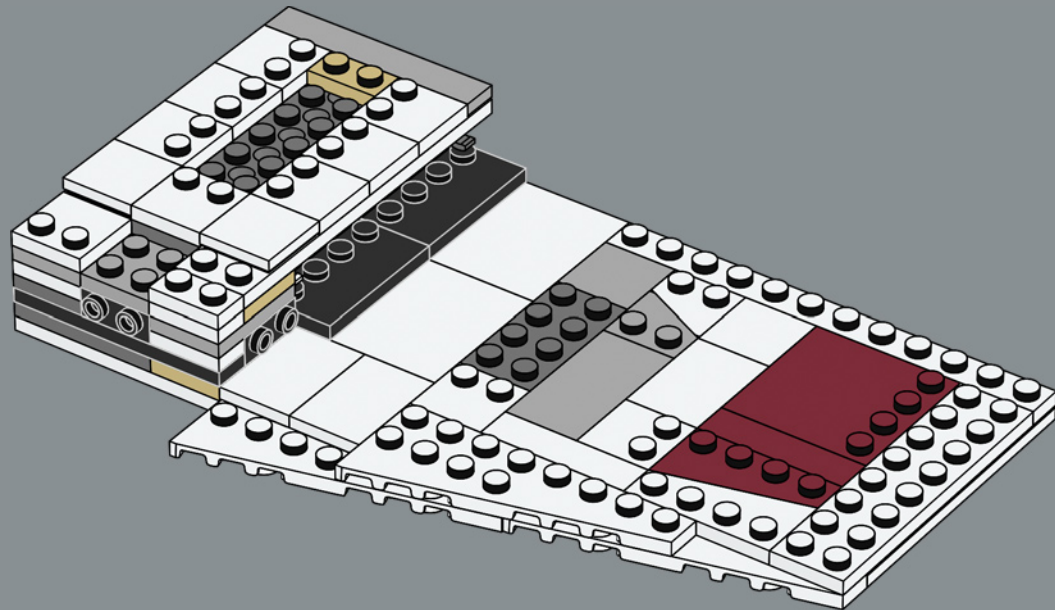

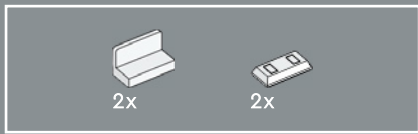

394

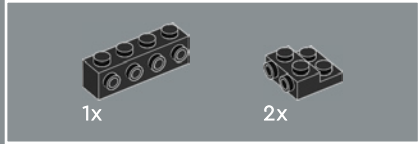
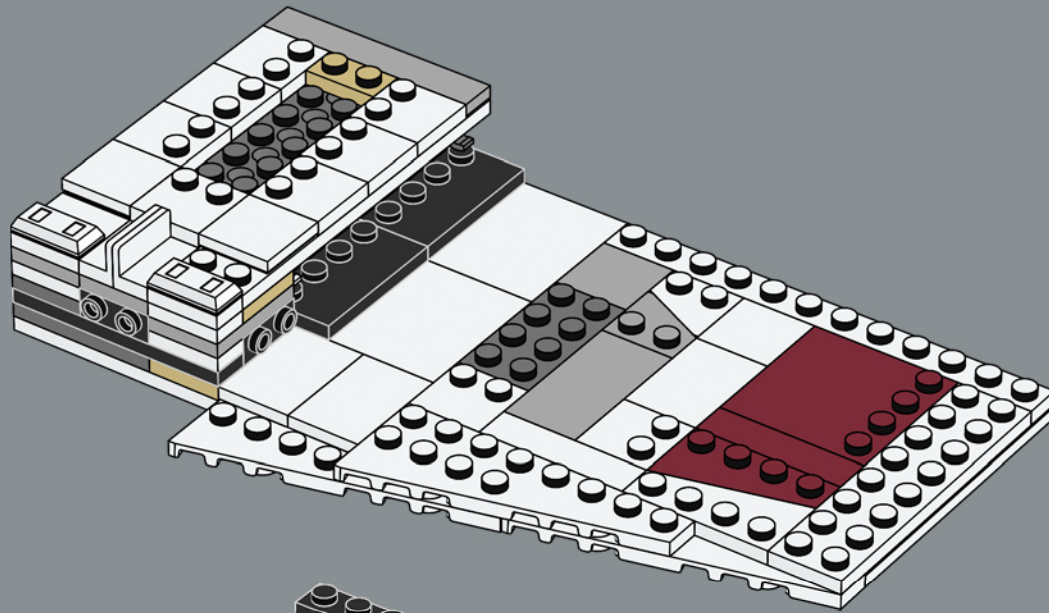

395

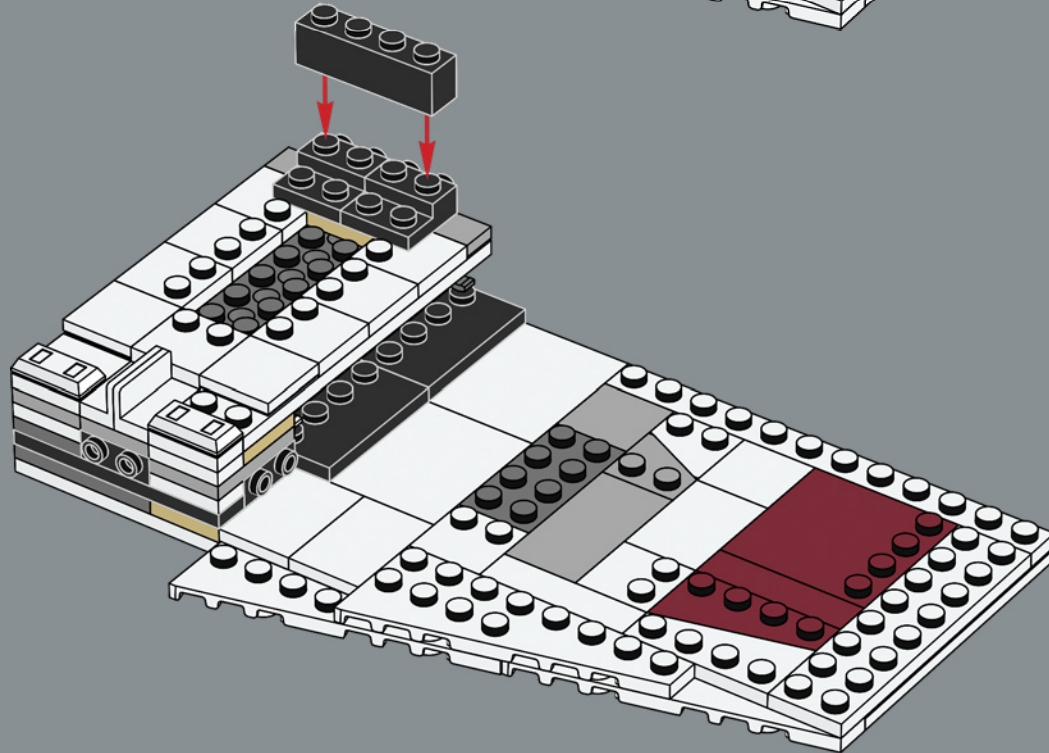



2x

396

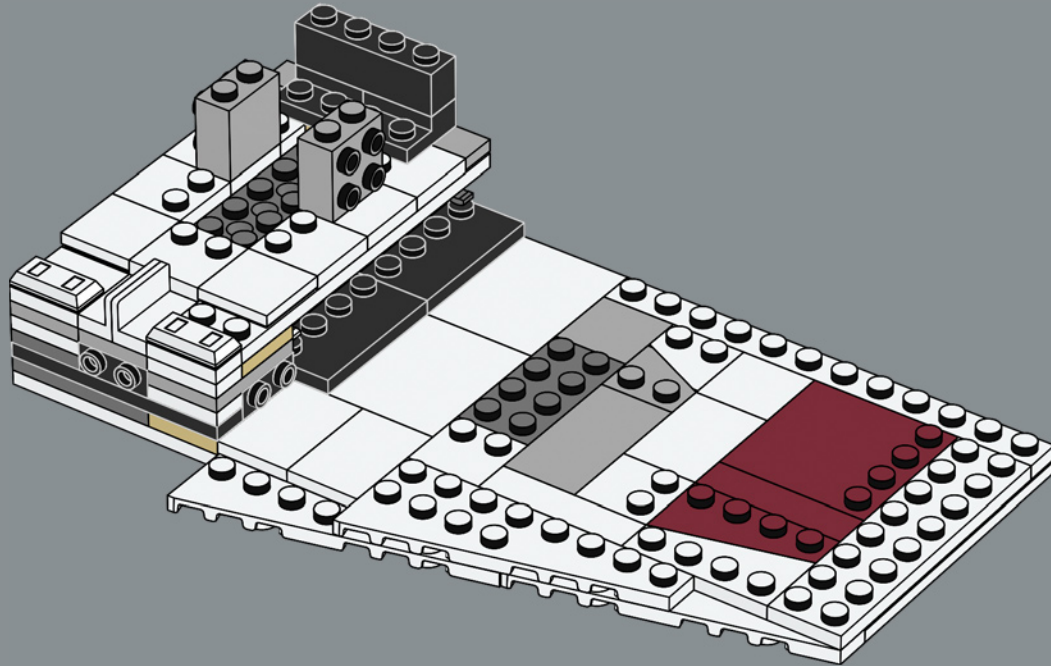

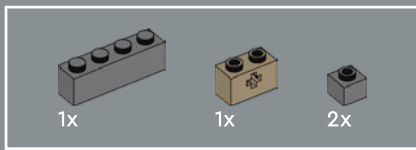

397

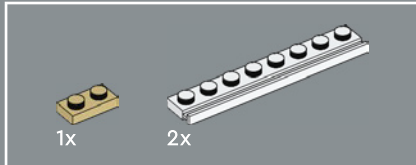
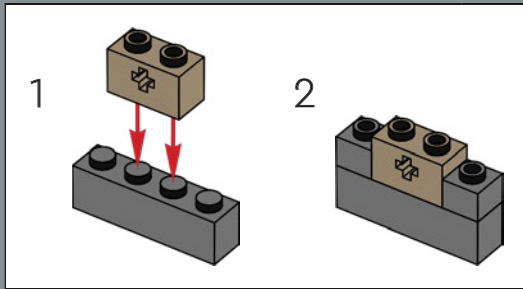

398

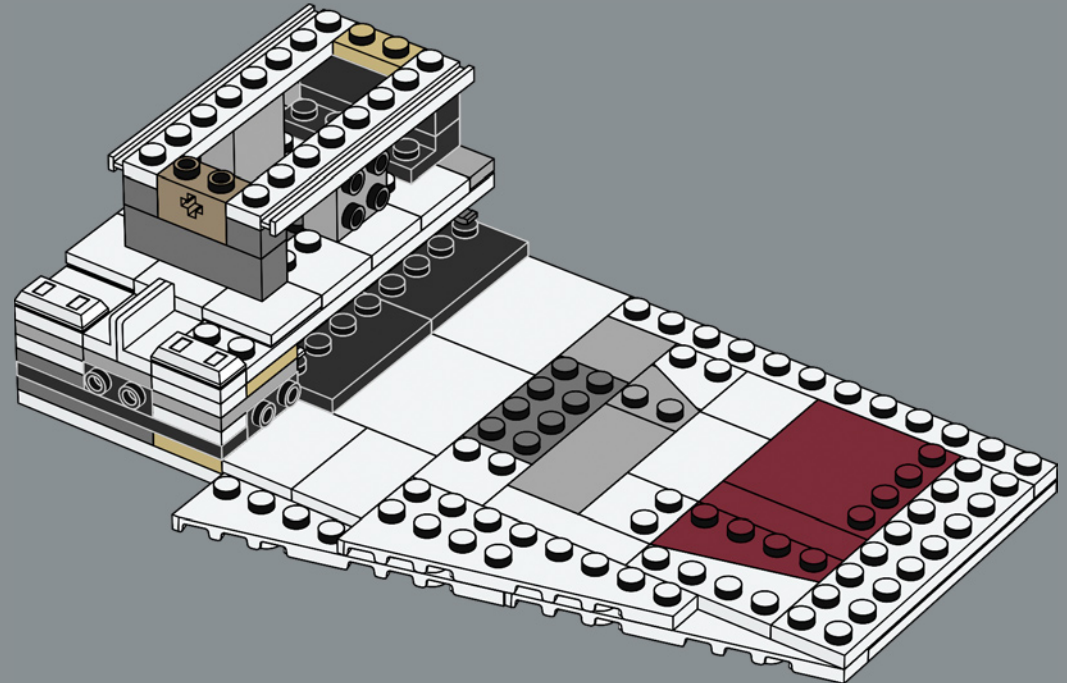
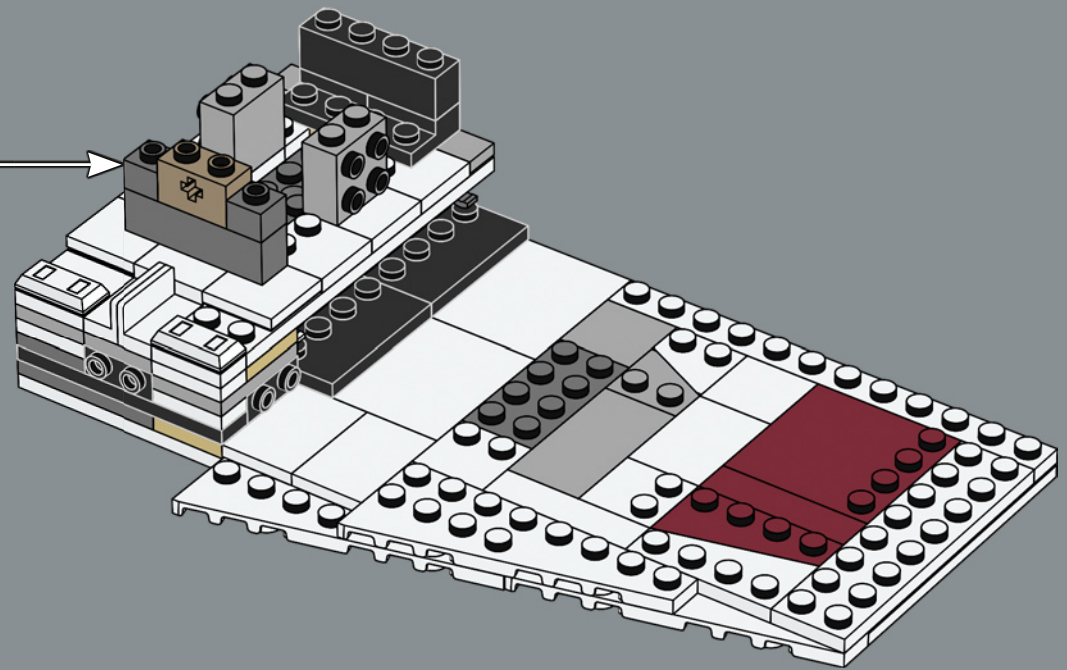

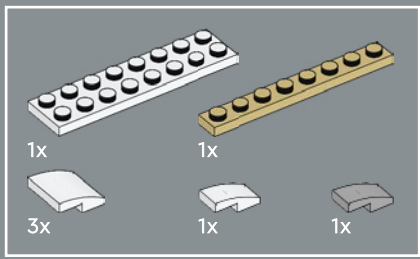

399

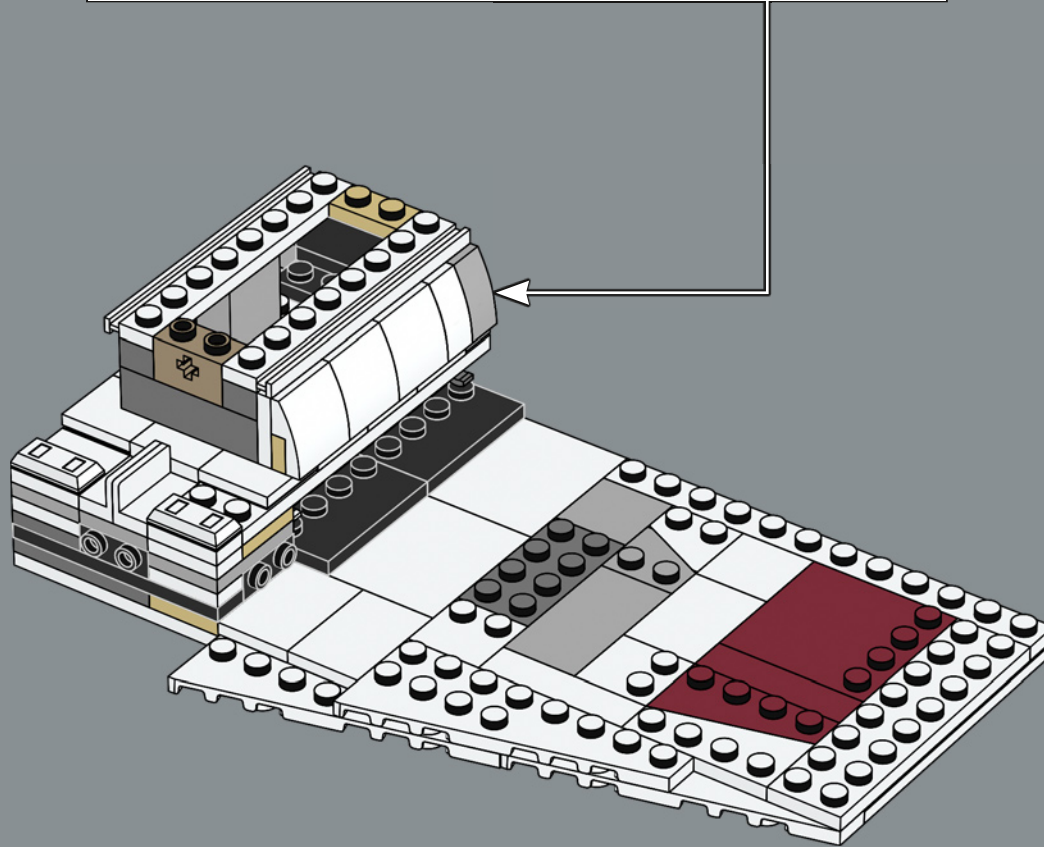
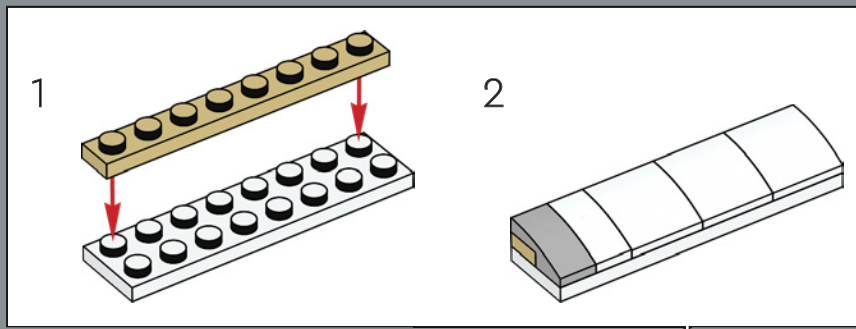

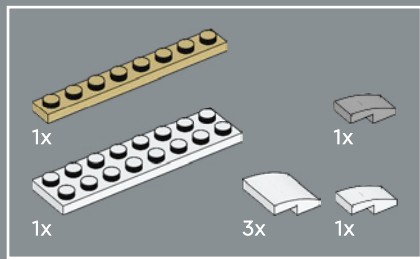

400

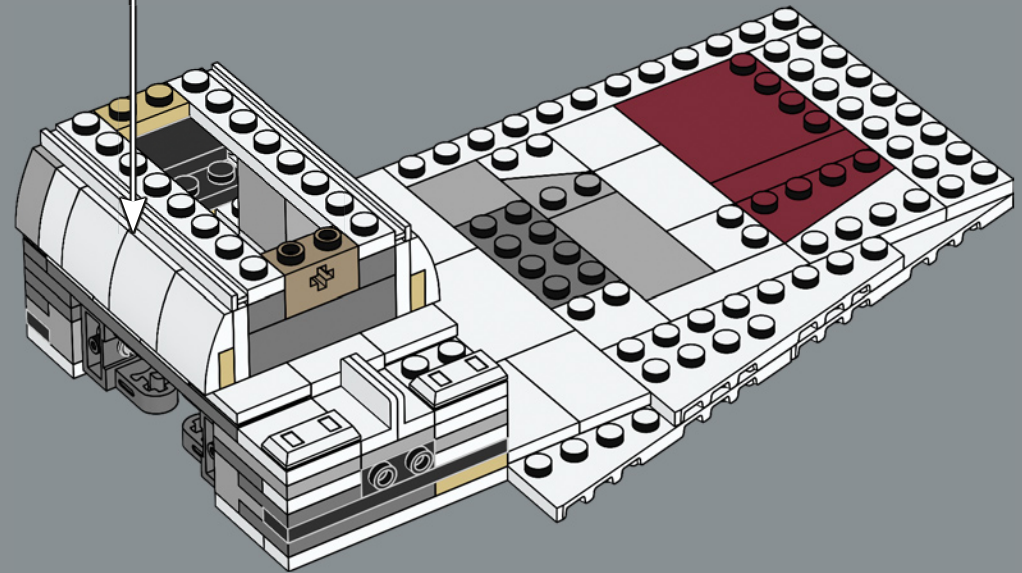
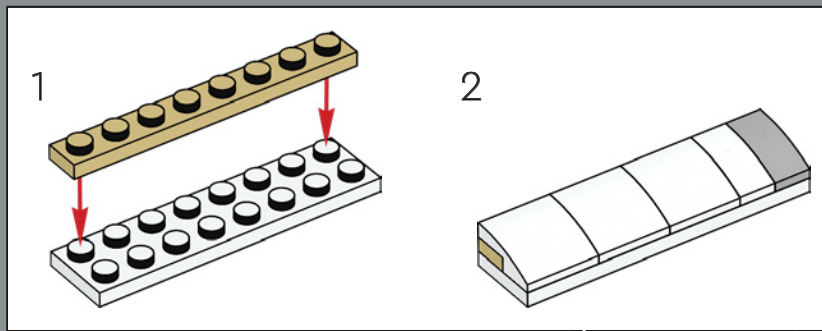

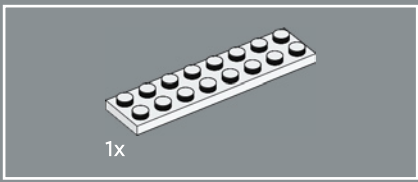

401

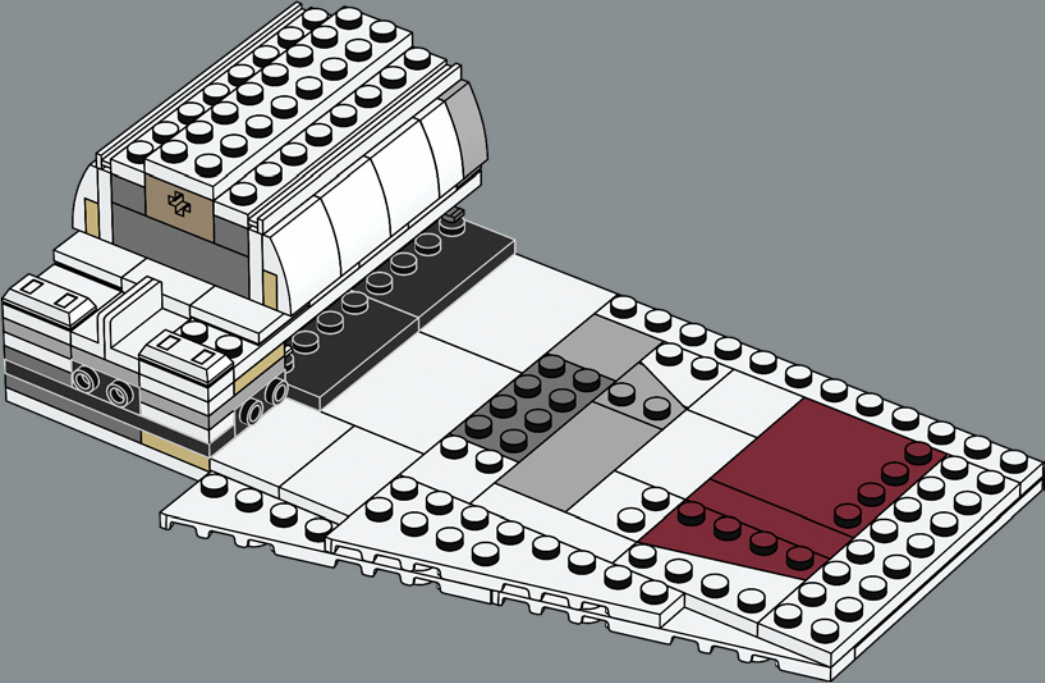



402

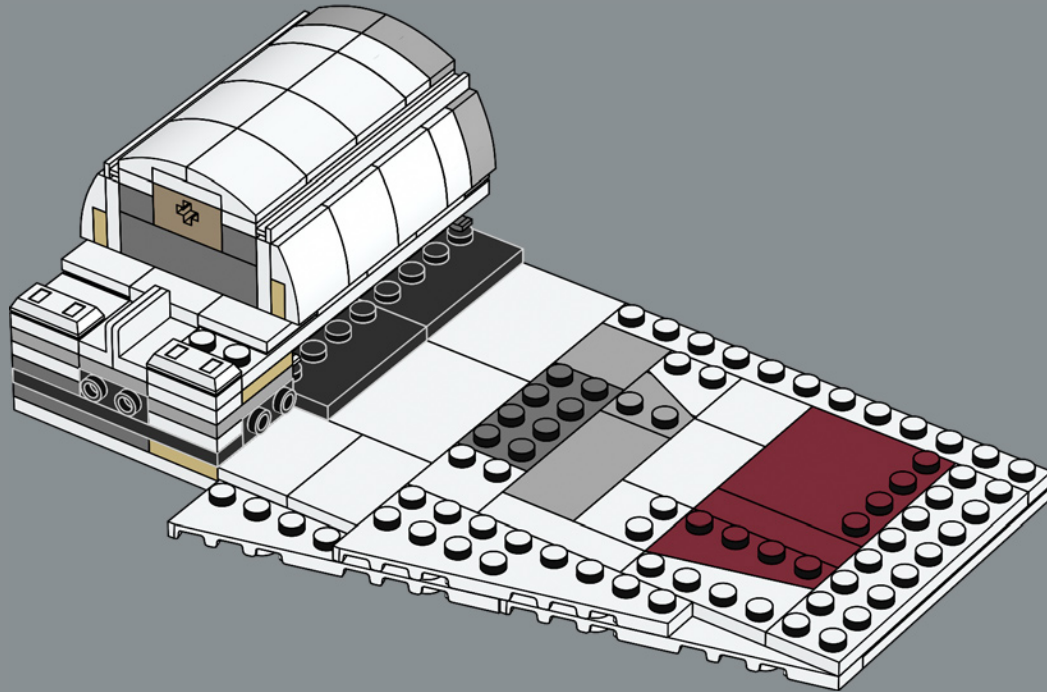

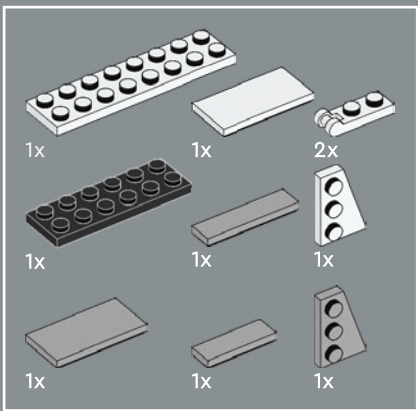

403

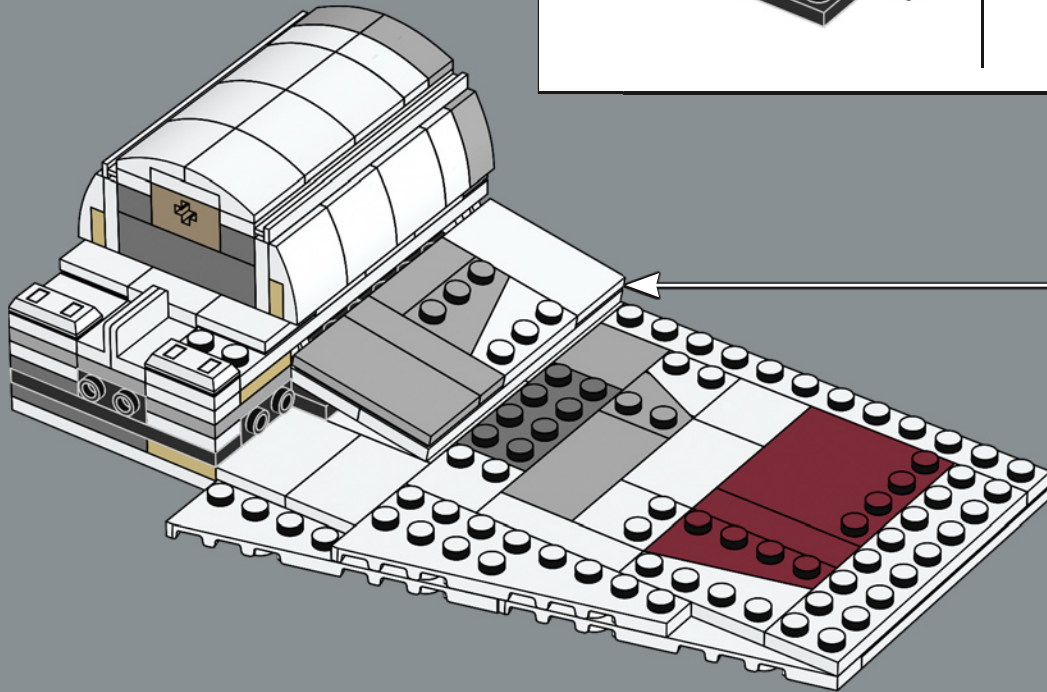
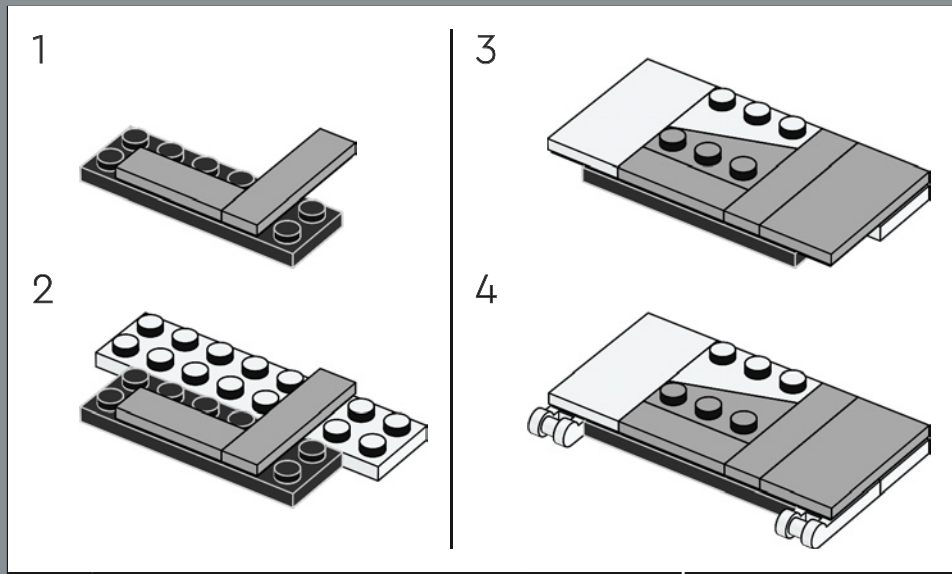

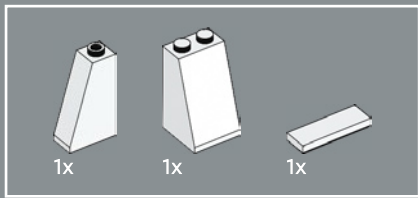

404

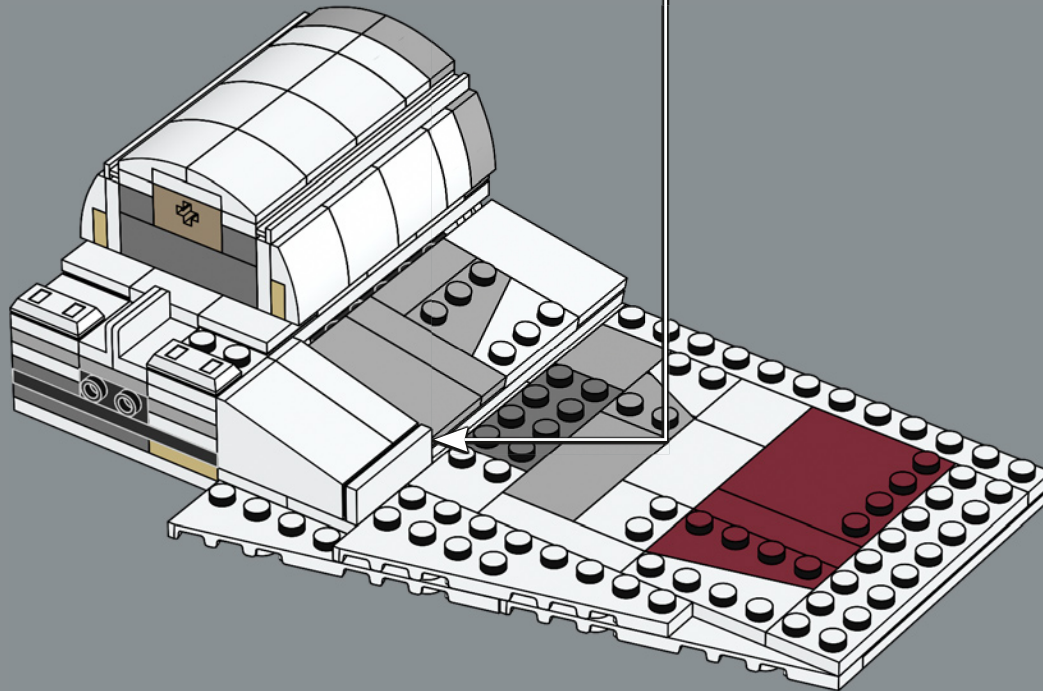
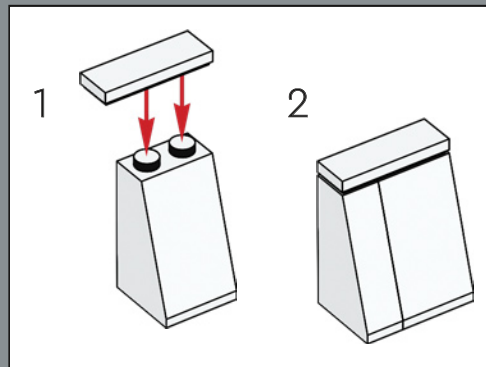

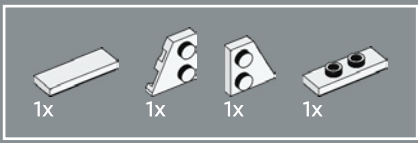

405

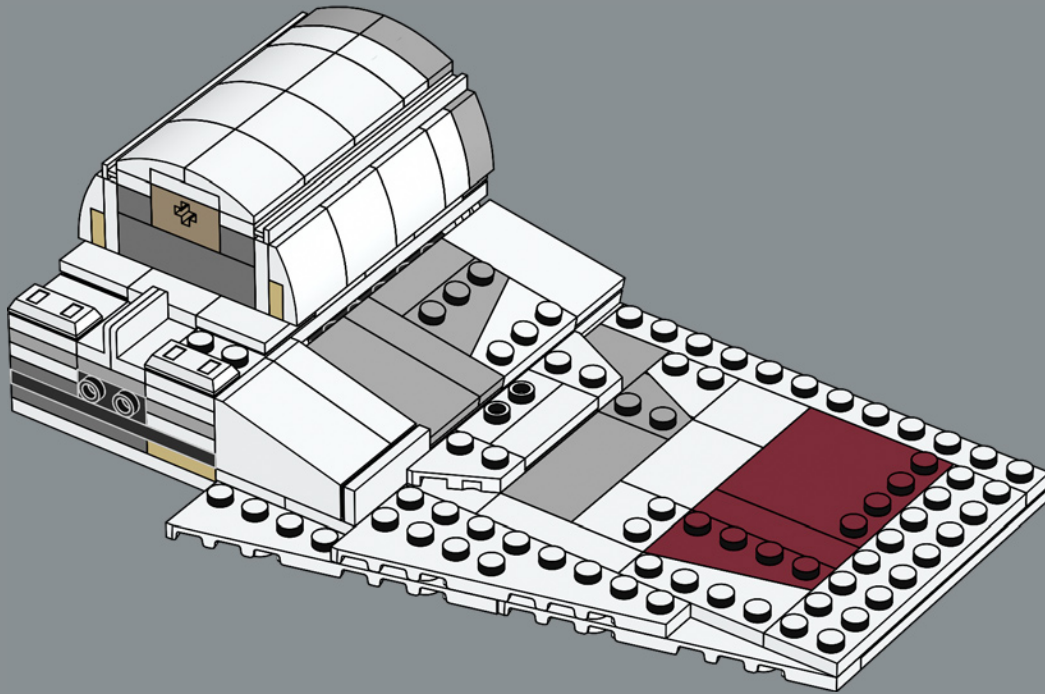

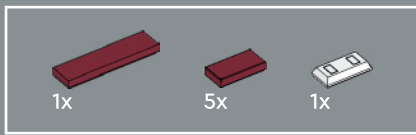

406

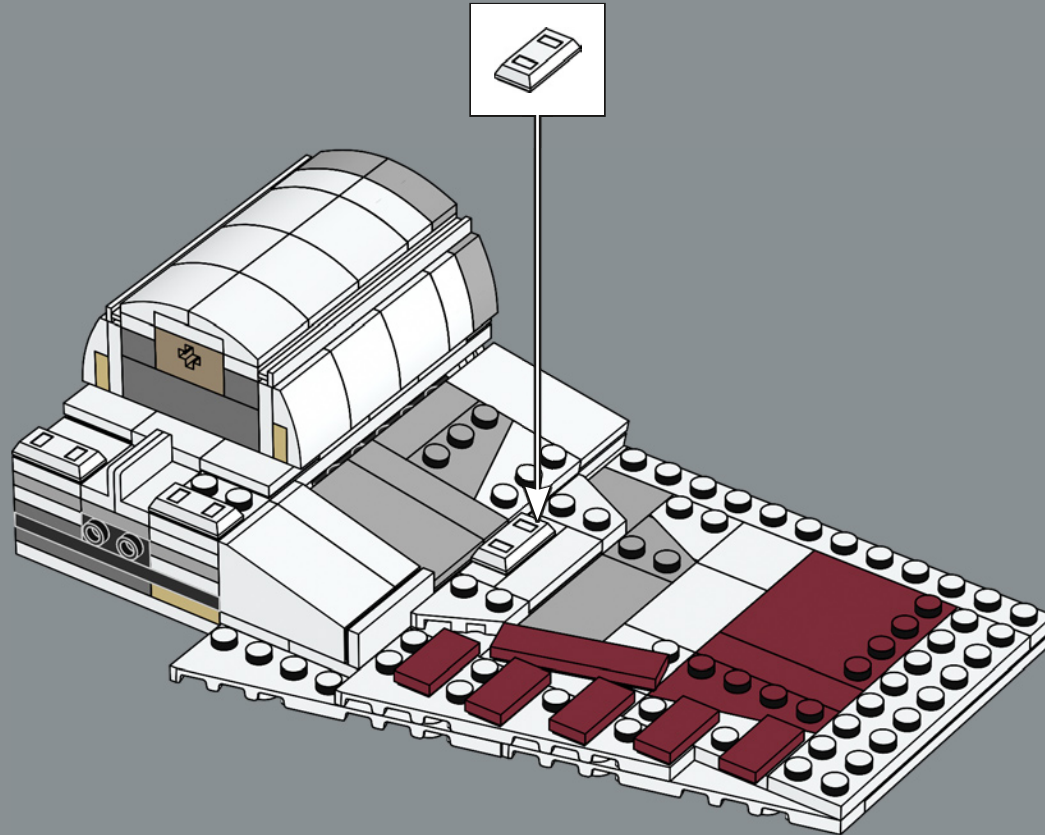

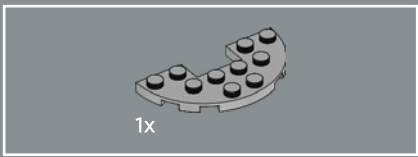

407

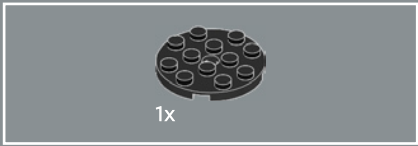
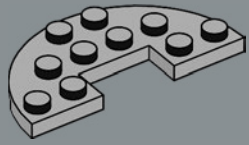

408

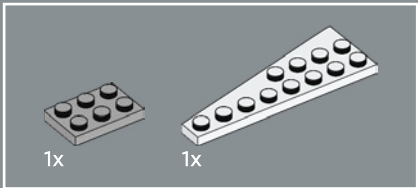
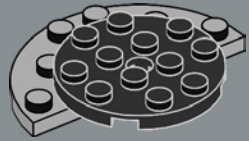

409

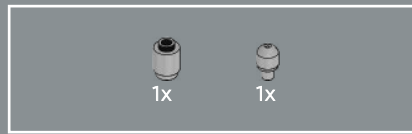
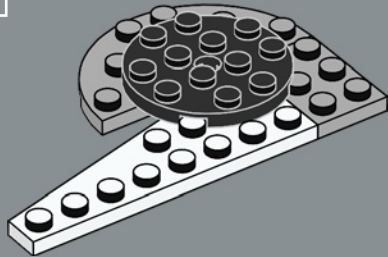

410

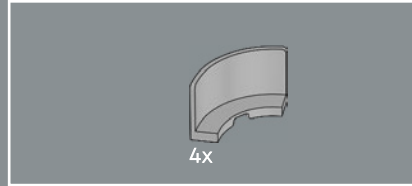
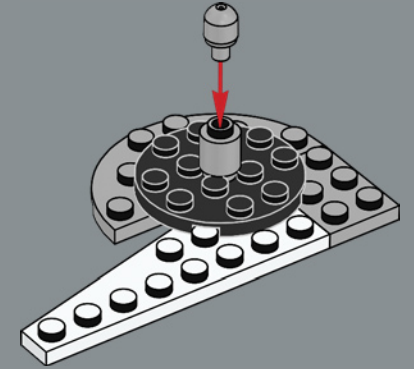

411

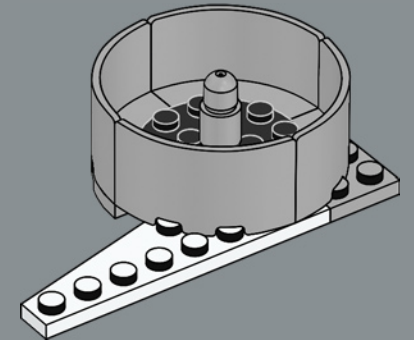

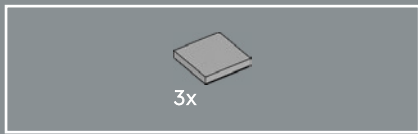

412

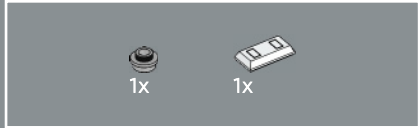
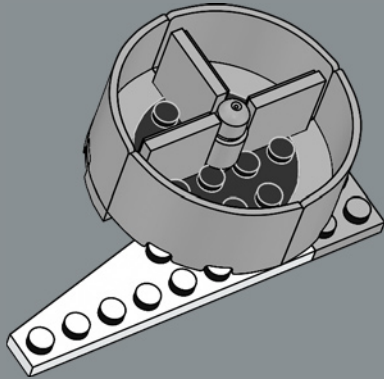

413

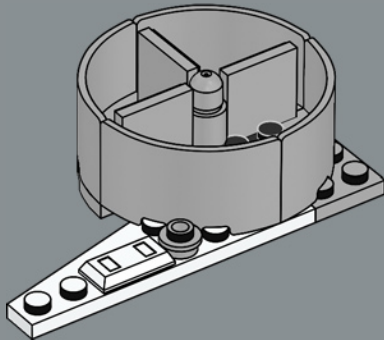

414

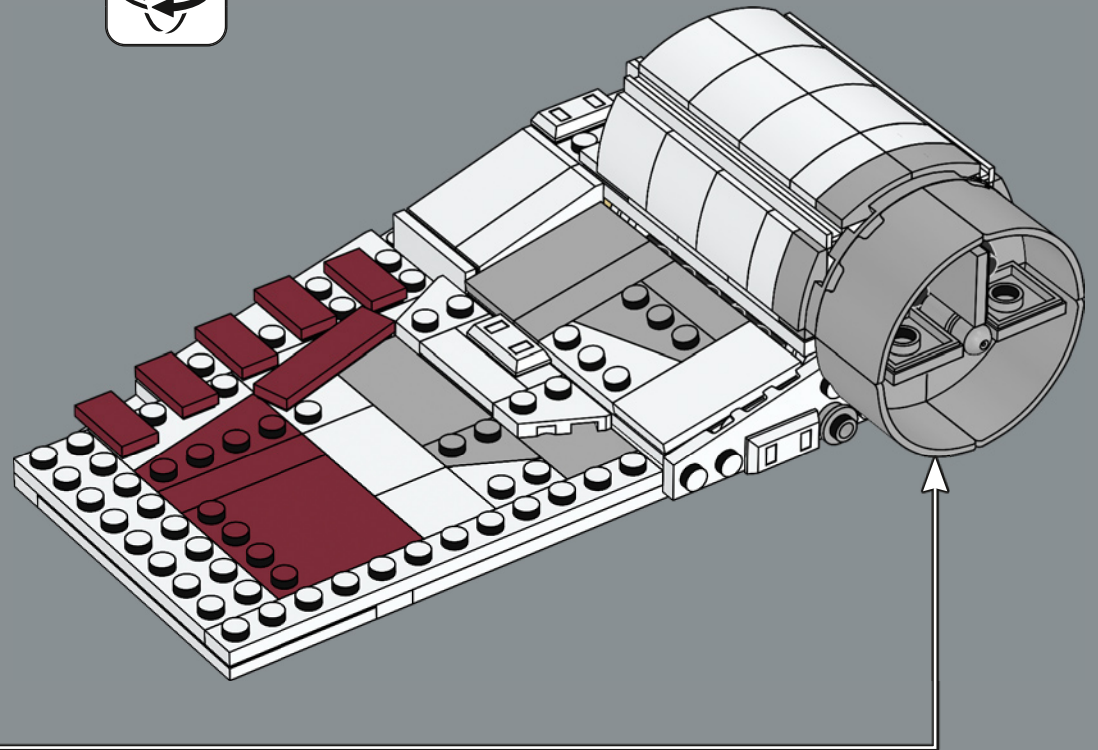

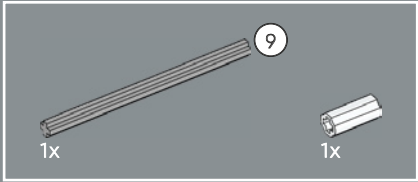
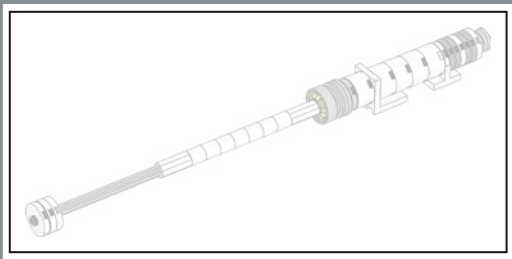

415

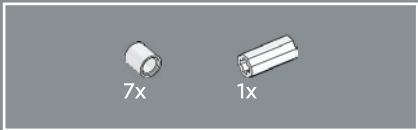
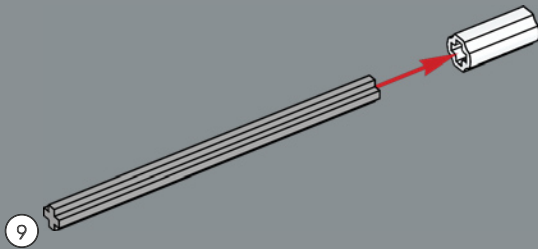

416

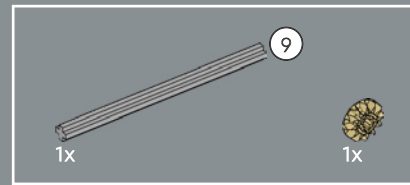
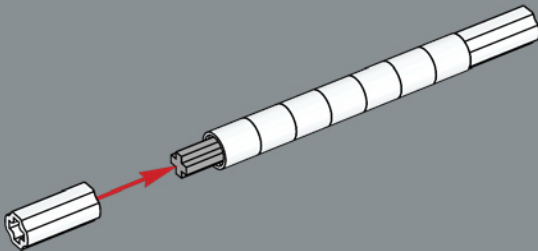

417

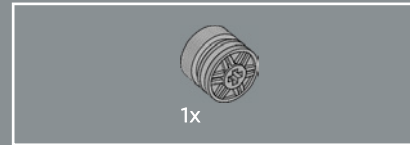
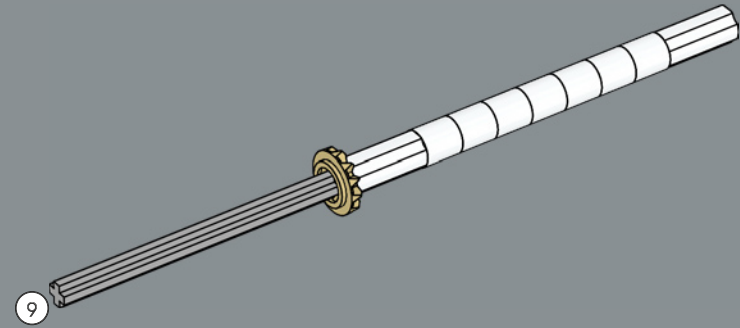

418

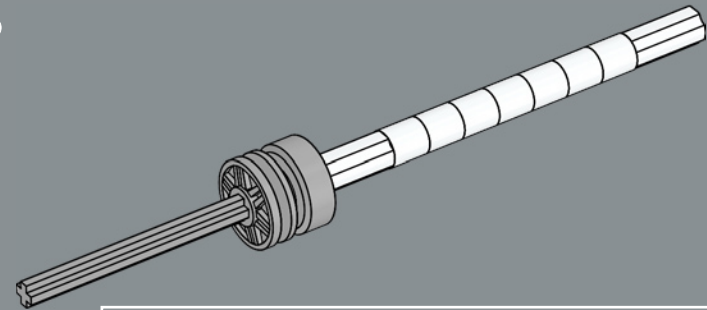

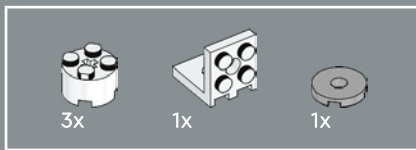

419

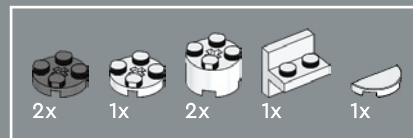
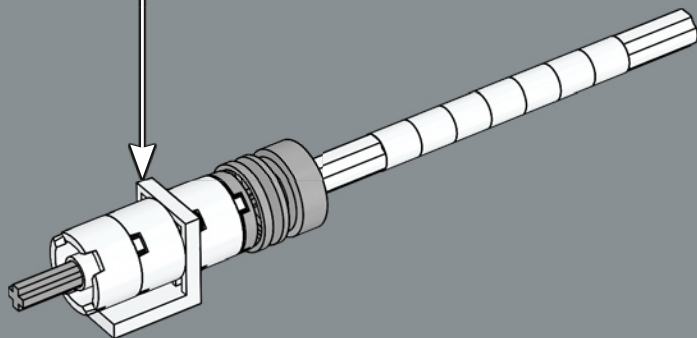
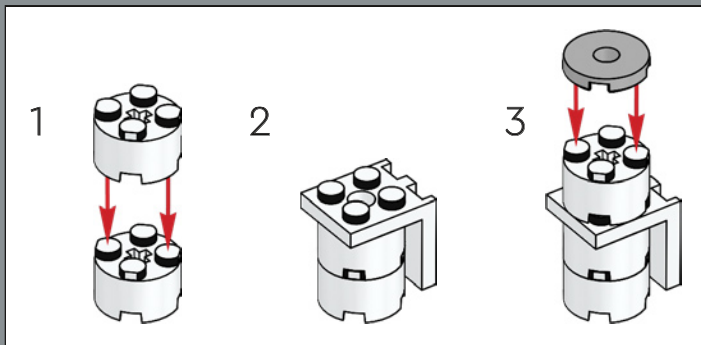

420

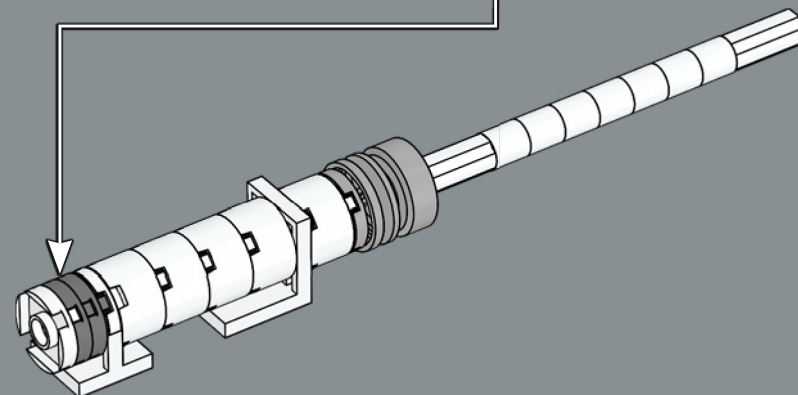
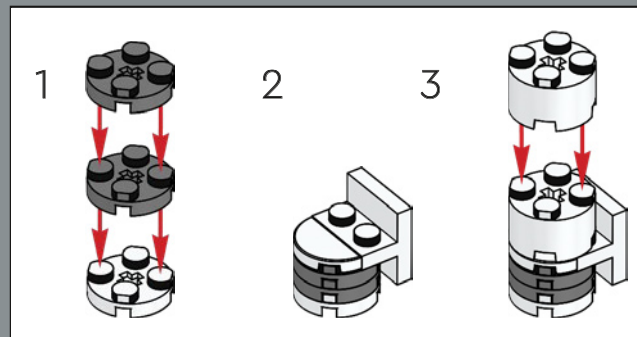



421

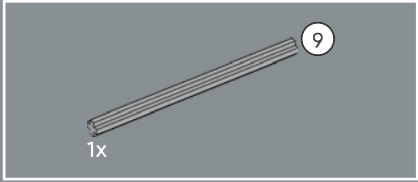
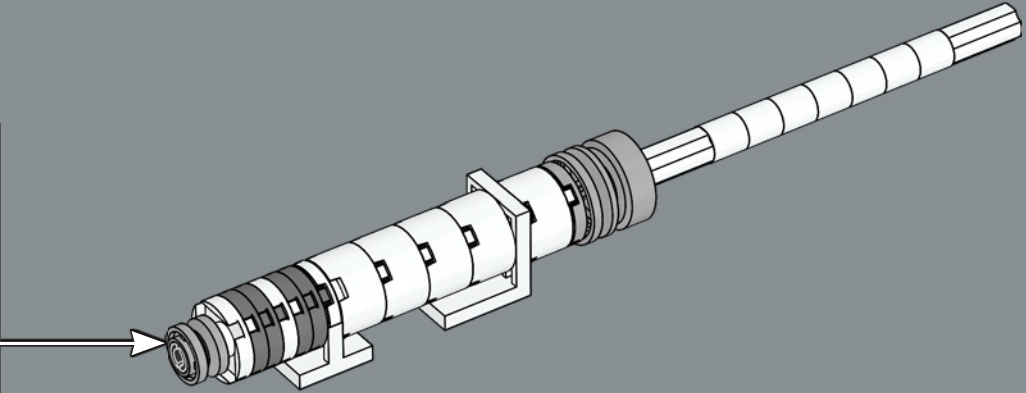
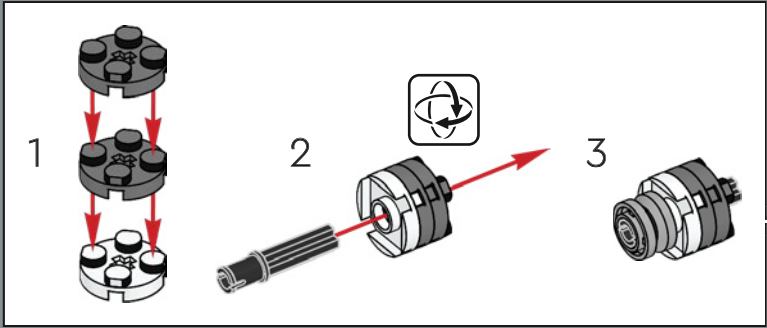

422

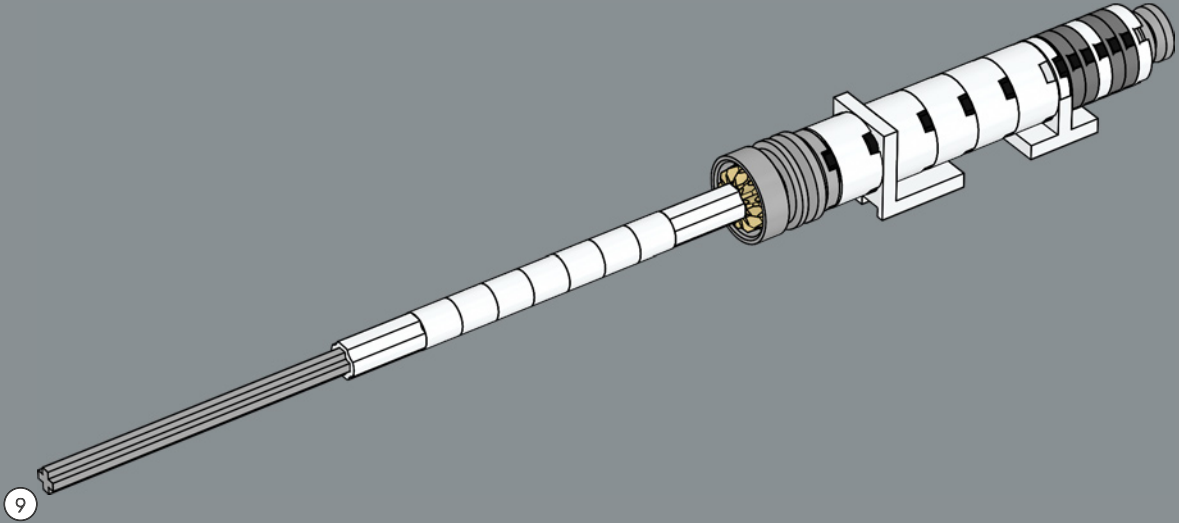

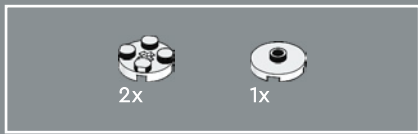

423

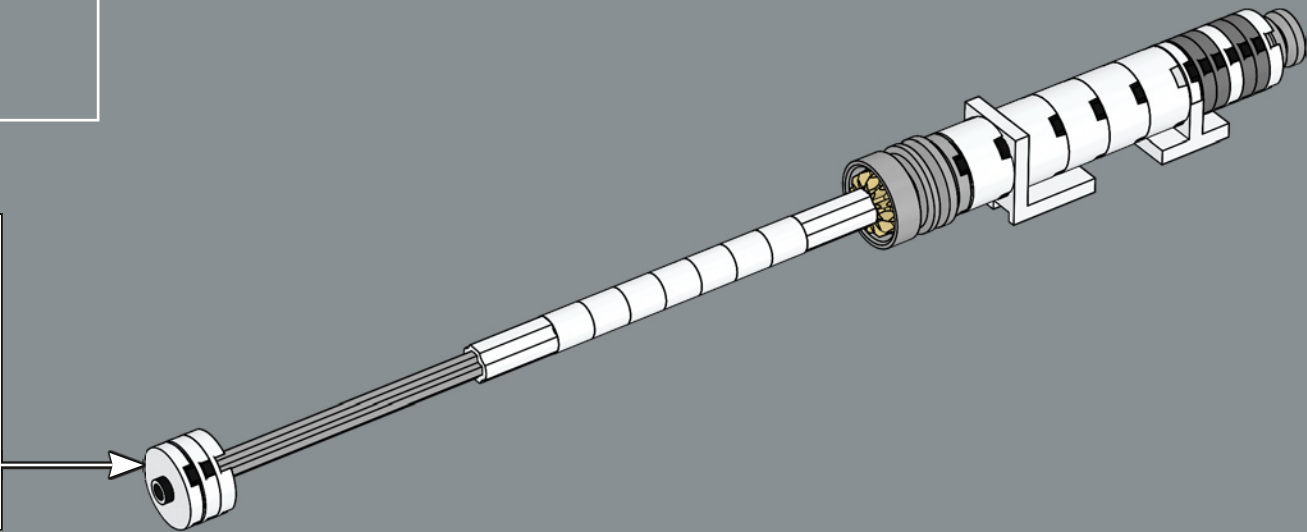
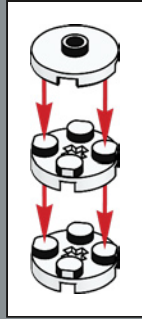

424

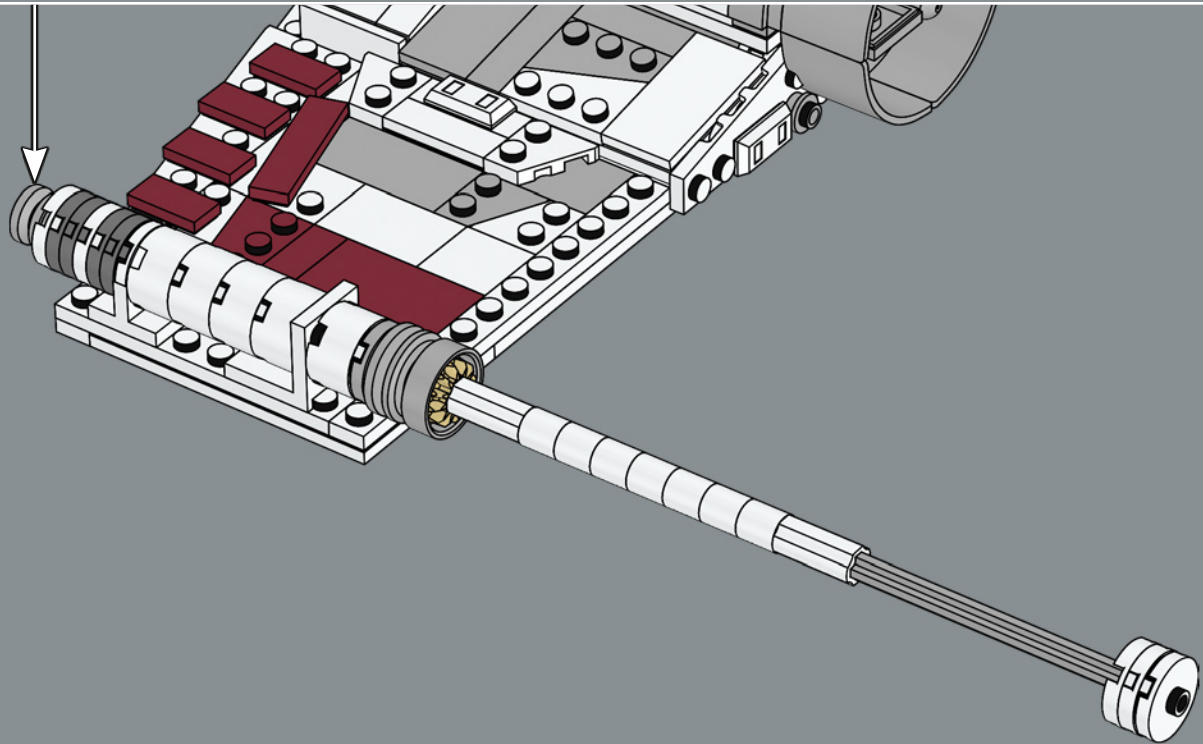

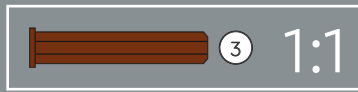
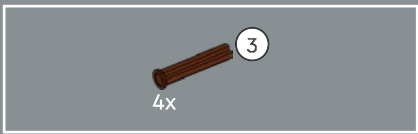

425

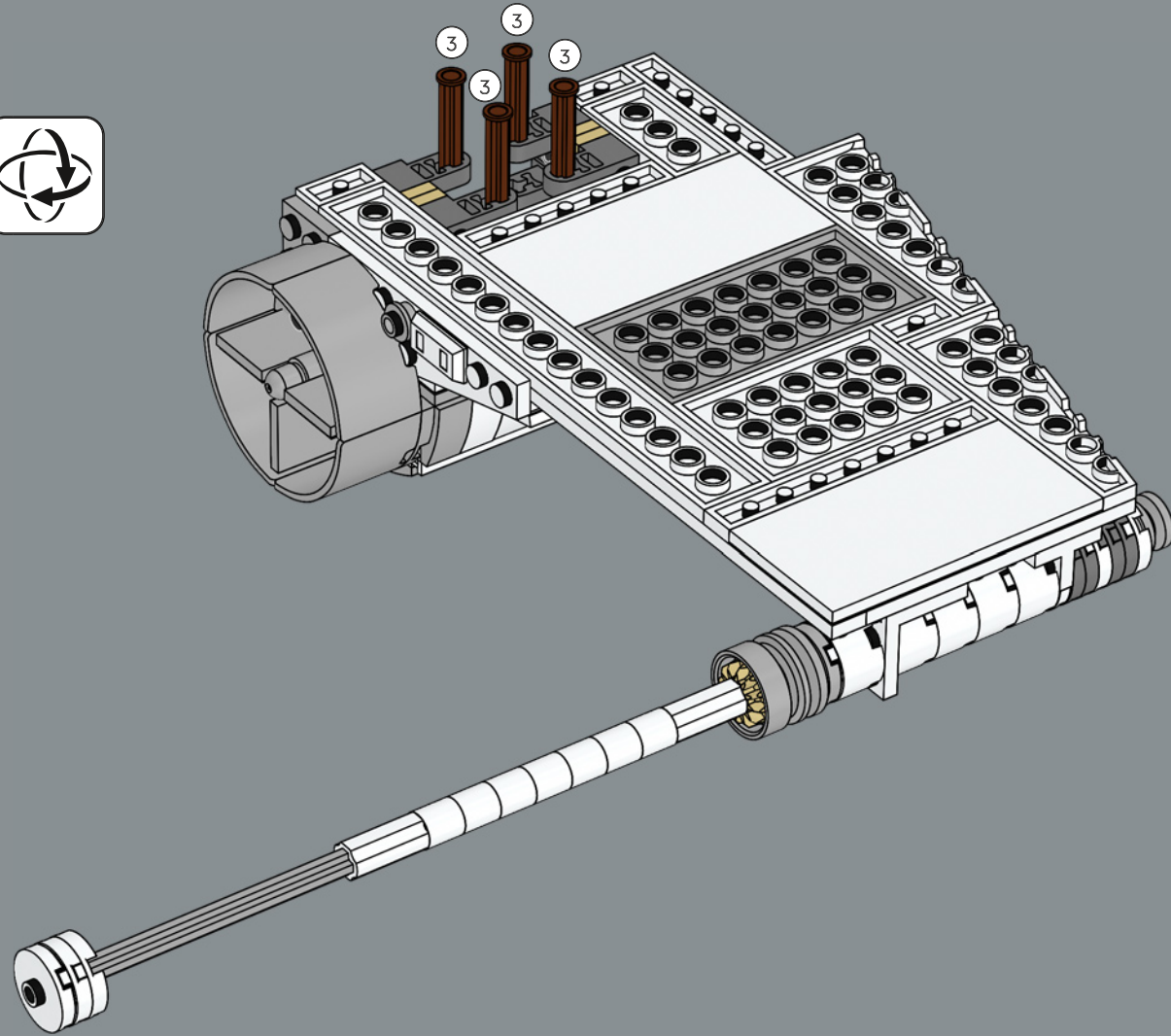

426

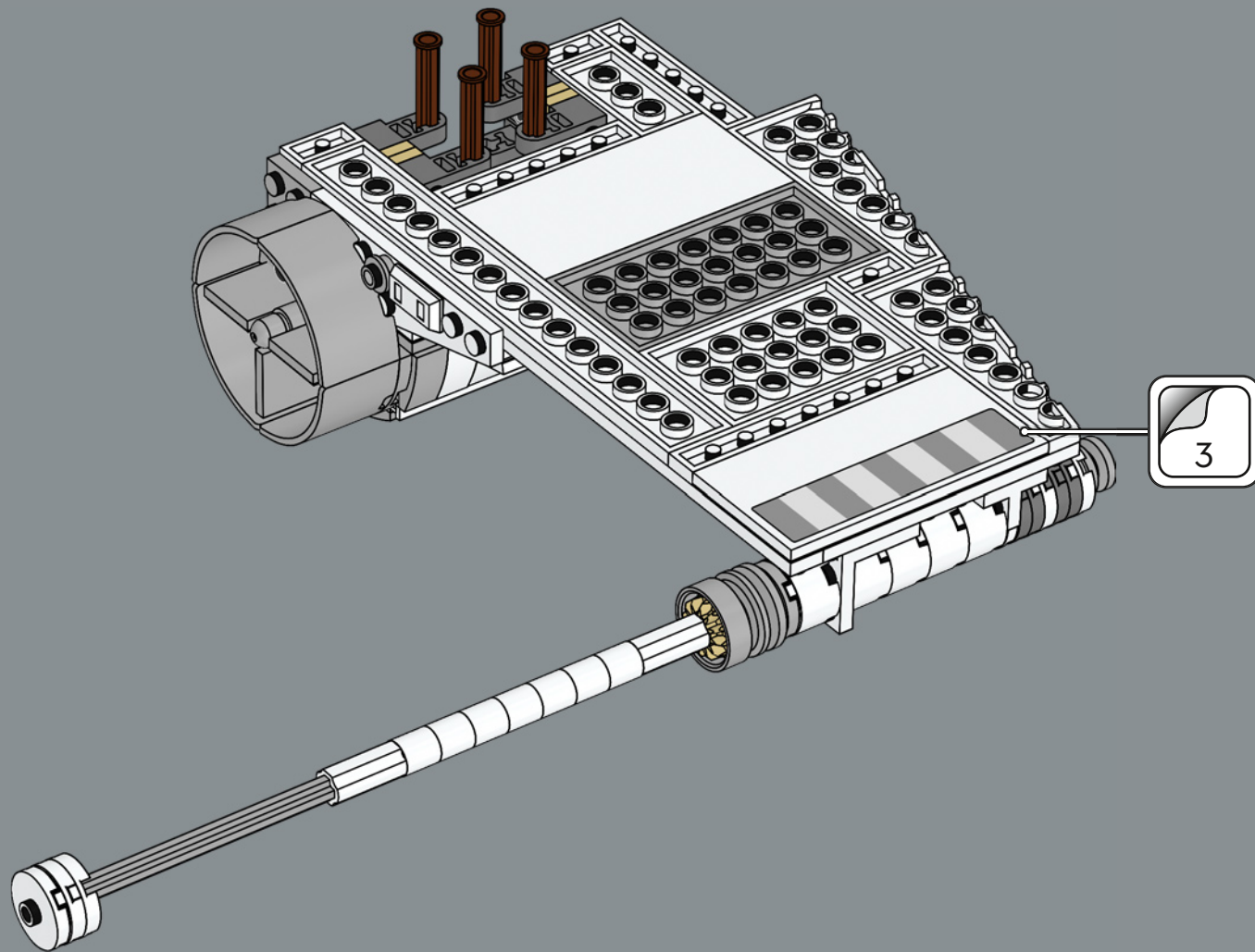

427

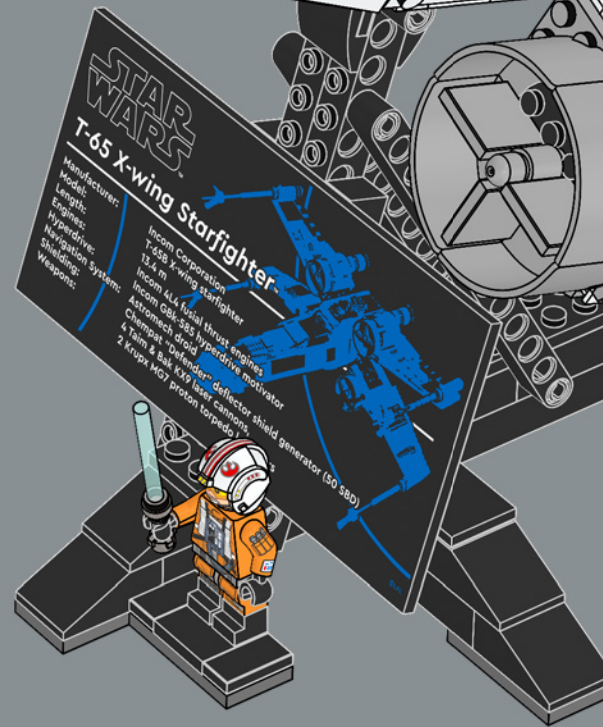

STAR WARS
T-65 X-wing Starfighter

Manufacturer:
Model:
Length:
Engines:
Hyperdrive:
Navigation
shielding:
Weapons:

Incom Corporation
T-65 X-wing starfighter
13.4 m
Incom 4L4 axial thrust engine
Incom G4K-35 hyperdrive
Astromech droid
Chempat Defender
2 Twin & Bak K19 laser cannons
2 Krux MG7 proton torpedos

deflector shield generator (50 SBD)

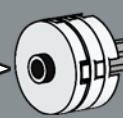

- 1x 
- 2x 
- 1x 
- 2x 

427

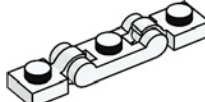
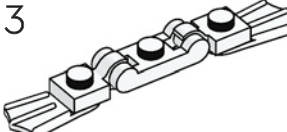
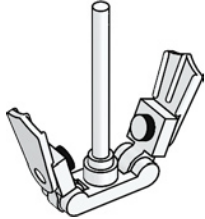
- 1 
- 2 
- 3 
- 4 

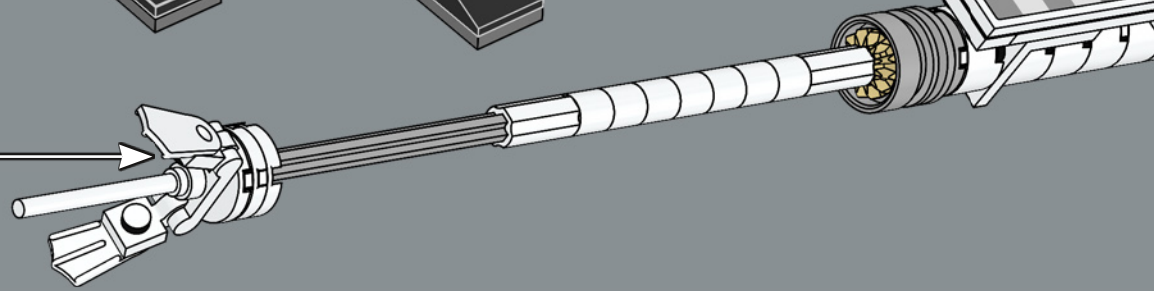
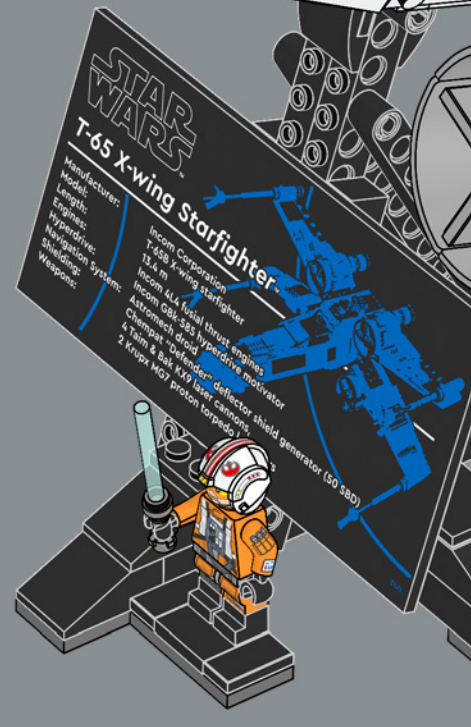

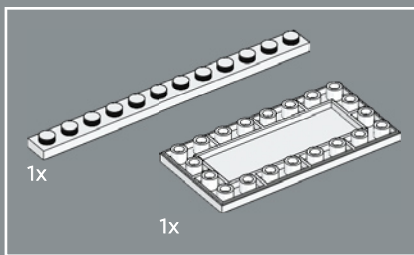

429

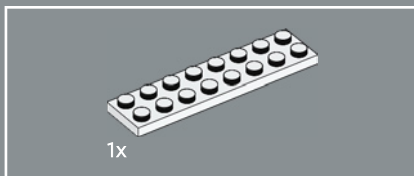
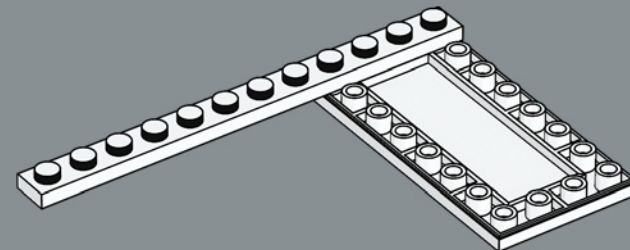

430

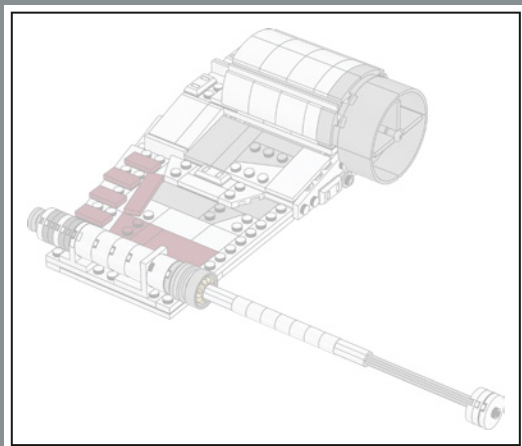
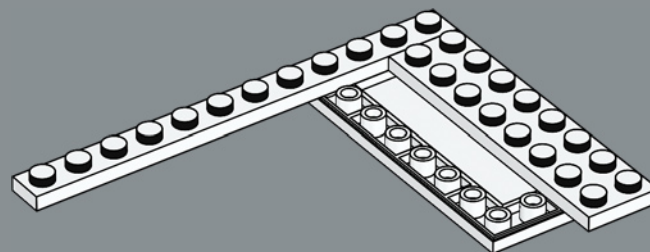

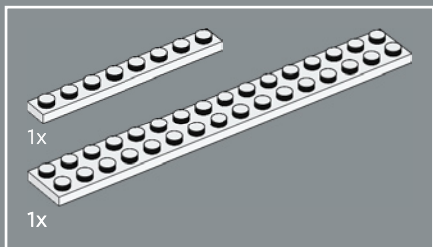

431

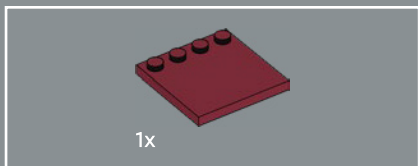
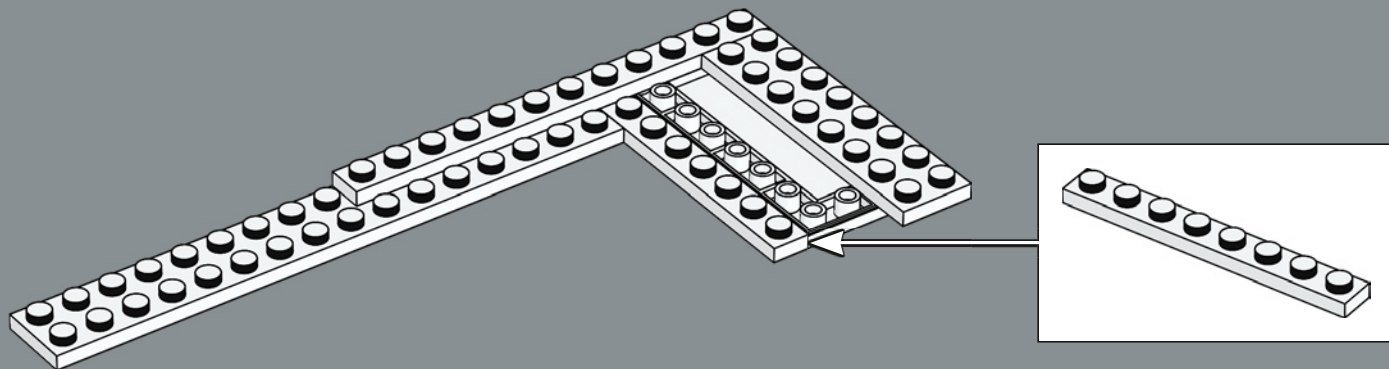

432

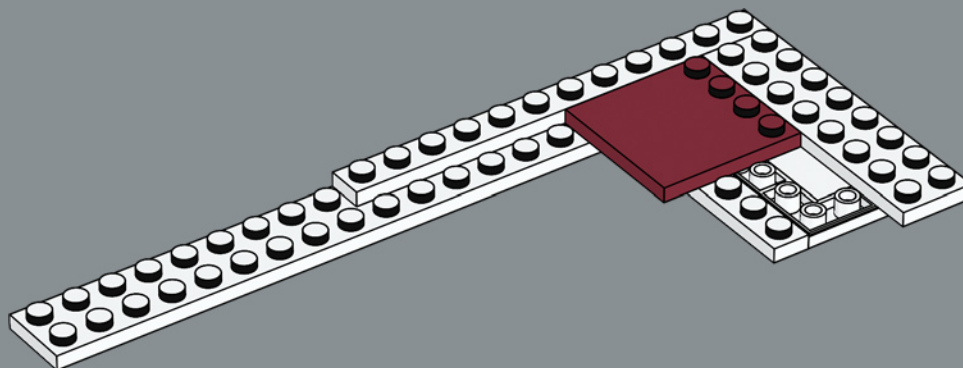

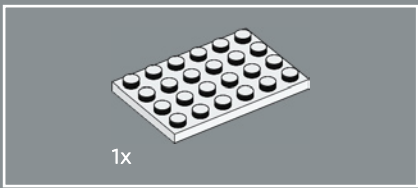

433

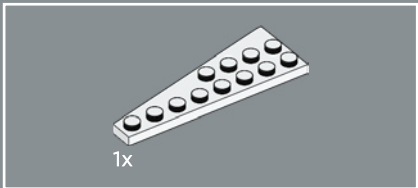
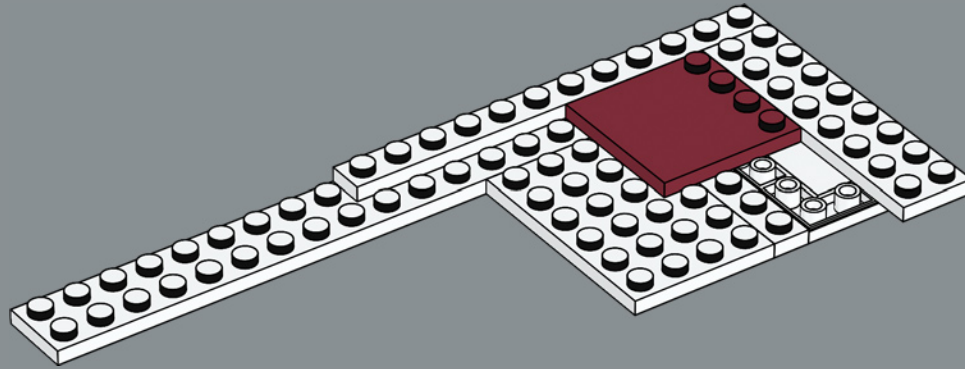

434

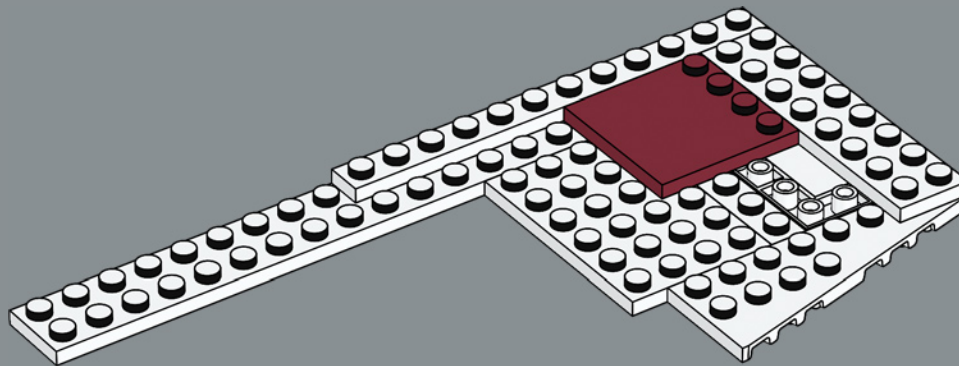

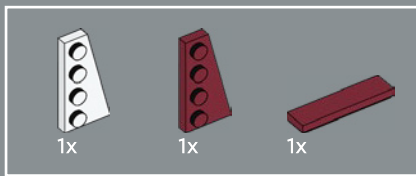

435

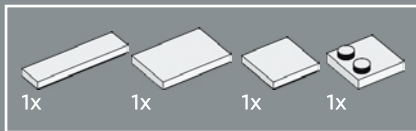
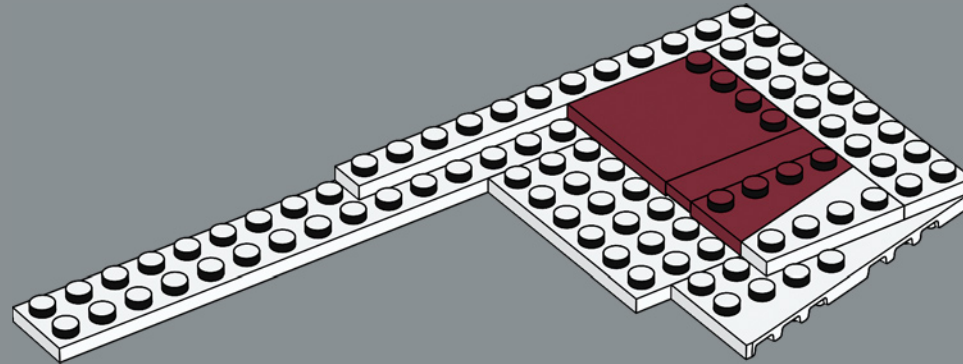

436

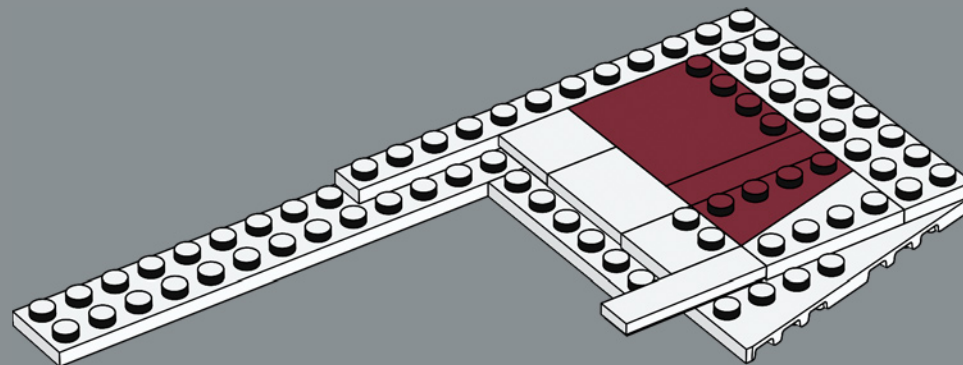

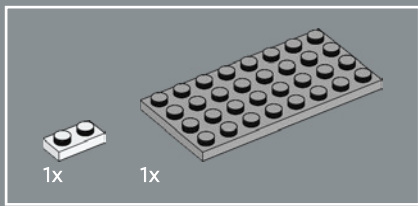

437

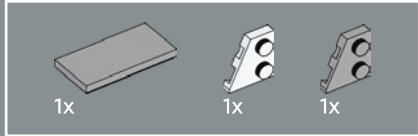
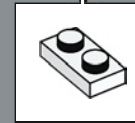
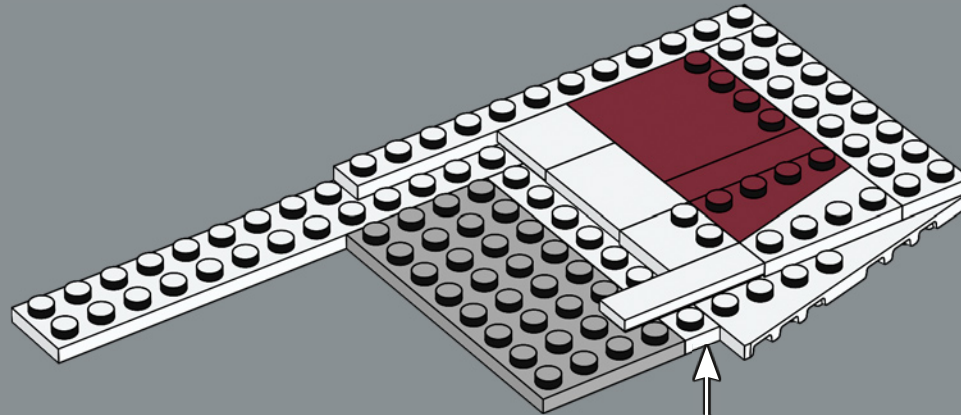

438

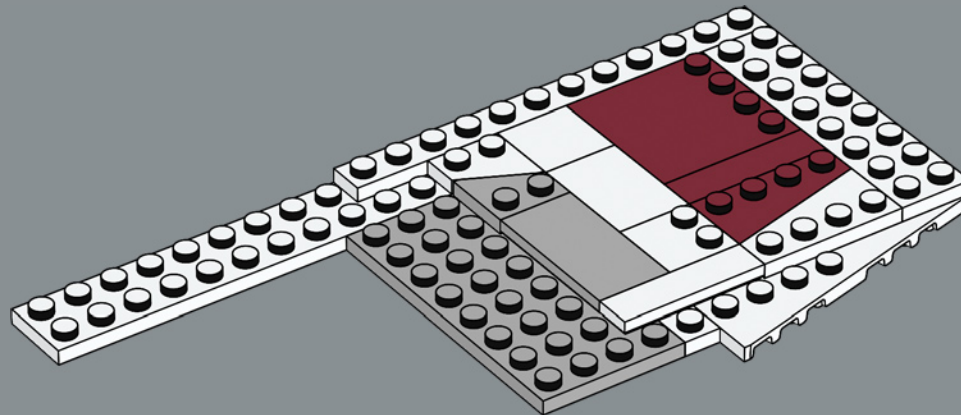

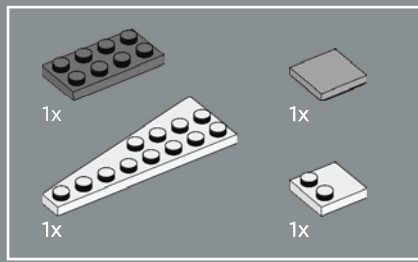

439

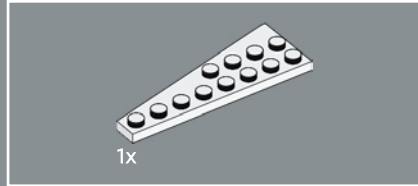
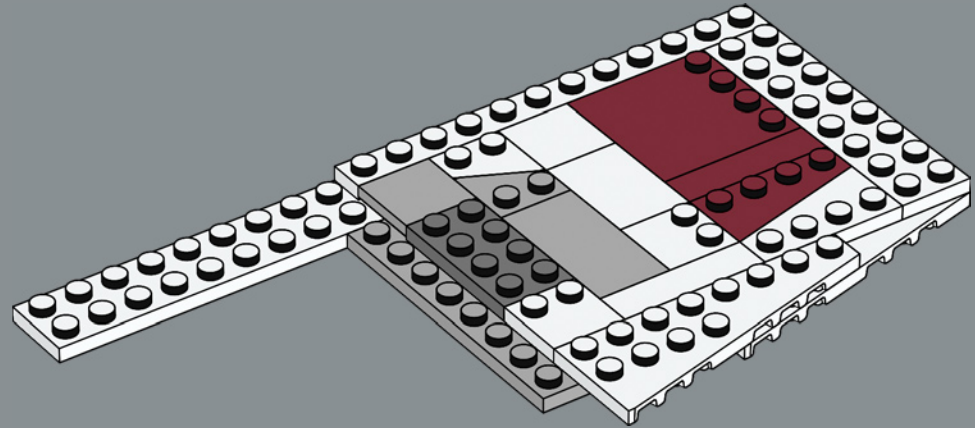

440

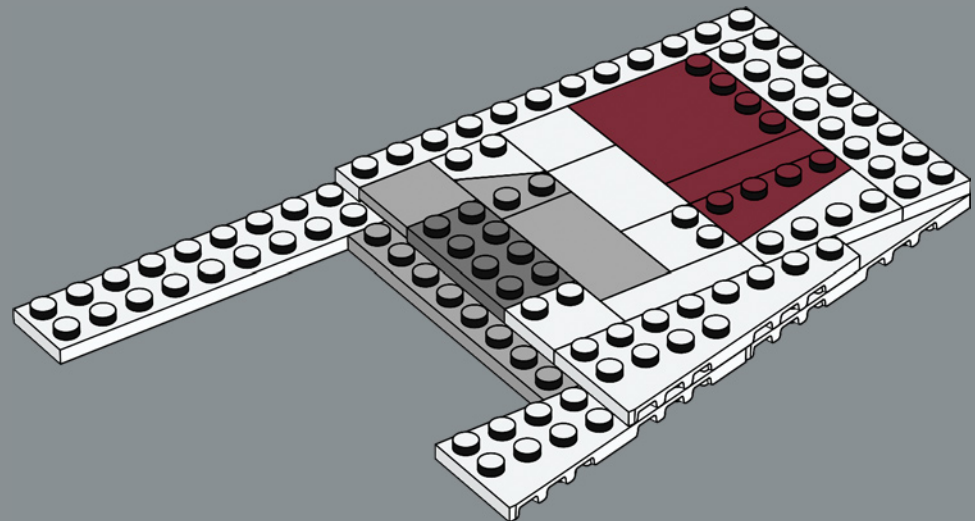

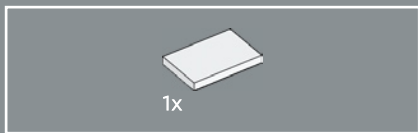

441

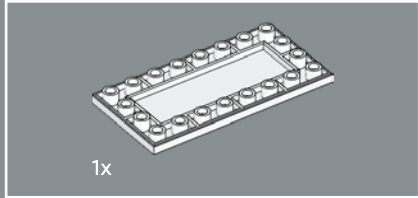
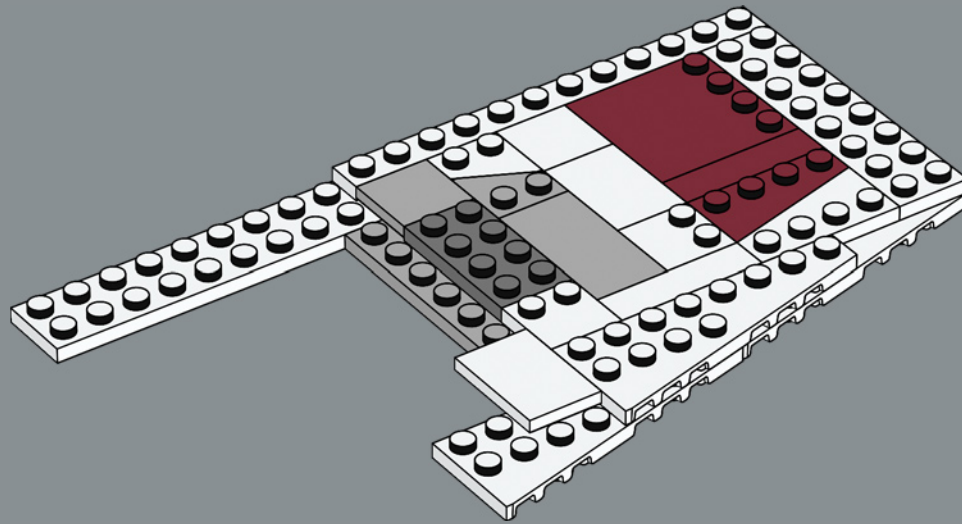

442

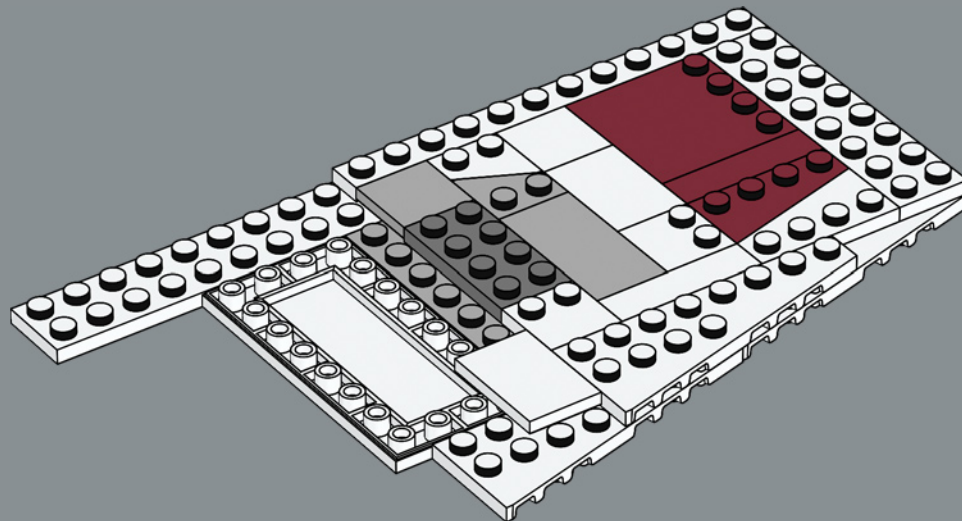

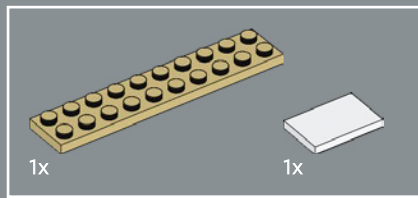

443

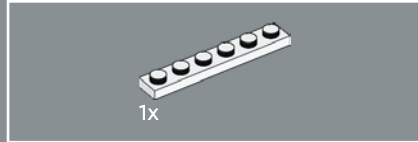
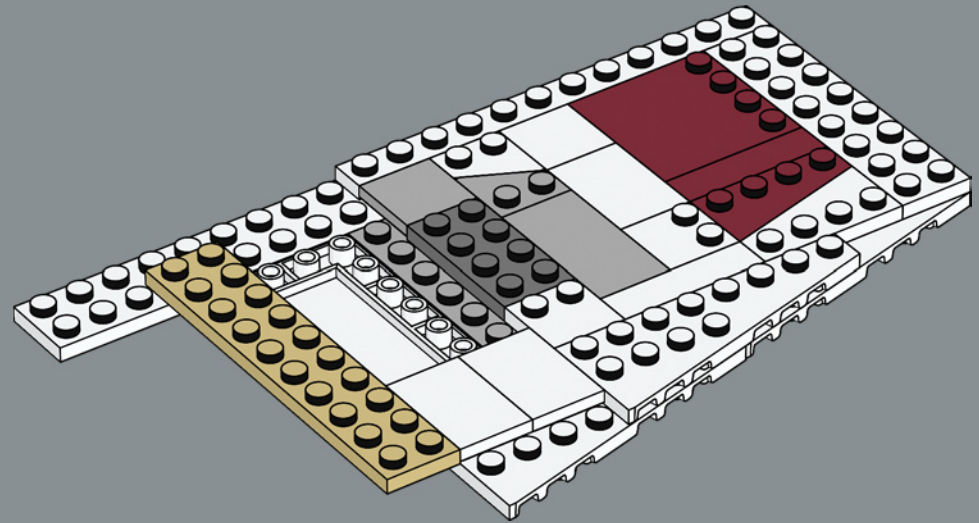

444

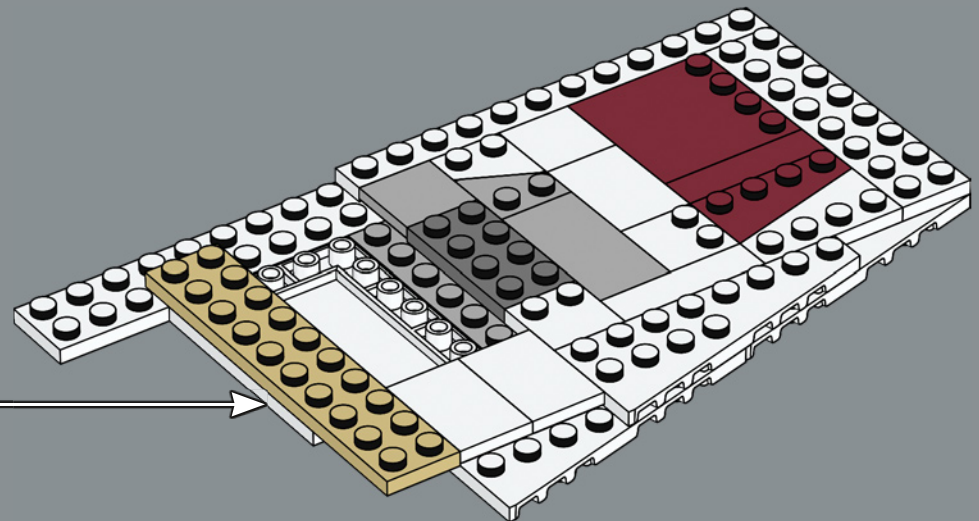
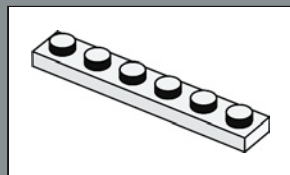

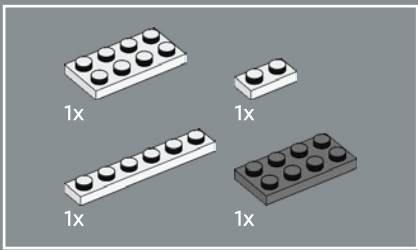

445

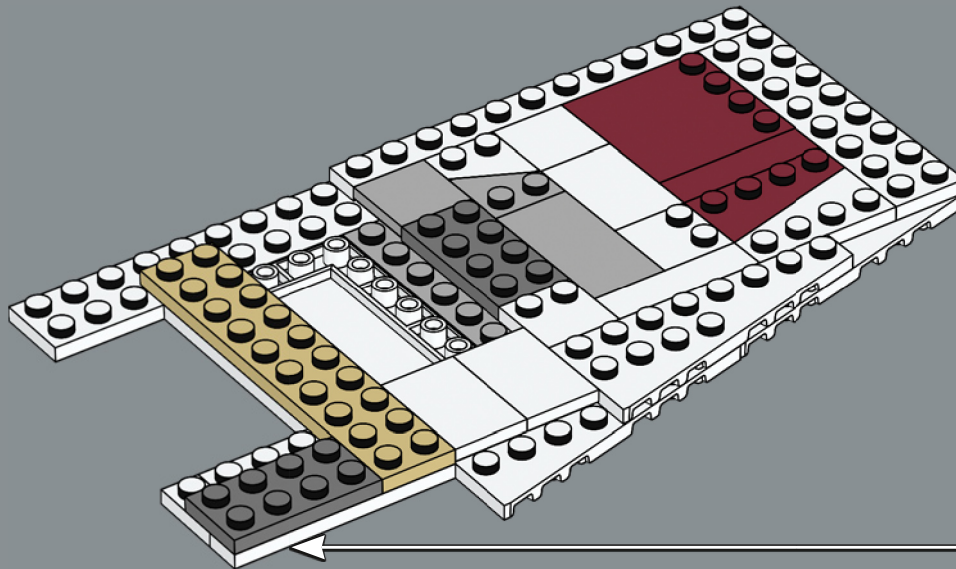
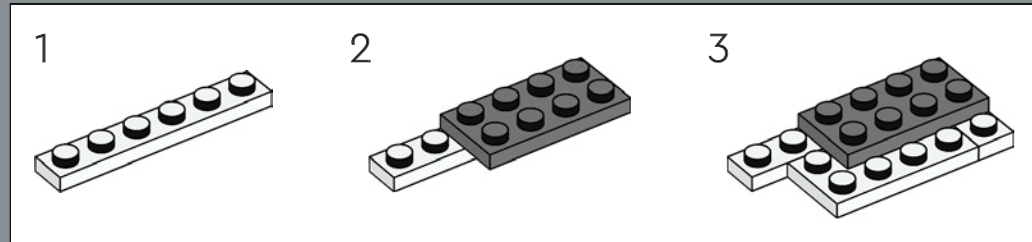

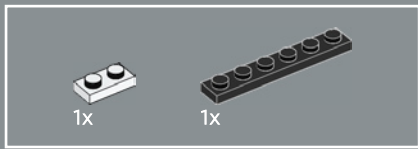

446

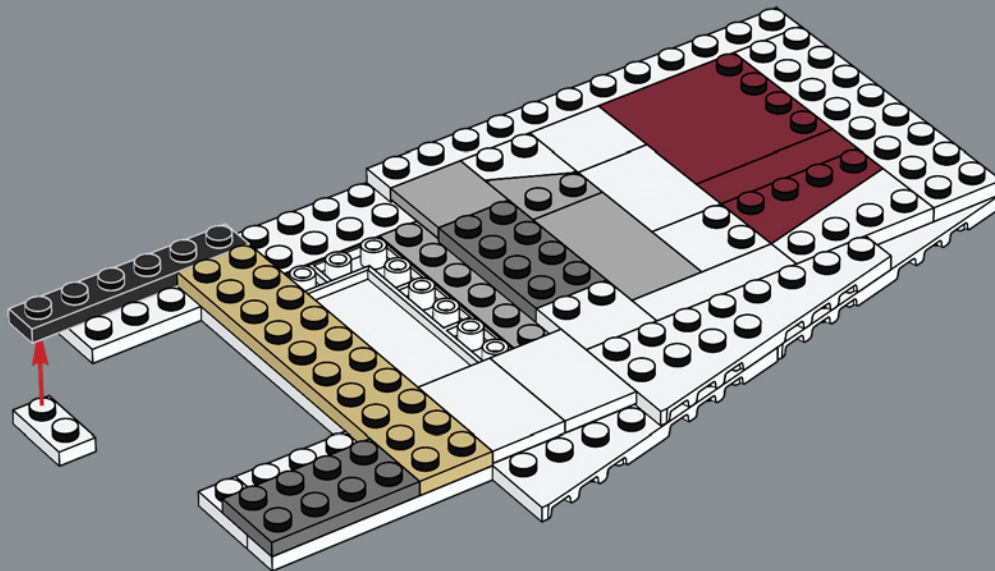

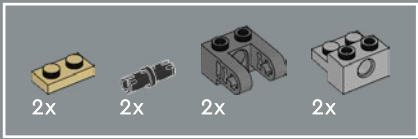

447

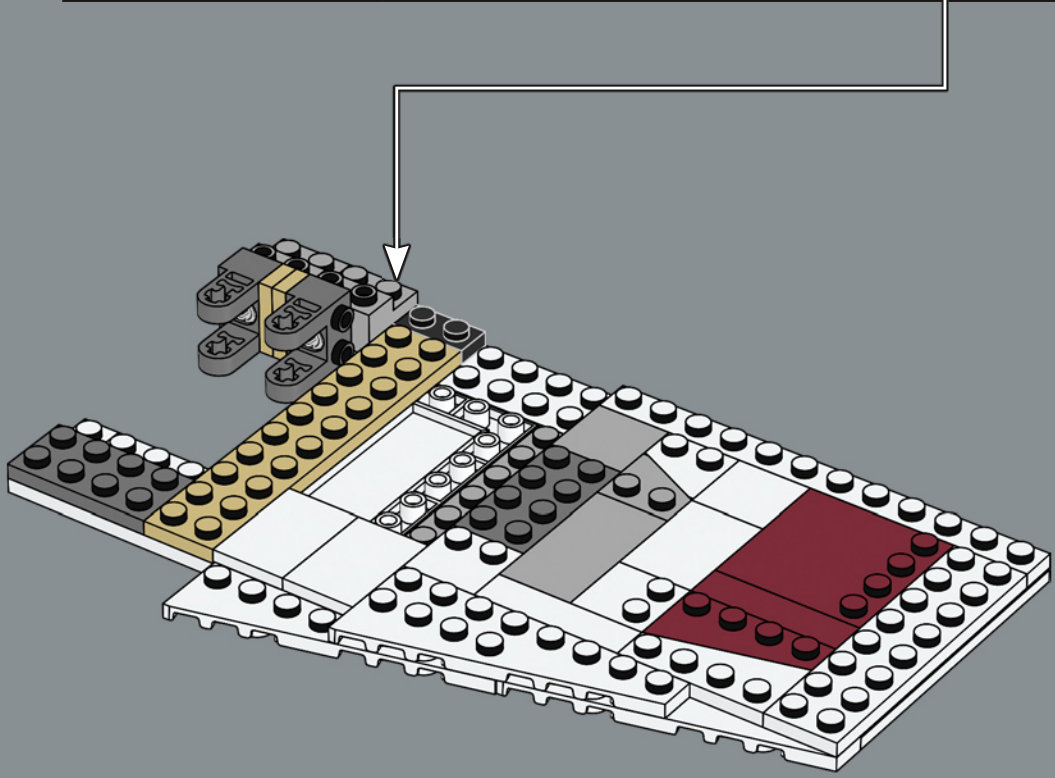
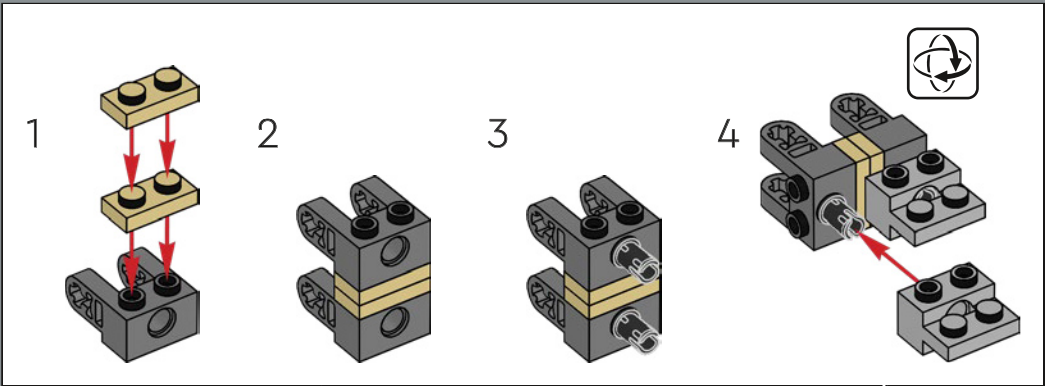

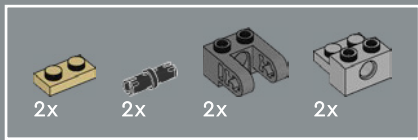

448

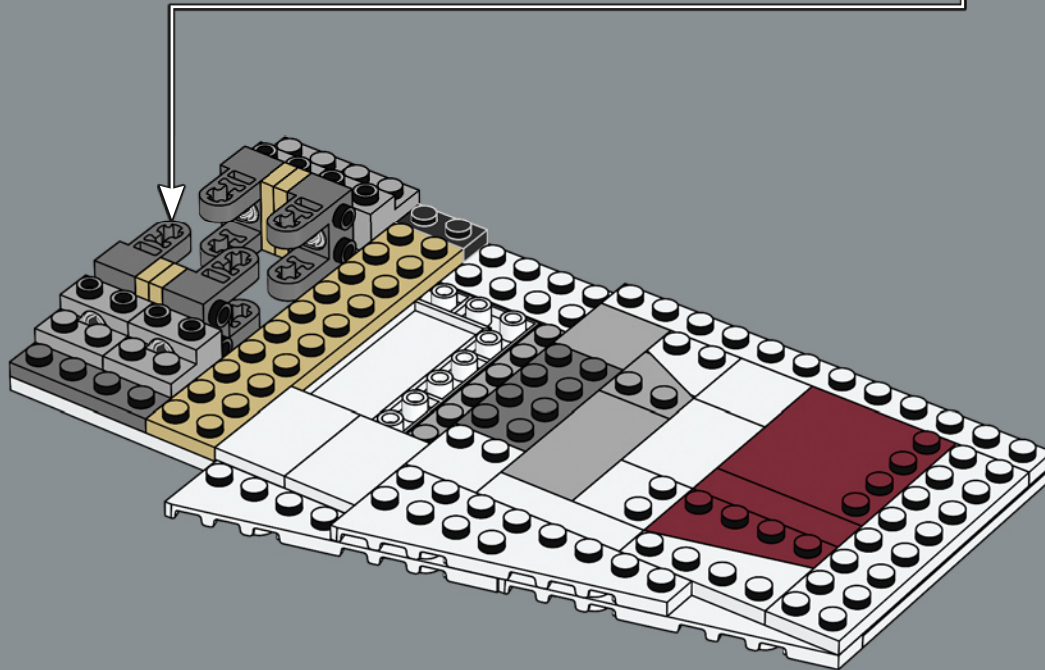
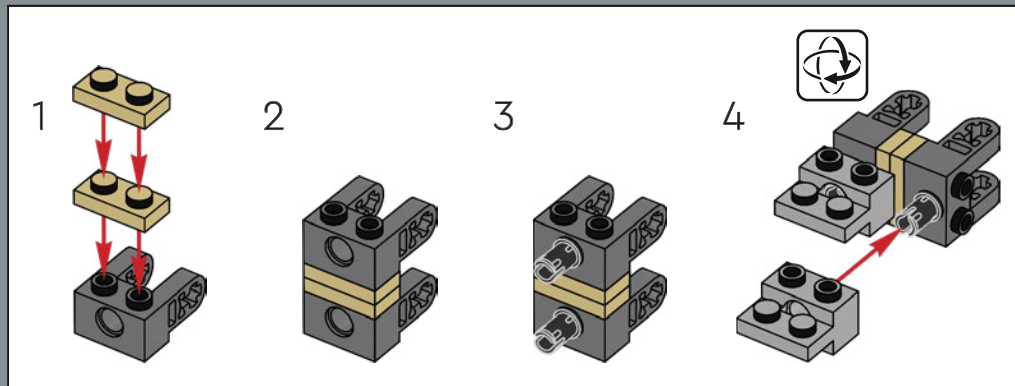

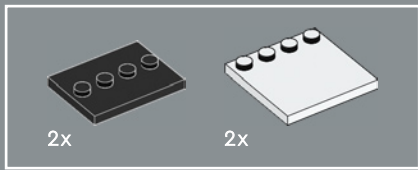

449

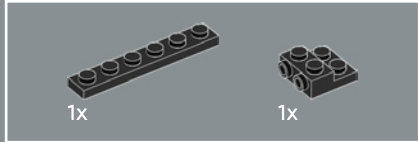
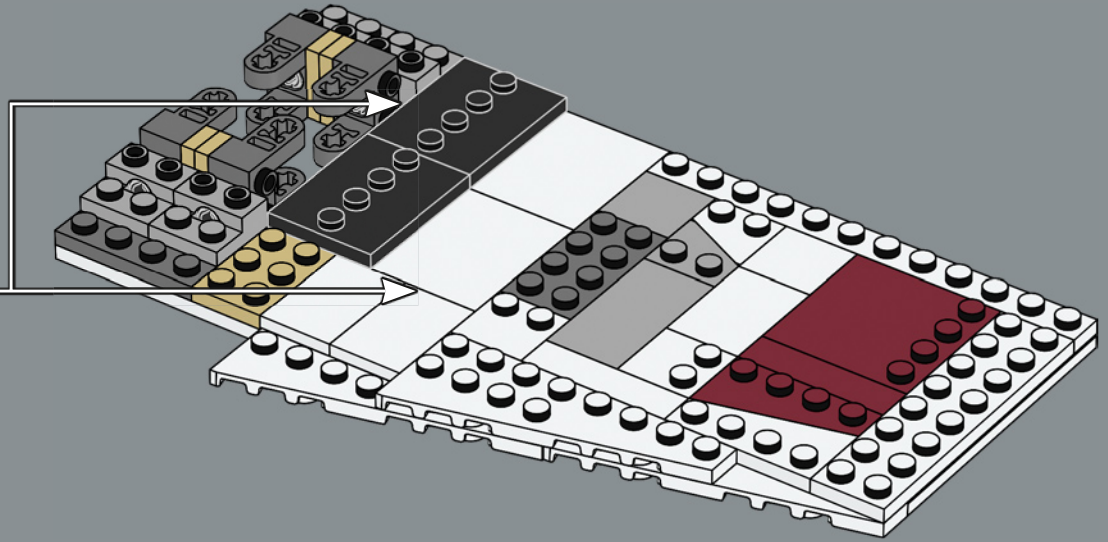
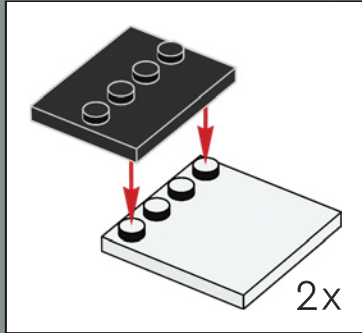

450

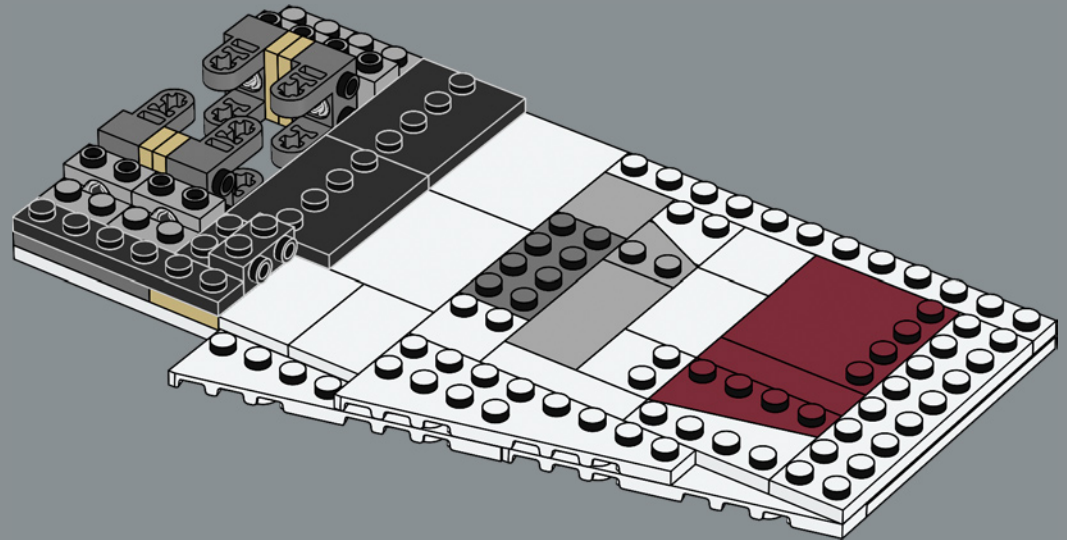

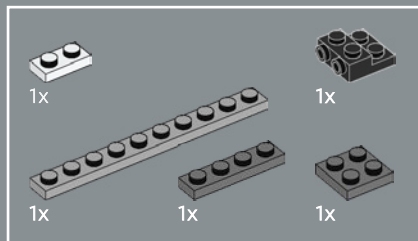

451

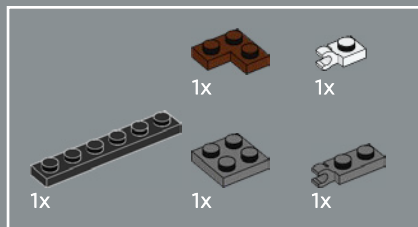
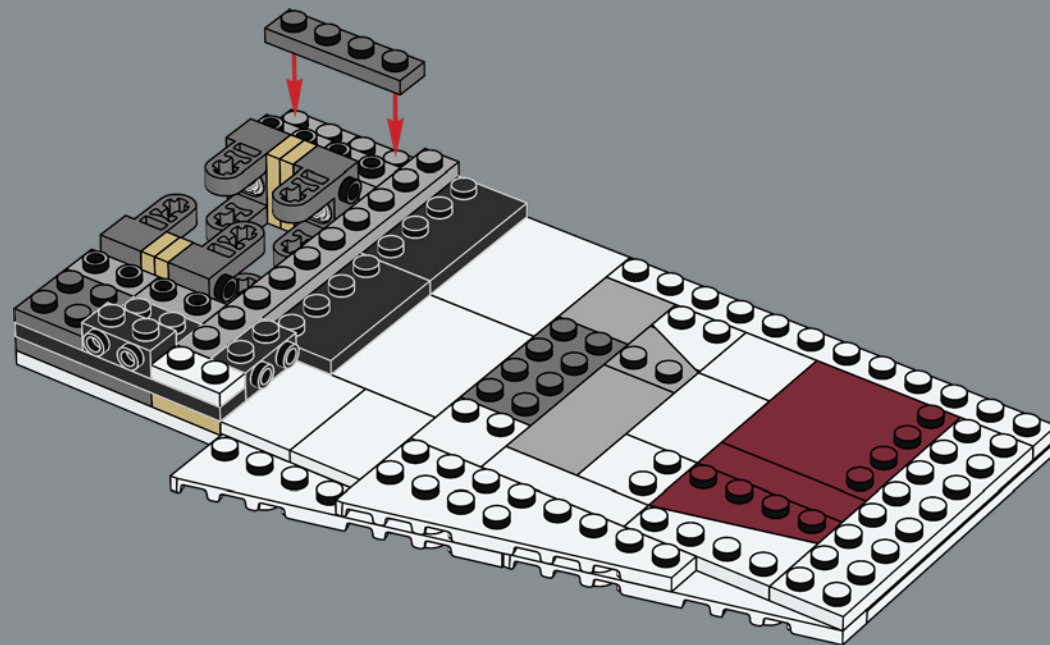

452

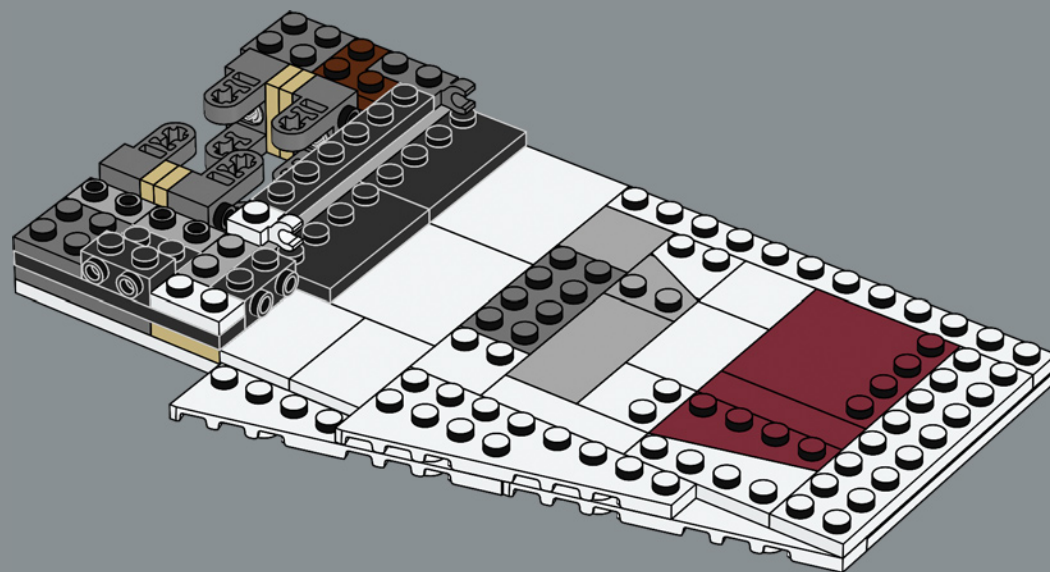

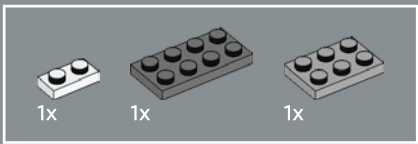

453

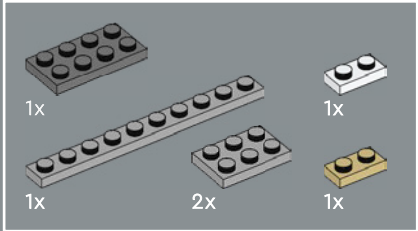
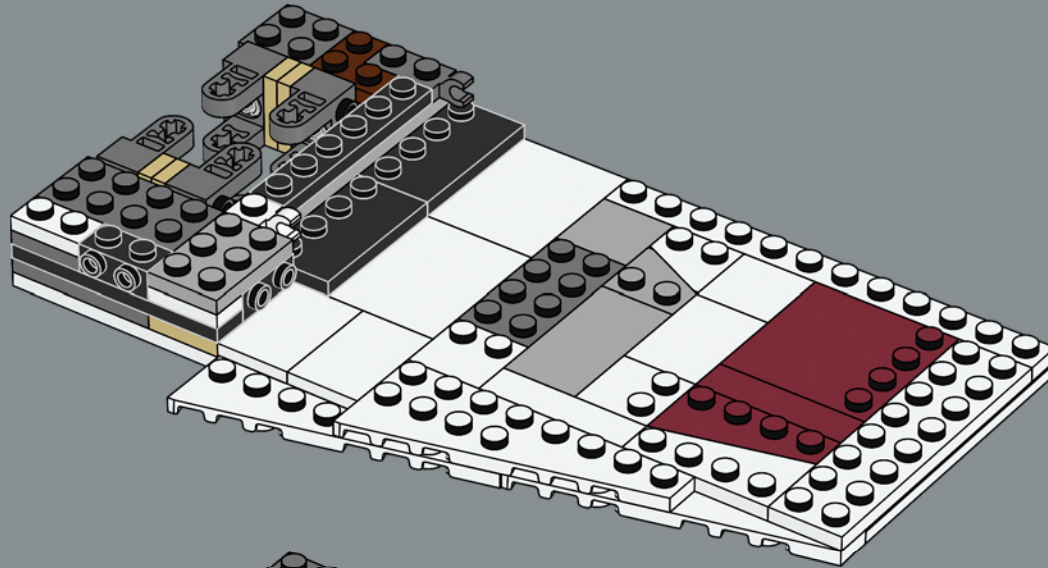

454

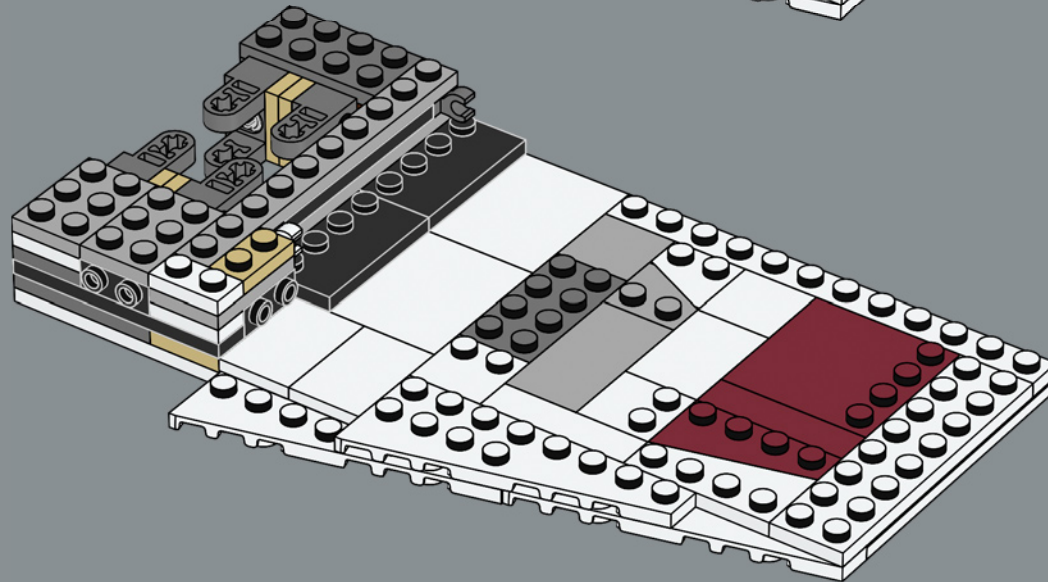

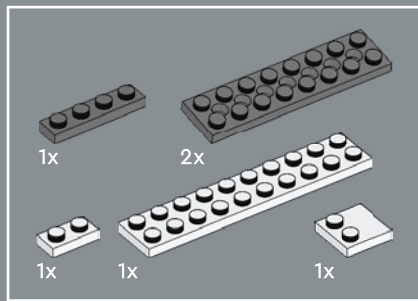

455

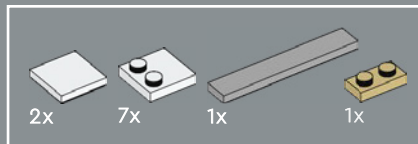
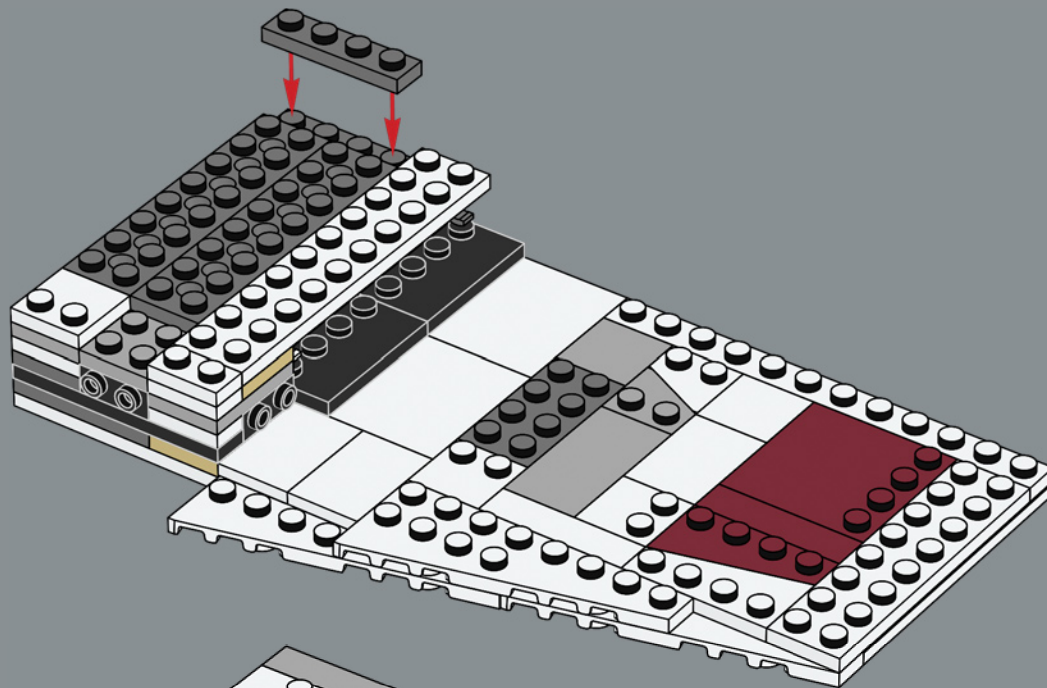

456

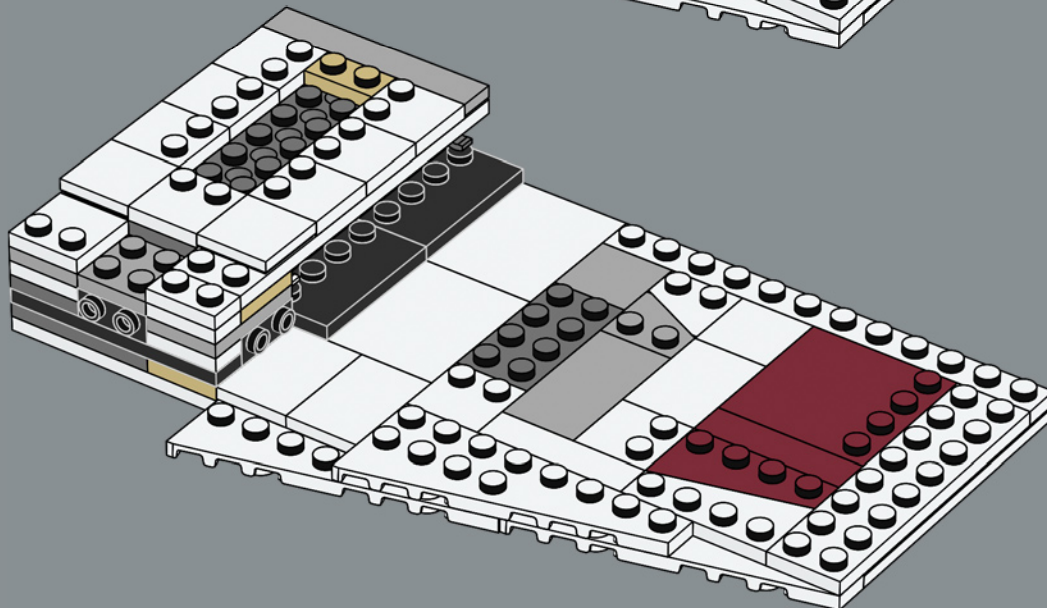

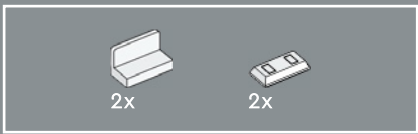

457

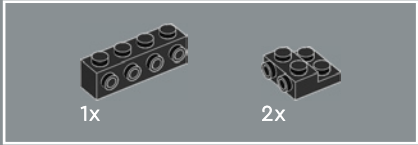
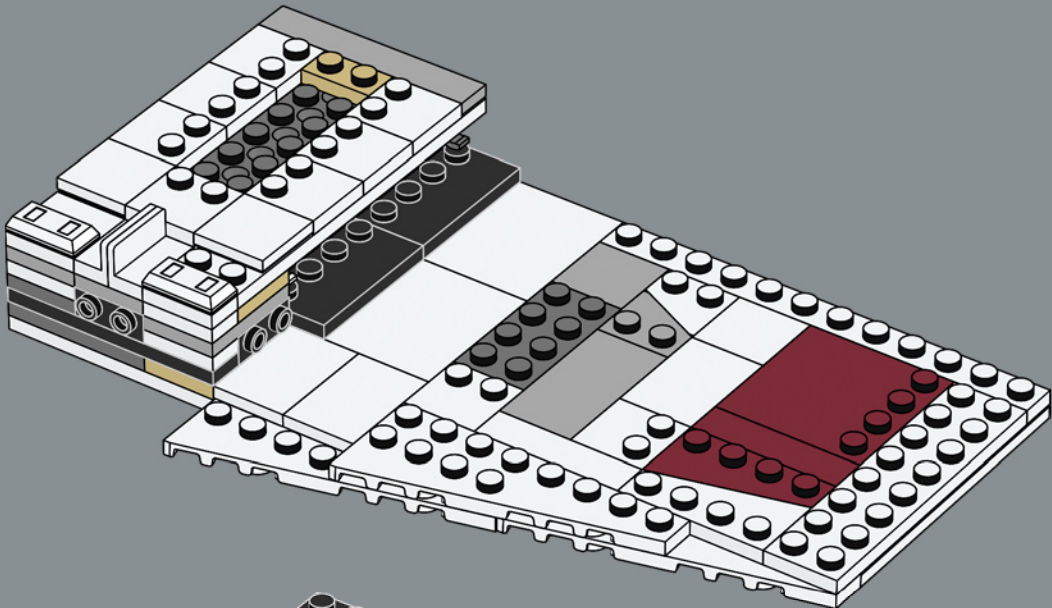

458

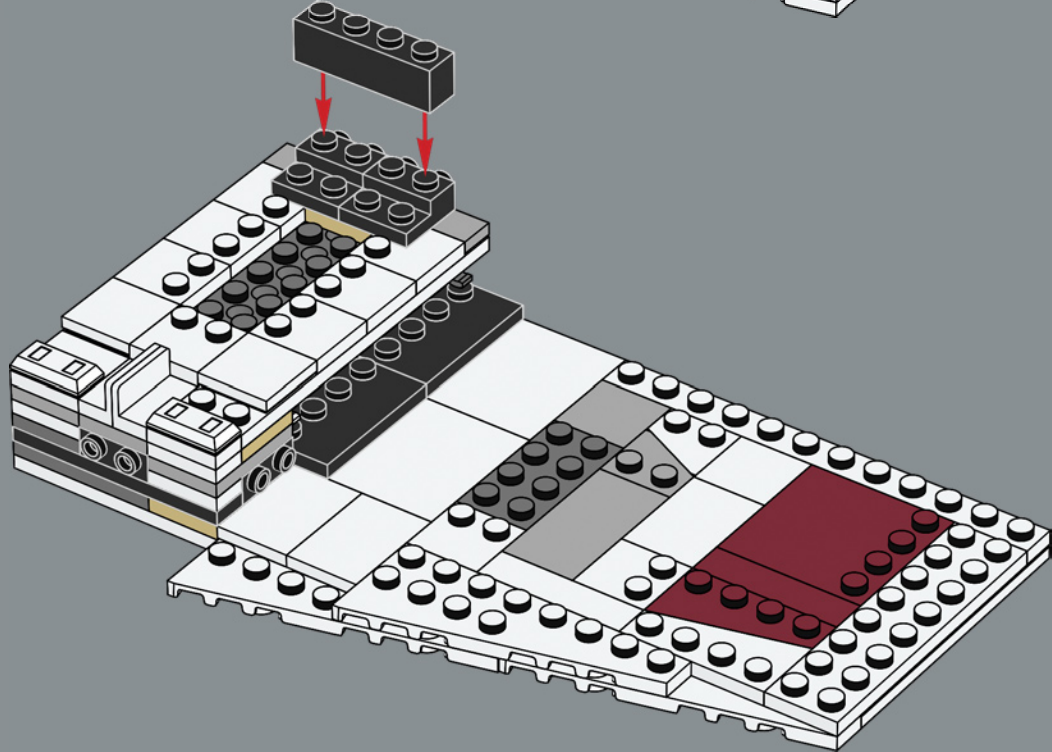



2x

459

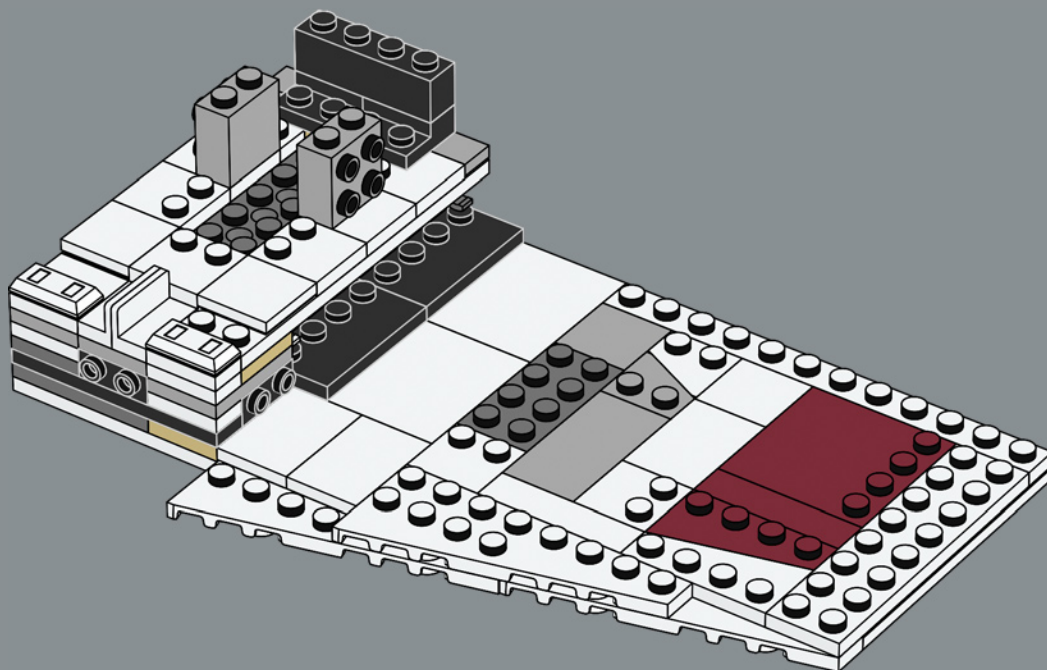

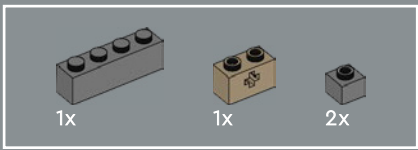

460

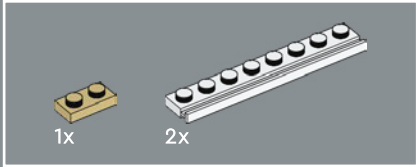
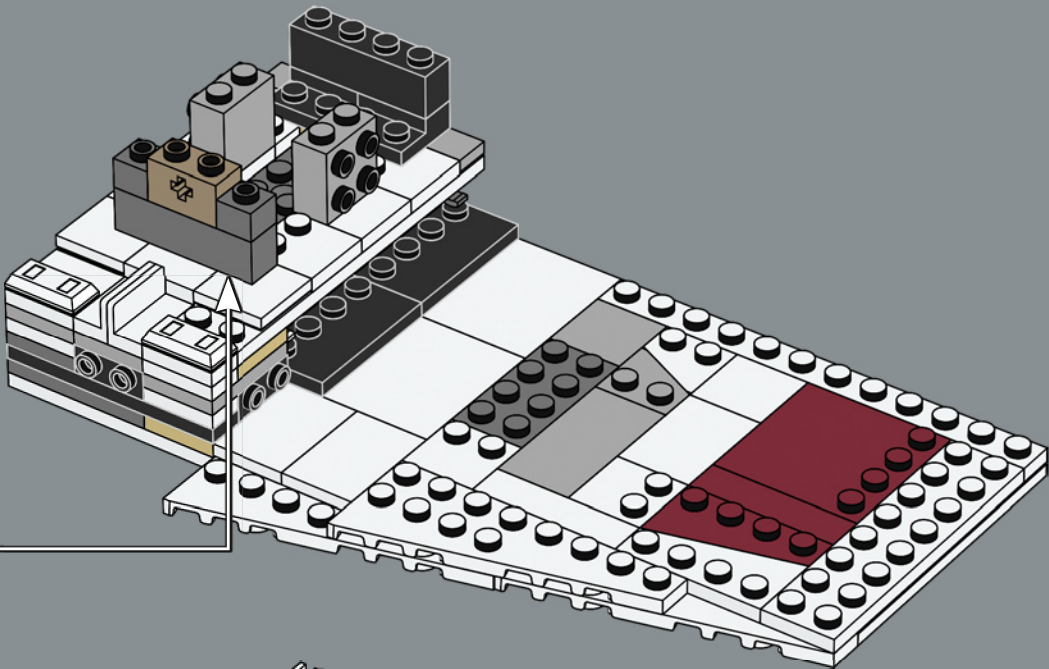
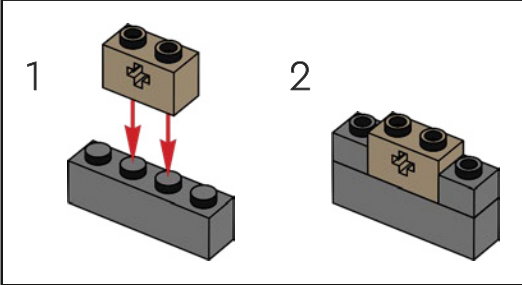

461

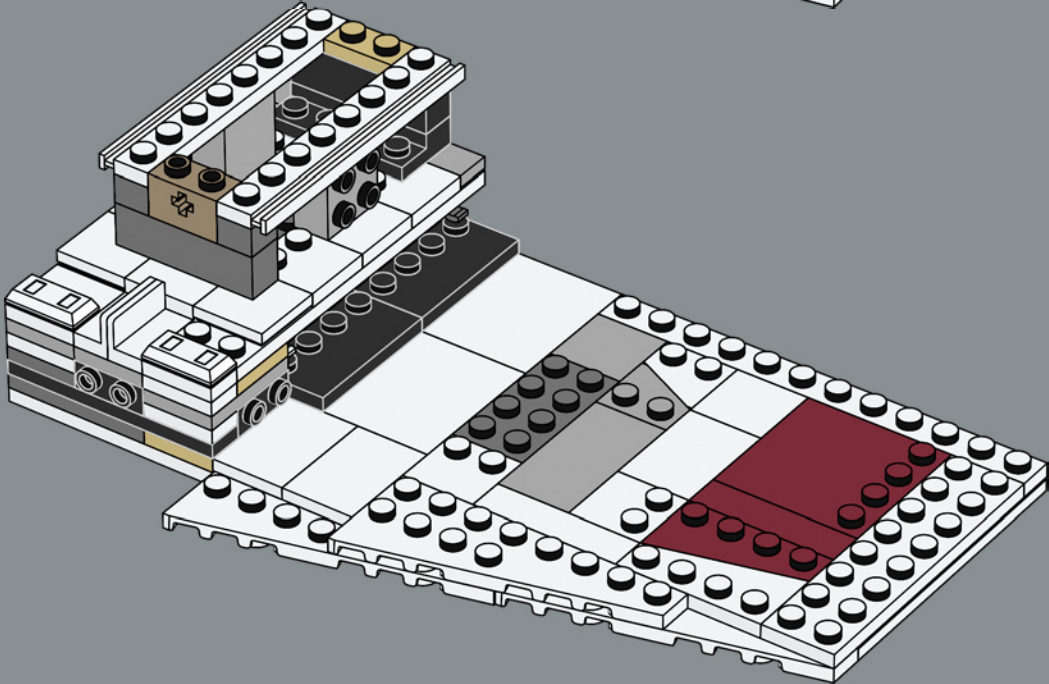

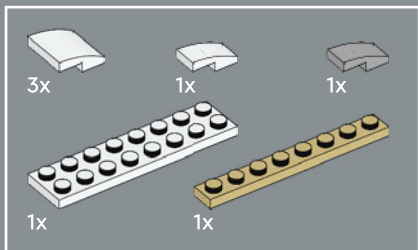

462

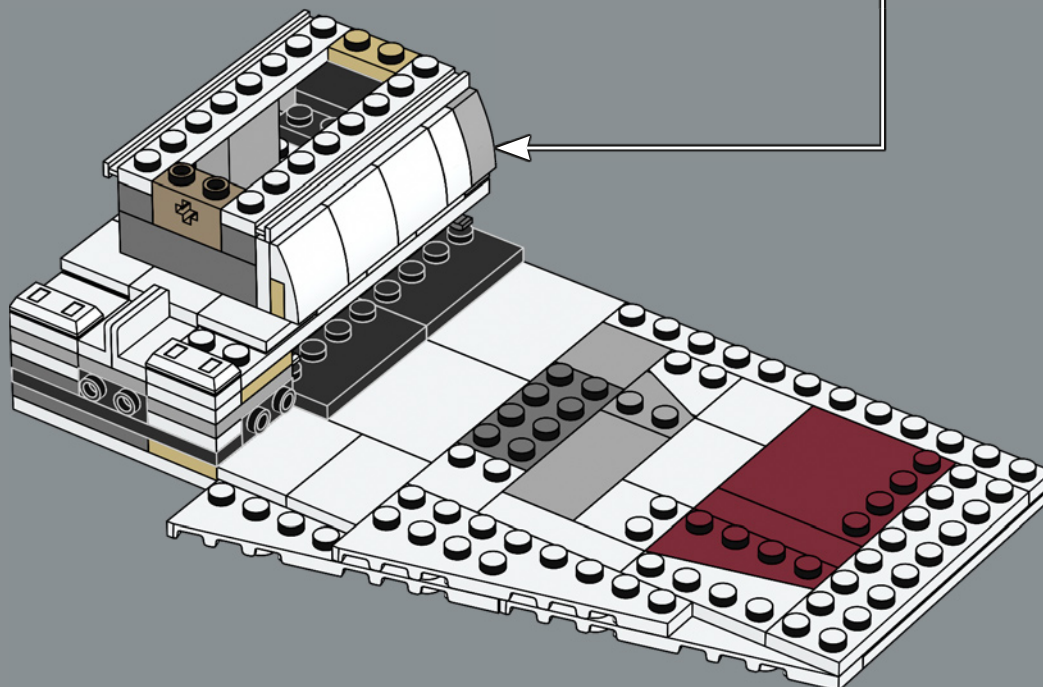
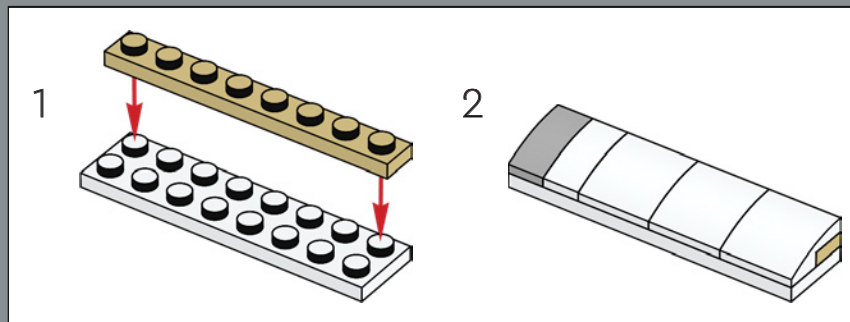

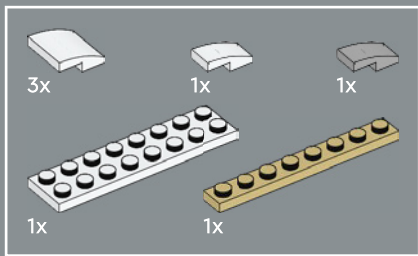

463

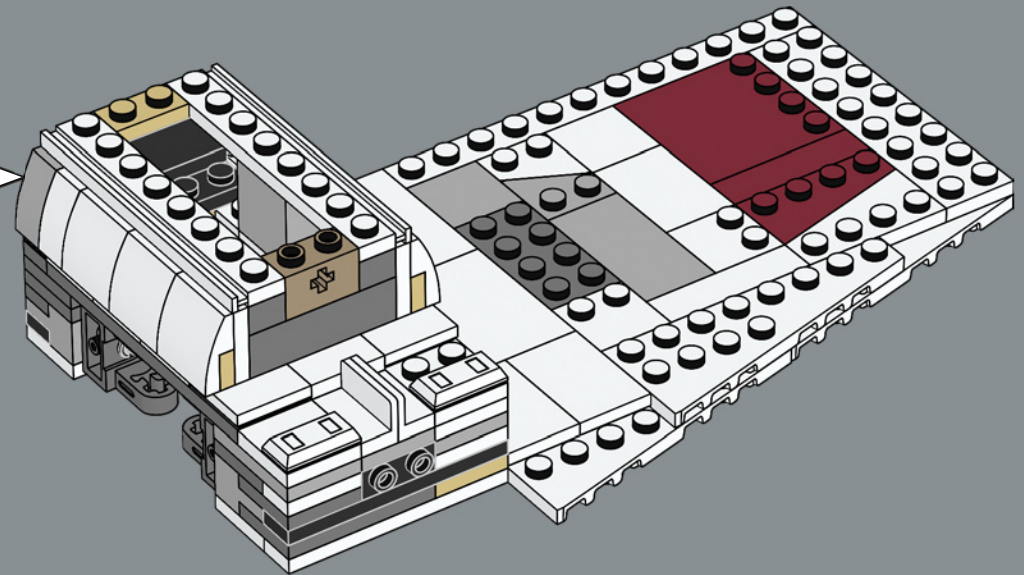
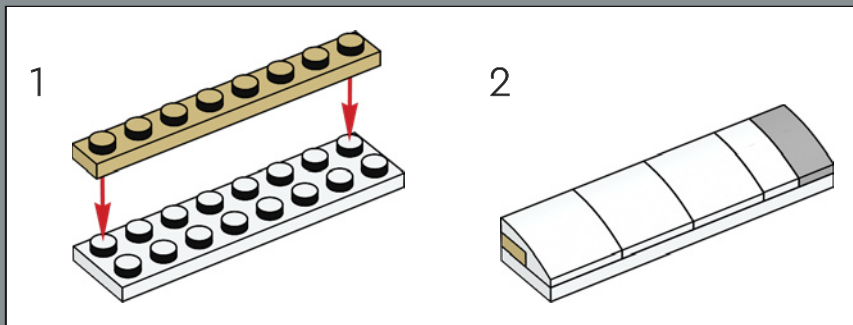

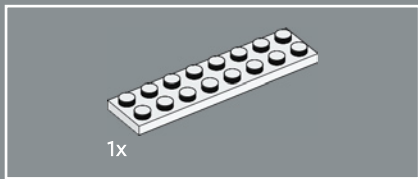

464

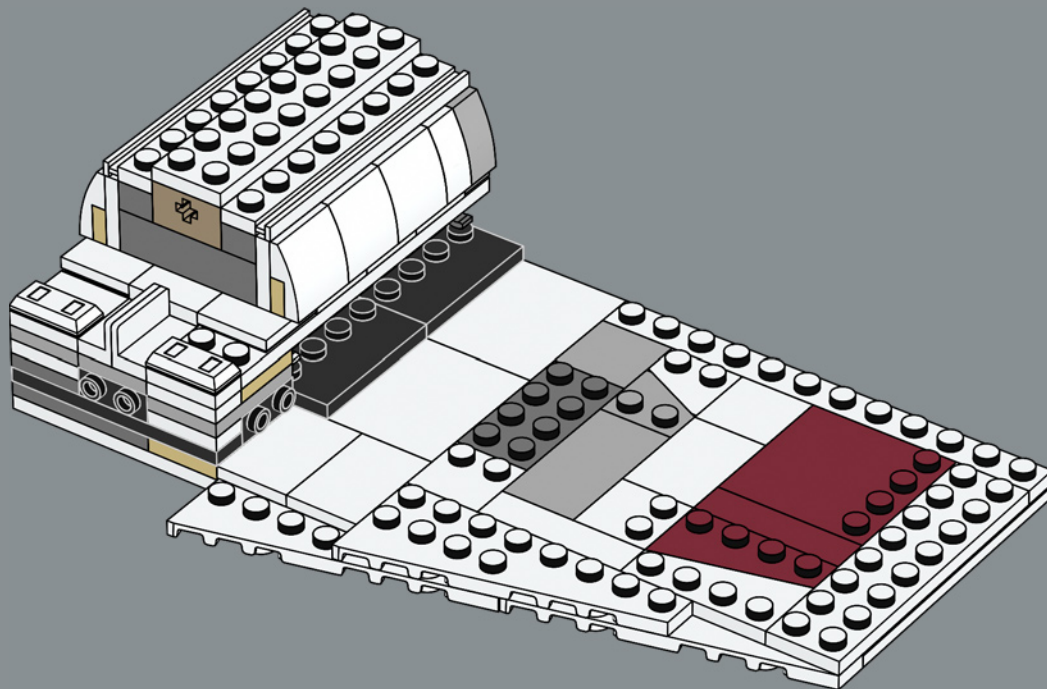



465

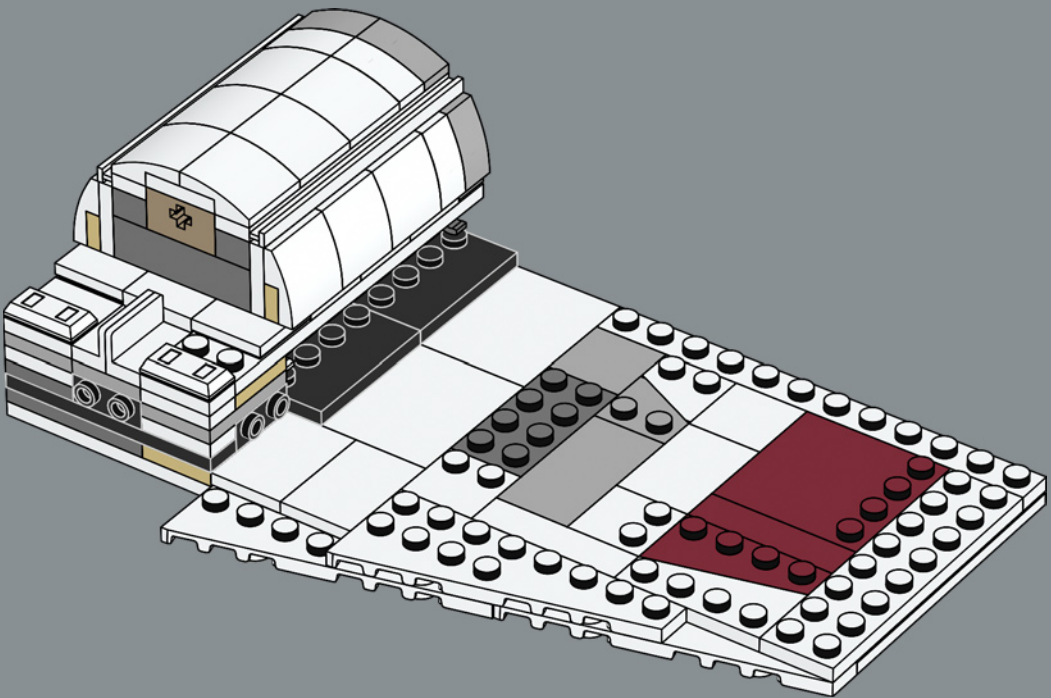

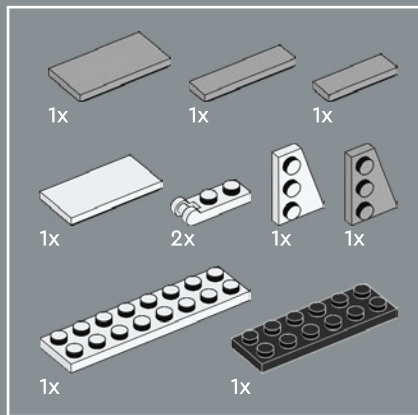

466

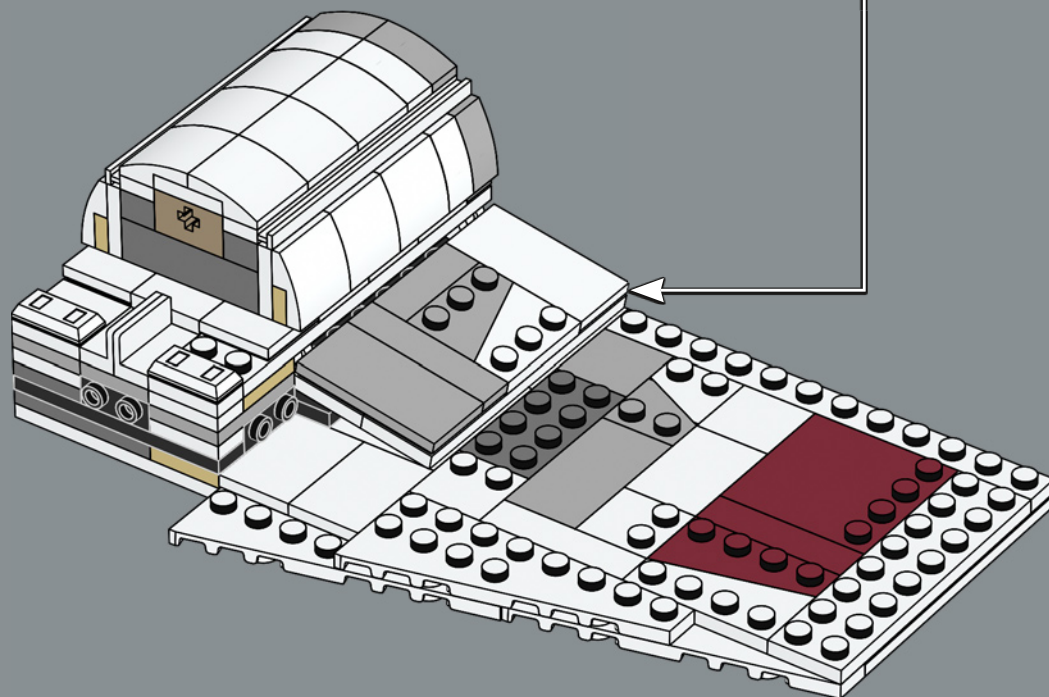
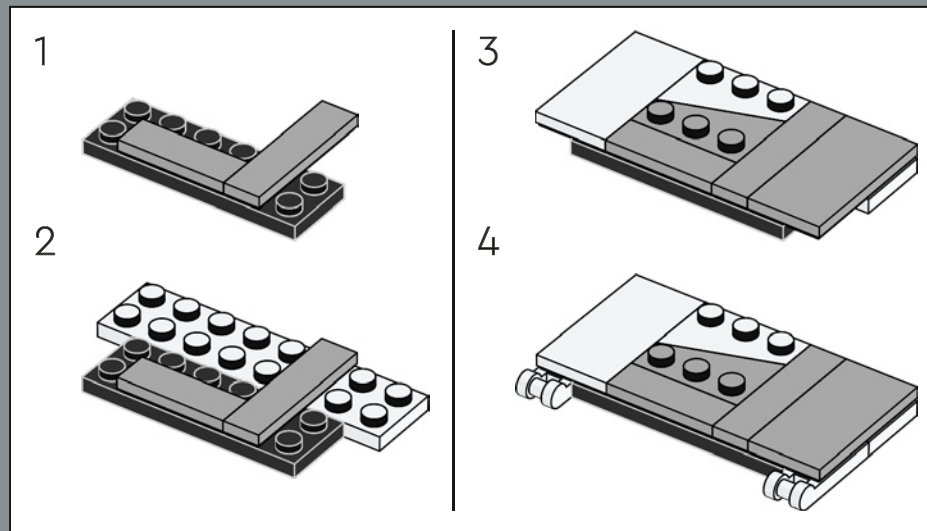

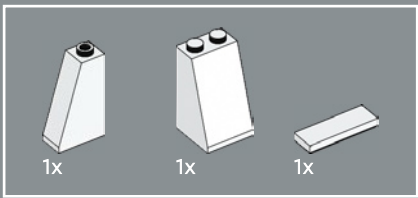

467

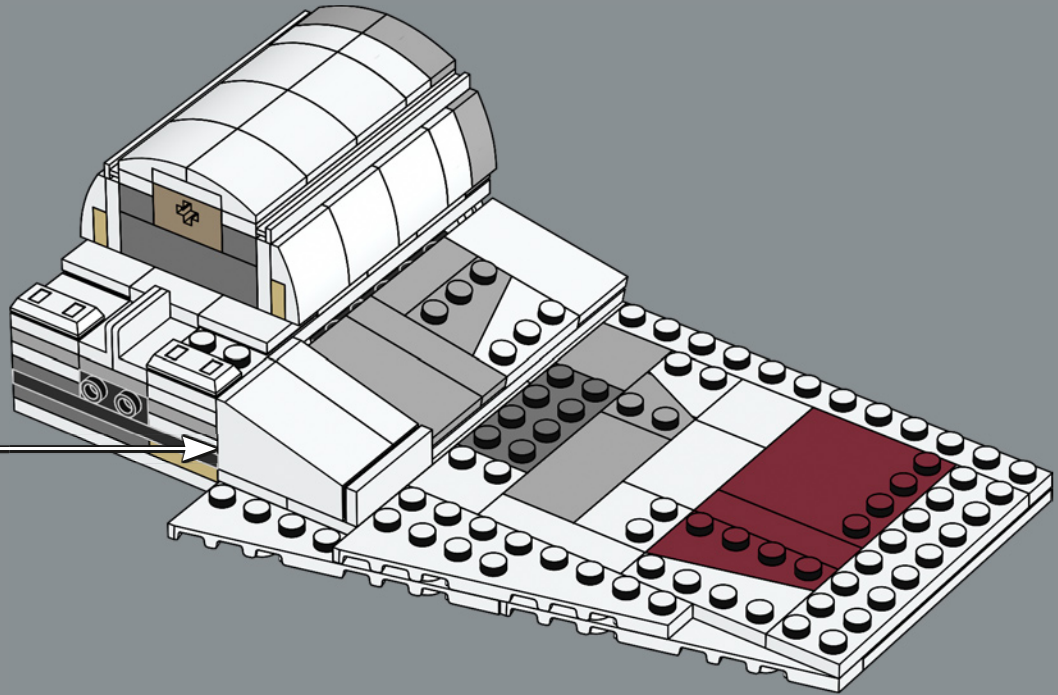
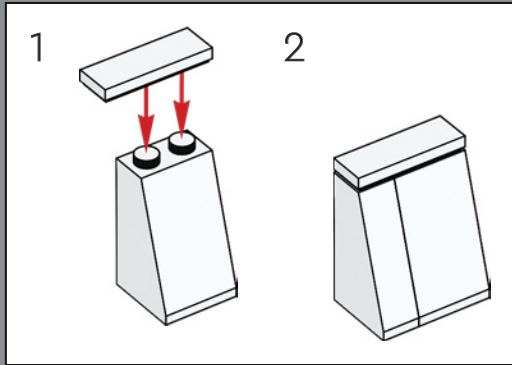

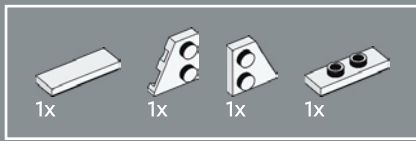

468

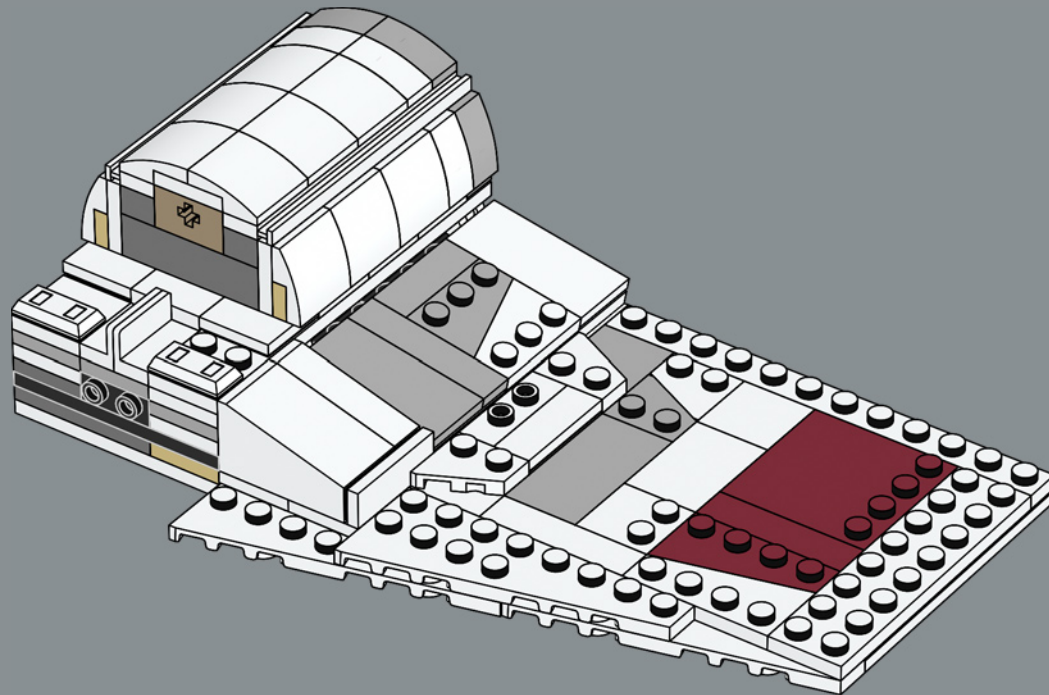

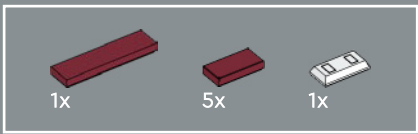

469

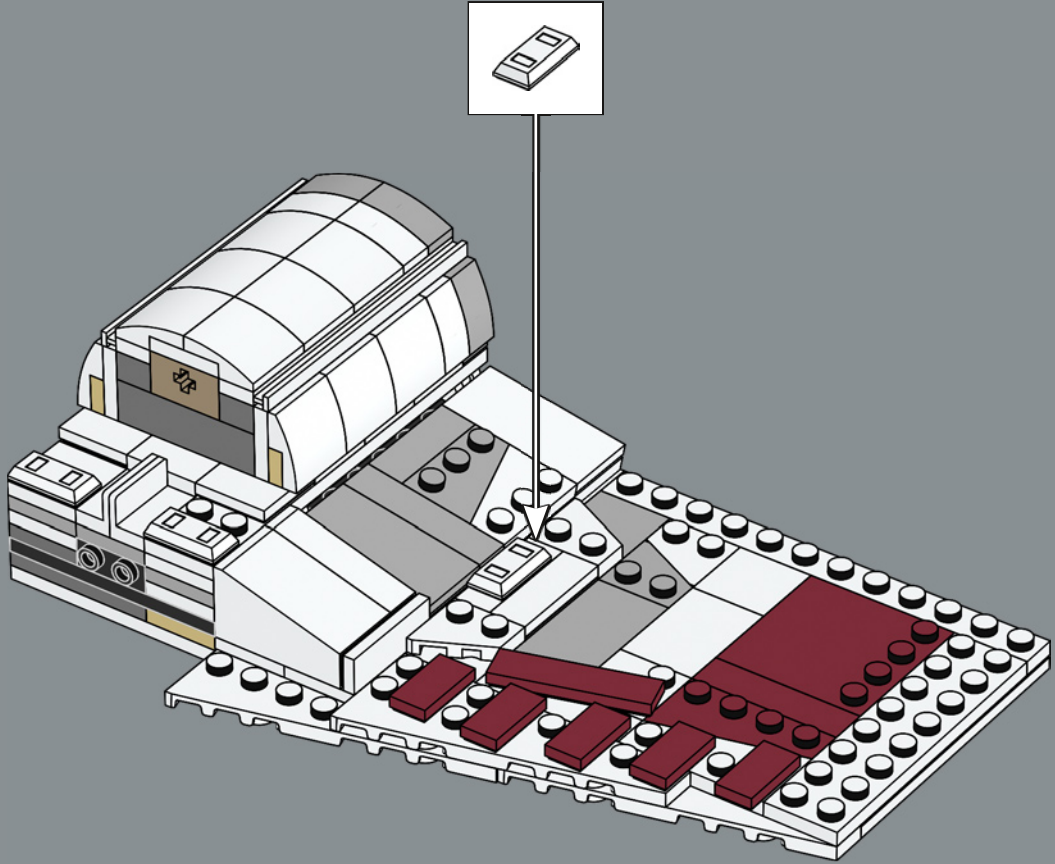

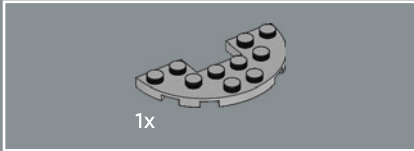
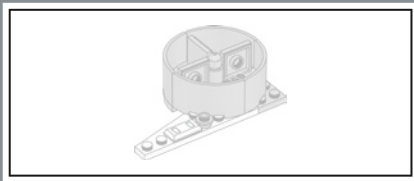

470

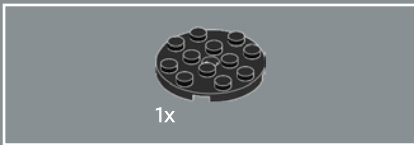
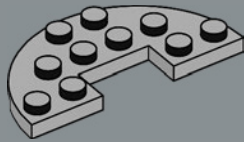

471

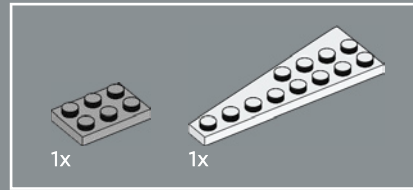
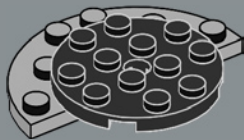

472

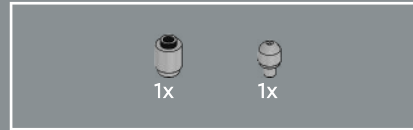
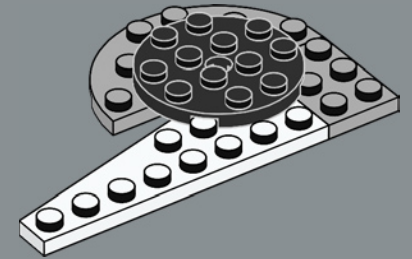

473

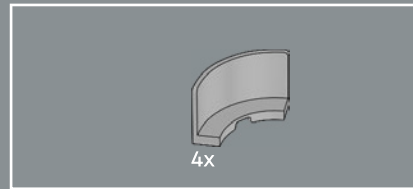
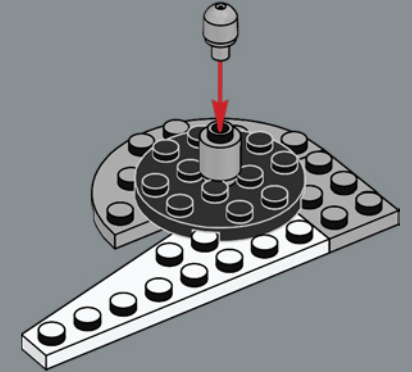

474

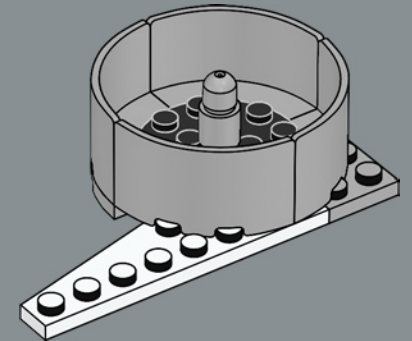

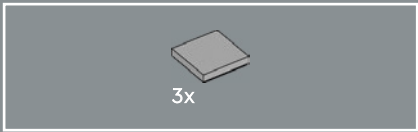

475

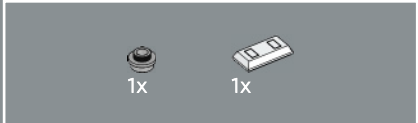
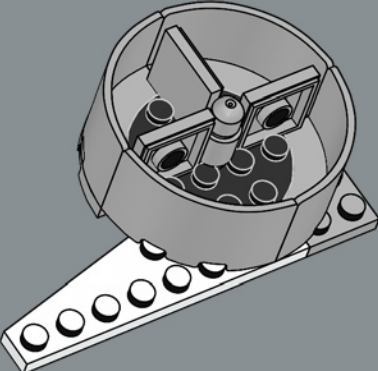

476

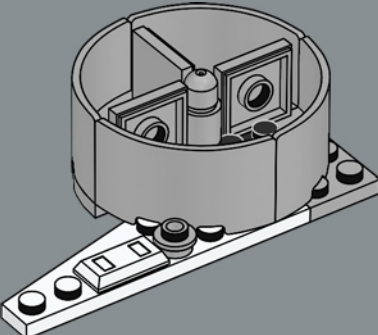

477

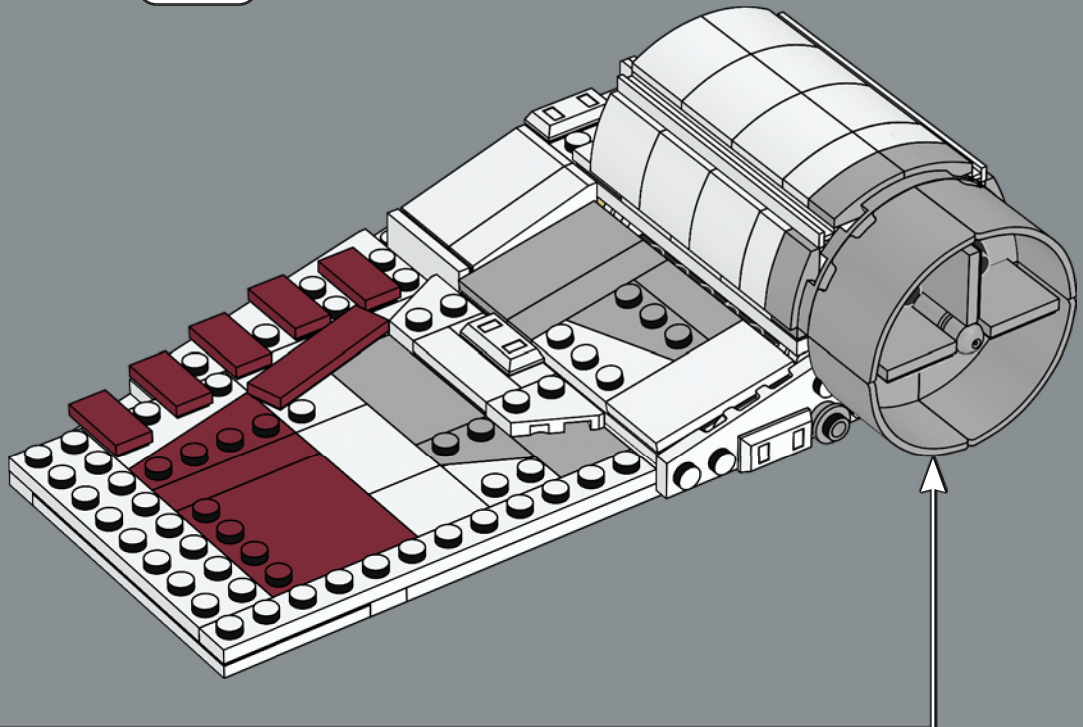

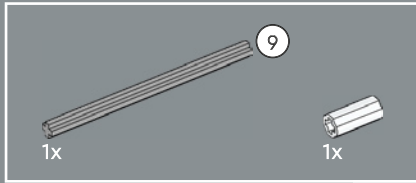
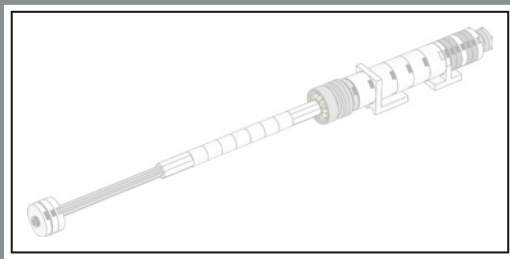

478

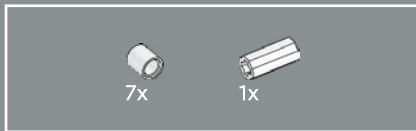
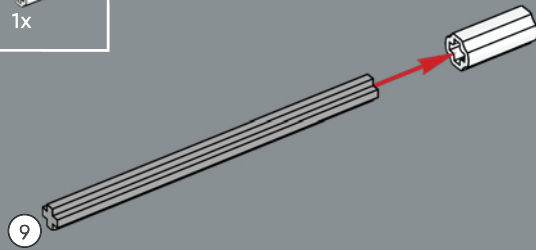

479

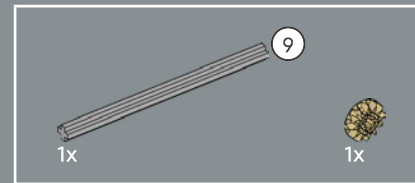
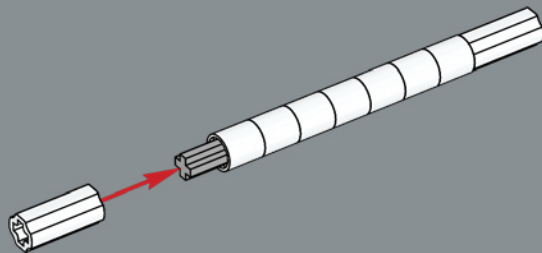

480

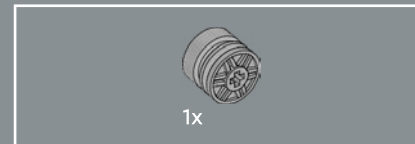
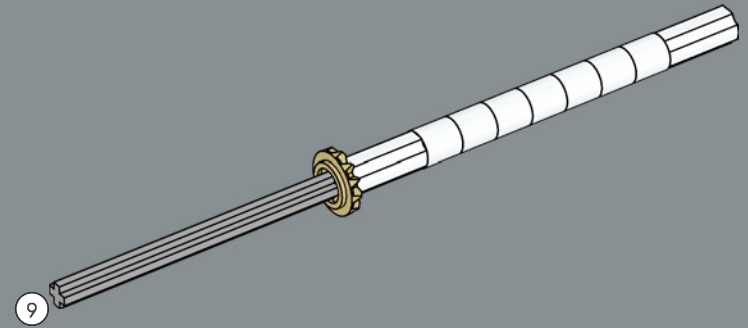

481

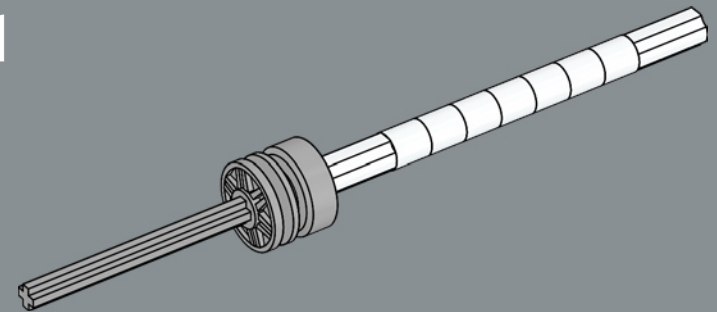

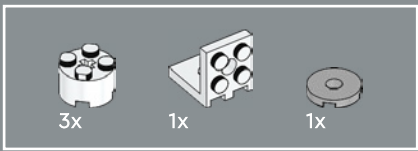

482

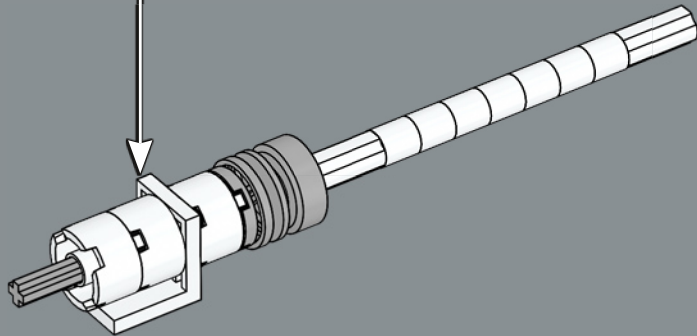
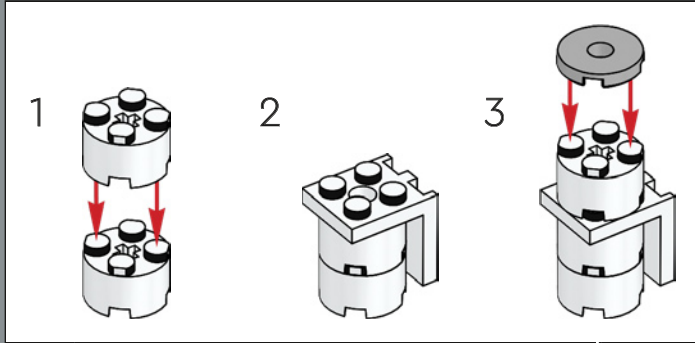

483

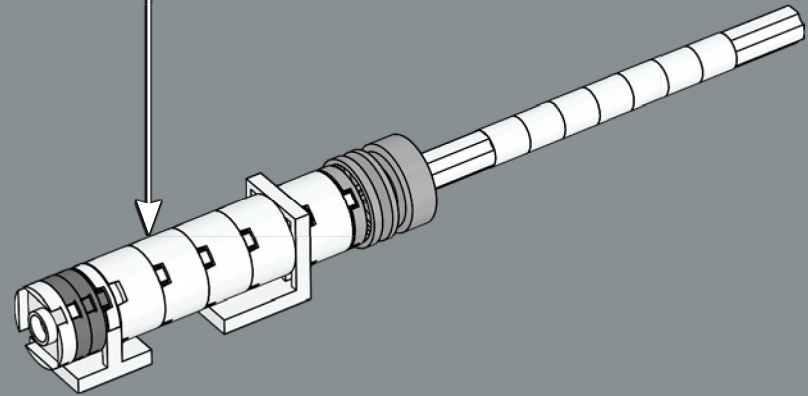
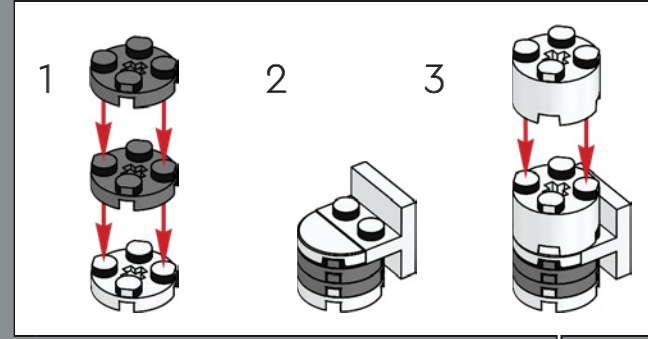

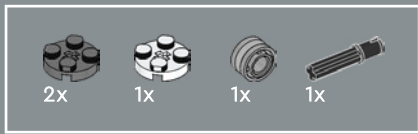

484

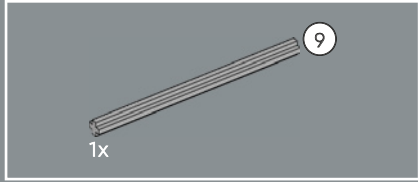
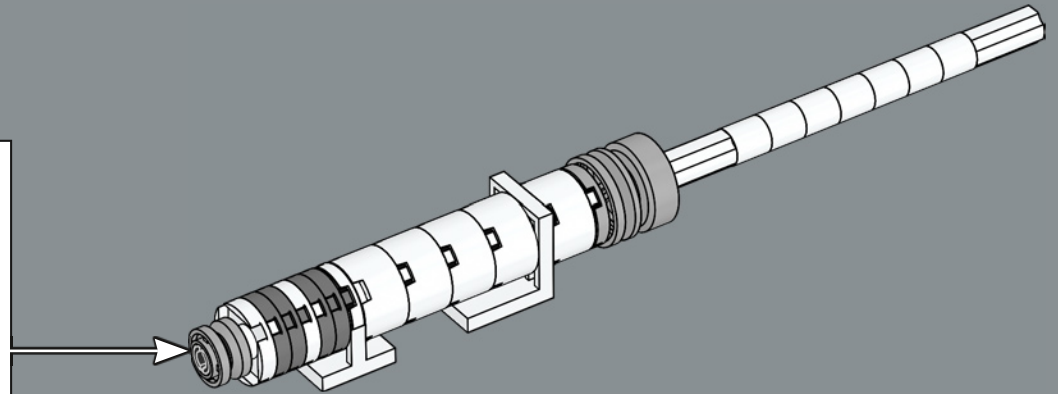
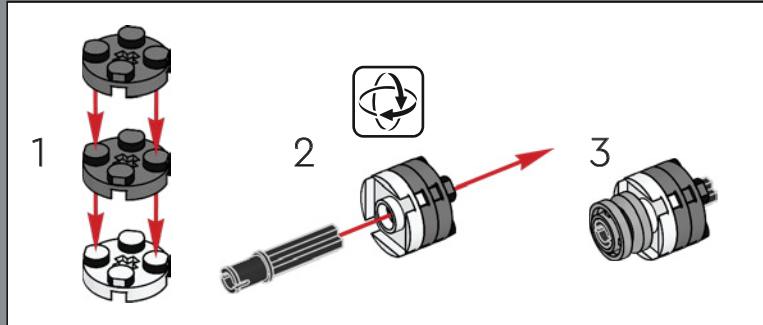

485

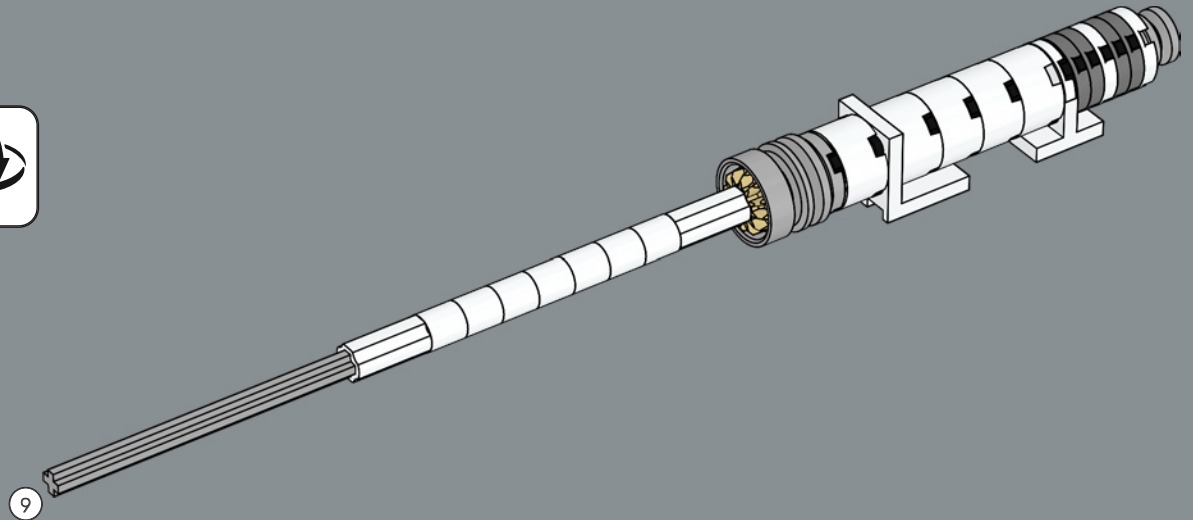



486

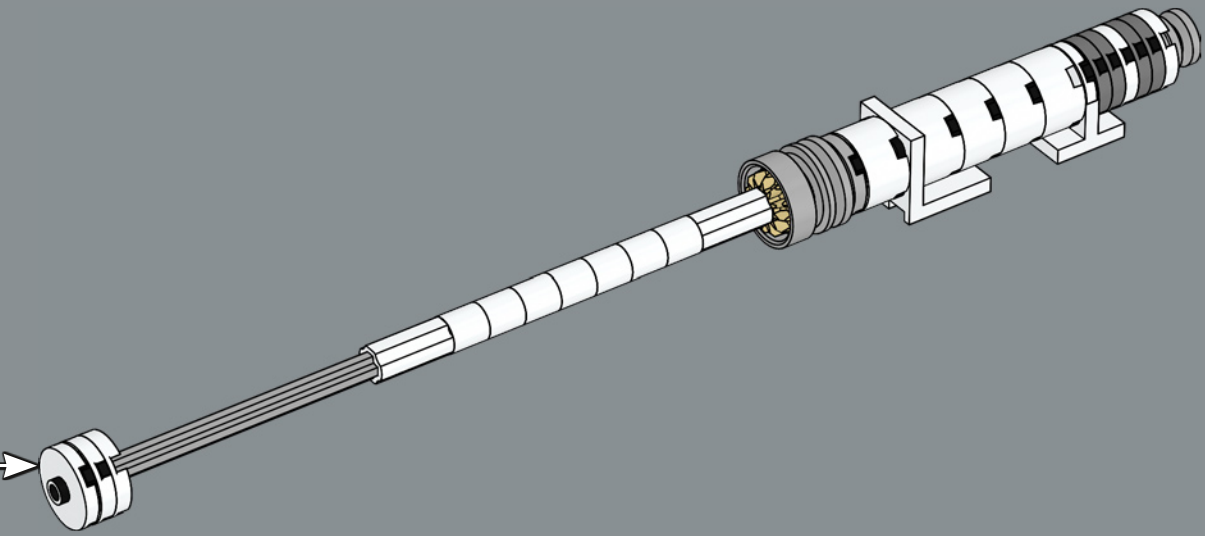
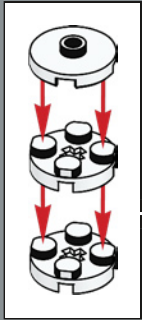

487

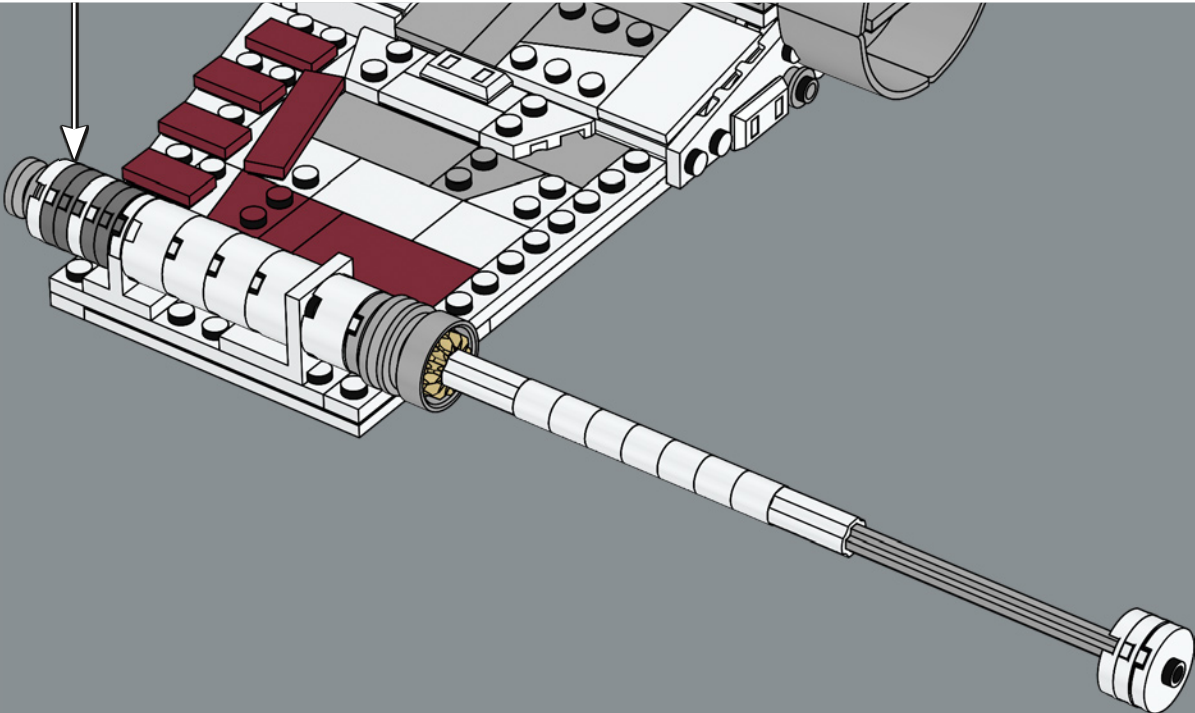

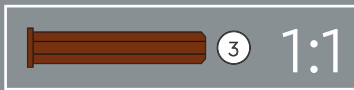
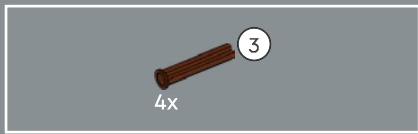

488

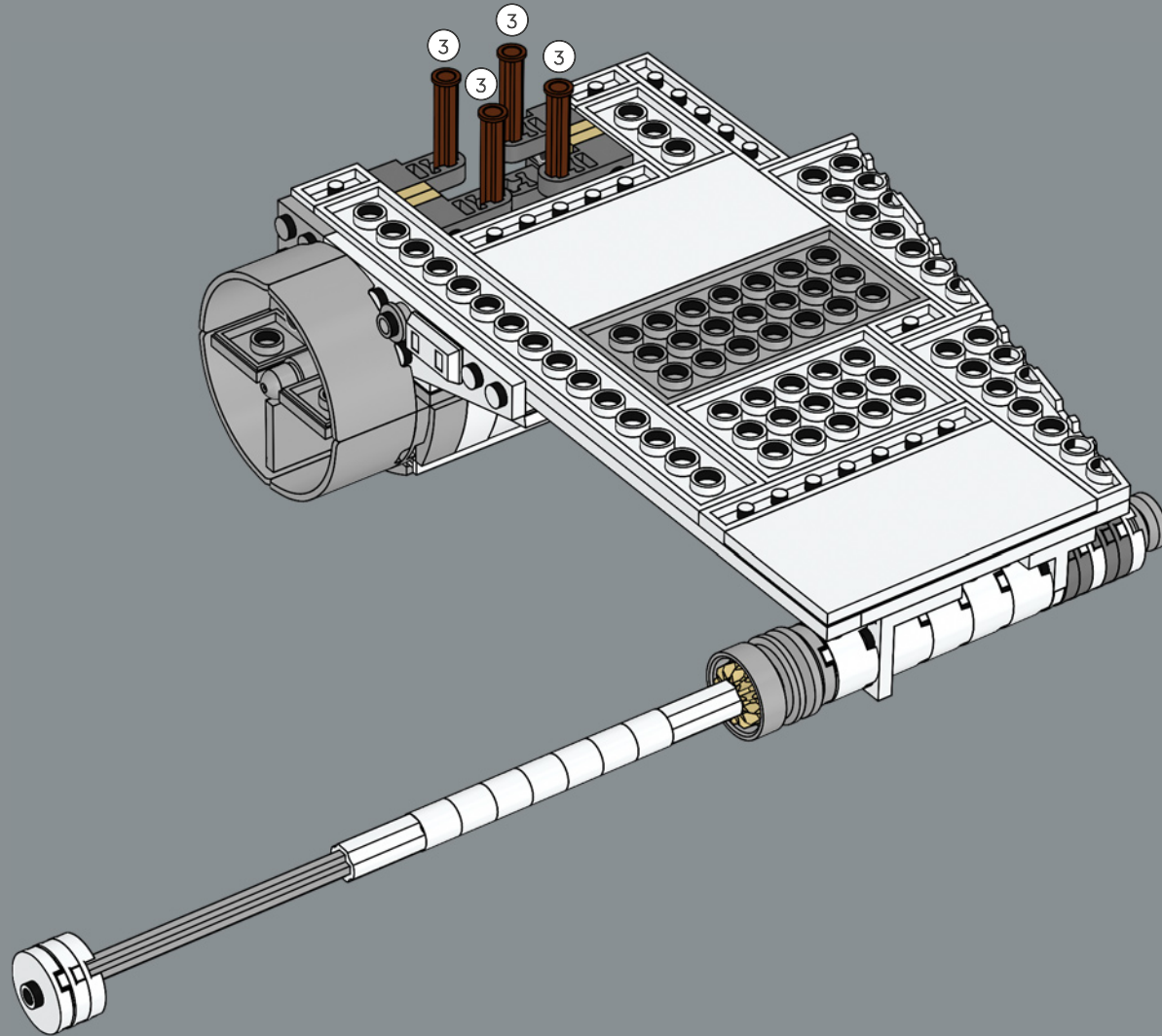

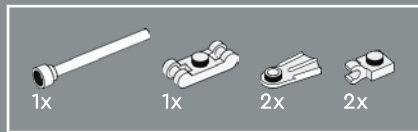

490

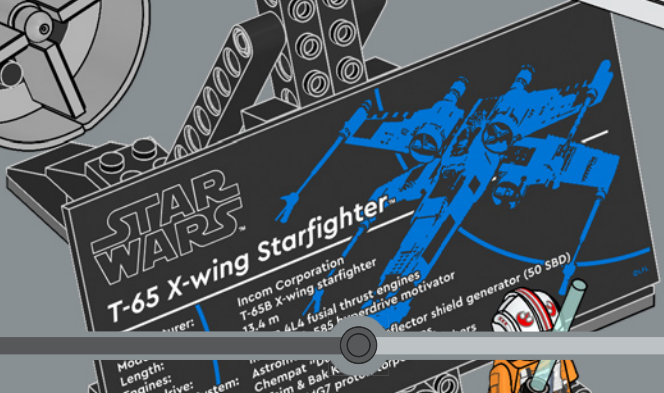
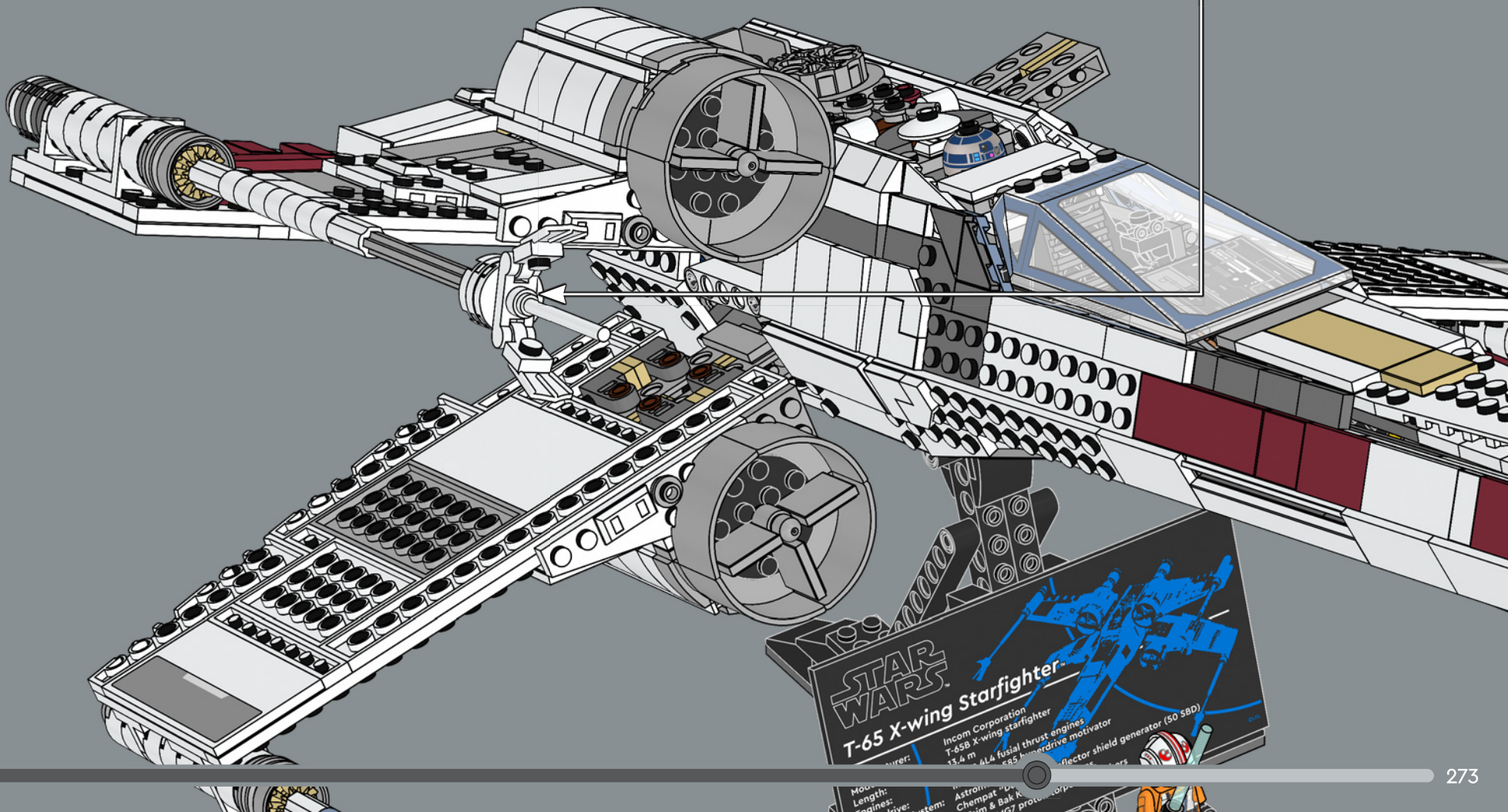
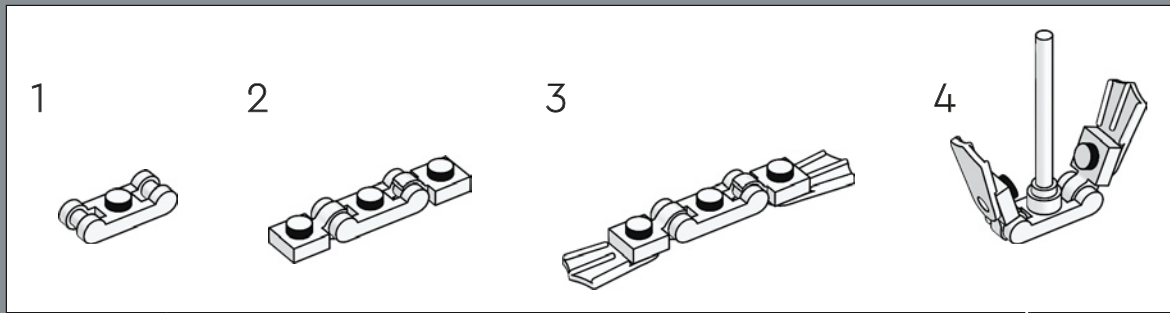

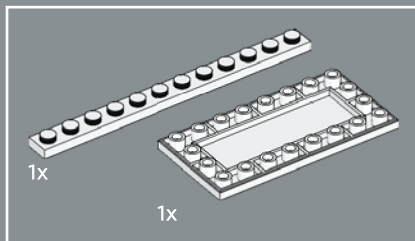

491

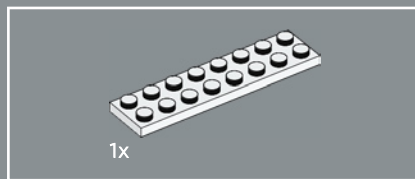
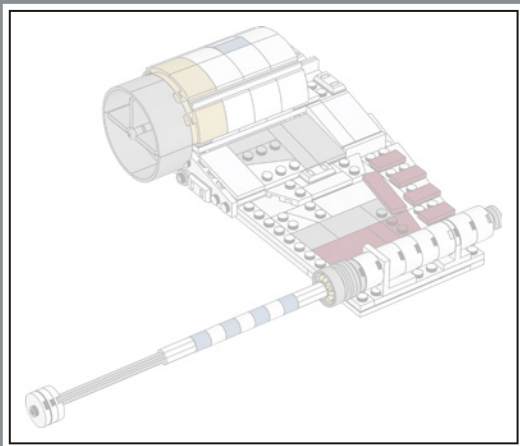
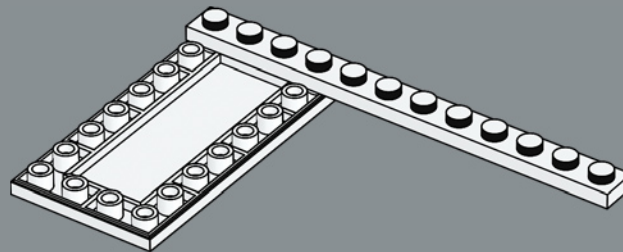

492

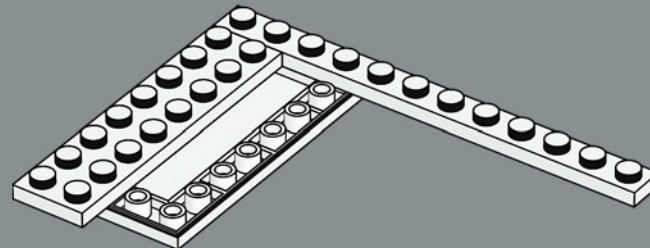

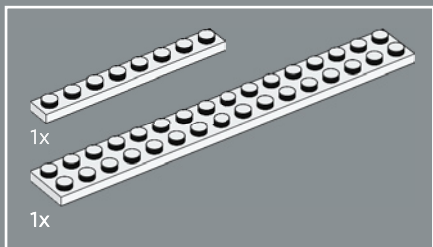

493

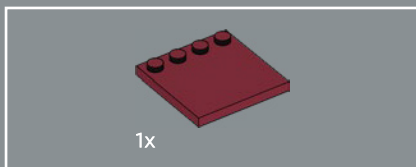
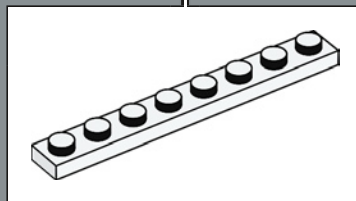
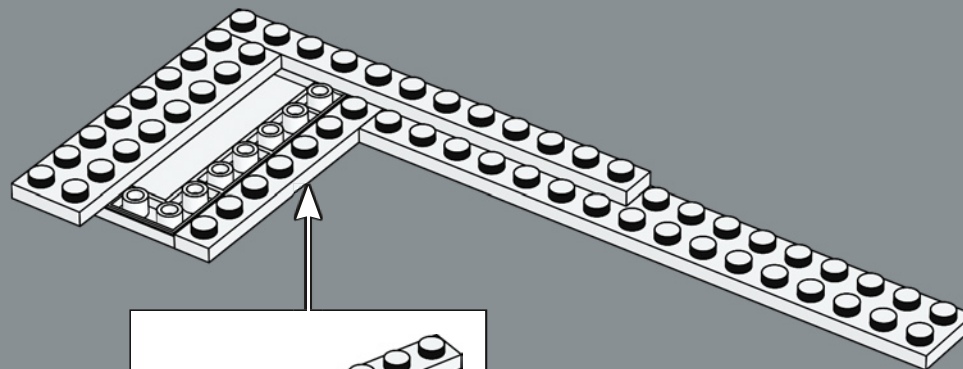

494

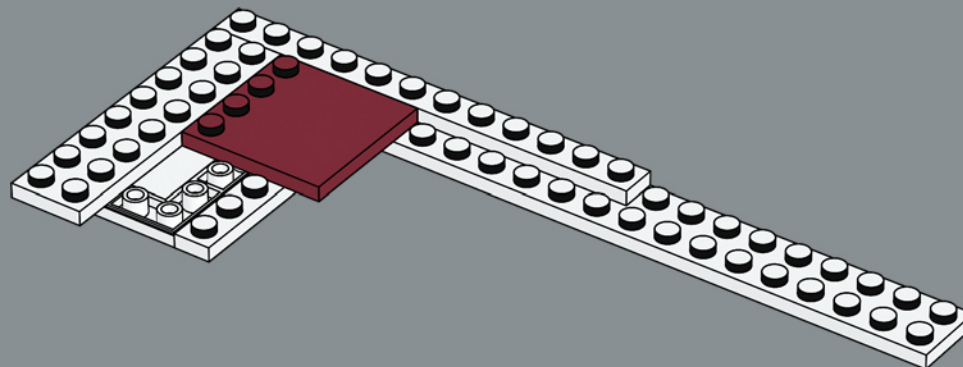

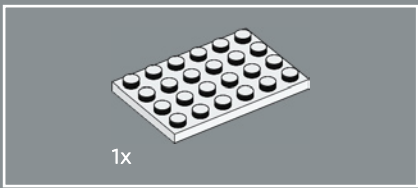

495

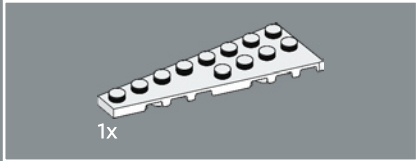
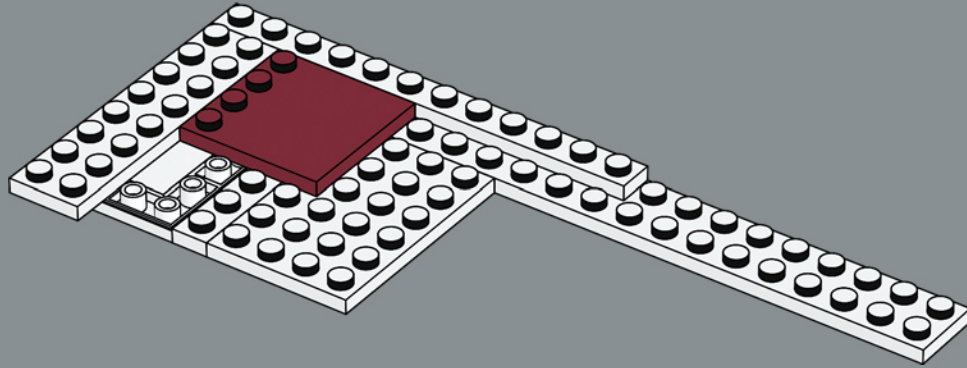

496

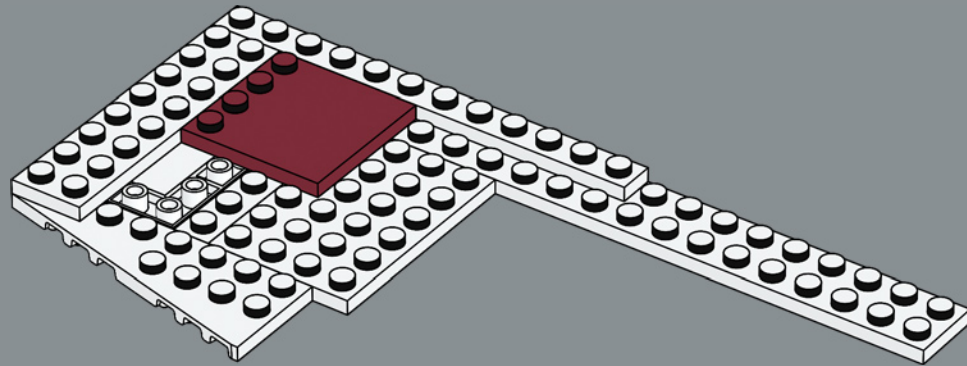

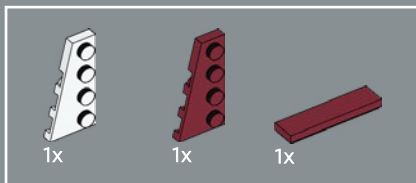

497

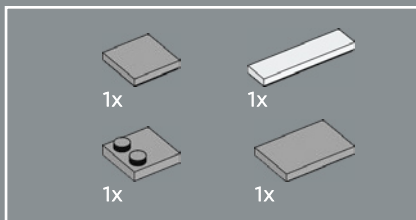
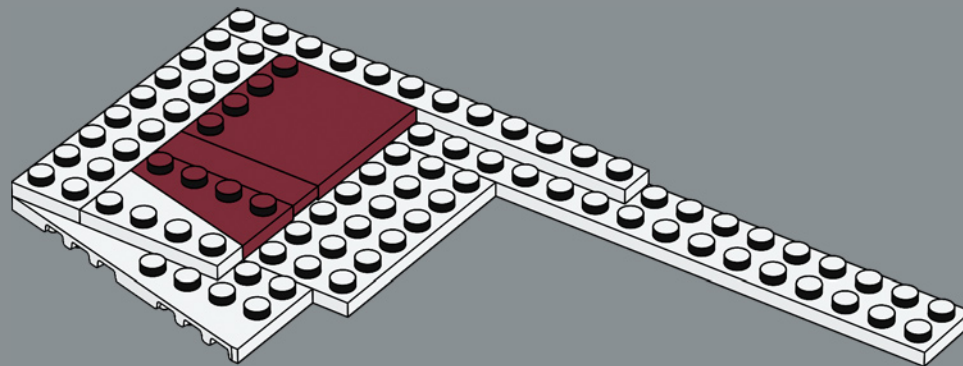

498

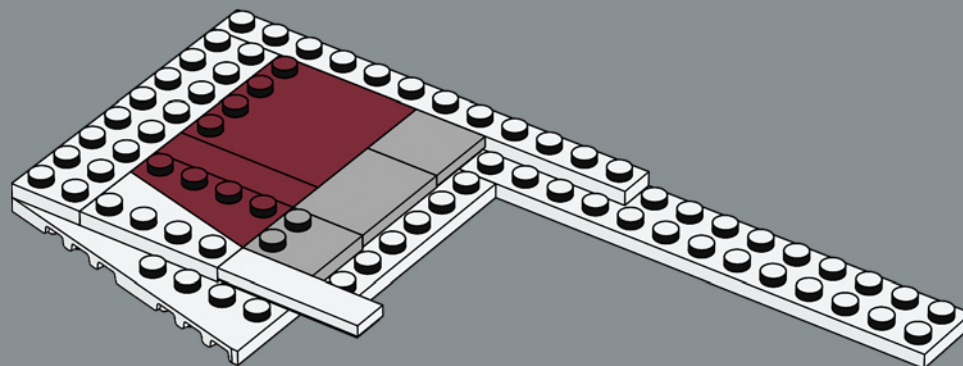

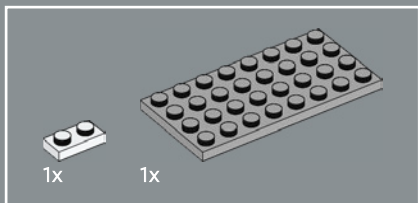

499

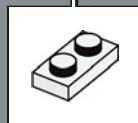
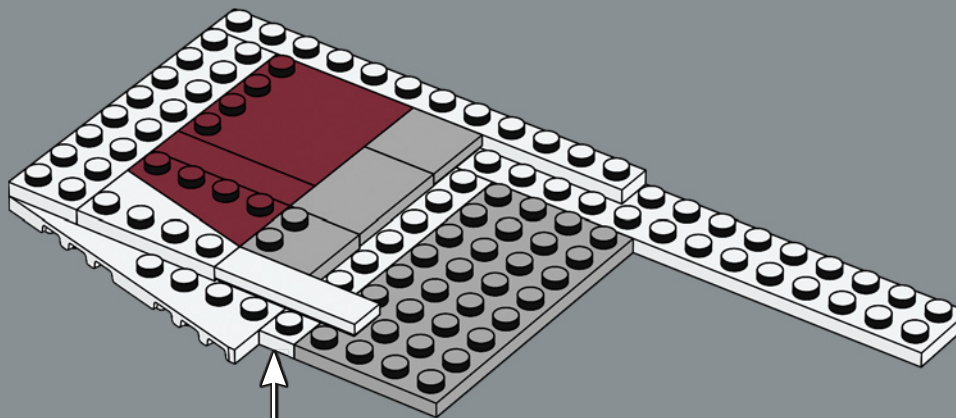

500

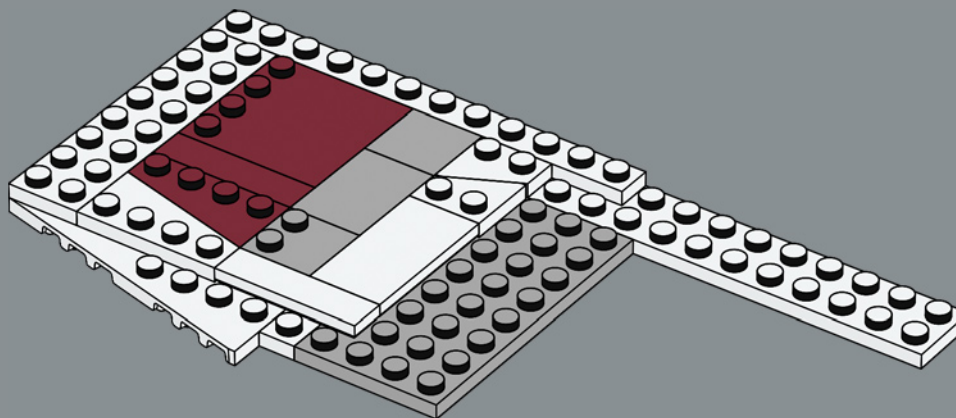

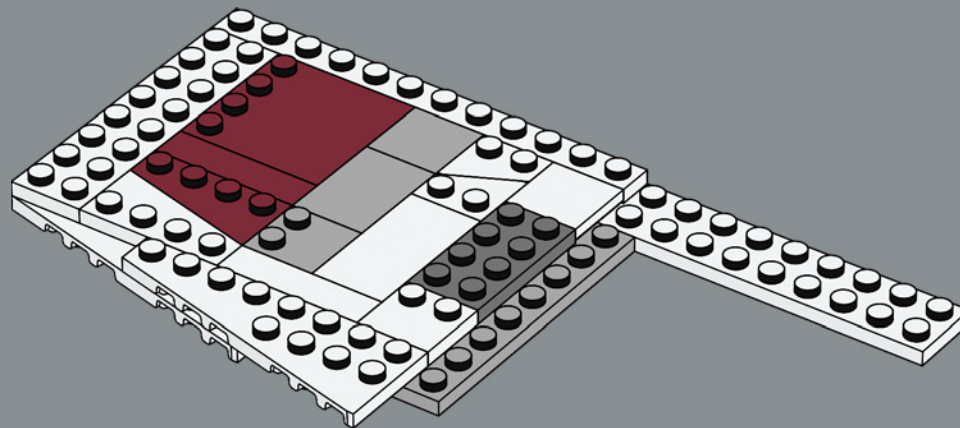
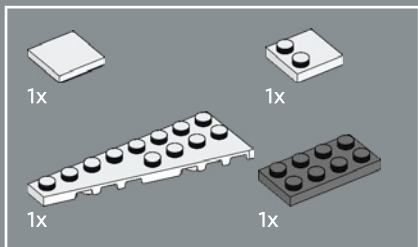

501

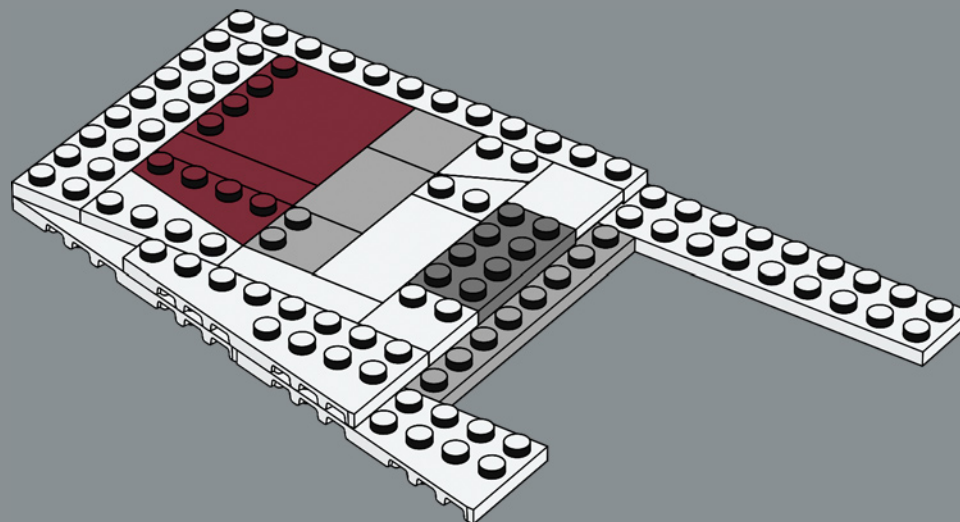
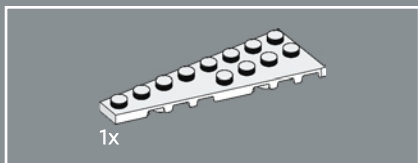

502



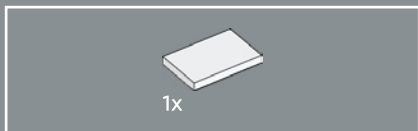

503

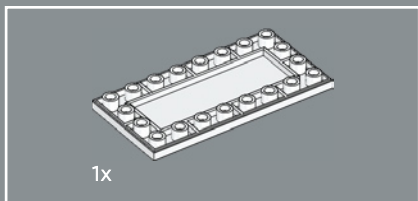
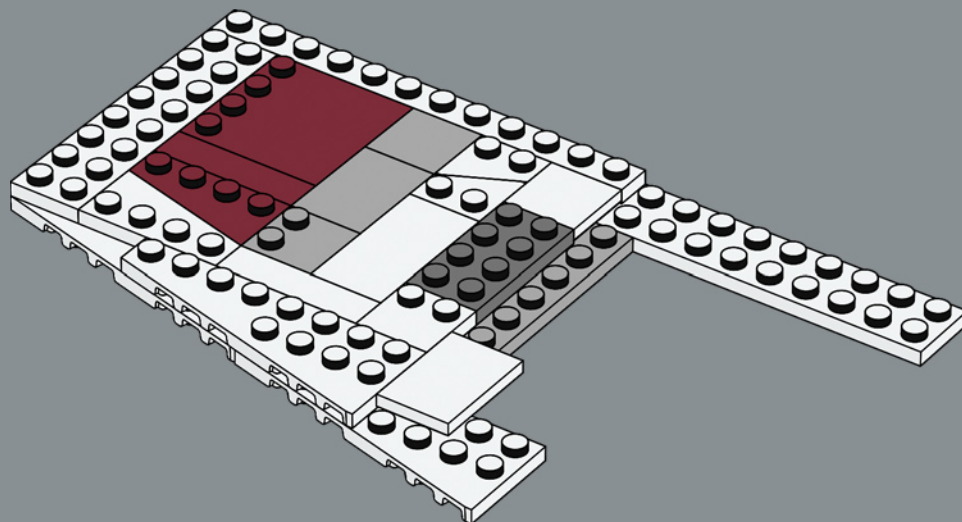

504

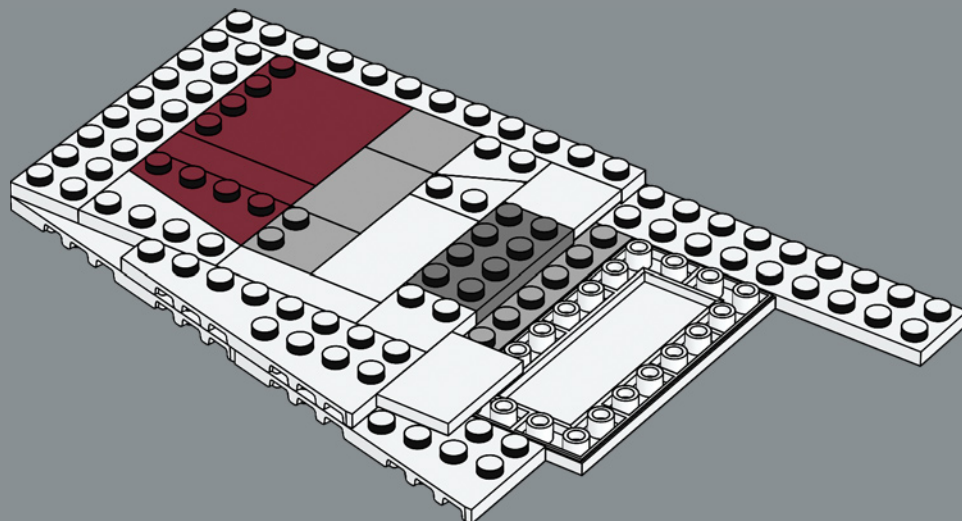

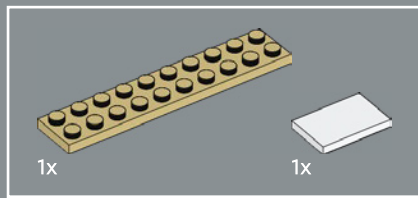

505

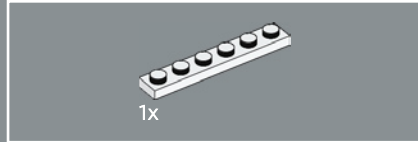
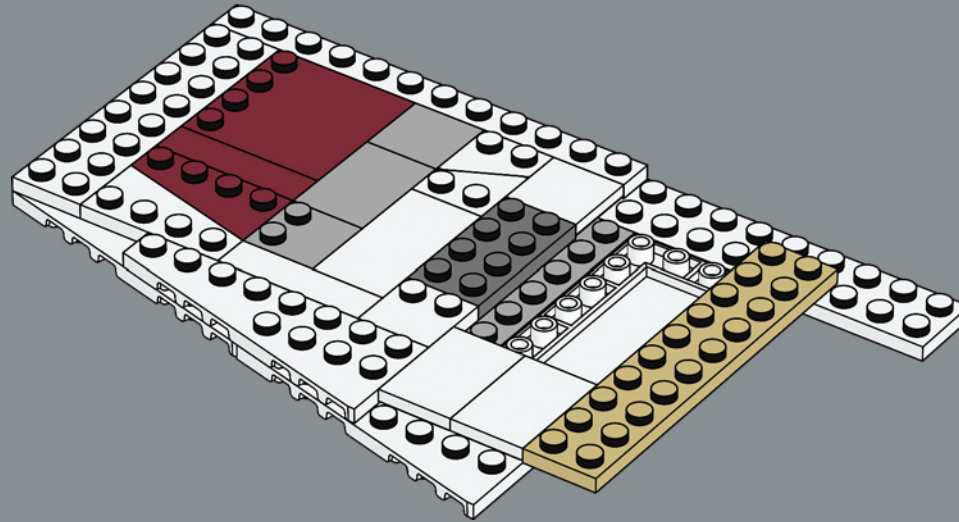

506

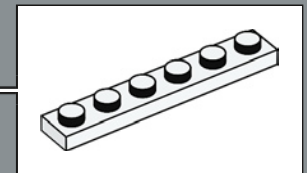
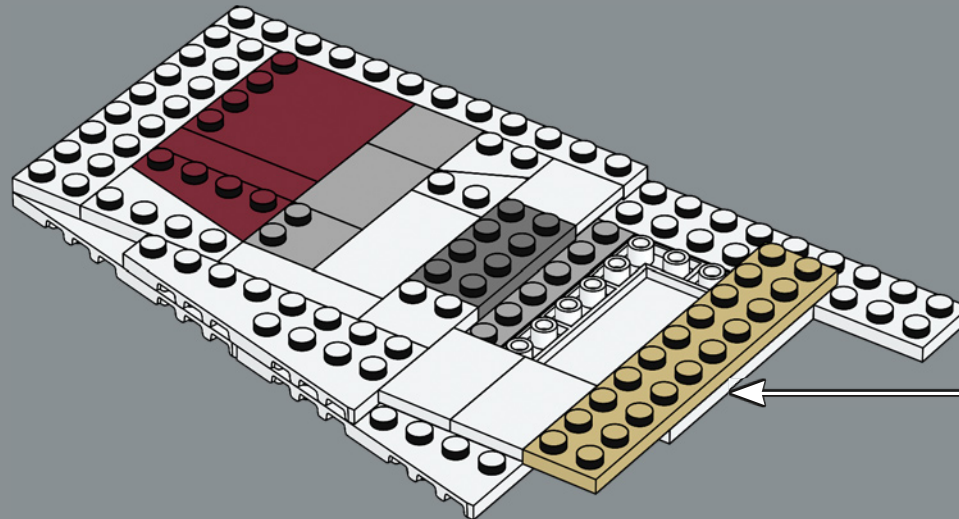

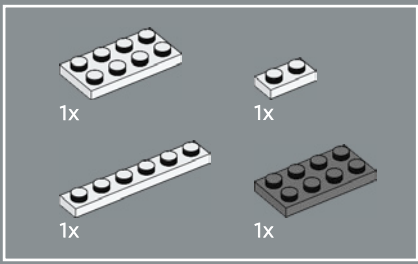

507

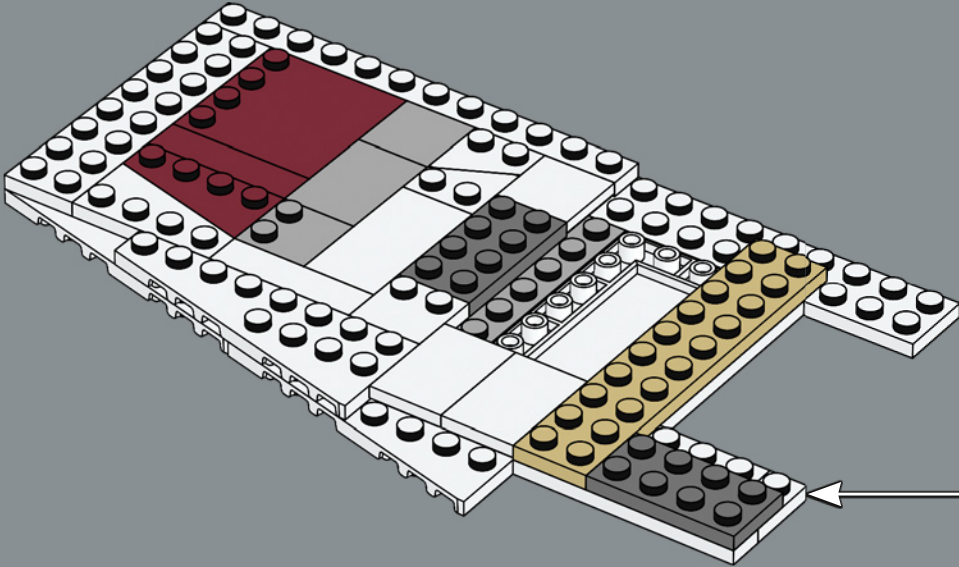
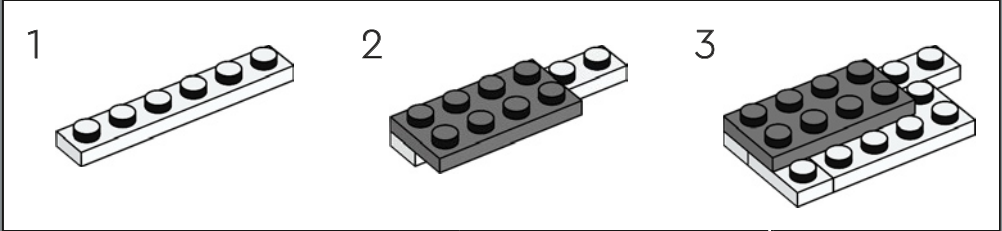

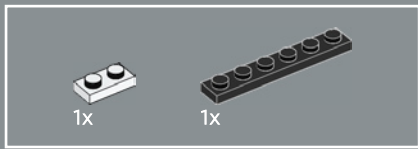

508

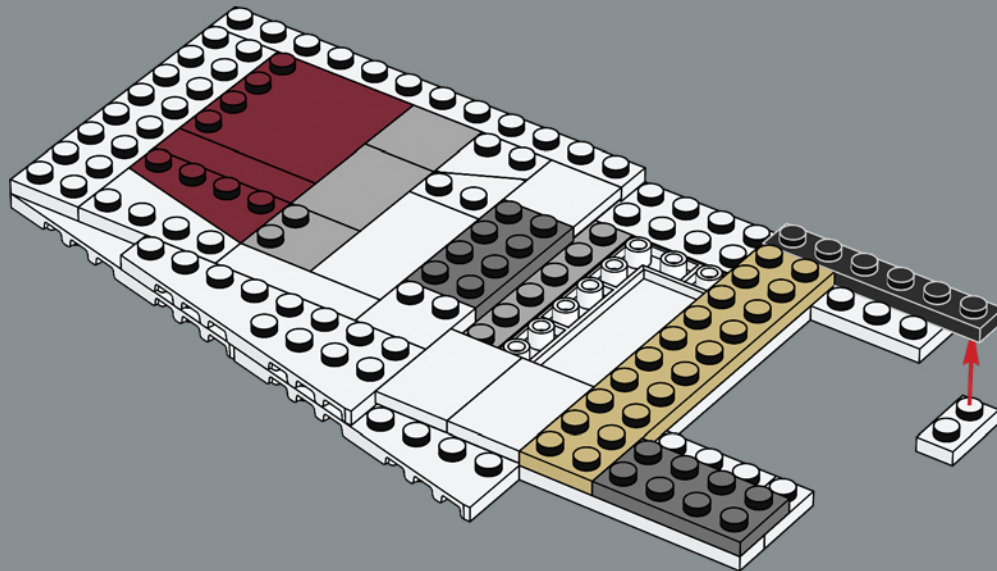

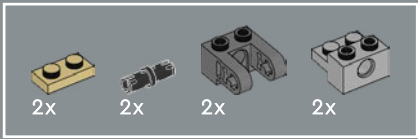

509

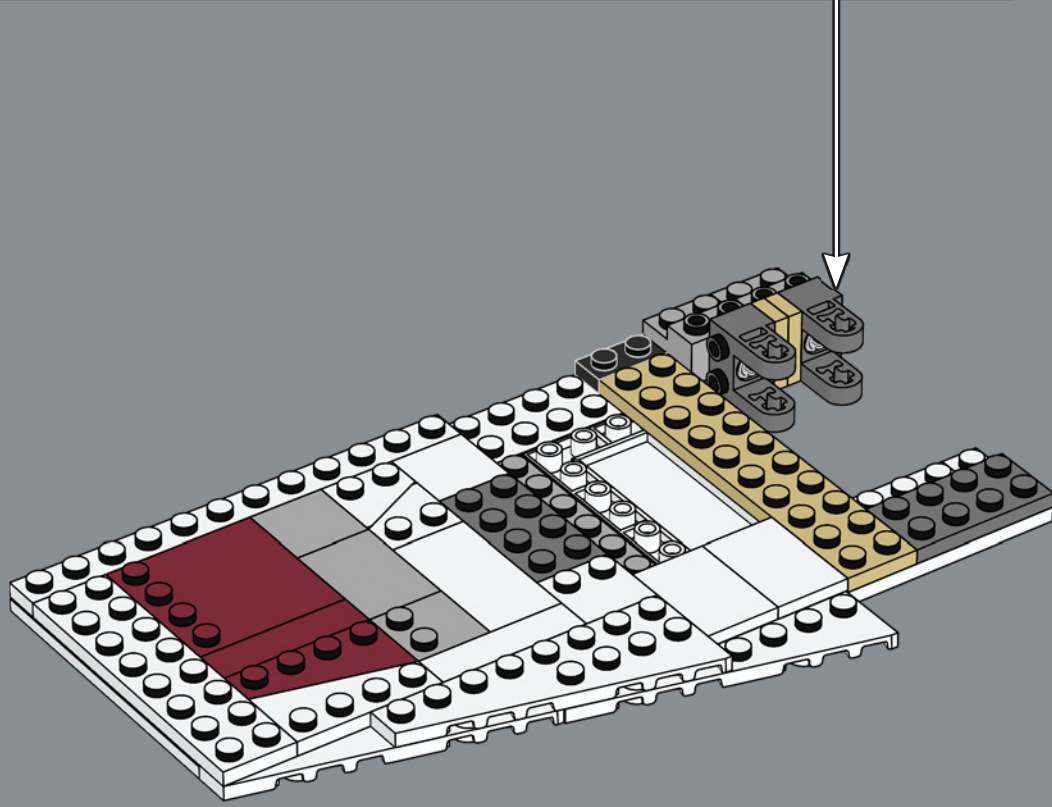
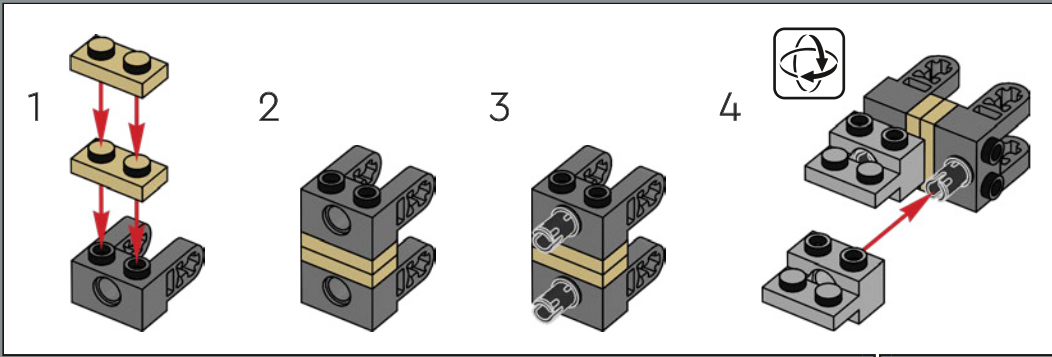

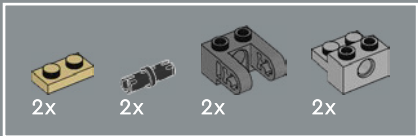

510

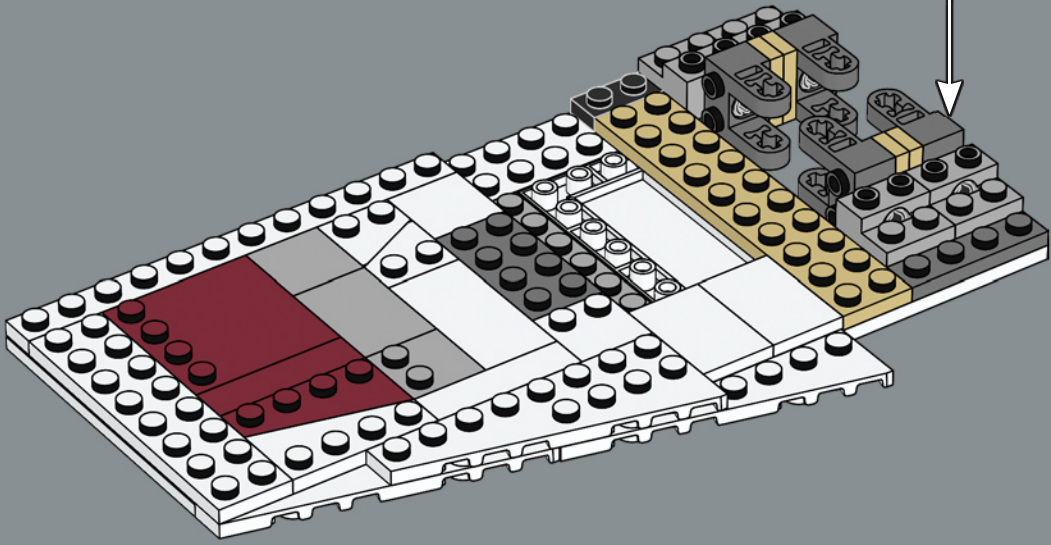
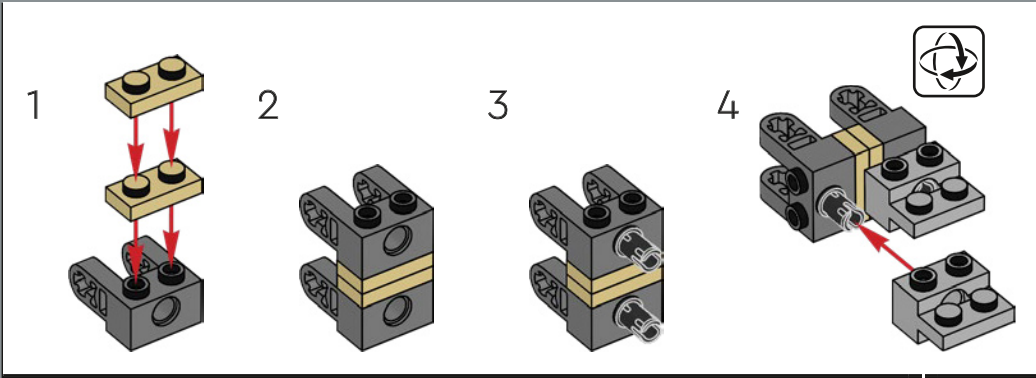

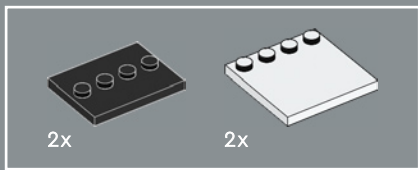

511

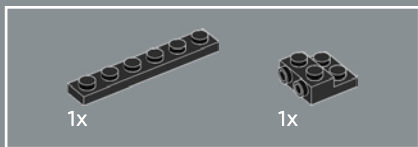
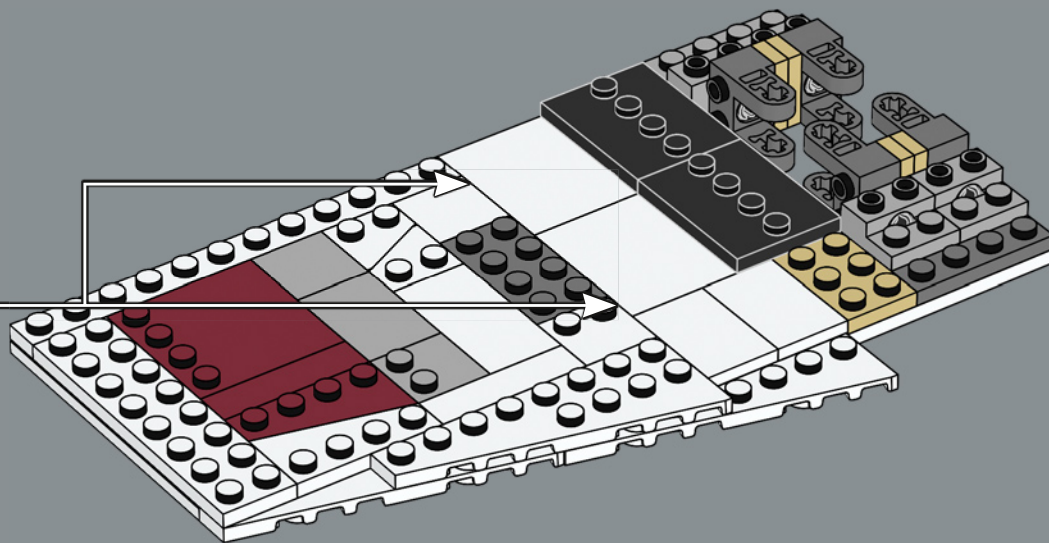
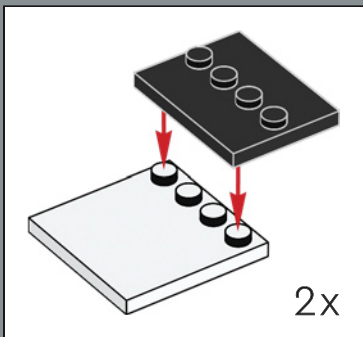

512

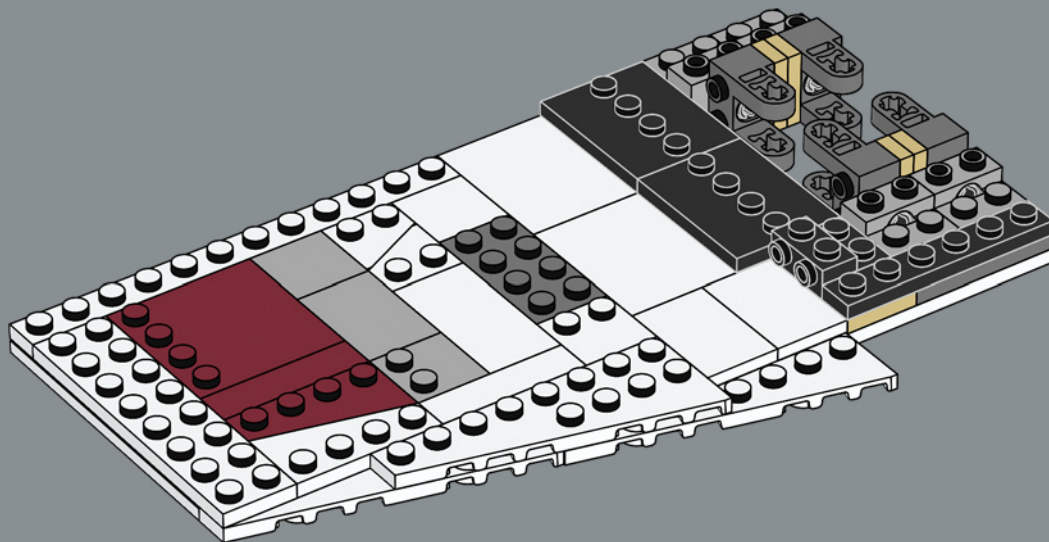

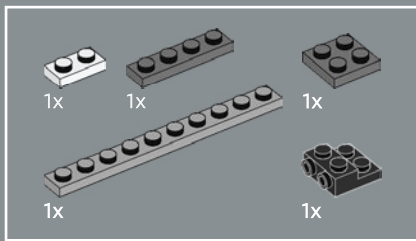

513

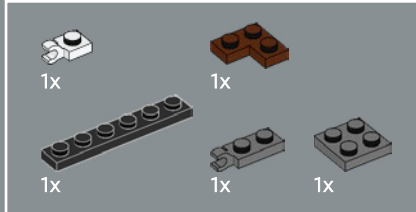
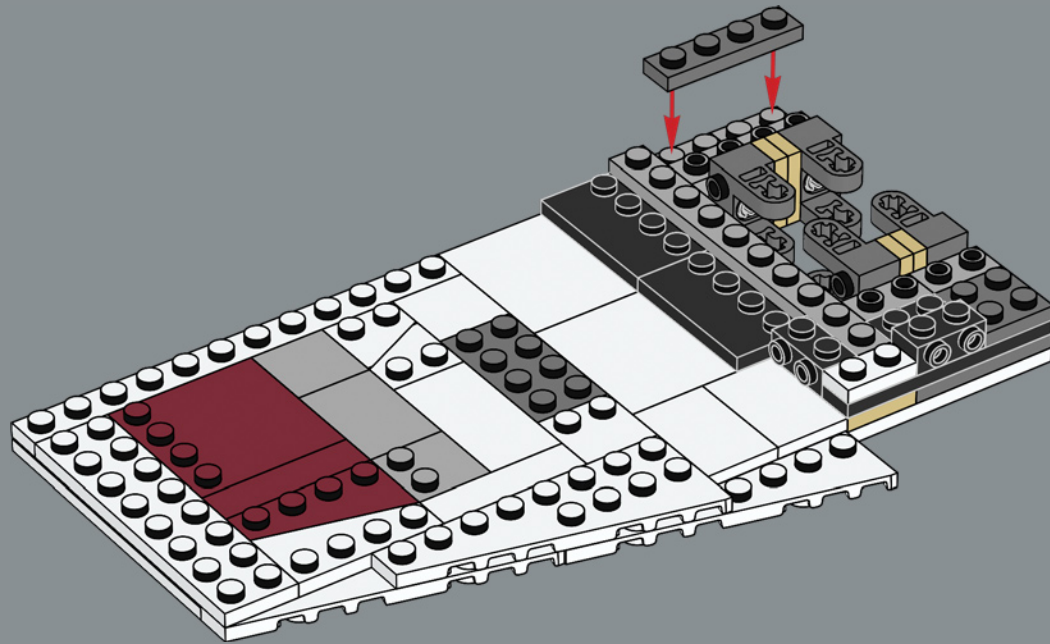

514

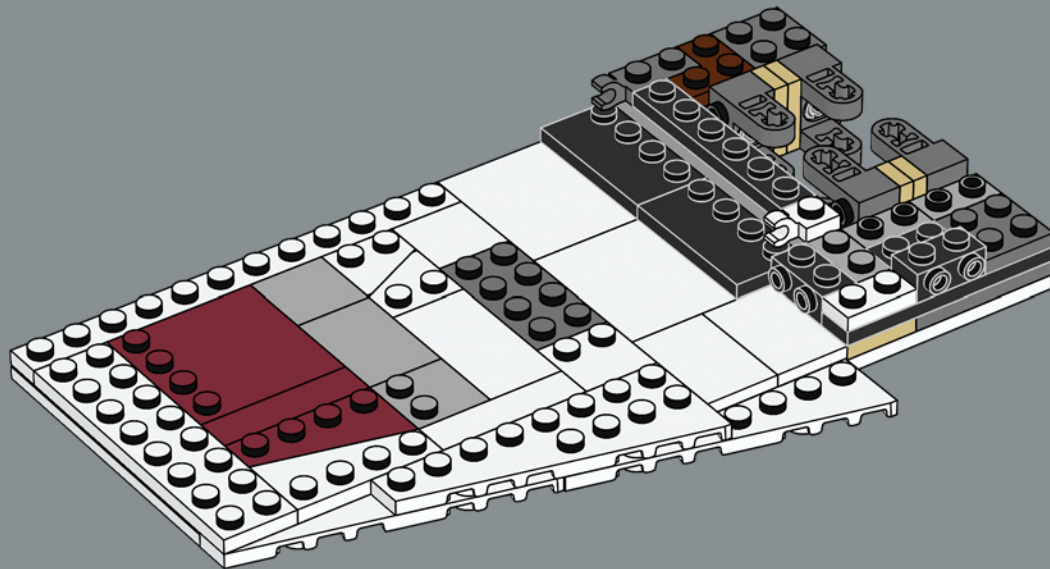

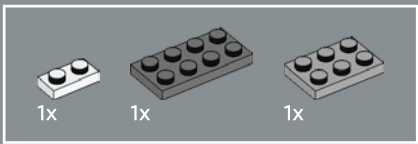

515

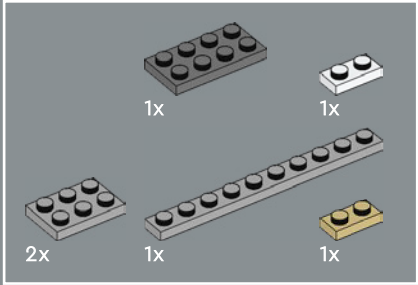
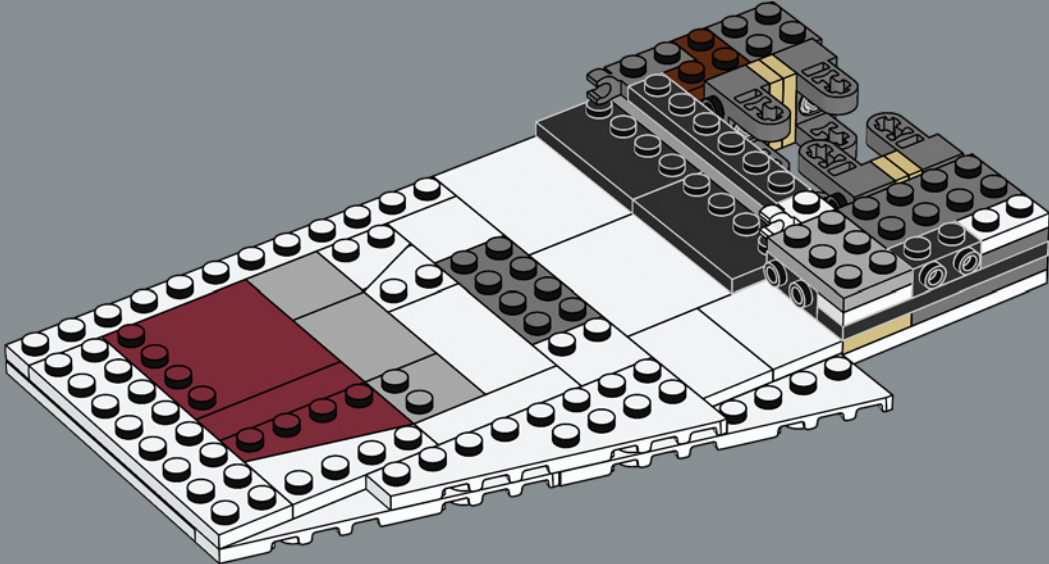

516

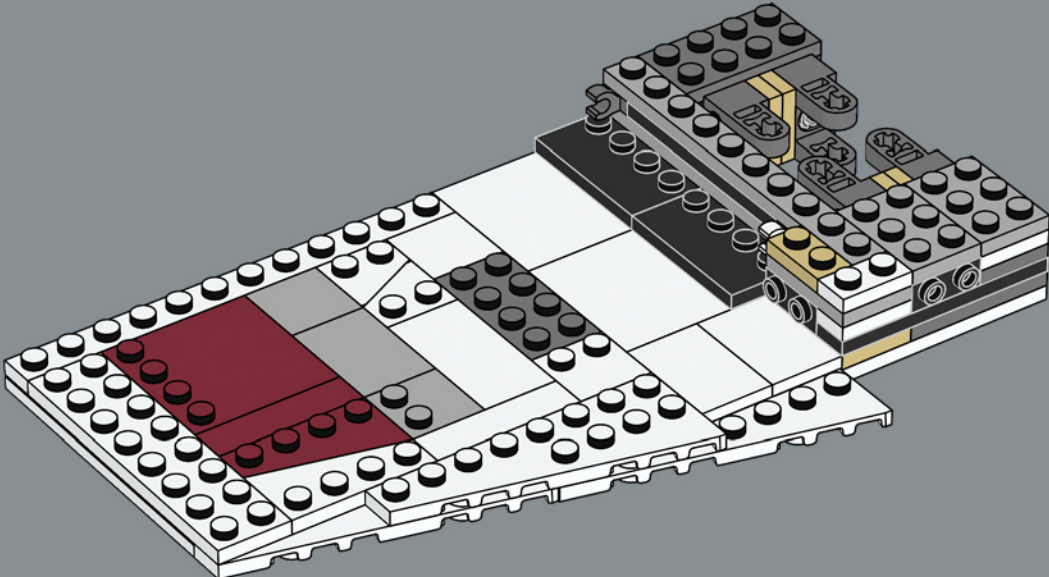

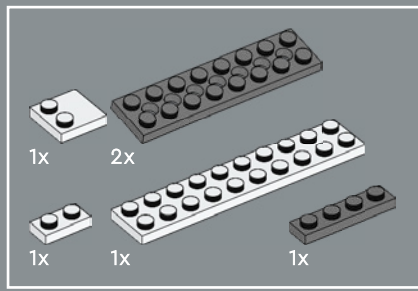

517

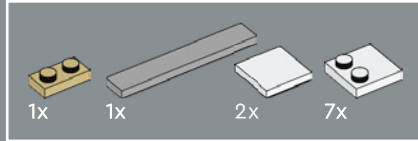
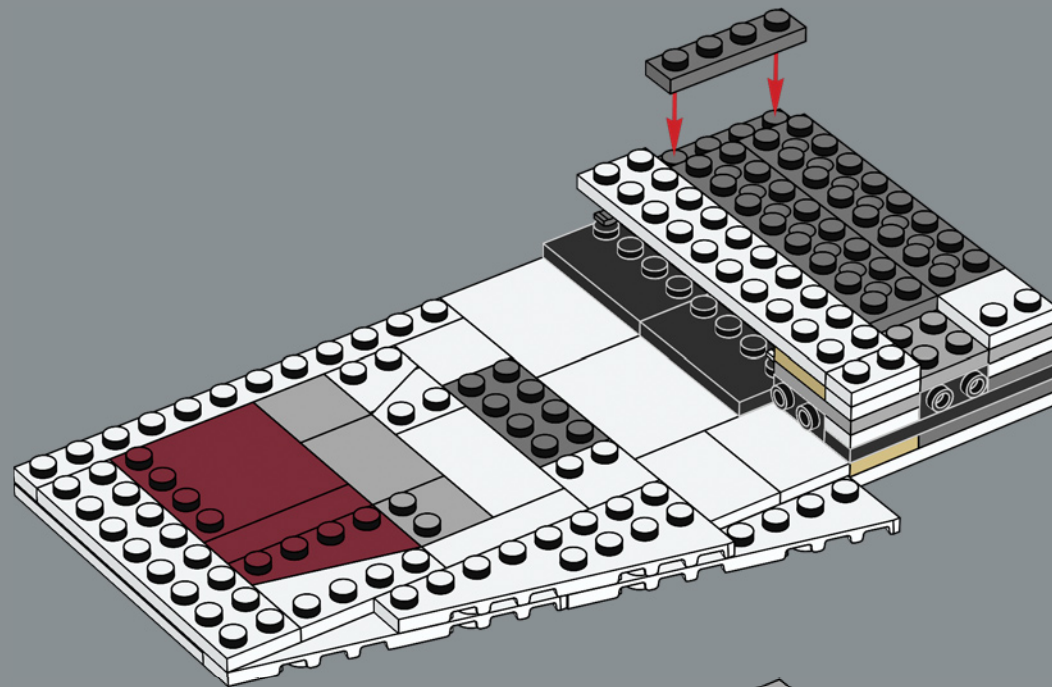

518

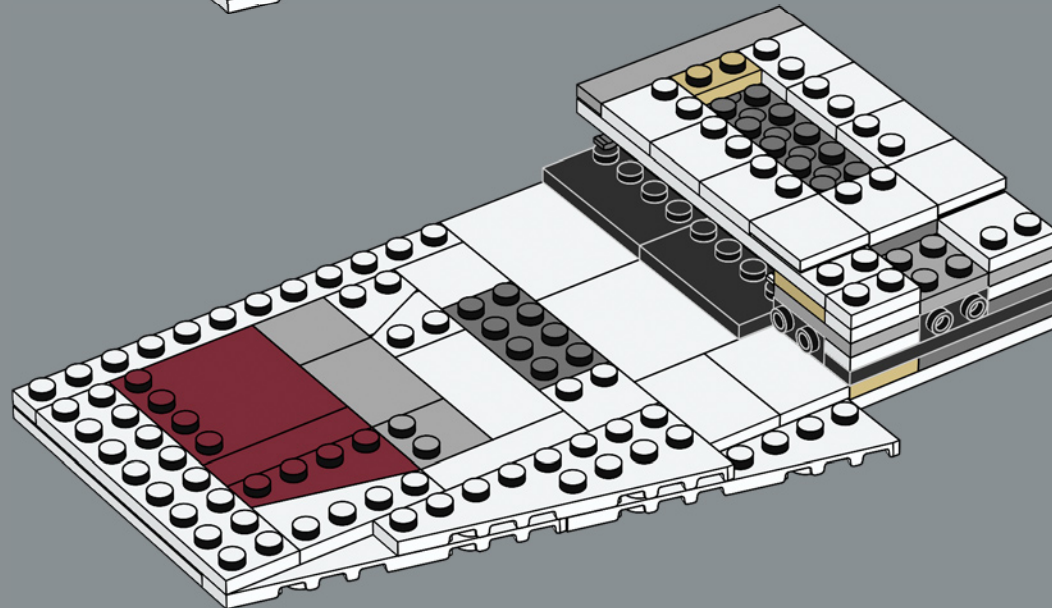

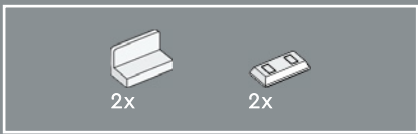

519

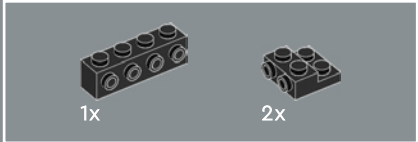
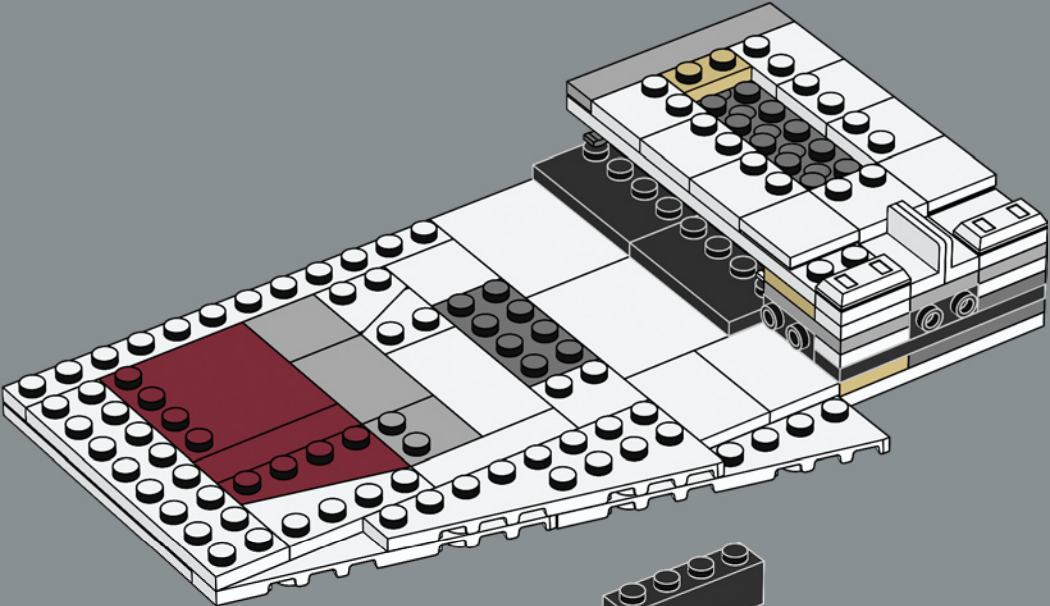

520

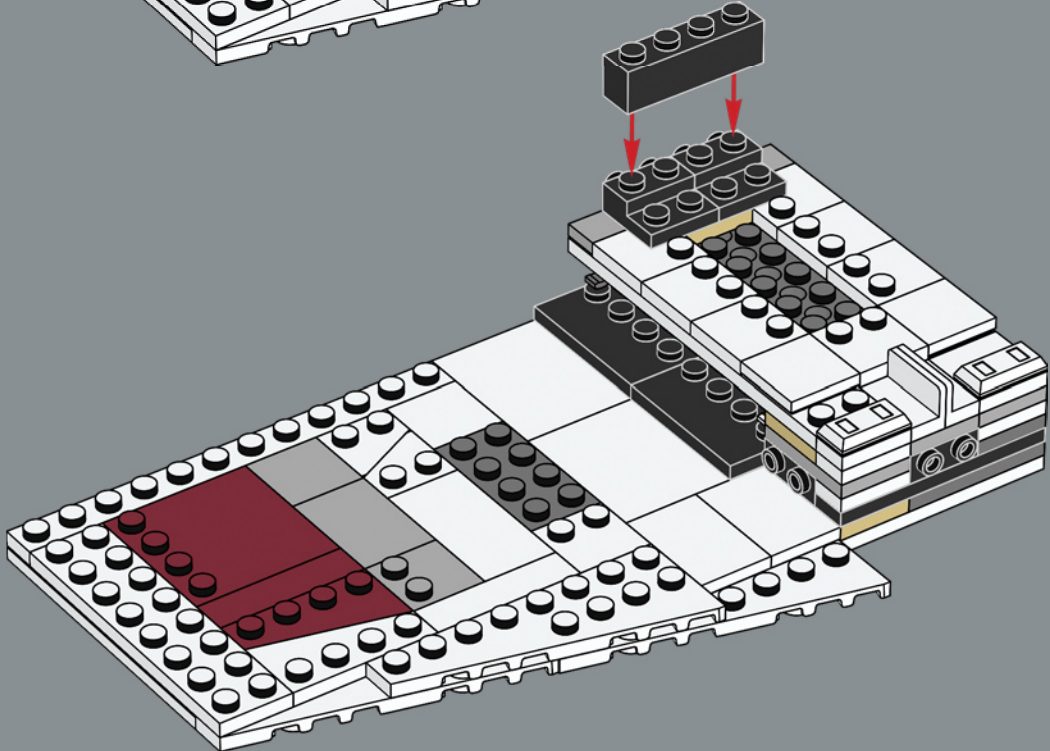



2x

521

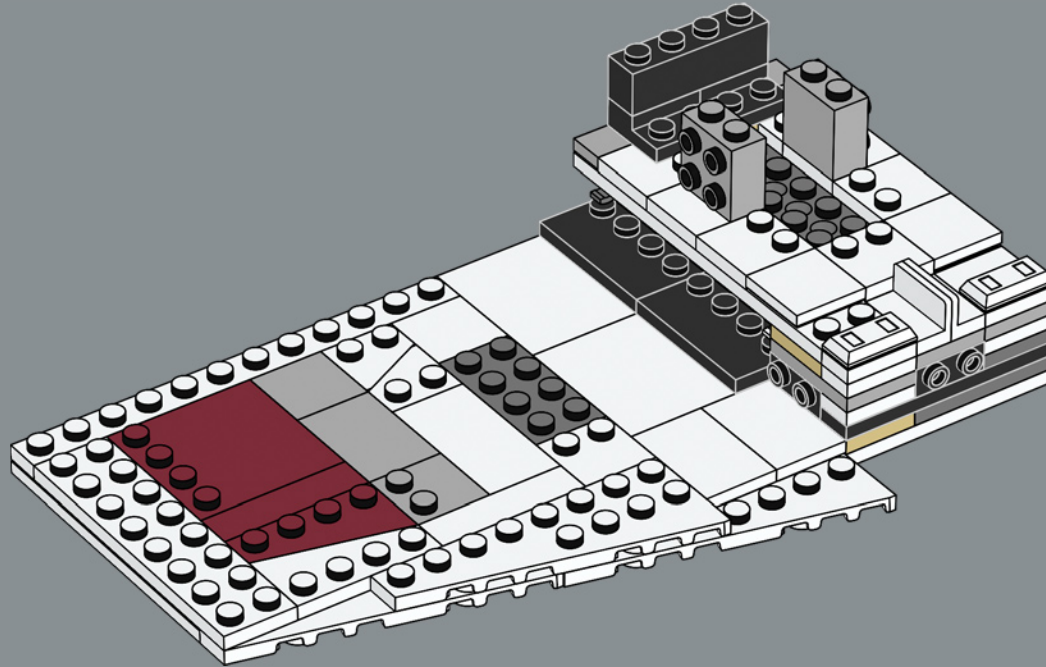

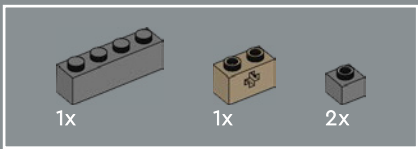

522

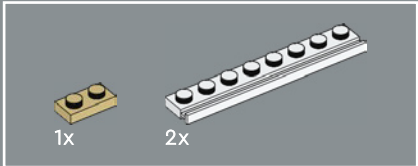
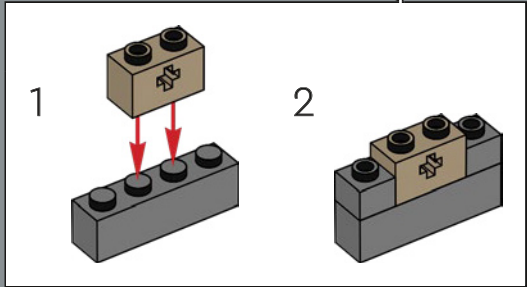
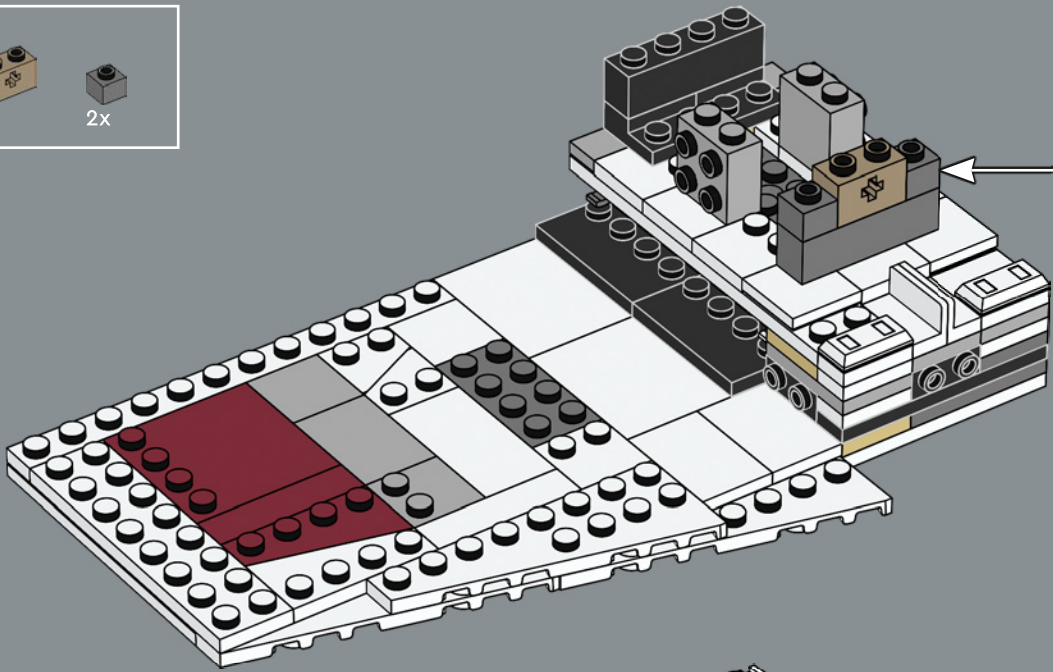

523

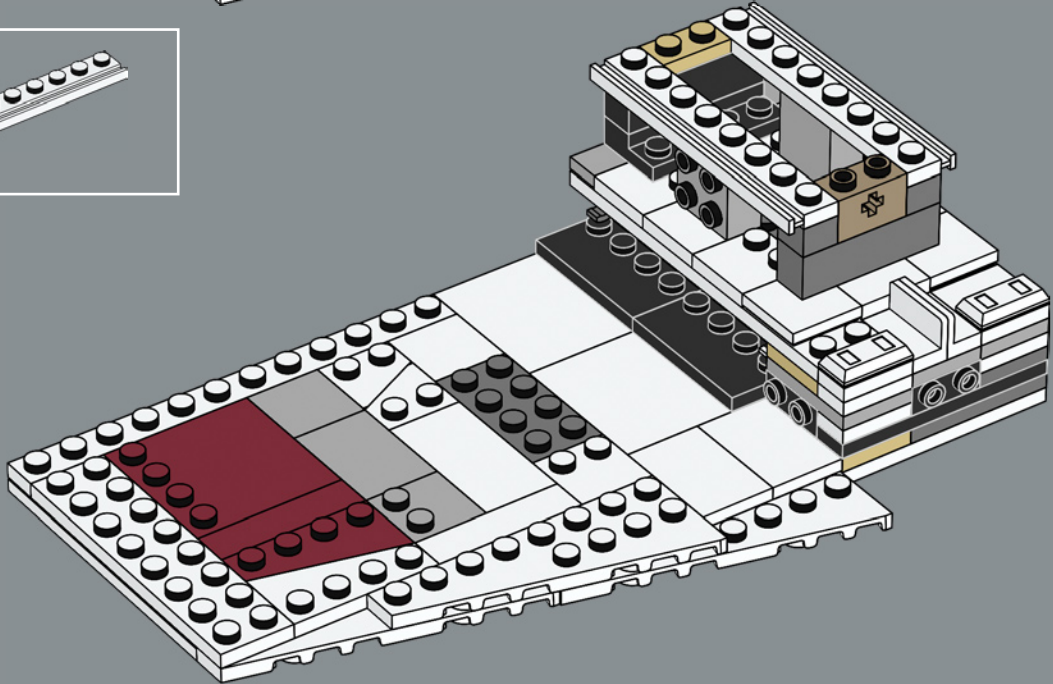

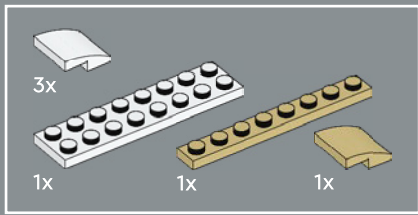

524

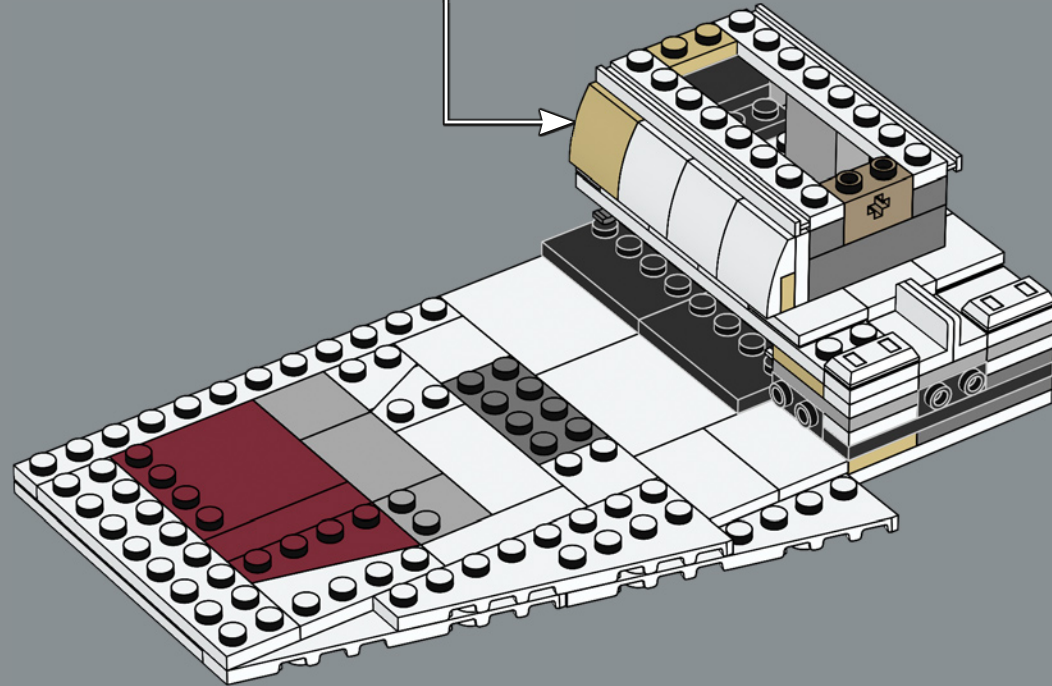
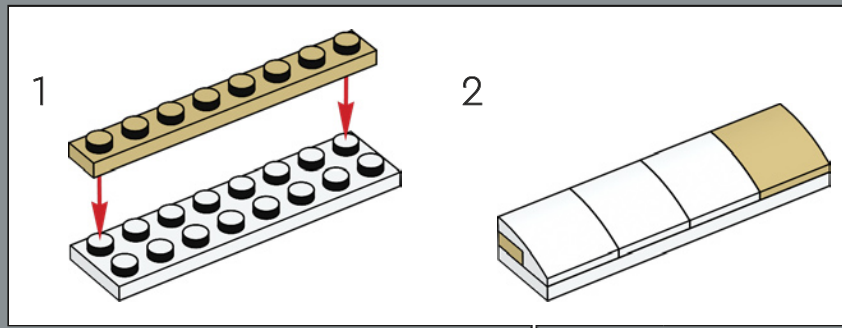

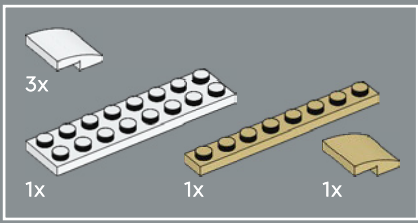

525

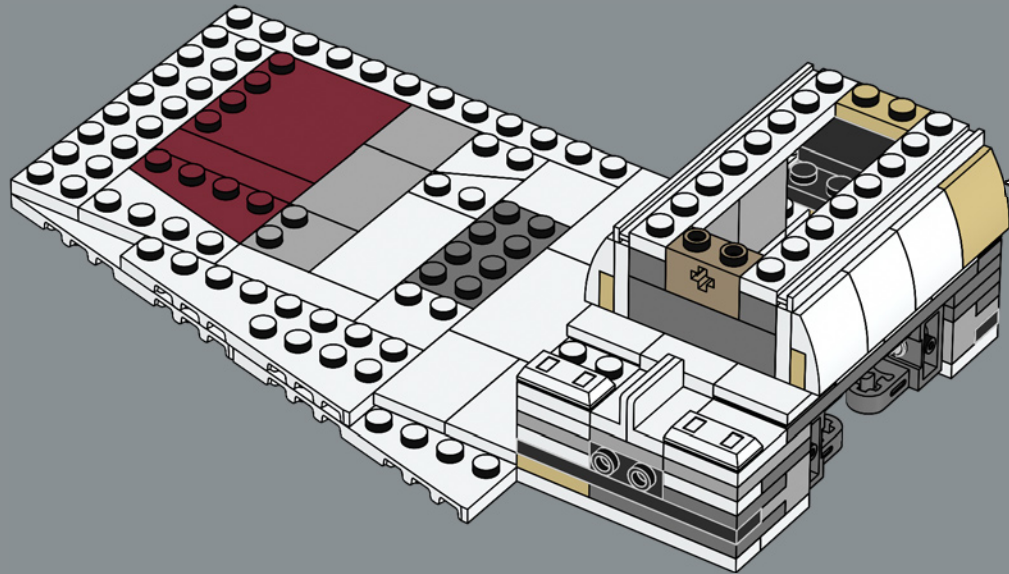
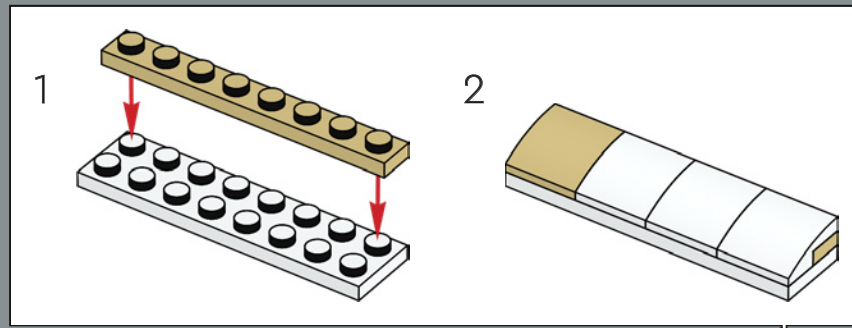

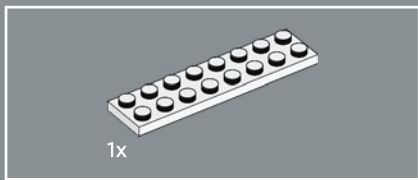

526

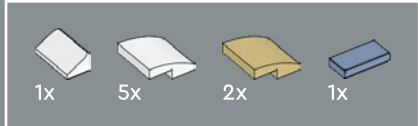
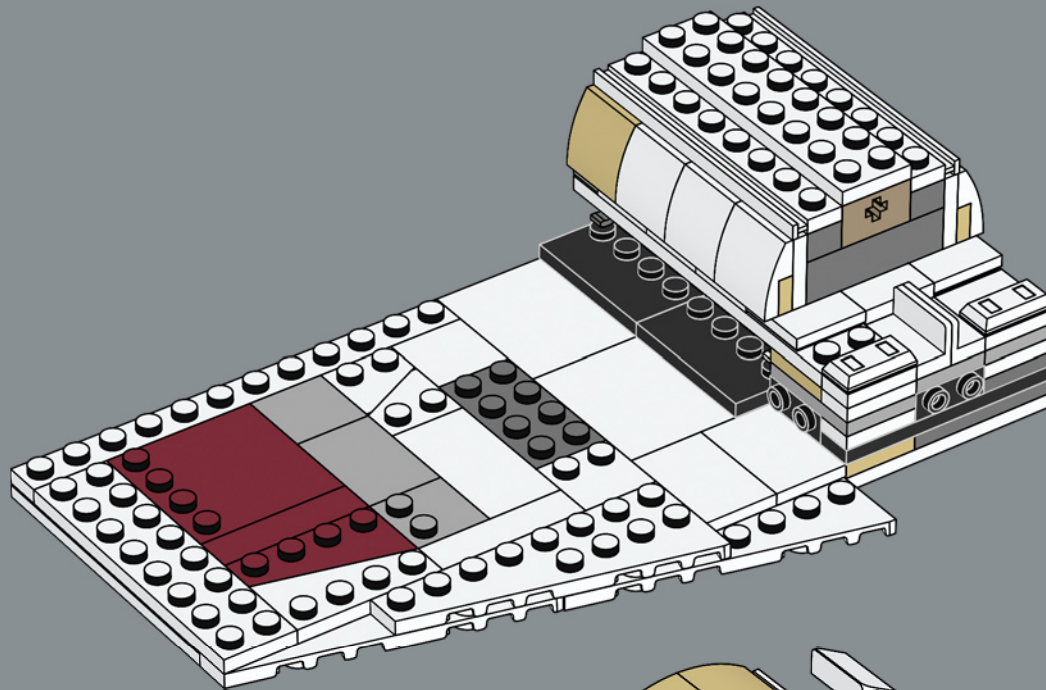

527

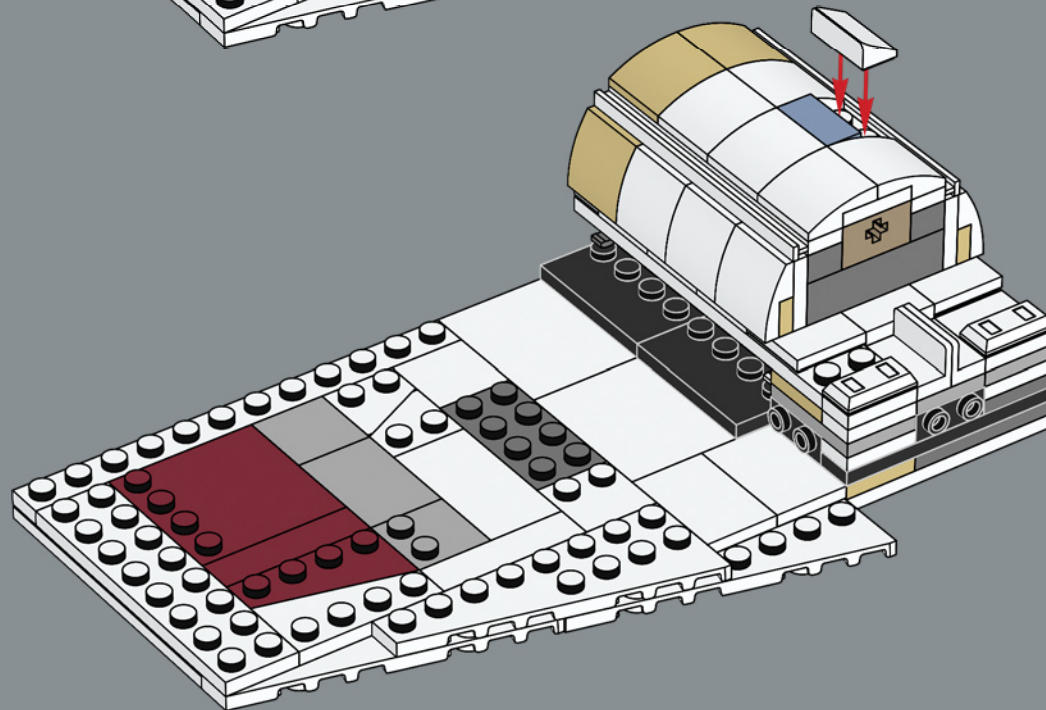

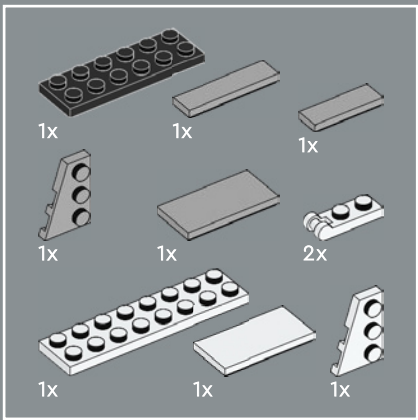

528

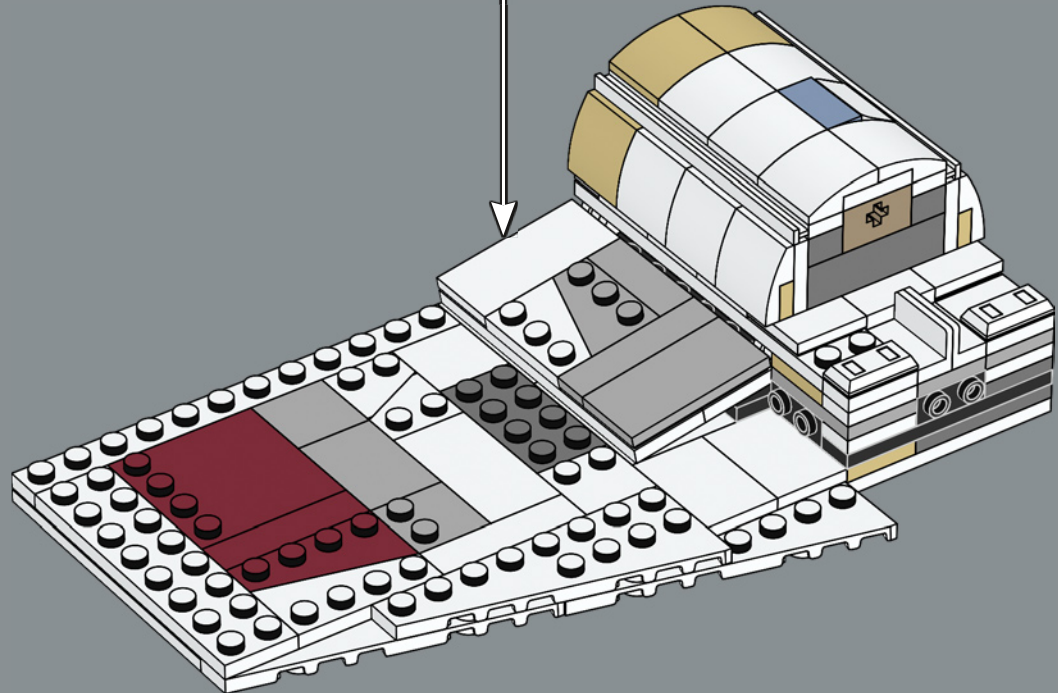
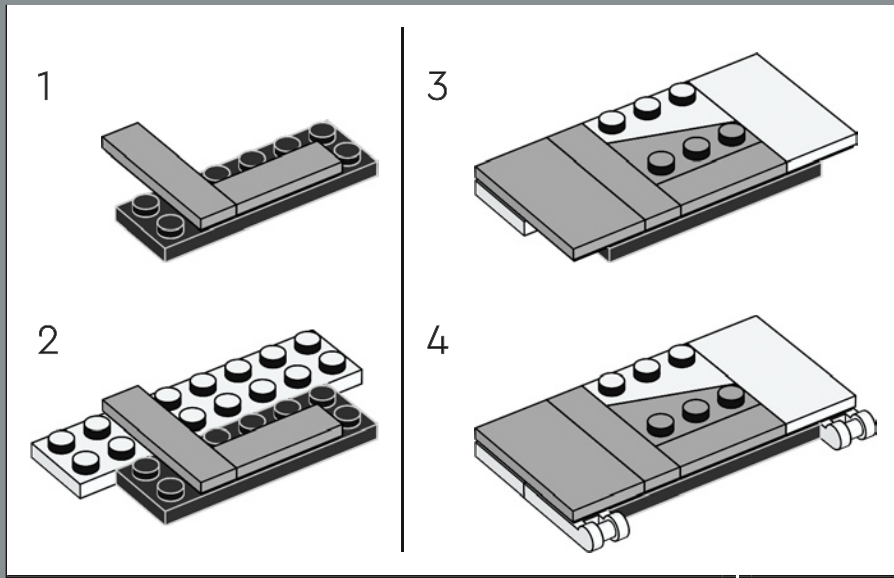

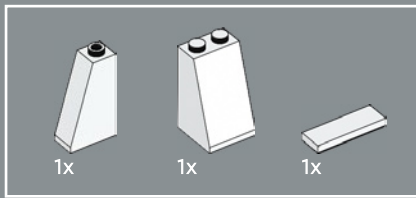

529

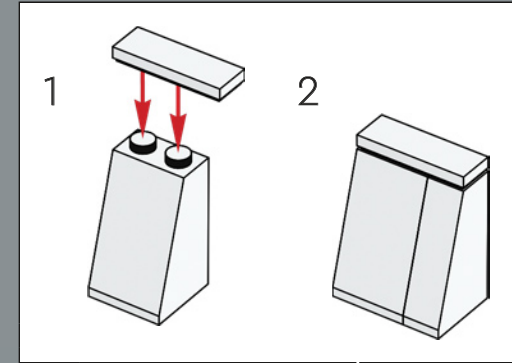
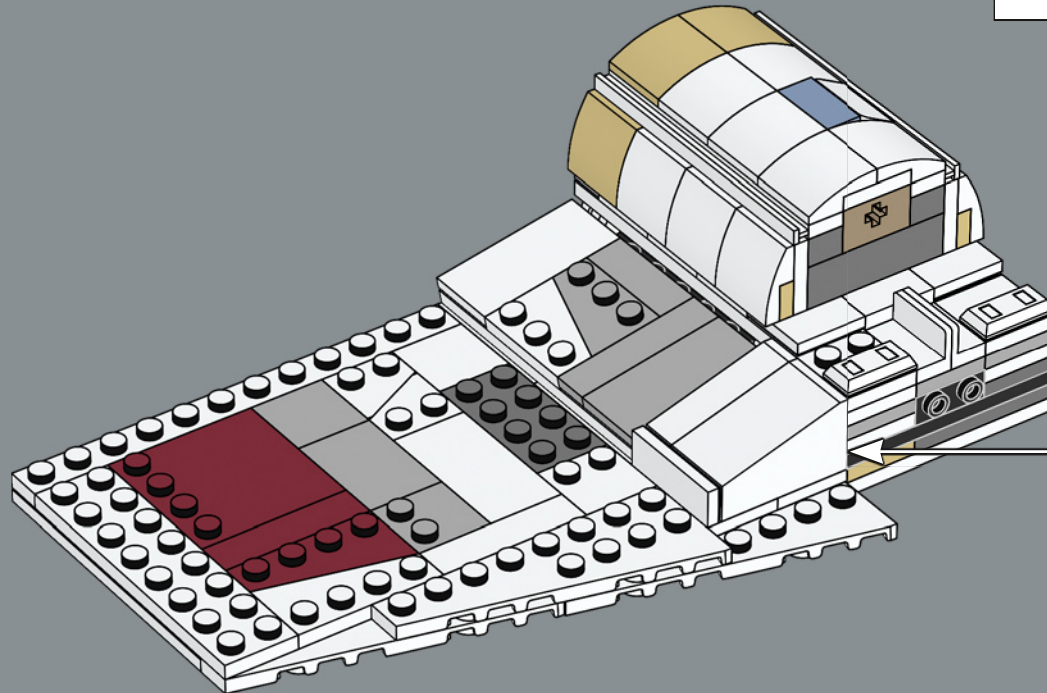

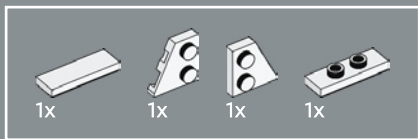

530

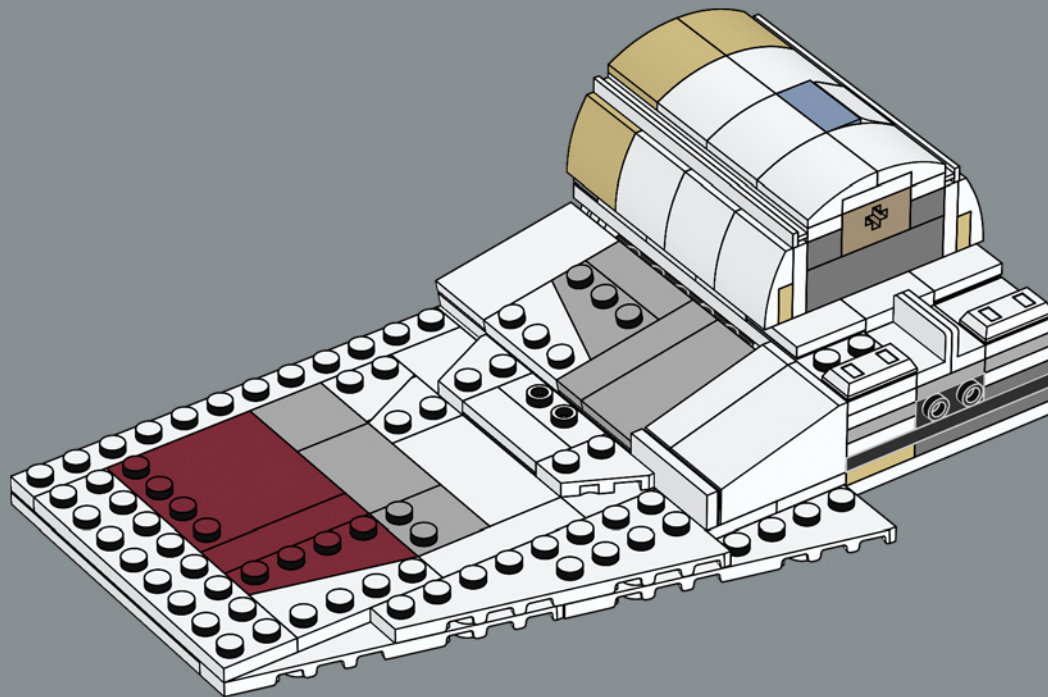

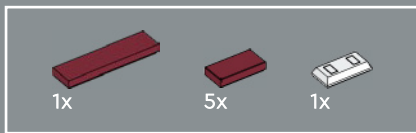

531

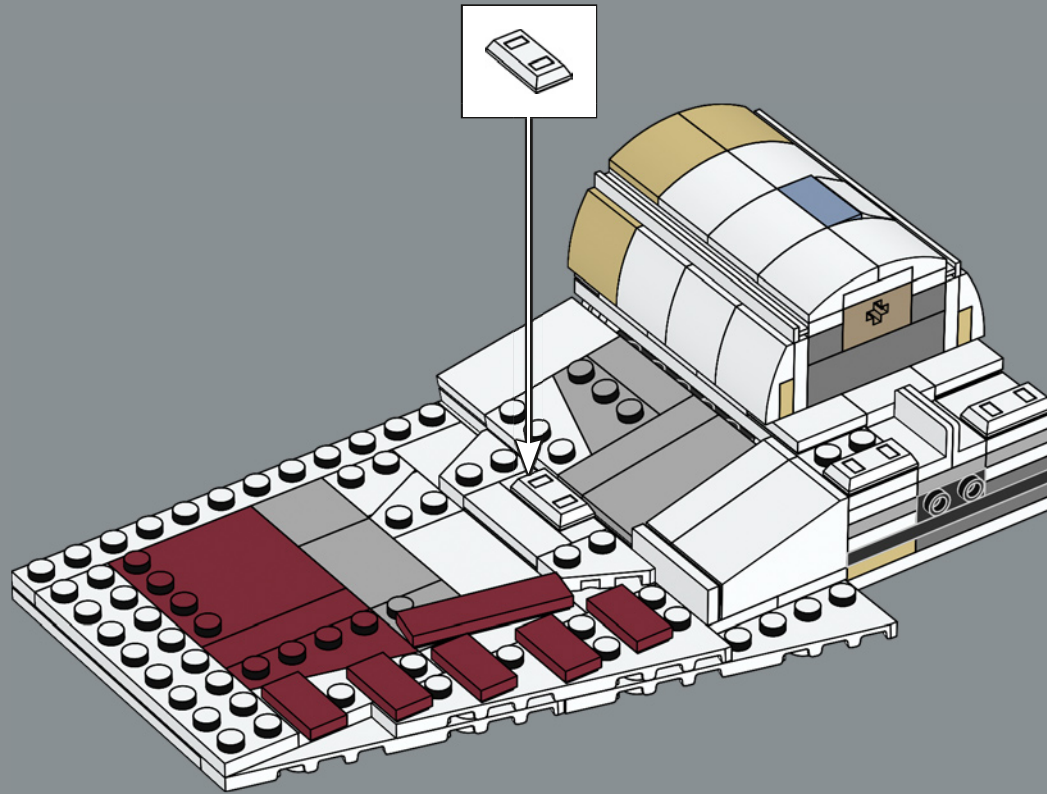

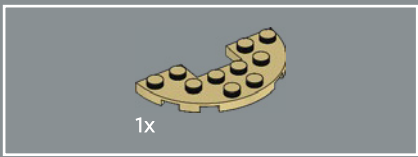

532

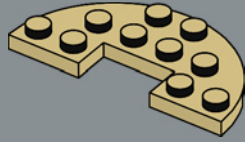

533

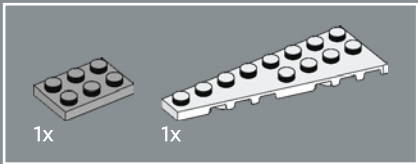
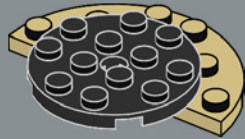

534

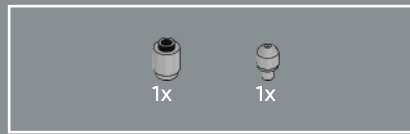
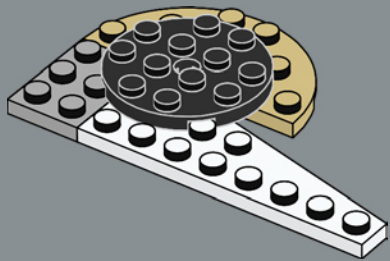

535

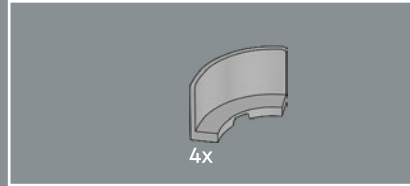
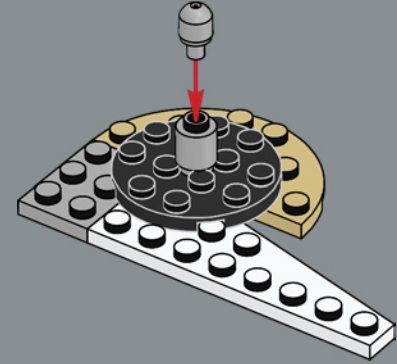

536

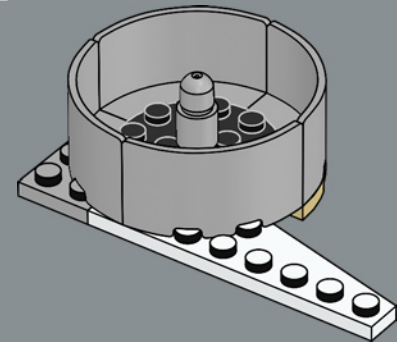

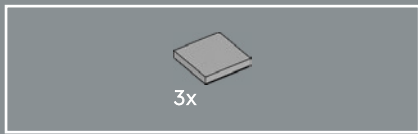

537

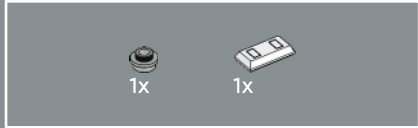
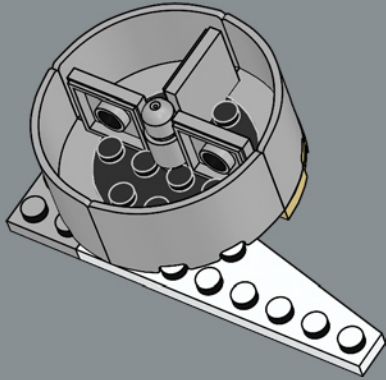

538

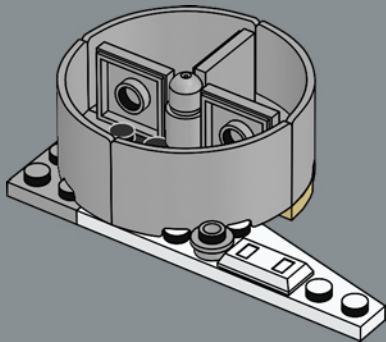

539

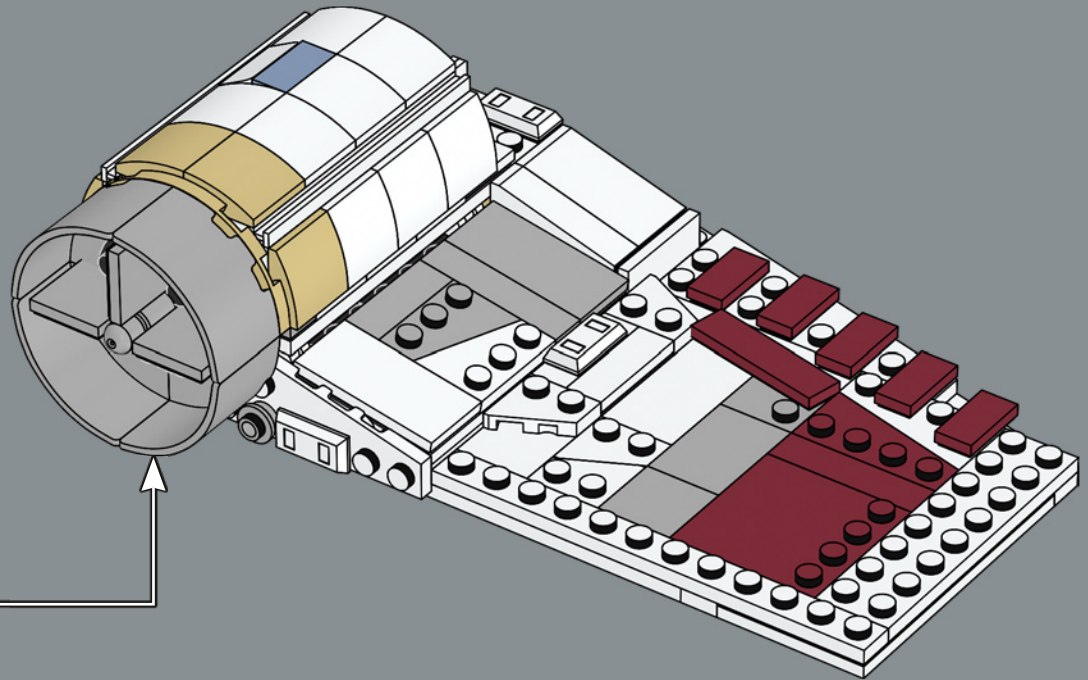

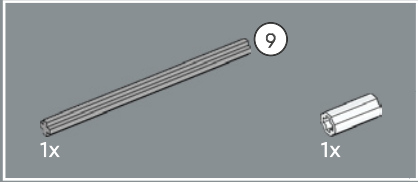
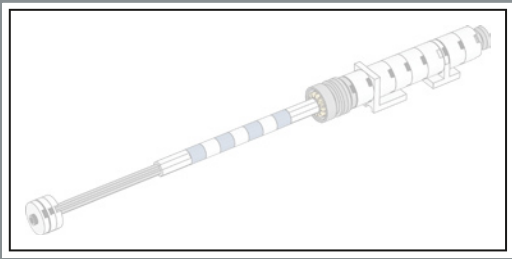

540

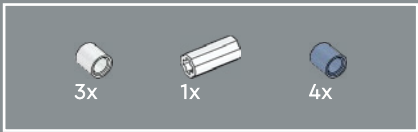
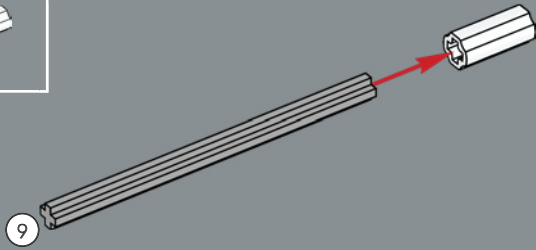

541

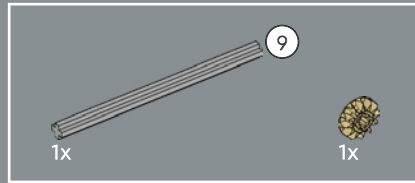
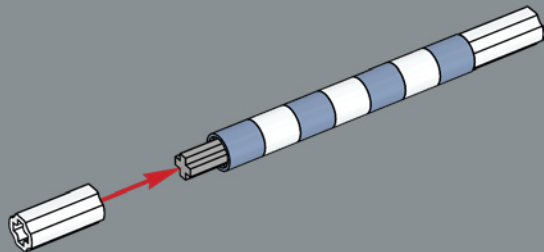

542

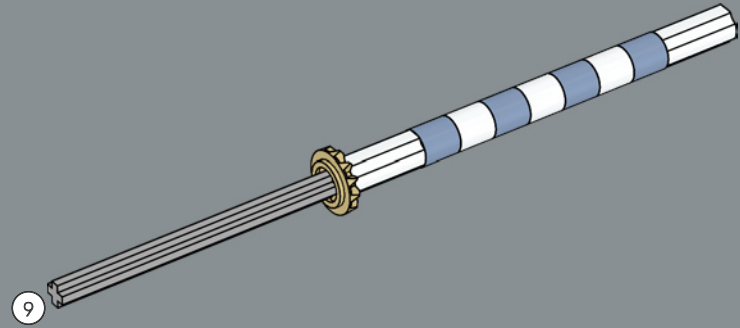

543

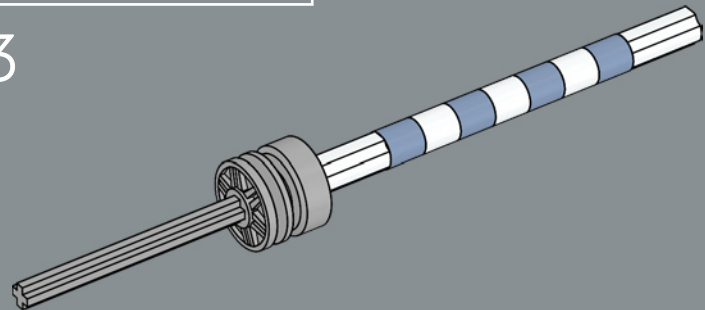

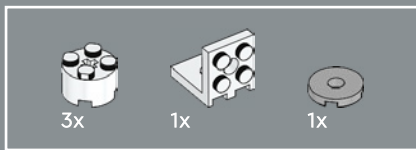

544

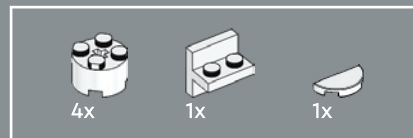
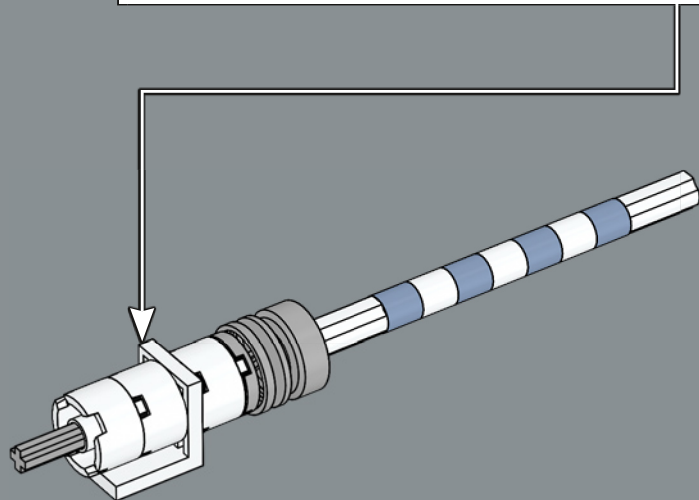
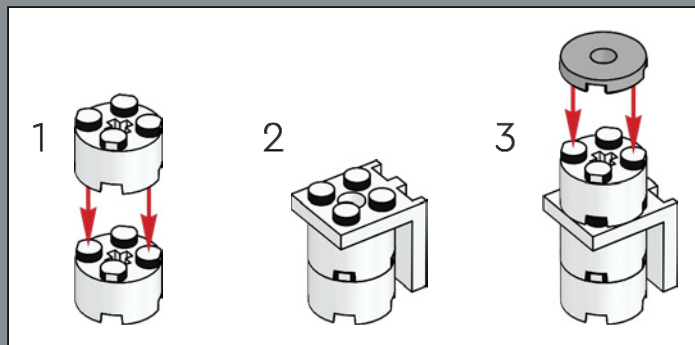

545

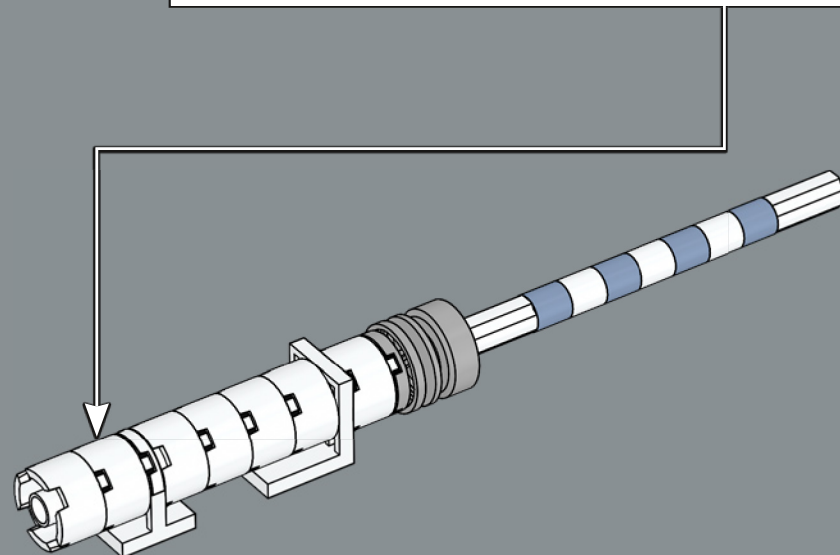
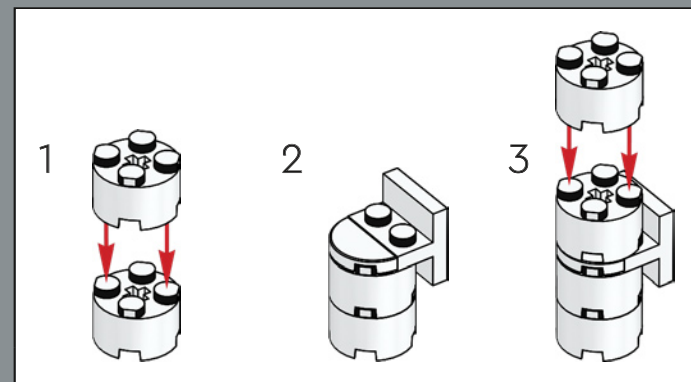

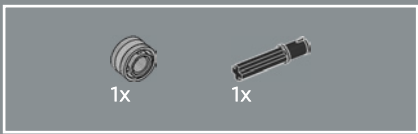

546

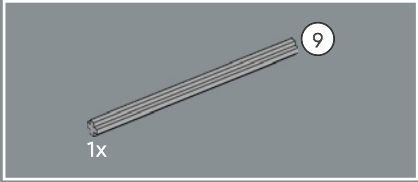
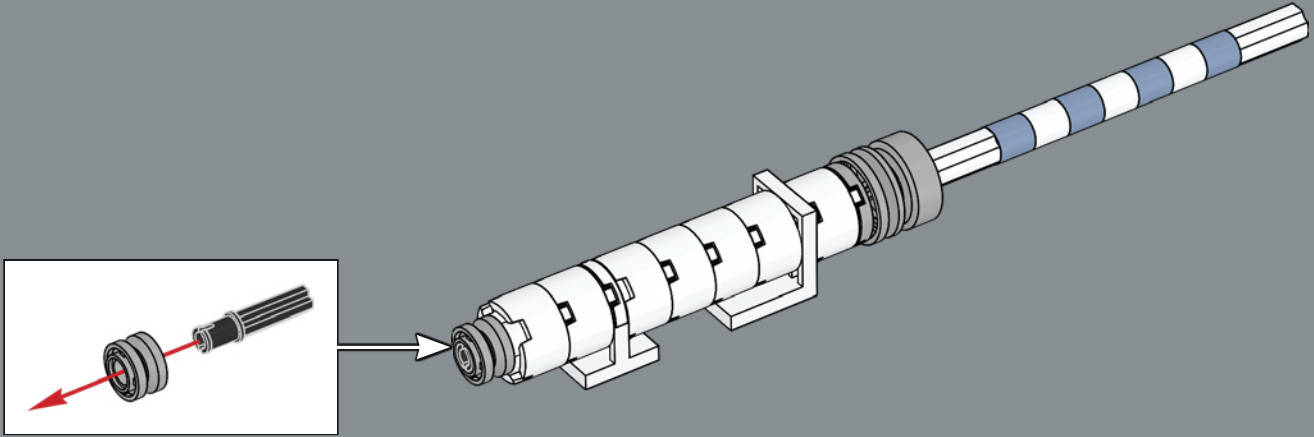

547

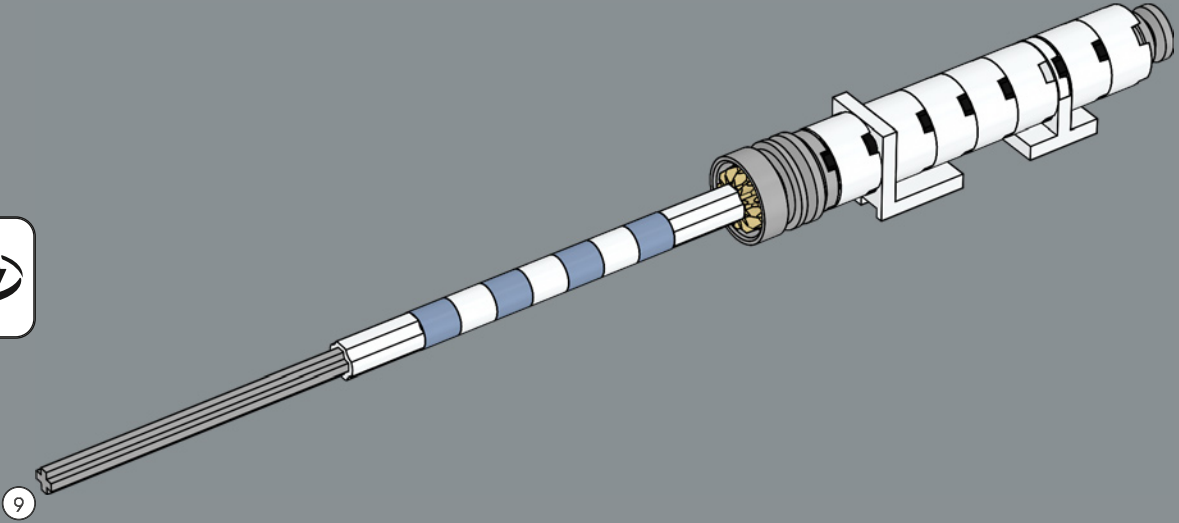

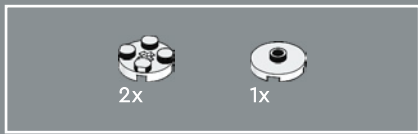

548

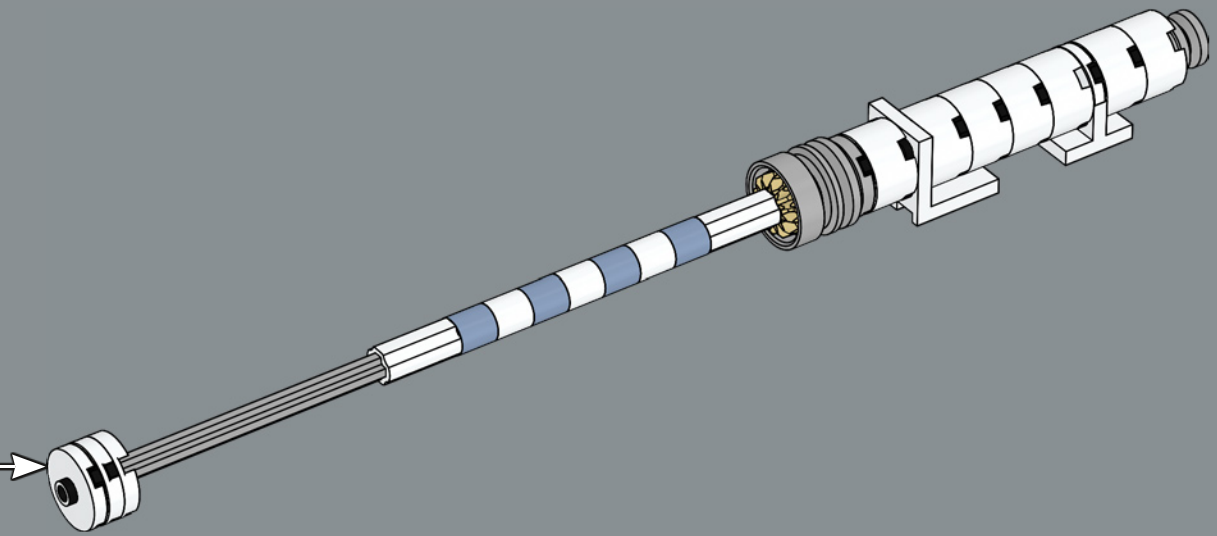
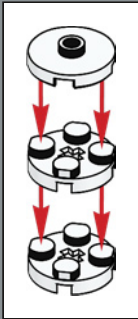

549

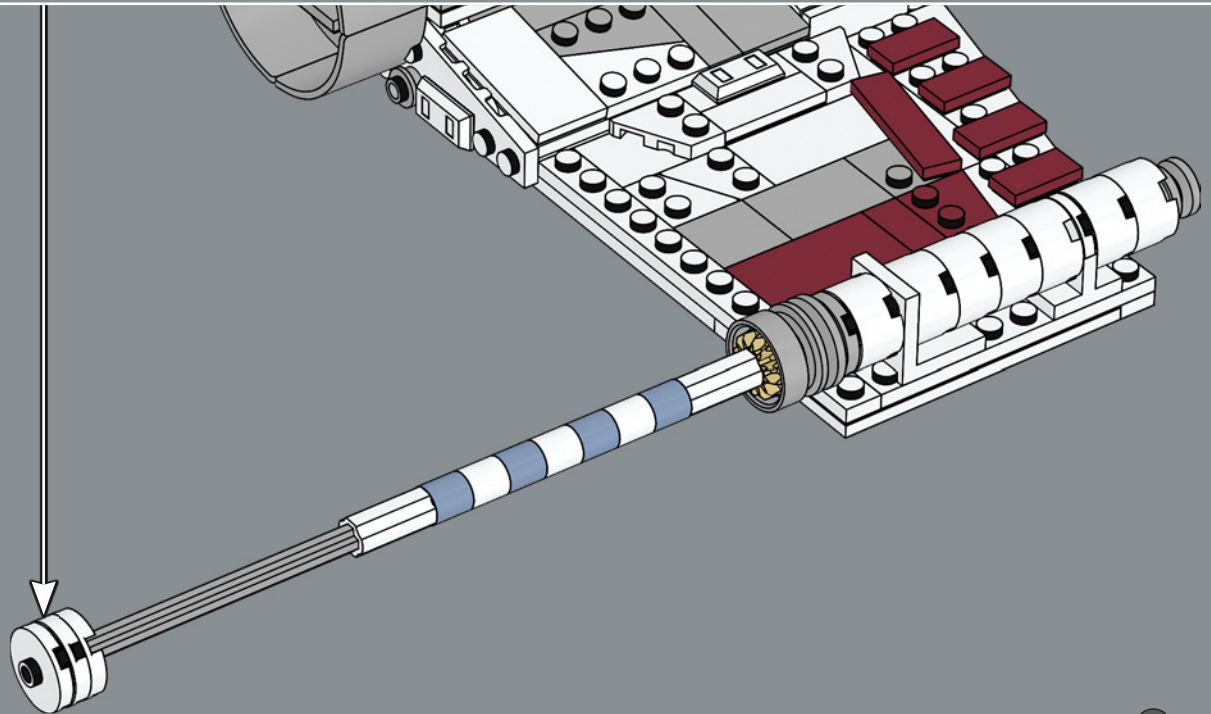

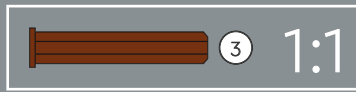
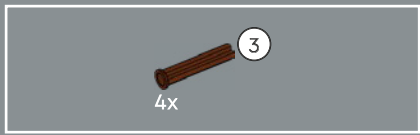

550

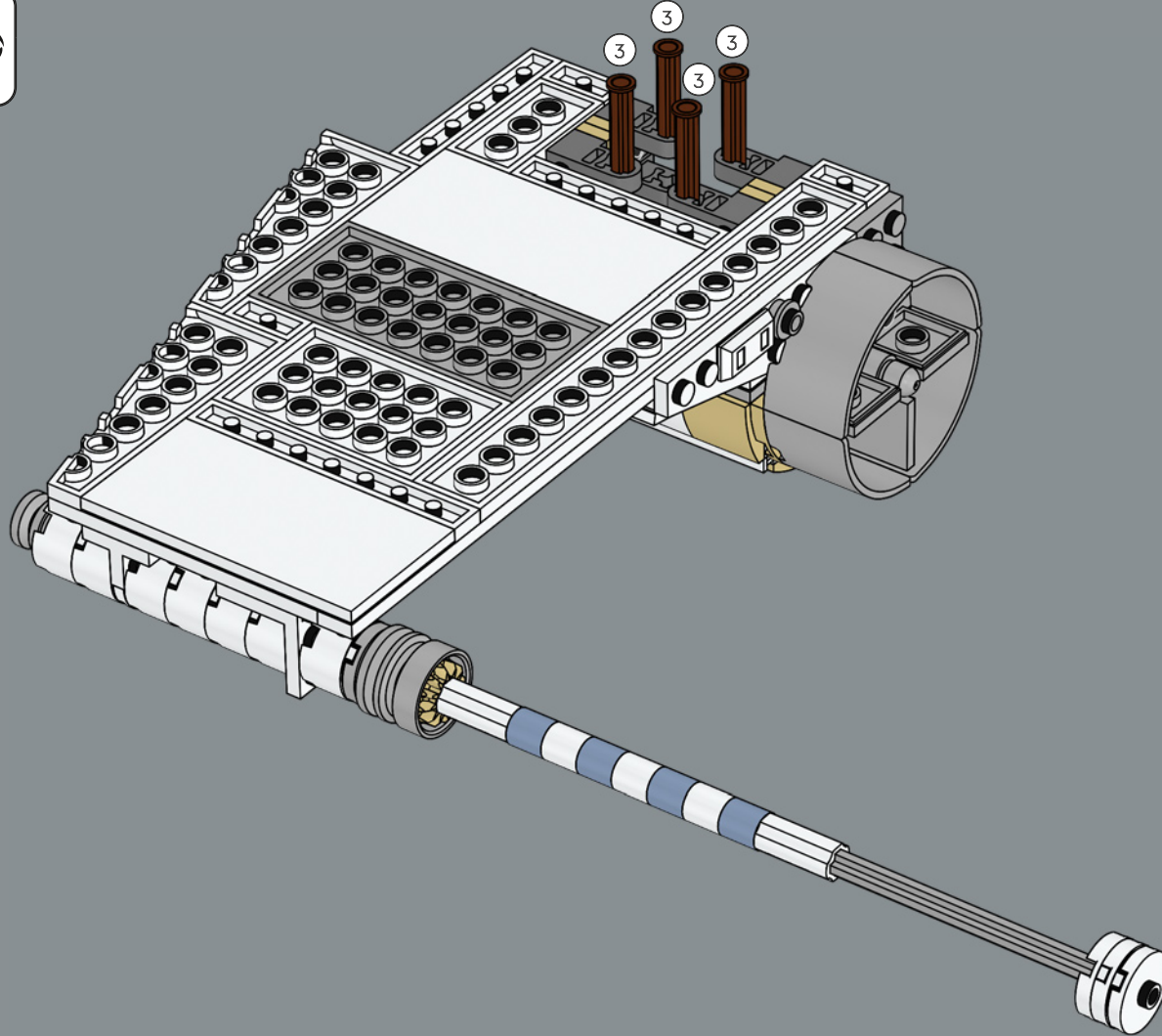

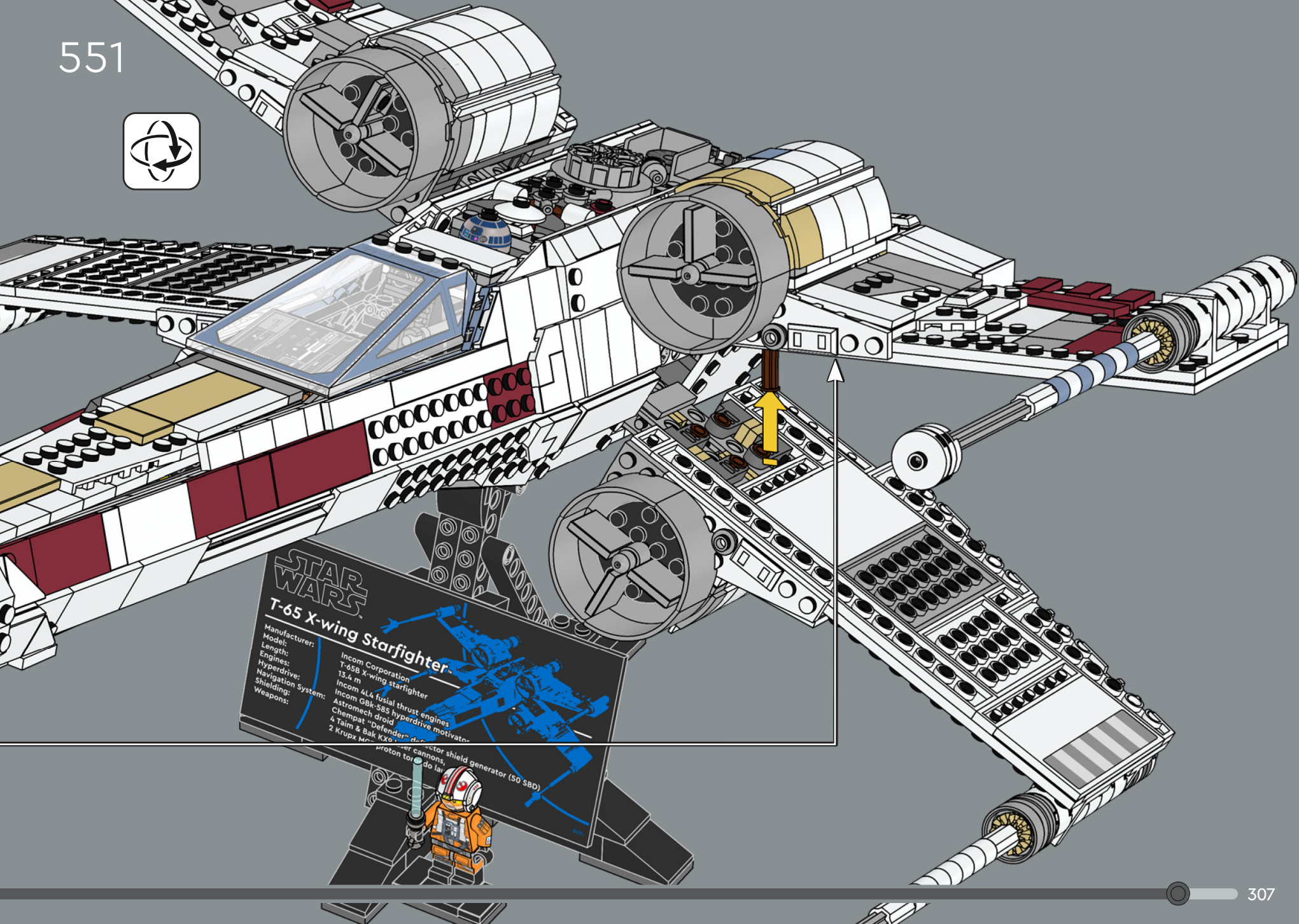

STAR WARS
T-65 X-wing Starfighter

Manufacturers:	Incom Corporation
Model:	T-65B X-wing starfighter
Length:	13.4 m
Engines:	Incom 4L4 fusial thrust engines
Hyperdrive:	Astromech droid
Navigation System:	Chempat "Defender" droid
Shielding:	4 Taim & Bak KXo
Weapons:	2 Krupx M... proton tor... detector shield generator (50 SBD)

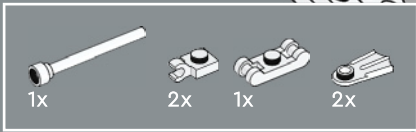

552

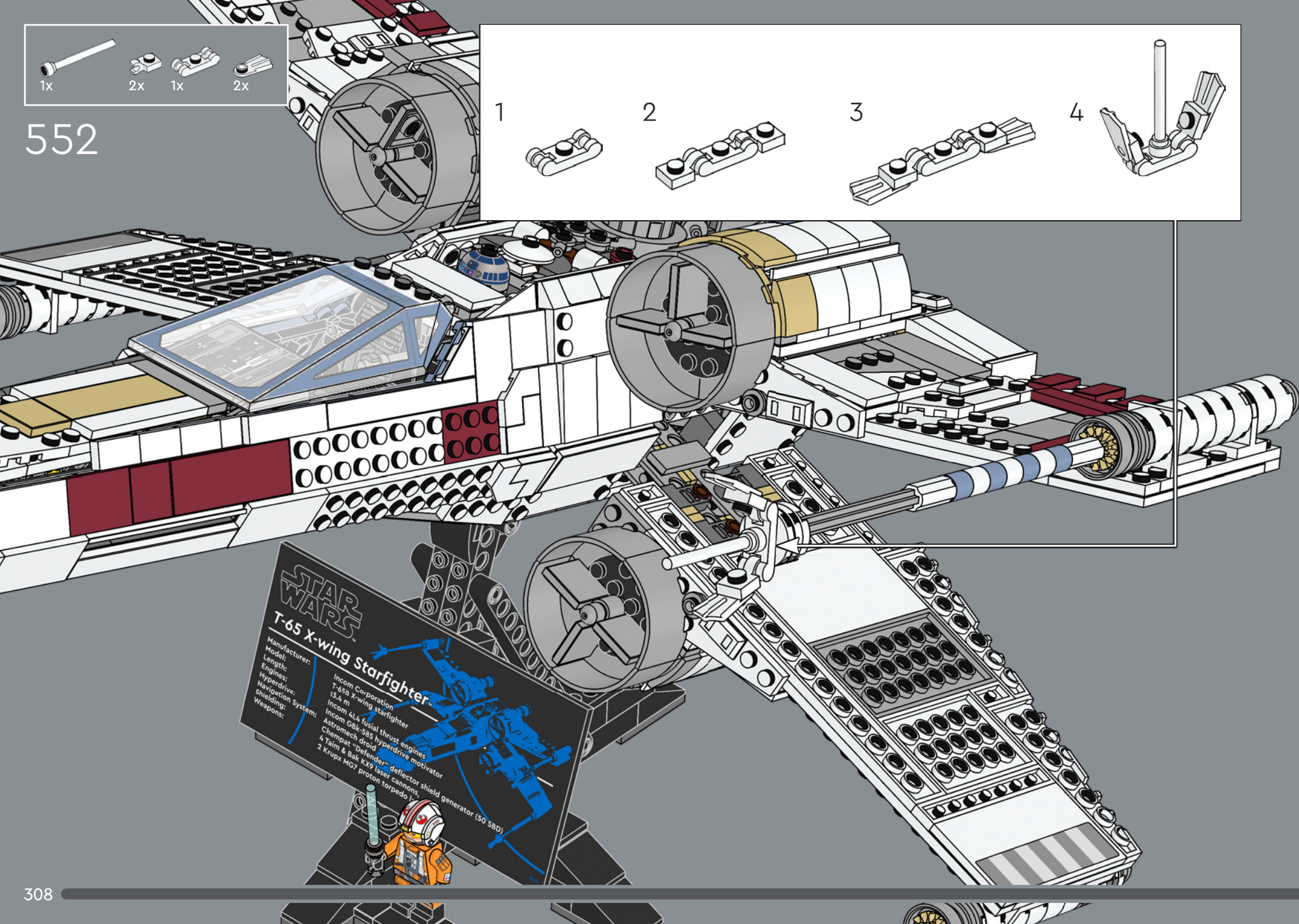
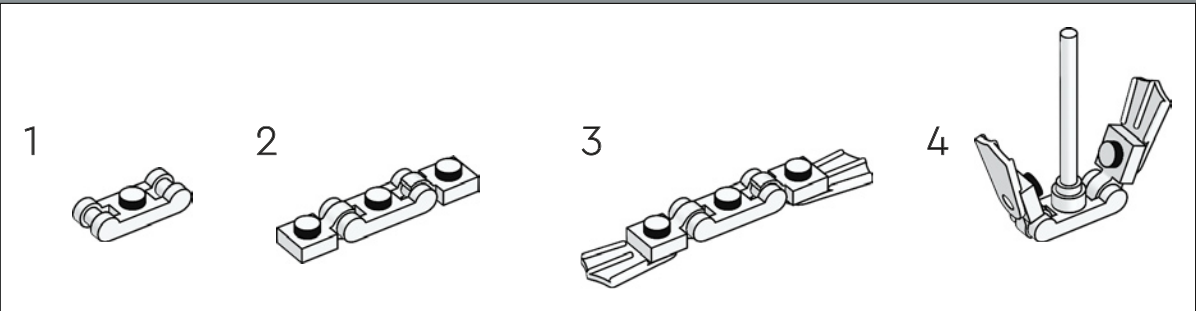

STAR WARS
T-65 X-wing Starfighter

Manufacturer: Incom Corporation
 Model: T-65 X-wing starfighter
 Length: 13.4 m
 Engines: Incom 4L4 radial thrust engines
 Hyperdrive: Astromech droid
 Navigation system: Chromatech droid
 Shielding: 4 Taim & Bak KK9 laser cannons
 Weapons: 2 Krupx MG7 proton torpedo launchers

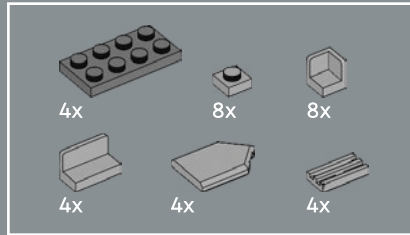
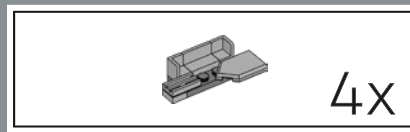

553

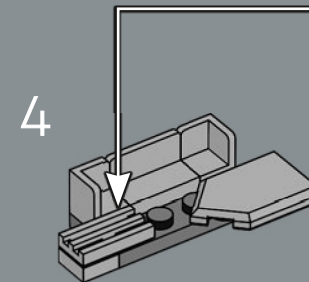
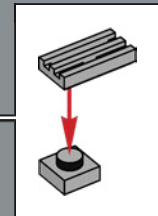
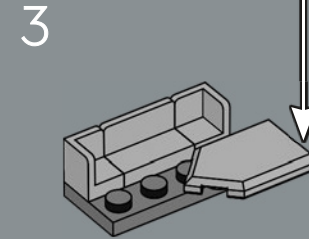
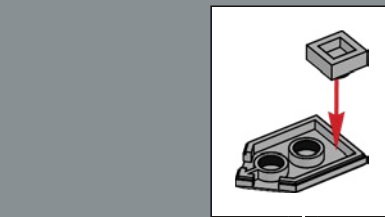
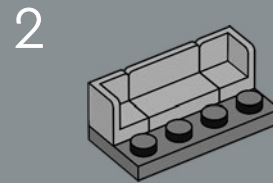
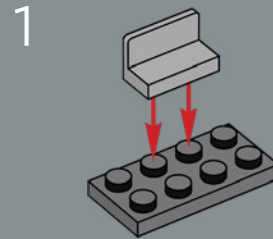

4x

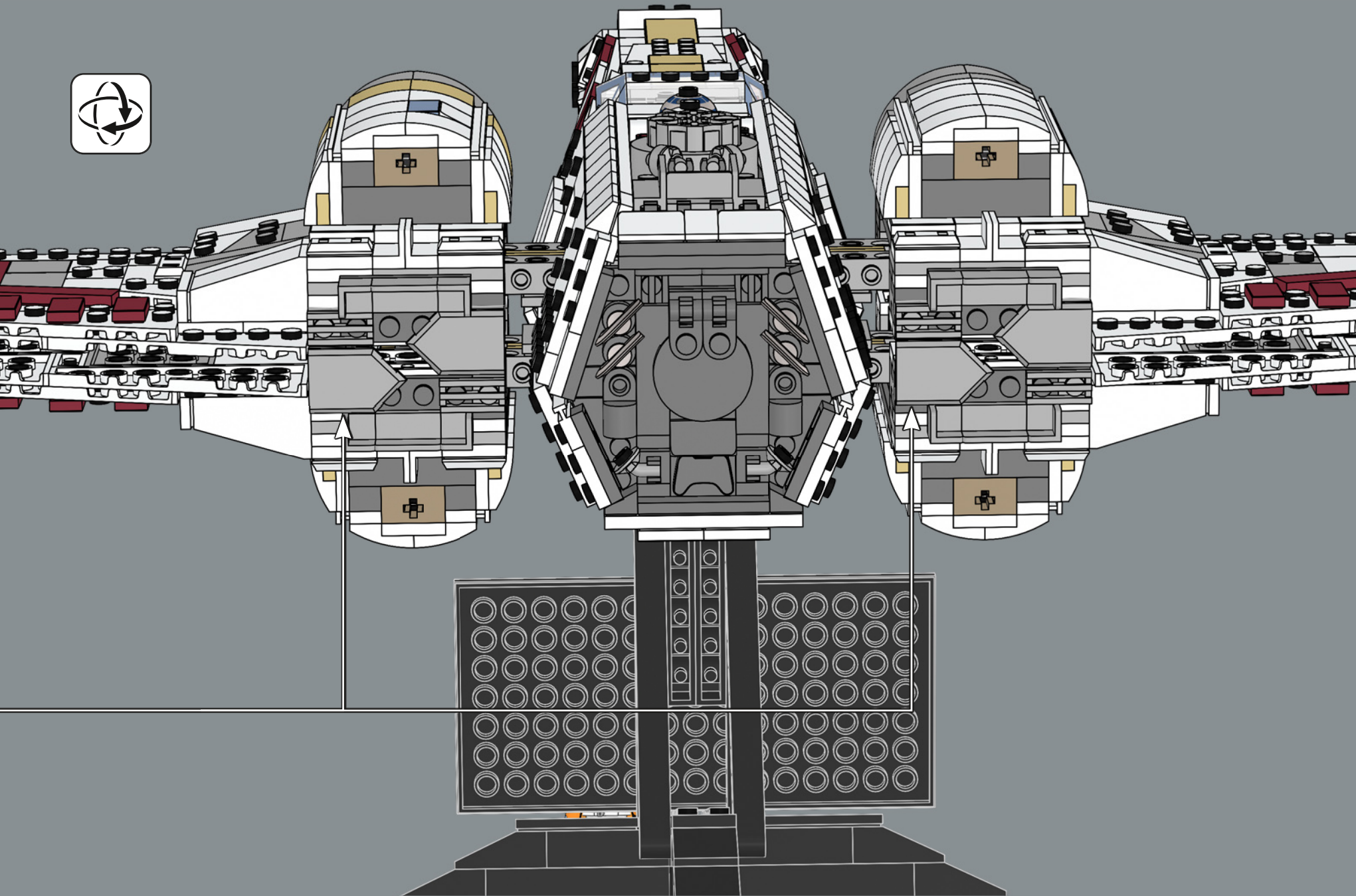

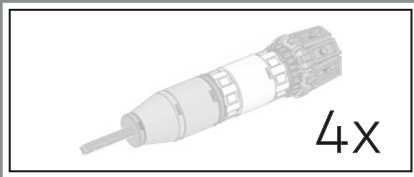

554

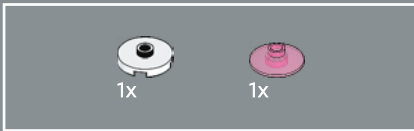
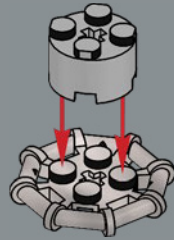

555

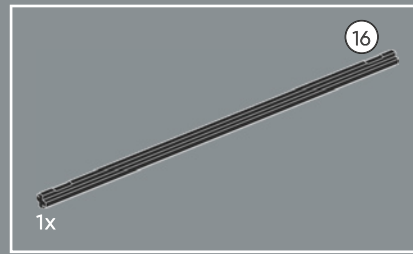
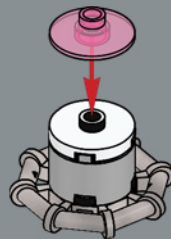

556

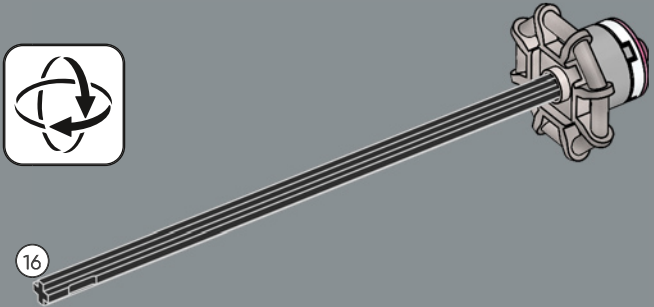

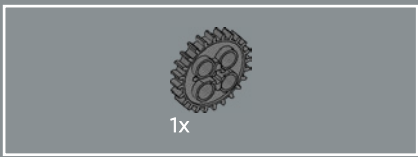

557

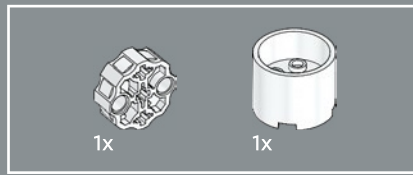
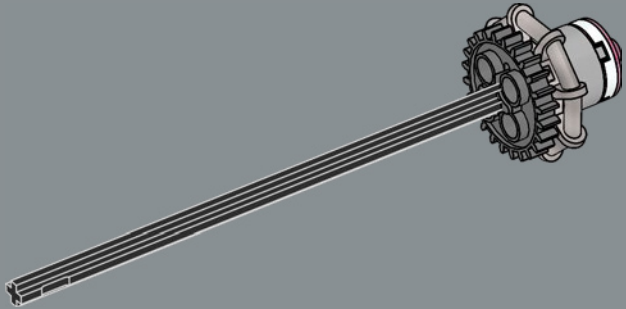

558

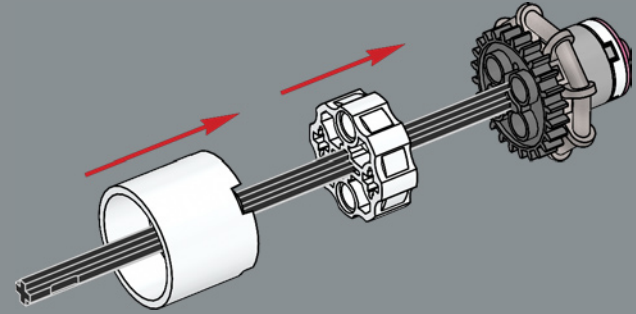

559

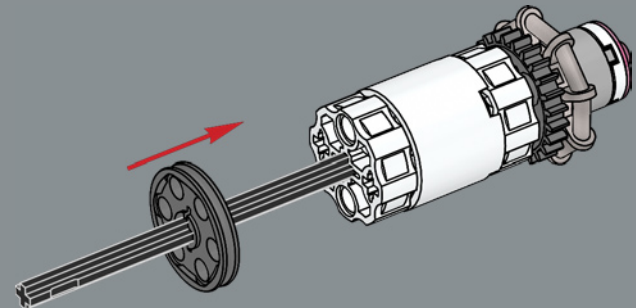

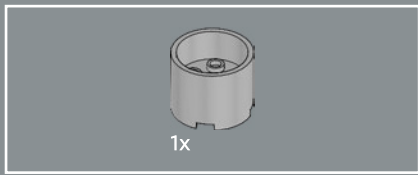

560

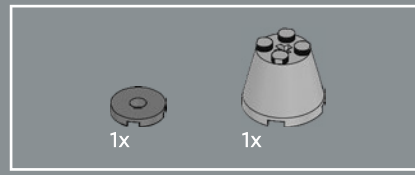
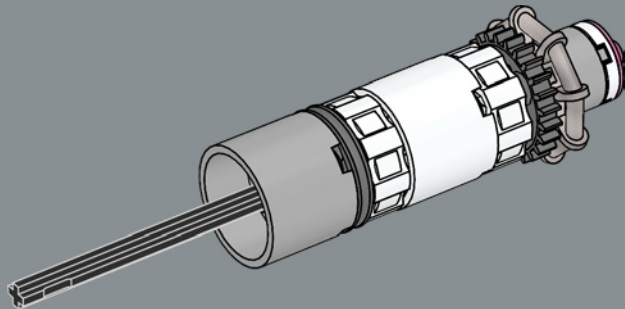

561

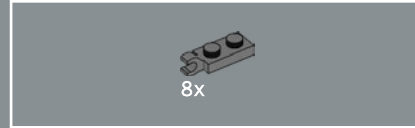
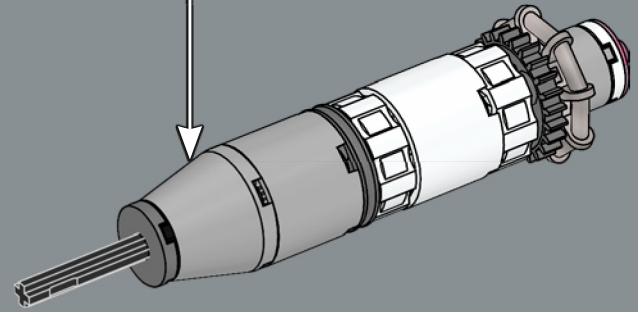
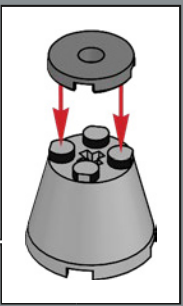

562

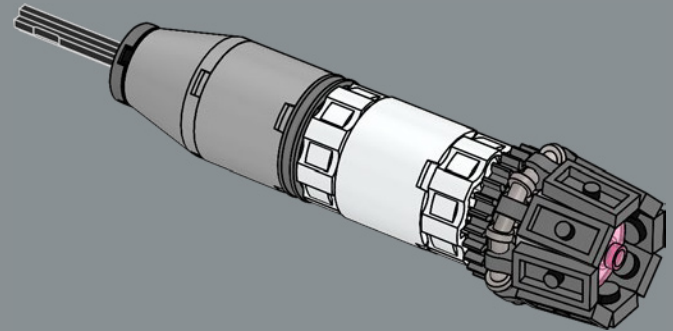

4x

563

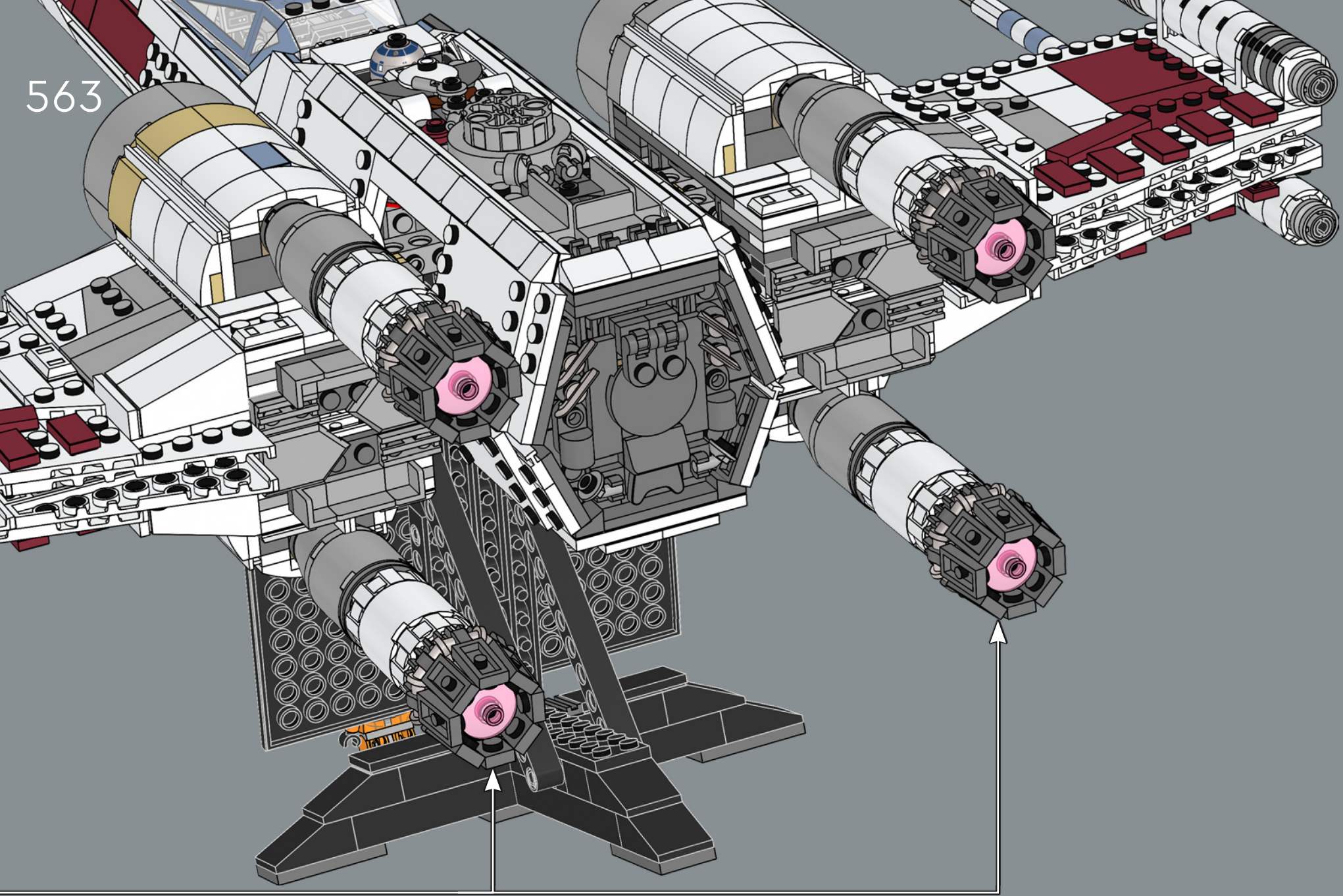

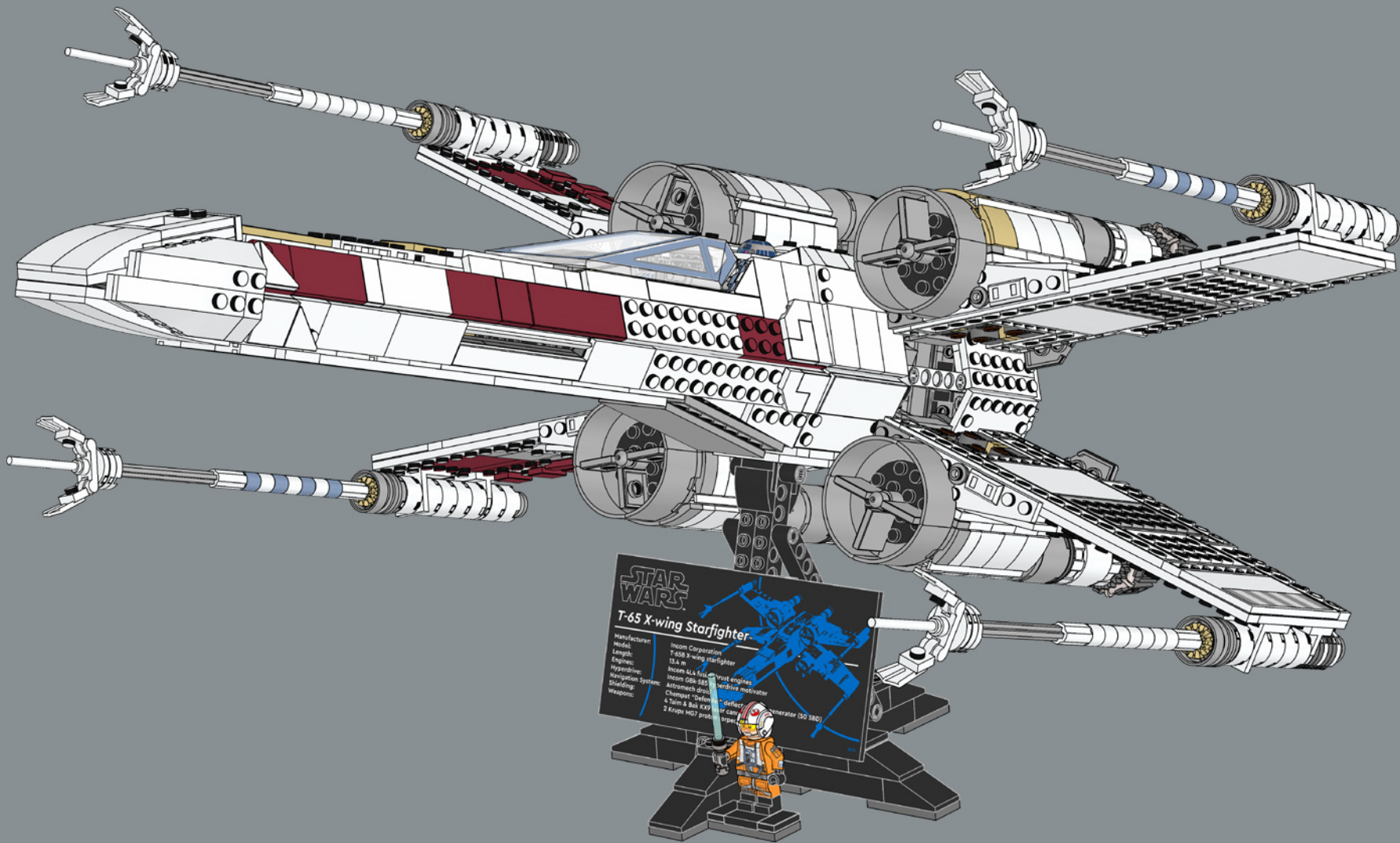

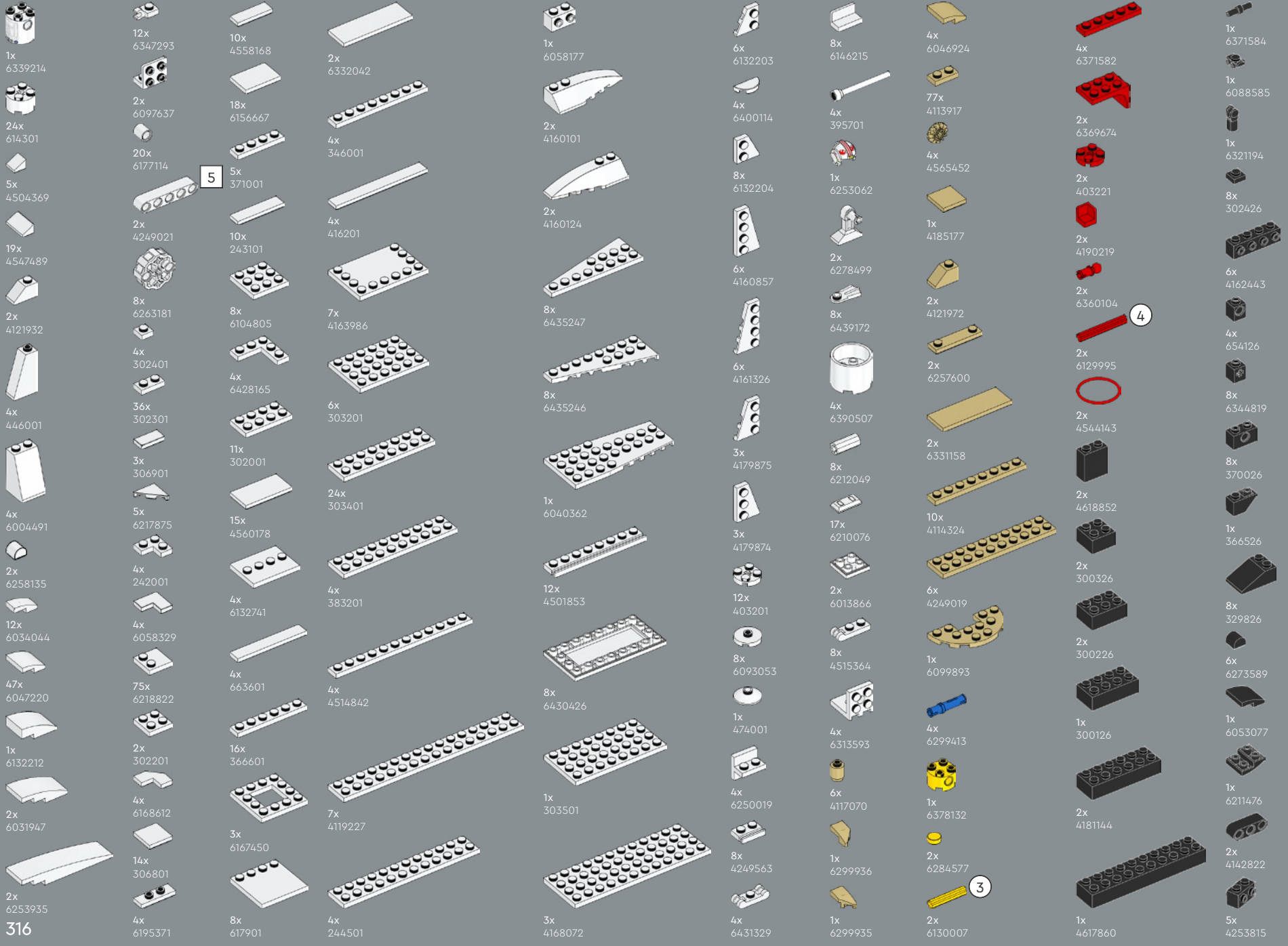



1x
370226



2x
273026



2x
4107558

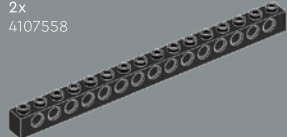

5x
370326

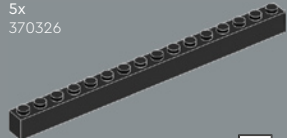

2x
246526



2x
4522933

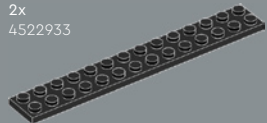

1x
6001494

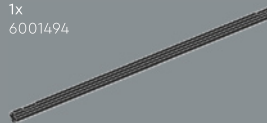

4x
6317564



1x
6446687

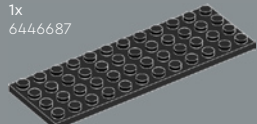

1x
302926



4x
6092585



2x
306926



1x
6192346



1x
6162892



5x
6174917



2x
6439175



1x
302026

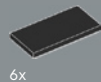

6x
4560182

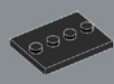

8x
6076678



3x
663626



12x
366626



7x
379526

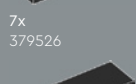

1x
6318582

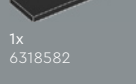

2x
447726



1x
6299338



2x
6121485



2x
4144024



3x
6310268



15x
4124096



1x
6258904



1x
4517986



5x
4515350



2x
303226



1x
303426



1x
395826



2x
6276993



2x
6276993



2x
6344752



72x
6279875



4x
6089119



2x
6321745



1x
370626



16x
6052126



4x
4515368



1x
4180508



1x
4180536



4x
4278359



2x
6167800



1x
6170187



2x
6276993



2x
6276993



14x
4211257



2x
6428178



16x
6135494



4x
6245302



1x
6447834



1x
6443847



1x
6240515



8x
6257131



1x
6142505



2x
6198156



2x
6111685



2x
6248957



2x
6439270



4x
6310833



5x
4616711



5x
6168645



20x
4539090



2x
6214309



2x
4539105



2x
6359681



8x
4539060



2x
6186003



4x
6173167



2x
6335319



1x
4618986



2x
6008593



2x
6008593



4x
6168647



13x
6015344



8x
6123809



4x
4211412



8x
4211526



2x
4211385



20x
6326478



1x
4211441



10x
4211466



4x
4211640



3x
6132983



1x
6276045



1x
6186129



12x
6028813



2x
6102357



8x
4211399



4x
4211350



2x
6163478



4x
6212077



16x
4211413



2x
6412816



8x
4558169



8x
4211429



27x
4211396



2x
6171894



6x
4211356



6x
4560183



2x
6258831



3x
6227897



4x
6296894



1x
6313114



3x
4244627



1x
4211464



1x
4211732



1x
4211735



2x
4211794



2x
4211791



4x
6179186



2x
6186657



12x
6163990



2x
6360043

11

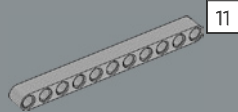

2x
4611705

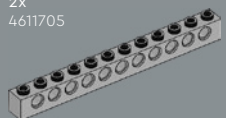

4x
4211860

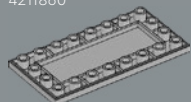

1x
6435281



1x
4211408

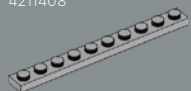

12x
4251149

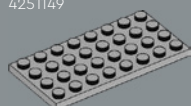

4x
4211407

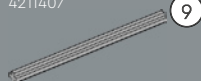

12x
4535768



LEGO.com/service



5x
6146223



2x
6210581



1x
6170418



4x
6212288



4x
6326748



4x
4490127



5x
4211452



2x
4211404



1x
6303438



4x
4211758



16x
6435248



2x
4211470



2x
6134378



4x
6410336



4x
6326483



4x
6092111



4x
6245254



4x
6240463



1x
6102999



16x
6324639



1x
4211063



2x
4504378



1x
4567887



4x
4211054



2x
6333129



8x
6215212



2x
6302690



5x
6344820



8x
6388133



12x
4210631



8x
6092572



18x
4211088



6x
4211103



2x
4210635



2x
6126083



4x
4211133



25x
4211001



3x
4211053



36x
4211065



2x
6413109



1x
4210651



2x
4211002



1x
4211008



4x
6271752



11x
6344022



2x
6388119



2x
6344754



2x
6308045



36x
6336990



2x
6123814



2x
6306725



2x
6143423



1x
4211052



4x
6133119



9x
4260707



6x
6133611



1x
4210963



2x
6262025



20x
4211094



6x
6309059



1x
6164073



2x
6265306



1x
6433729



1x
6439170



4x
6321744



9x
6395635



1x
6083620



17x
4211066



1x
6433807



3x
4210796



4x
4625036



1x
6051389



1x
6051389



1x
6051389



1x
6051389



3x
6221607



2x
6143417



9x
4211042



4x
6055313



1x
6117346



1x
6253114



2x
6424277



1x
6290309



4x
6020990



4x
6088641



2x
6167922



4x
4625036



1x
6051389



1x
6051389



1x
6051389



1x
6051389



1x
6051389



1x
6051389

4

9



YOU COULD WIN



YOU COULD WIN

Your feedback will help shape the future development of this product series.

Visit:

DU KÖNNTEST GEWINNEN

Dein Feedback trägt zur Weiterentwicklung dieser Produktreihe bei.

Geh auf:

VOUS POURRIEZ GAGNER

Vos commentaires nous aideront à concevoir les futurs produits de cette gamme.

Visitez :

POTRESTI VINCERE TU

La tua opinione ci aiuterà a migliorare la creazione futura di questa linea di prodotti.

Visita:

PUEDES GANAR

Tu opinión contribuirá al futuro de esta serie de productos.

Visita:

轻松获奖

您的反馈将有助于我们在今后改进本产品系列。

请访问:

[LEGO.com/productfeedback](https://www.lego.com/productfeedback)

You also have the chance to win a LEGO® set.

Terms and conditions apply.*

Außerdem hast du die Chance, ein LEGO® Set zu gewinnen.

Es gelten die Teilnahmebedingungen.*

Vous pourriez également gagner un ensemble LEGO®.

Des conditions s'appliquent.*

Hai anche la possibilità di vincere un set LEGO®.

Termini e condizioni sono applicabili.*

También tienes la oportunidad de ganar un set LEGO®.

Aplican términos y condiciones.*

您还有机会赢取乐高®套装。

条款和条件适用。*

*[LEGO.com/productfeedback-terms](https://www.lego.com/productfeedback-terms)

**STAR
WARS**™

