



GAMES

30630



3
IN
1
EN

3 in 1
3 en 1
3 em 1
3 az 1-ben

Trīs vienā
3 în 1
3 合 1



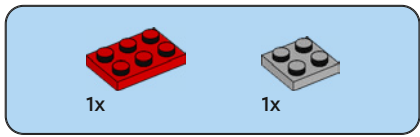

1

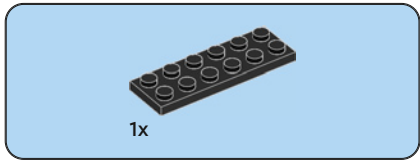
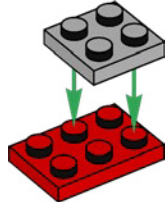

2

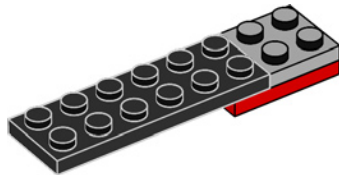

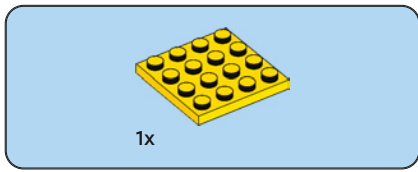

3

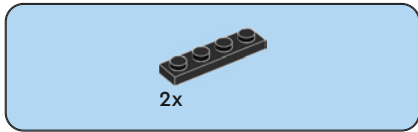
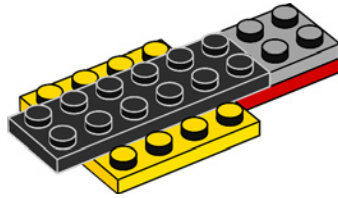

4

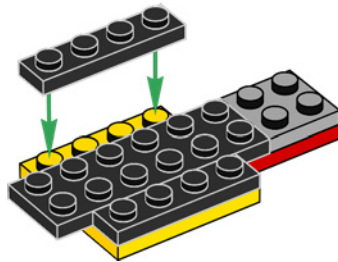

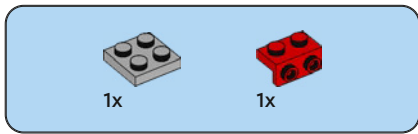

5

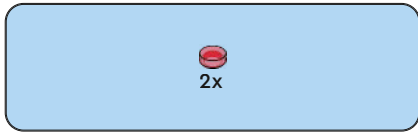
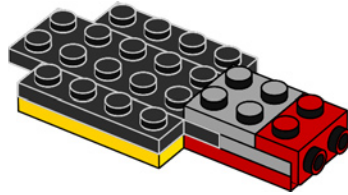

6

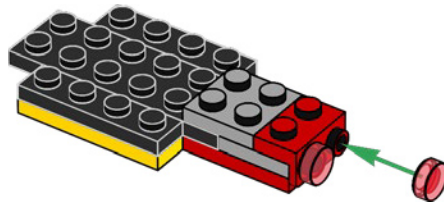

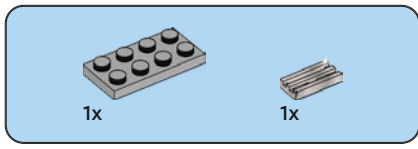

7

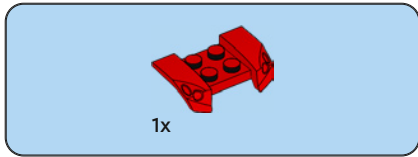
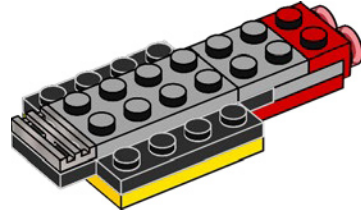

8

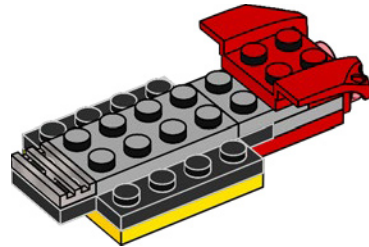

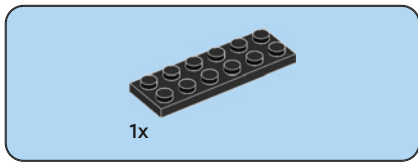

9

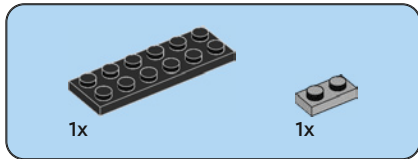
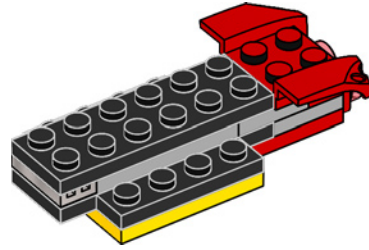

10

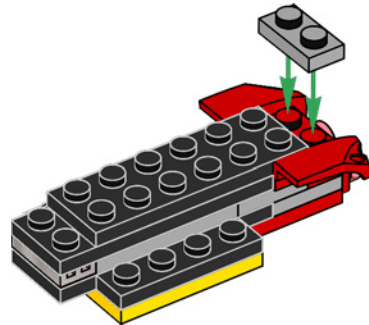

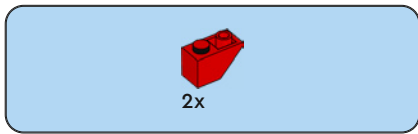

11

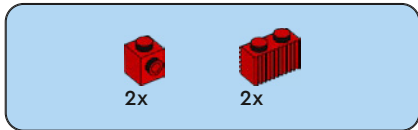
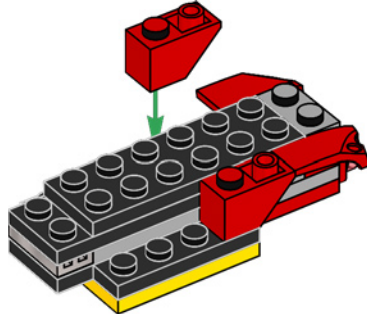

12

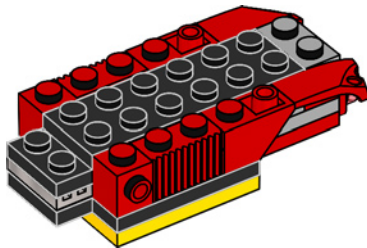

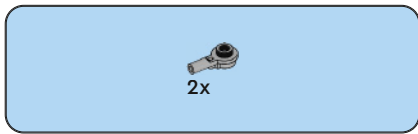

13

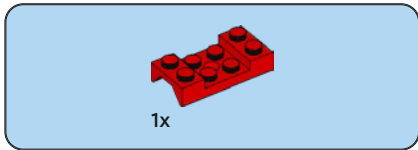
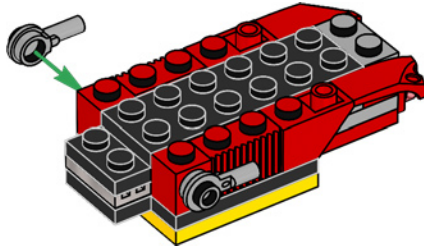

14

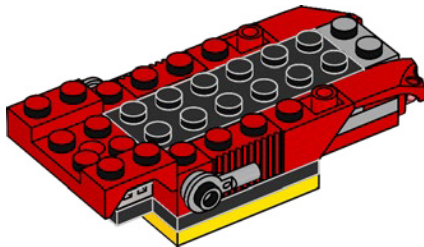

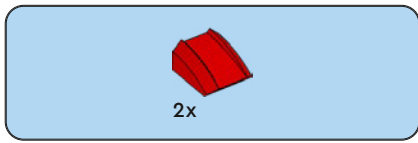

15

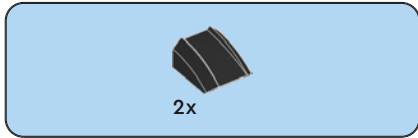
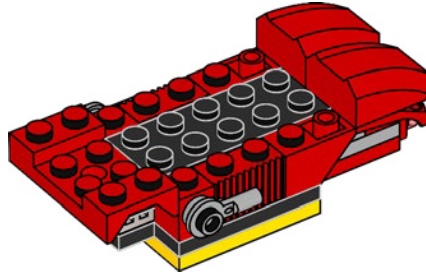

16

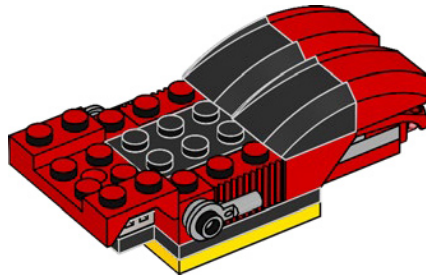

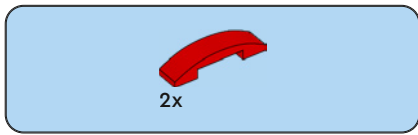

17

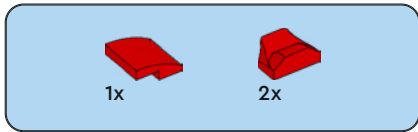
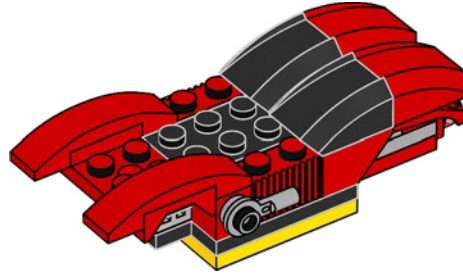

18

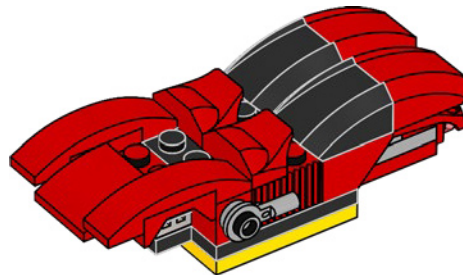

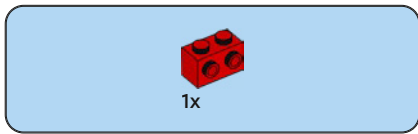

19

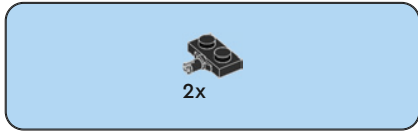
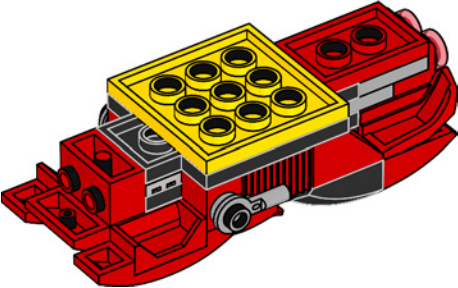

20

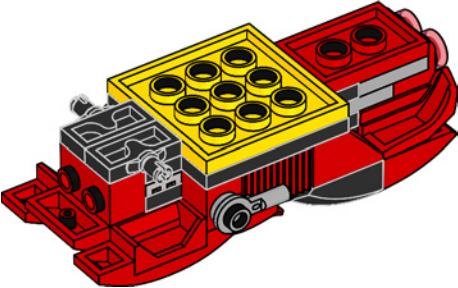

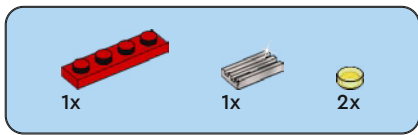

21

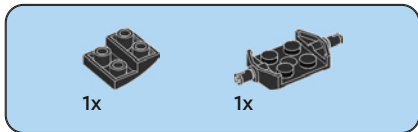
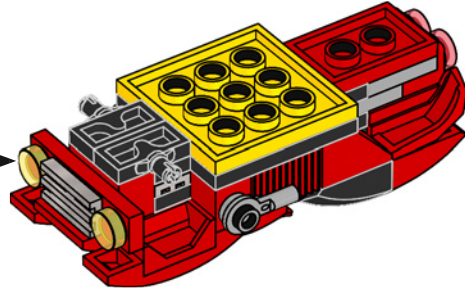
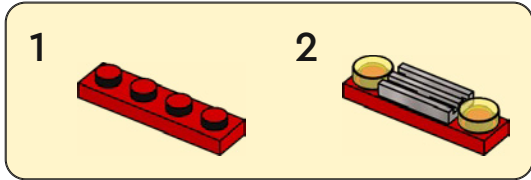

22

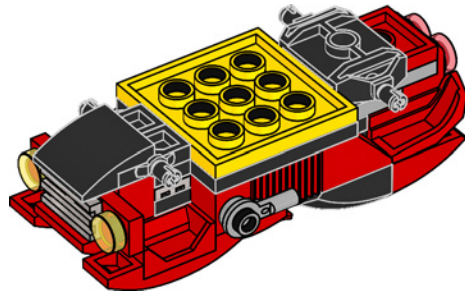

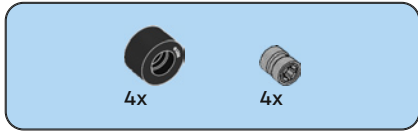

23

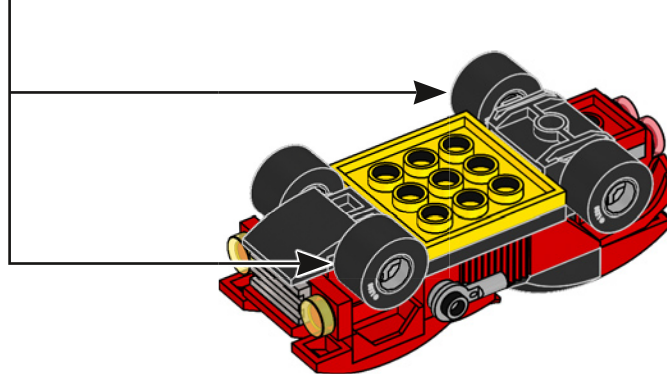
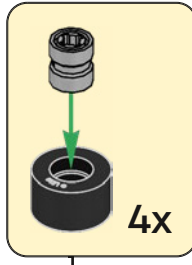

24

