



CITY

60397



1

2



LEGO.com/sustainable-packaging



BUILDER



Apple and the Apple logo are trademarks of Apple Inc., registered in the U.S. and other countries and regions. App Store is a service mark of Apple Inc. Google Play and the Google Play logo are trademarks of Google LLC. Tencent and the Tencent logo are trademarks of Tencent Inc.

Q [LEGO.com/devicecheck](https://www.lego.com/devicecheck)

EN Ask parents' permission before going online | **DE** Eltern um Erlaubnis bitten, bevor du online gehst | **FR** Demande l'autorisation d'un parent avant d'aller en ligne | **IT** Chiedi il permesso ai tuoi genitori prima di andare online | **ES** Pídeles permiso a tus papás antes de conectarte a Internet | **PT** Pede autorização aos pais antes de acederes online | **ZH** 上网前应先征得父母的同意 | **PL** Poproś rodziców o zgodę, zanim wejdiesz do Internetu | **CS** Než půjdeš na internet, požádej rodiče o svolení | **SK** Skôr než pôjdeš na internet, vypýtaj si povolenie od rodičov | **HU** Kérj szülői engedélyt, mielőtt online csatlakoznál! | **RO** Cere permisiunea părinților înainte de a te conecta online | **BG** Поискайте разрешение от родител, преди да влезете онлайн | **LV** Pirms došanās tiešsaistē palūdz atļauju vecākiem | **ET** Enne Interneti kasutamist küsi vanematelt luba | **LT** Prieš prisijungdami prie interneto, atsilaukite tėvų

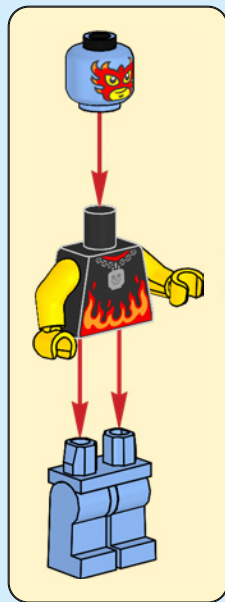

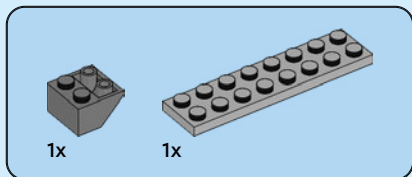

1

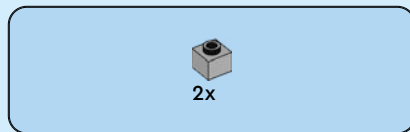
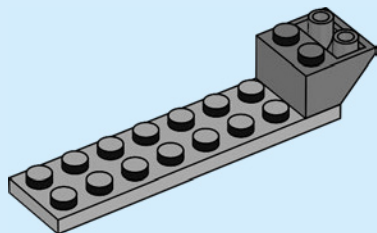

2

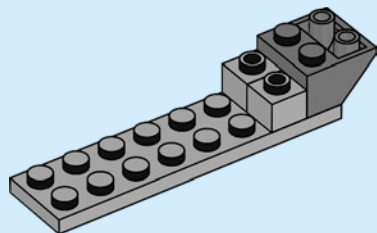



2x



1x

3

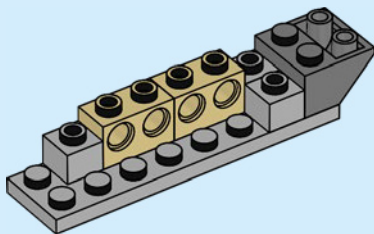



2x



1x

4

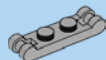
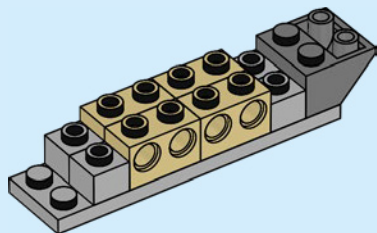

2x

5

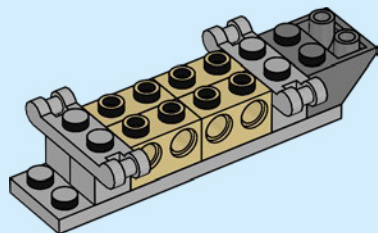



1x

6

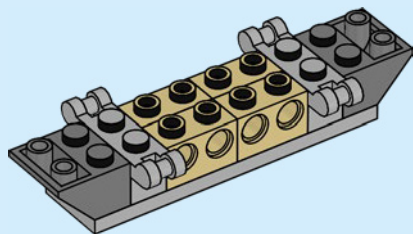

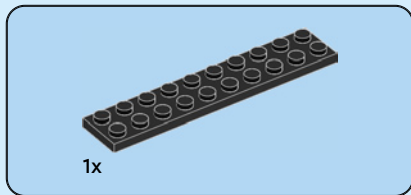

7

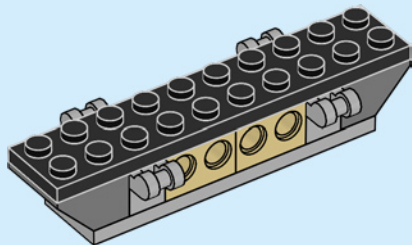

8

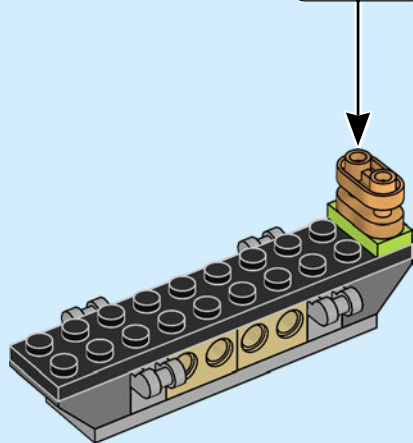
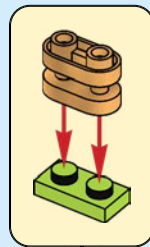

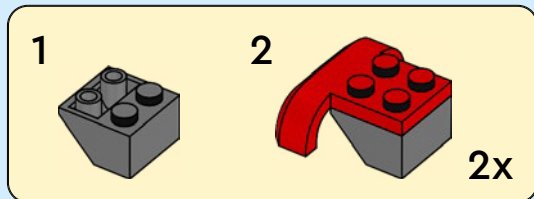
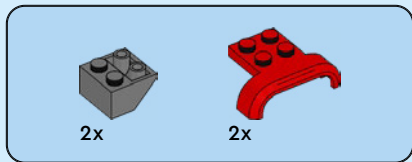

9

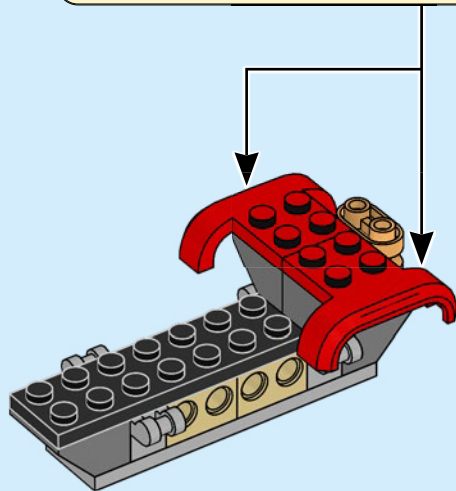

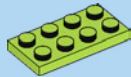

1x

10

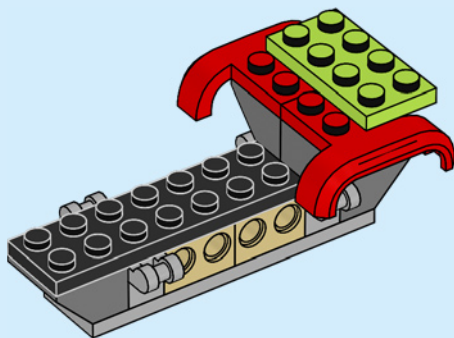

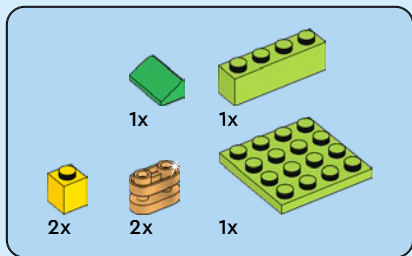

11

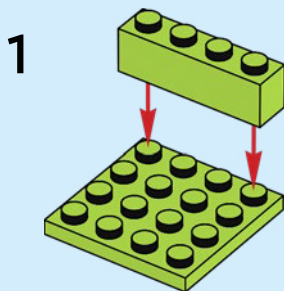

2

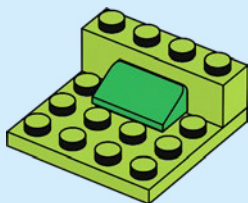

3

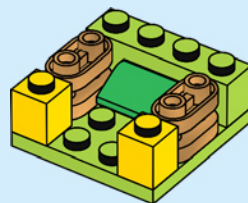

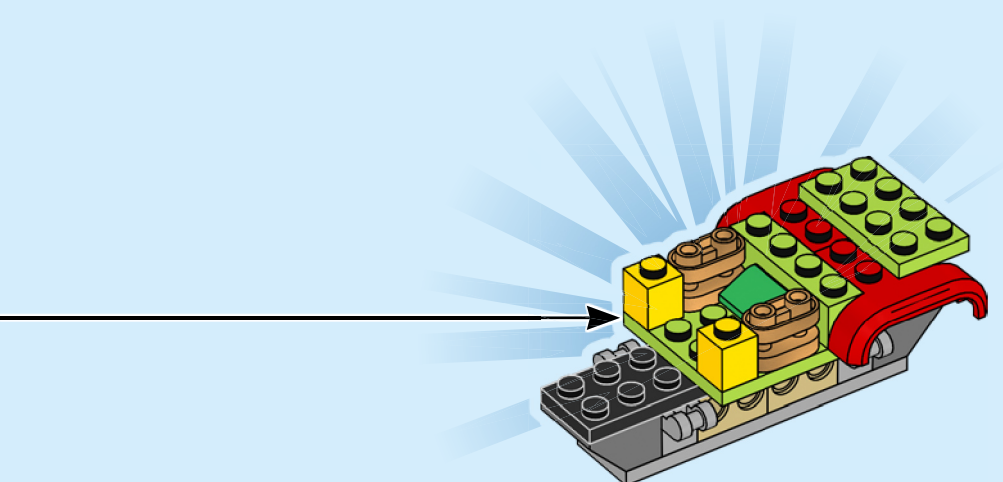

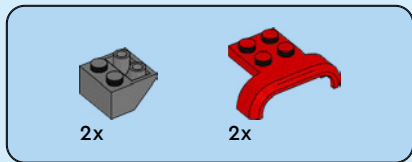

12

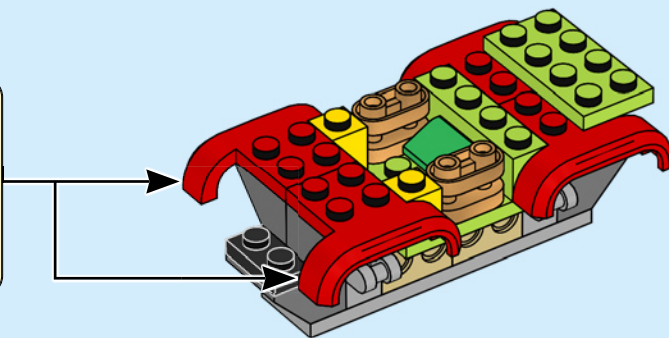
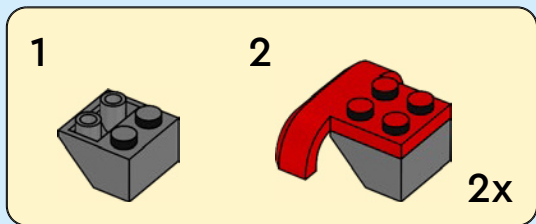

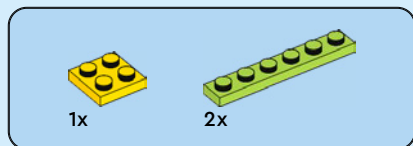

13

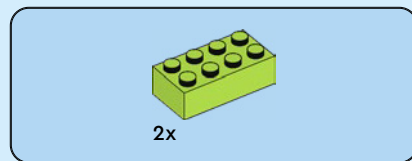
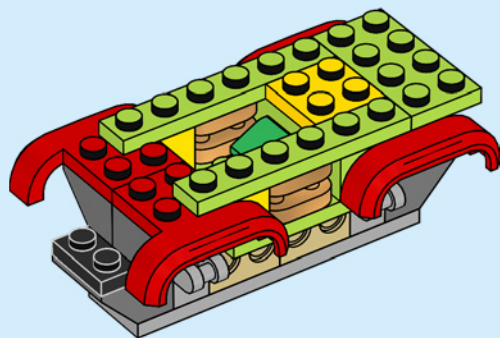

14

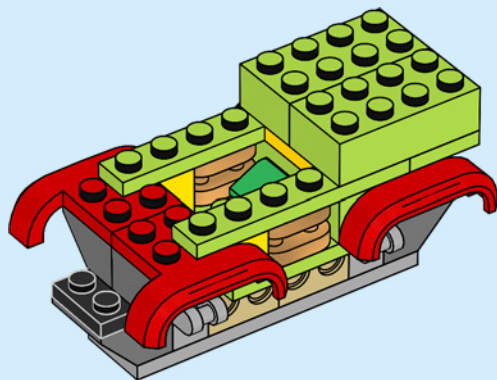

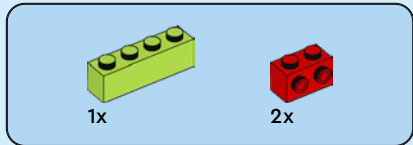

15

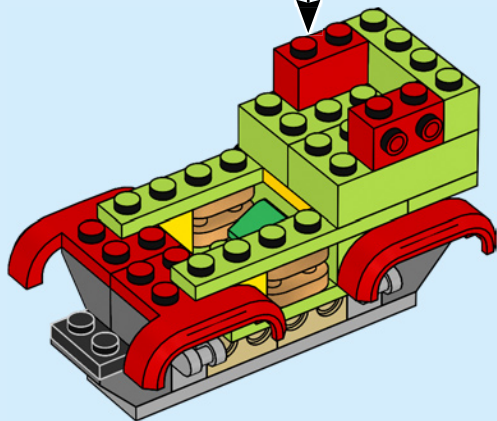
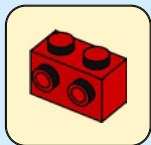

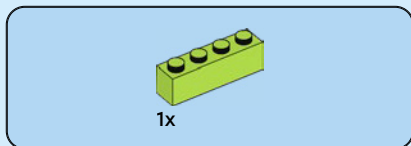

16

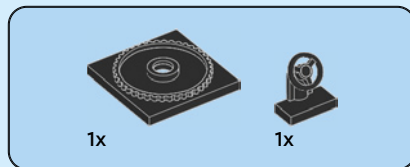
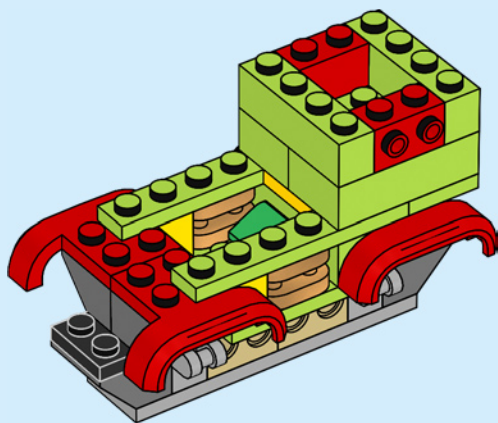

17

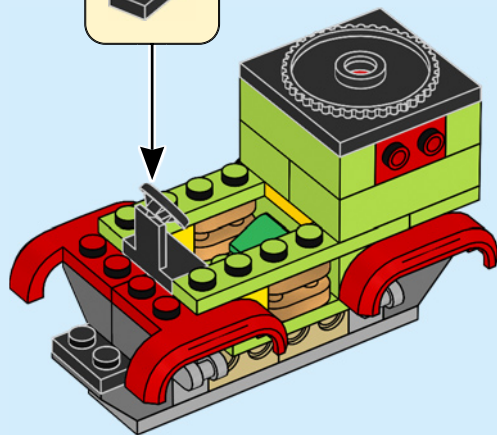



1x



1x

18

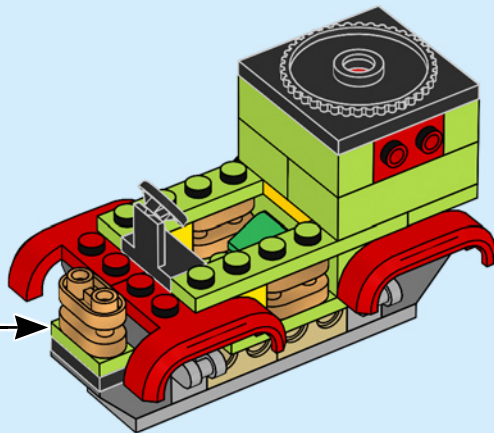
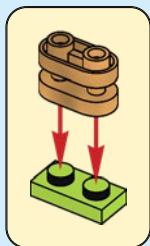

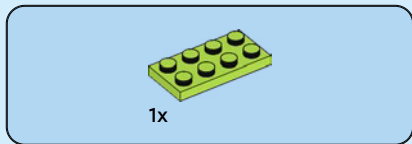

19

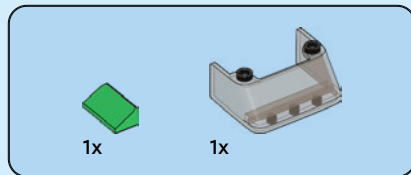
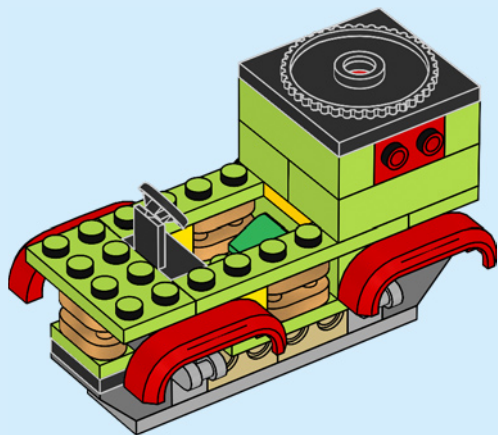

20

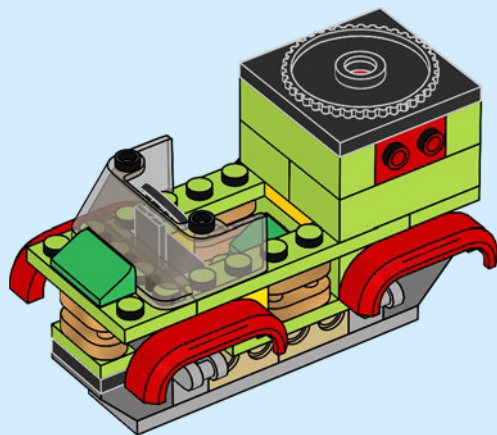

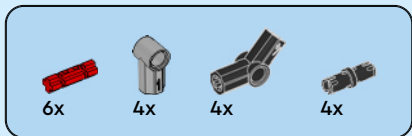
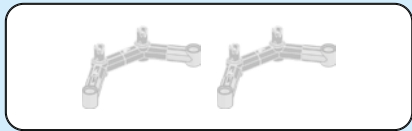

21

1

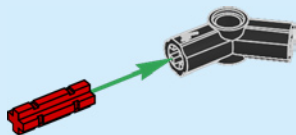

2

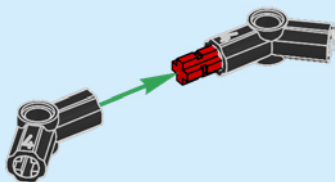

3

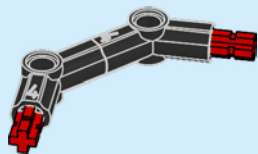

4

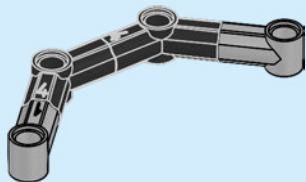

5

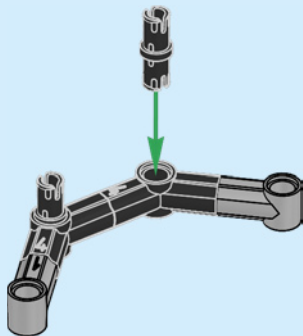

2x

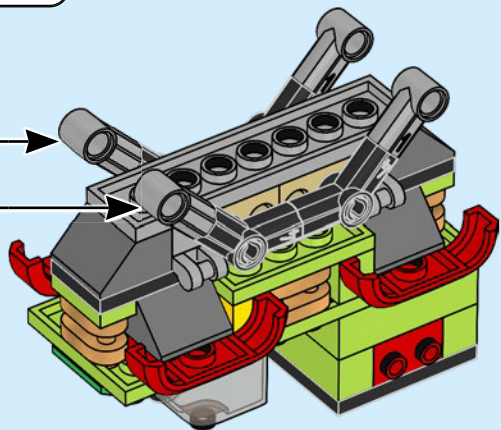
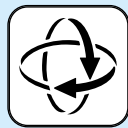

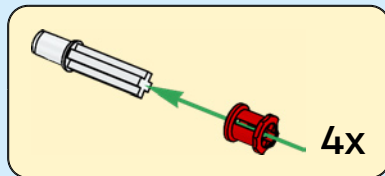
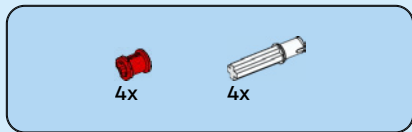

22

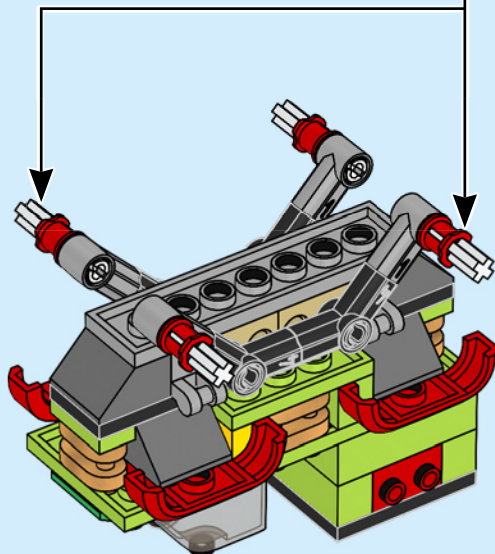



2x

23

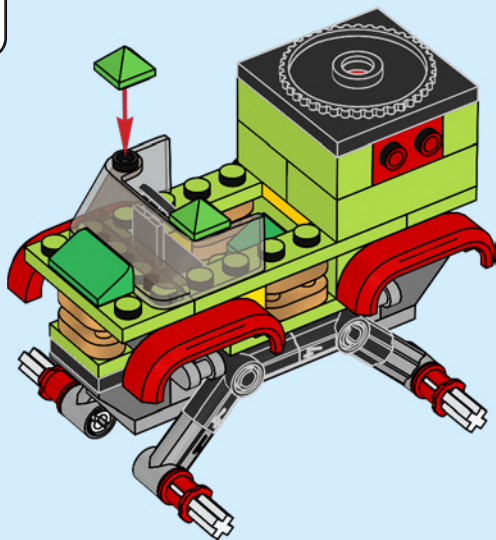
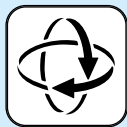

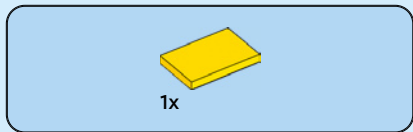

24

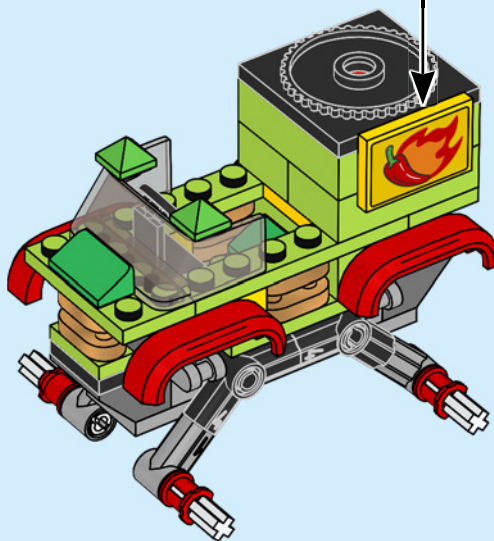
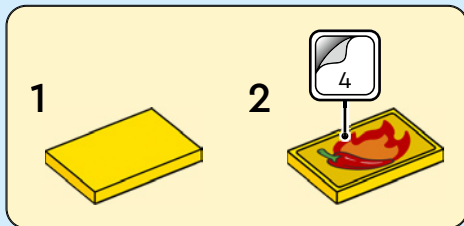

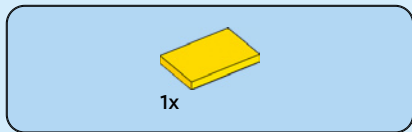

25

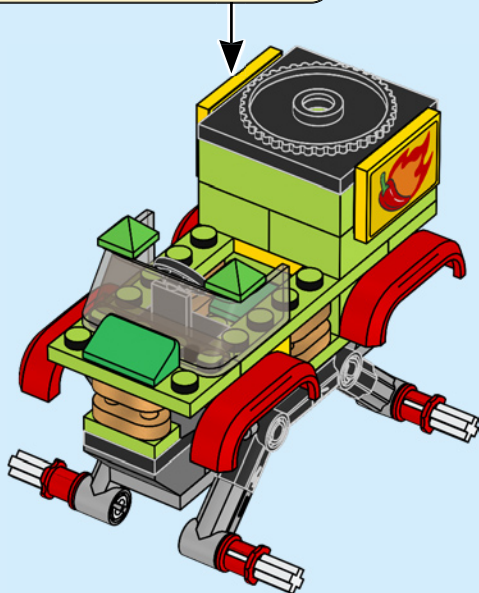
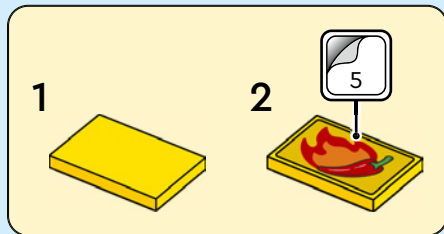

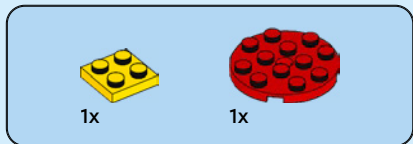
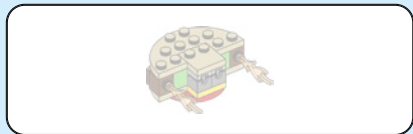

26

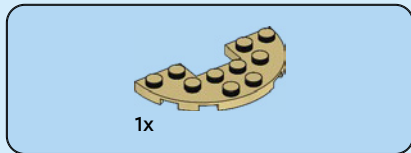
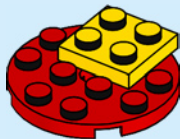

27



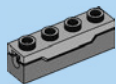

2x

28

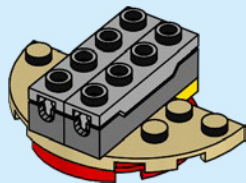

2x

29

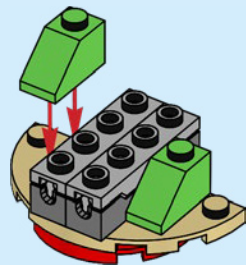

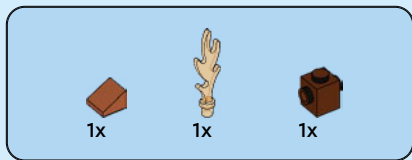

30

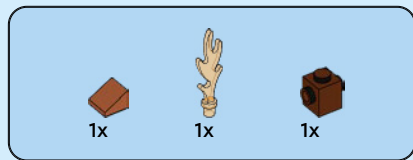
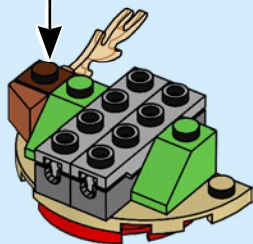
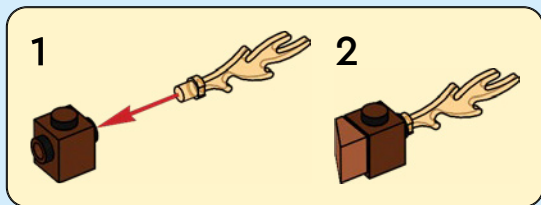

31

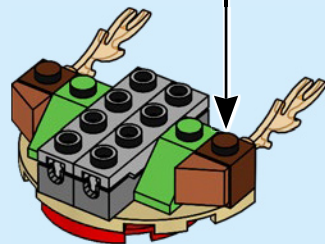
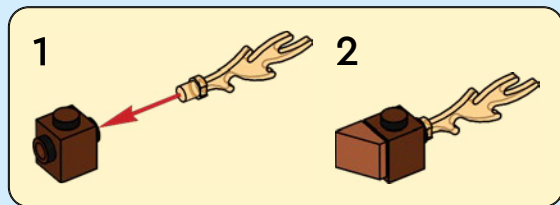

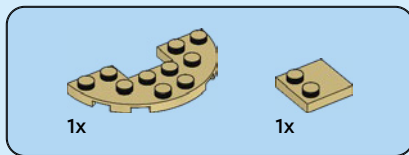

32

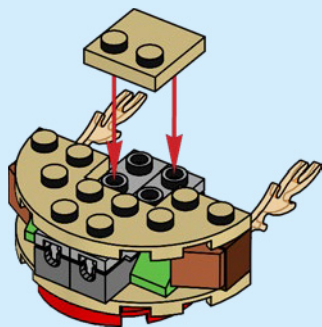

33

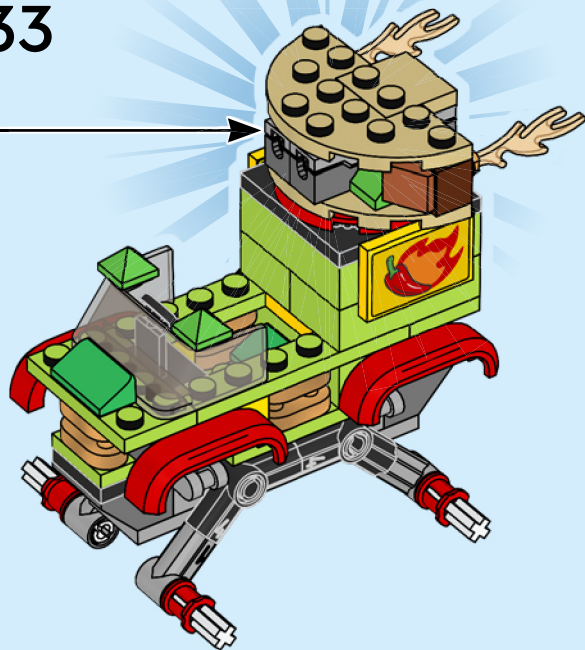

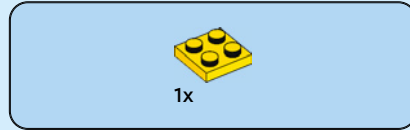
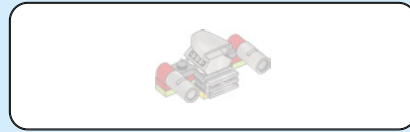

34



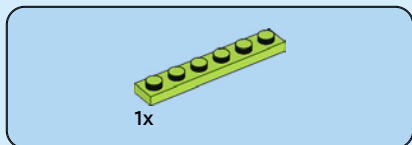

35

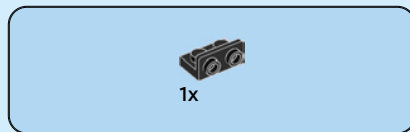
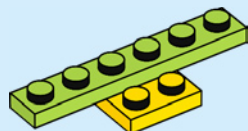

36

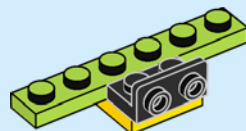



2x

37

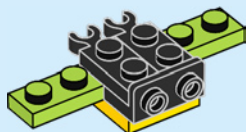

1x

38

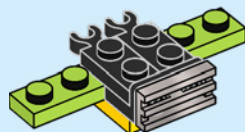



2x

39

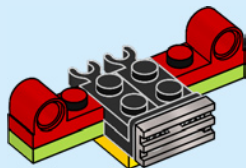

2x

40

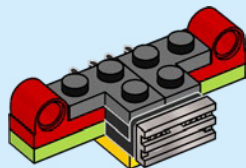



2x

41

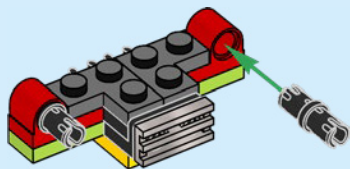



2x

42

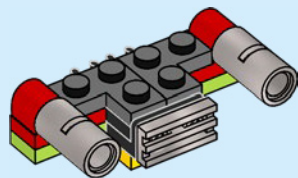

1x

43

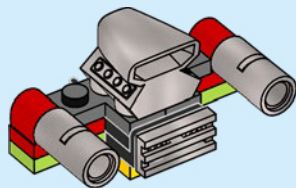

44

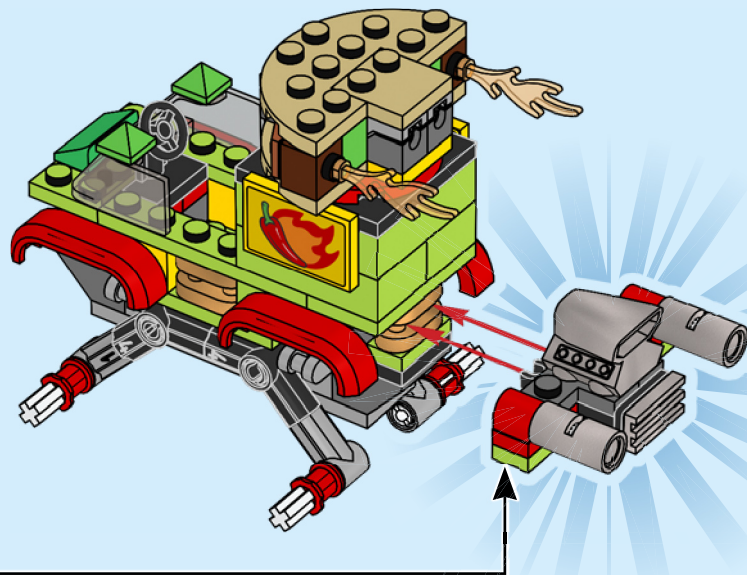

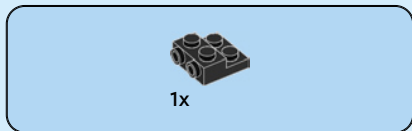

1x

45

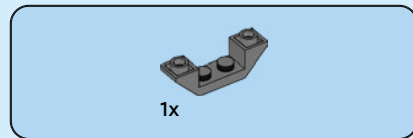
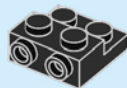

1x

46

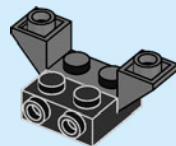



2x

47

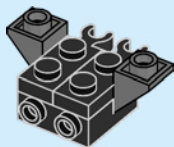

1x



1x

48





1x



1x

49

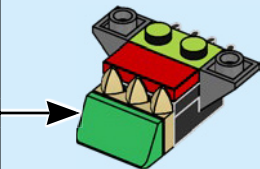
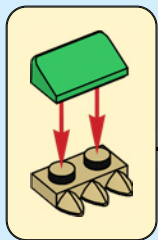

2x

50

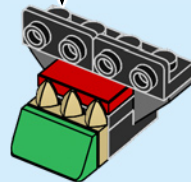
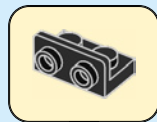



1x

51

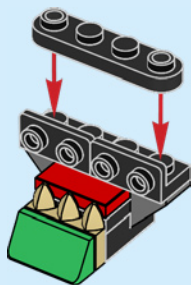



2x



1x

52

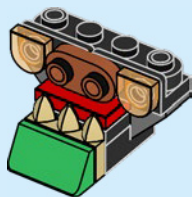

1x



2x

53

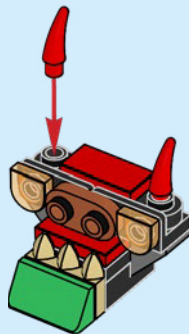

54

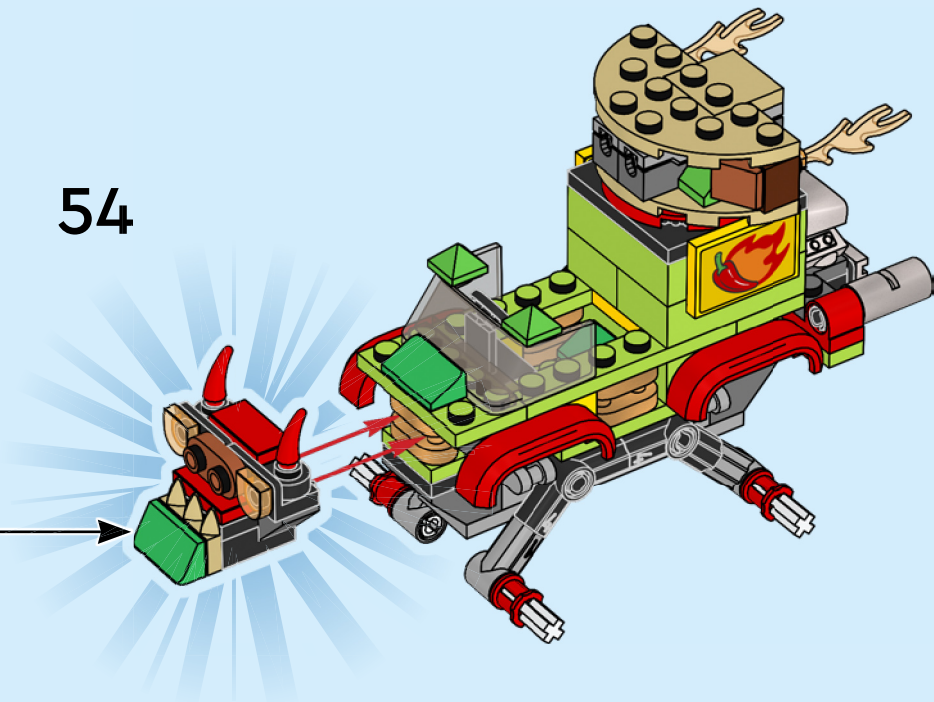

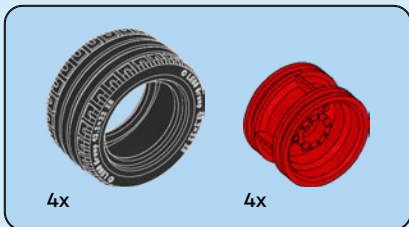

55

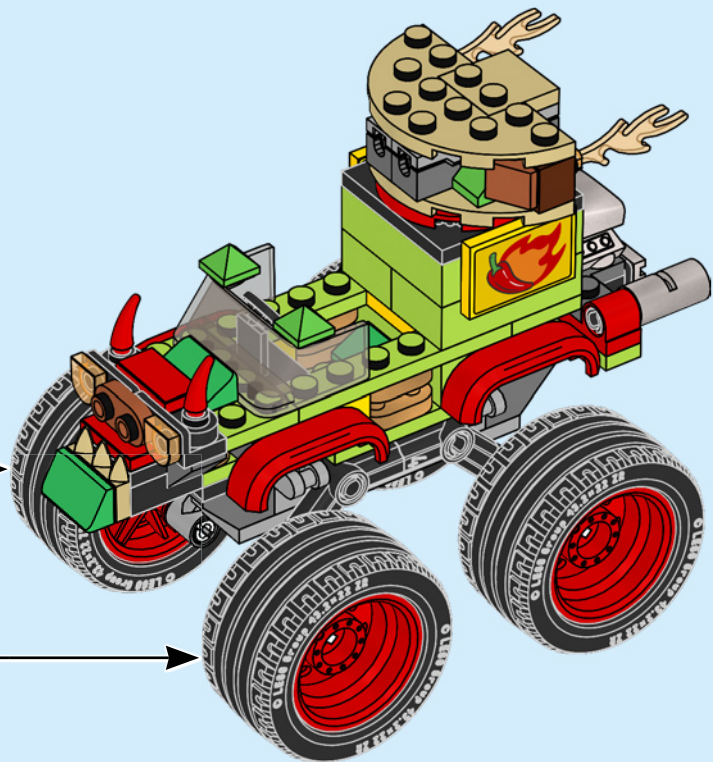
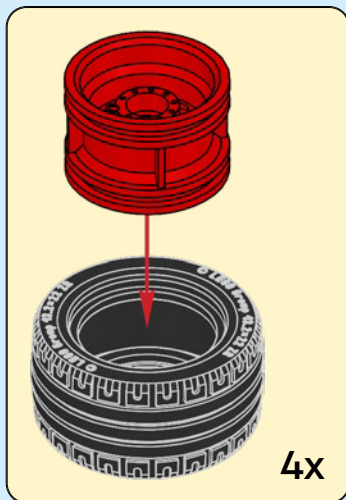



1x

56

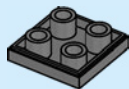

2x

57

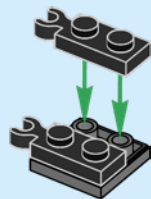



2x

58

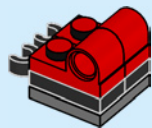

1x

59

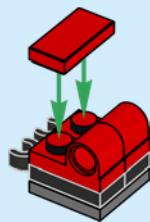



1x

60

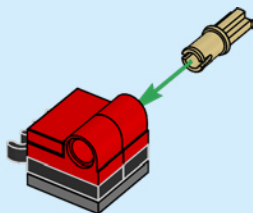

1x



1x

61

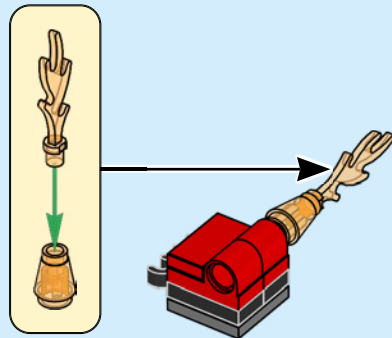



1x

62

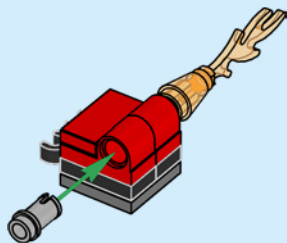

1x

63

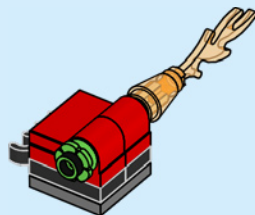

64

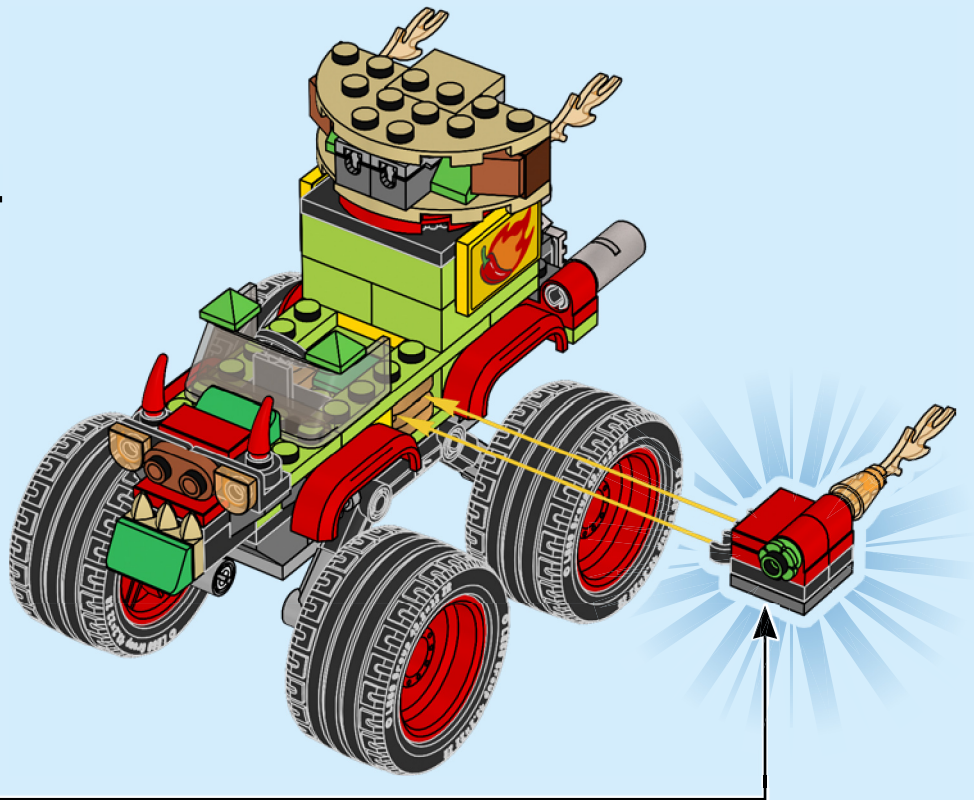



1x

65

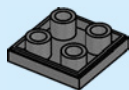

2x

66

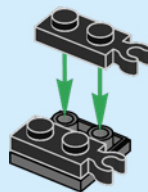



2x

67

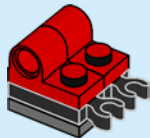

1x

68

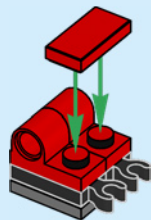



1x

69

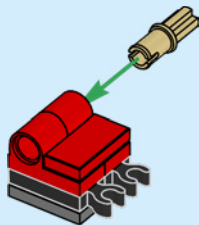

1x



1x

70

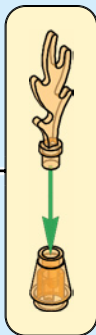
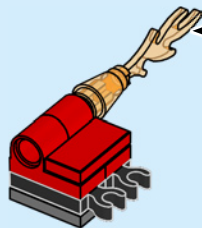



1x

71

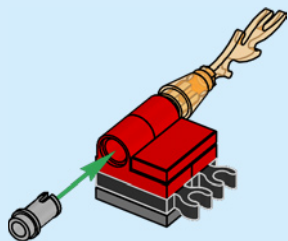

1x

72

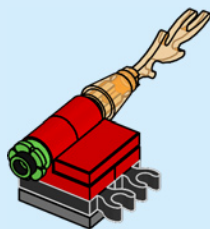

73

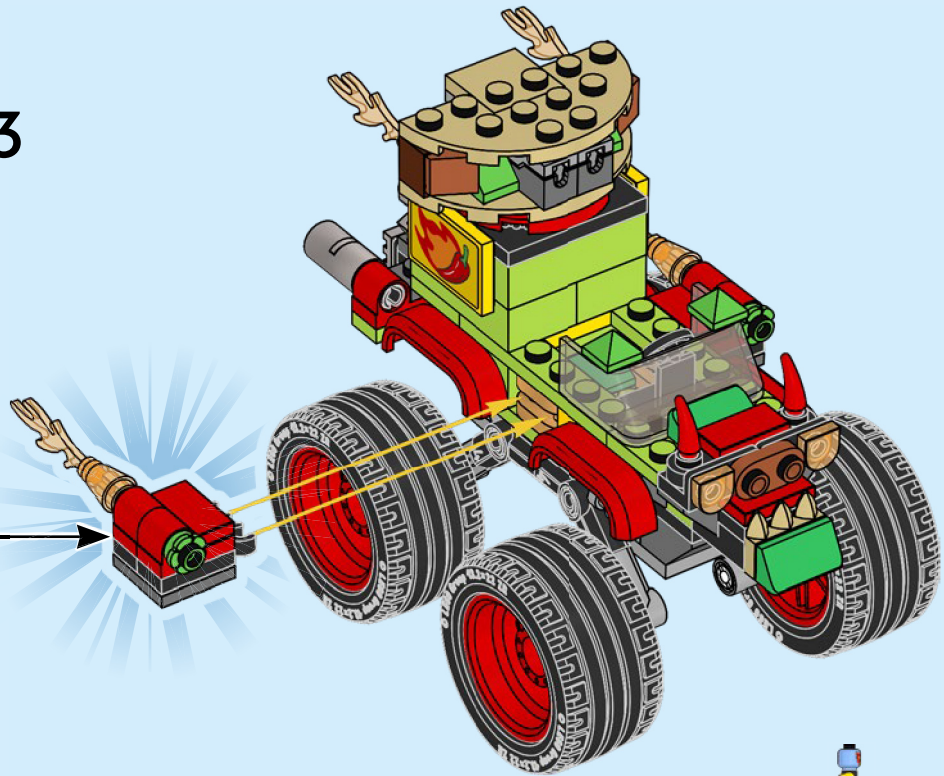

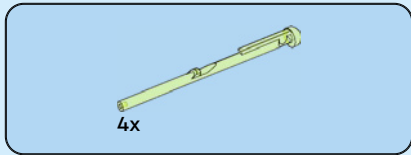

74

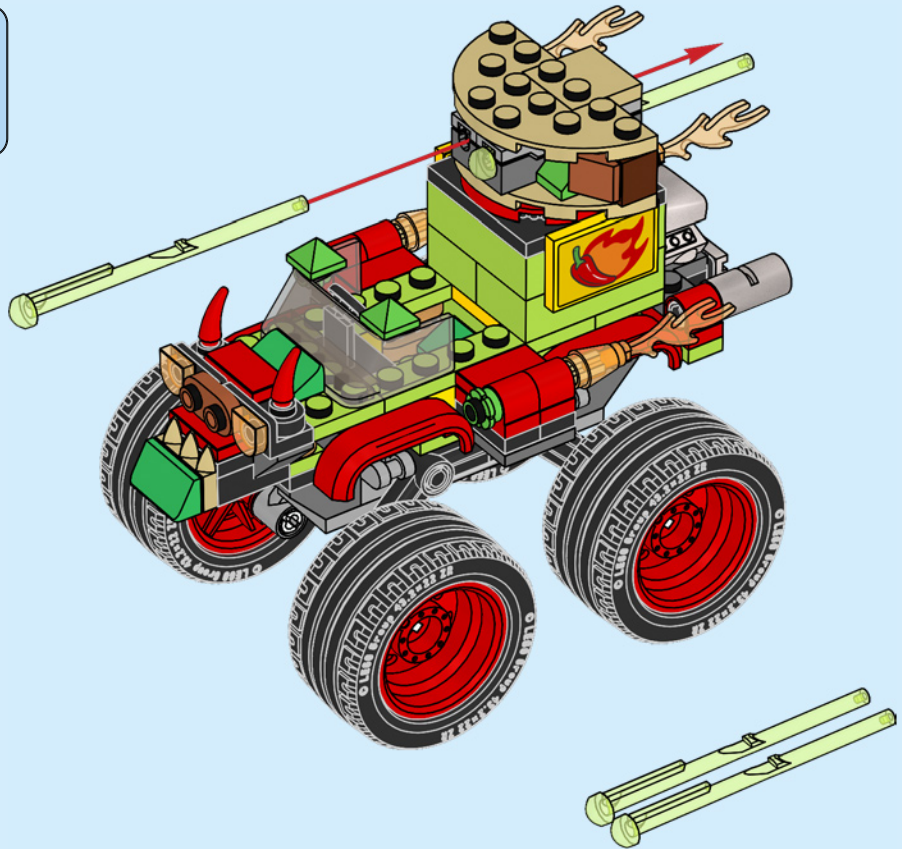

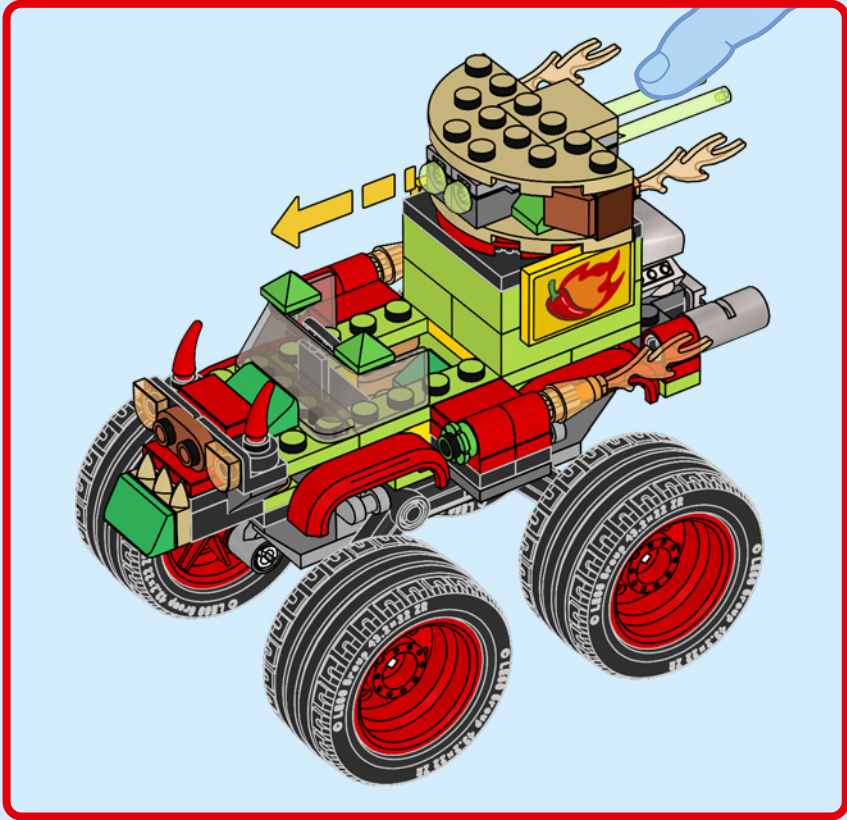

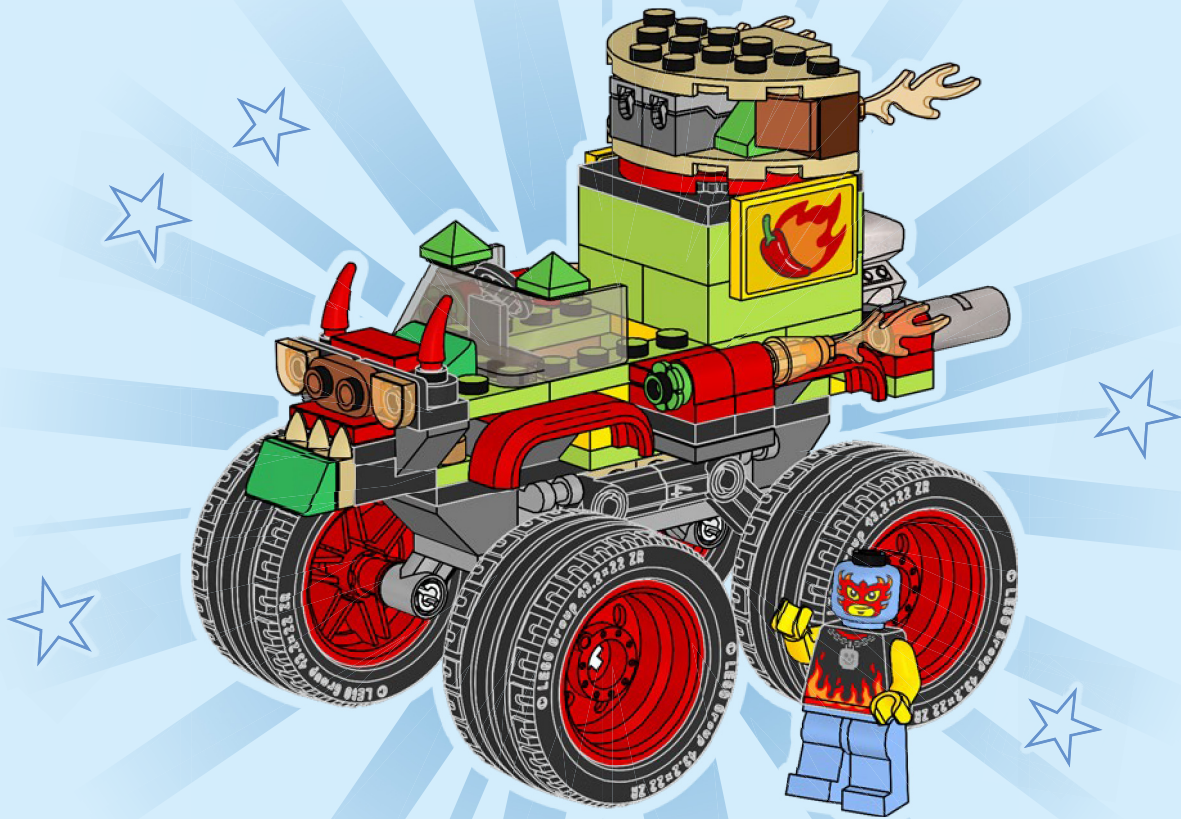

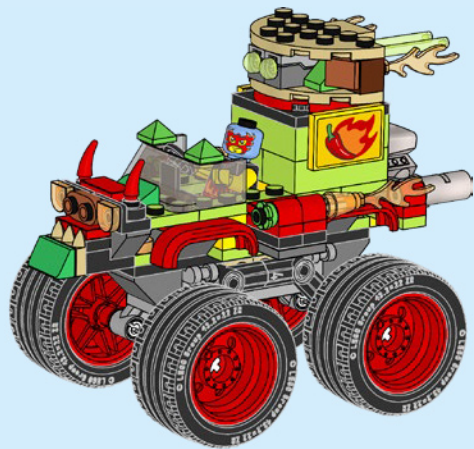
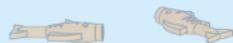
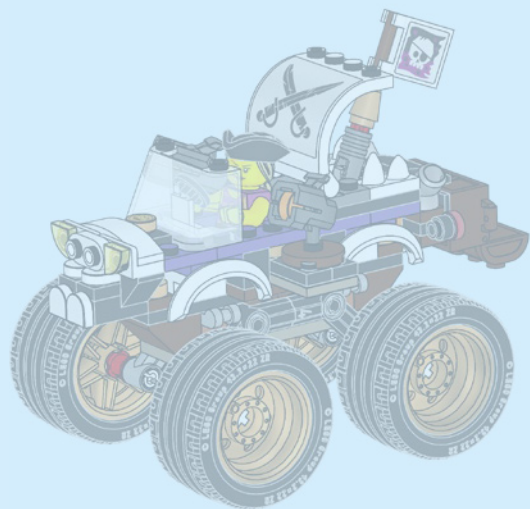



CITY



PLAY IT IN
SPIEL DAMIT IN
JOUÉ DANS
GIOCA IN
JUEGA CON EL MODELO EN
JOGA EM
可在下方游戏中玩乐
BAW SIŃ
ZAHRAJ SI V
JÁTSZD LE EBBEN:
JOACĂ-L ÎN
ИГРАЙТЕ В
ROTAĻĪJIES
MĀNGI SEE SISSE
ŽAISK



60395



60396



60397



CITY

60368



60377



60378



60379





Rebuild
the
world™





CITY

60397



3

4

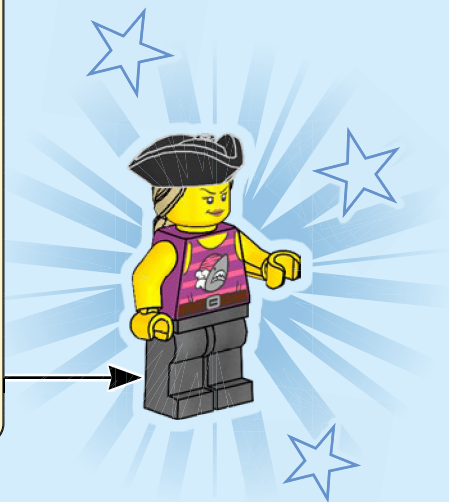
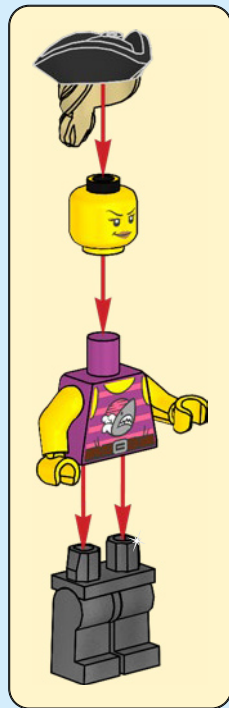

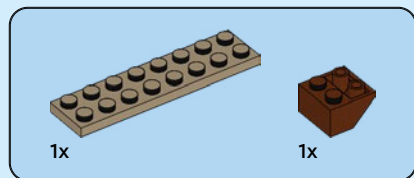

1

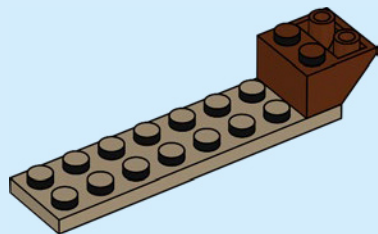

2

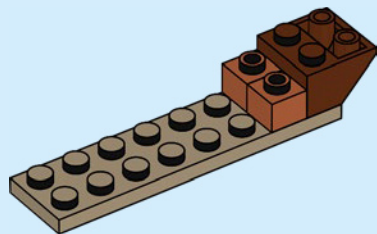



2x



1x

3

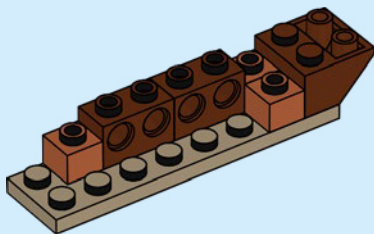

4





2x



1x

4

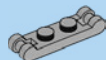
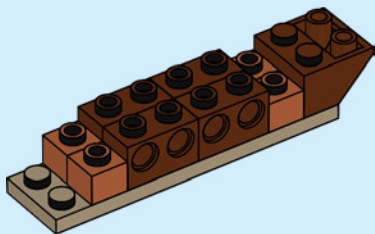

2x

5

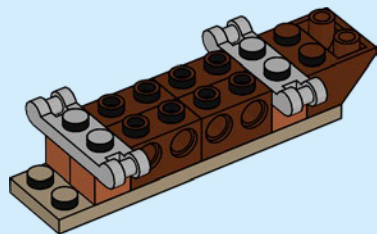



1x

6

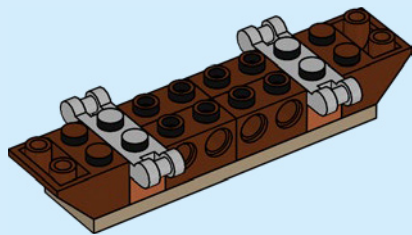

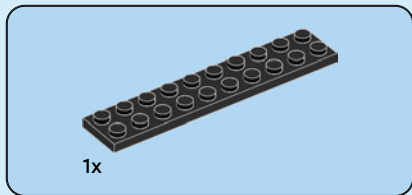

7

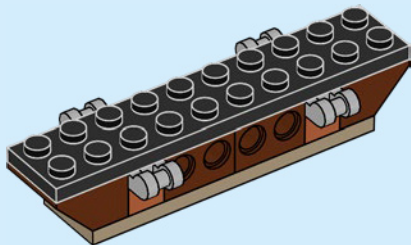

8

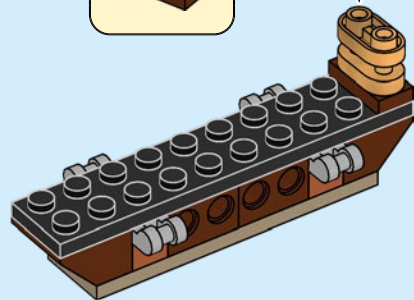
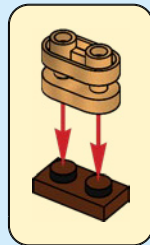



2x

9

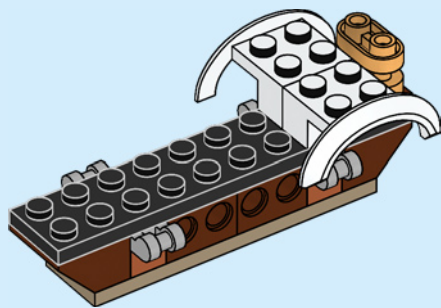

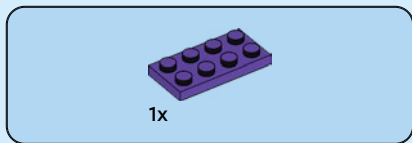

10

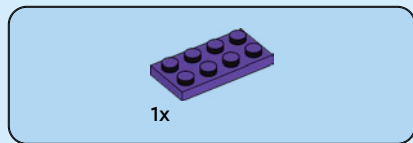
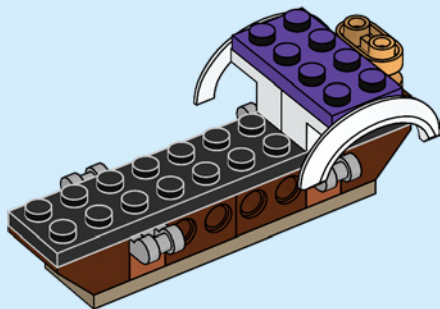

11

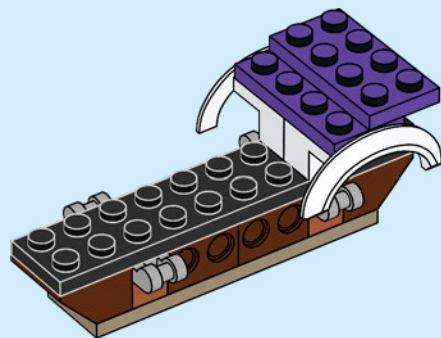

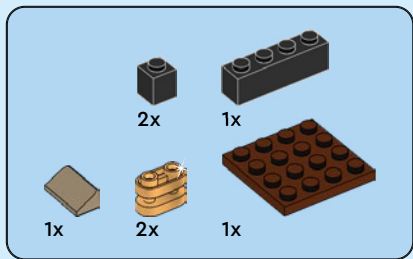

12

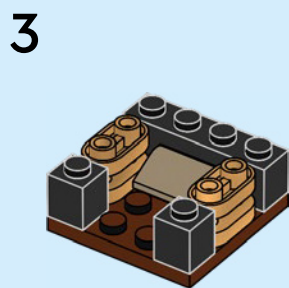
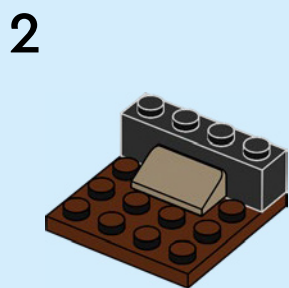
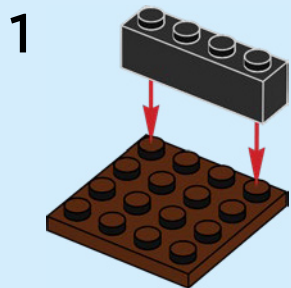

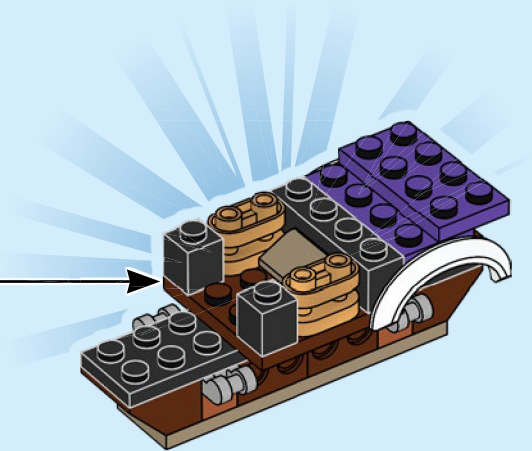



2x

13

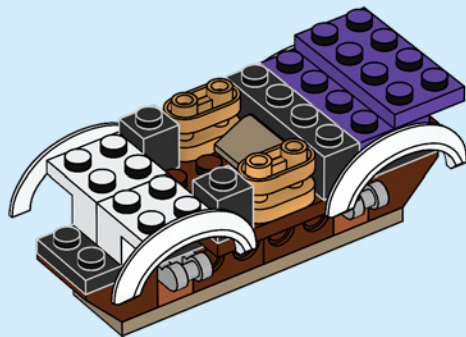

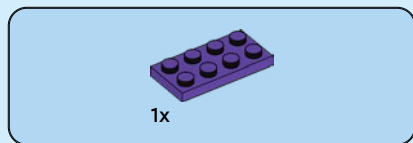

14

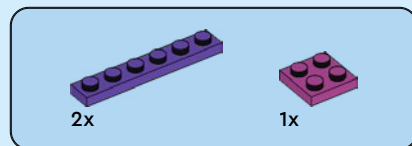
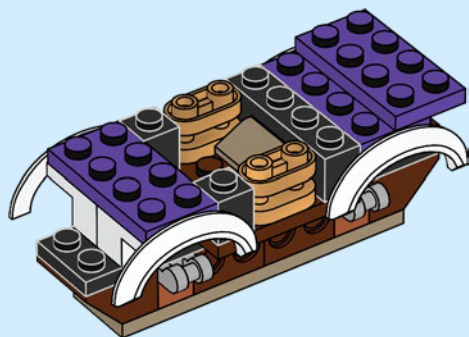

15

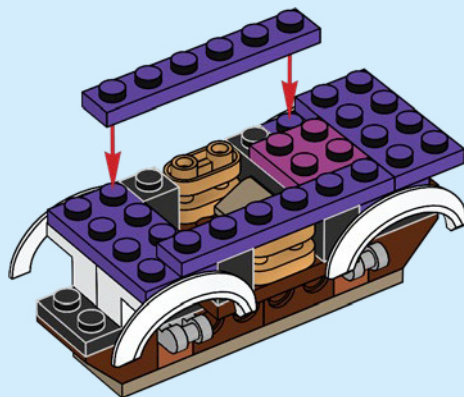



1x

16

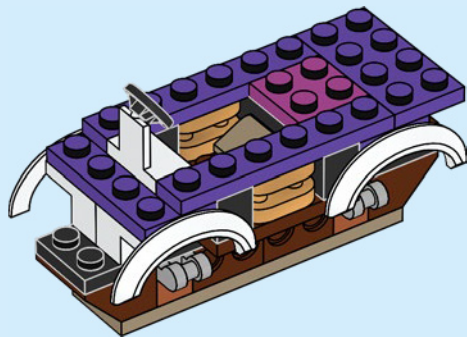



1x



1x

17

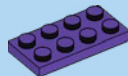
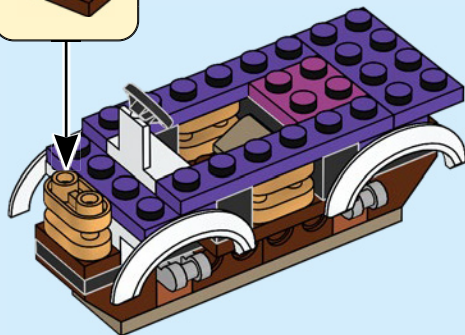
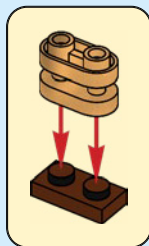

1x

18

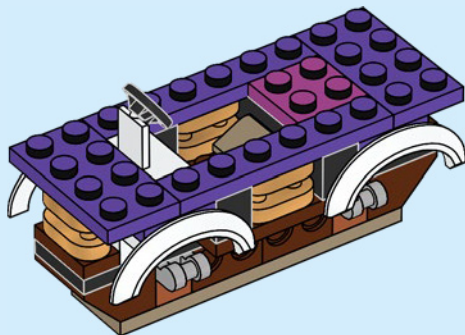

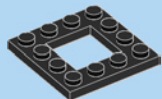

1x

19

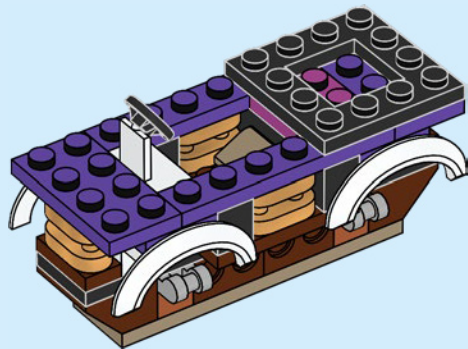



1x

20

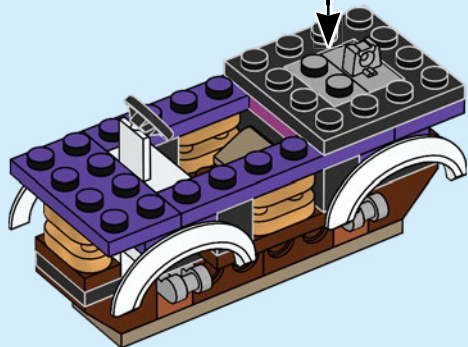

2x



2x

21

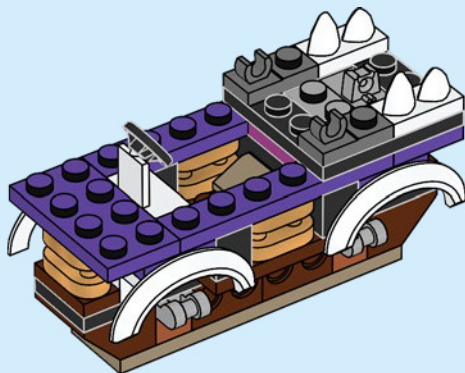

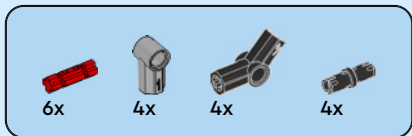
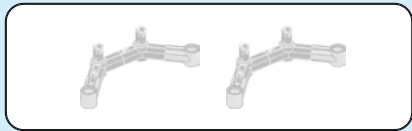

22

1

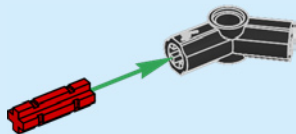

2

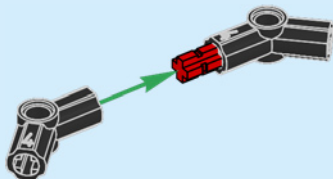

3

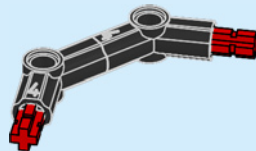

4

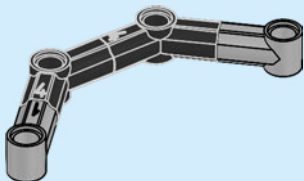

5

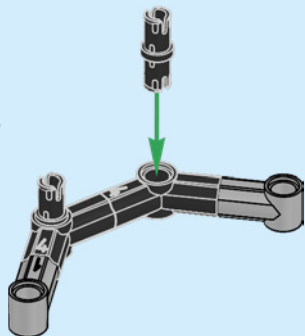

2x

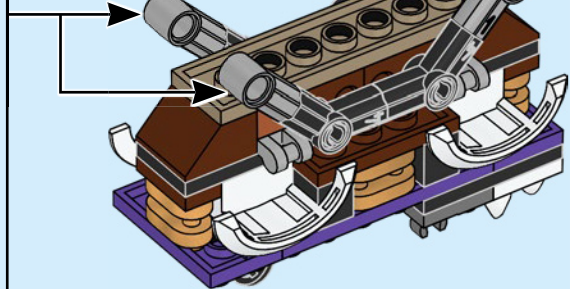

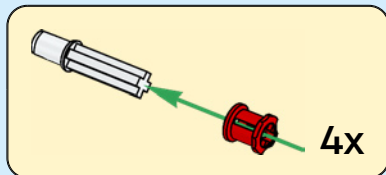
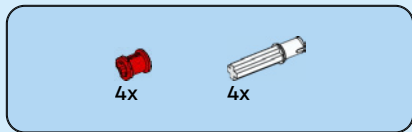

23

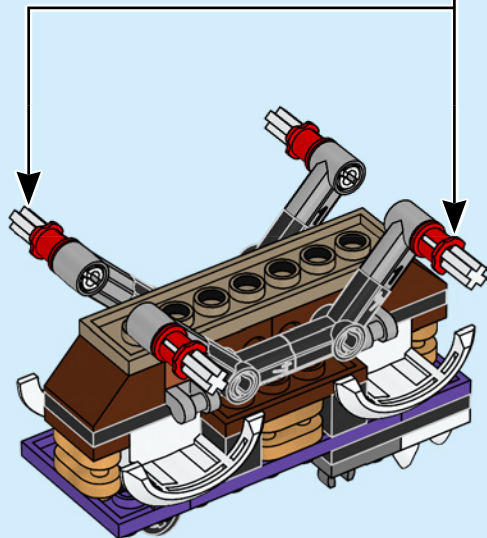

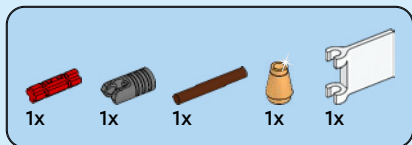

24

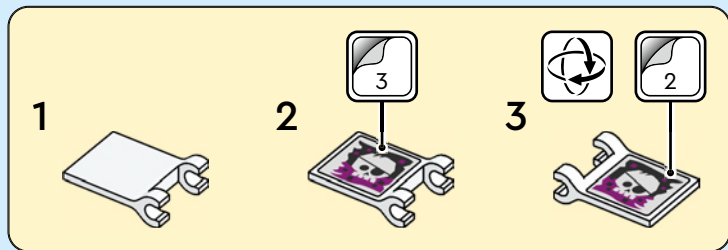

1

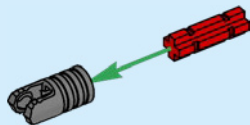

2

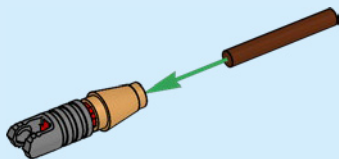

3



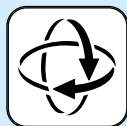

25

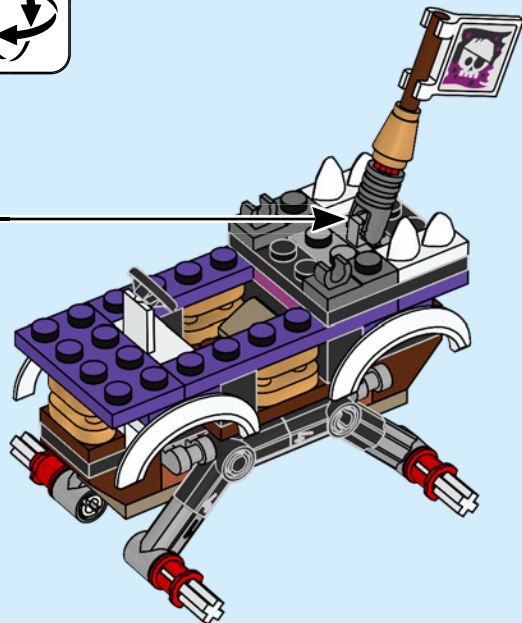

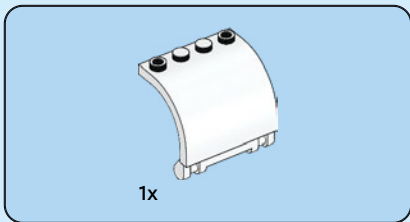

26

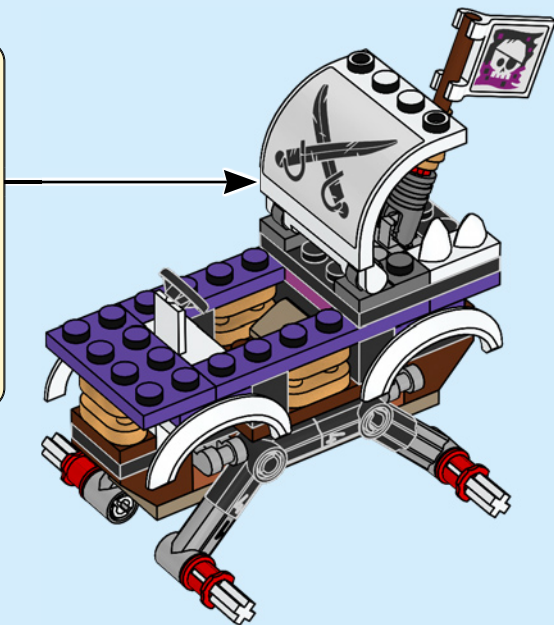
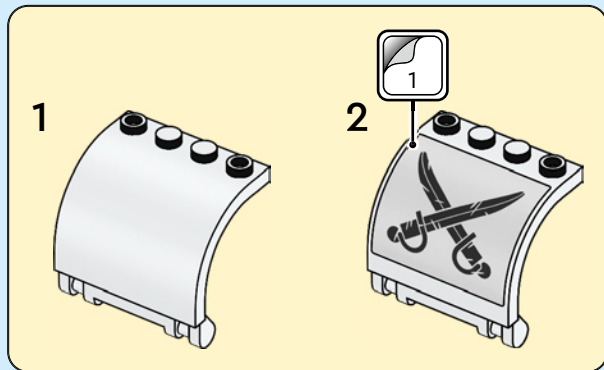

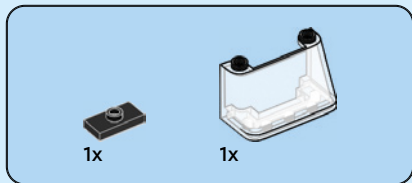

27

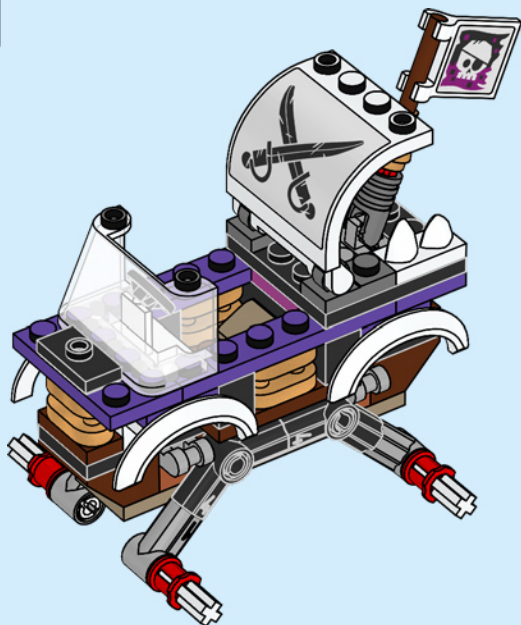



28

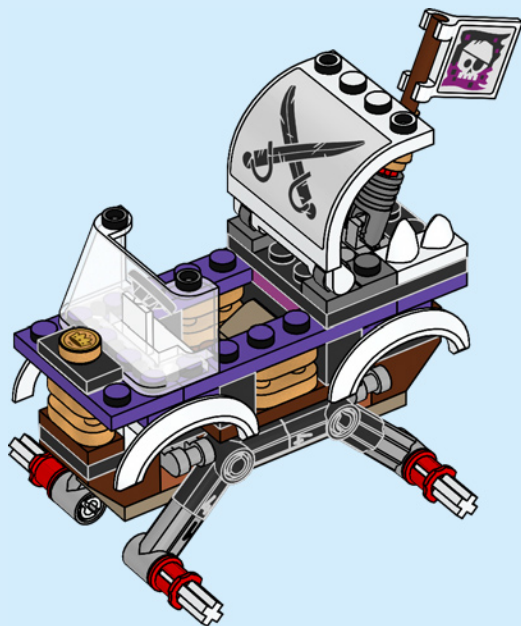

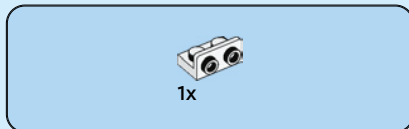

29





1x

30



2x



2x

31





1x

32



2x

33





1x

34

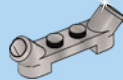
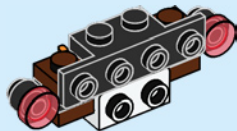

1x

35

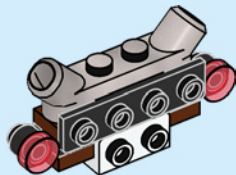

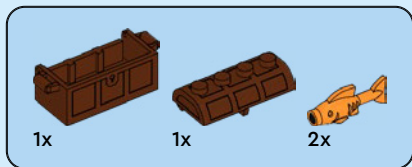

36

1

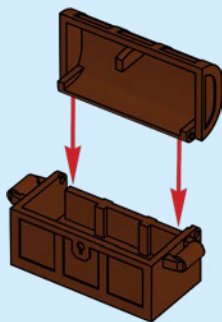

2

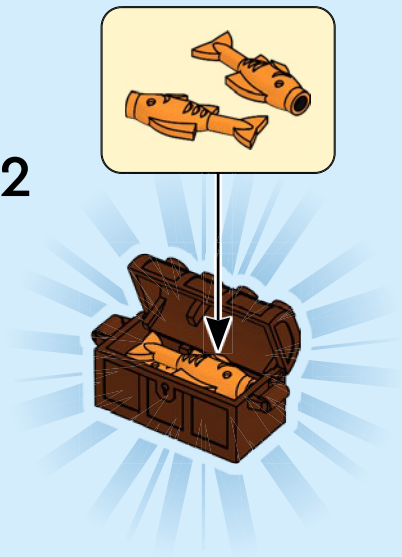



1x

37

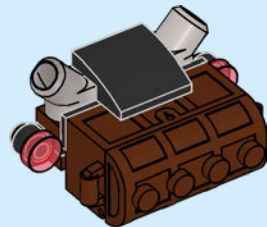
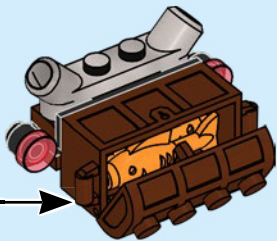

38

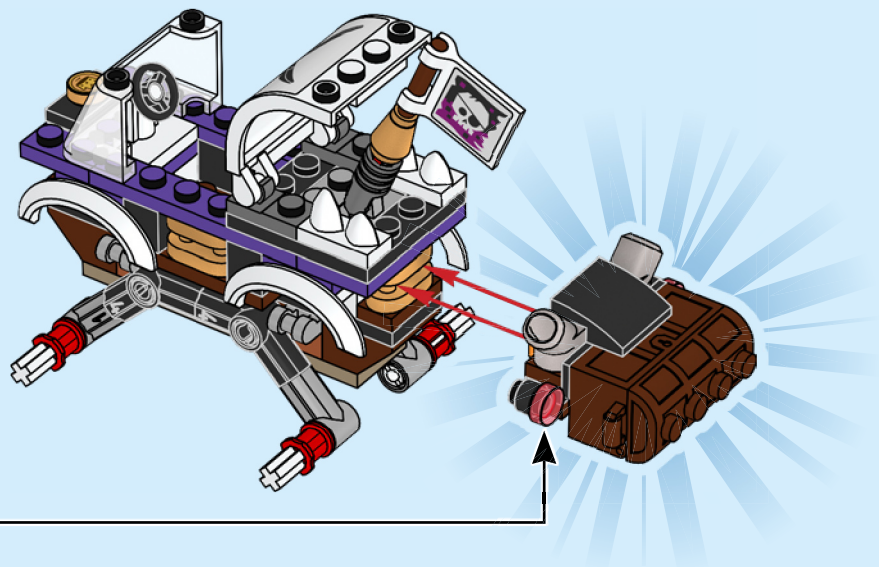



1x

39

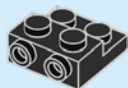

1x

40

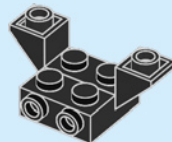



2x

41

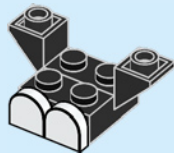

2x

42

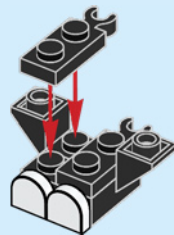



1x



2x

43

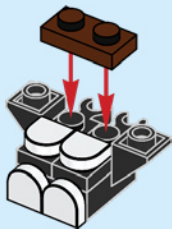

2x

44

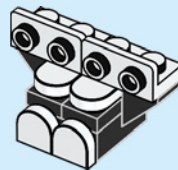



1x

45

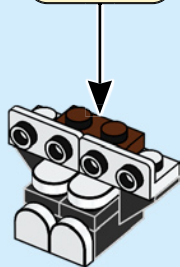

1x

46

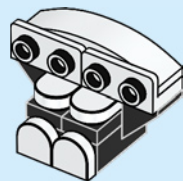



1x



2x

47

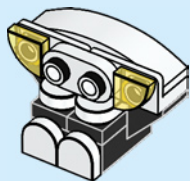

48

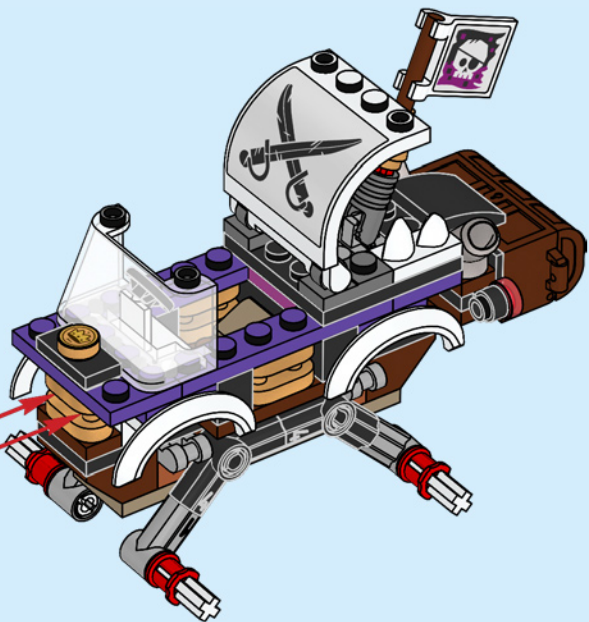
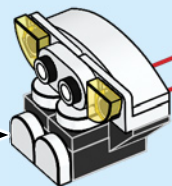

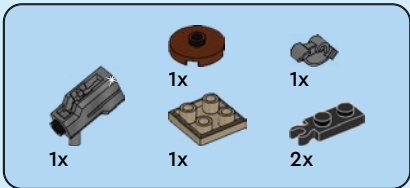
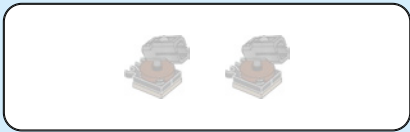

49

1

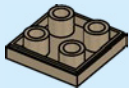

2



3

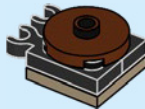

4

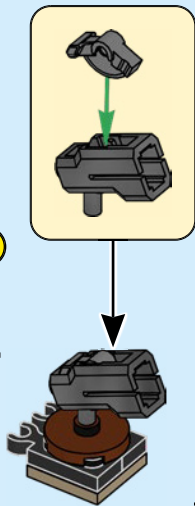

2x

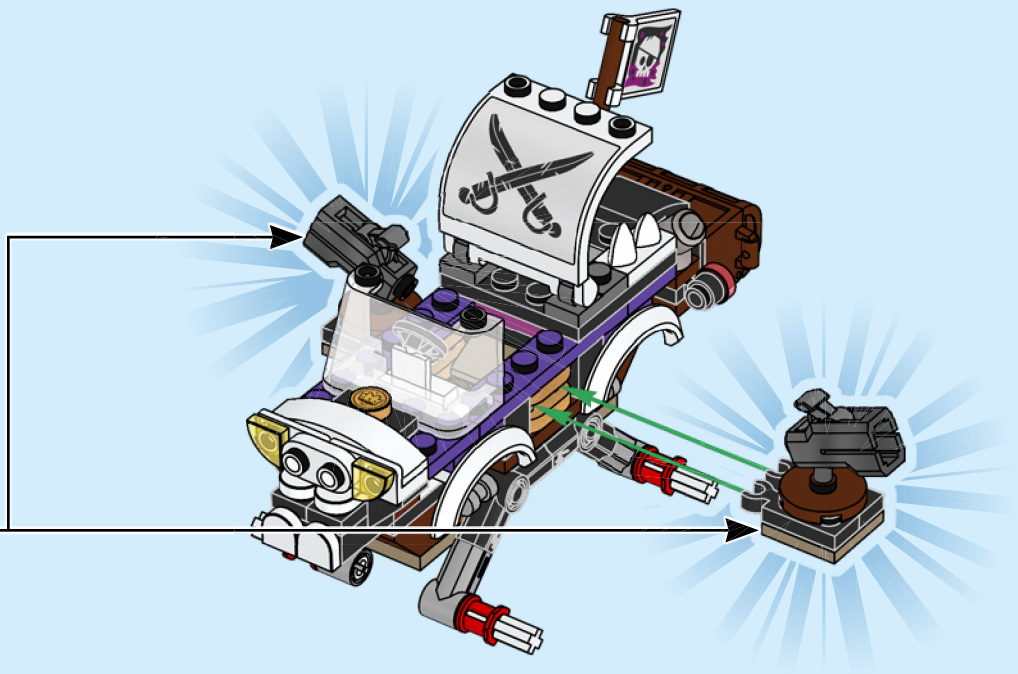

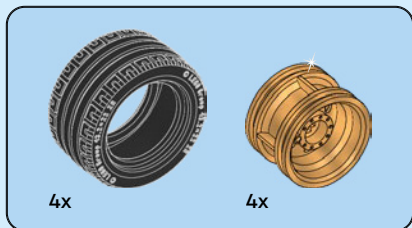

50

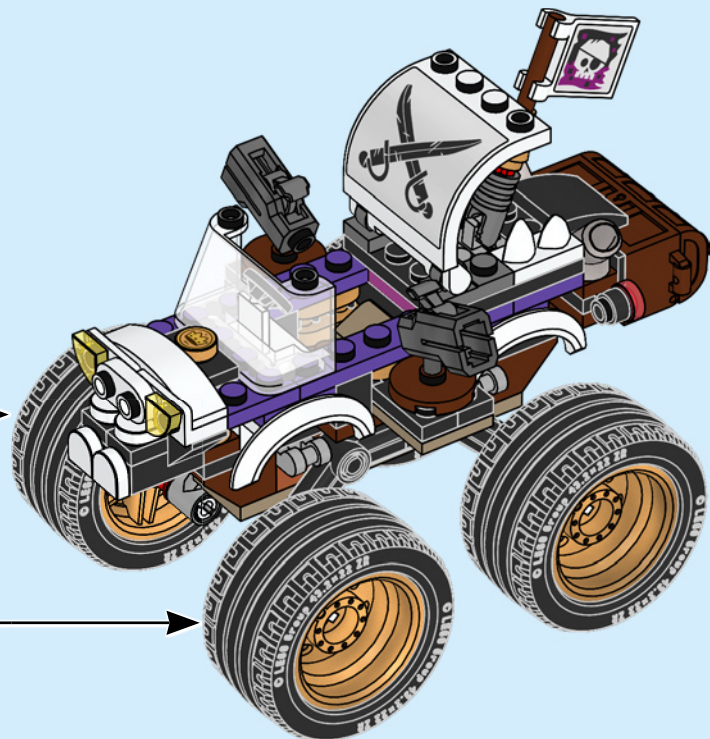
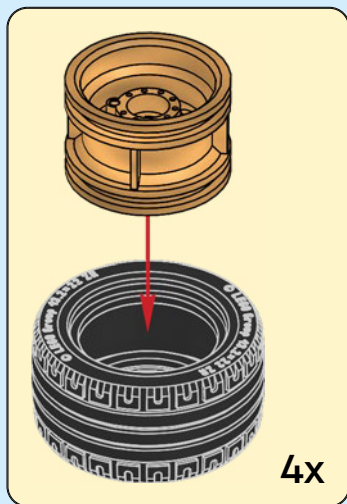

51

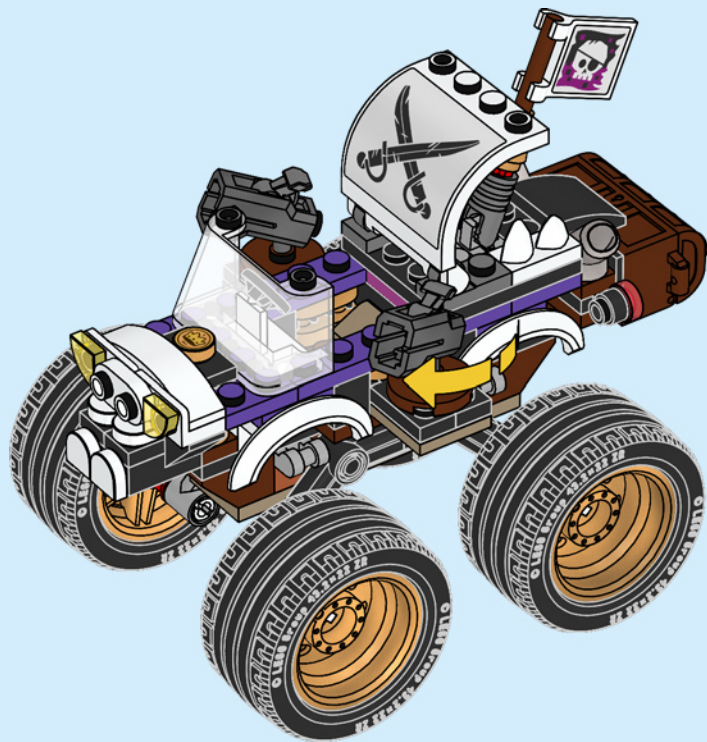

4x

52

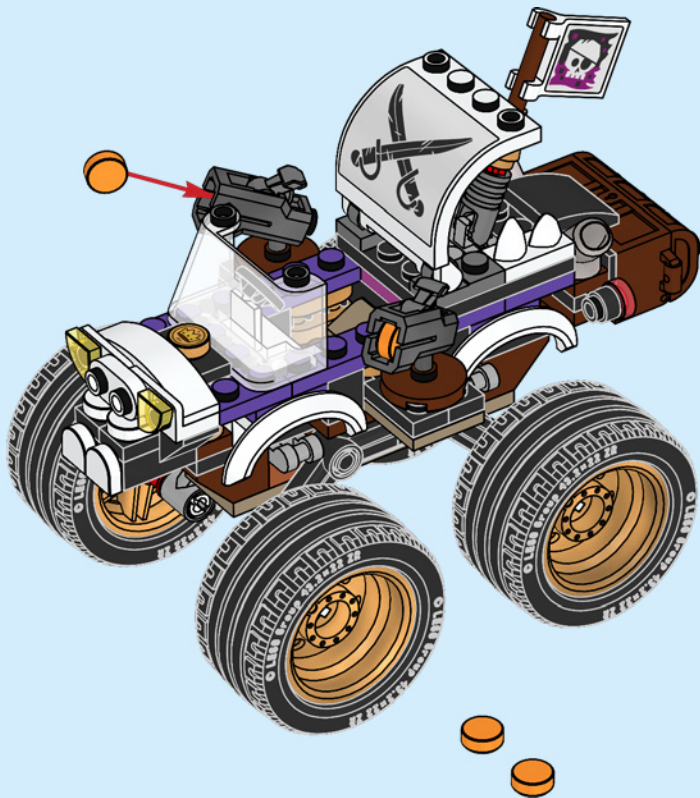

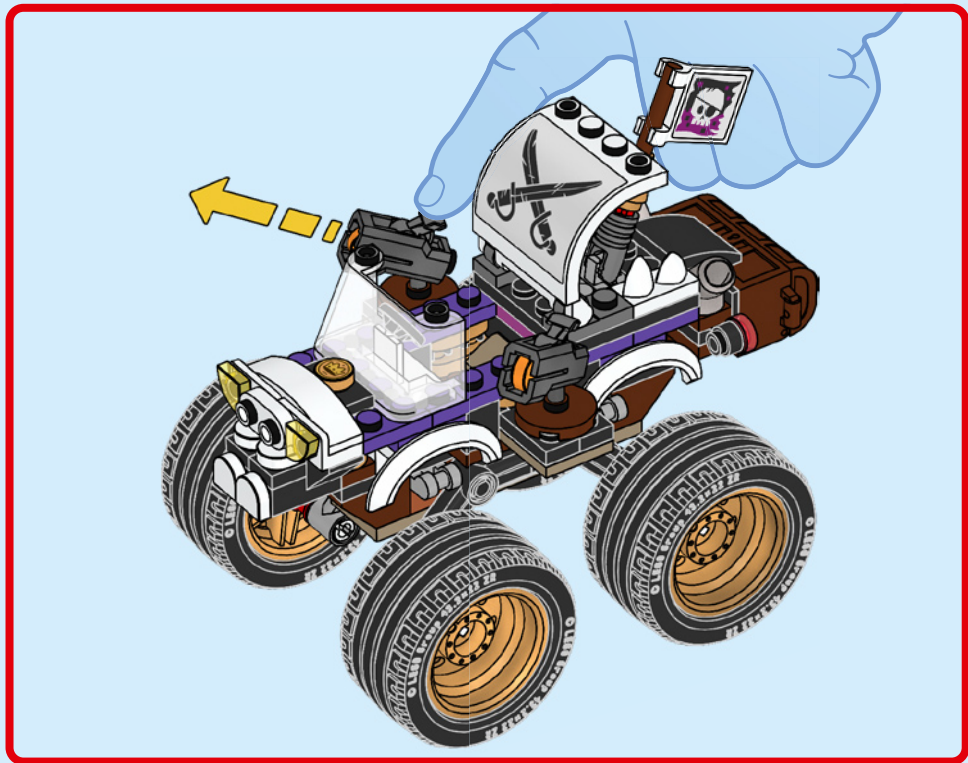

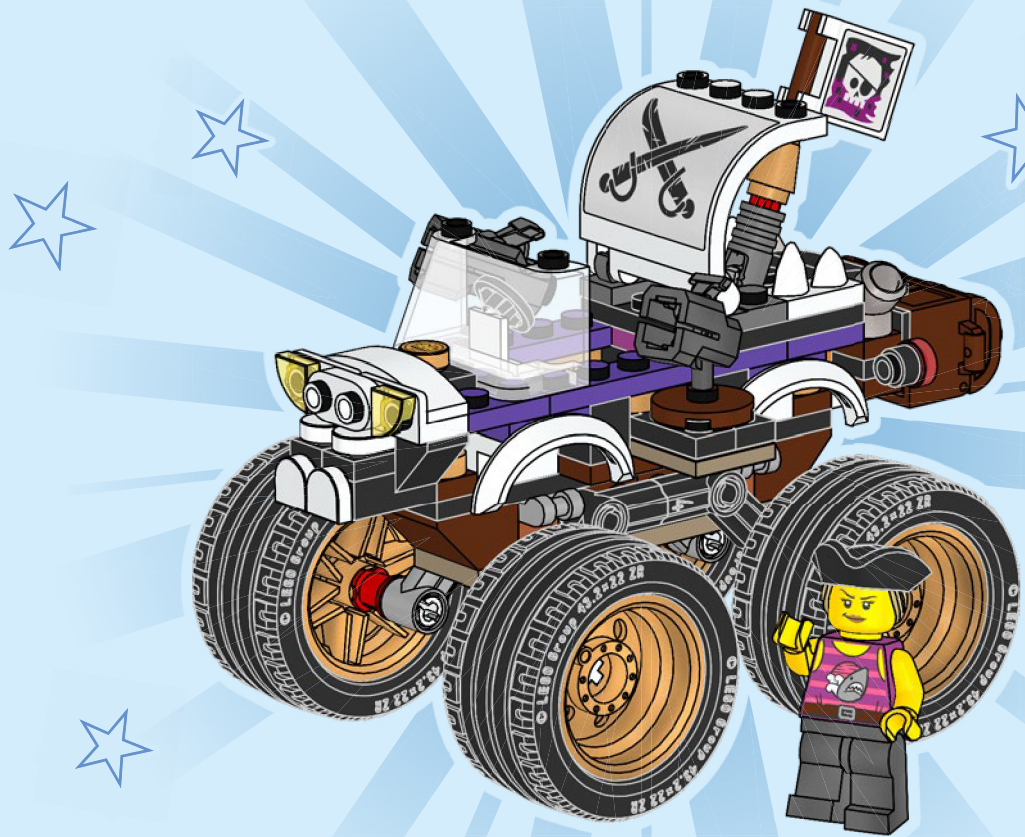

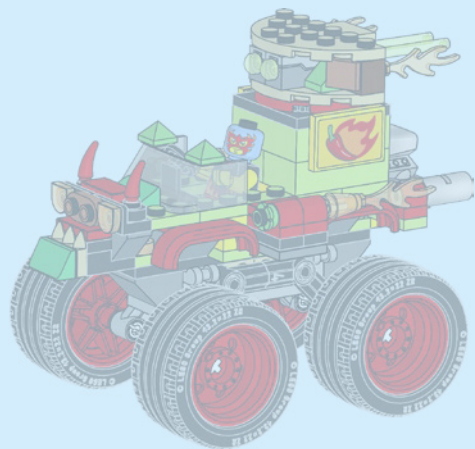
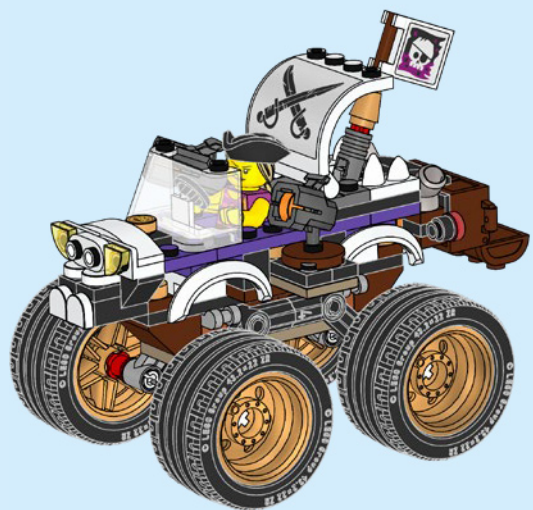





1x
6455810



1x
6015449



2x
6406008



1x
4246957



2x
6172233



4x
6167741



2x
6249116



2x
6253167



2x
6102360



4x
4211150



4x
6151461



1x
6428805



2x
6425510



2x
4211190



1x
6254220



1x
4533101



1x
4243838



8x
6296859



2x
4211483



4x
6401023



1x
6265742



4x
6093058



2x
6324200

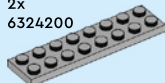

1x
4211406



2x
6258607



2x
6360675



1x
6271538



2x
6344754



6x
4211000



2x
4210635



2x
6013082



1x
6185675



4x
6030277



2x
4655691



1x
6375358



1x
4529247



8x
6370621



4x
4648531



4x
6287551



1x
4619636



2x
6245499



1x
6076604



1x
4632100



1x
6197015



2x
6345880



 [LEGO.com/service](https://www.LEGO.com/service)

YOU COULD **WIN**



Scan this QR code or go to **LEGO.COM/PRODUCTFEEDBACK** and give us your short feedback about this LEGO® set for a chance to win a cool LEGO prize.

Terms and Conditions apply*

EN: YOU COULD WIN. Terms and Conditions apply* **DE: Du könntest GEWINNEN.** Es gelten die Teilnahmebedingungen* **FR: Tu pourrais GAGNER.** Des conditions s'appliquent* **IT: Potresti VINCERE tu.** Termini e condizioni sono applicabili* **ES: Puedes GANAR.** Aplican términos y condiciones* **PT: Poderá GANHAR.** Aplicam-se termos e condições* **ZH: 轻松获奖. 条款和条件适用*** **PL: Szansa na WYGRANĄ.** Obowiązują warunki korzystania* **CS: Máte šanci VYHRÁT.** Platí všeobecné smluvní podmínky* **SK: Máte šancu VYHRAŤ.** Platia všeobecné zmluvné podmienky* **HU: TE IS NYERHETSZ.** Felhasználási feltételek érvényesek* **RO: Ai putea CÂȘTIGA.** Se aplică termenii și condiții* **BG: Можете да СПЕЧЕЛИТЕ.** Има определени правила и условия* **LV: Tu vari LAIMĒT.** Ir spēkā noteikumi un nosacījumi.* **ET: Sul on võimalus VÕITA.** Kehtivad tingimused* **LT: Jūs galite LAIMĖTI.** Taikomos sąlygos*

*[LEGO.com/productfeedback-terms](https://www.lego.com/productfeedback-terms)

LEGO and the LEGO logo are trademarks of the LEGO Group. ©2023 The LEGO Group.

6475169