



NICKELODEON

SpongeBob  
SquarePants™

4982





1

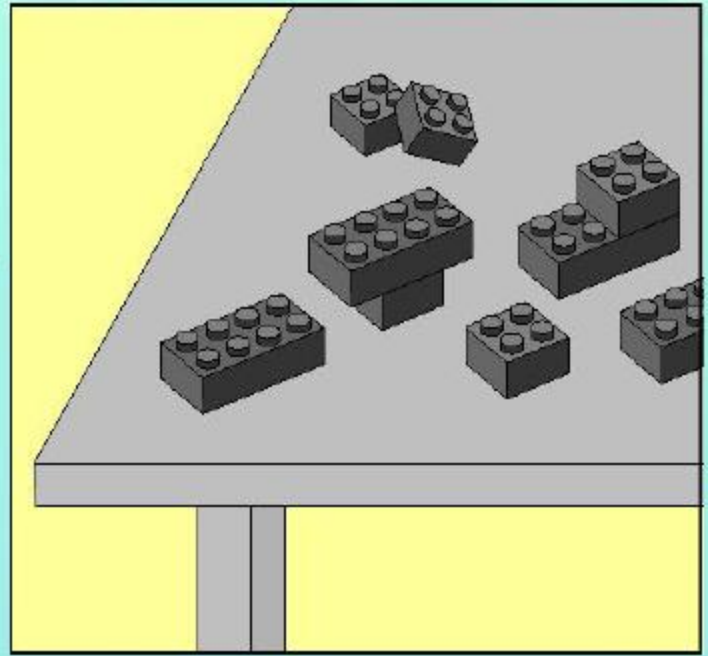
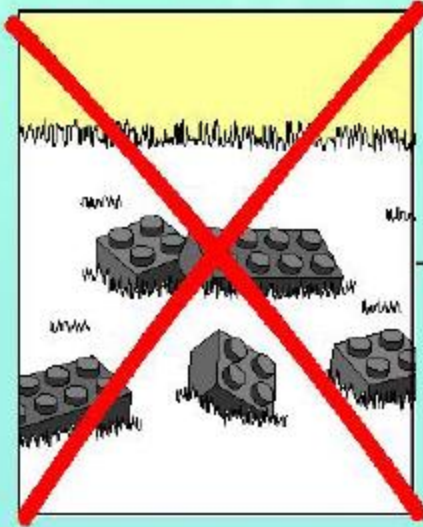

2



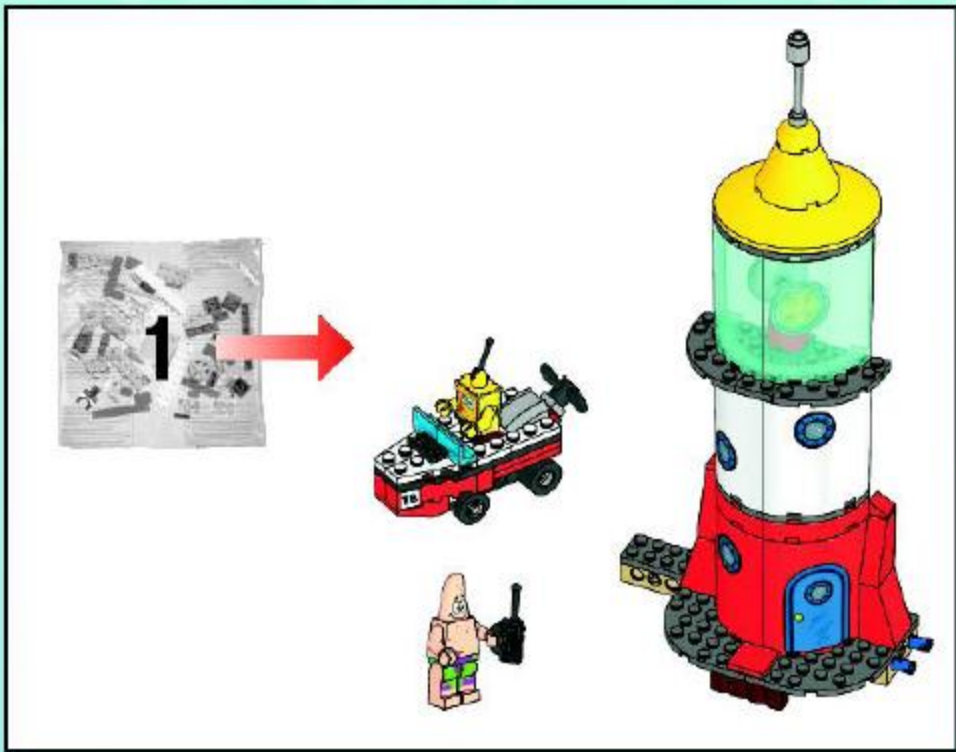

3



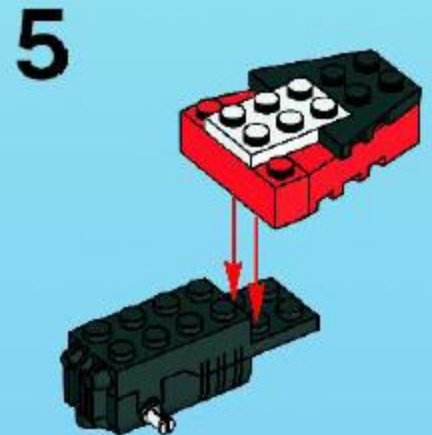
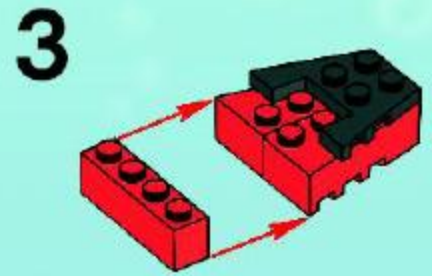
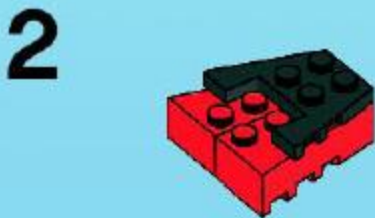
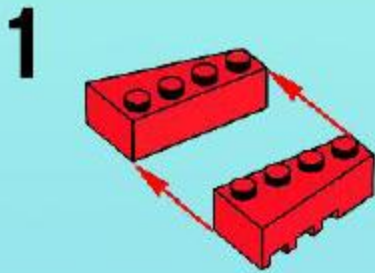
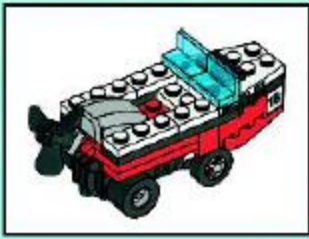

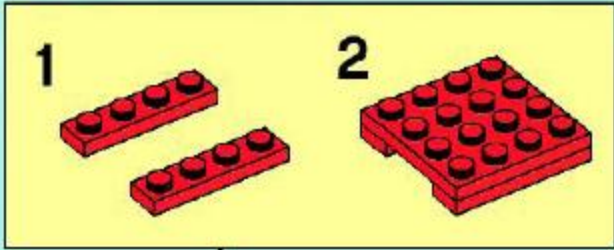

6

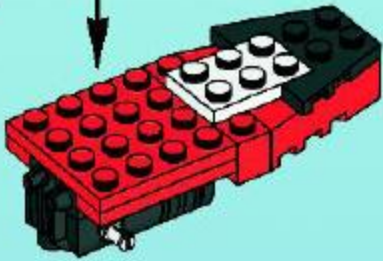

8

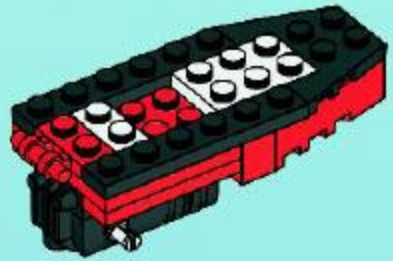

7

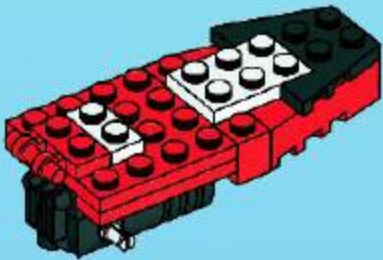

9

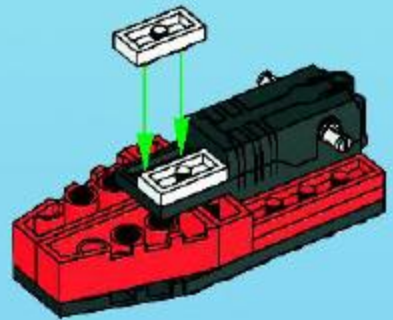

10

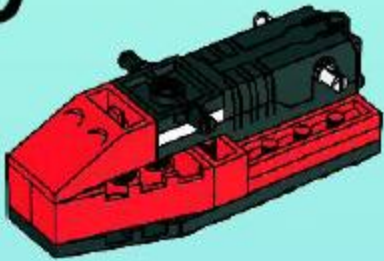

12

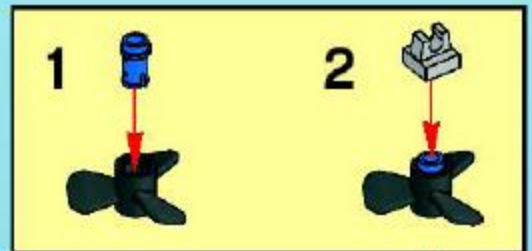

11

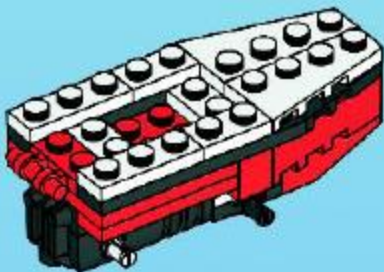

13

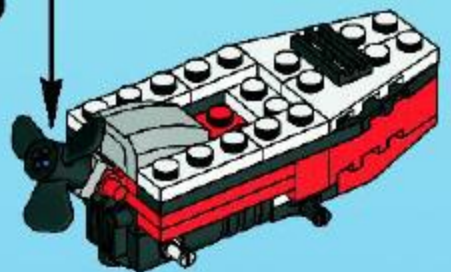

14

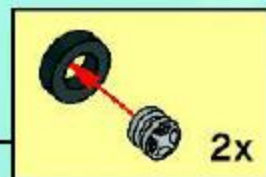

15

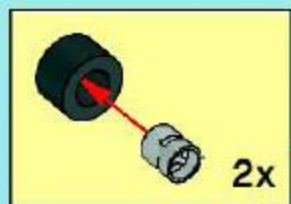
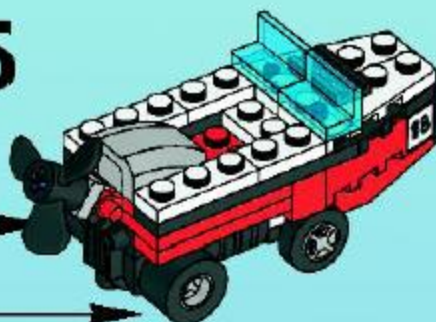

16





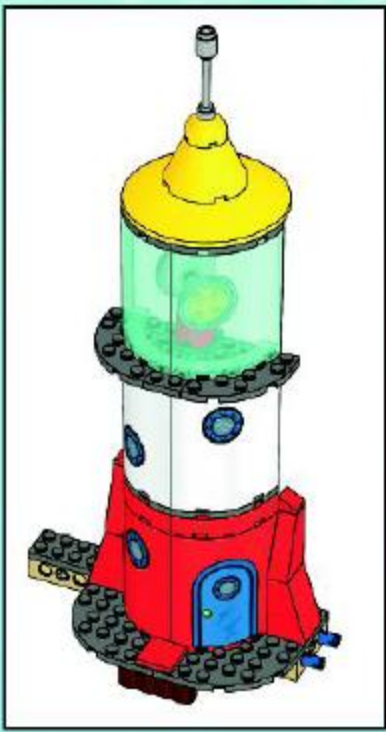

1

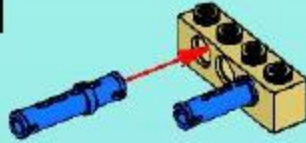

2



3

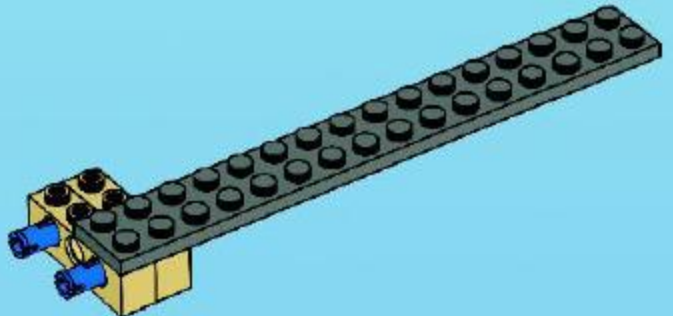

4

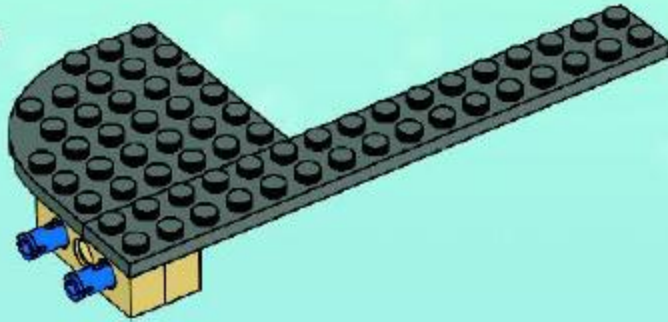

5

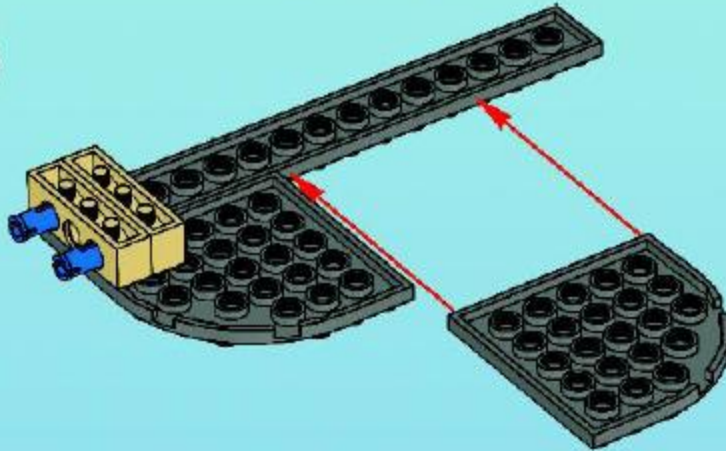

6

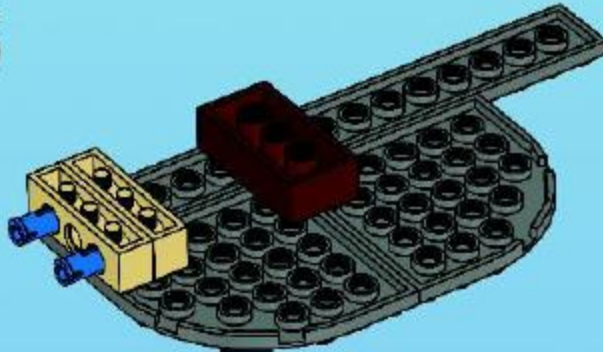

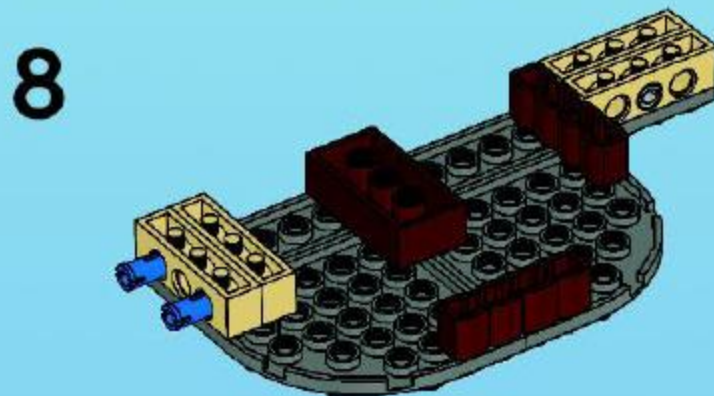
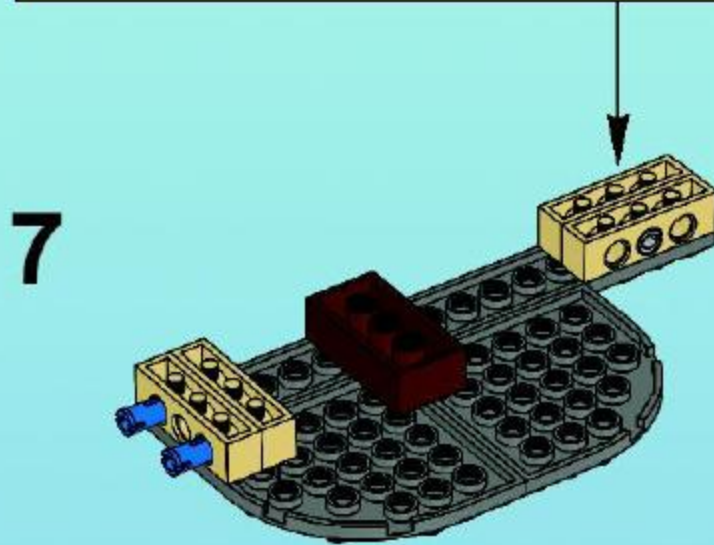
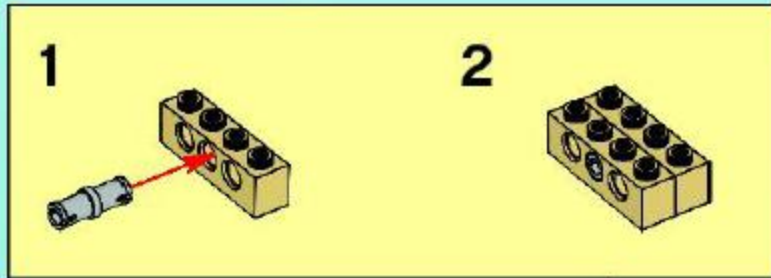



9

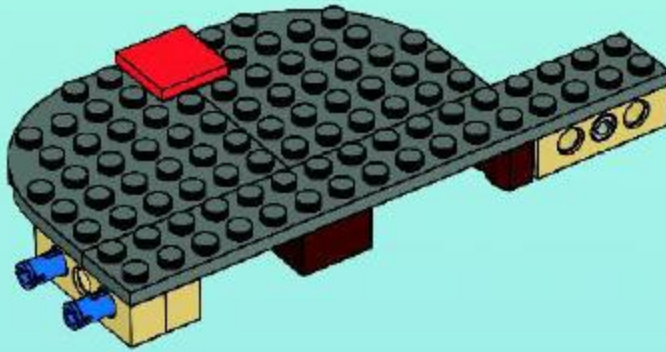

10

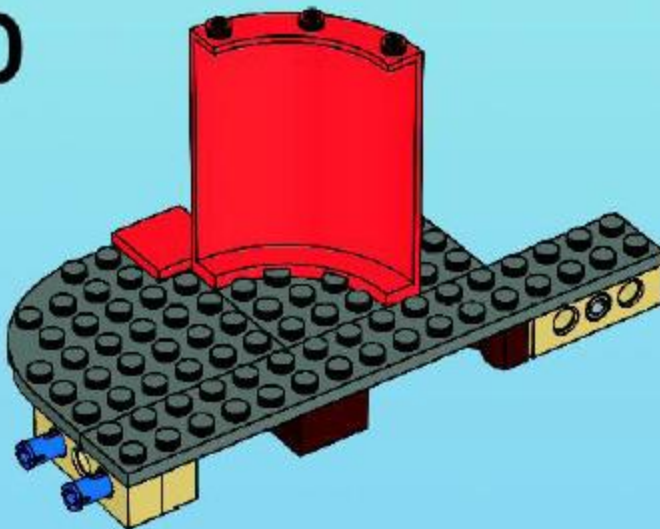

11

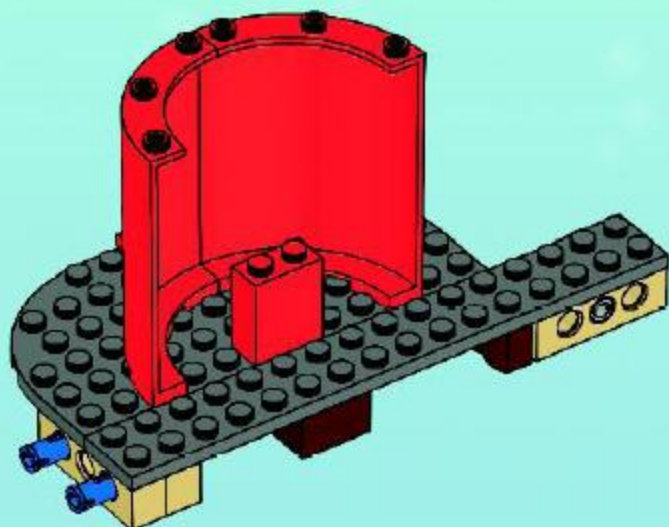

12

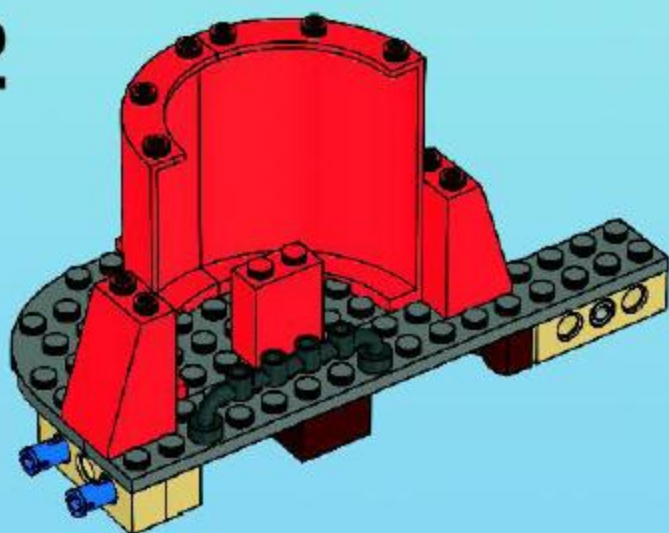

13

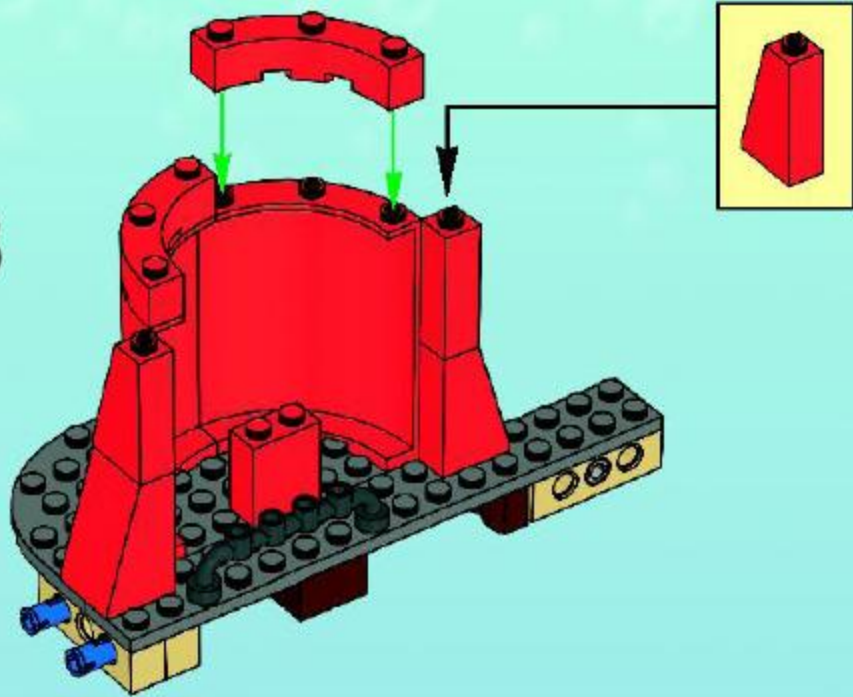

14

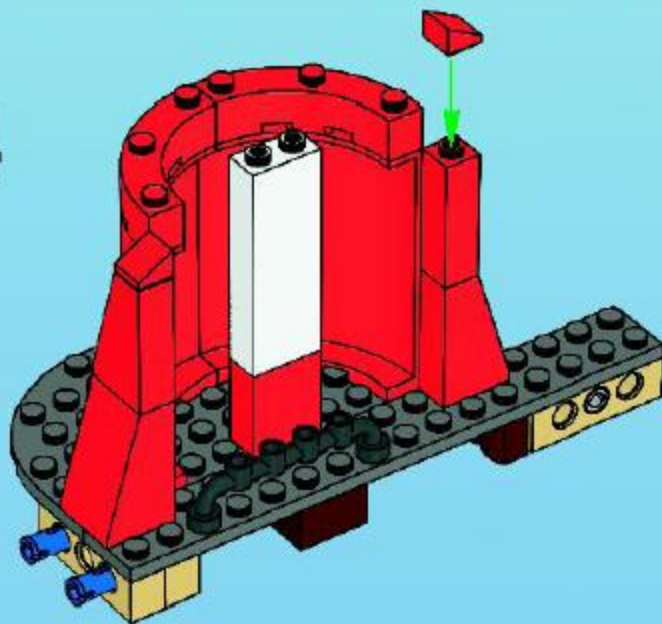

15

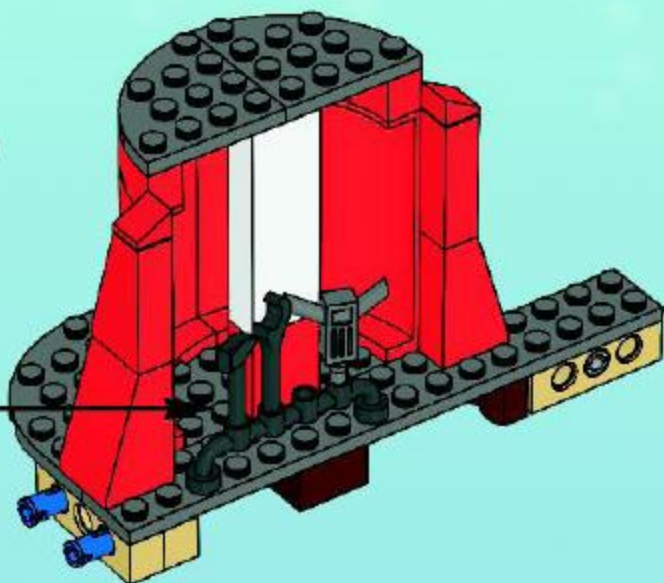

16

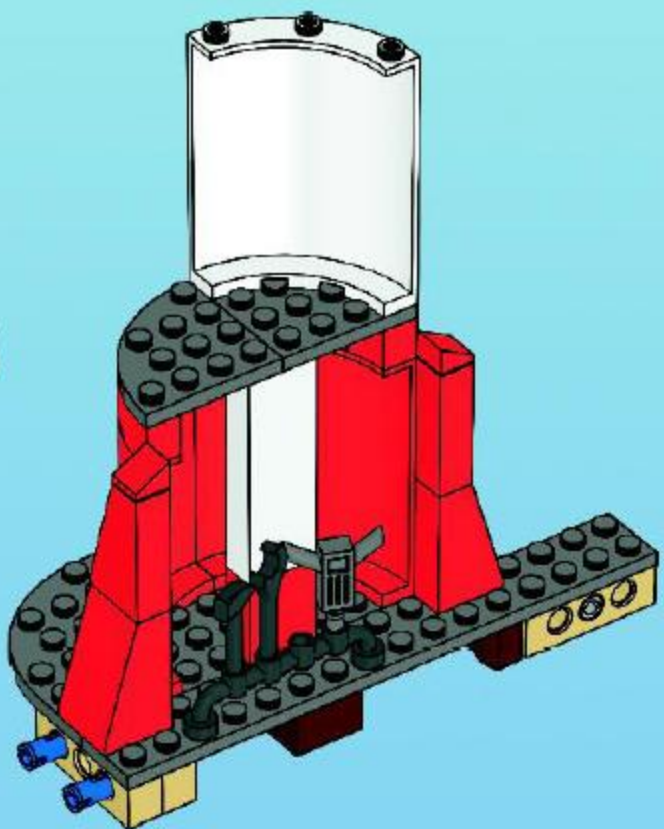

17

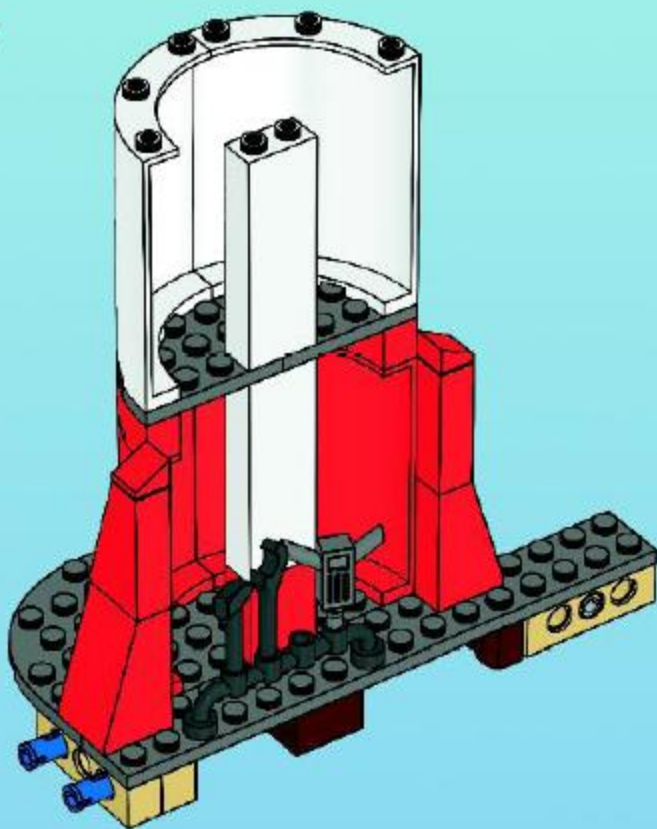



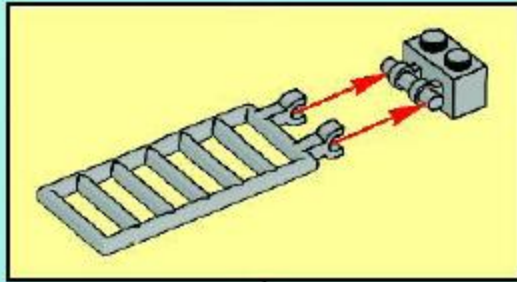

18

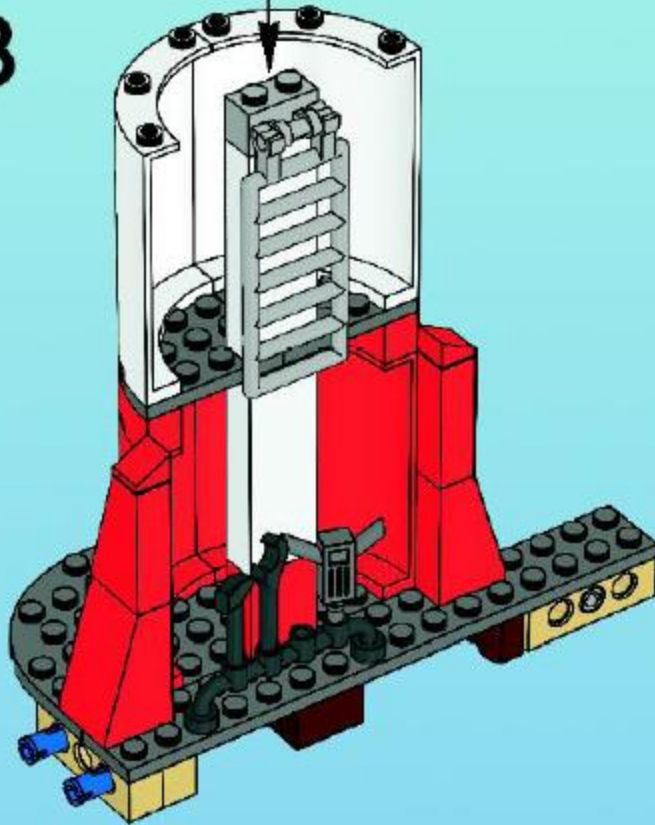

19

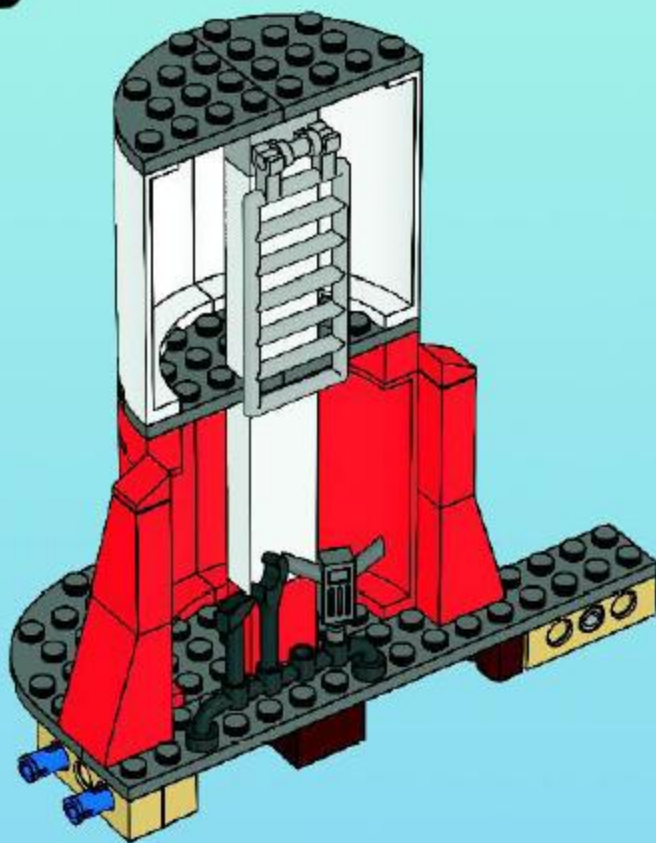

20

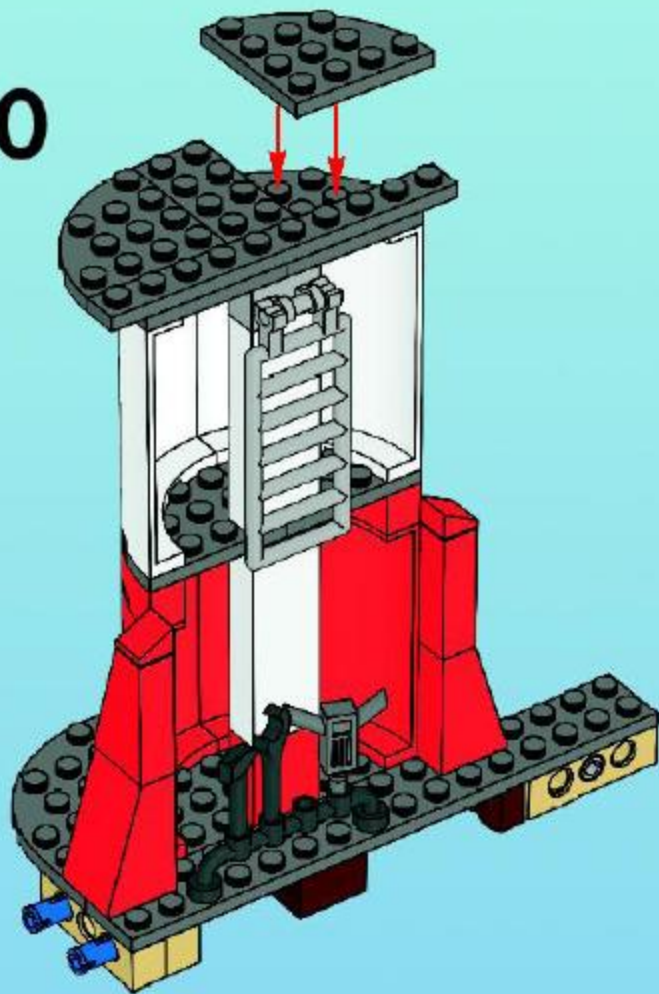

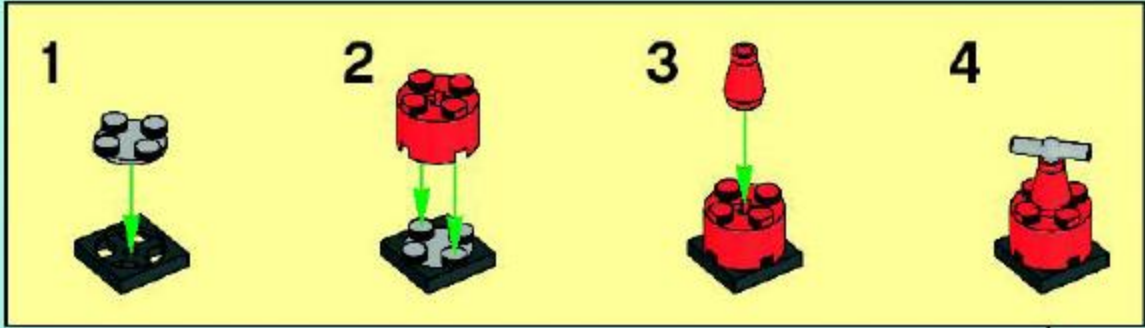

21

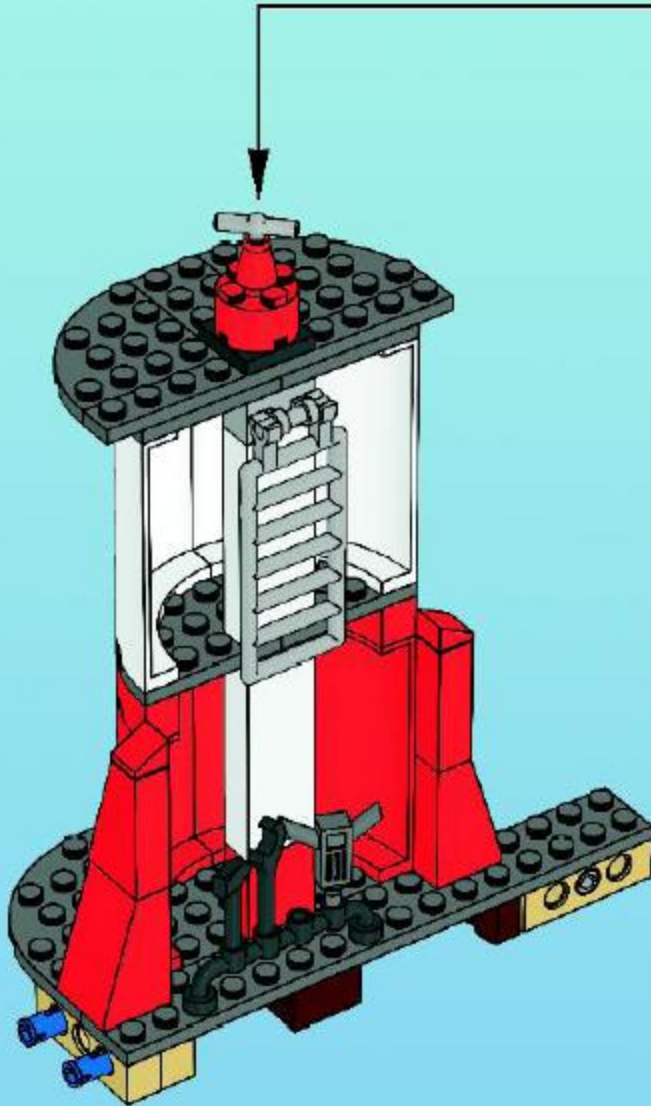

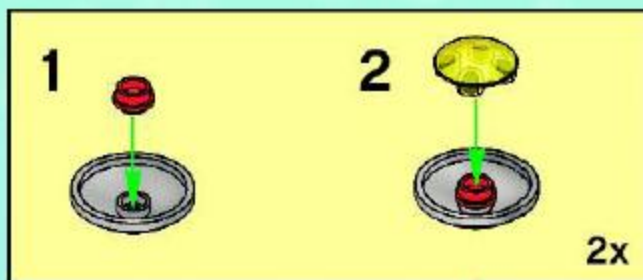

22

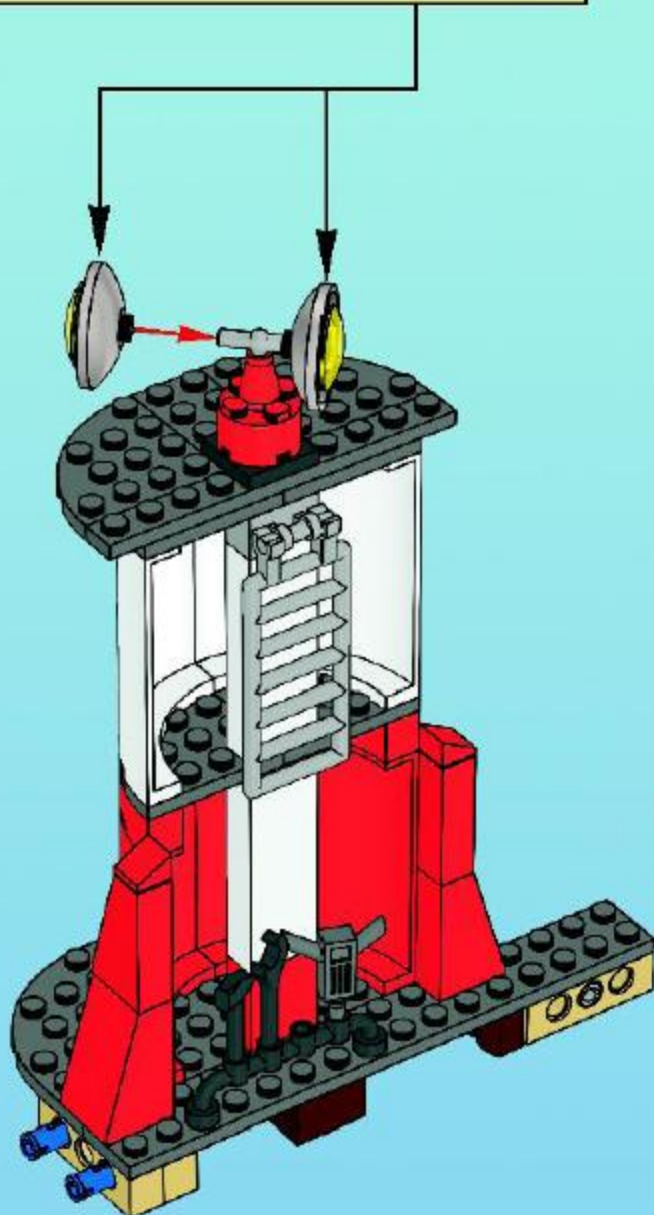

23

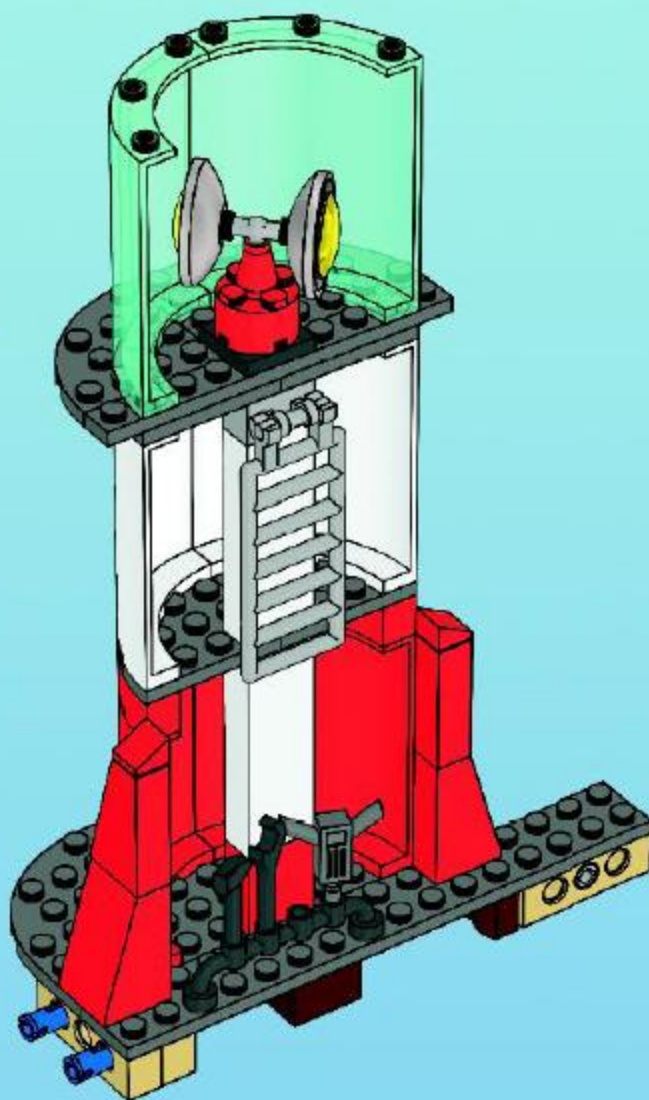

1



2

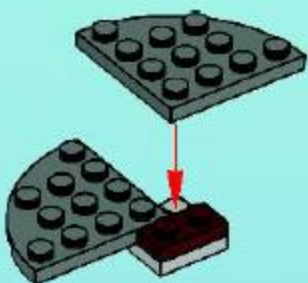

3

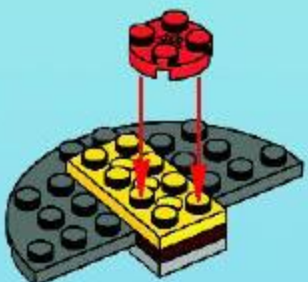

4



5

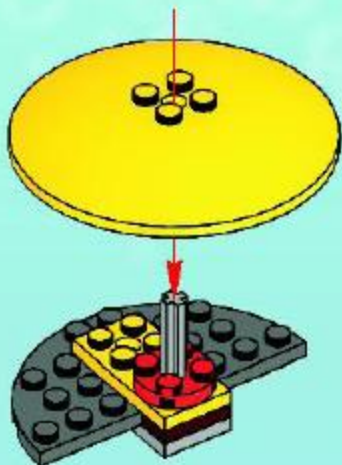

6

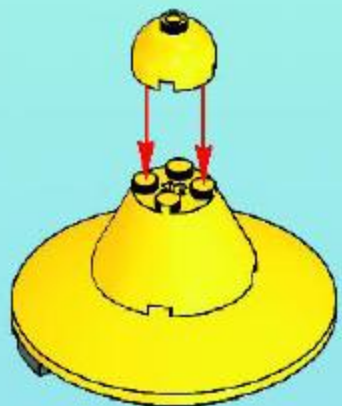

7

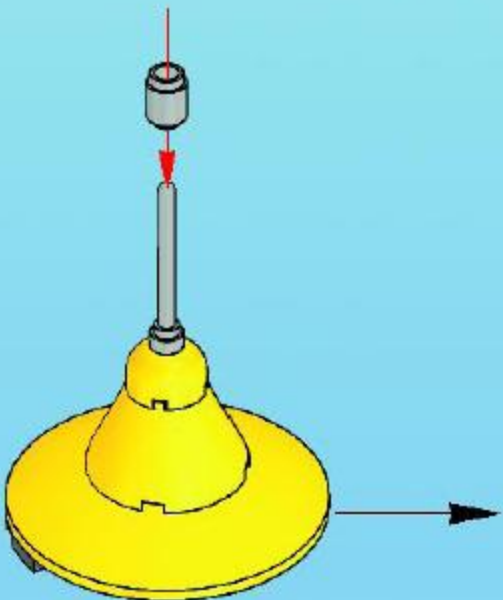

24

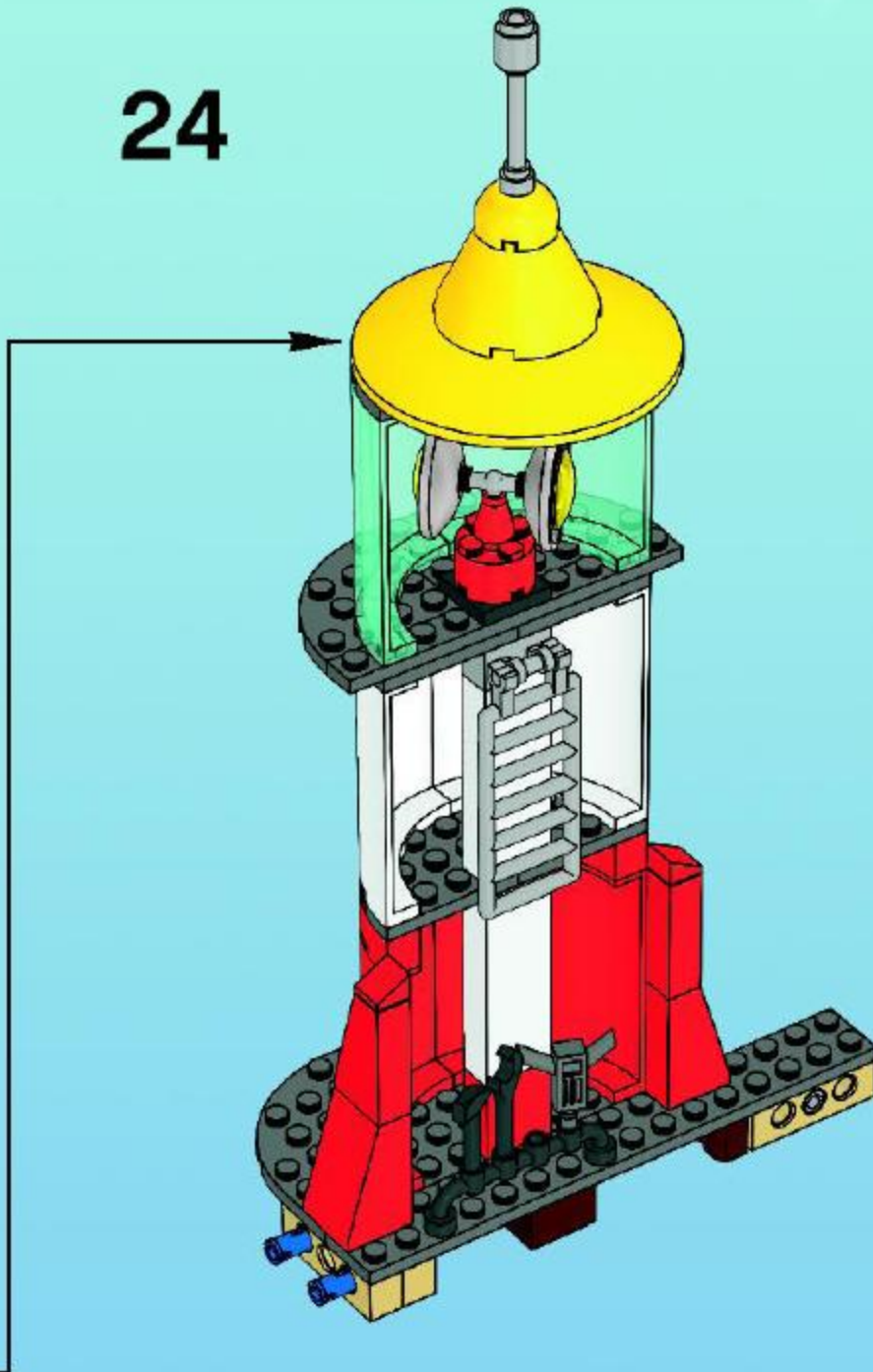





25

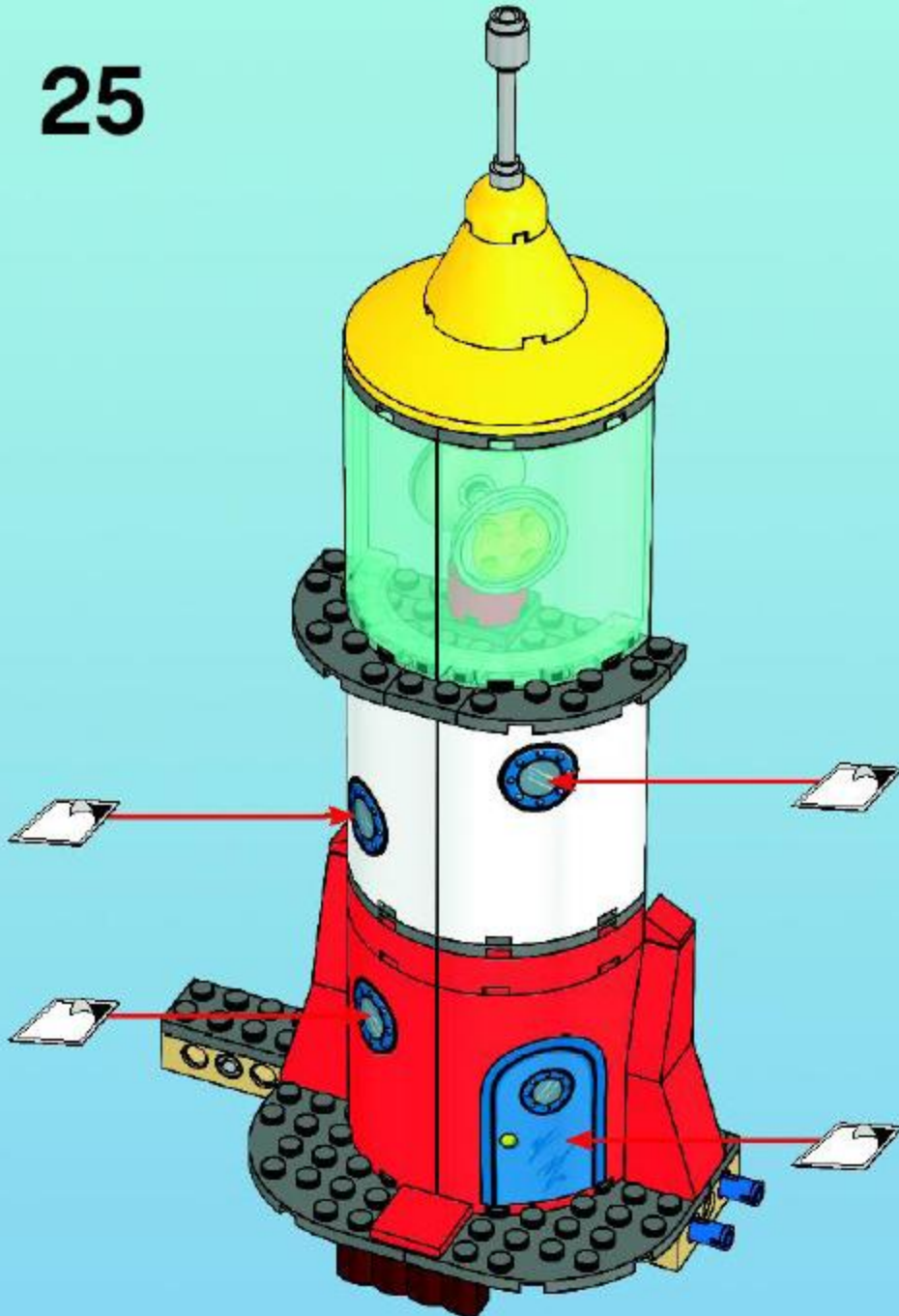

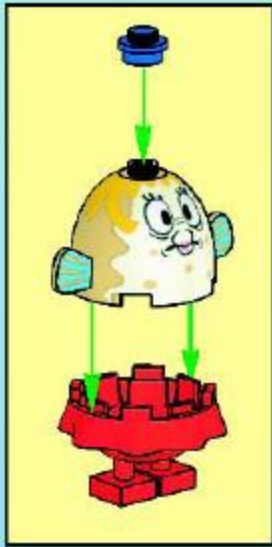
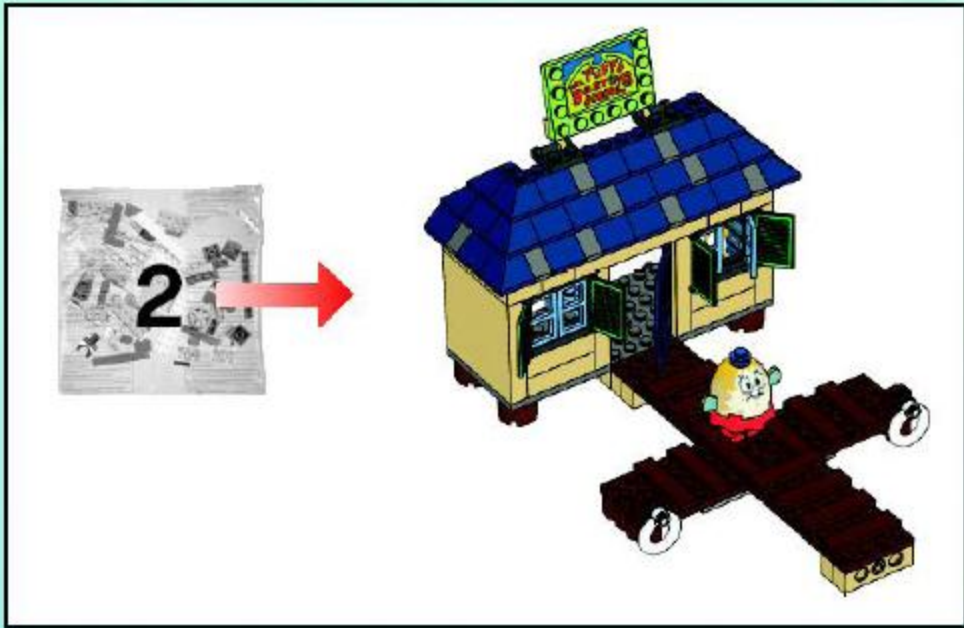

1

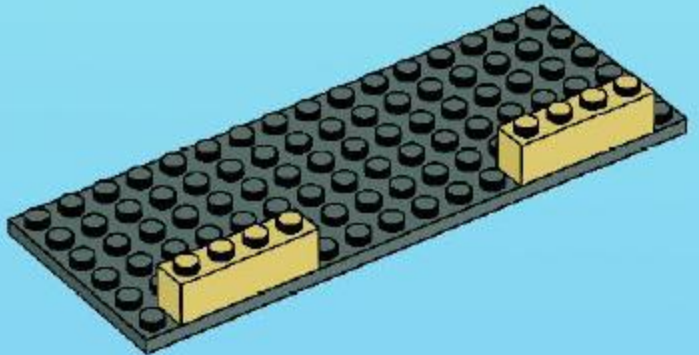

2

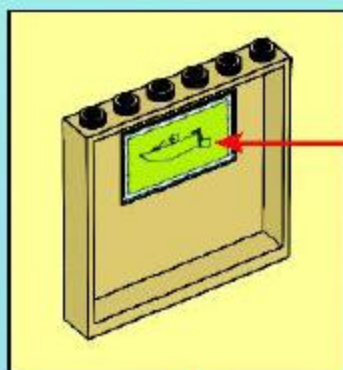
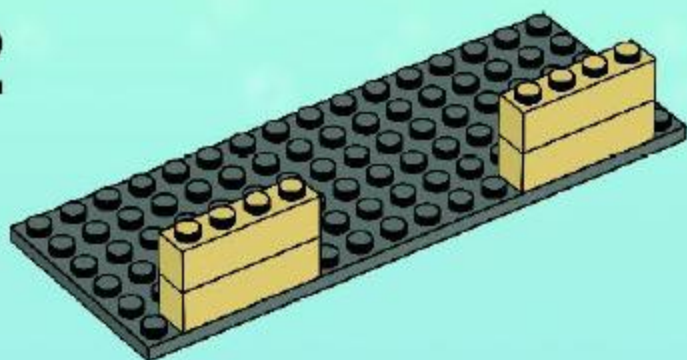

3

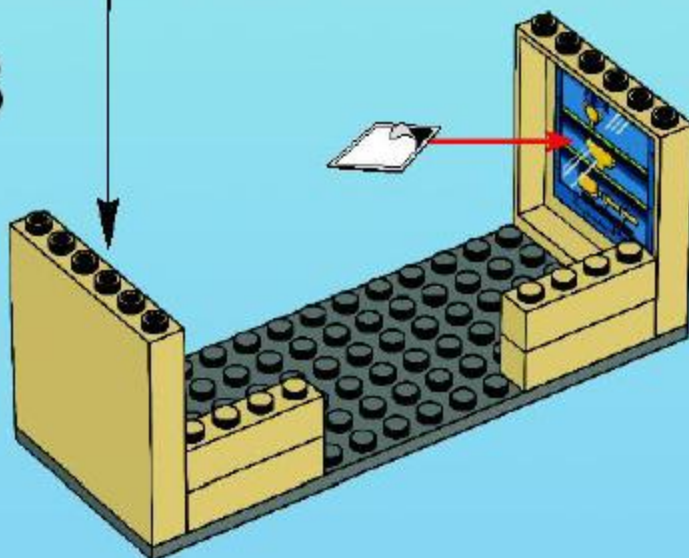

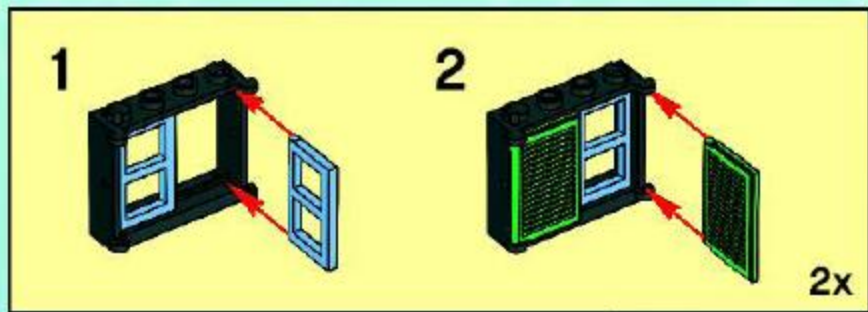

4

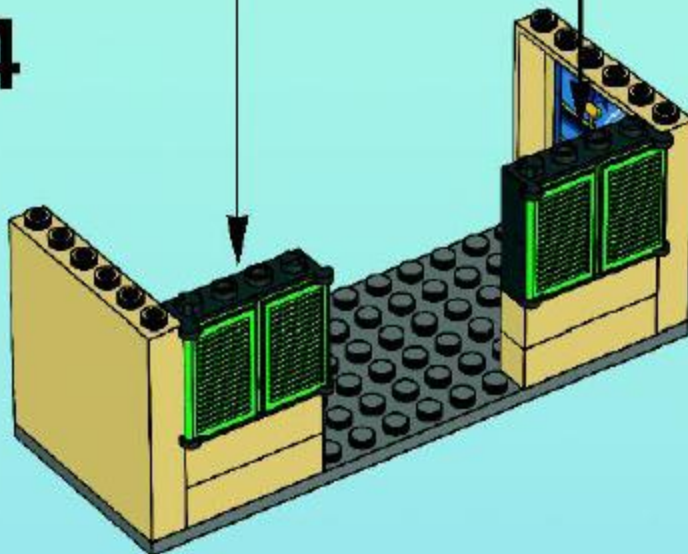

5

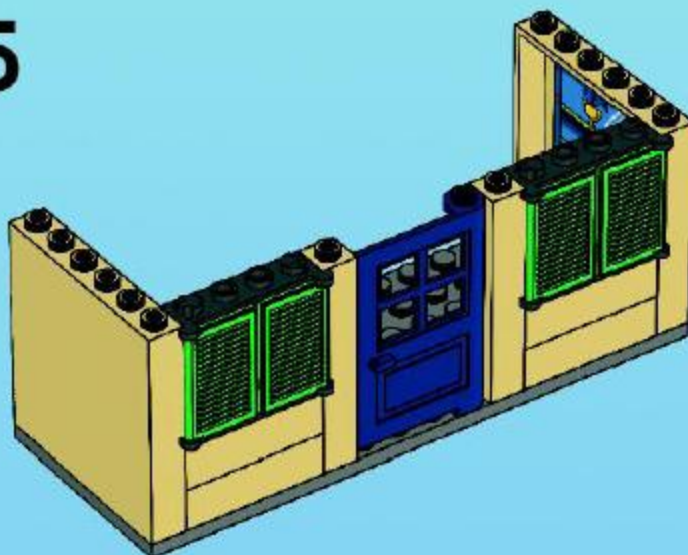

6

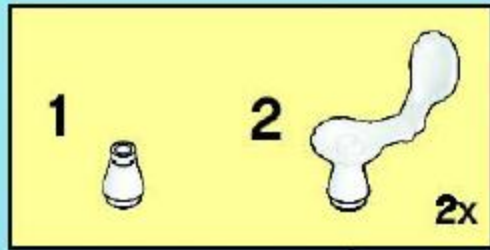
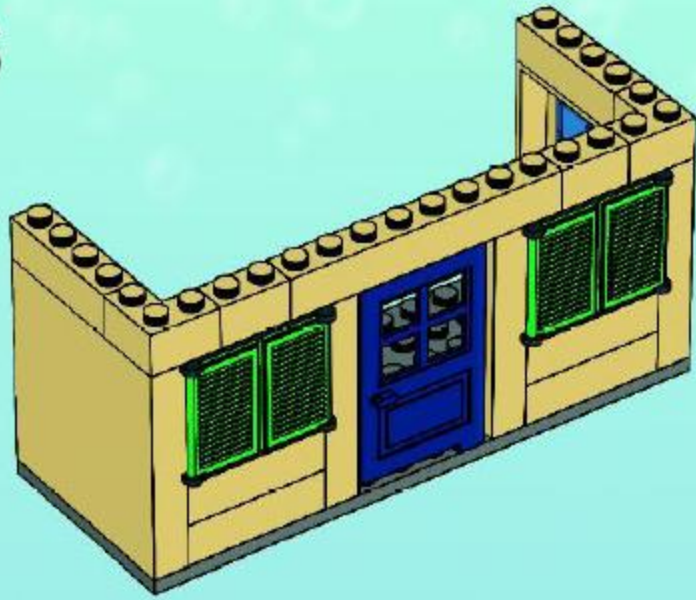

7

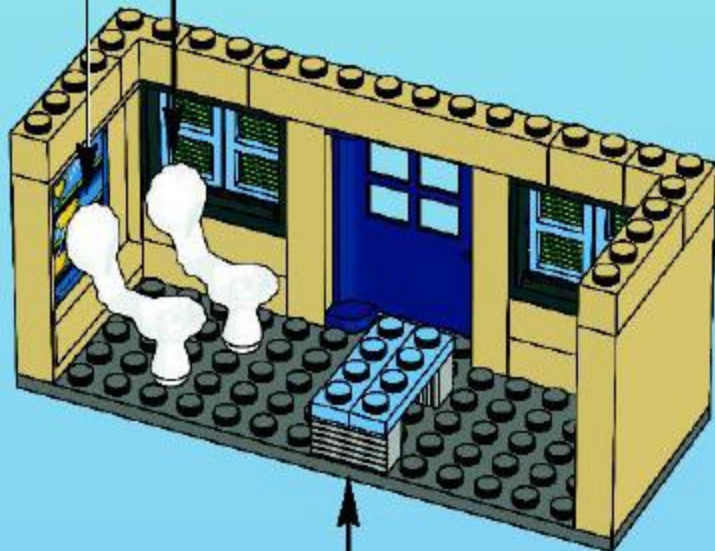
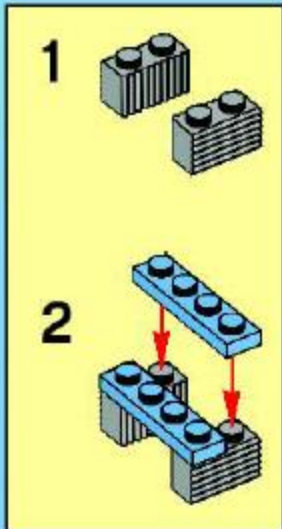

8

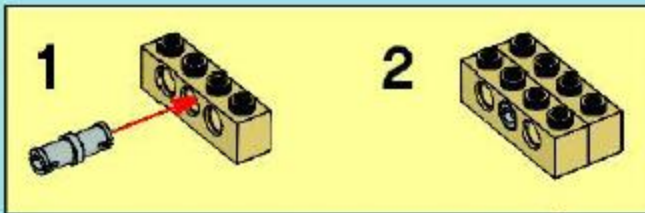

9

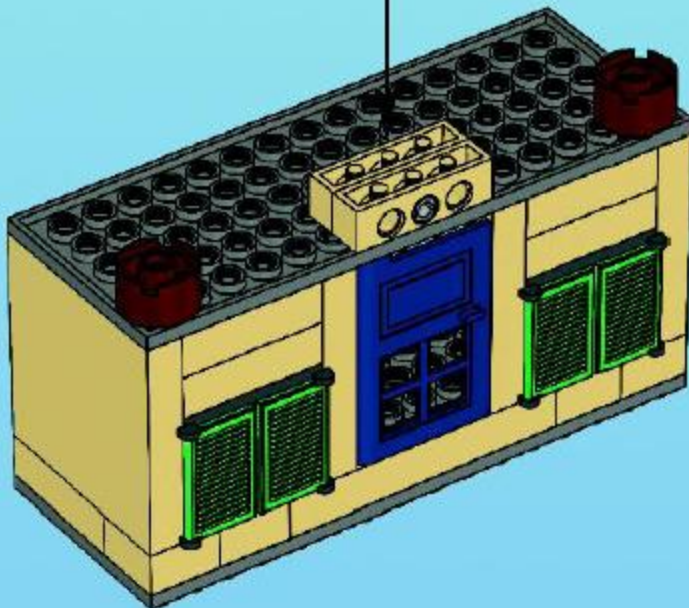

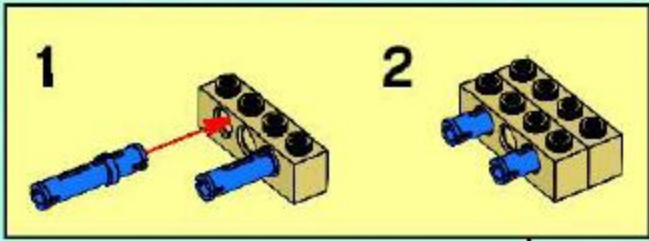

10

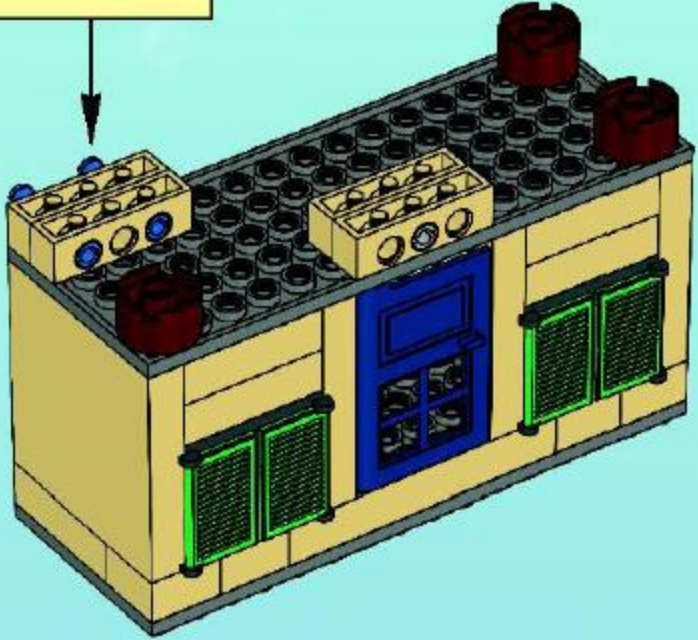

11

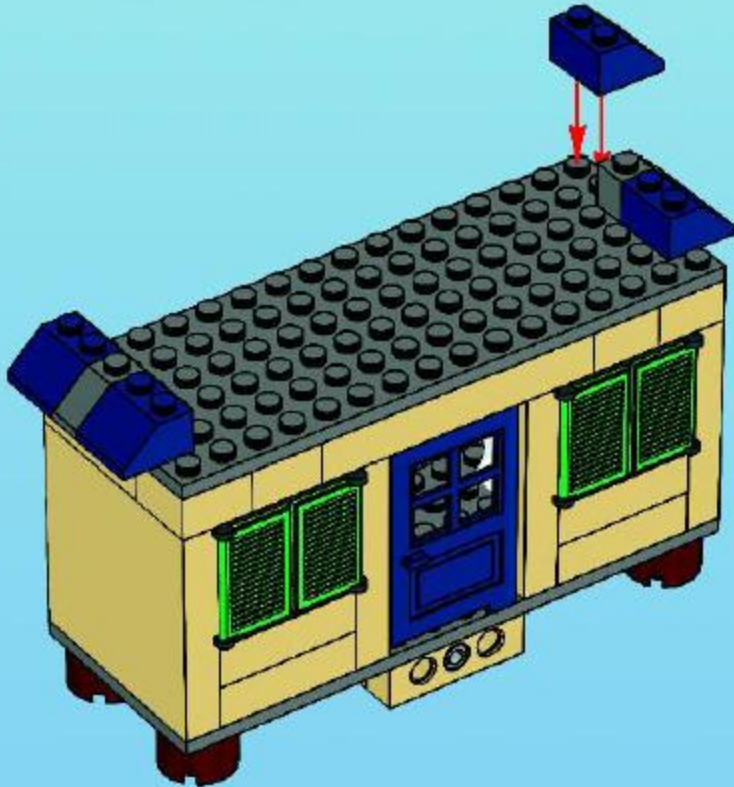

12

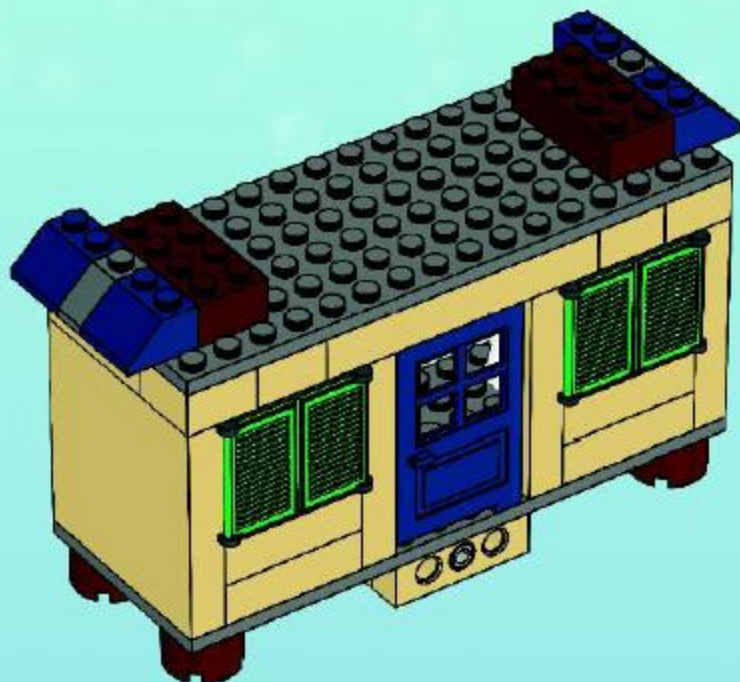

13

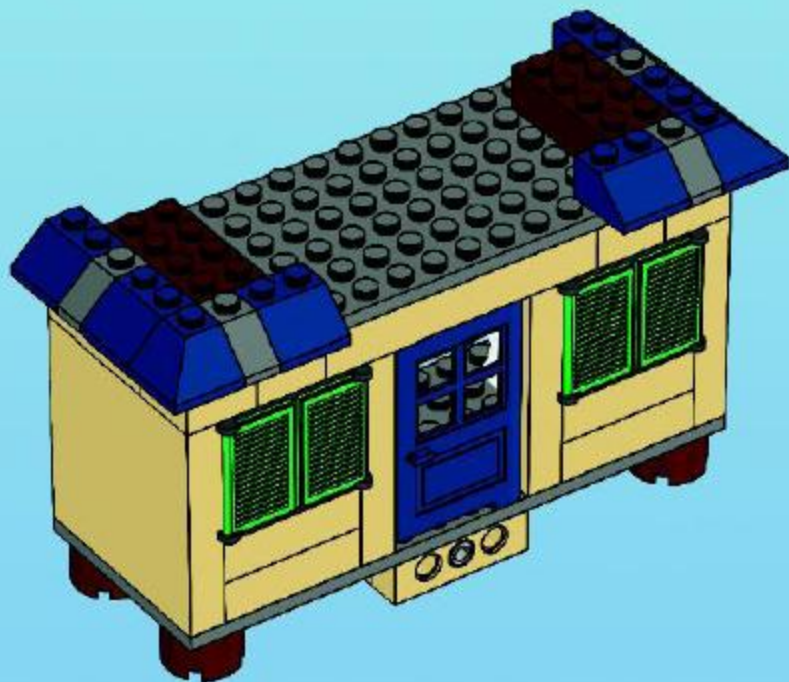



14

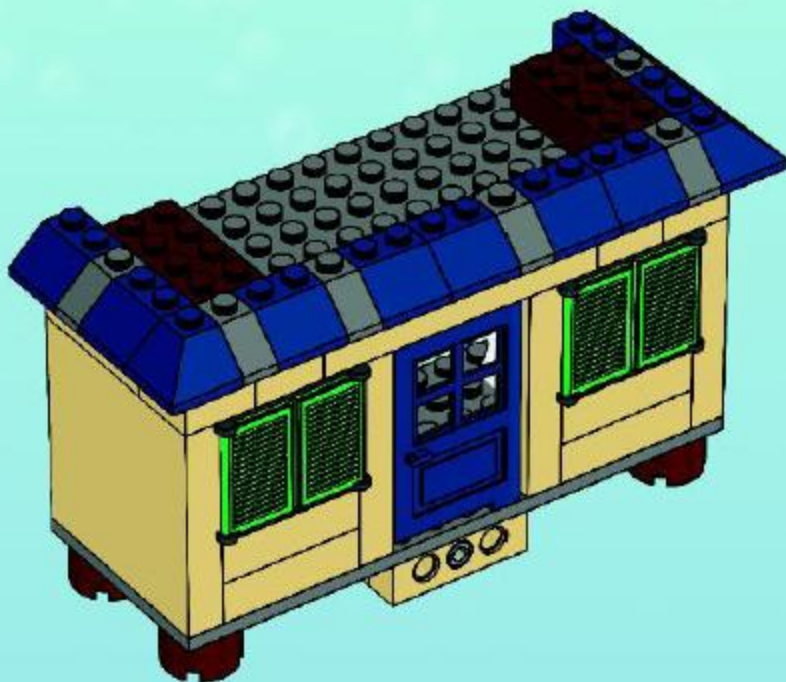

15

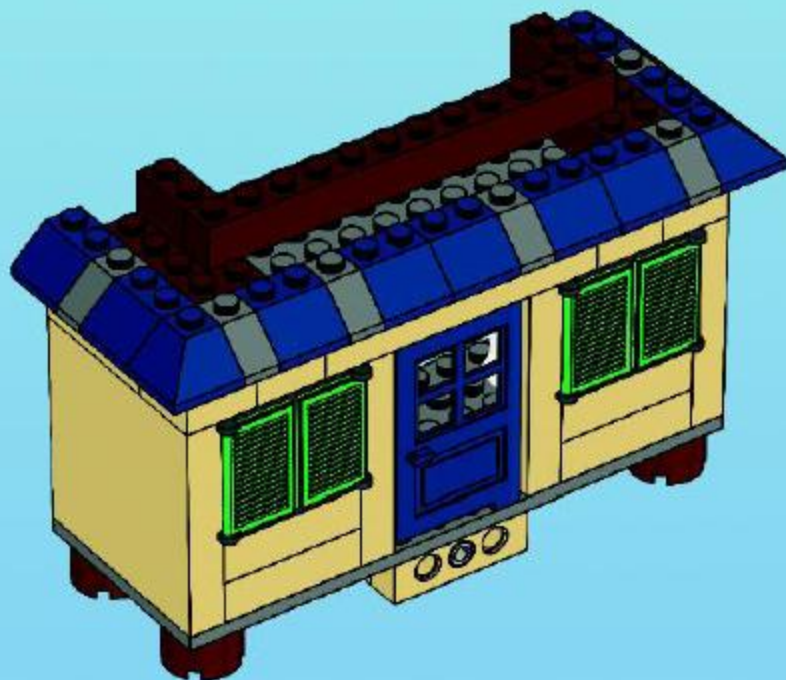

16

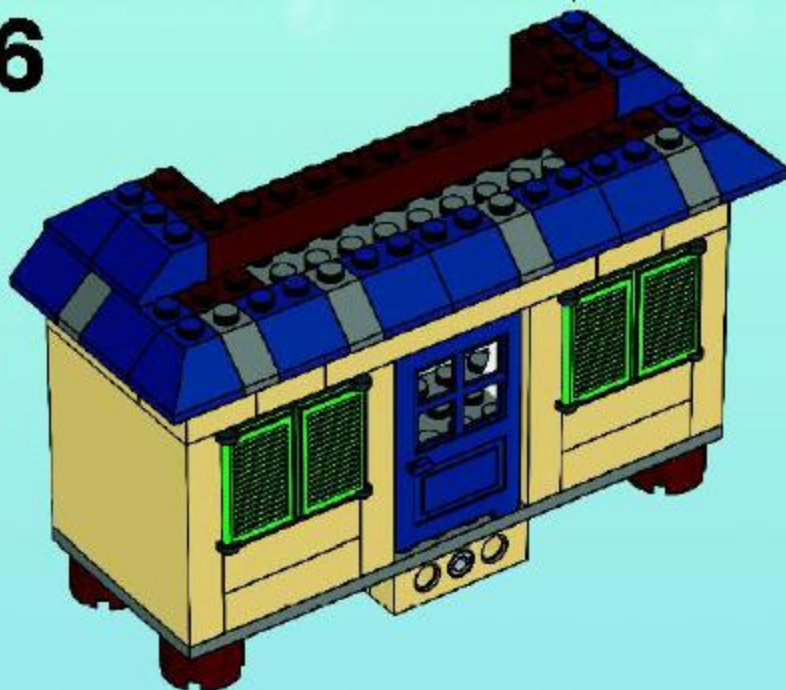

17

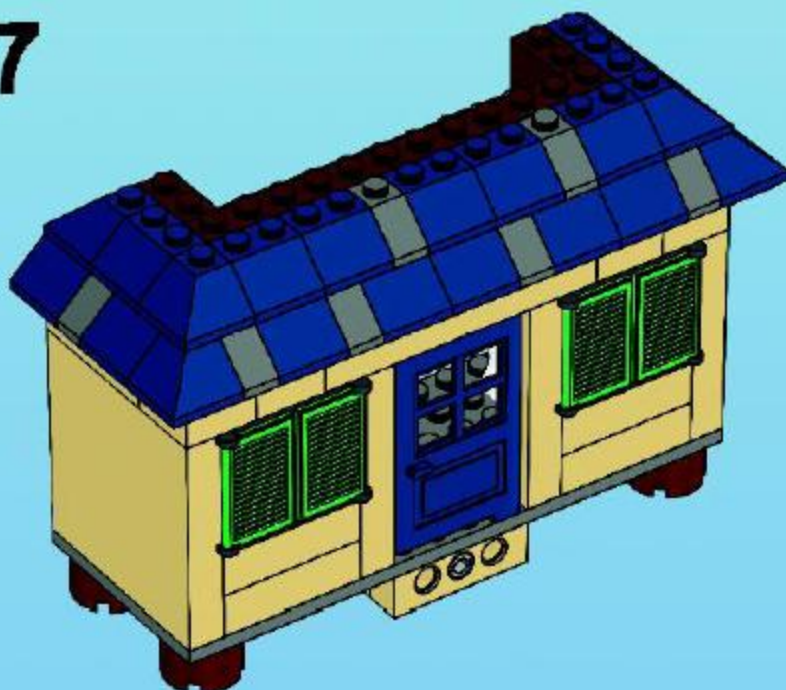

18



19



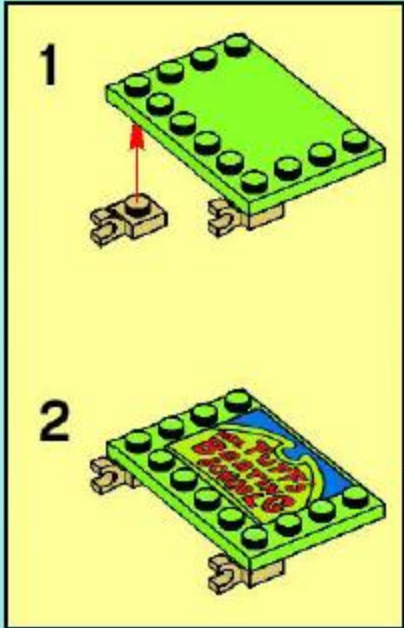

20

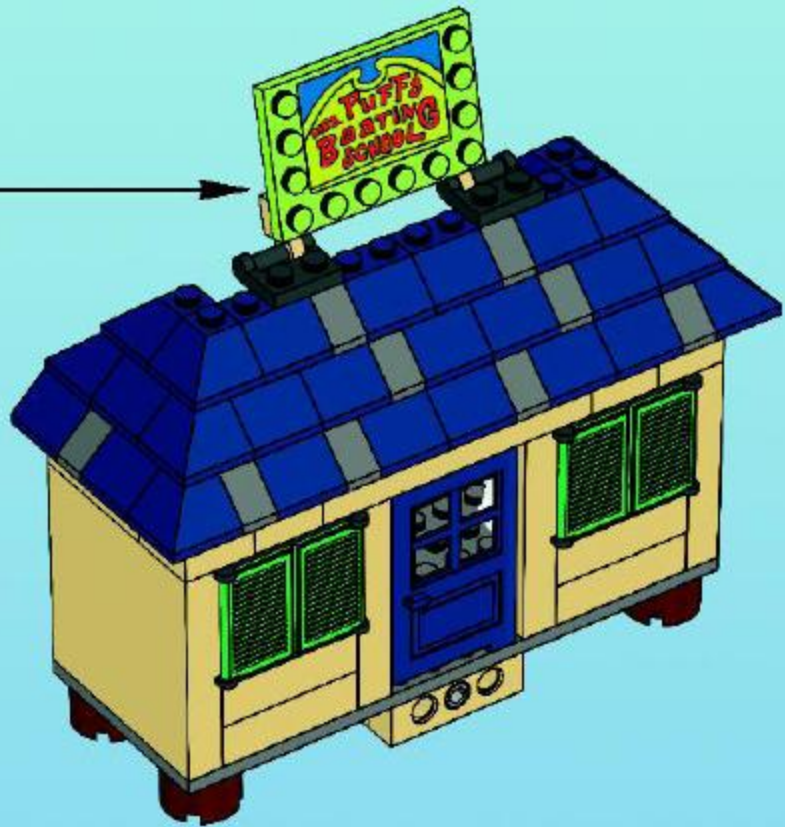

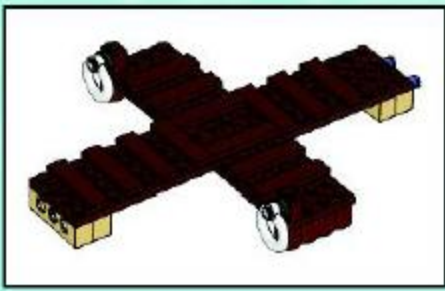

1

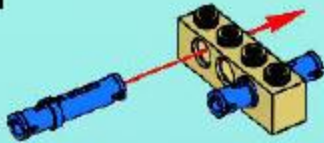

2



3



4

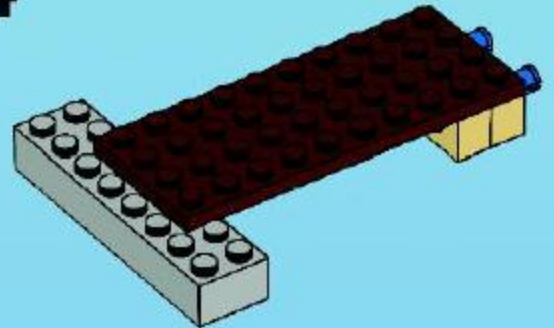

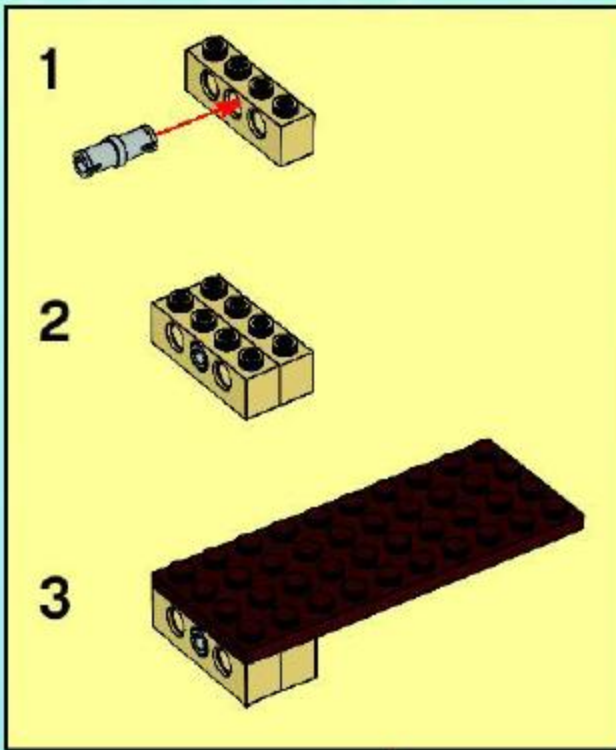

5

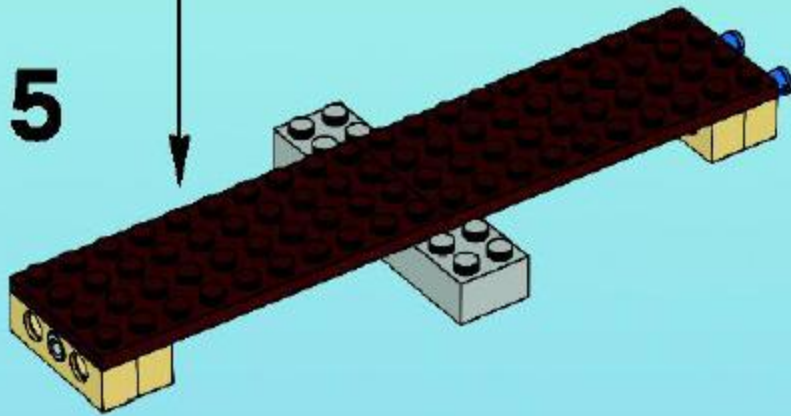

6

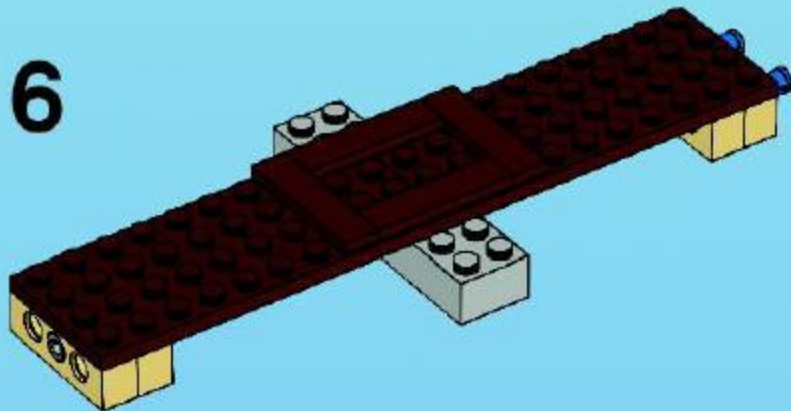

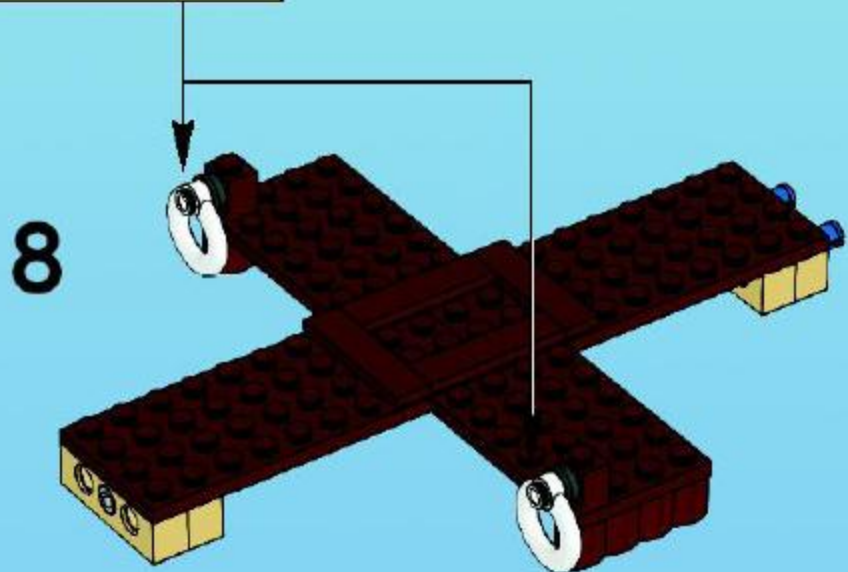
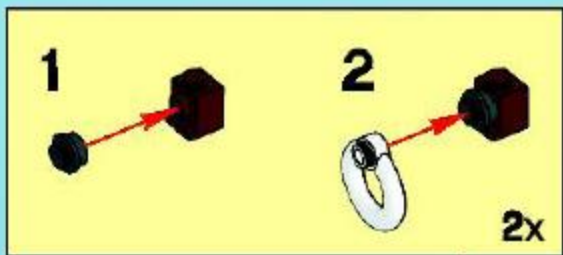
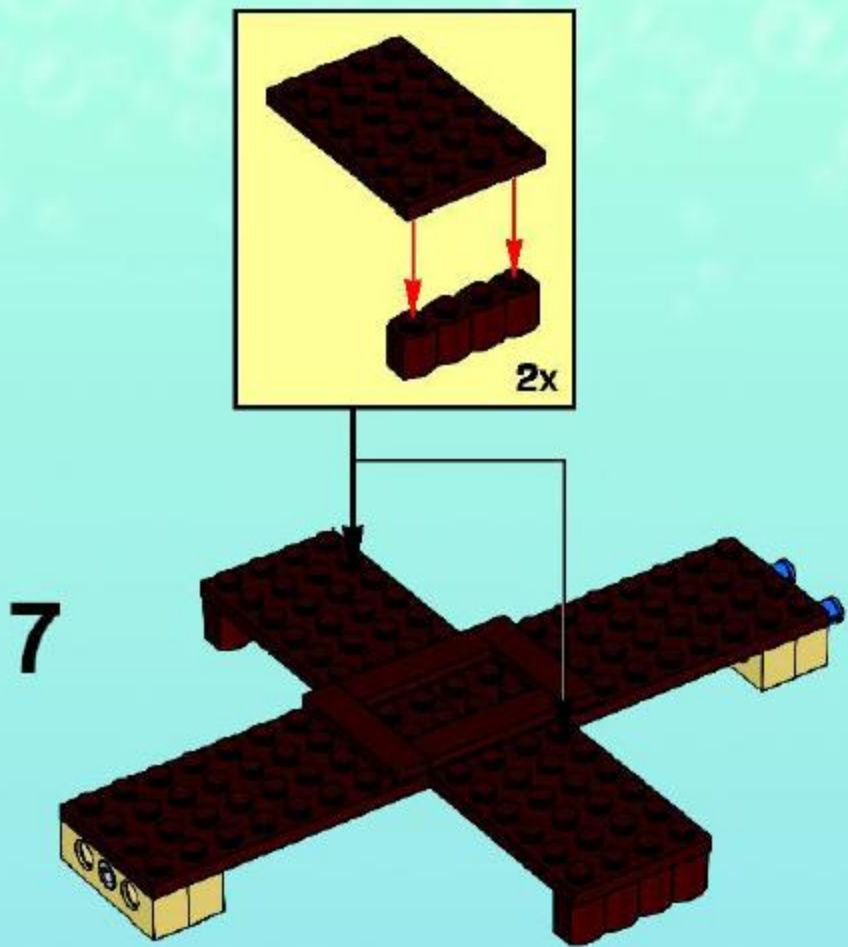

9

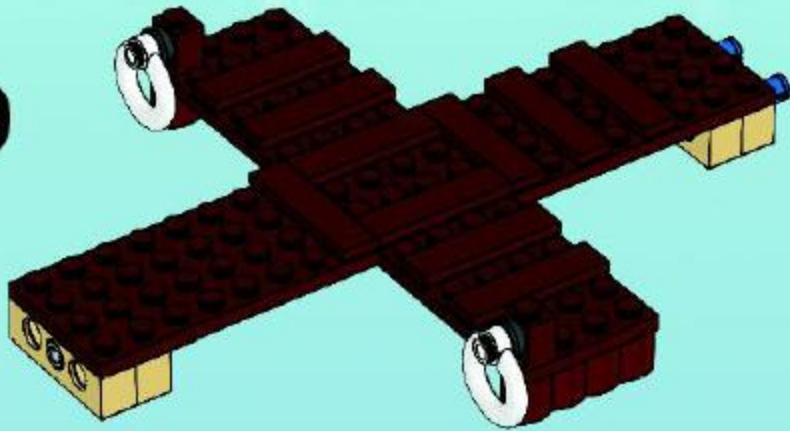

10

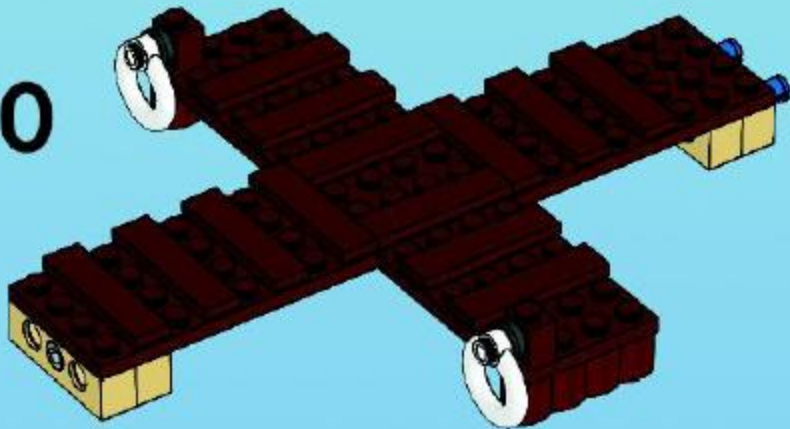



11

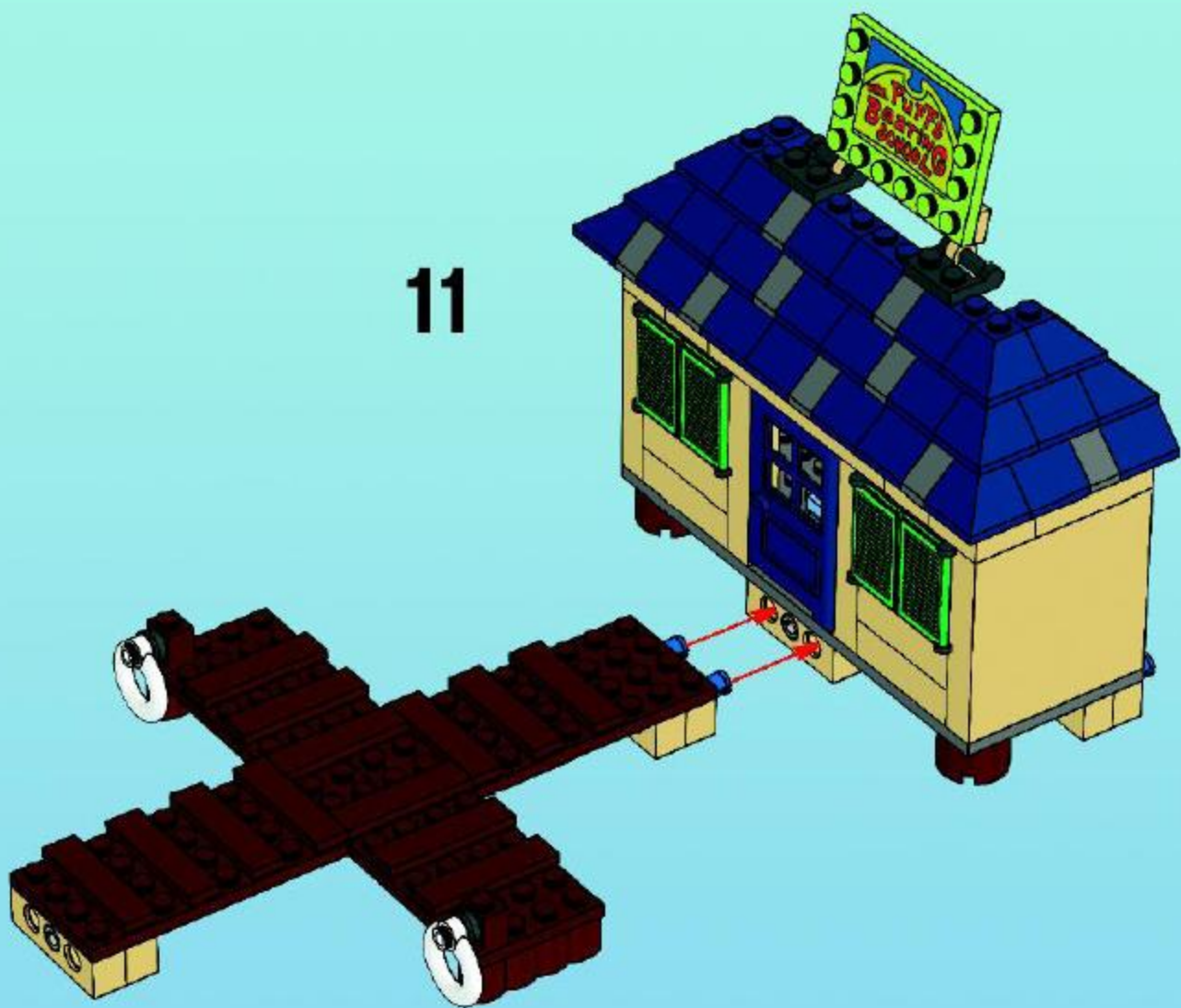

12

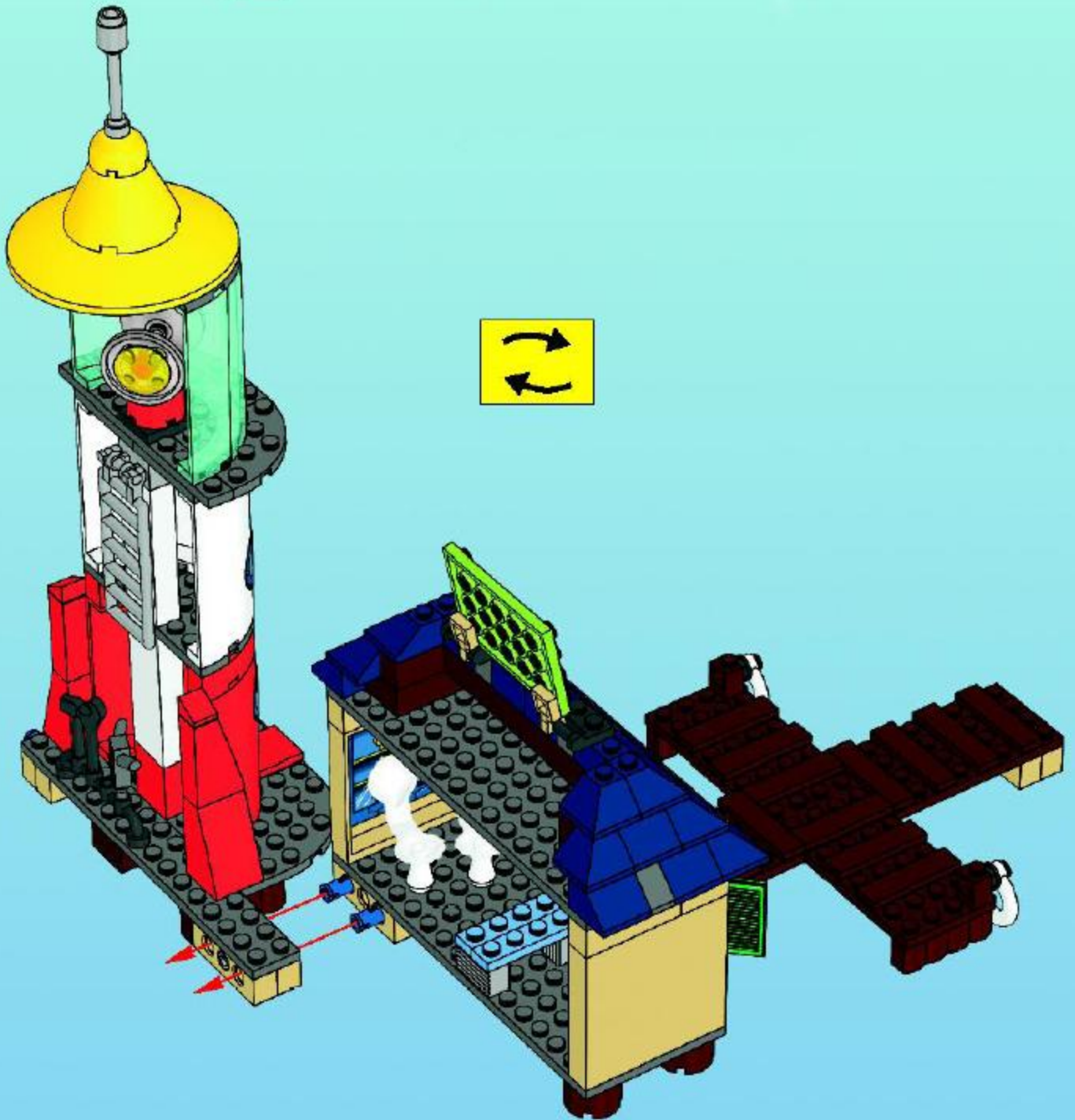

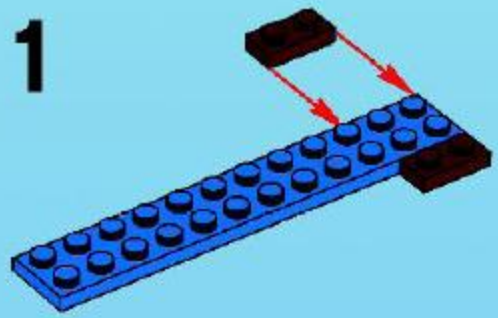
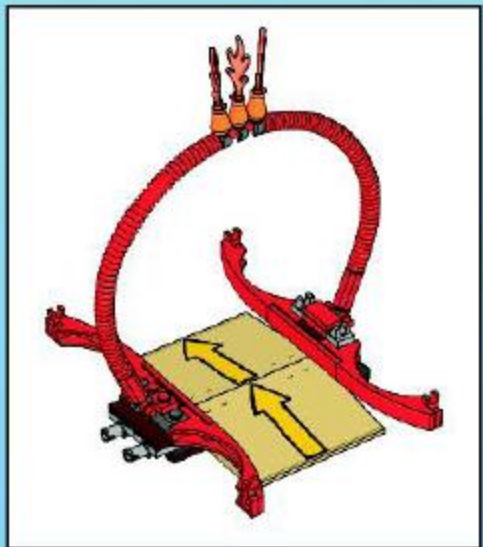
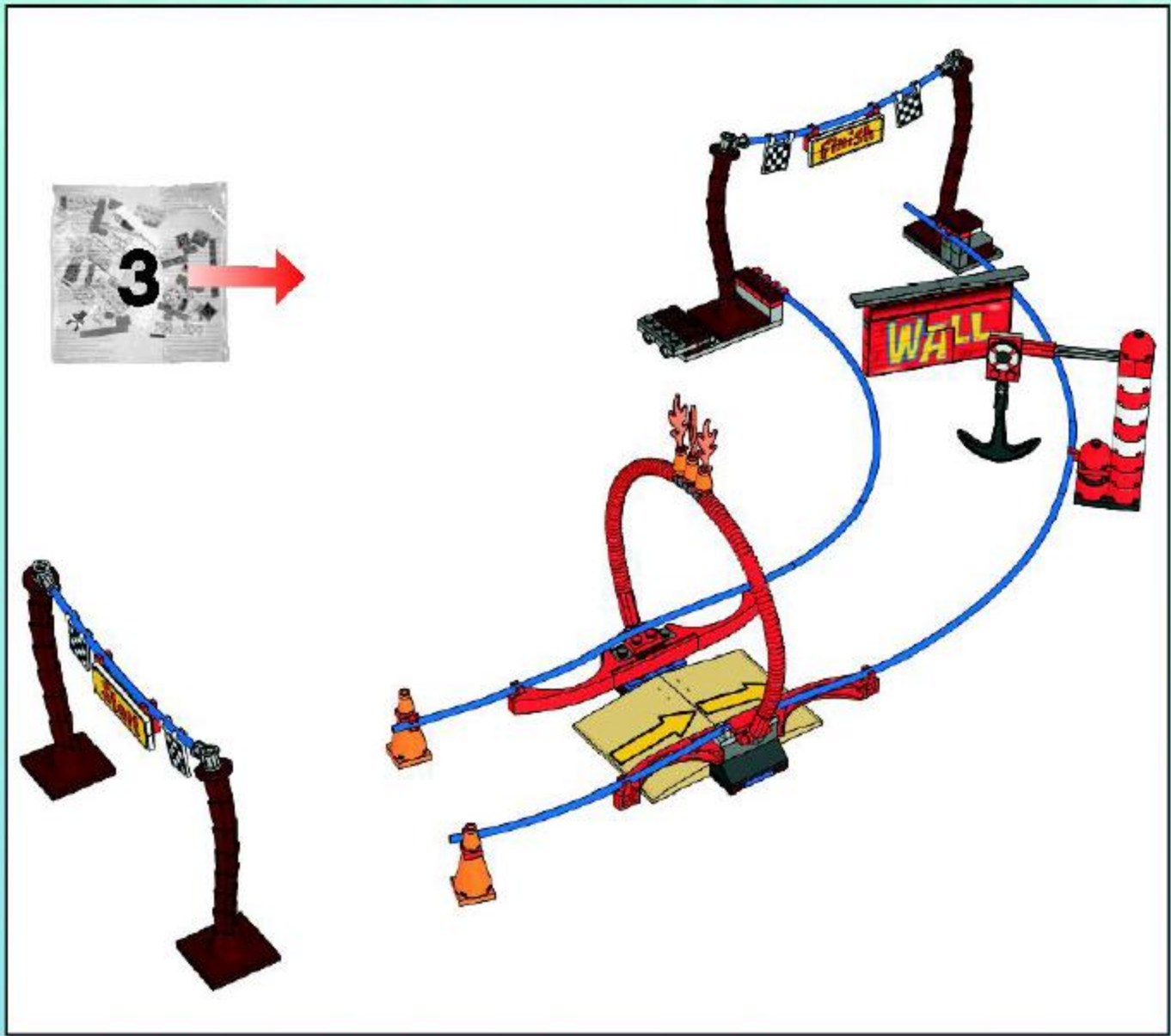

2

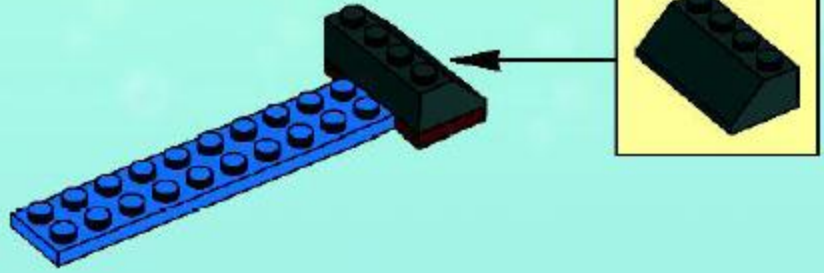

3

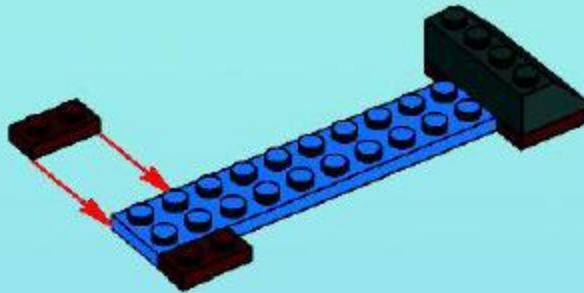

4

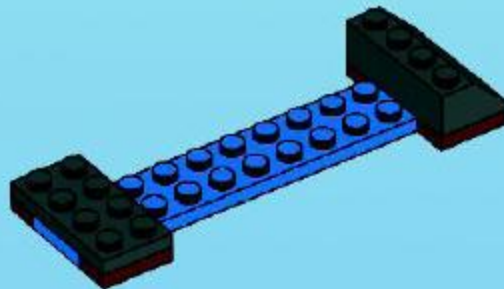

5

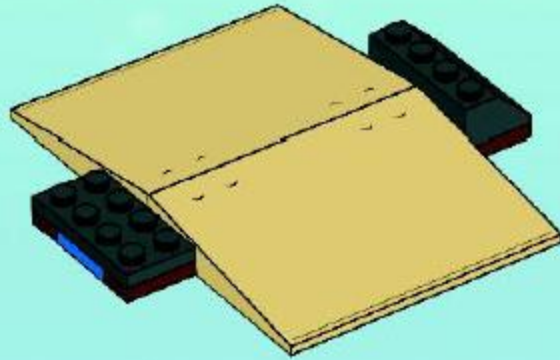

6

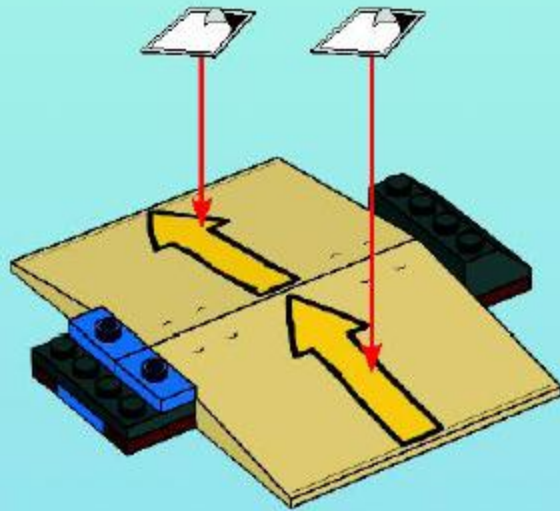

7

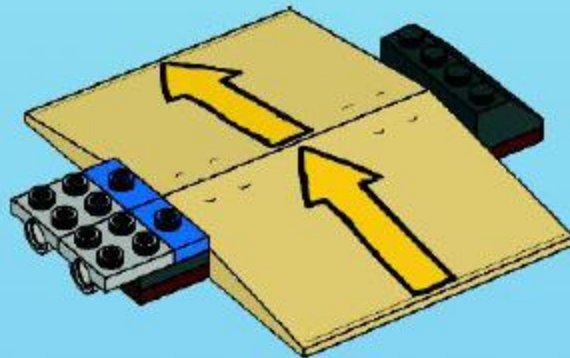

8

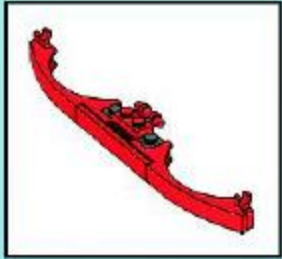
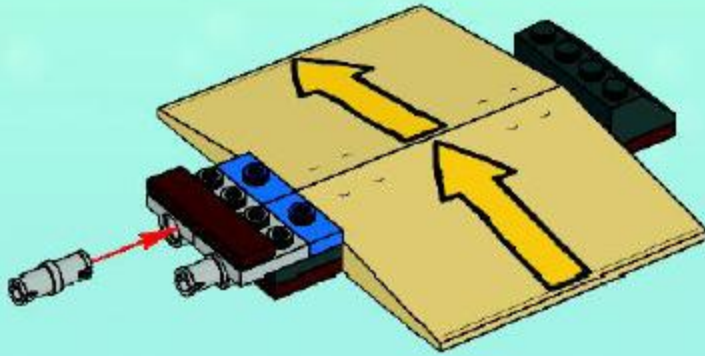

1

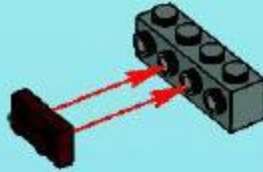

2

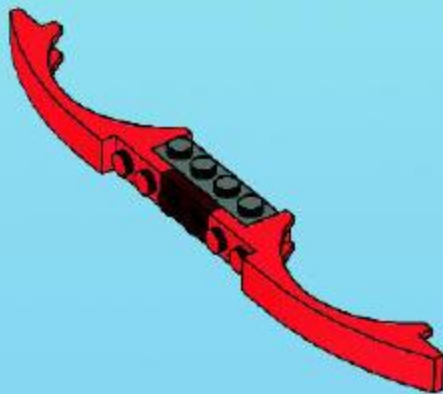

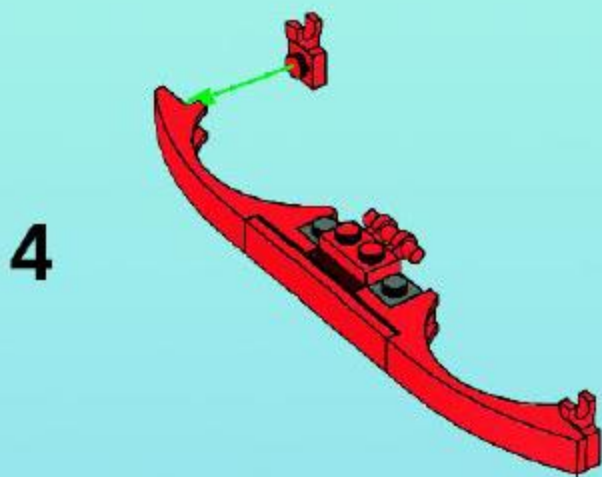
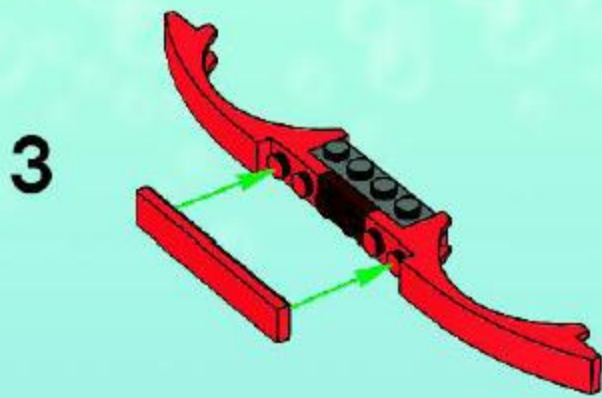

**2x**

**9**

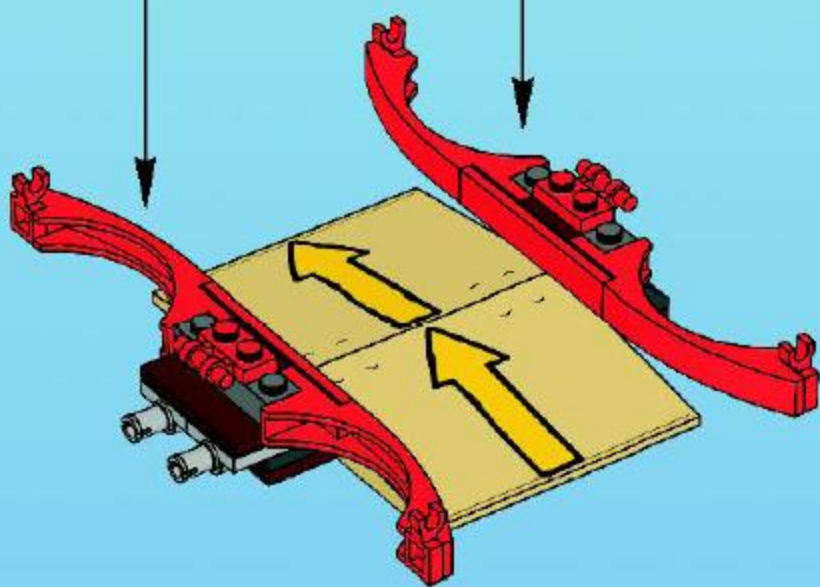

10

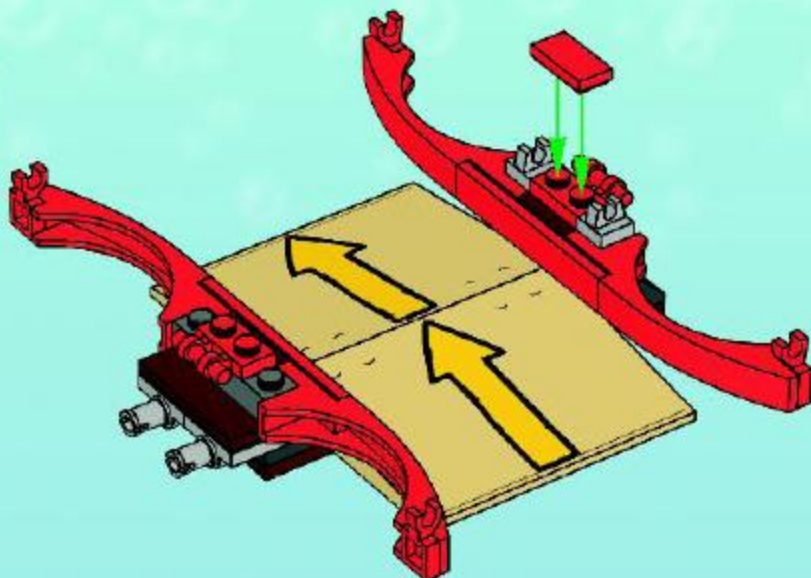

1

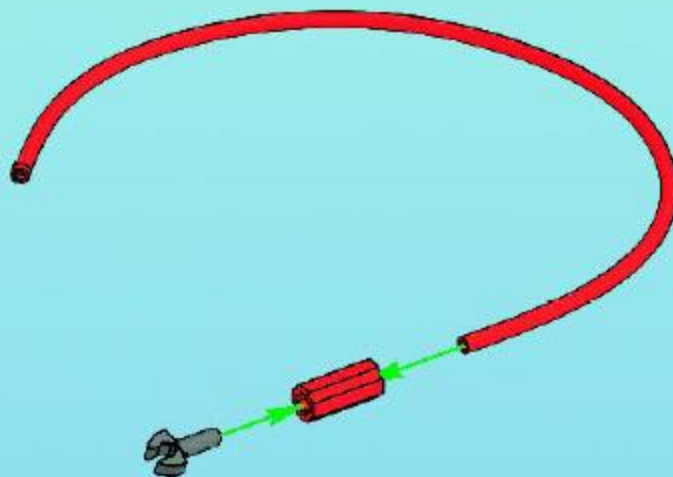

2

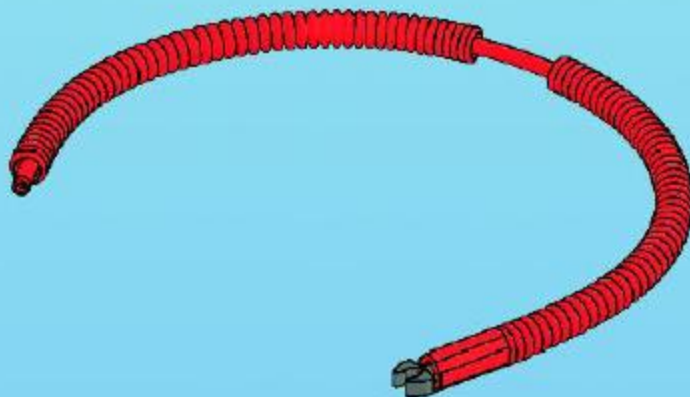



3

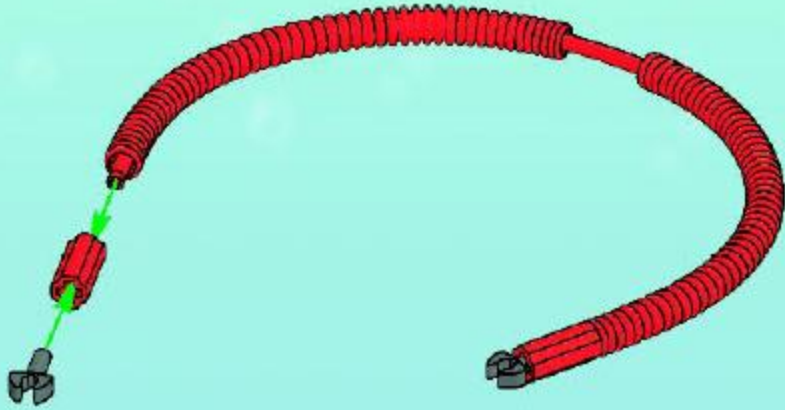

11

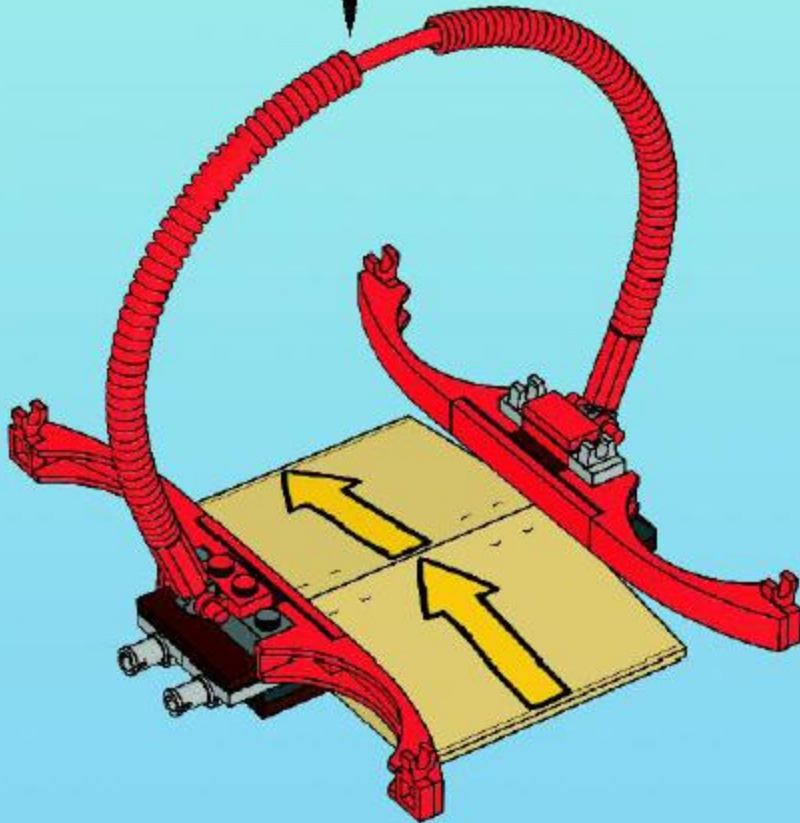

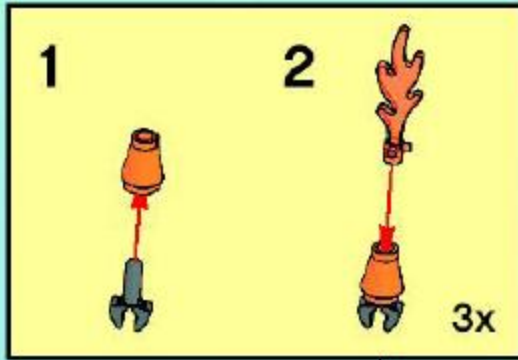

12

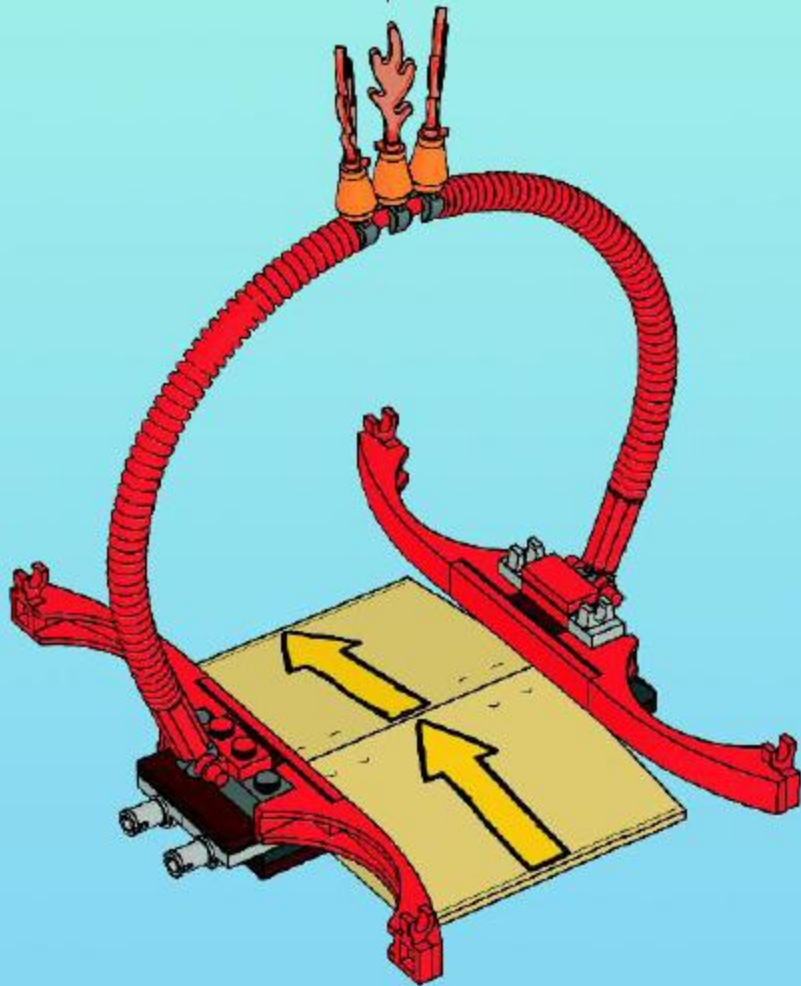

13



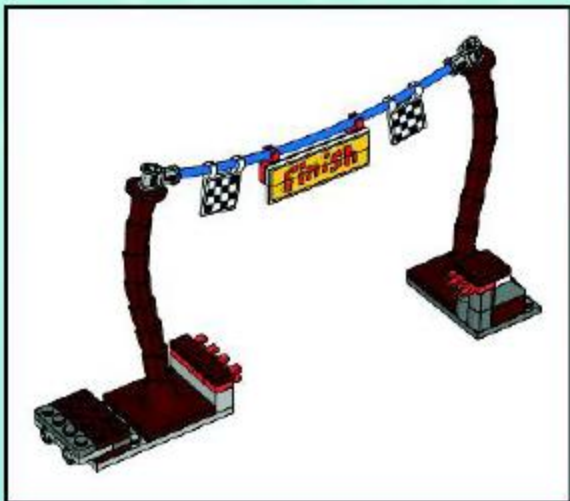

1



2



3

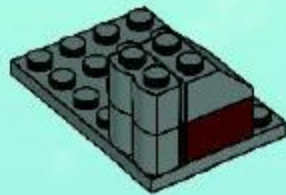

4

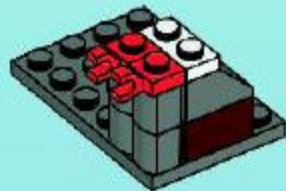

5



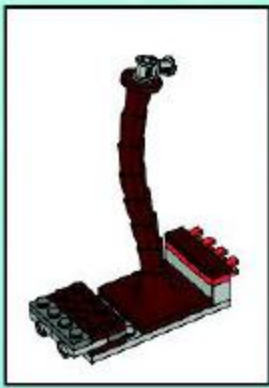

1



2



3

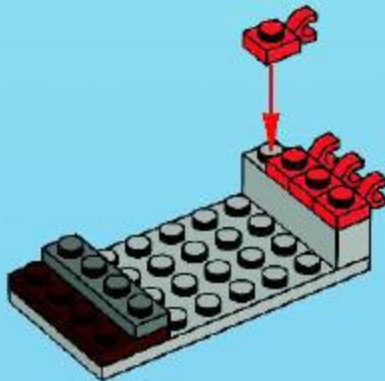

4

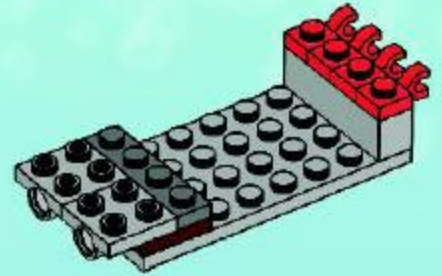

5

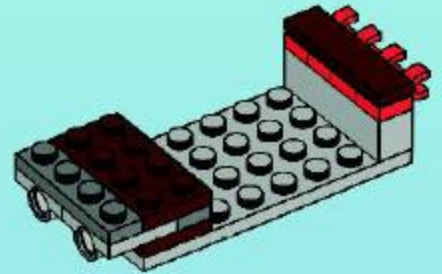

6

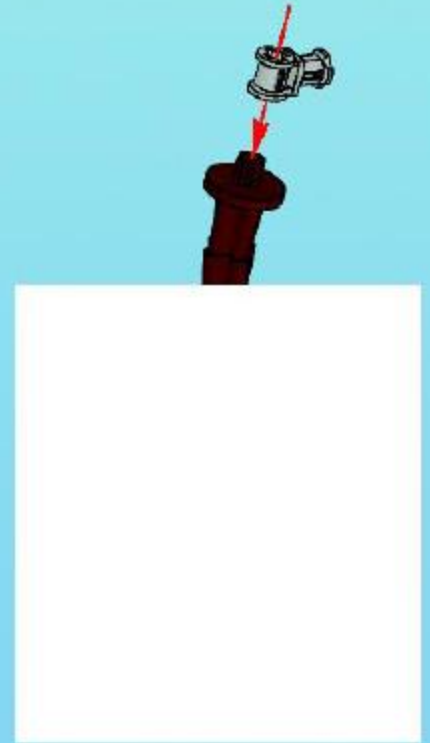

7

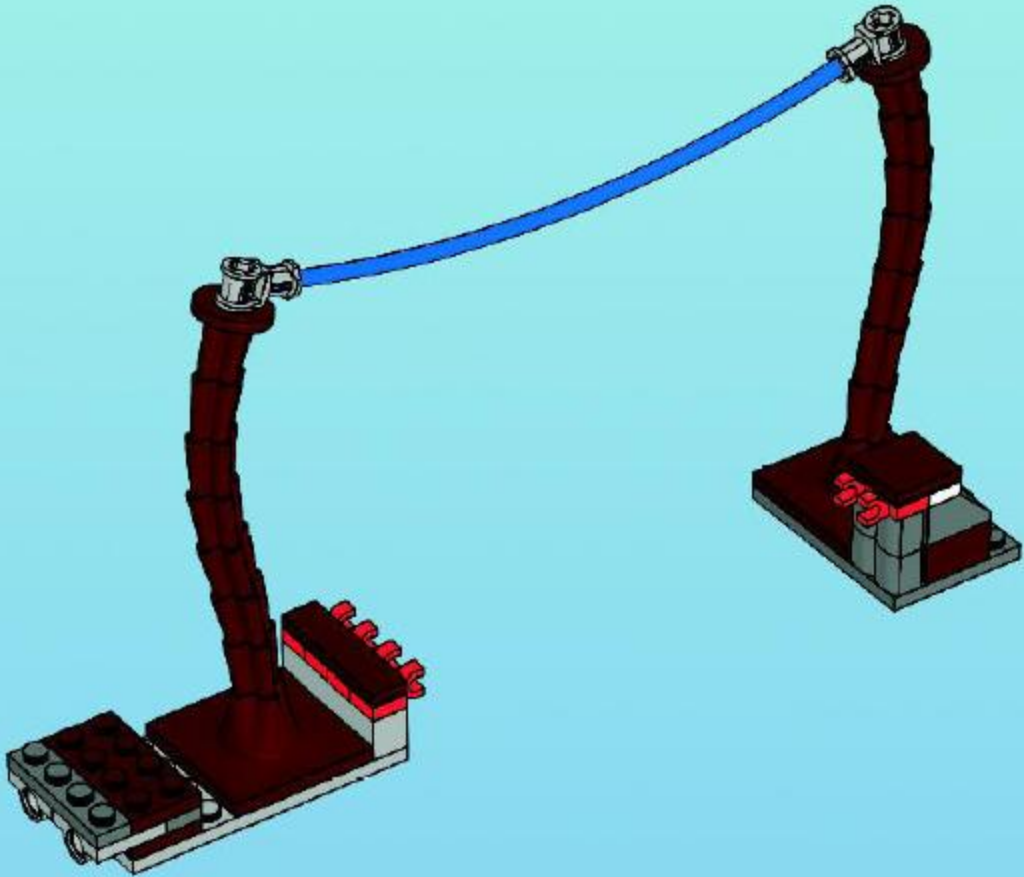

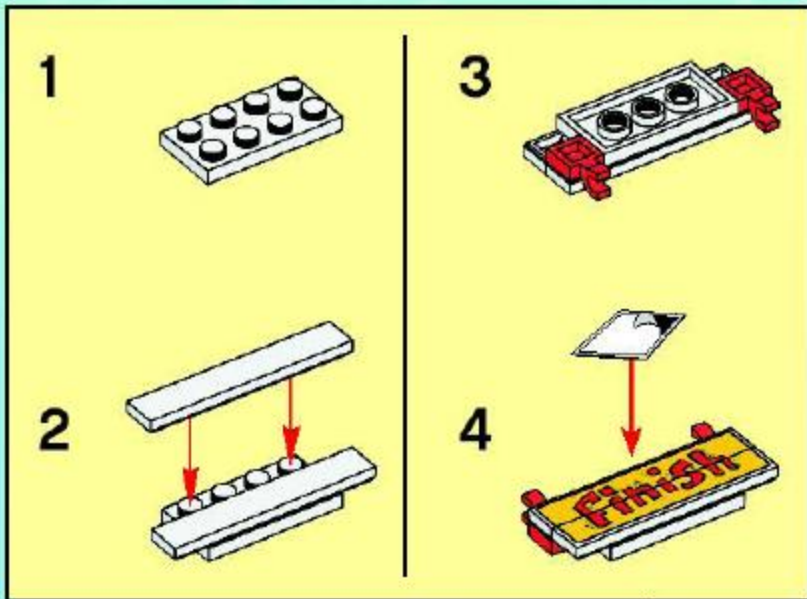

8

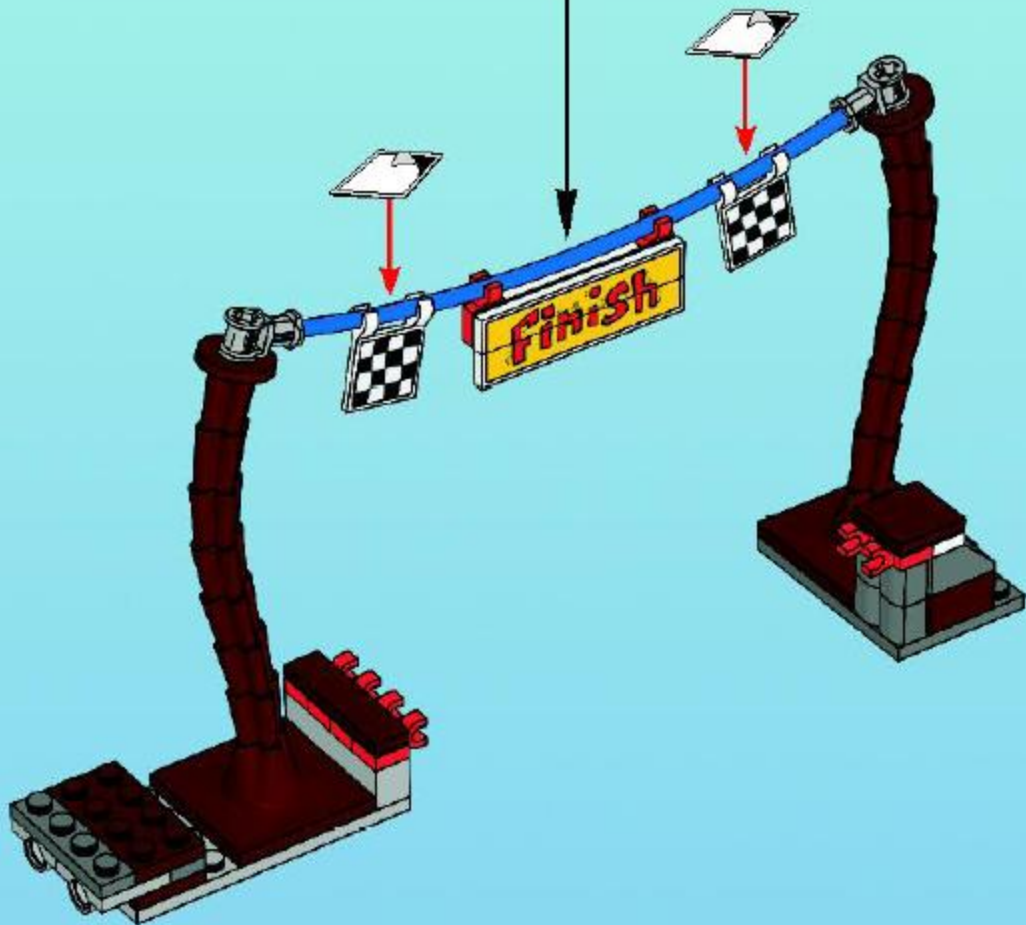

9

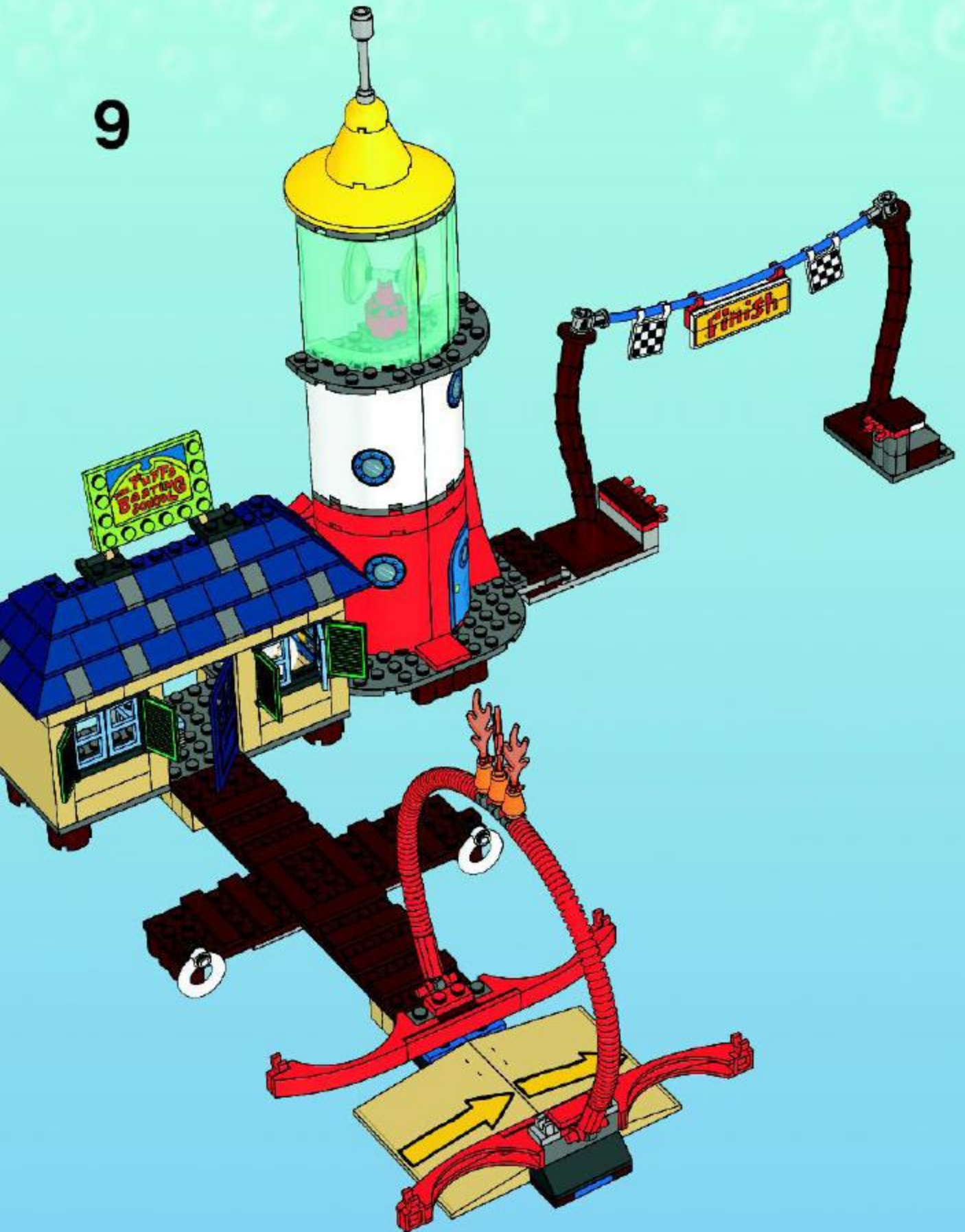



10



11



1

2

3

2x

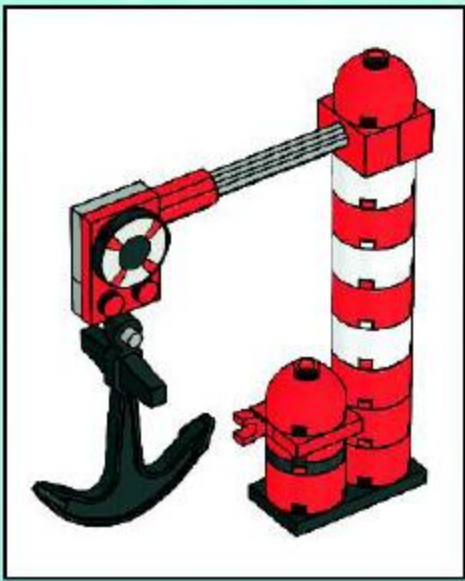

1



2

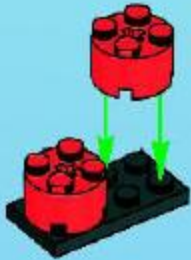

3



4



5

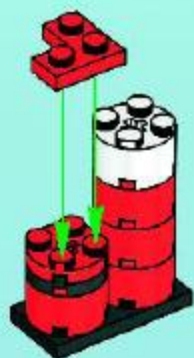

7



6



8



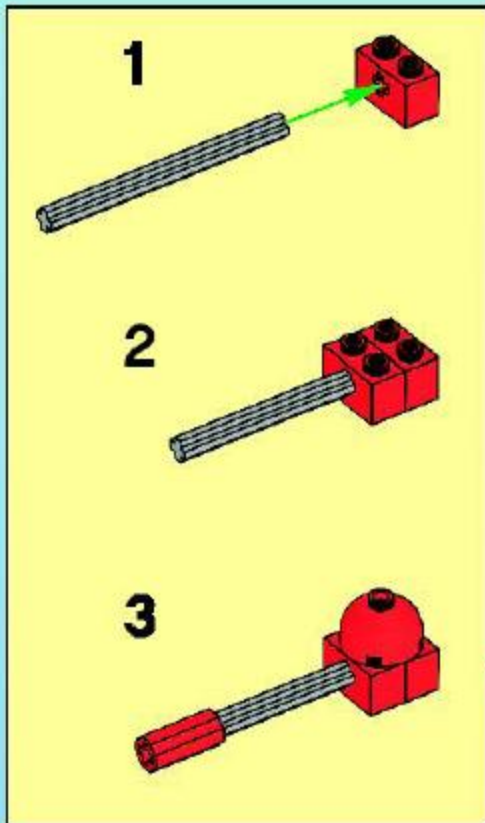

9



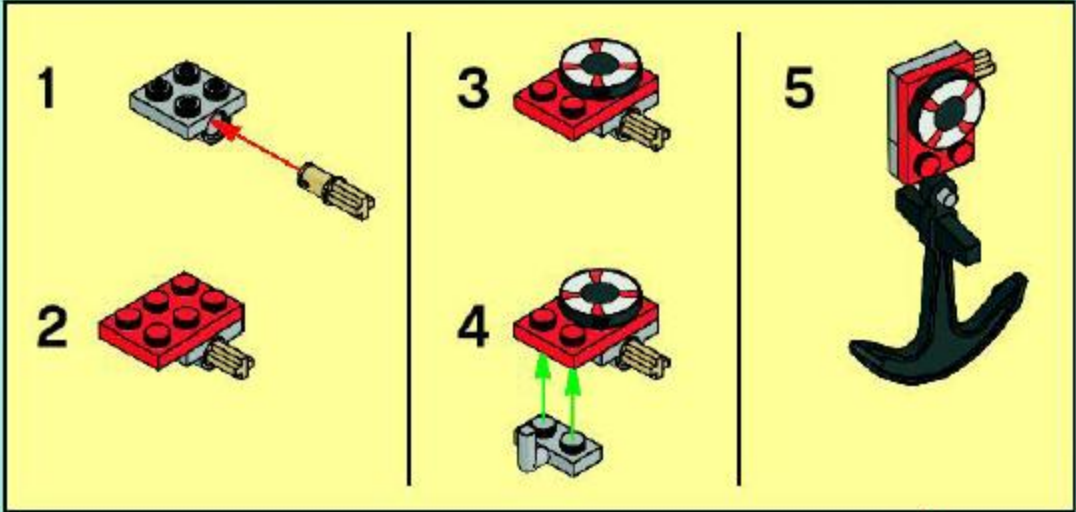

10





1

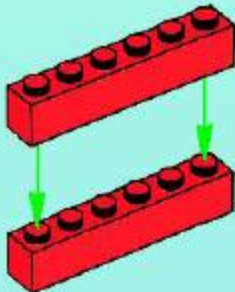

2

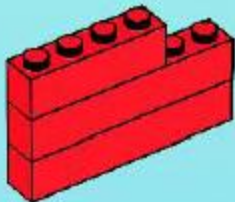

3

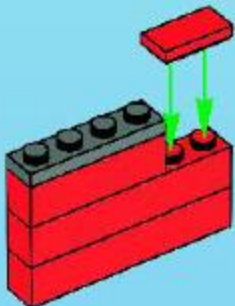

4

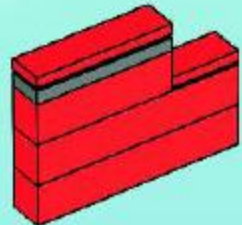

5



1

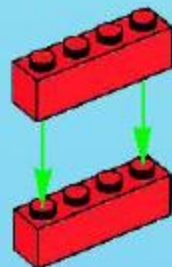

2



3

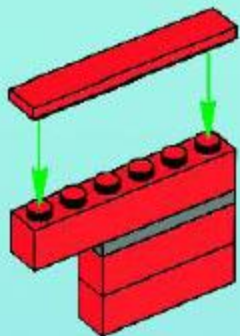

4

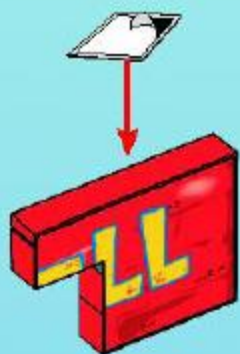

5

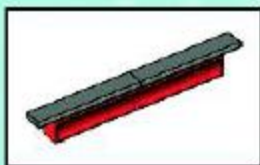

6

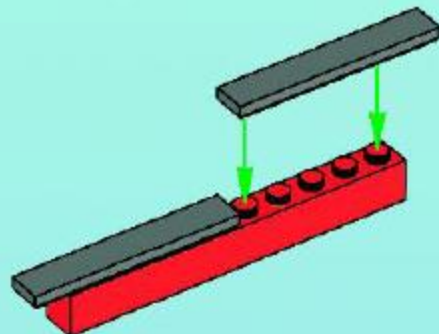

7

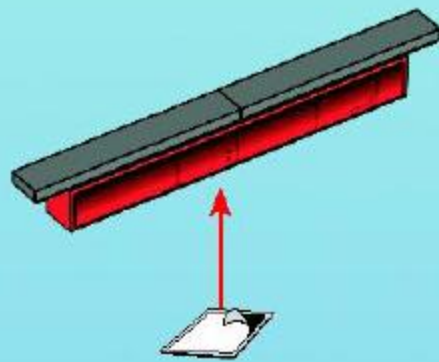

8







1

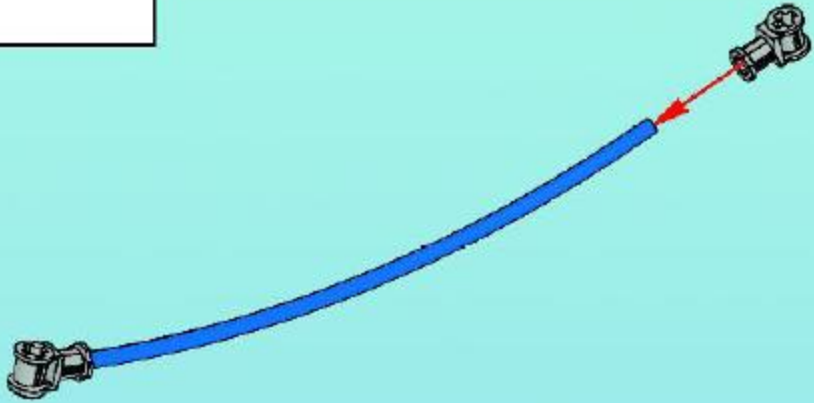

2

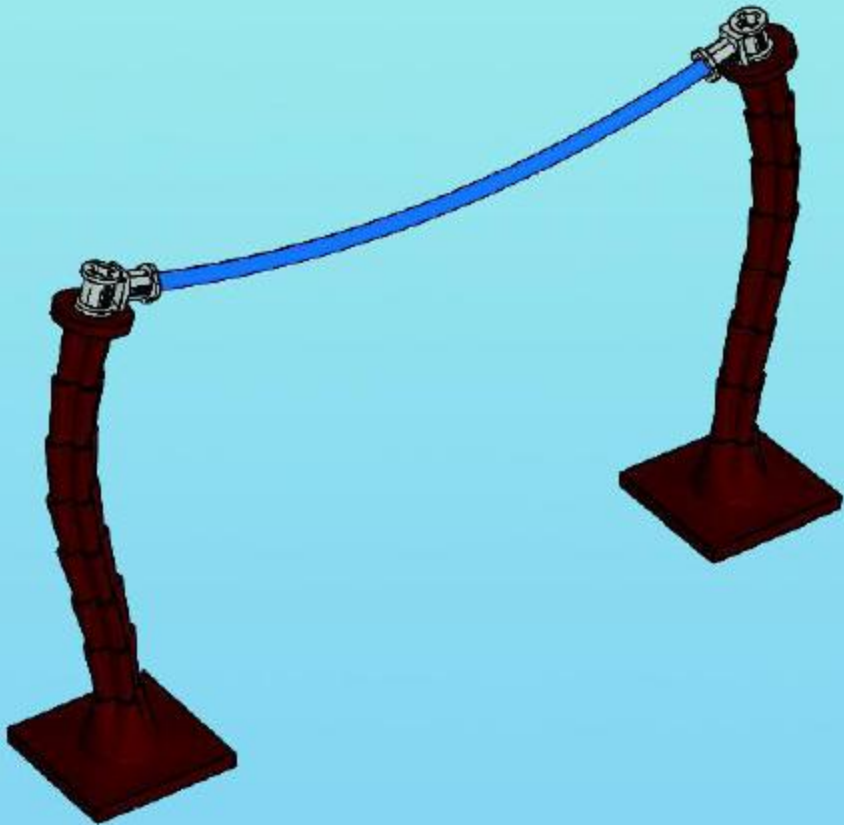

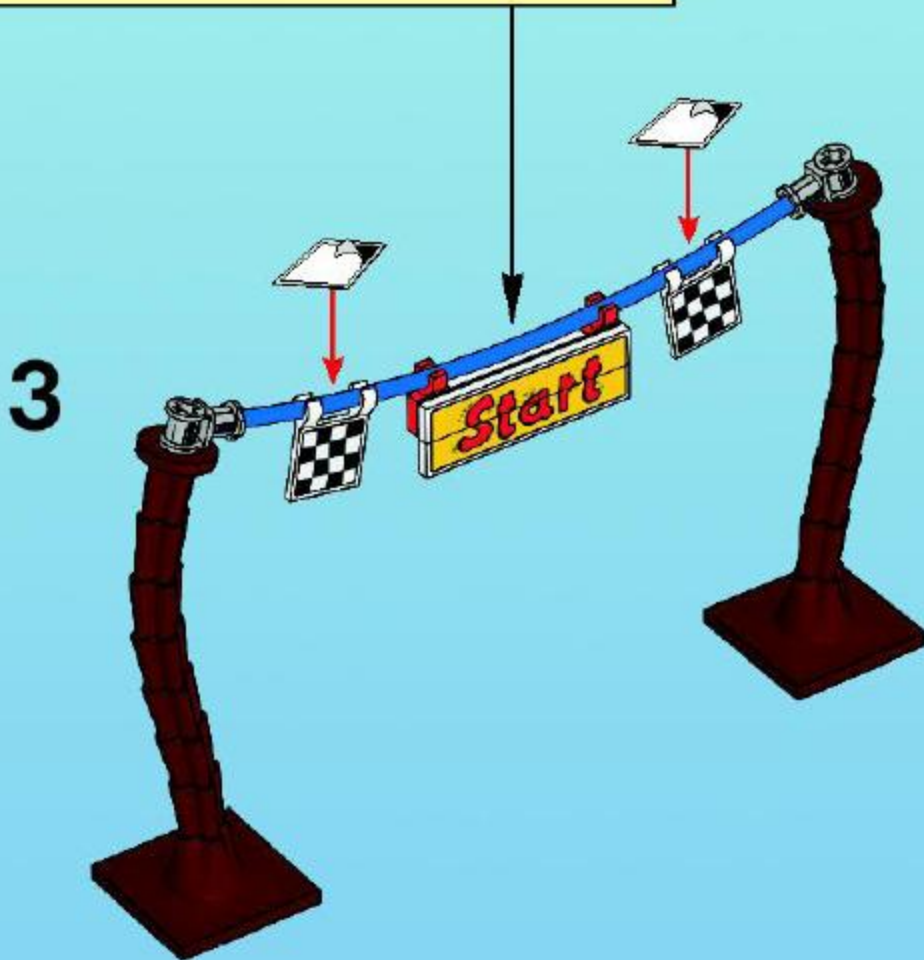
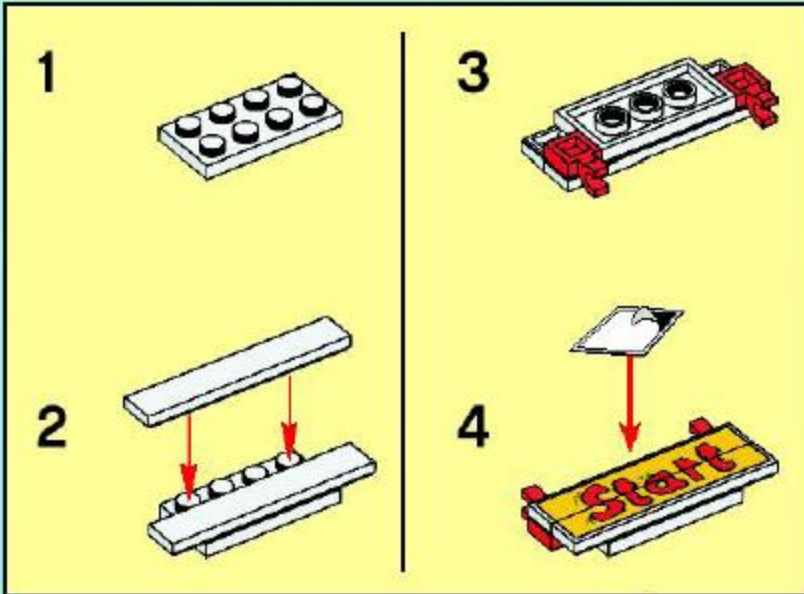



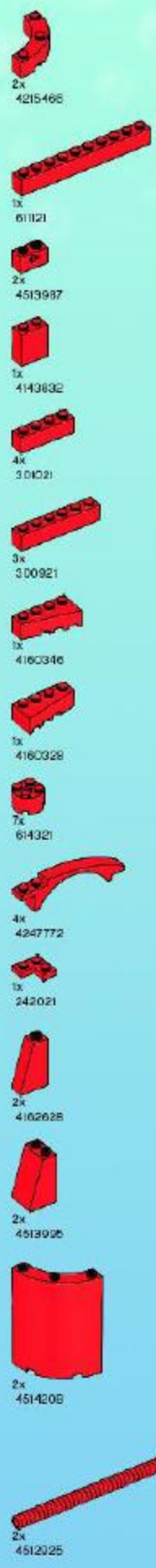

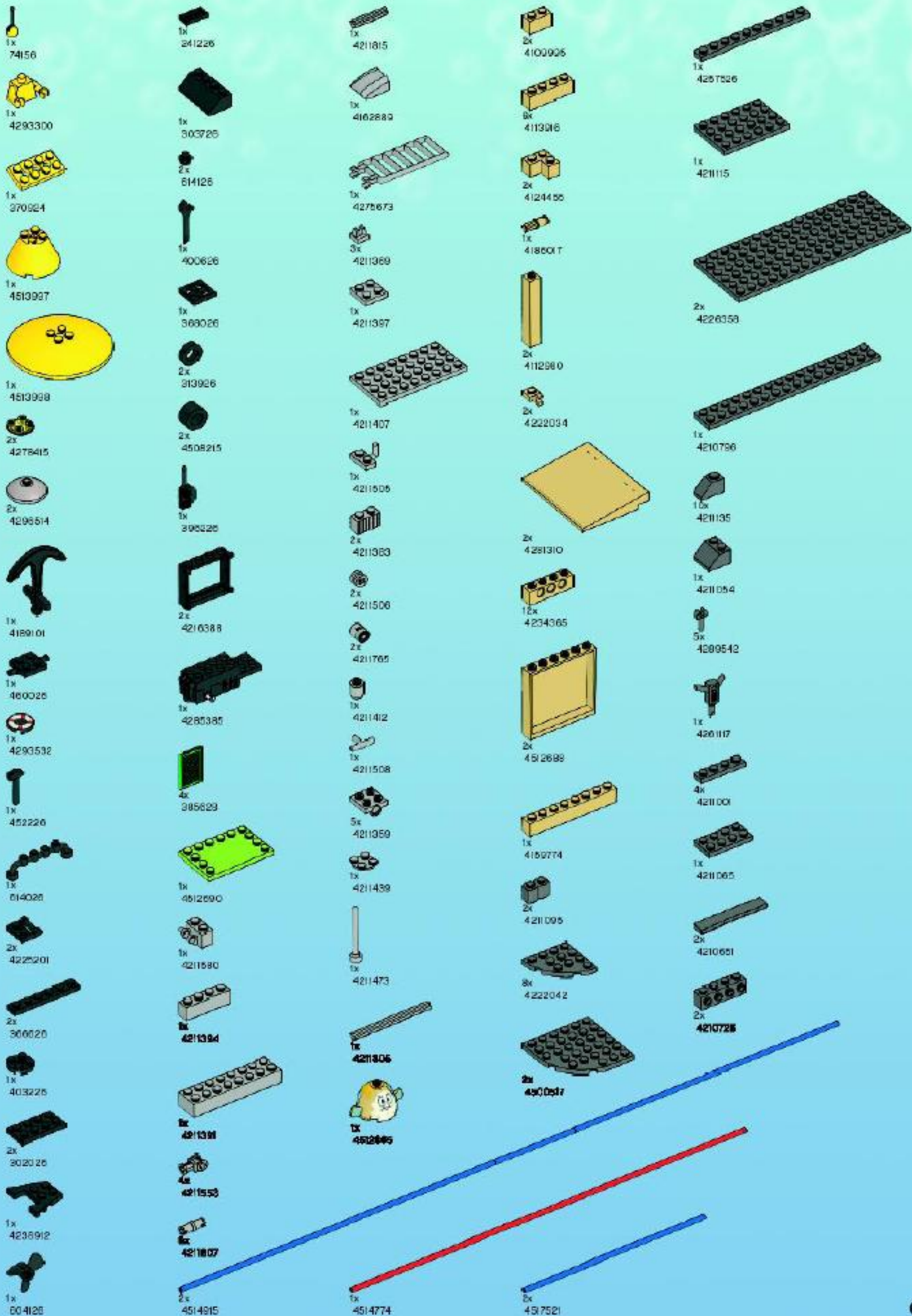

# Win! Gagne! 当たります Gewinne!

## Win LEGO products

We would like to know what you think about your new LEGO product. Log on to the web address below for further instructions.

## Gagne des produits LEGO

Nous aimerions savoir ce que tu penses de ton nouveau produit LEGO. Tu obtiendras davantage d'informations en visitant le site Internet indique ci-dessous.

## Gewinne LEGO produkte

Wir sind sehr an deiner Meinung über dein neues LEGO Produkt interessiert. Gehe einfach zu der unten angegebenen Webadresse – dort findest du weitere Informationen.

## Estimado usuario LEGO

Al contestar algunas preguntas en inglés, francés, alemán o japonés, en el sitio [www.acnielsen.aim.dk/lego](http://www.acnielsen.aim.dk/lego), podrás participar en el sorteo de algunos valiosos premios LEGO.

## Caro Consumidor da LEGO

Ao responder a algumas perguntas em Inglês, Francês, Alemão ou Japonês no endereço [www.acnielsen.aim.dk/lego](http://www.acnielsen.aim.dk/lego) irá participar num concurso para ganhar valiosos prémios da LEGO.

## Kedves ifjú LEGO Vásárló

Ha ellátogatsz a [www.acnielsen.aim.dk/lego](http://www.acnielsen.aim.dk/lego) honlapra és ott angol, francia, német vagy japán nyelven megválaszolsz néhány kérdést, akkor részt veszel egy versenyben, amelyben értékes LEGO díjakat nyerhetsz.

## 日本でレゴ製品が当たります

私たちは、皆さんがお買い求めのレゴ製品についてどんな感想をお持ちか、知りたいと思っています。質問に答えて、新しいレゴ製品の特選にあwardsをせんか。アンケートの回答には、ほんの3分ほどしかかかりません！詳しくは、以下のウェブアドレスまでアクセスしてください。



[www.acnielsen.aim.dk/LEGO](http://www.acnielsen.aim.dk/LEGO)



Any questions regarding your new LEGO product, please contact:

**Customer Service | Kundenservice**

**Service Consommateurs**

**Servicio Al Consumidor at**

**[www.lego.com/service](http://www.lego.com/service) or dial**

 :

**00800 5346 5555**

 :

**1-800-422-5346**





**YES! I want to join the LEGO® Club FREE!**

**OUI! Je veux m'abonner au Club LEGO® GRATUITEMENT!**

**Ja! Ich möchte Mitglied im kostenlosen LEGO Club werden. Ja! Ik wil graag GRATIS lid worden van de LEGO Club.**

BG27

First Name  
Prénom  
Vorname  
Voornaam

Last name  
Nom de famille  
Familienname  
Achternaam

Date of Birth  
Date de naissance  
Geburtsdag  
Geboortedatum

Boy  
Garçon  
Junge  
Jongen

Girl  
Fille  
Mädchen  
Meisje

Street, No.  
Rue  
Straße, Hausnr.  
Street, huisnr.

City/County  
Ville  
Stadt  
Woonplaats

State  
Prov.

Zip/Postcode  
Code Postal  
PLZ  
Postcode

Country  
Pays  
Land

Telephone  
No de Téléphone  
Telefonnr.  
Telefoonnummer

Parent's signature  
Signature d'un parent  
Unterschrift Erziehungsberechtigte/r  
Handtekening ouders

The English version of the magazine can only be mailed to addresses in the US, Canada, the UK, and Republic of Ireland. Club membership is valid for 2 years and includes free copies of the LEGO Magazine. In the US and Canada please allow up to 6 weeks for delivery of your first magazine. By signing this form you consent the LEGO Club to use your child's data for LEGO mailings. The data will only be used for LEGO mailings and will not be sold, rented or otherwise disclosed to any company outside the LEGO Company except for disclosure to companies acting as our agents to help us provide services requested by the child. This coupon good for one free membership per person, group or organization (photo copies not accepted).  
La version française du magazine peut être posée uniquement au Canada. L'abonnement est valide pour 2 ans et inclut des exemplaires gratuits du Magazine LEGO. Aux E.U. et au Canada, prévoir 6 semaines pour la livraison initiale. En remplissant ce formulaire, vous consentez à ce que LEGO utilise les informations de votre enfant pour des envois postaux de LEGO. L'information sera utilisée uniquement pour des envois postaux par LEGO et ne sera en aucun cas, vendue, louée, échangée ou divulguée à d'autres compagnies autres que la compagnie LEGO, à l'exception des compagnies affiliées qui nous procurent des services auxquels l'enfant en a fait la demande.

Das deutschsprachige Angebot gilt nur für die Länder D, AU und CH. Die kostenlose Mitgliedschaft beinhaltet die Zusage des LEGO Magazins und endet nach zwei Jahren. Für die Mitglieder entstehen keine Verpflichtungen. Es kann bis zu drei Monate dauern, bis das erste Magazin zugestellt wird. Mit Ihrer Unterschrift erklären Sie sich einverstanden, dass die Daten Ihres Kindes zum Zweck einer LEGO Club-Mitgliedschaft von der LEGO Gruppe gespeichert werden. Die Daten werden vertraulich behandelt und nicht an Dritte weitergegeben, außer an Dienstleister des LEGO Clubs. Wenn Sie außer vom LEGO Club keine weiteren Informationen von der LEGO Company bekommen möchten bitte hier ankreuzen:   
Door dit formulier te tekenen geeft u de LEGO Club toestemming om bovenstaande gegevens te gebruiken voor het toesturen van LEGO mailings. Uw gegevens worden uitsluitend gebruikt voor mailings van LEGO en zullen niet worden verkocht, verhuurd of op welke wijze dan ook verstrekt aan derden buiten de LEGO Groep, uitgezonderd de organisaties die namens ons optreden om de service te verlenen waar uw kind om gevraagd heeft.



Mail to: / Poster à:

**LEGO Club**

**P.O. Box 1157**

**Enfield, CT USA**

**06083-1157**



Mail to:

**LEGO Club**

**33 Bath Road**

**Slough SL1 3UF**

**United Kingdom**



Per Post an:

**LEGO® Club**

**Postfach 14 15**

**D-36243 Niederaula**



Stuur op naar:

**LEGO® Club**

**Postbus 40252**

**3504 AB Utrecht**



# club™

FREE LEGO Magazine • GRATUIT • GRATIS LEGO Magazin



**Join Today!**  
.....  
**Abonne-toi  
dès aujourd'hui !**  
.....  
**Meld je nu aan!**  
.....  
**Jetzt anmelden!**

  US & Canada only

1-866-534-6258 / 1-877-518-5346  
(en français)

00800 5346 5555      

[www.LEGOclub.com](http://www.LEGOclub.com)



VISIT THE  
**WORLD'S BIGGEST  
LEGO® SHOP!**  
[www.LEGOshop.com](http://www.LEGOshop.com)



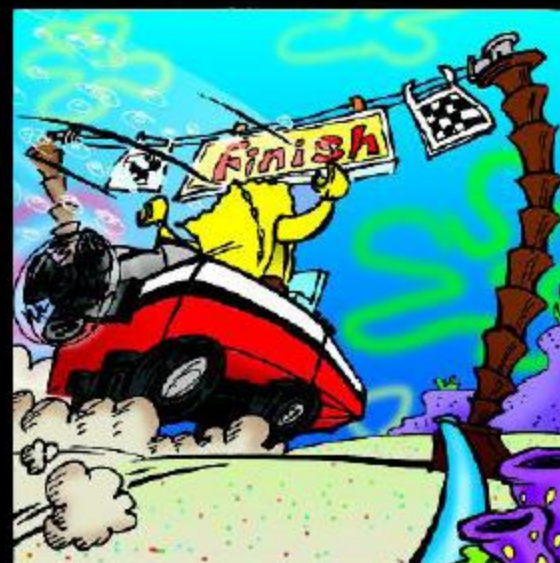







LEGO and the LEGO logo are trademarks of the/son des marques de commerce de/son marcas registradas de LEGO Group.  
©2007 The LEGO Group. 4916581

© 2007 Viacom International, Inc. All Rights Reserved/Tous droits réservés/Todos los Derechos Reservados.  
Nikolodeon, SpongeBob SquarePants and all related titles, logos and characters are trademarks of/et tous les titres qui  
s'y rapportent, les logos et les personnages sont des marques de commerce de/et todos los títulos relacionados, logos y  
personajes son marcas registradas de Viacom International, Inc. Created by Stephen Hillenburg/Créé par Stephen Hillenburg/  
Creado por Stephen Hillenburg

