



3833

NICKELODEON

**SpongeBob**  
**SQUAREPANTS**

THE  
KRUSTY  
KRAB

ENTER



1

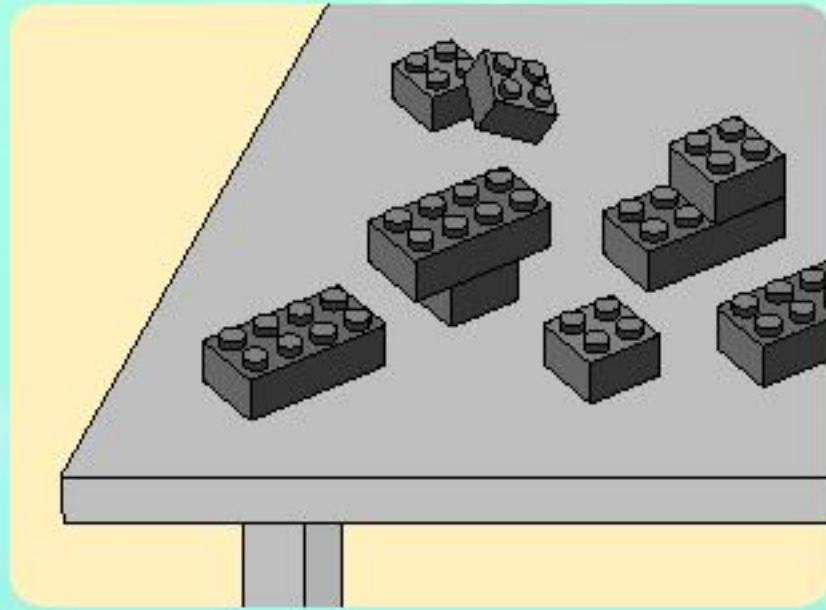

2

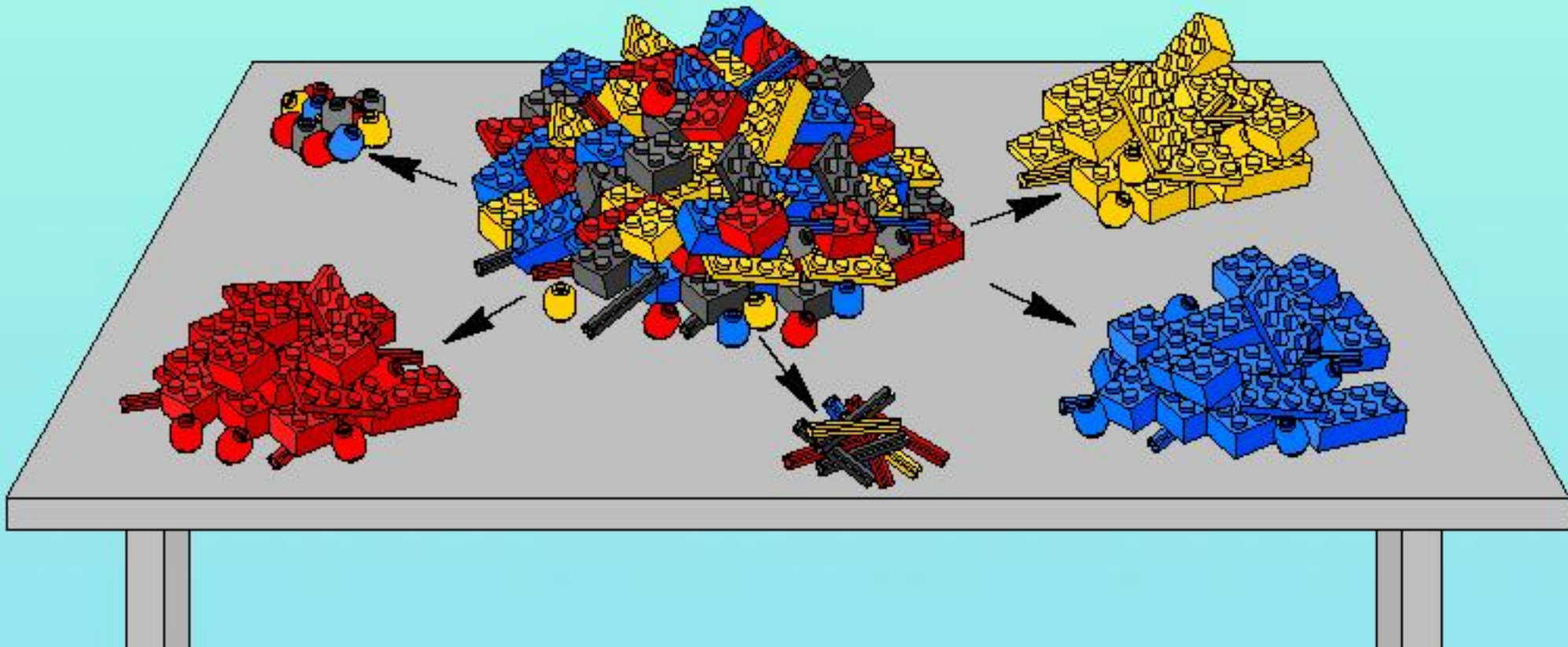

2

3

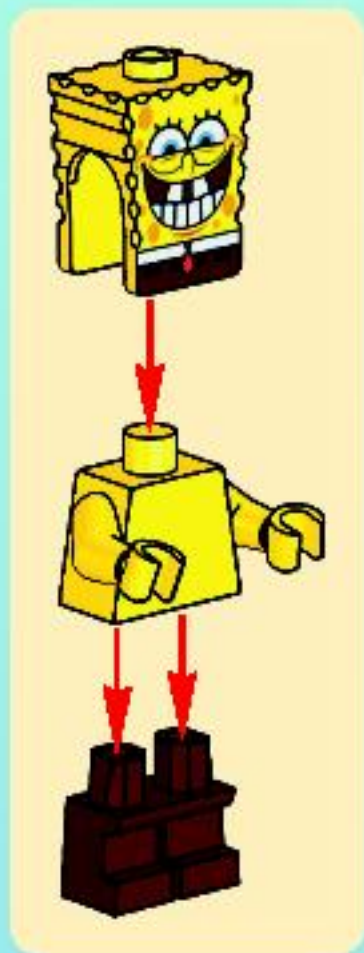



1

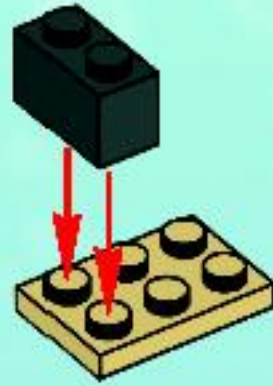

2

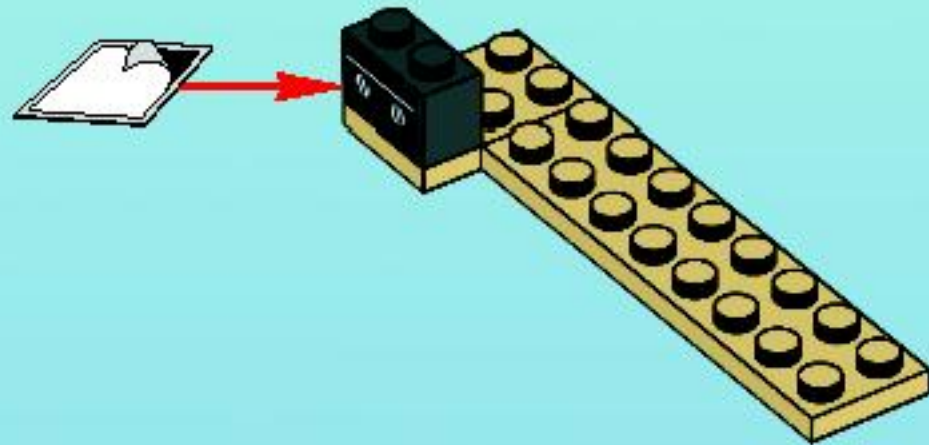

3

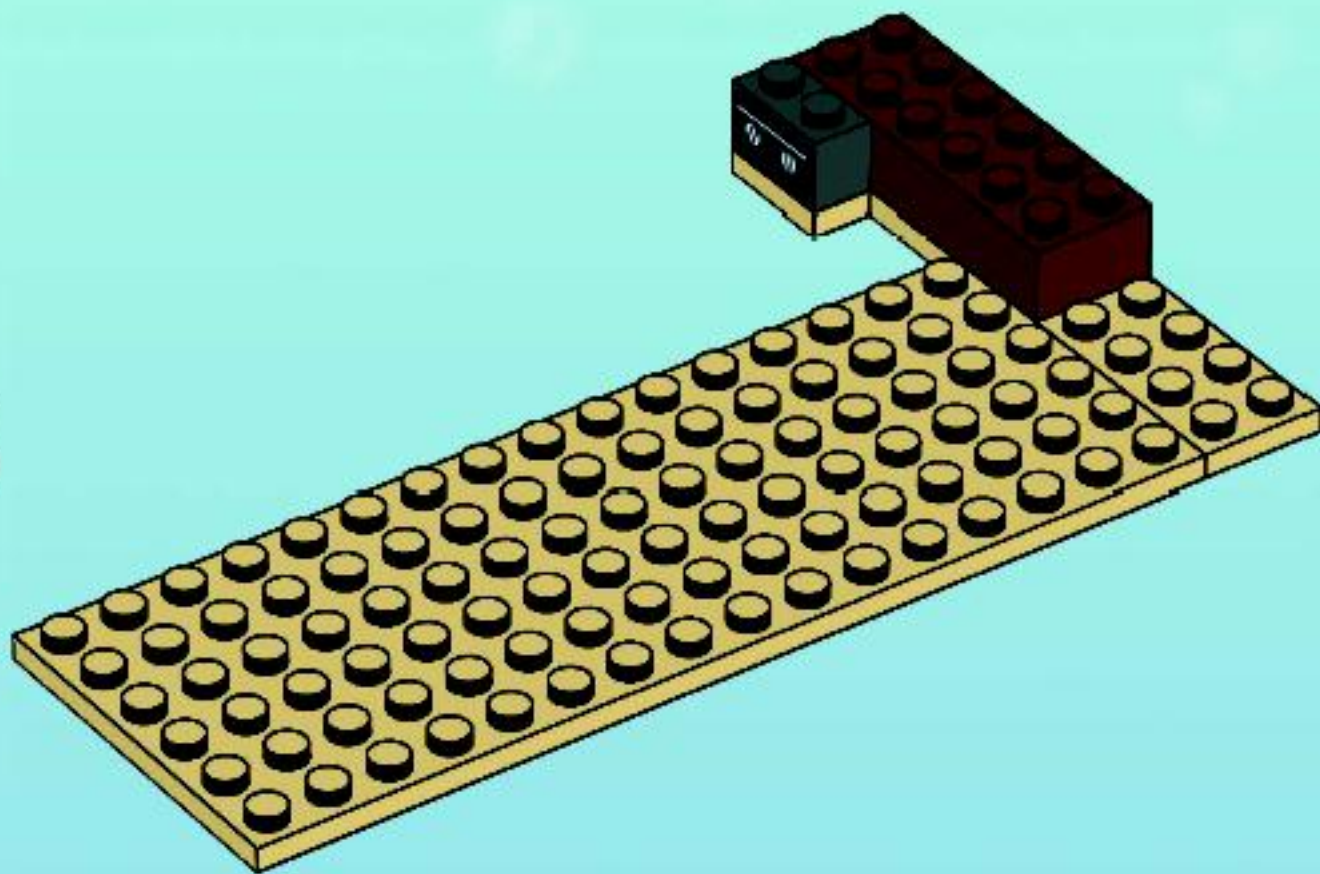

4

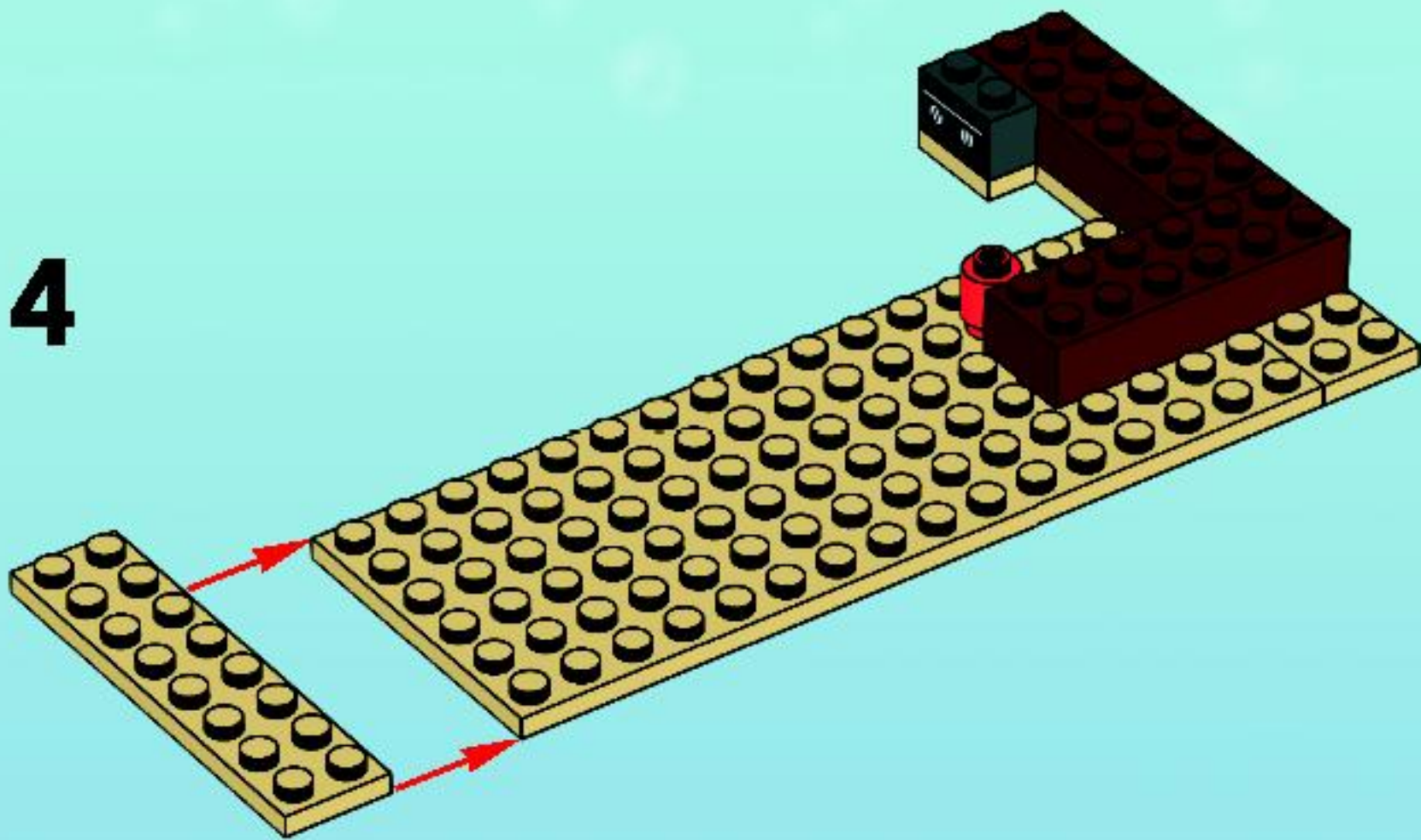

5

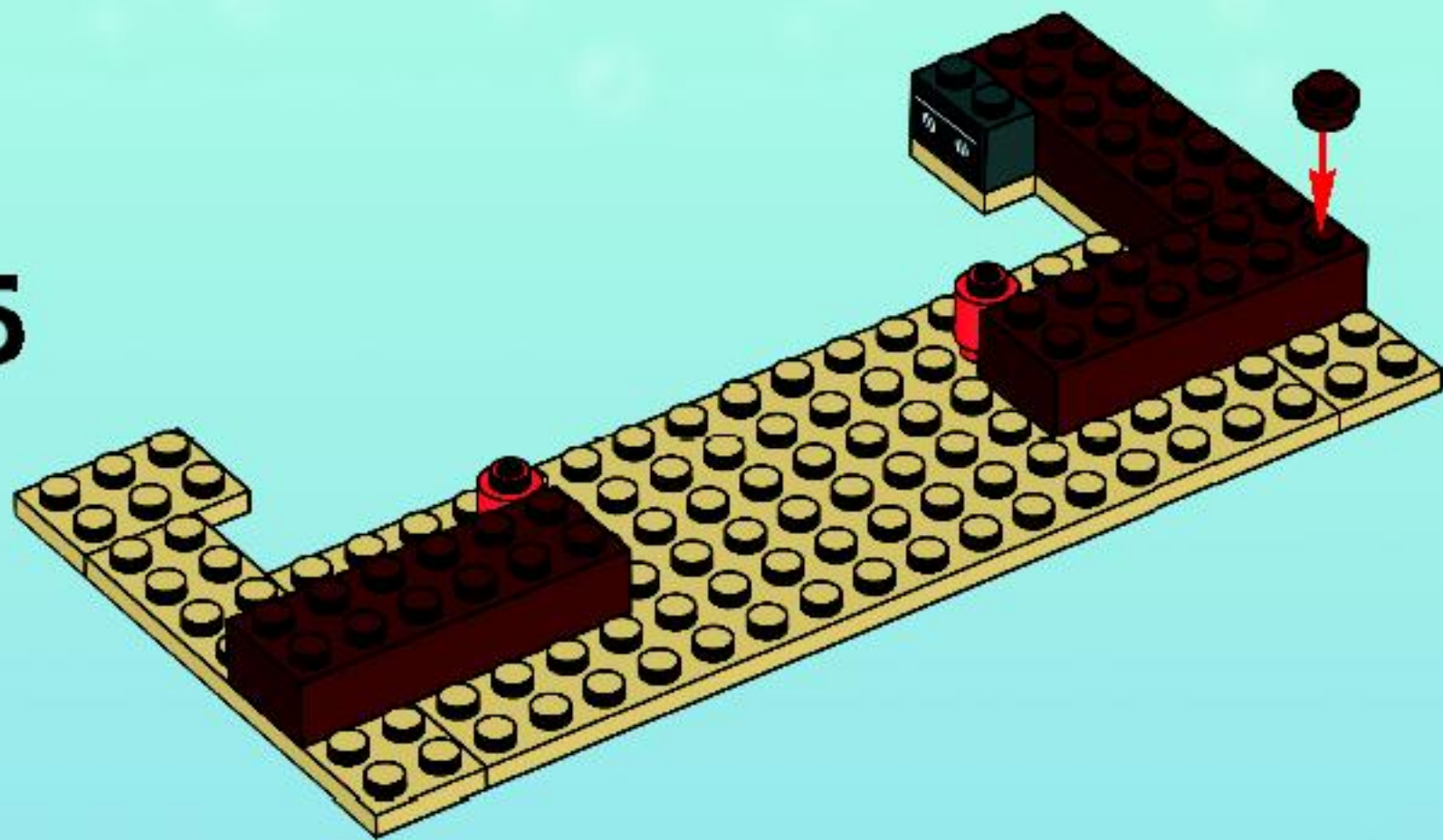

6

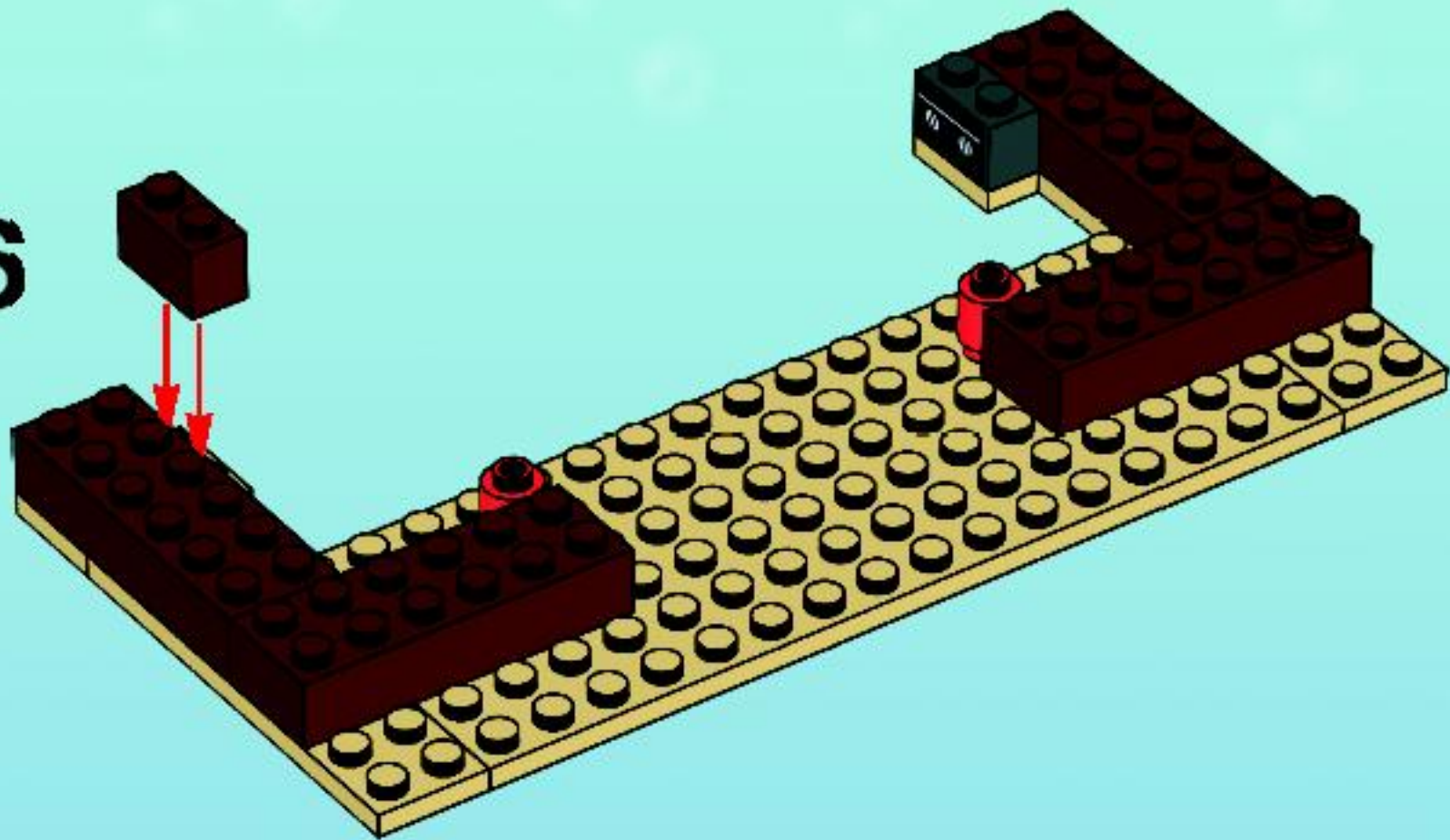



7

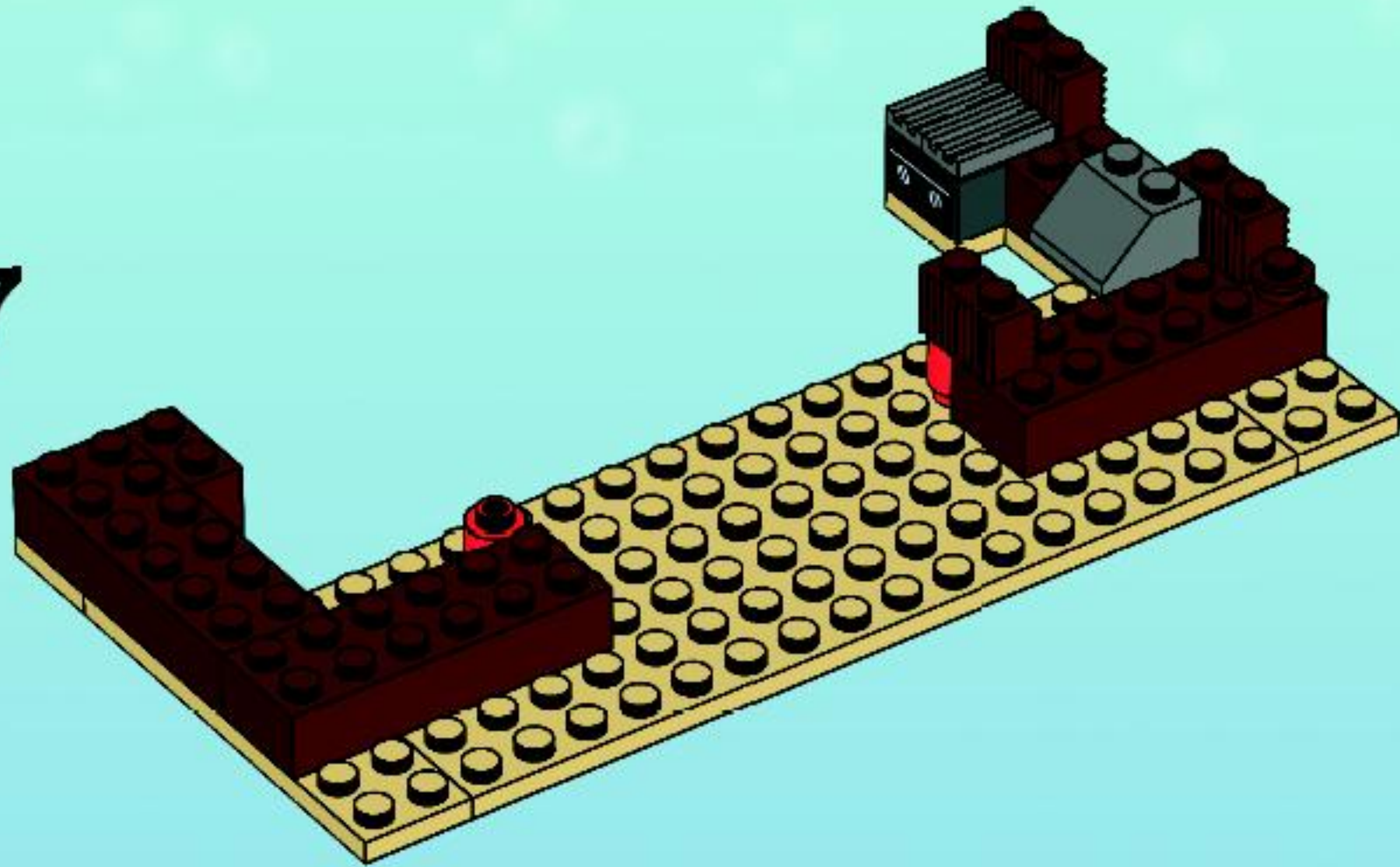

8

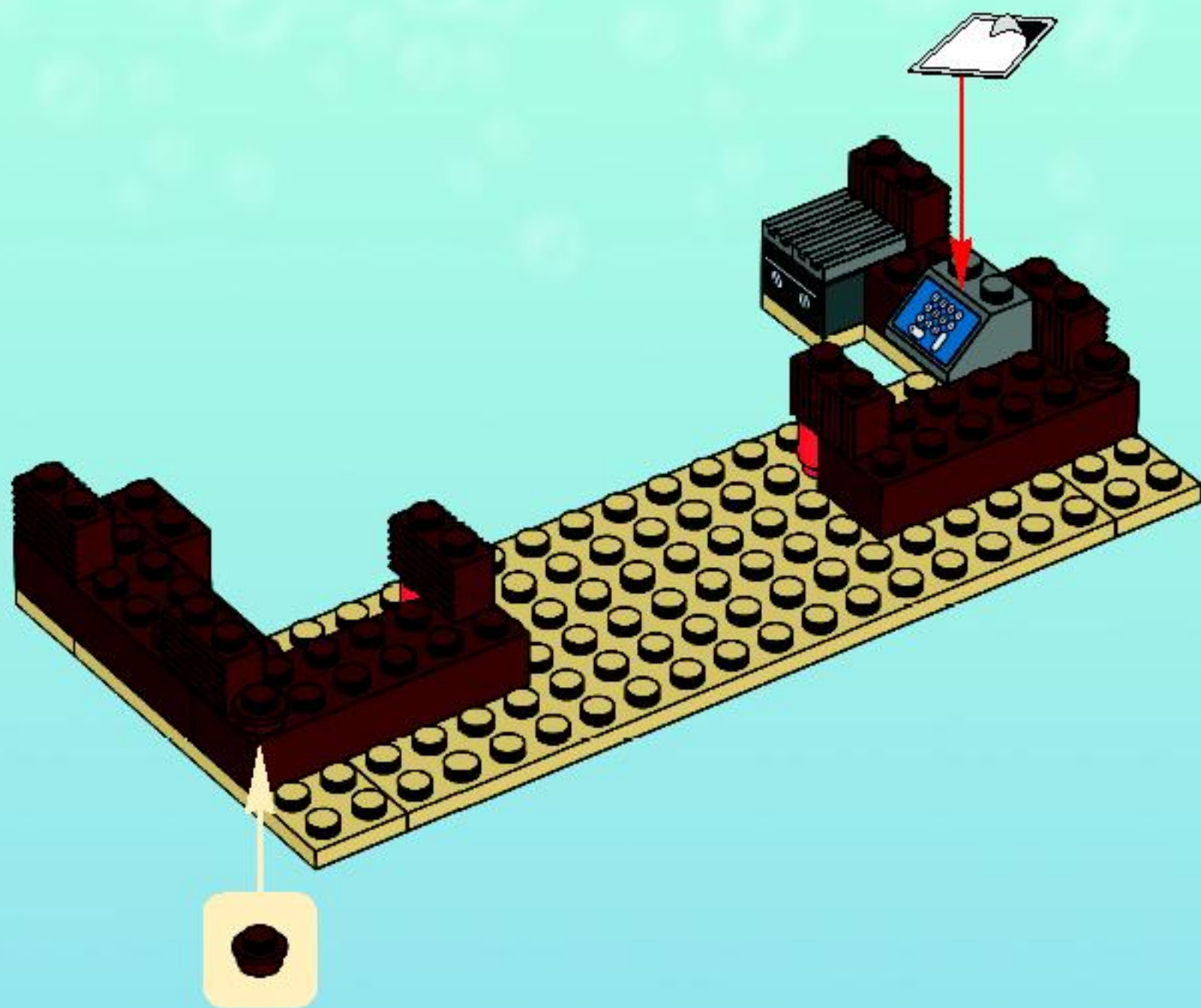

1

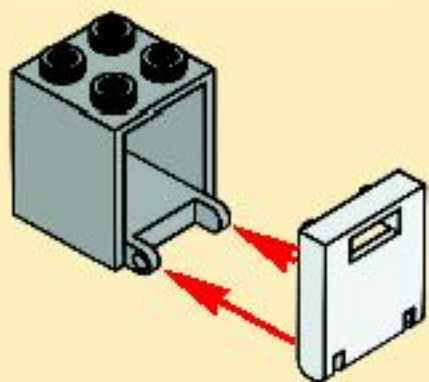

2



9

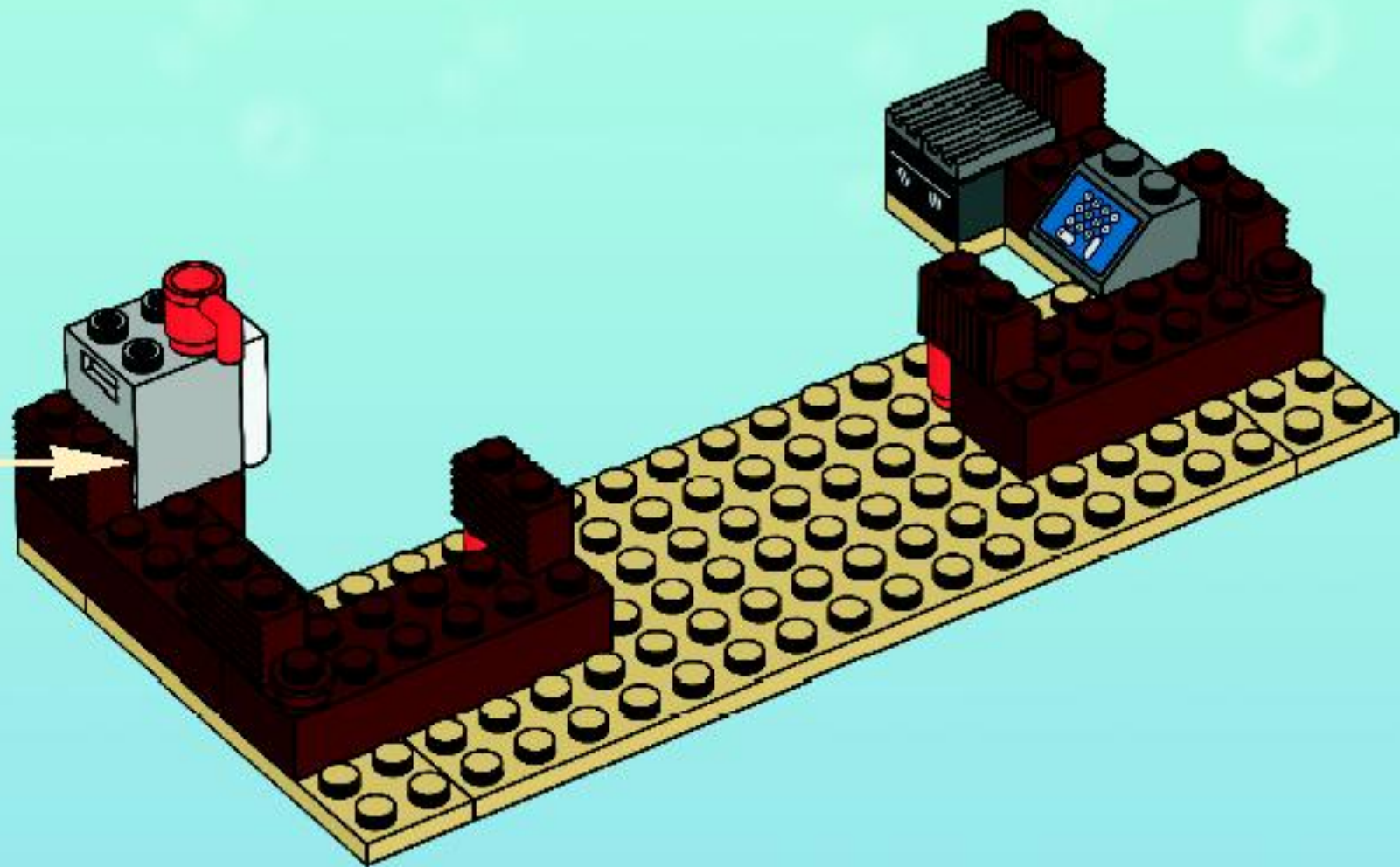

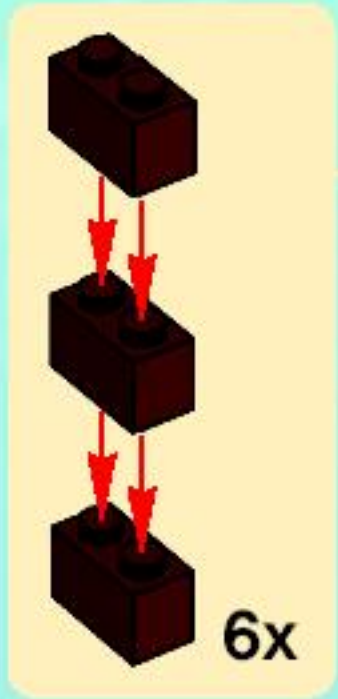

10

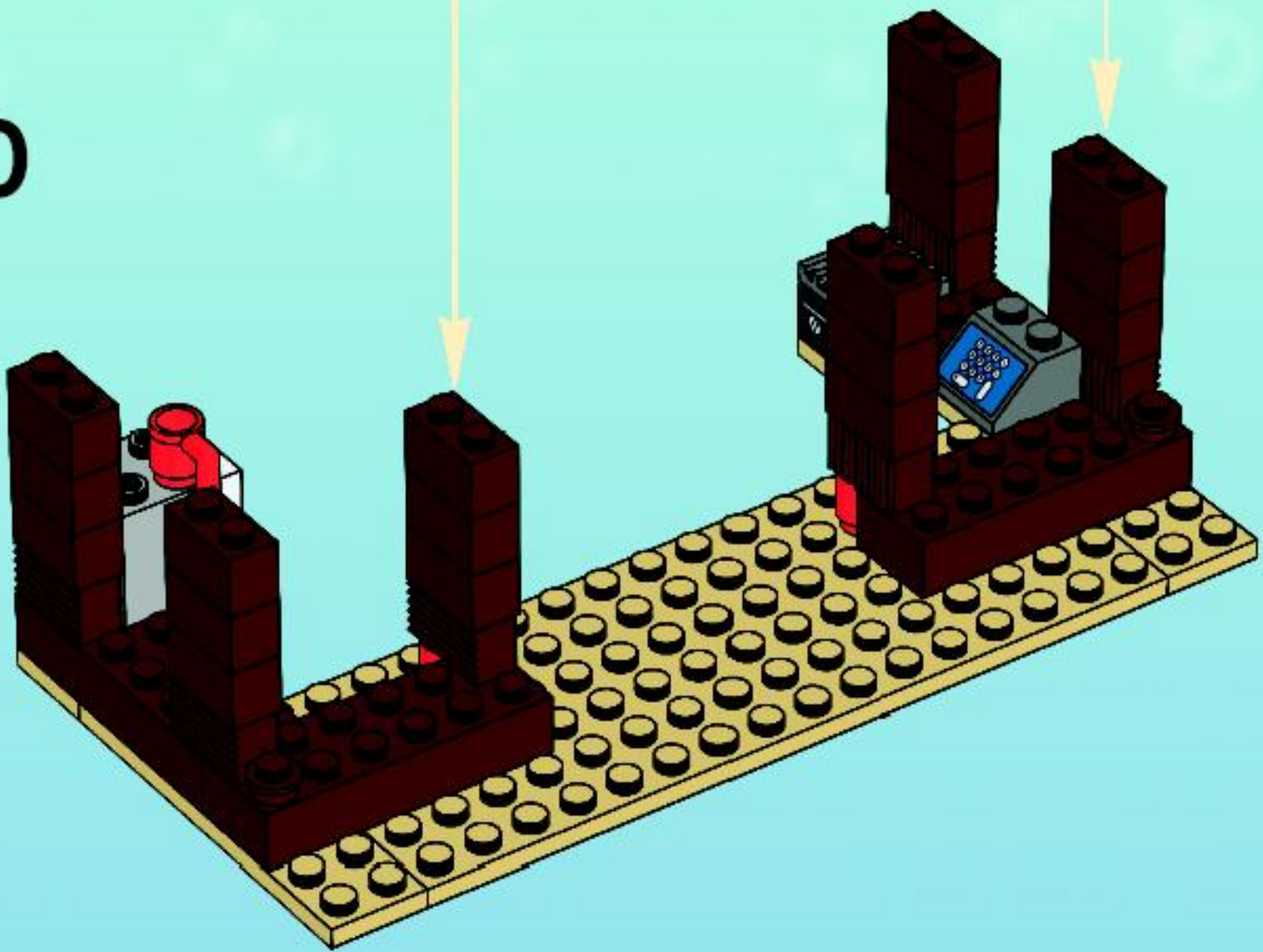

11

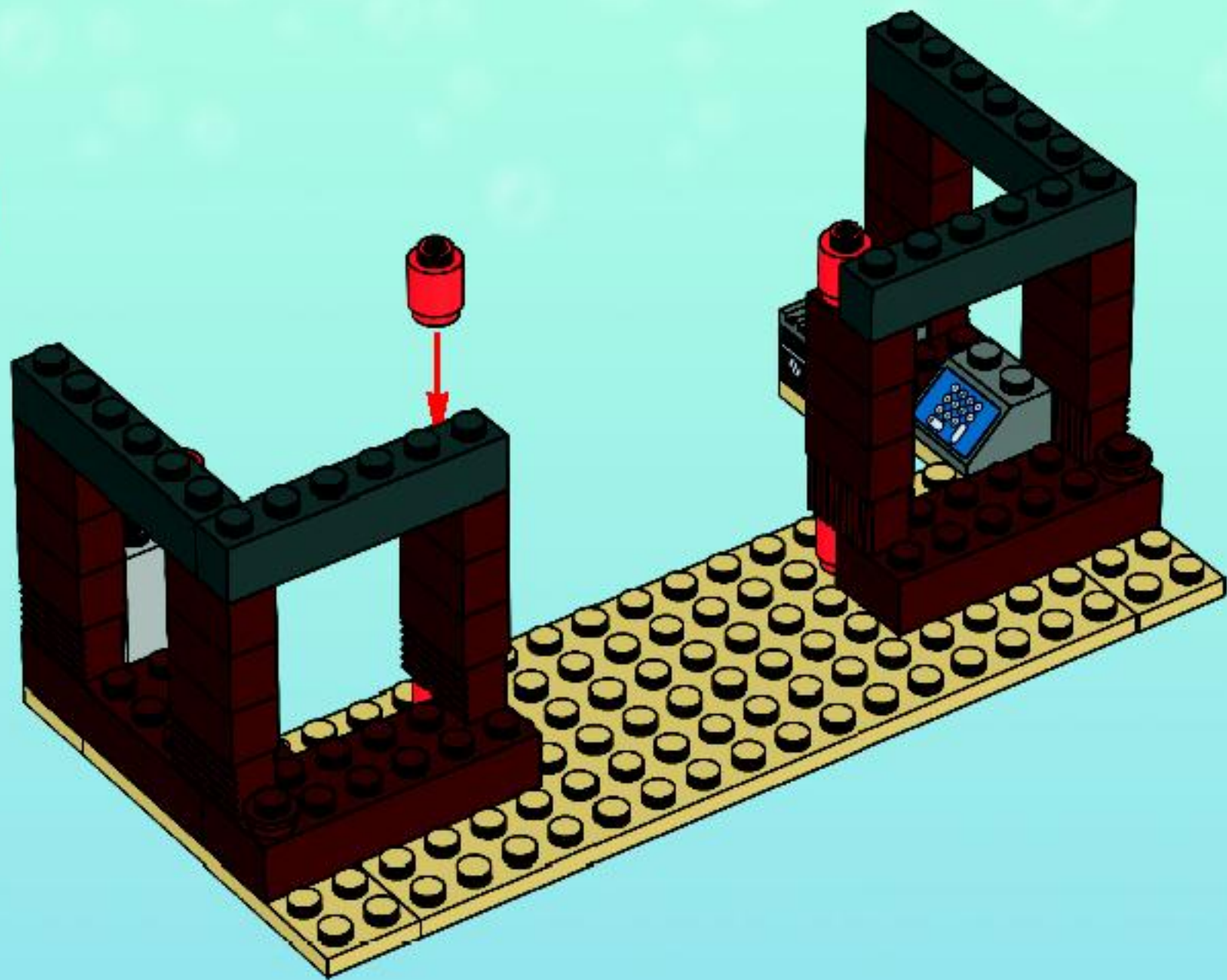

1

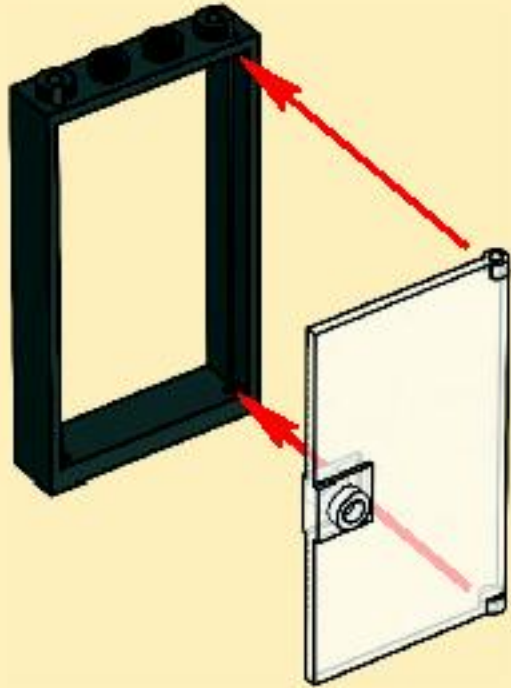

2



12

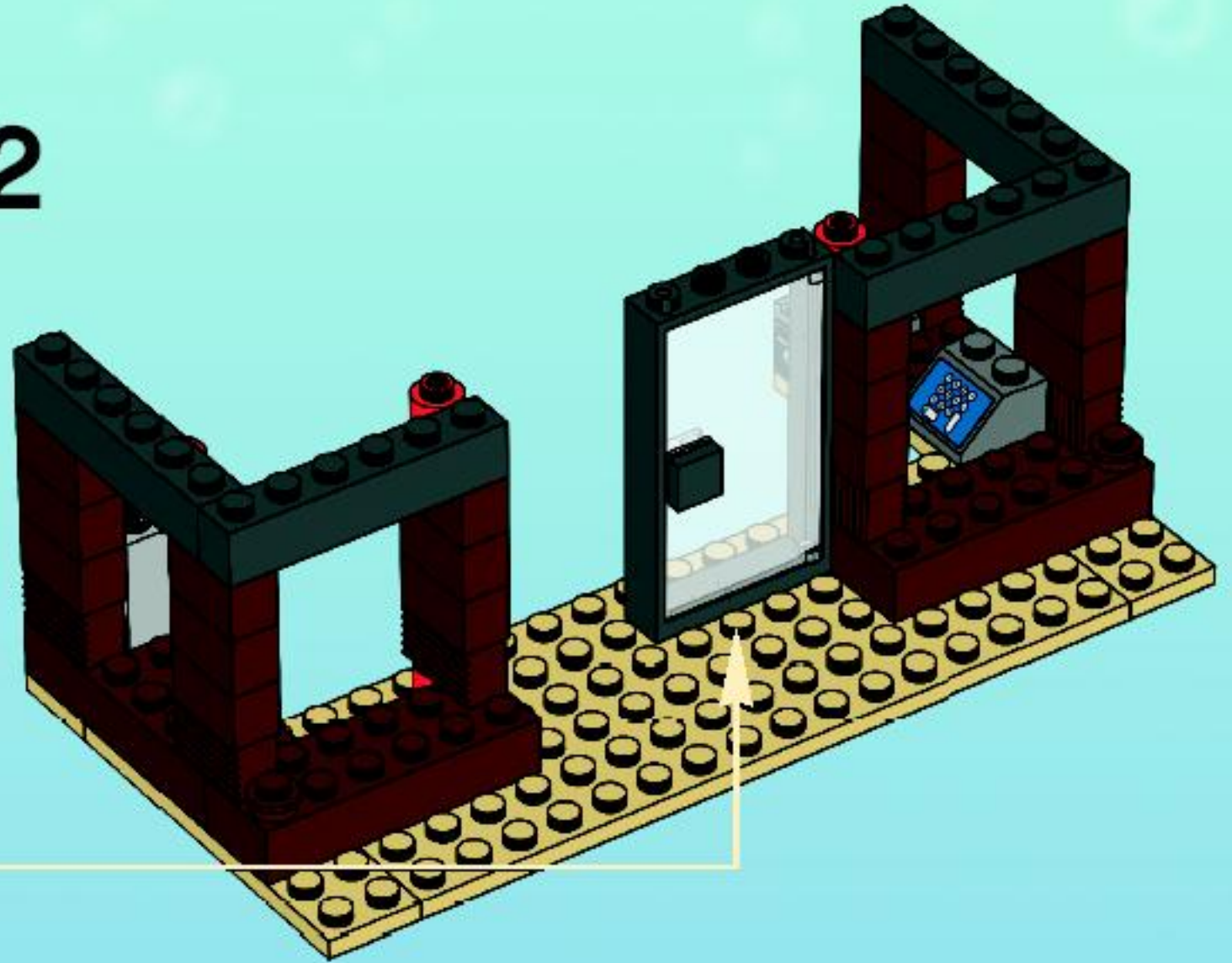

1

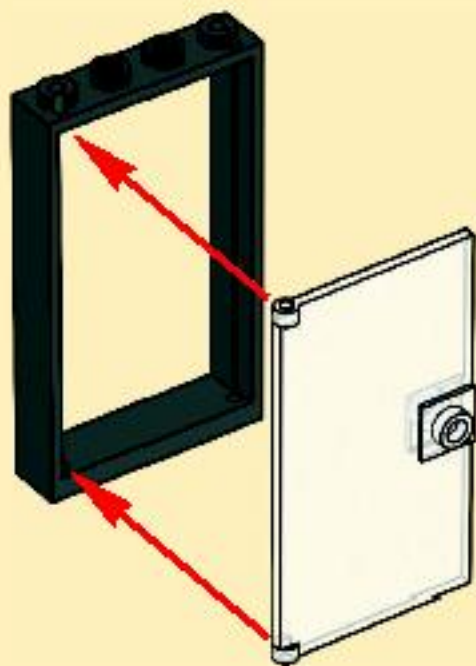

2



13

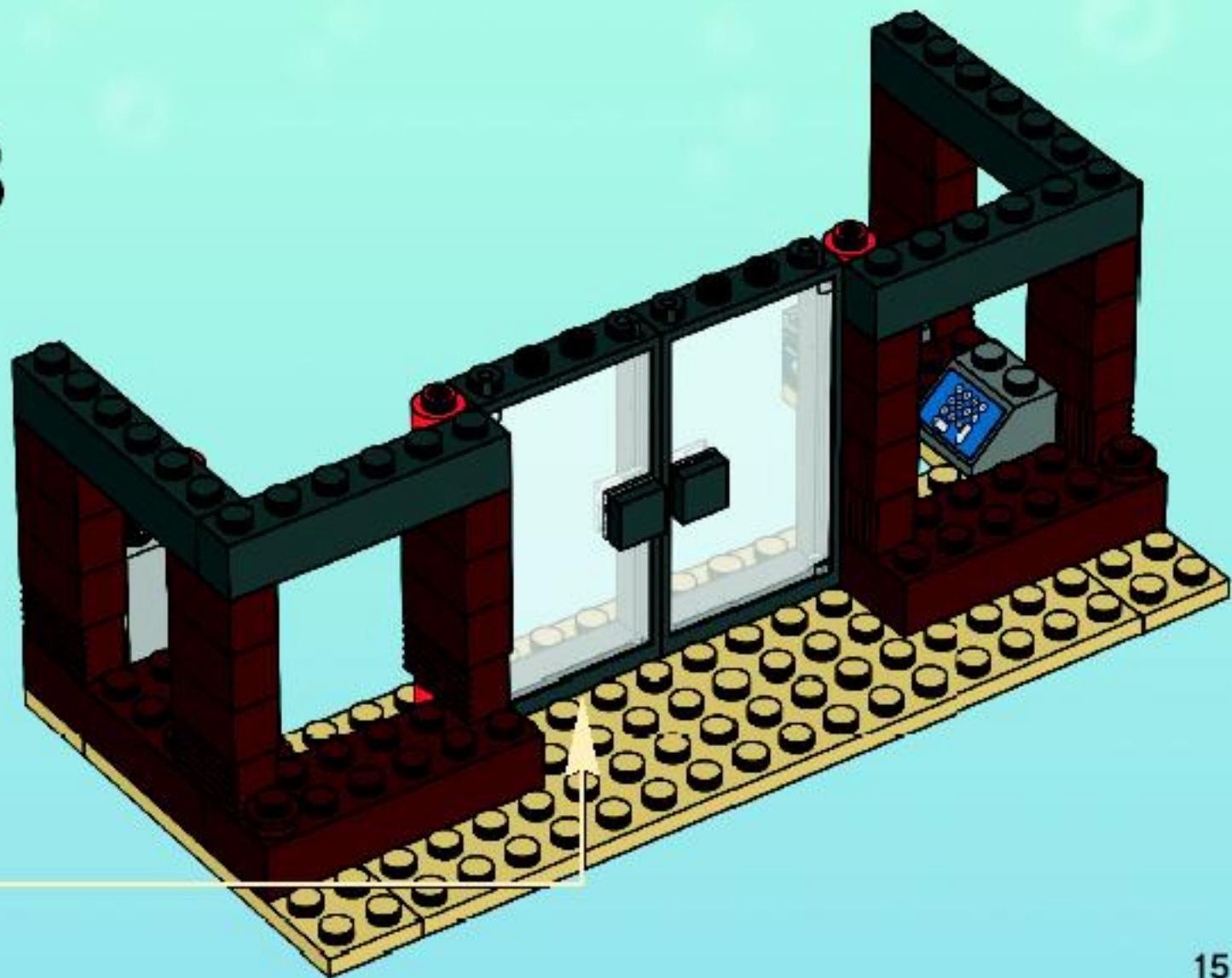

14

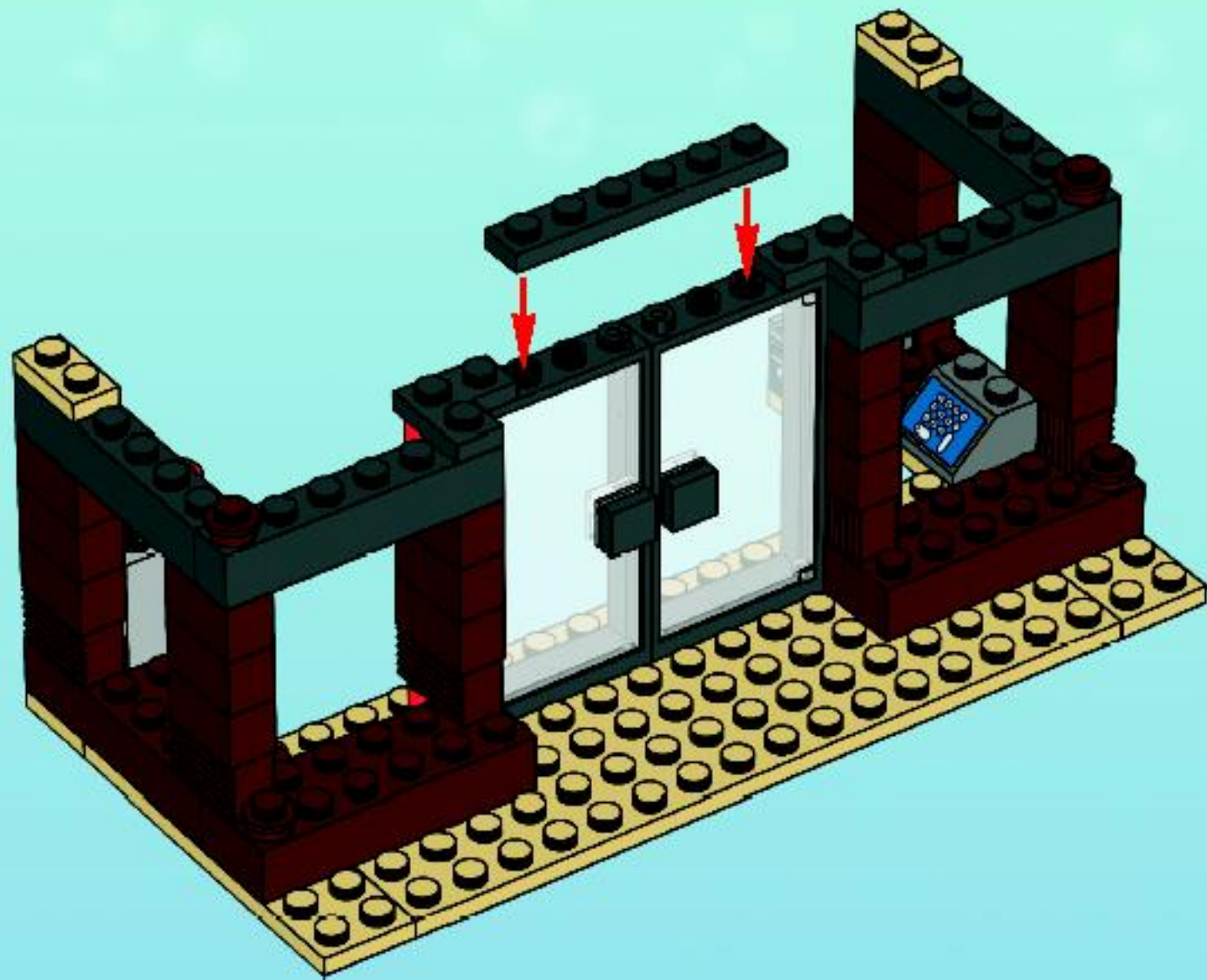



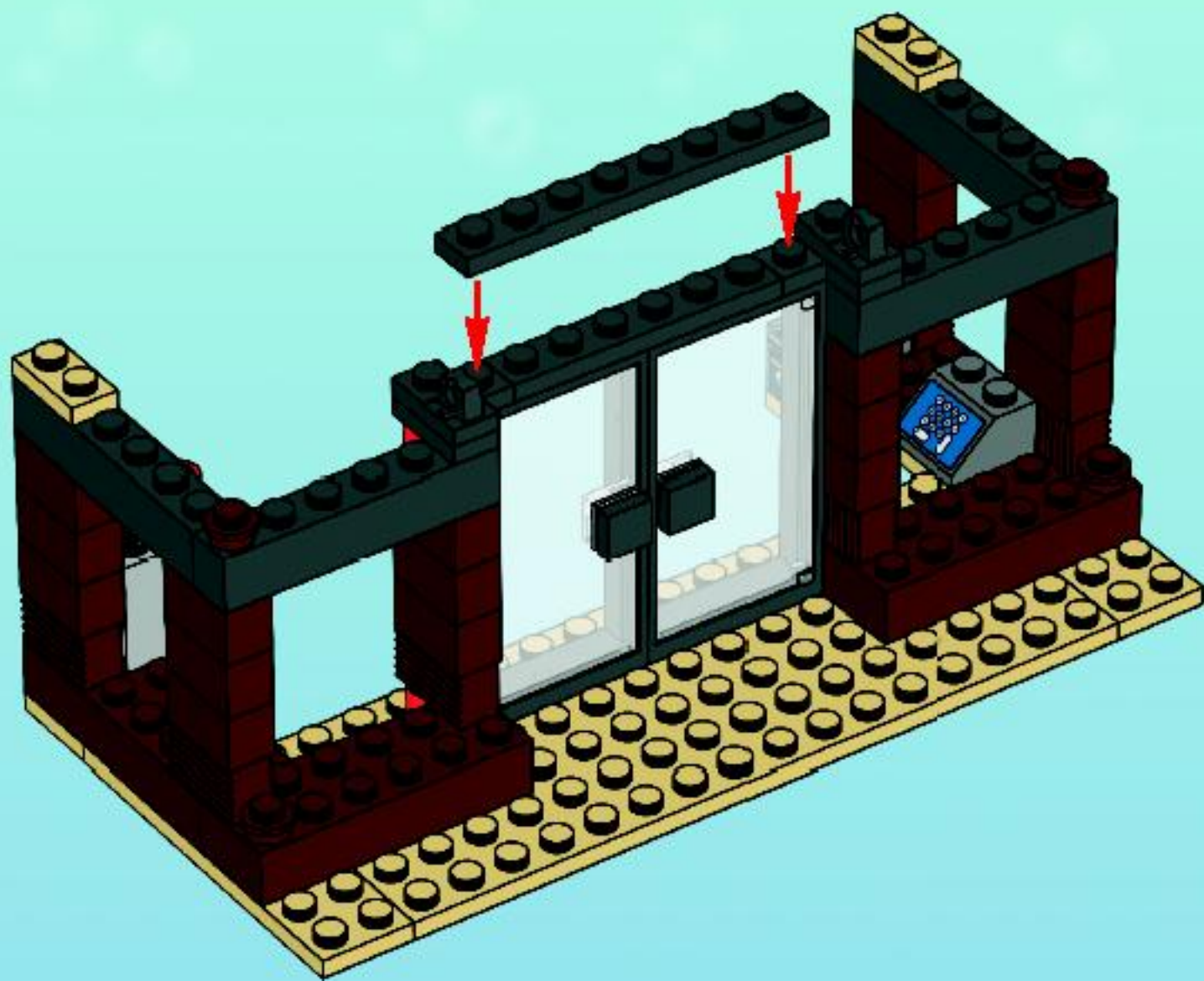

15

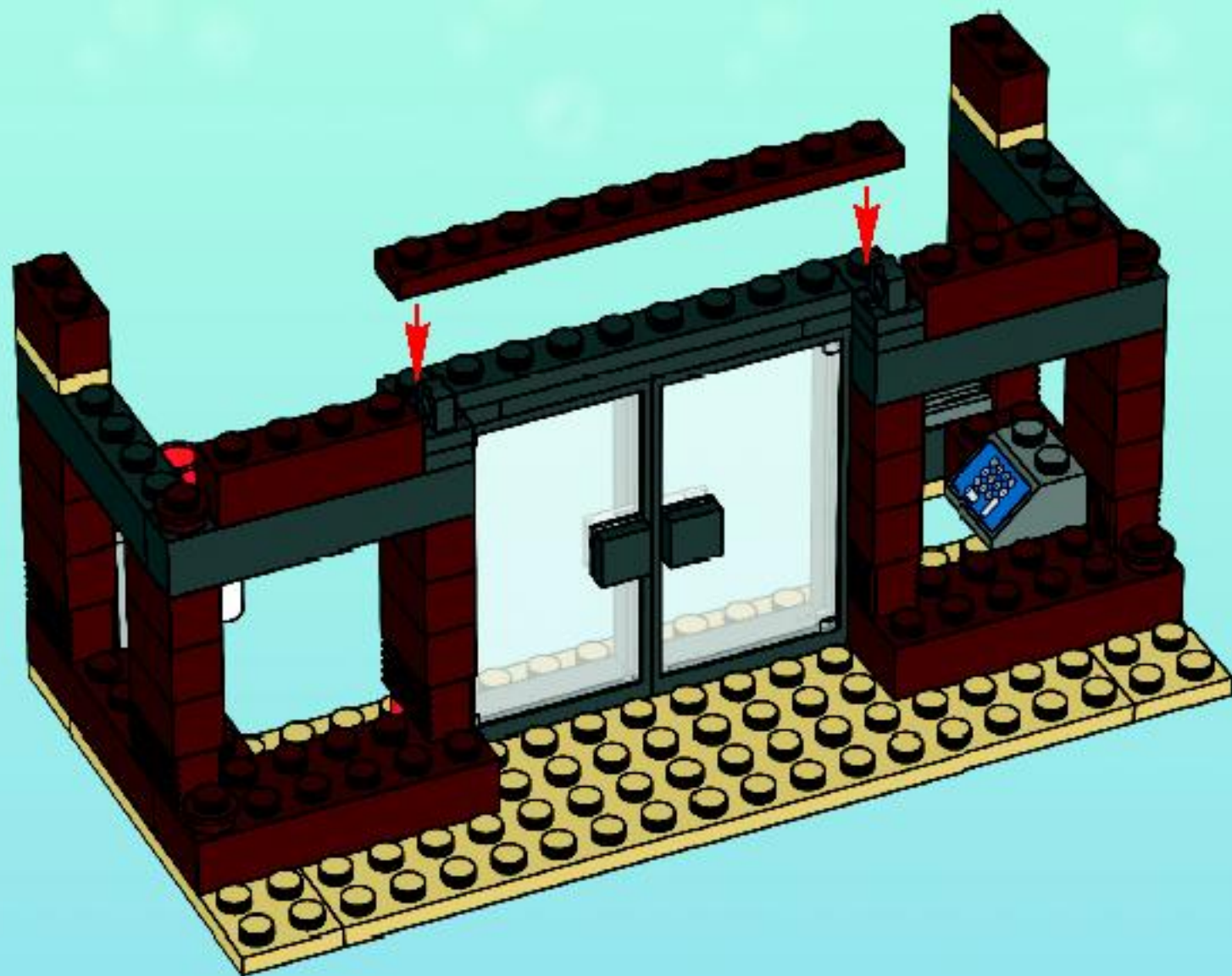

16



1 

2 

3  2x

17

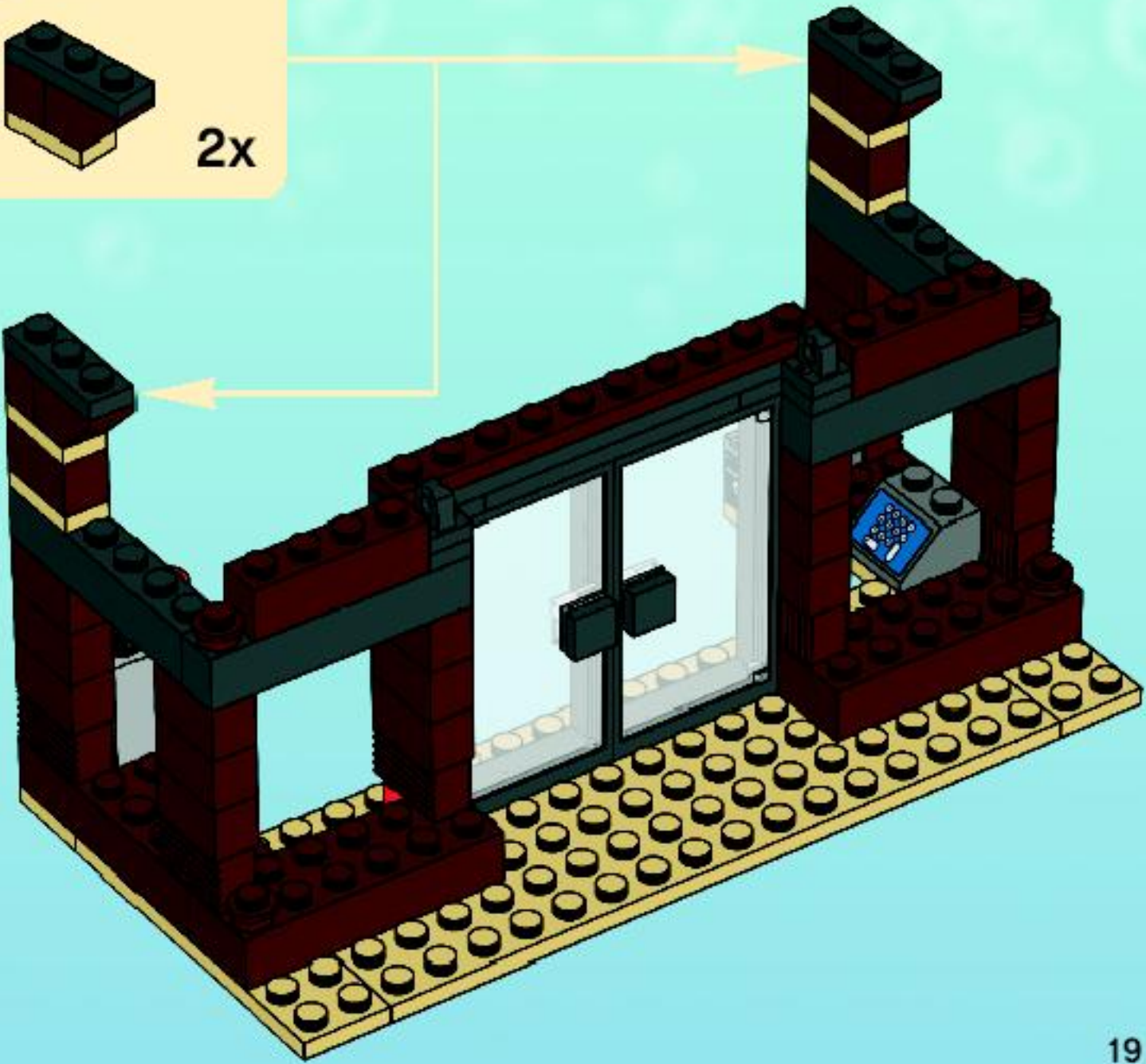

18

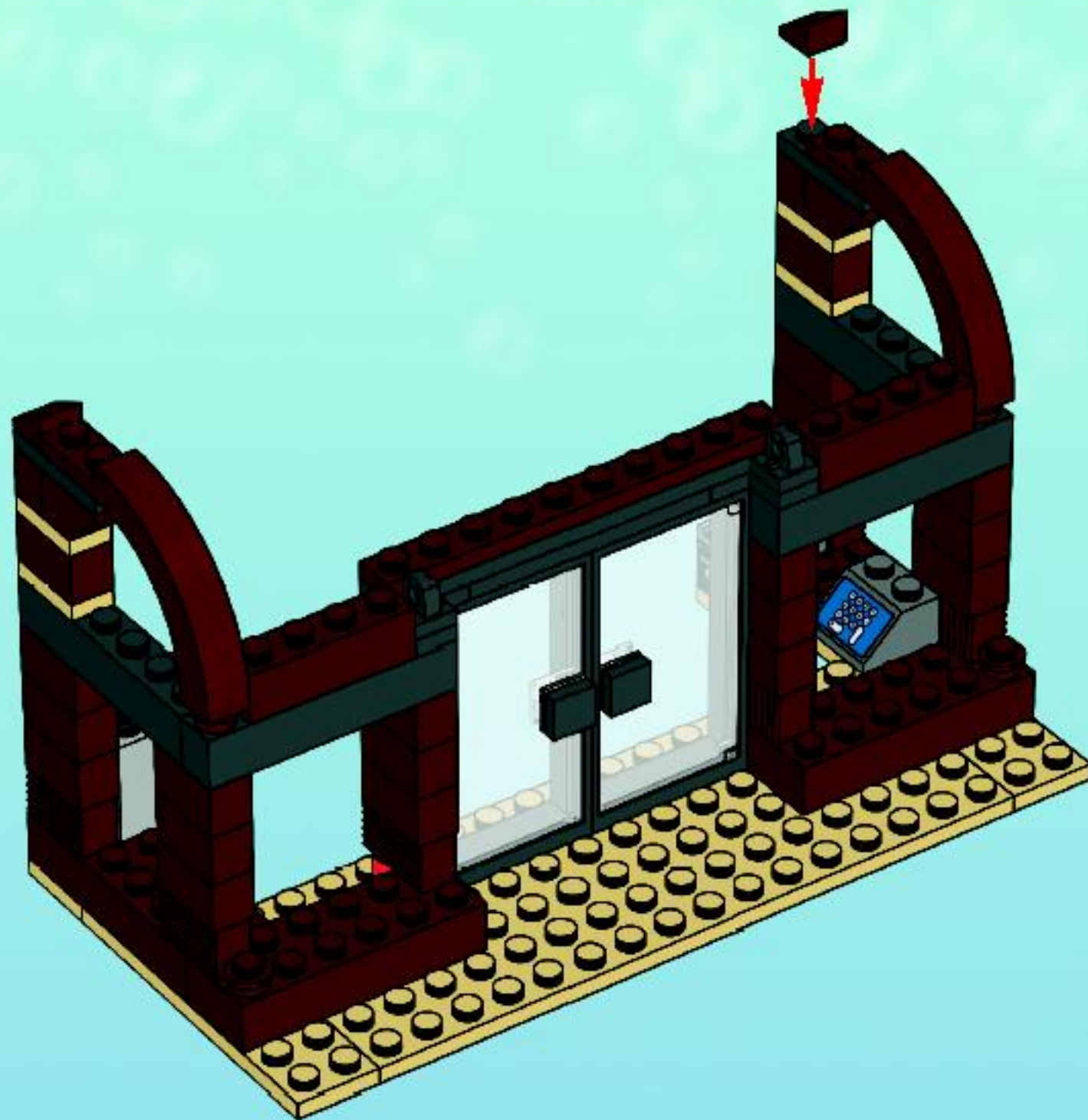

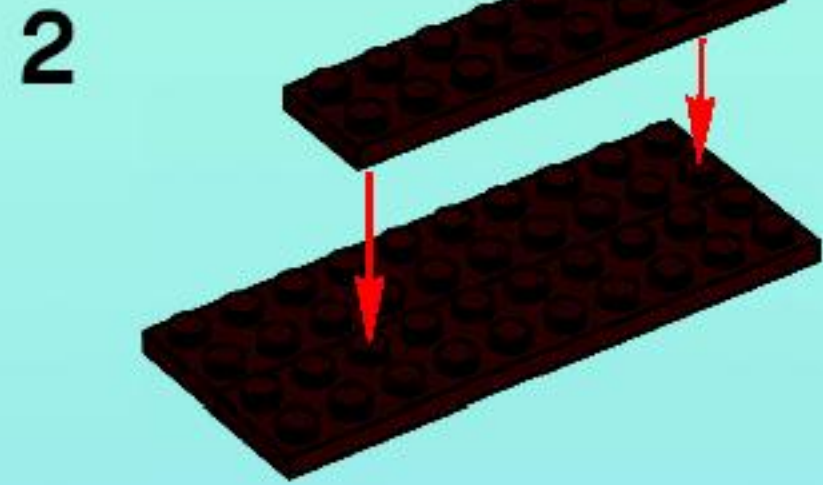
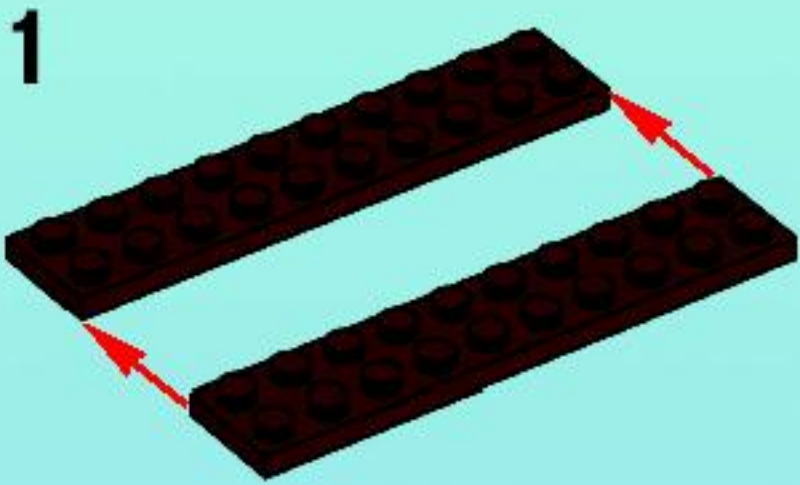

3

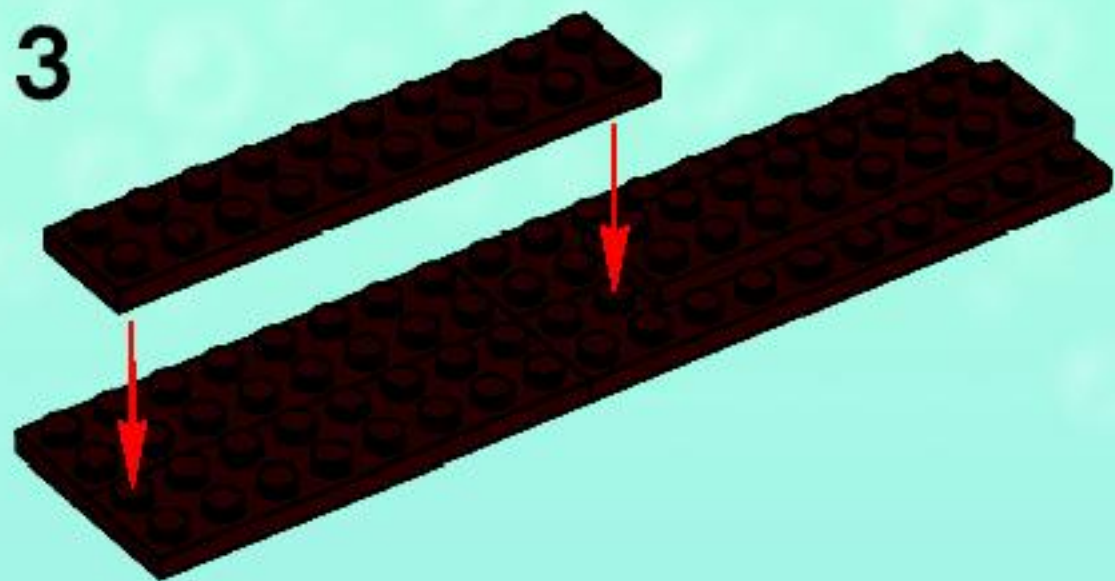

4

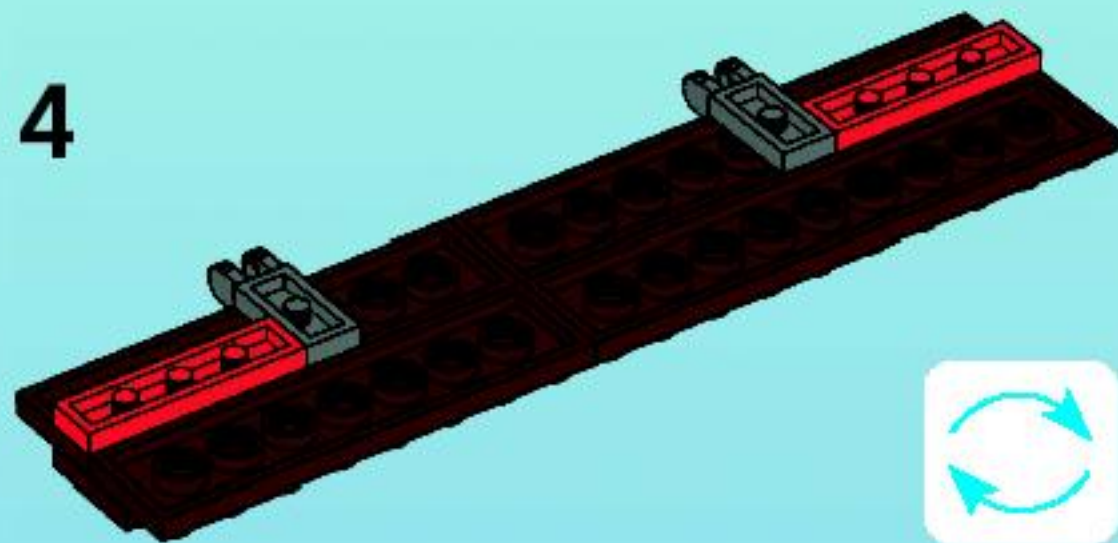

5

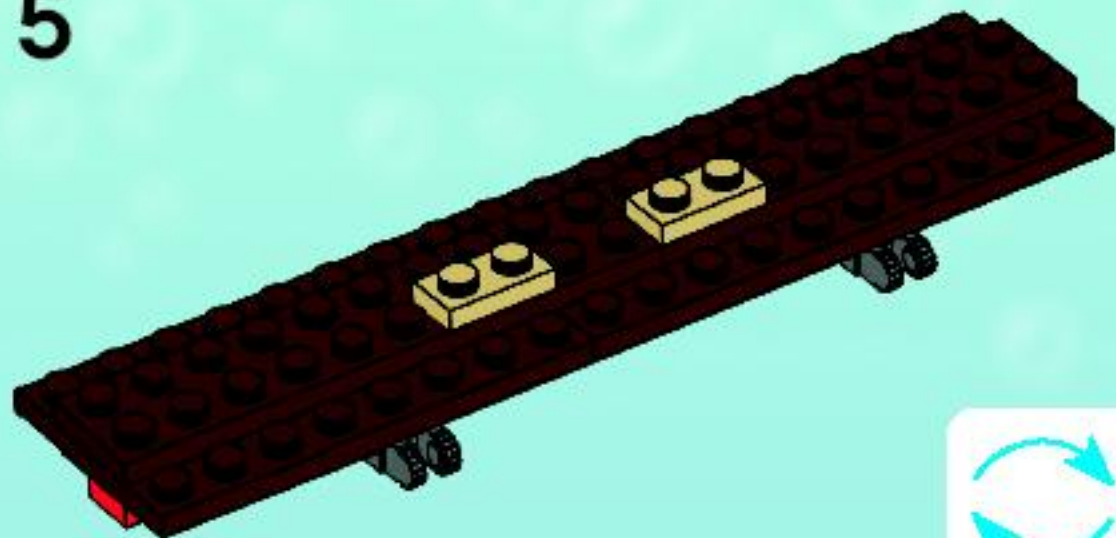

6

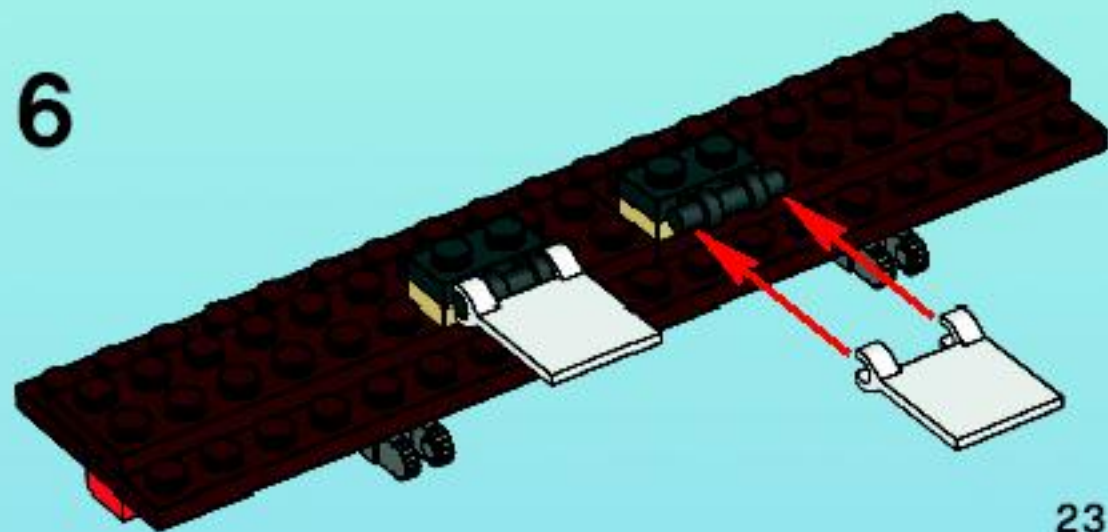

7

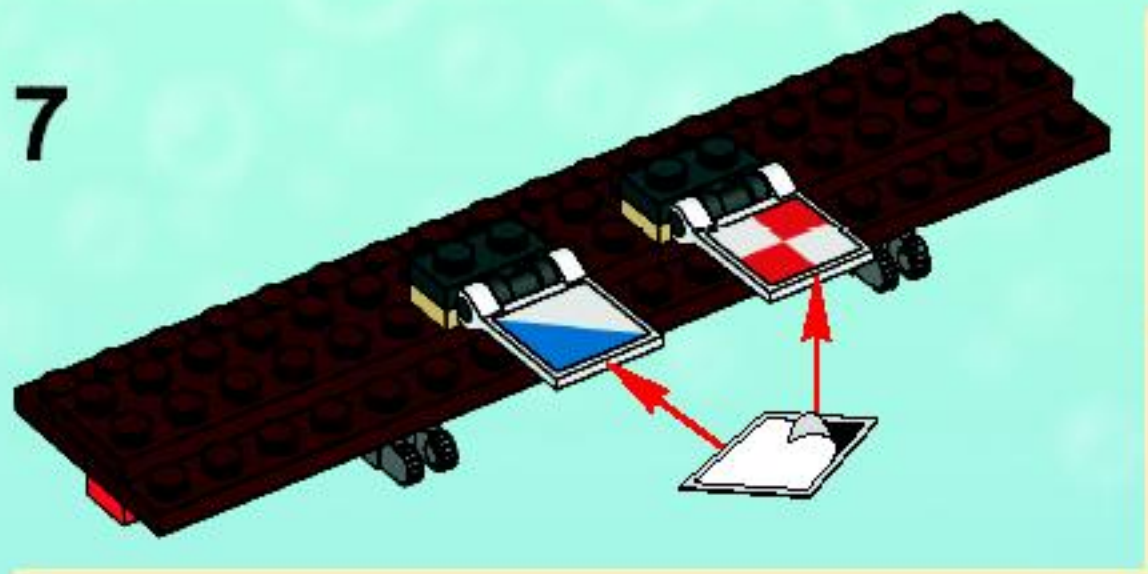

19

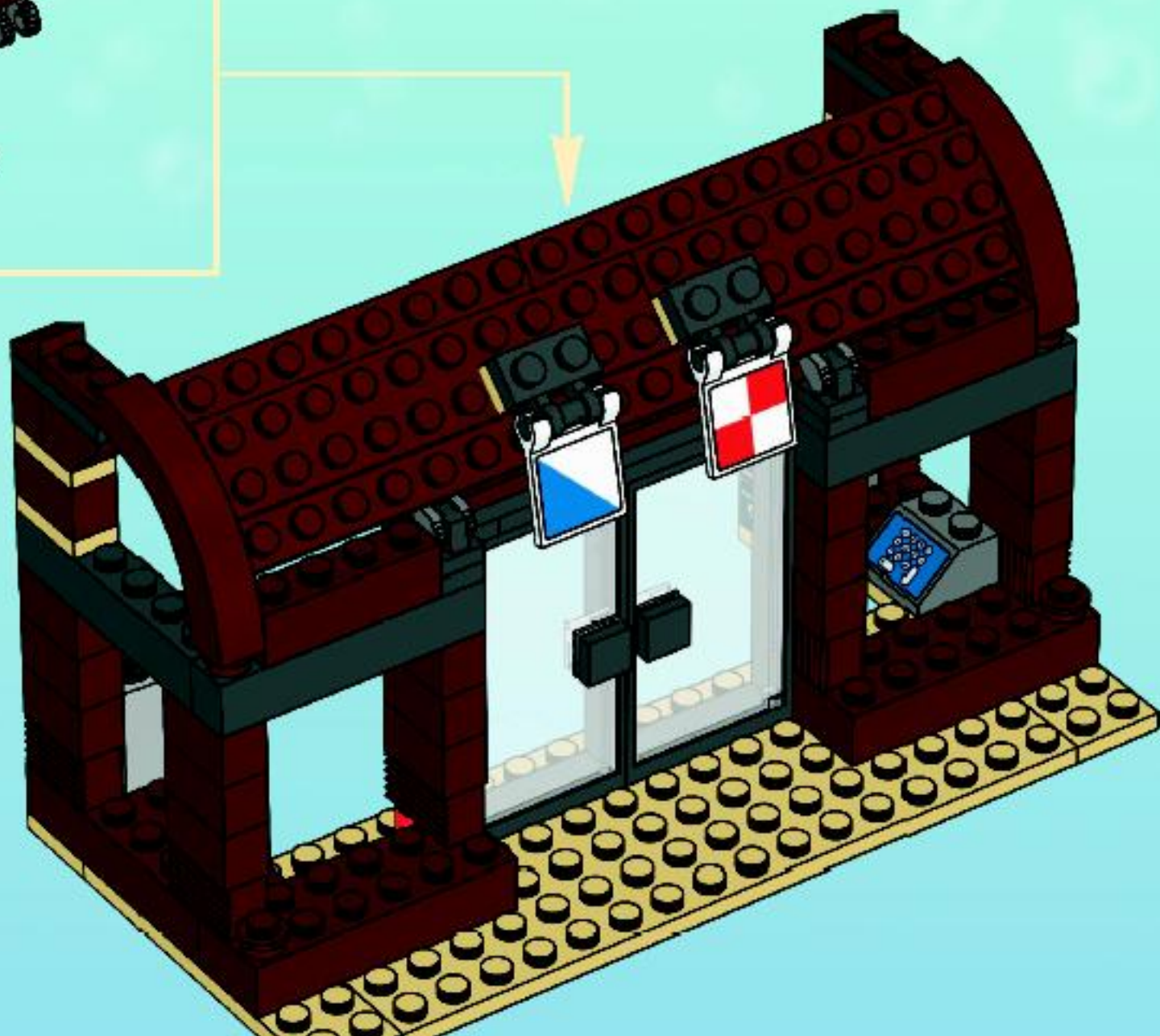



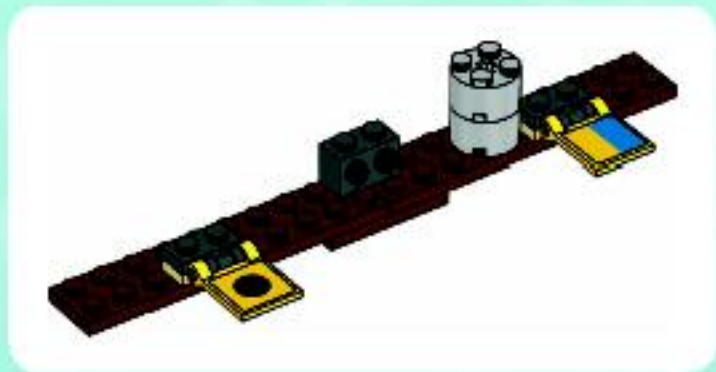

1



2

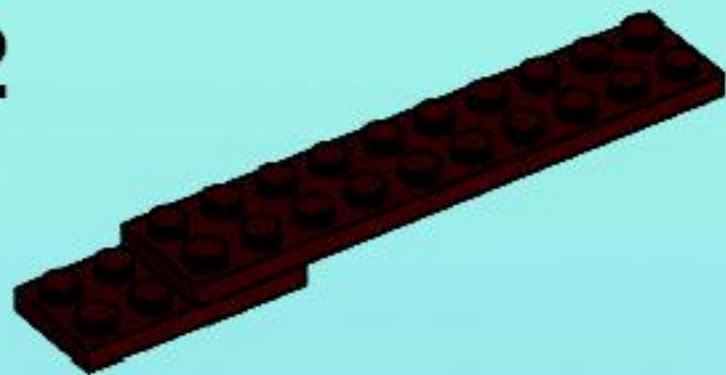

3



4

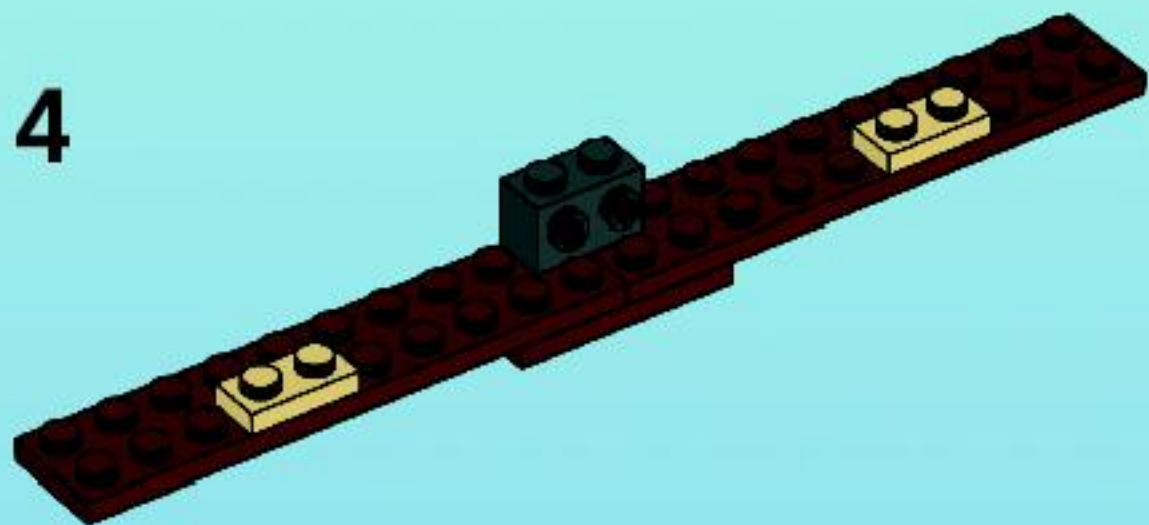

5

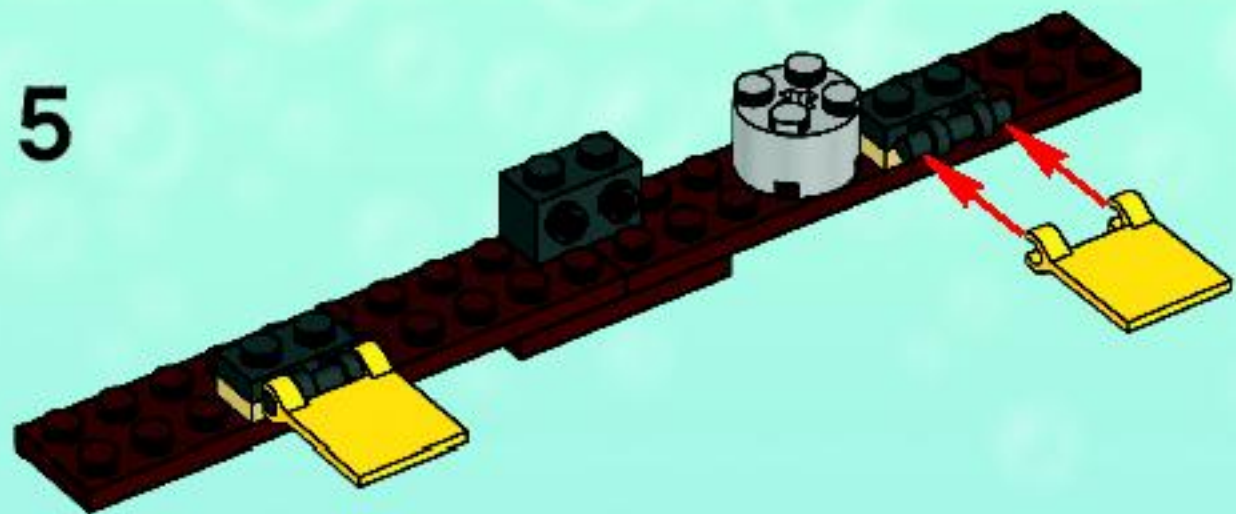

6

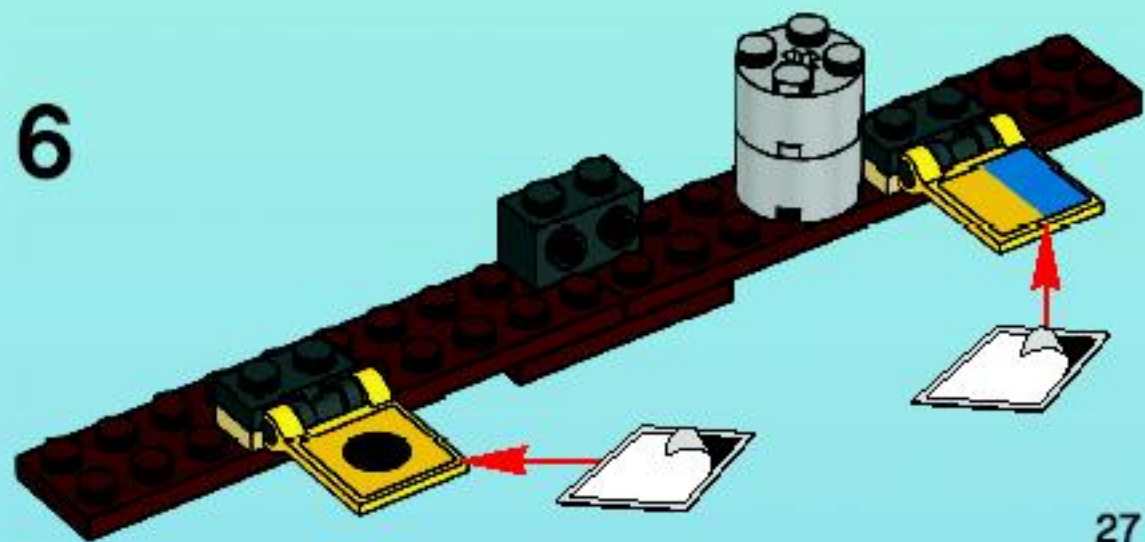

20

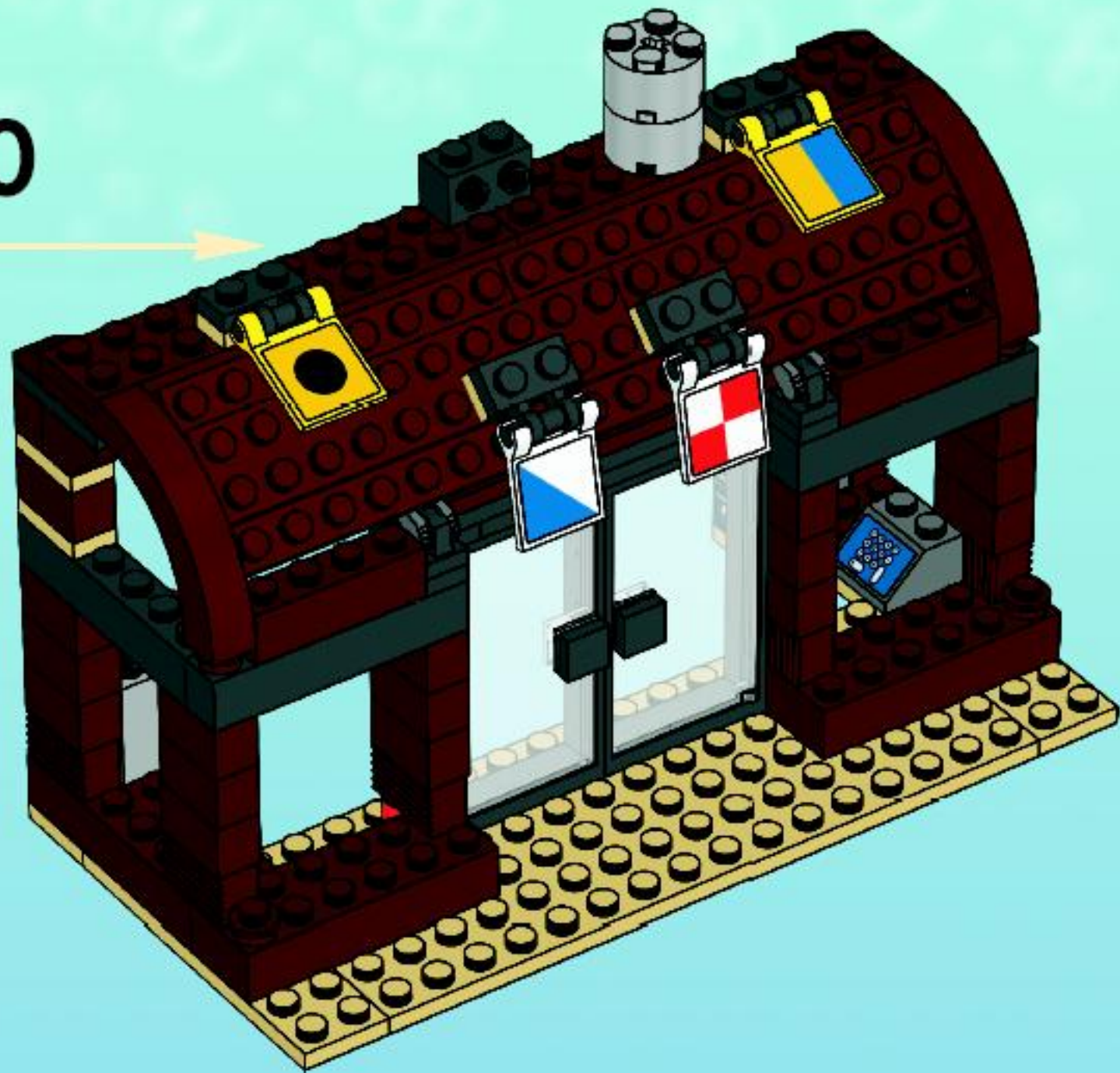

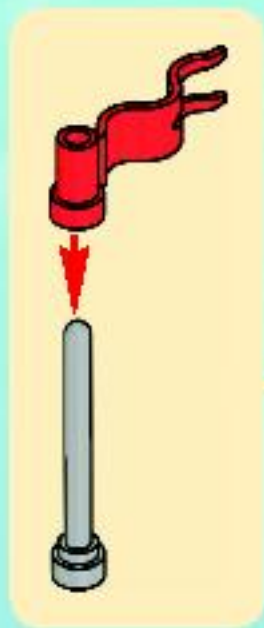



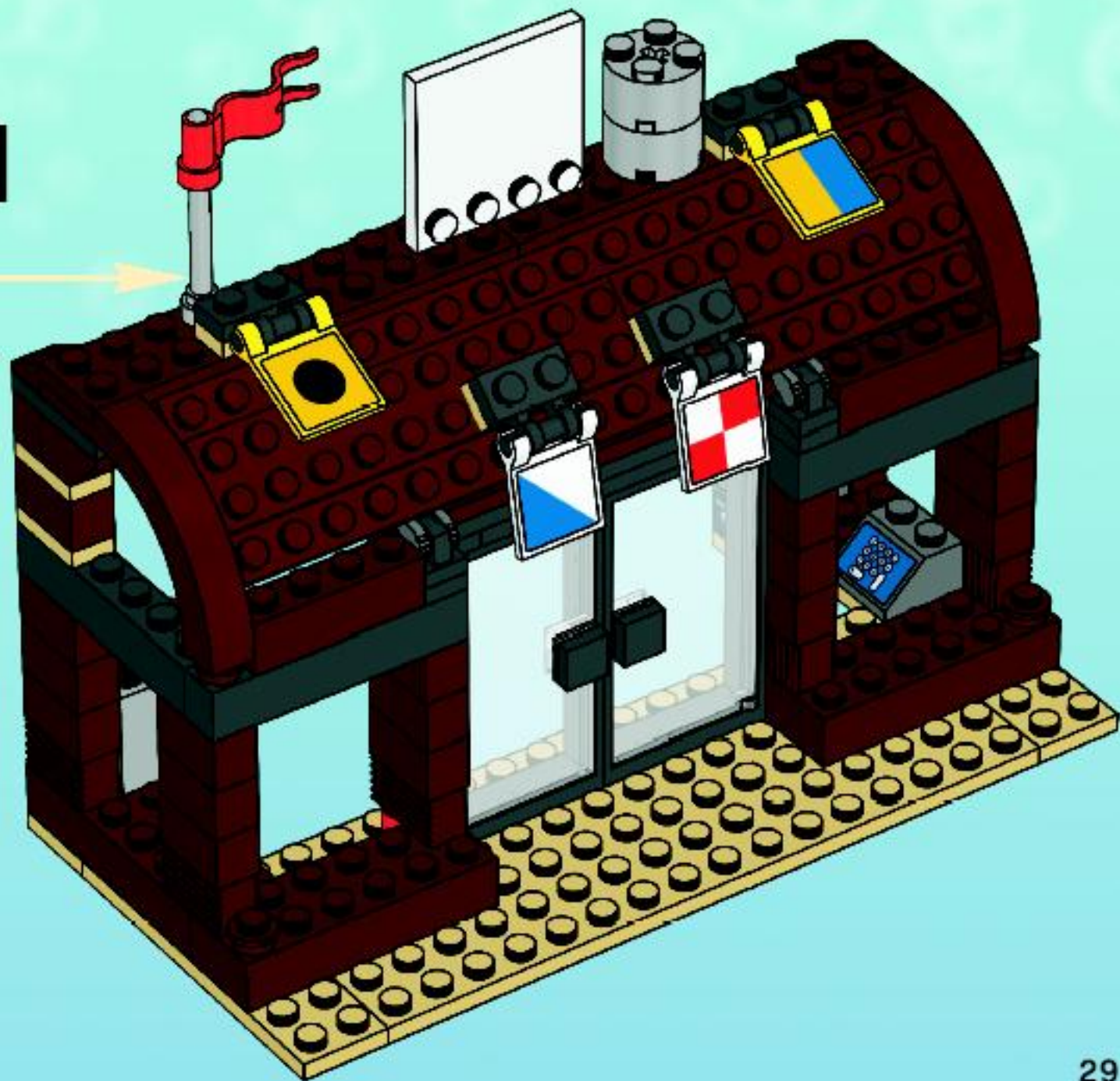

21

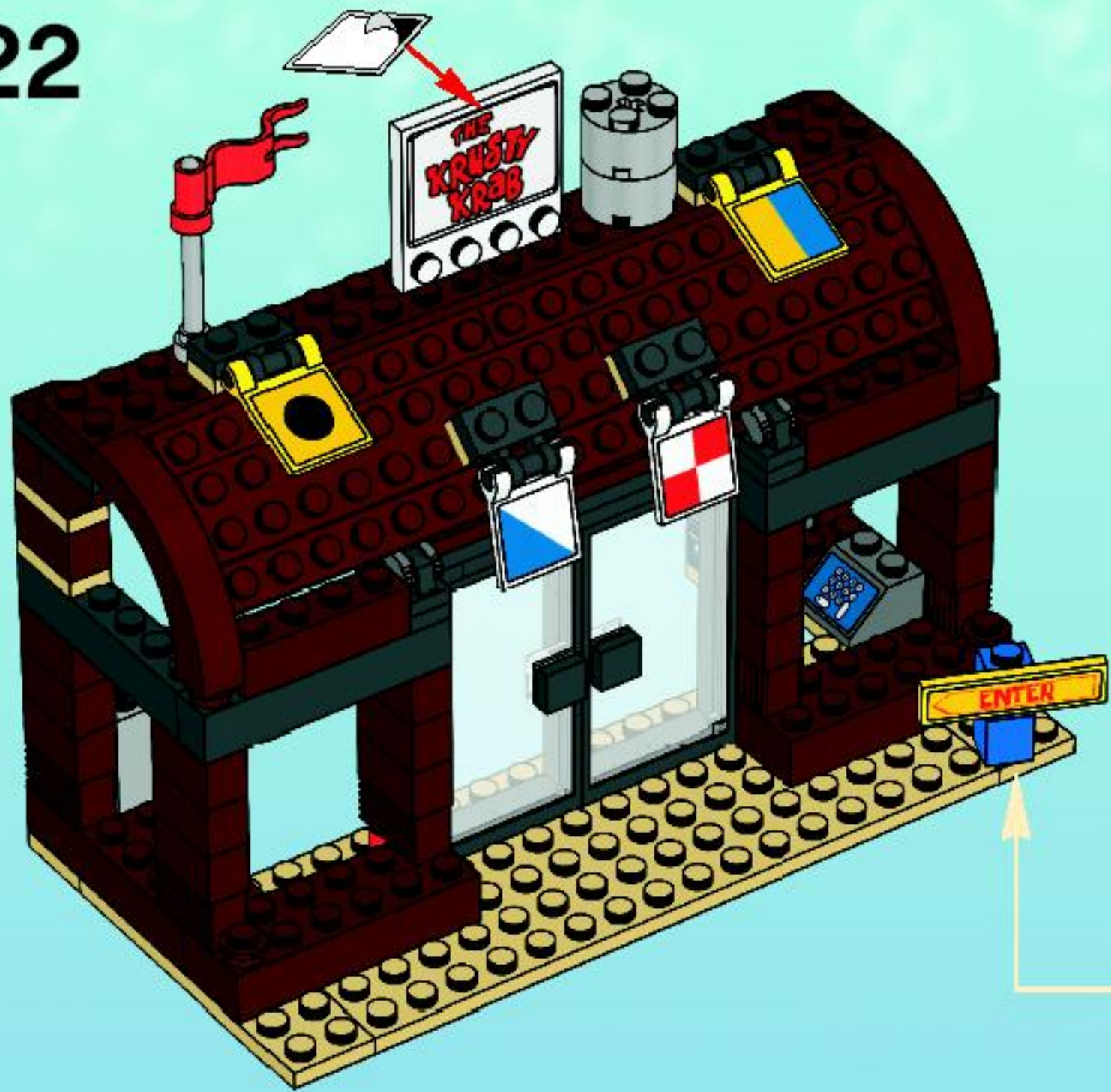

22

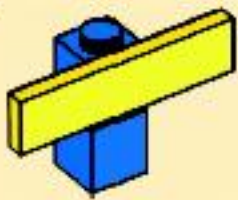

- 1 
- 2 
- 3 

# 23



1



2



3



24

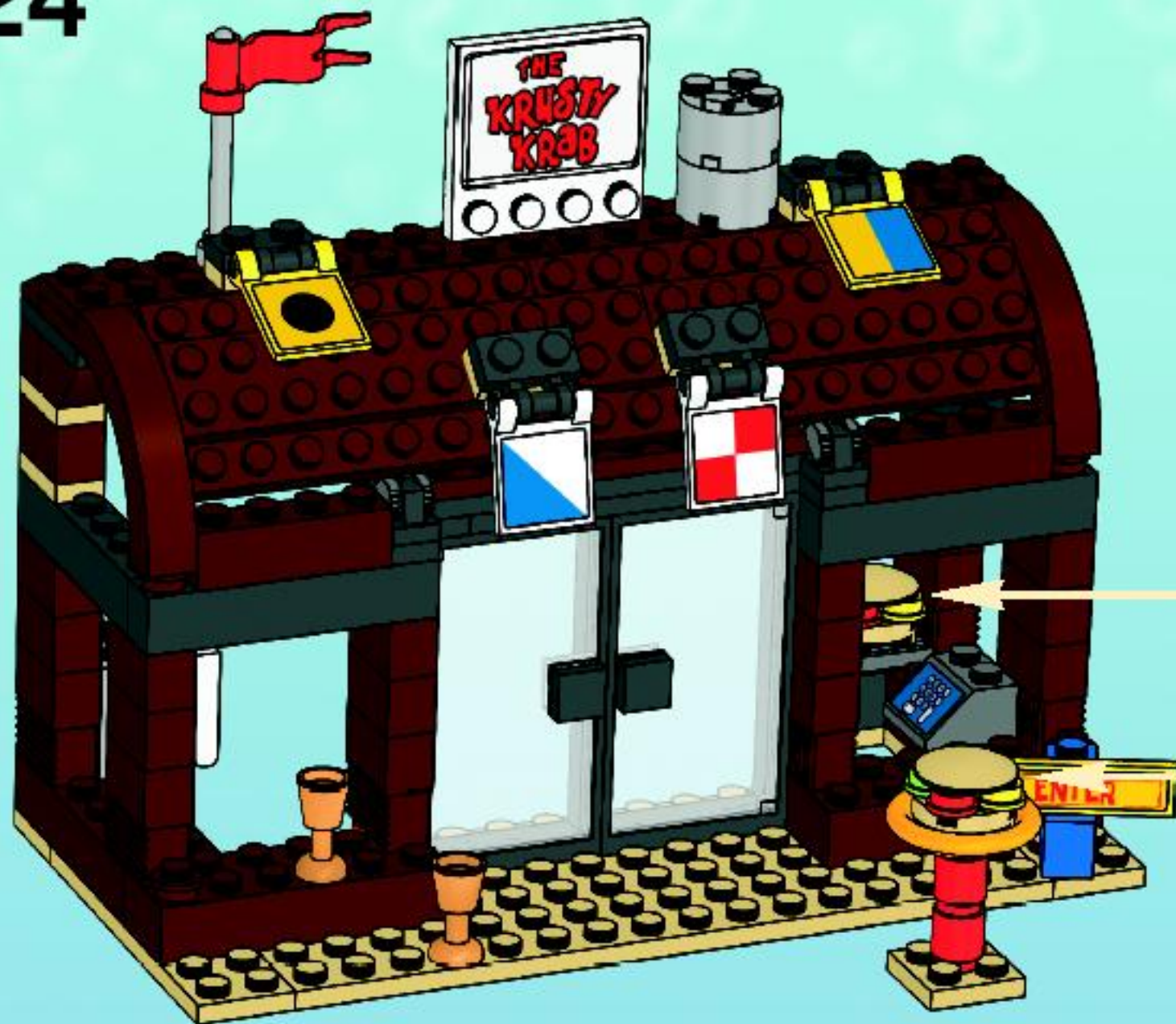

1



2



3



2x



25





1

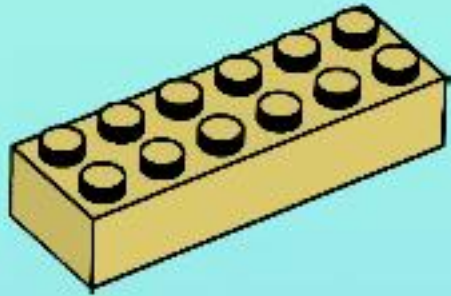

2



3



4

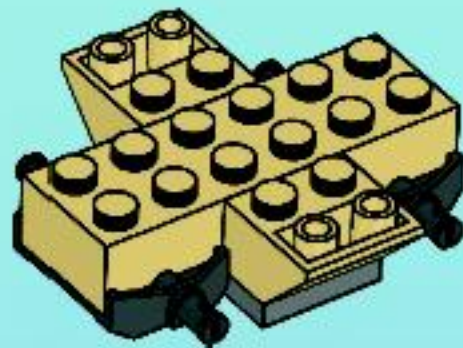

5

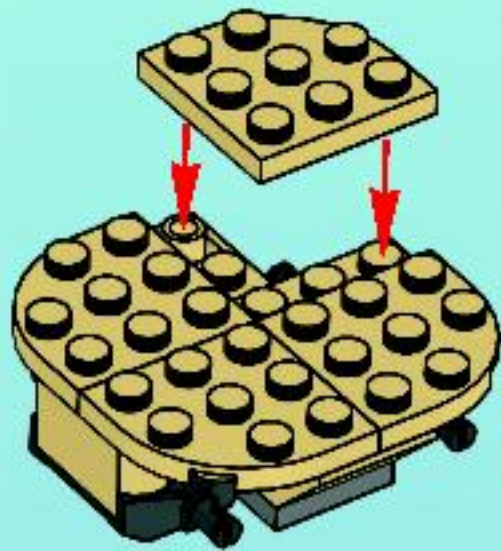

6



7

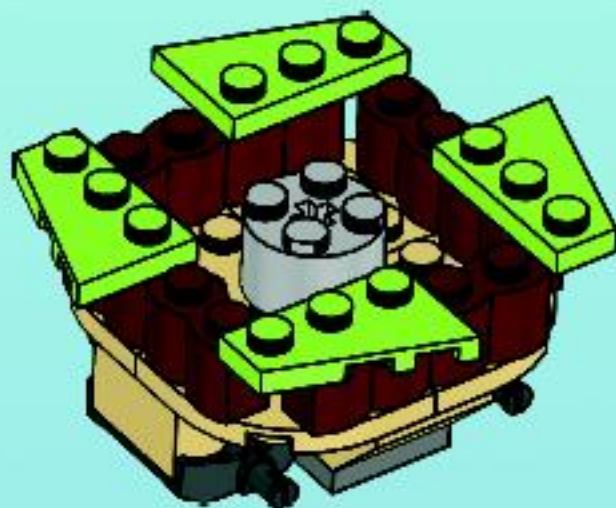

8



9



10

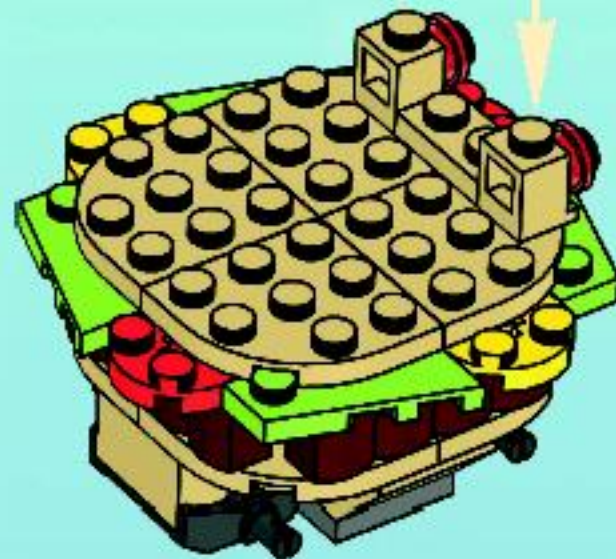
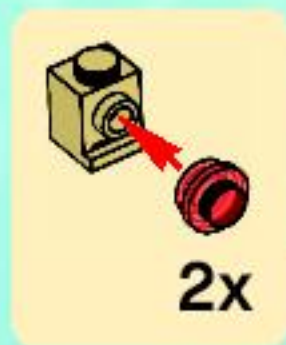

11

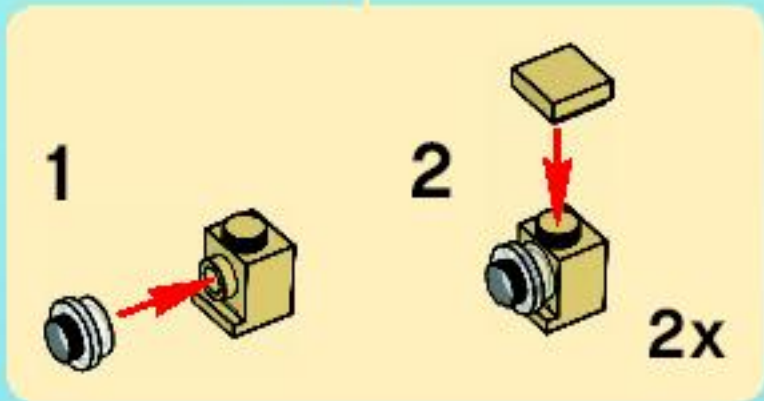
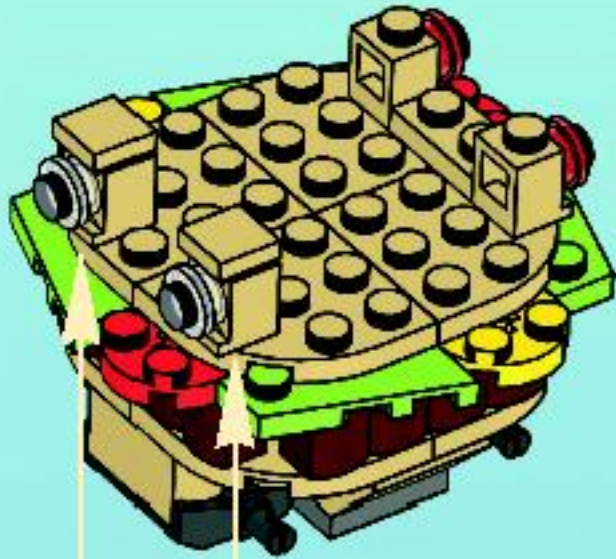

12

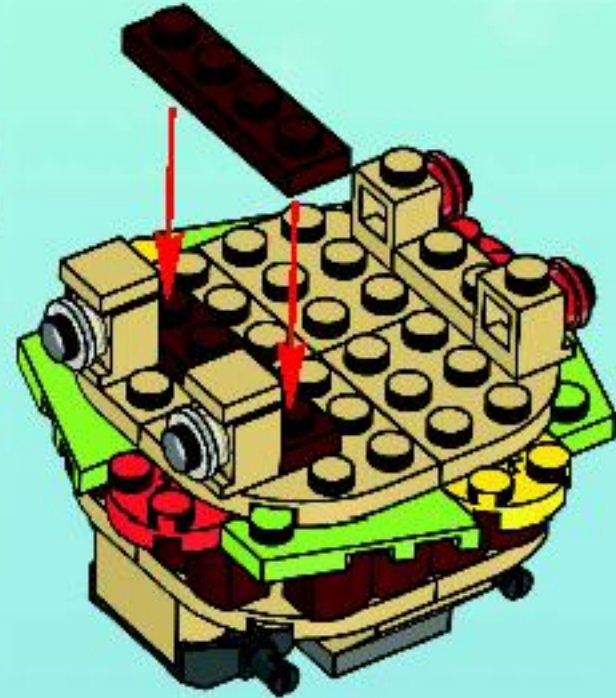

13

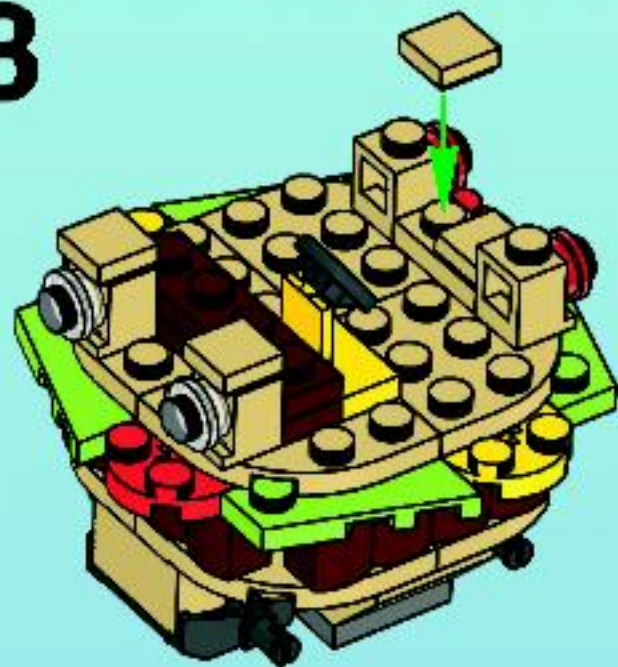

14

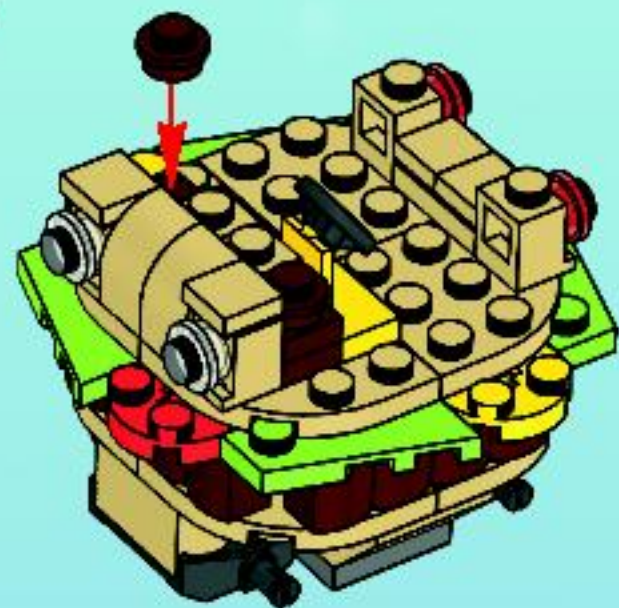



15



16

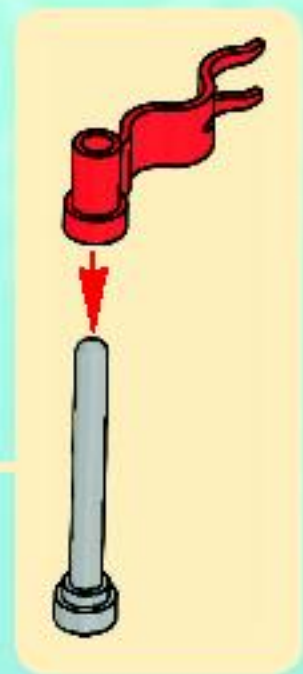
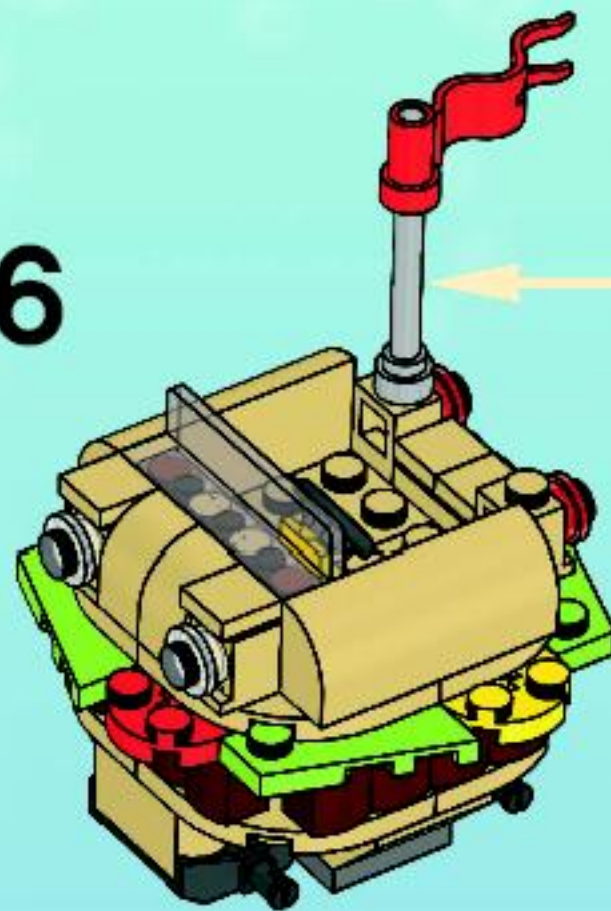

17

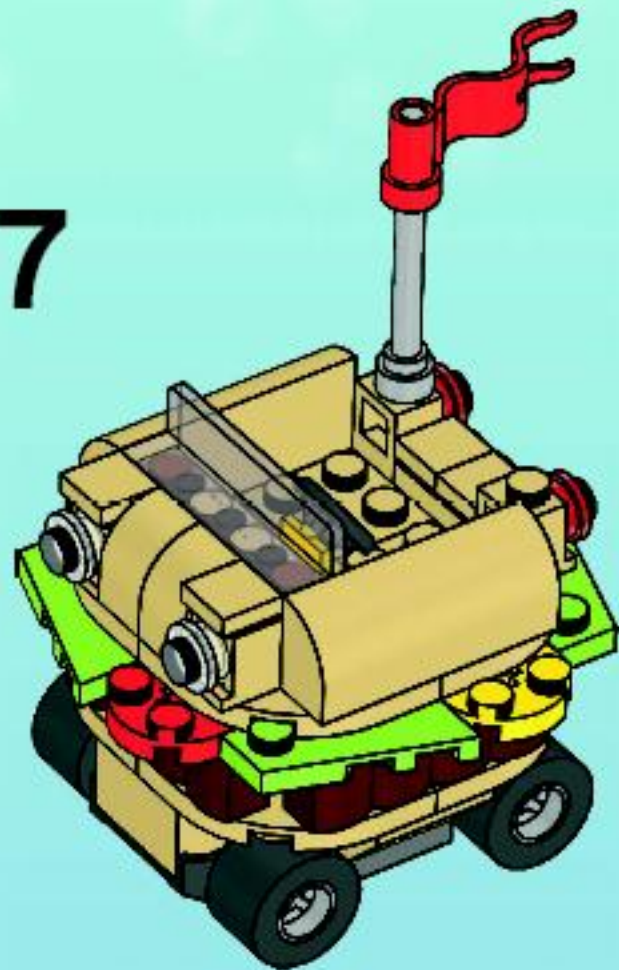

18



  
2x  
4523403

  
1x  
434601

  
1x  
617901

  
1x  
4201201

  
1x  
4243920

  
2x  
4211242

  
6x  
4223303

  
2x  
4504376

  
2x  
4211222

  
8x  
4216581

  
1x  
4270443

  
21x  
4211149

  
4x  
4211181

  
2x  
4211225

  
4x  
4216615

  
2x  
4541894

  
2x  
4211190

  
1x  
4223683

  
1x  
4211186

  
3x  
4211211

  
5x  
4211214

  
1x  
4543329

  
1x  
4293489

  
1x  
4293446

  
1x  
4543327

  
1x  
389921

  
2x  
403221

  
6x  
306221

  
2x  
614121

  
2x  
371021

  
2x  
449521

  
1x  
407023

  
1x  
300523

  
1x  
4543857

  
1x  
4543939

  
4x  
4118793

  
2x  
4273526

  
4x  
4125253

  
9x  
4113917

  
2x  
4278422

  
1x  
4114084

  
2x  
4140562

  
2x  
4118790



Customer Service

Kundenservice

Service Consommateurs

Servicio Al Consumidor

[www.lego.com/service](http://www.lego.com/service) or dial



00800 5346 5555 :



1-800-422-5346 :





NICKELODEON

# SpongeBob SQUAREPANTS

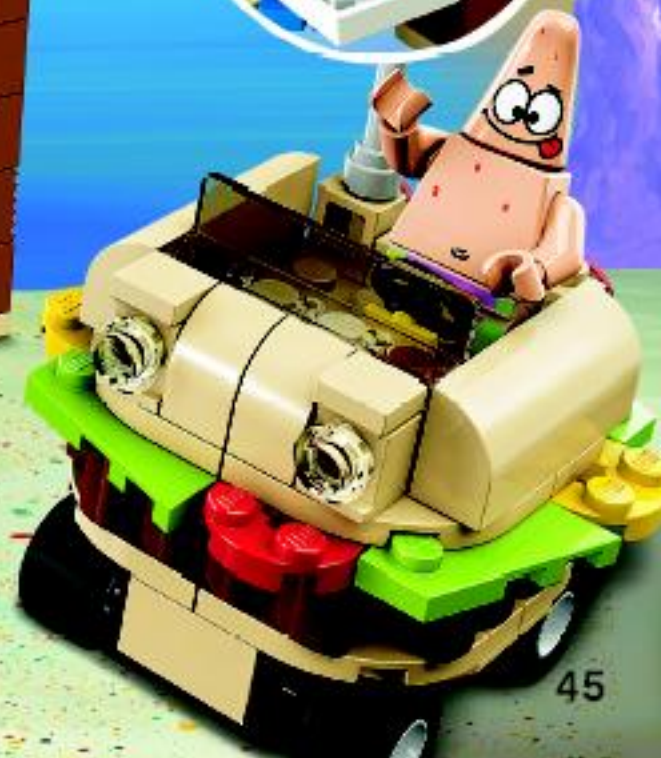



NICKELODEON

# SpongeBob SQUAREPANTS

3834



46



**FREE! GRATIS! GRATUIT!**



**club**  
MAGAZINE™

**www.LEGOclub.com**



**00800 5346 5555\***        

  **1-866-534-6258 • 1-877-518-5346**

US & Canada only

Canada seulement

\* FreePhone. Mobile charges may apply. \* Numéro sans Frais. Des Frais peuvent s'appliquer avec les téléphones cellulaires. \* Gebührenfrei, nur bei Anbietern für Mobilfunknetze können abweichen. \* Grátis telefonnummer vanaf vastelijn. \* Het er is gratis nummer, vóór de ringen Fra PostTelefon. \* Het er gratis, når du ringer Primen Fast Telefon.



VISIT THE WORLD'S  
BIGGEST LEGO® SHOP!

**www.LEGOshop.com**



## WIN LEGO® PRODUCTS

Fill out a survey and you might WIN a cool LEGO product  
NO PURCHASE NECESSARY

Open to all residents where not prohibited

Go to [www.nielsen.com/LEGO](http://www.nielsen.com/LEGO) to fill out a survey for a chance to win

a LEGO product.

## WIN LEGO® PRODUCTEN

Vul een enquêteformulier in en maak kans op een cool LEGO® product!

Kopen niet nodig

Iedereen uit landen waar geen enquêteverbod geldt mag deelnemen.

Ga naar [www.nielsen.nl/LEGO](http://www.nielsen.nl/LEGO), vul een enquêteformulier in en

maak kans op een LEGO product.

## GEWINNE LEGO® PRODUKTE

Nimm an der Umfrage teil und GEWINNE ein tolles LEGO® Produkt!

Die Teilnahme am Gewinnspiel führt zu keinerlei Kaufverpflichtungen

Teilnahme in allen nicht ausgeschlossenen Ländern möglich

Wir verlosen unter allen Teilnehmern der Umfrage auf

[www.nielsen.de/LEGO](http://www.nielsen.de/LEGO) LEGO Produkte.

## GAGNE DES PRODUITS LEGO®

Réponds à un questionnaire et tu pourrais GAGNER un produit LEGO® très cool !

Aucune obligation d'achat.

Ouvert à tous les résidents des pays autorisés.

Visite [www.nielsen.com/LEGO](http://www.nielsen.com/LEGO) pour répondre à un questionnaire et

avoir une chance de gagner un produit LEGO.

## レゴ®製品を「当てよう」

アンケートに記入して、かっこいいレゴ®製品を当てよう！

お買い上げの必要はありません。

禁止されていない限り、すべての皆様にご利用いただけます。

[www.nielsen.com/LEGO](http://www.nielsen.com/LEGO)にアクセスして、アンケートに

ご記入ください。当選者にはレゴ®製品を差し上げます。

