



# THE HOBBIT

AN UNEXPECTED JOURNEY

79002





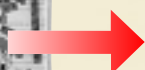
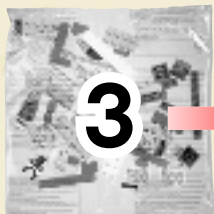
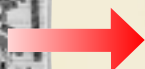

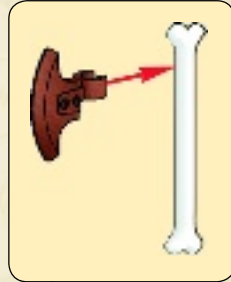
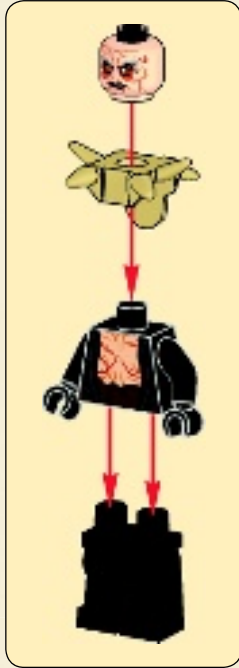

1



2



3

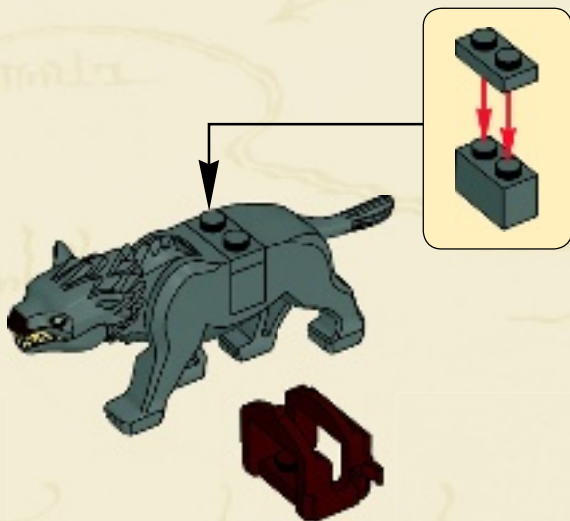

1

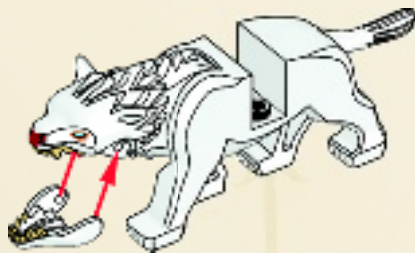

2



3

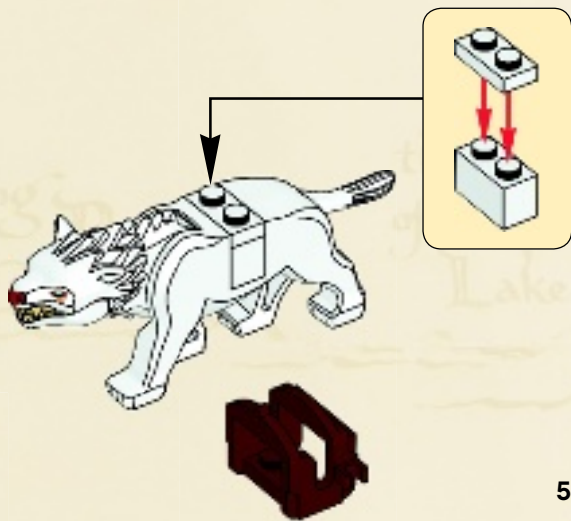

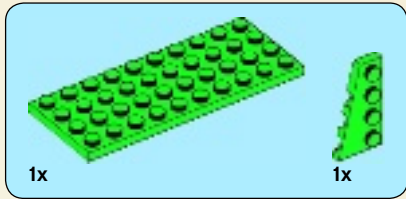

1

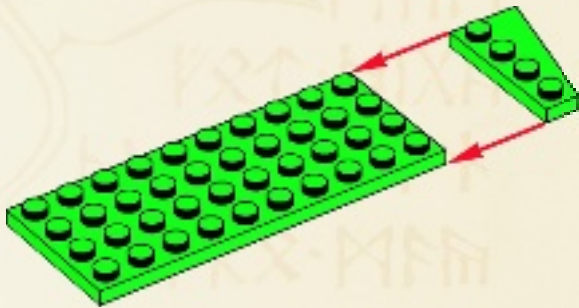

2

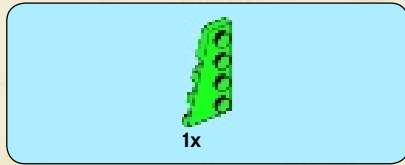

3





4

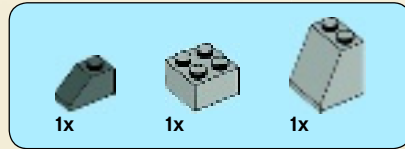
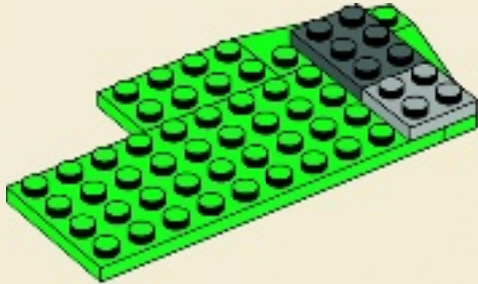

6

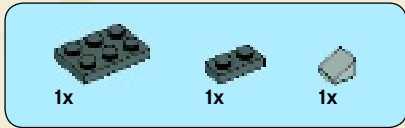
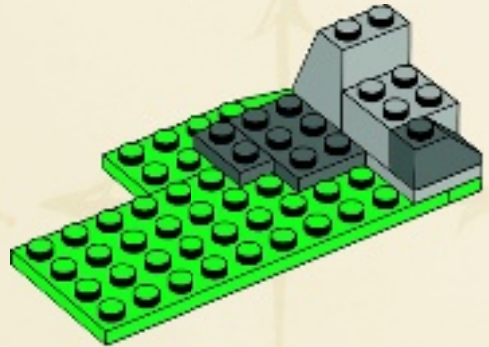

5

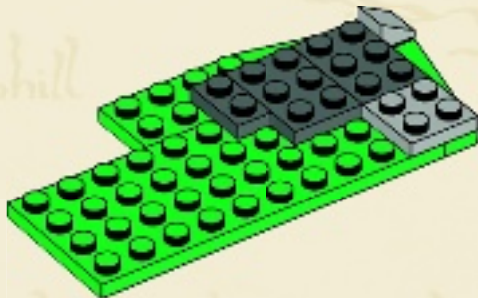

7





8

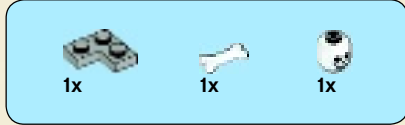
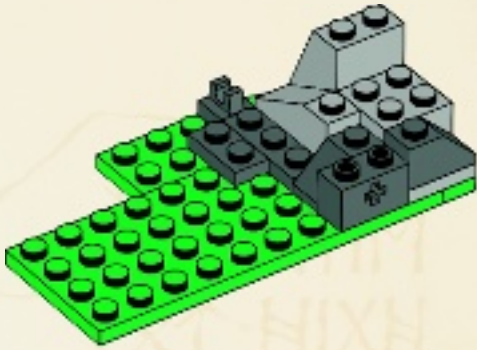

9

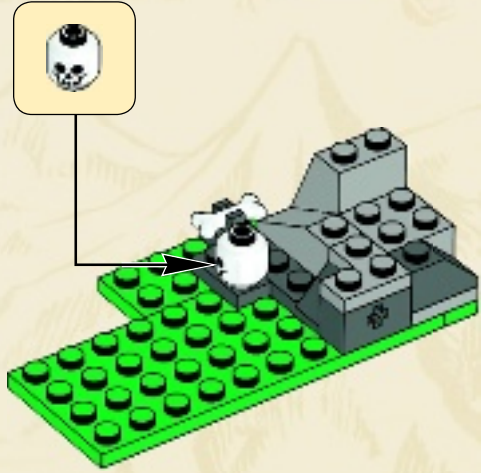



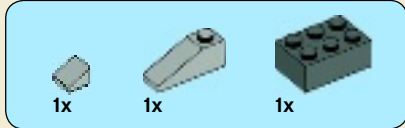

10

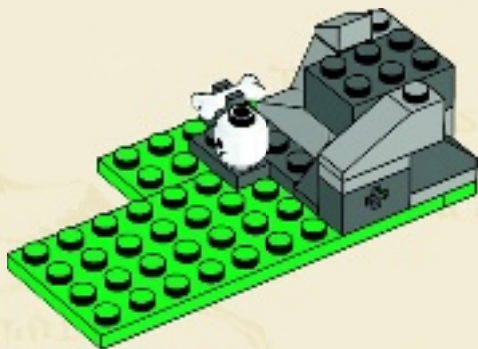

11





1x

# 12

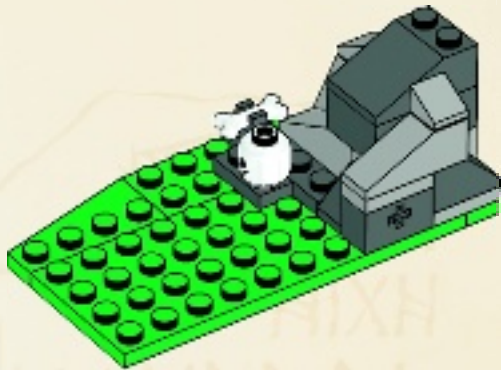

1x



1x

# 13

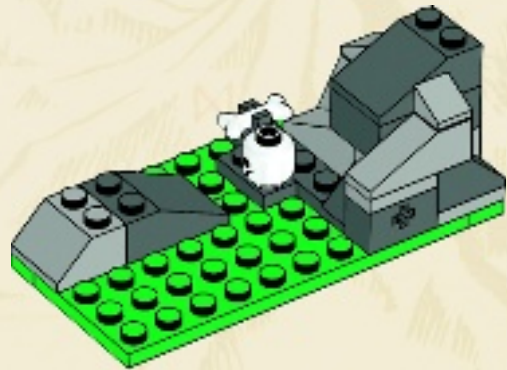



2x

14

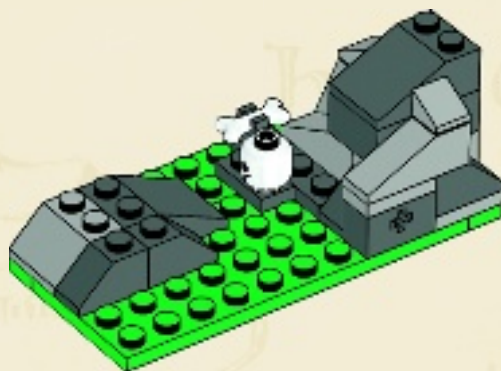

1x



1x

15





1x

16

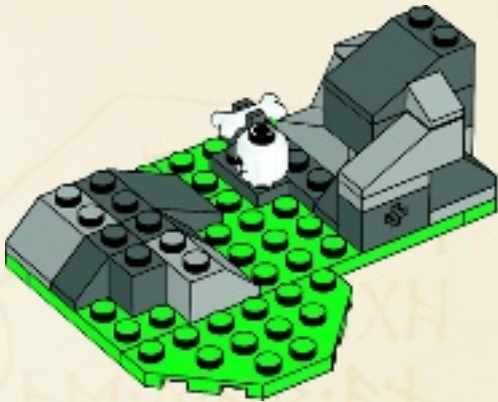

1x



2x

17

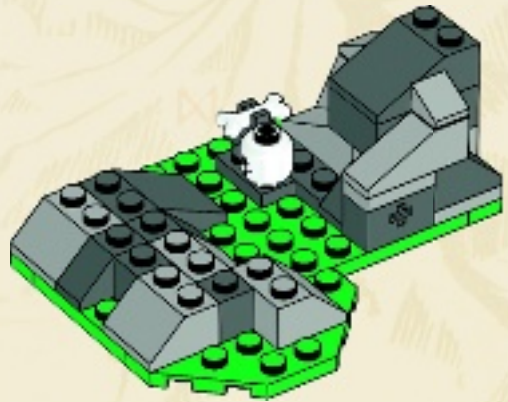



1x



1x

# 18

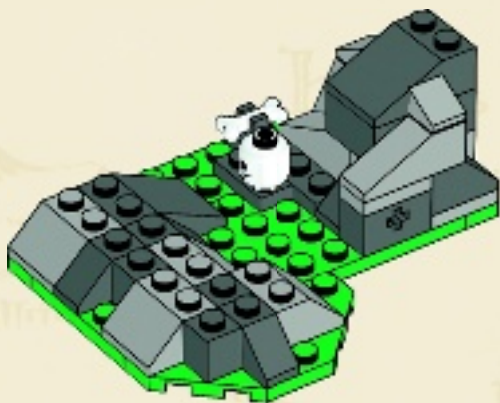

1x



2x



1x



2x

# 19

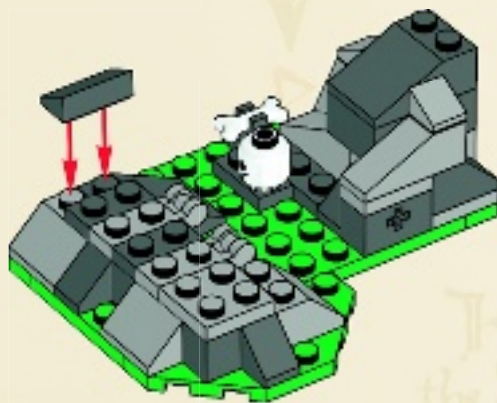

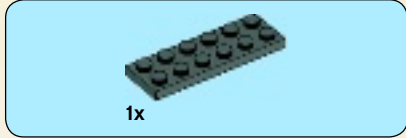

# 20

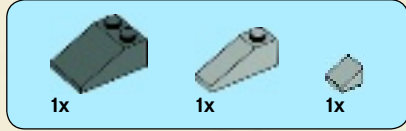
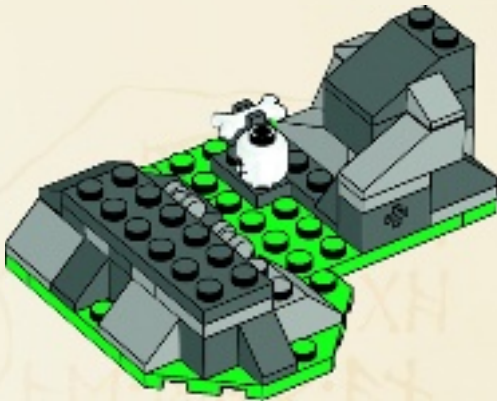

# 21

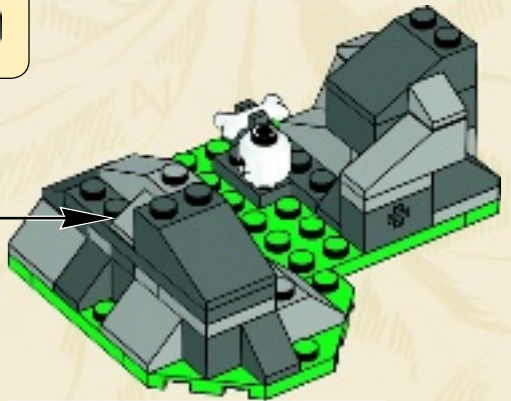

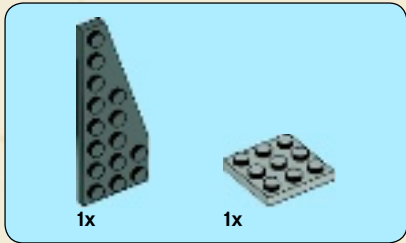

1



2

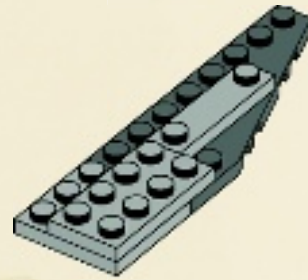

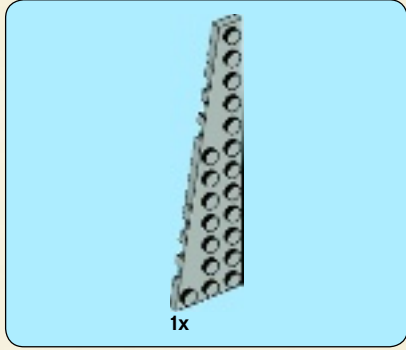

1x

3

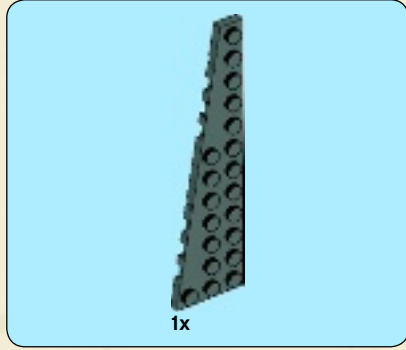
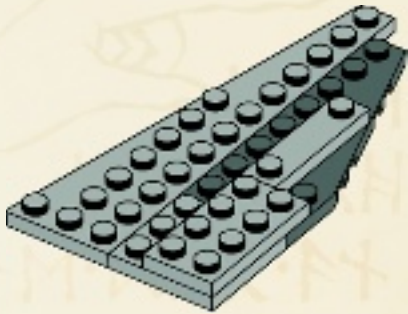

1x

4

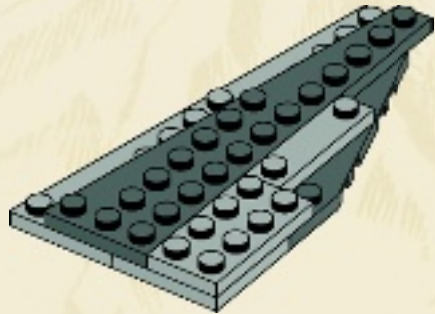





5

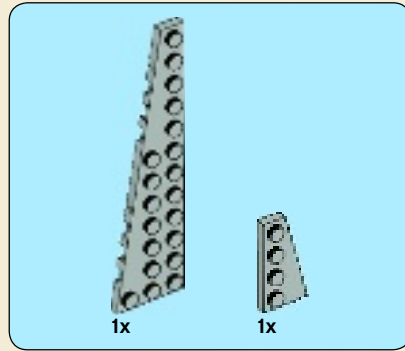
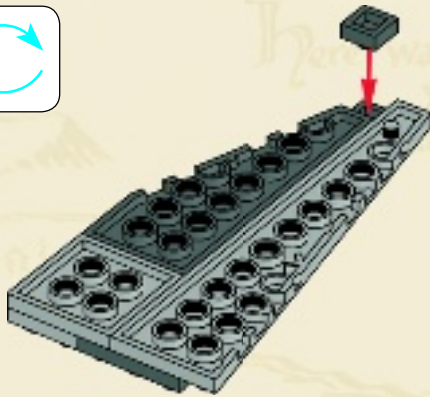
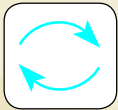

6

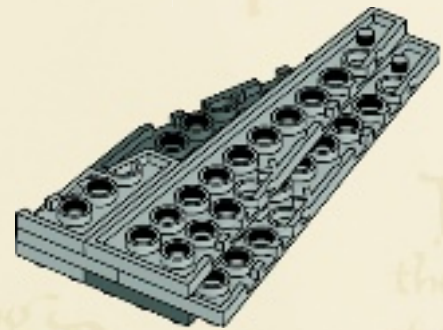



1x

7

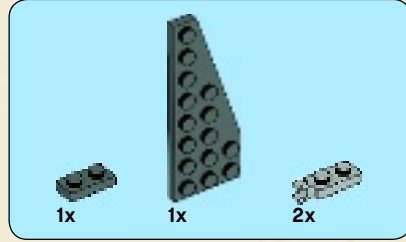
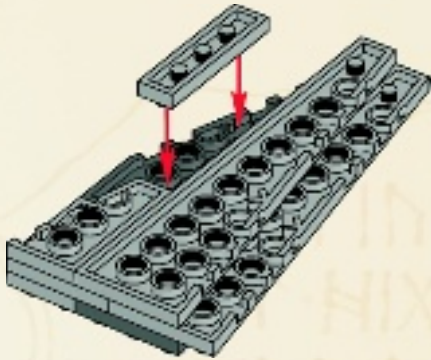

8

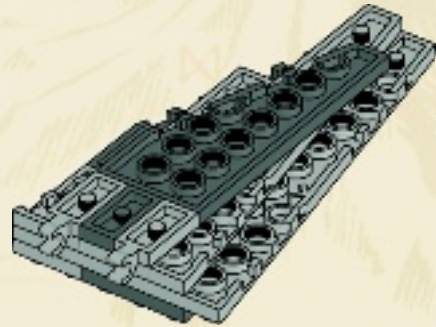



1x

9

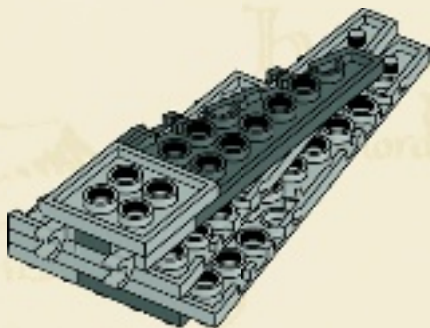

1x



1x

10

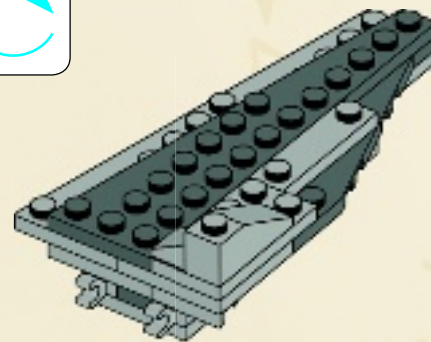
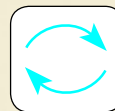

22

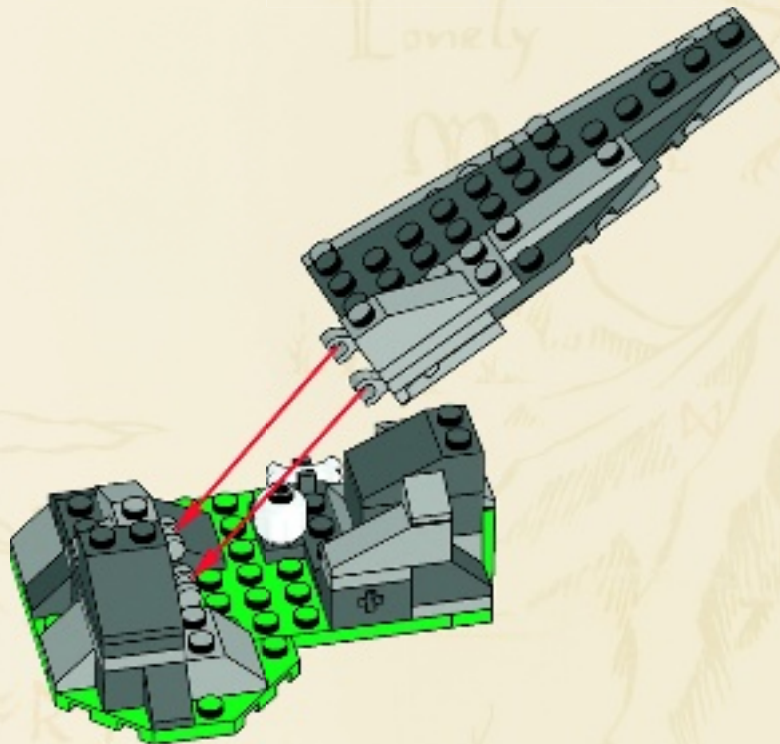

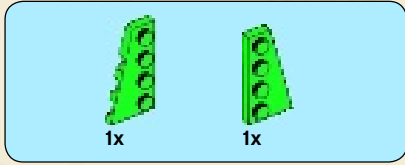

1

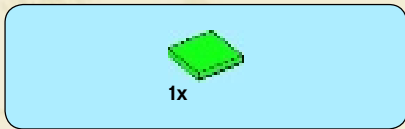
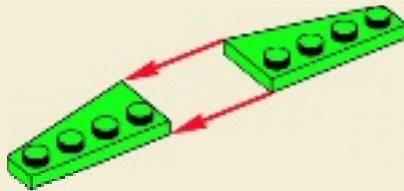

2

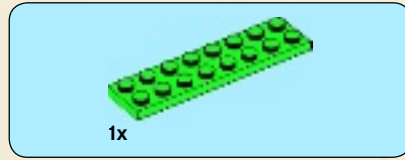
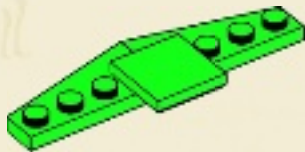

3

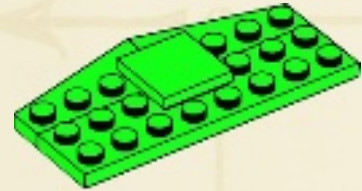

4

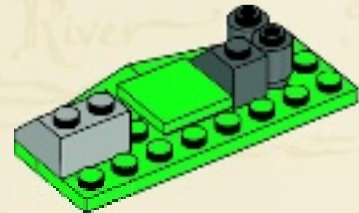



2x

5

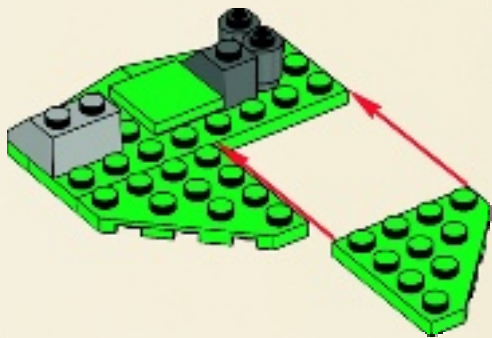

1x



1x

6



3x

7



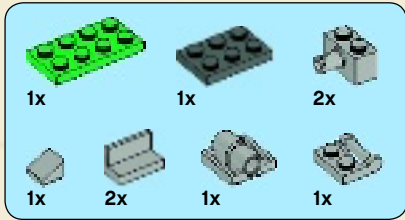

8

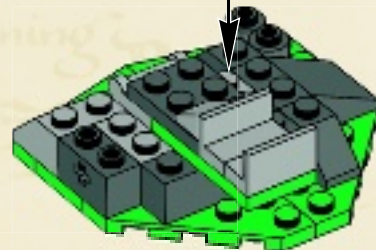
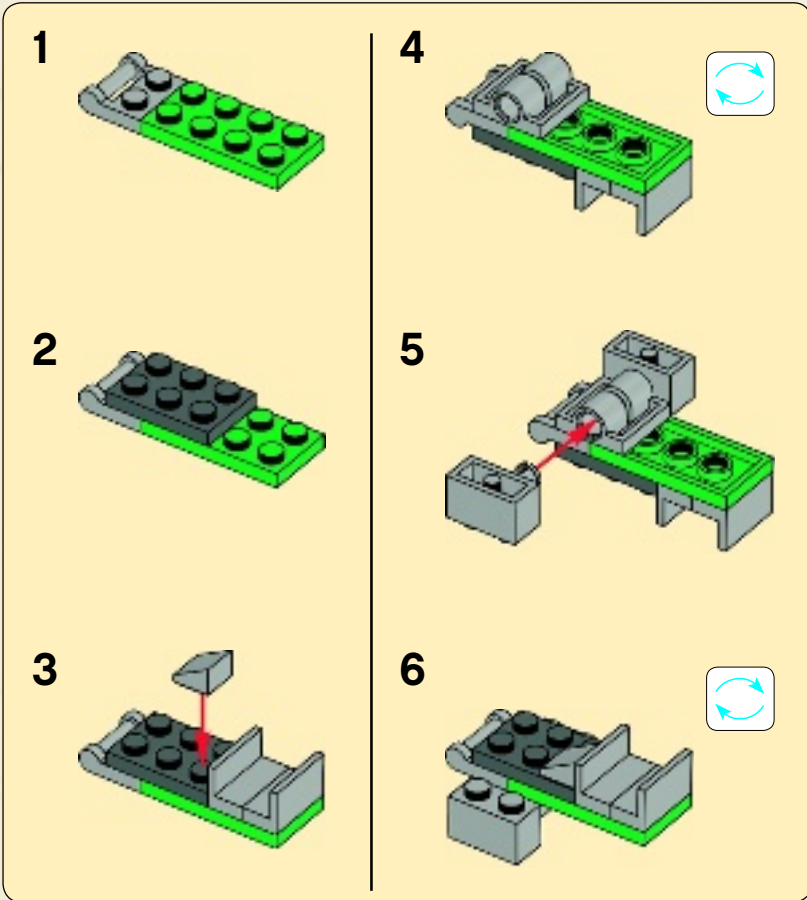

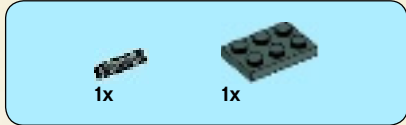

9

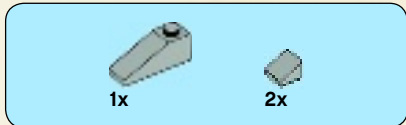
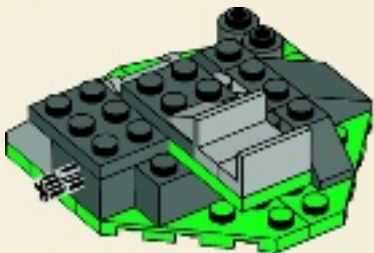

10

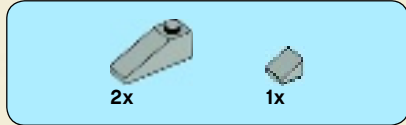



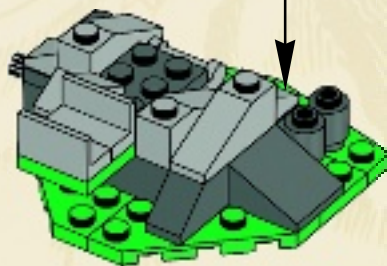
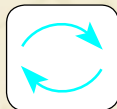



11

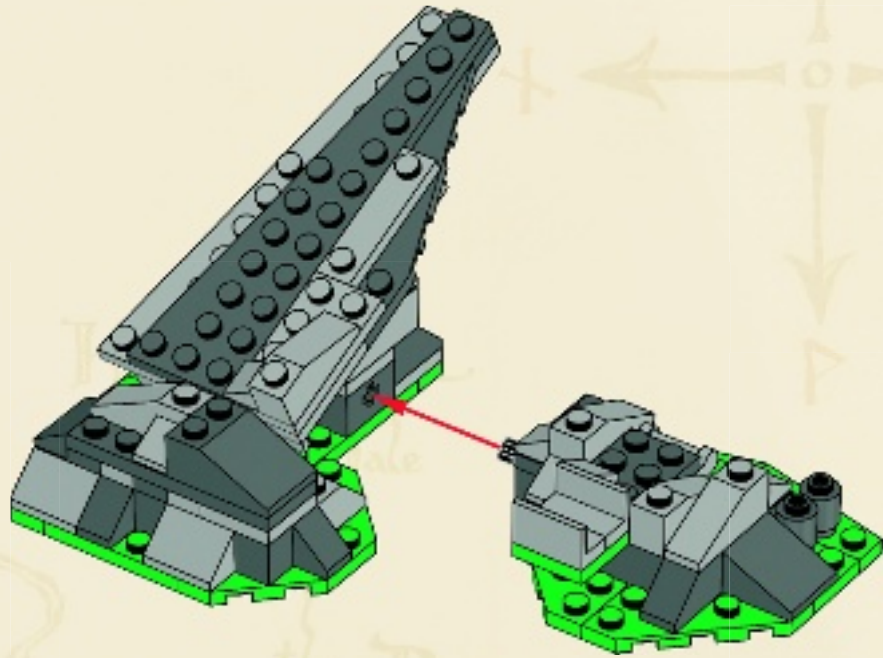



23



				
2x	2x	8x	8x	10x

# 24



↑ East lie the Iron Hills  
where is Dair

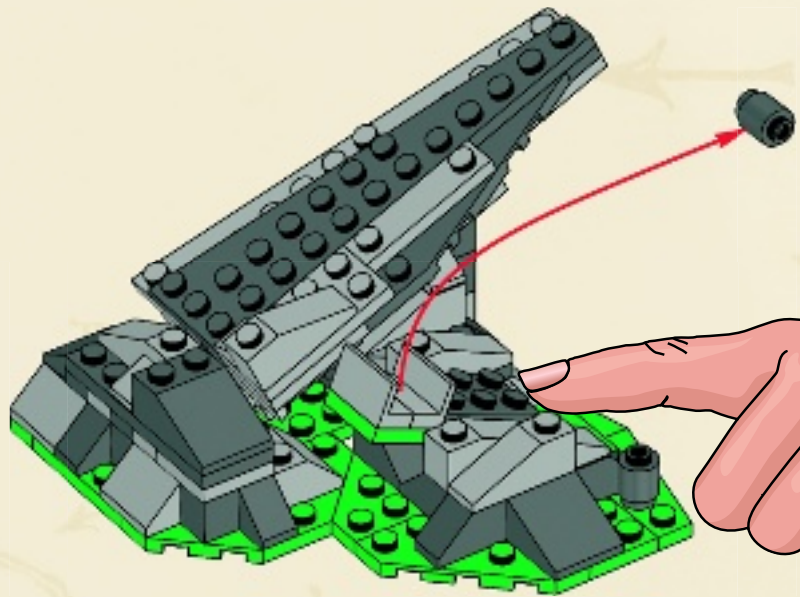

Amaly

Ravenhill



Running River

Here is  
the gateway  
of the Long  
Lake

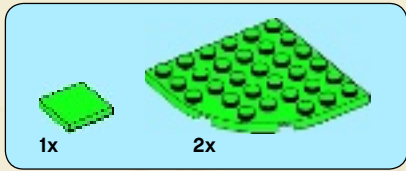

1

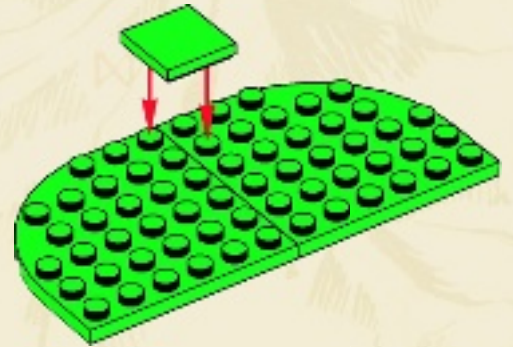
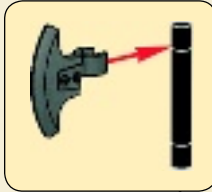

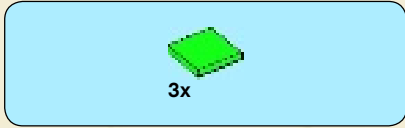

2

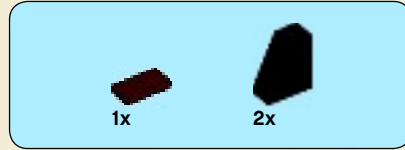
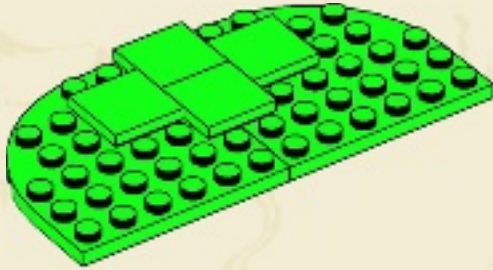

3

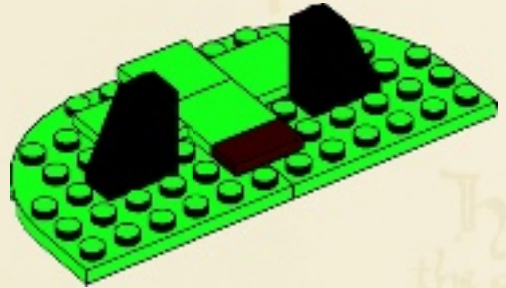

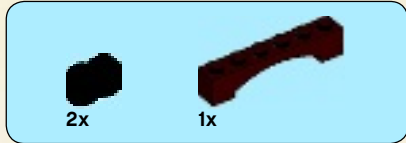

4

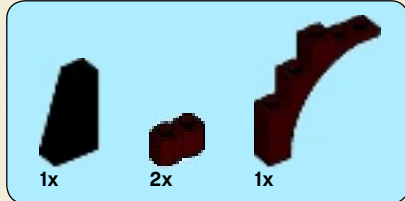
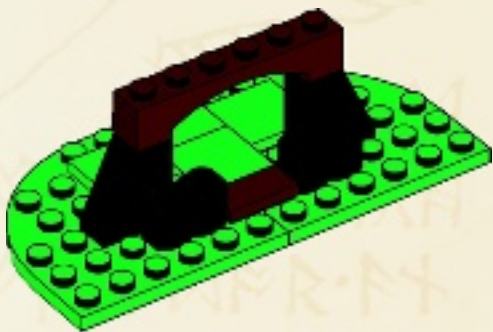

5

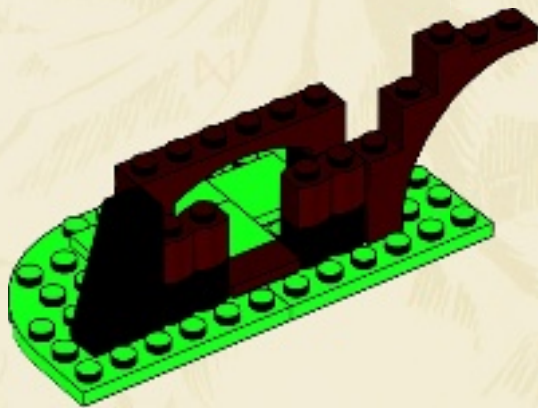

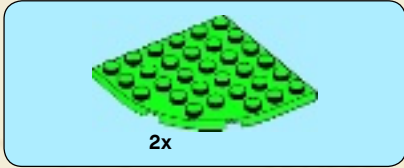

6

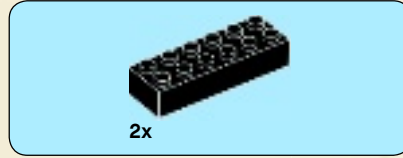
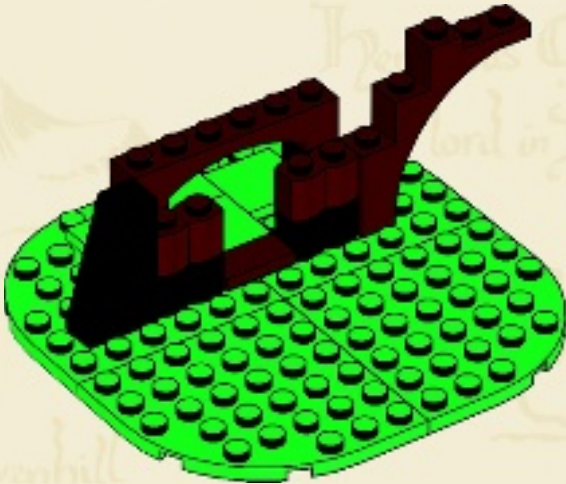

7

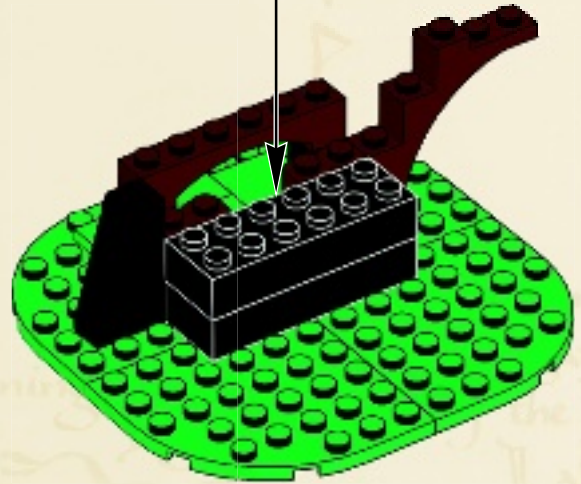
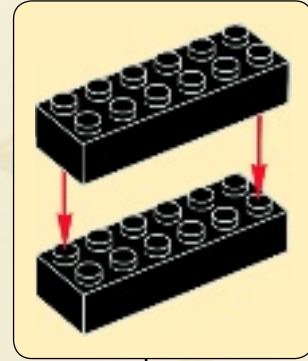



8

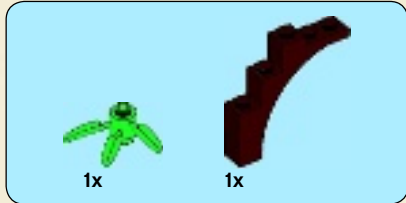
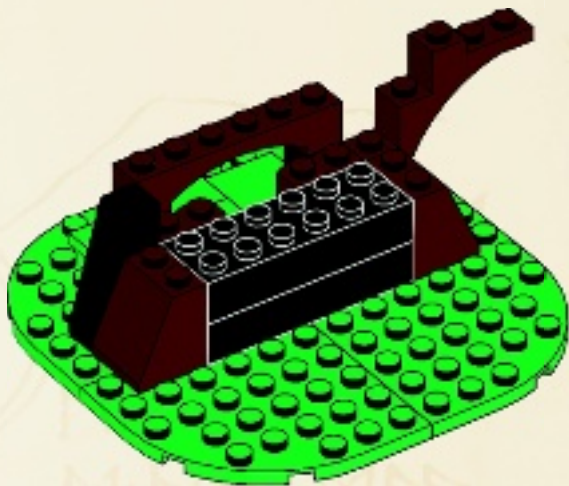

9

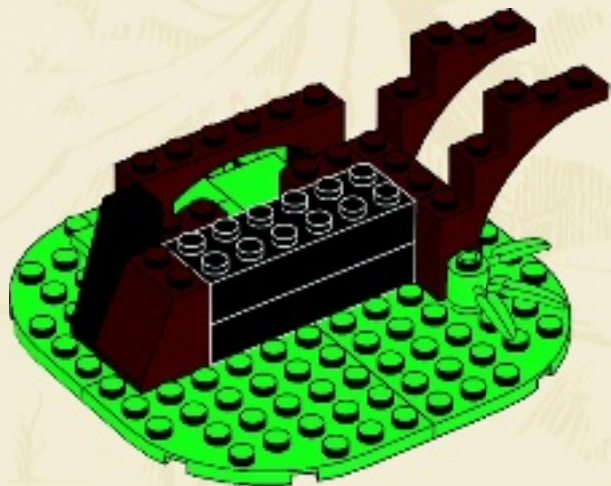





10

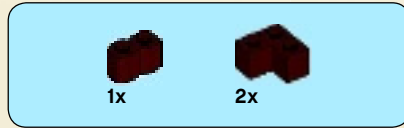
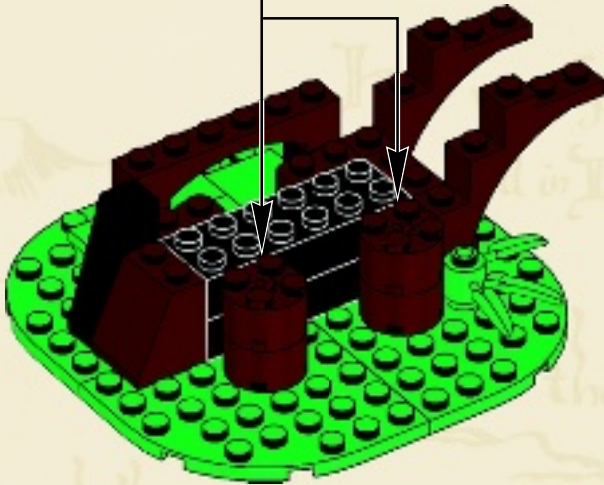

11

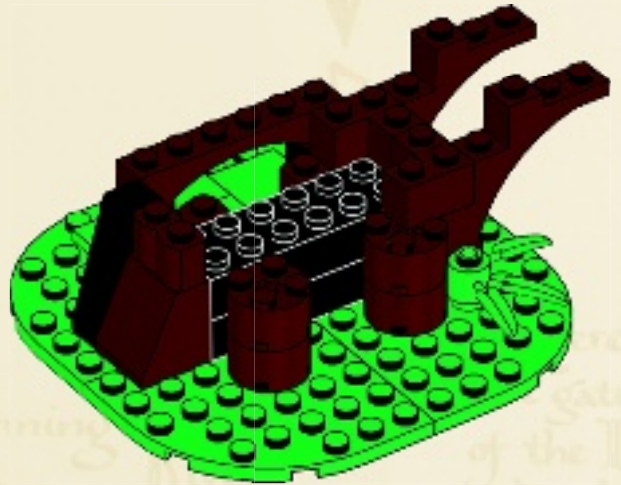



12

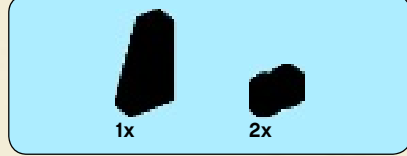
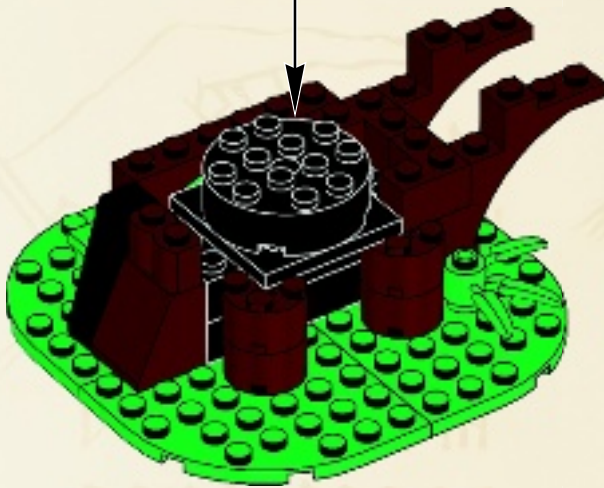
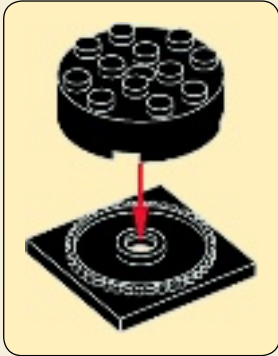

13

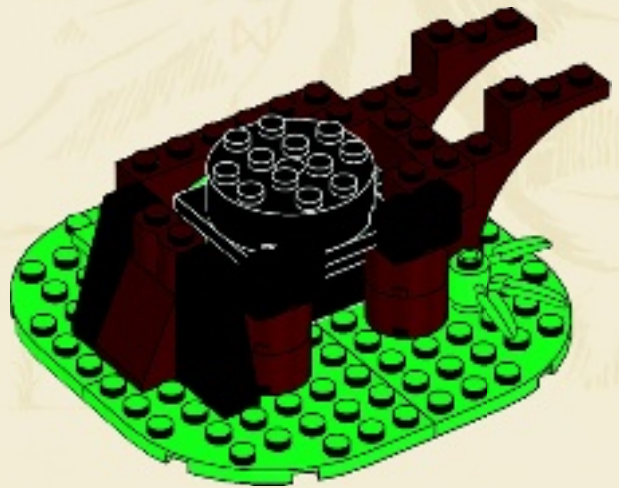



4x

14



4x

15

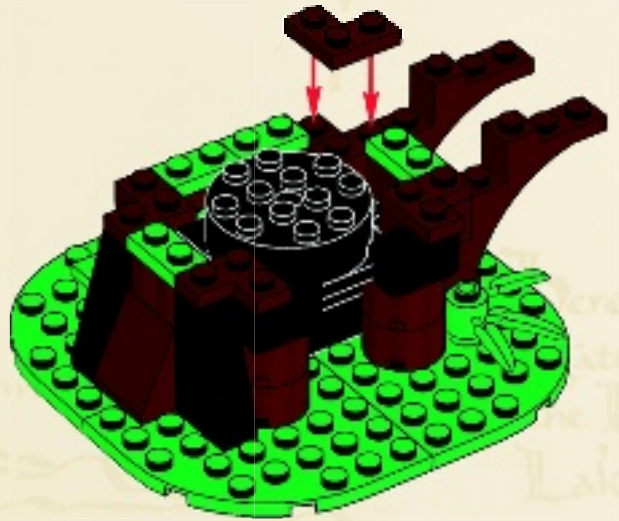



2x

16

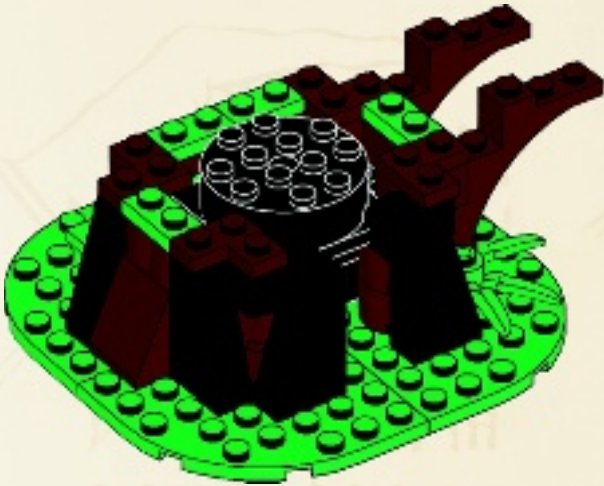

1x



1x

17

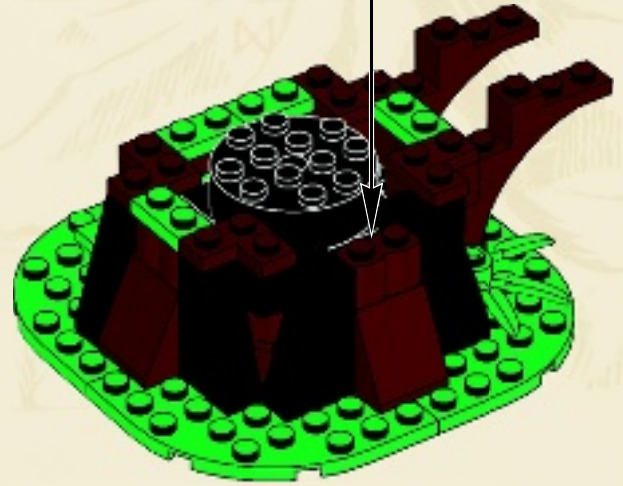
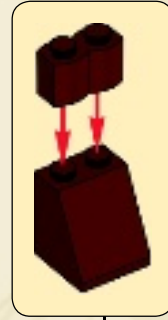



18

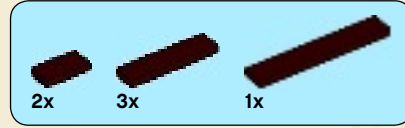

19

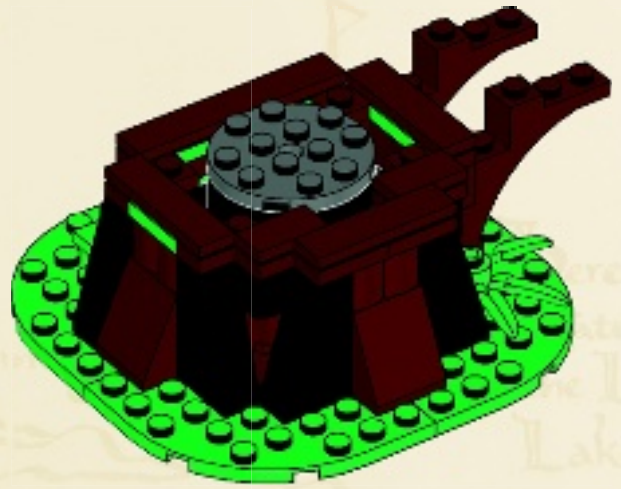

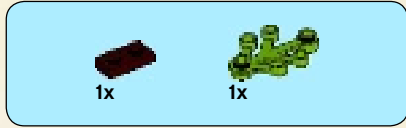

20



21



1x 2x 2x

22

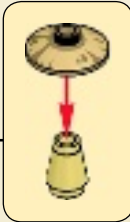
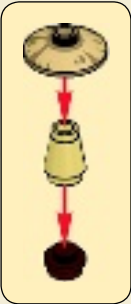

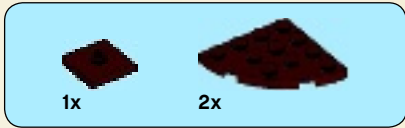

1



2



3







4



6



5



7



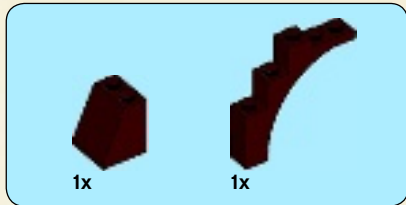

8

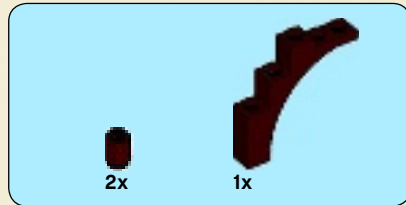

9

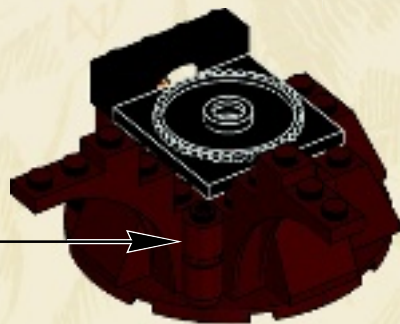
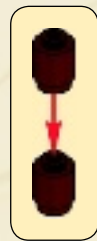

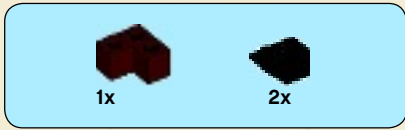

10

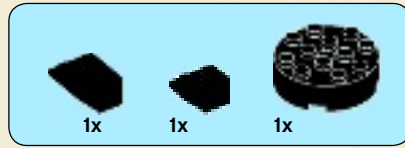
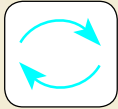

11





2x

# 12



# 13



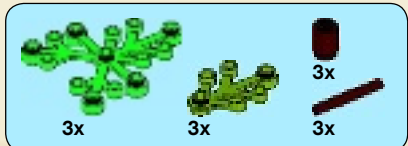

14

1

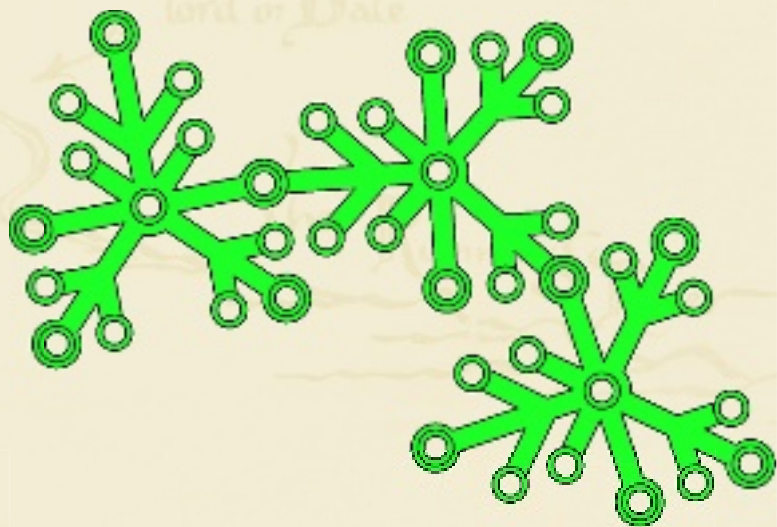
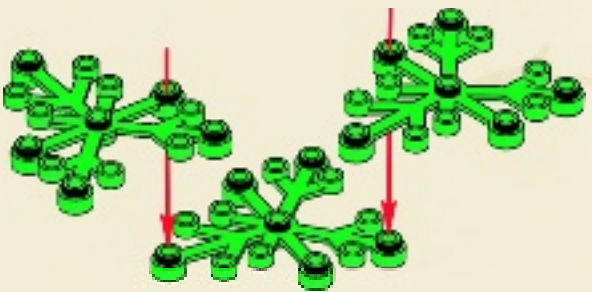

1:1

2

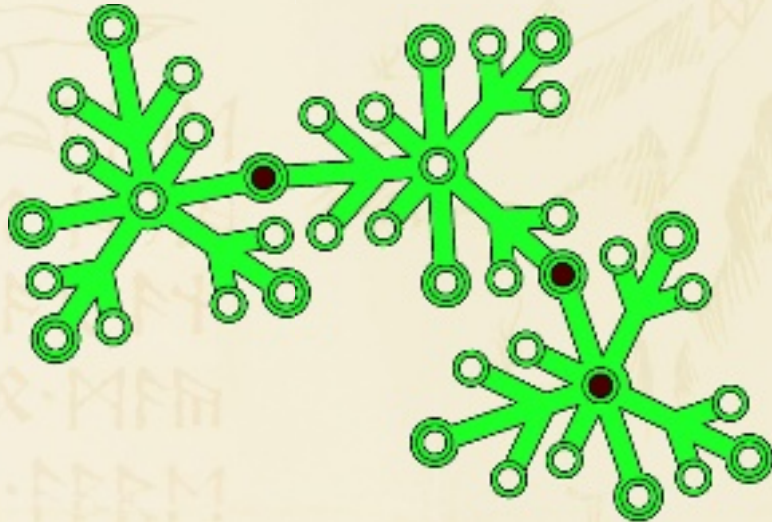

1:1

3



4



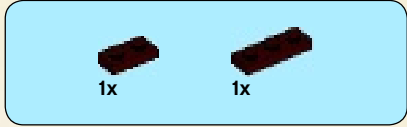

15



16

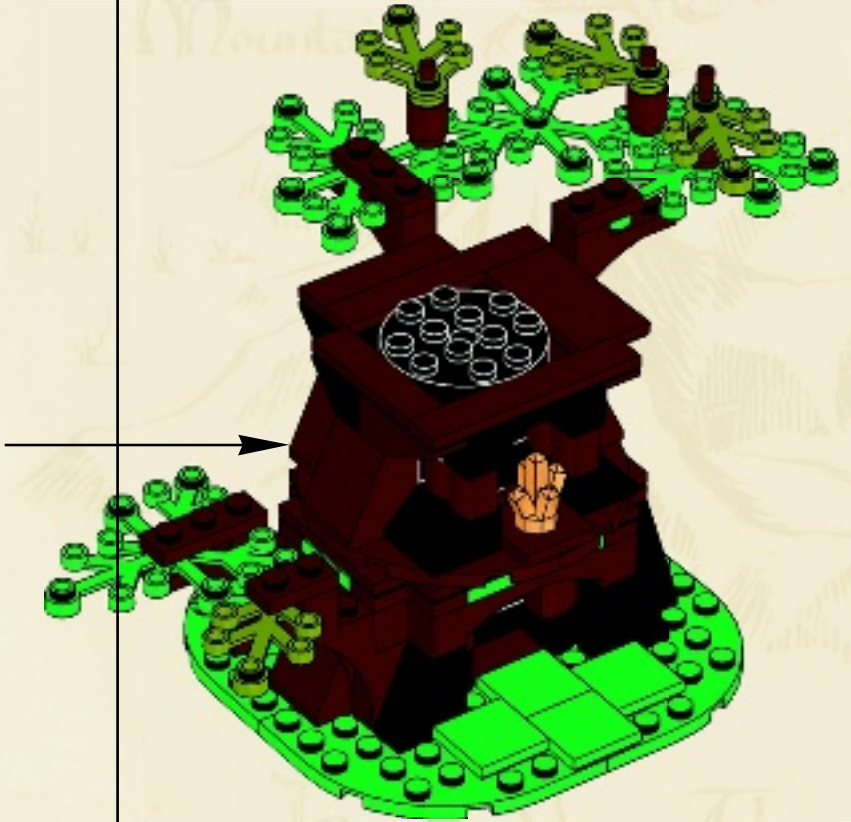



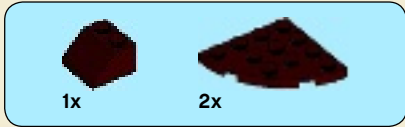
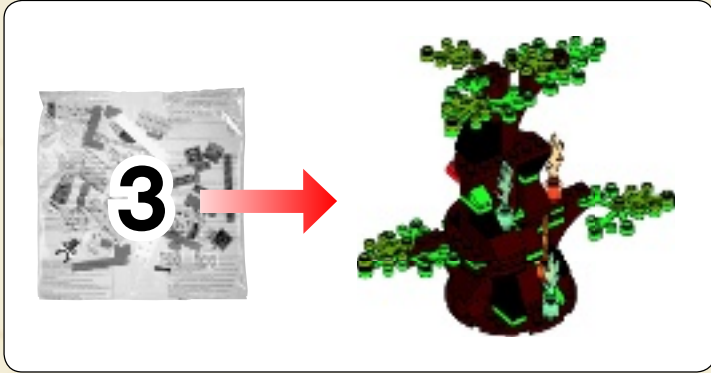

**1**

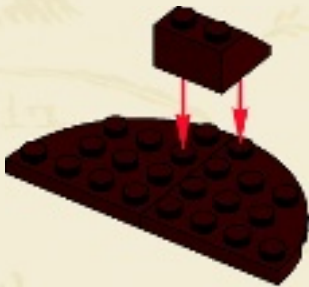

**2**

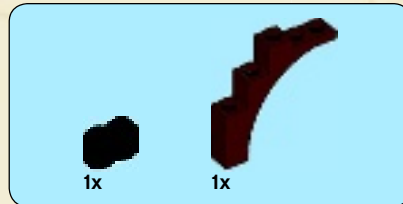
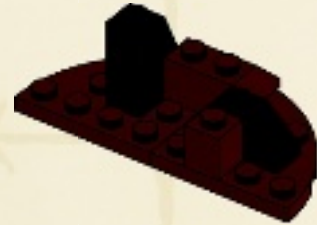

**3**

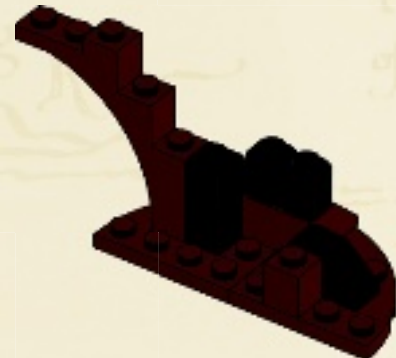



2x

4



3x

5

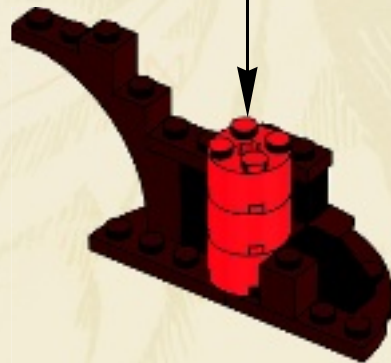



6

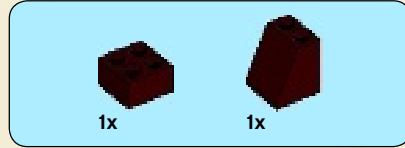

7





8

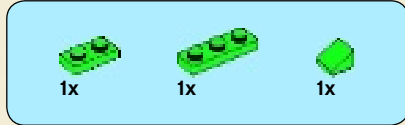
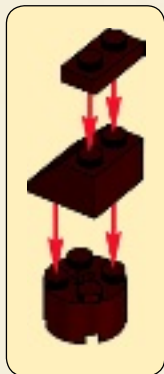

9



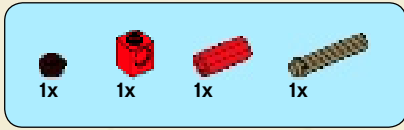

10

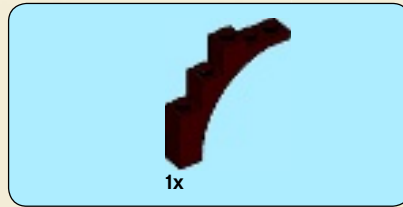
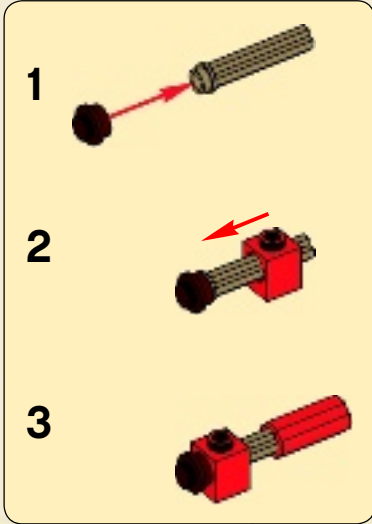

11





12



13





14



15

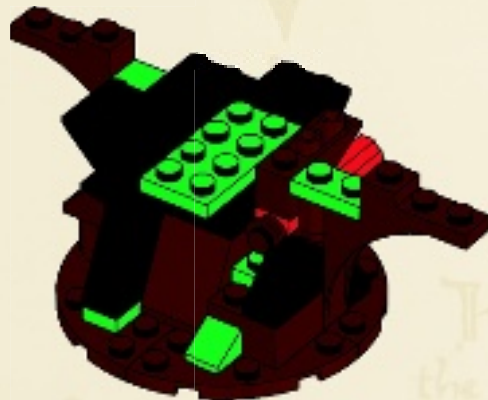



2x

# 16

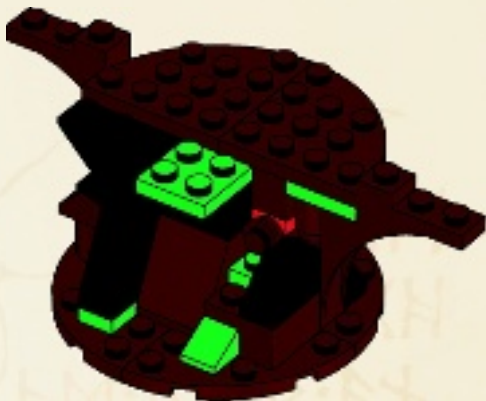

# 17





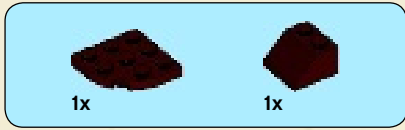

18

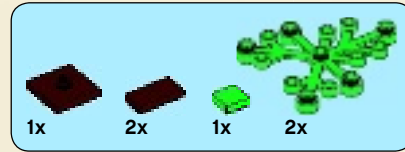
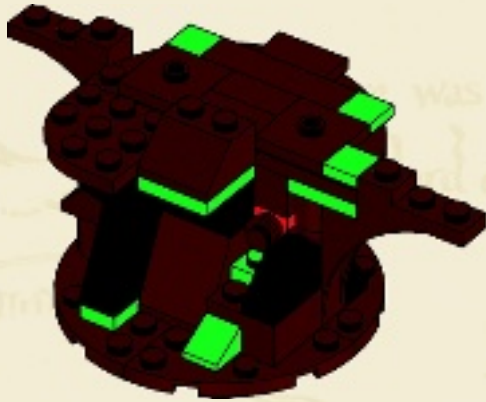

19

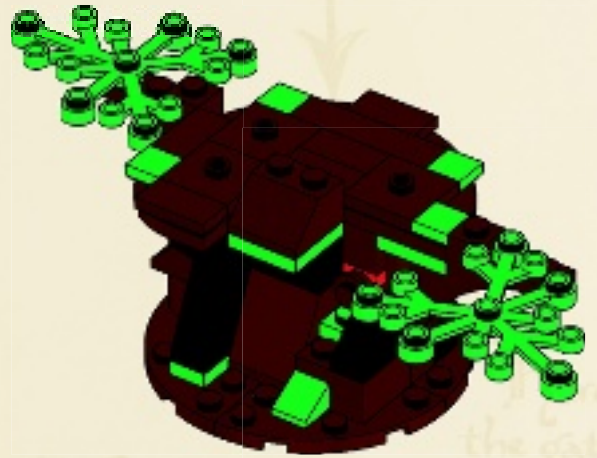

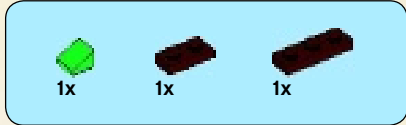

20



21

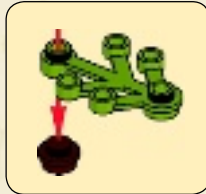

22

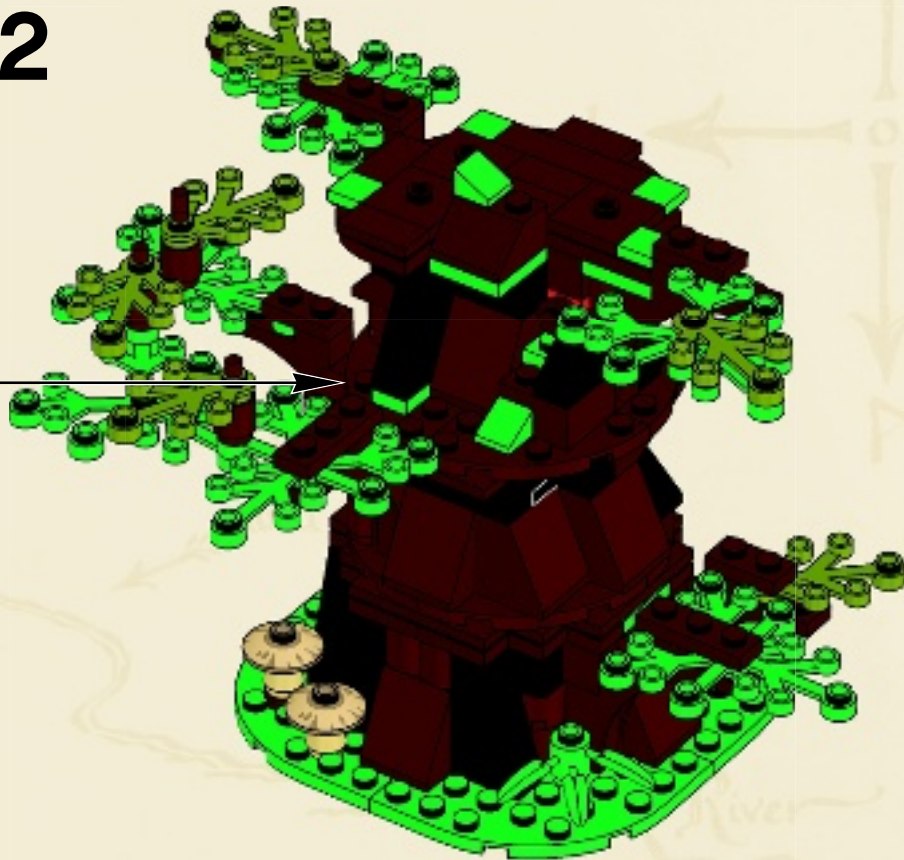



1

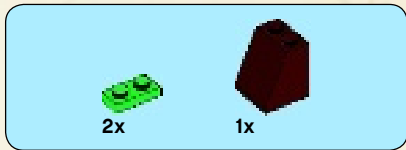
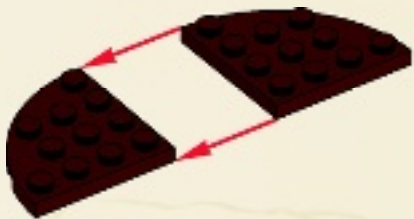

2

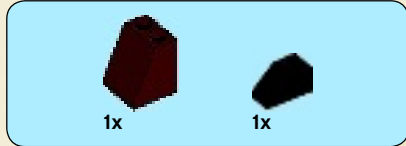

3



4



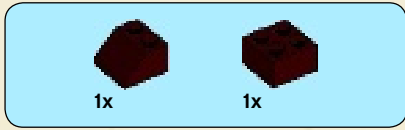

5



6

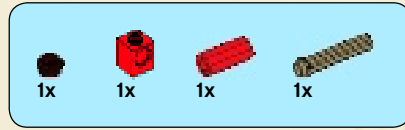

7

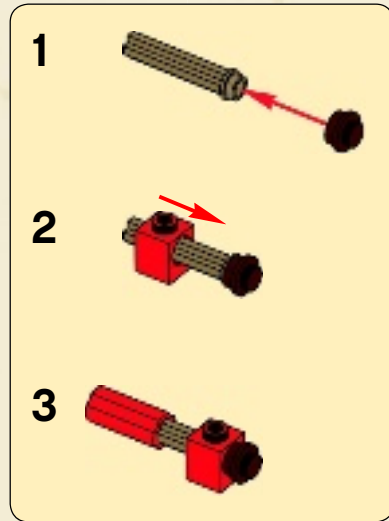



1x



1x

8

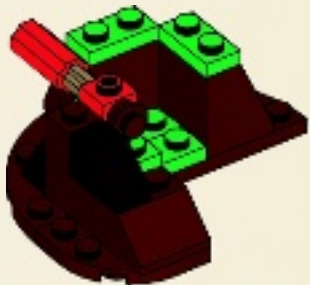

1x



1x



1x



1x

9



1x



1x



3x

10





2x

11

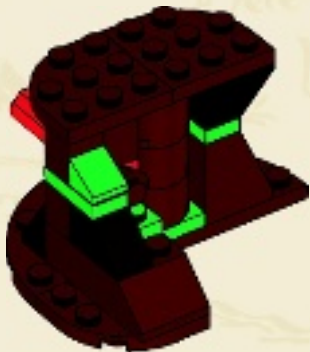

2x

12

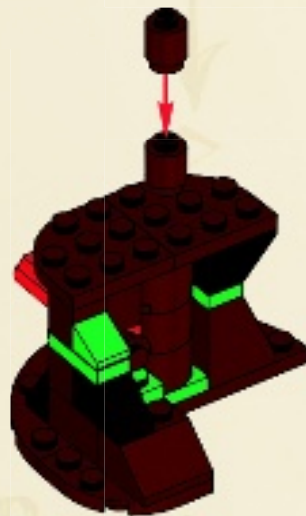

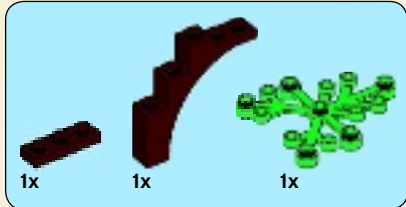

13

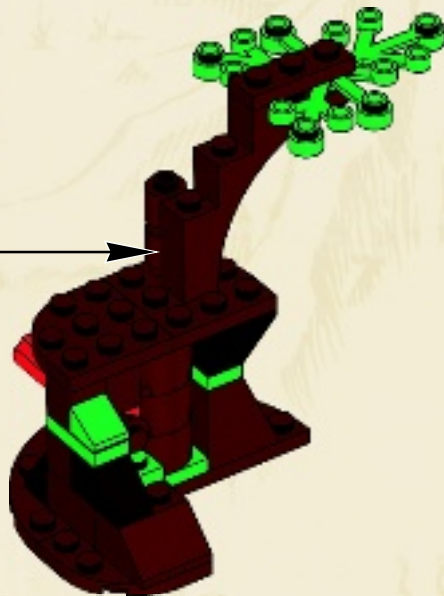
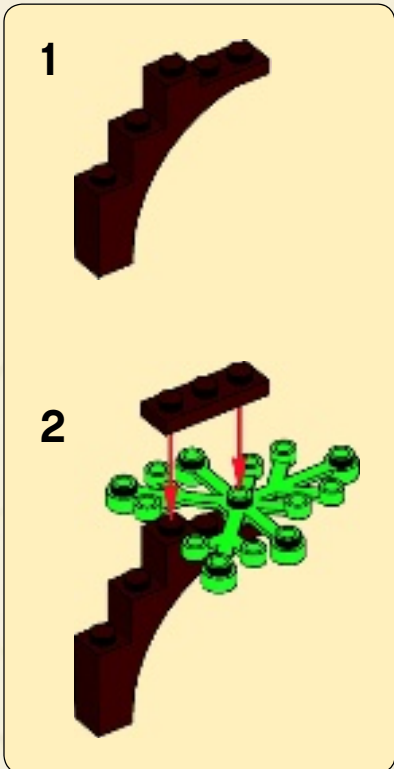





2x

14



2x



1x

15





# 16

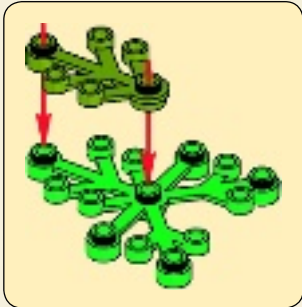

17

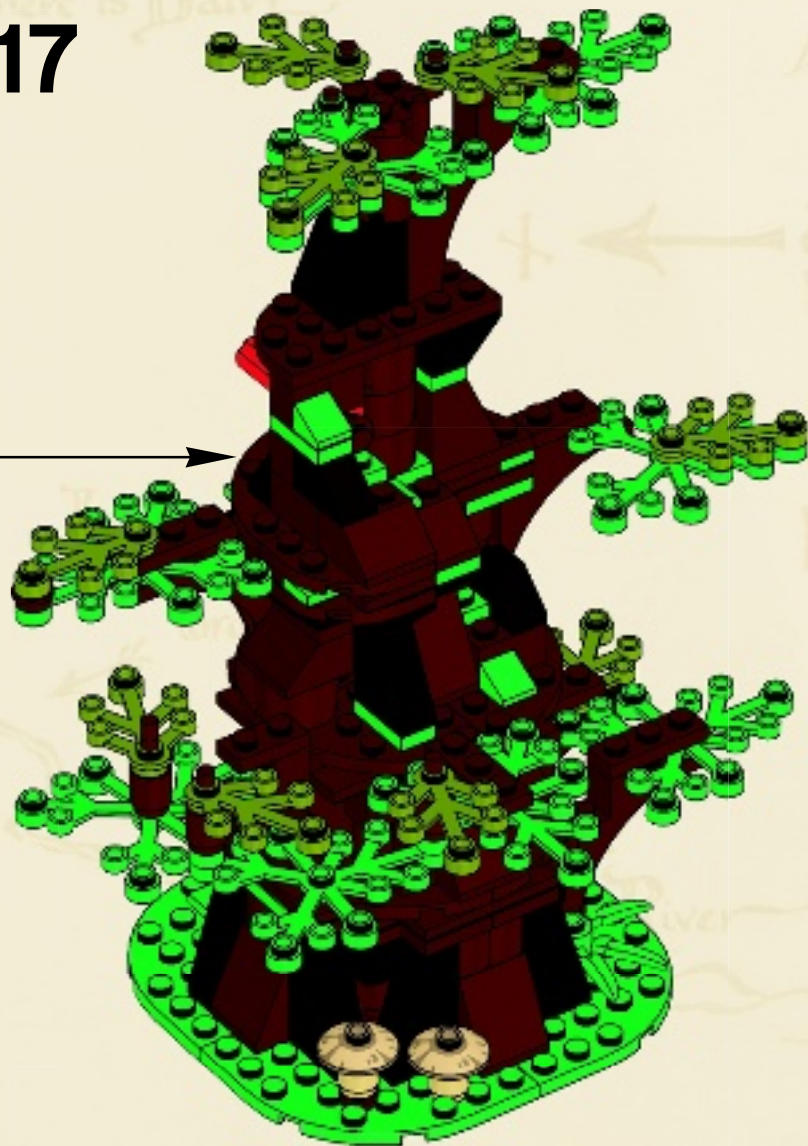



18

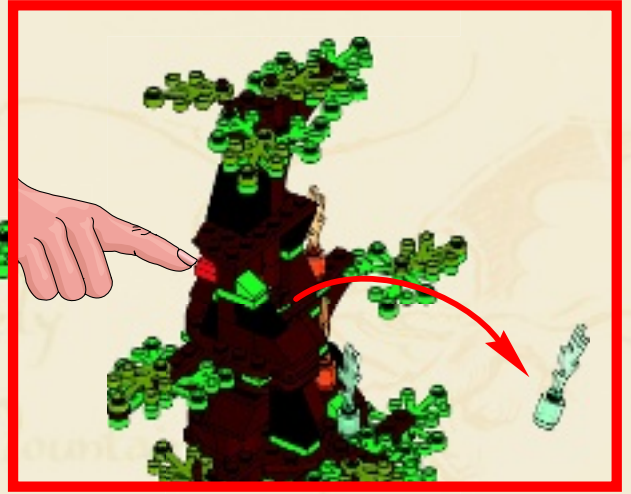
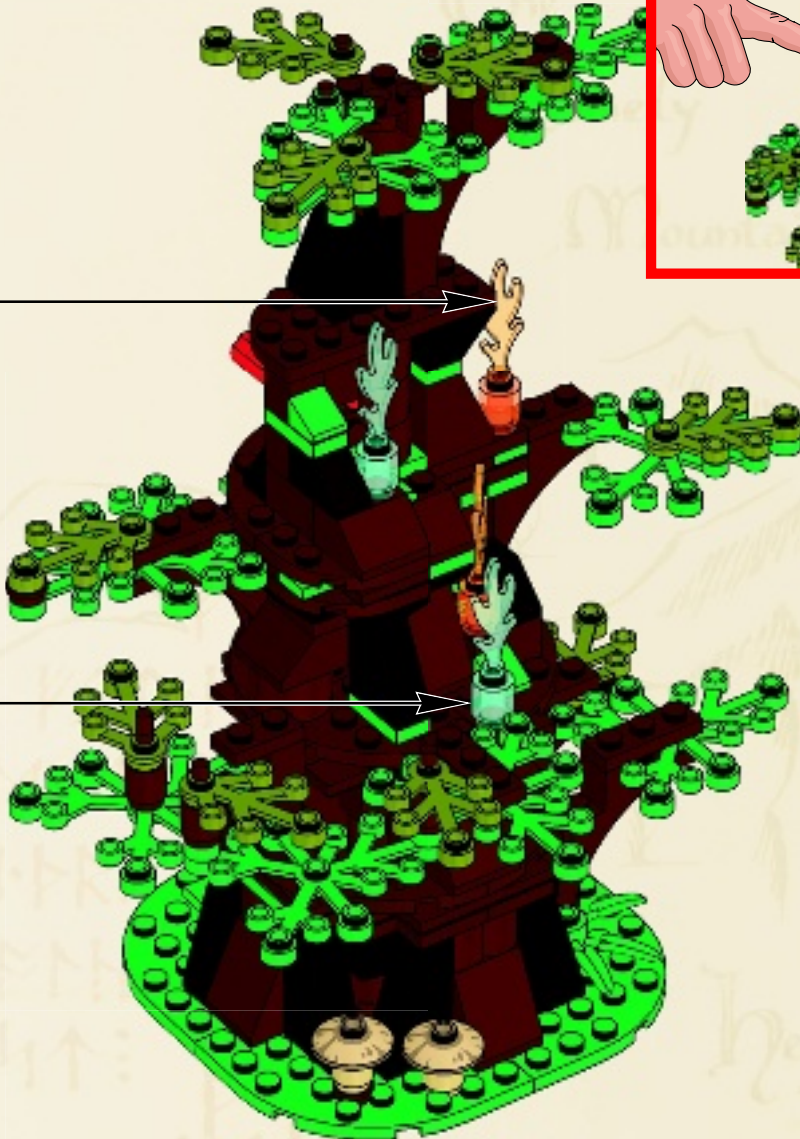
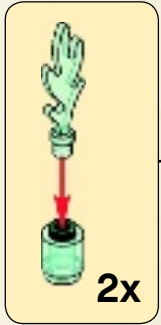
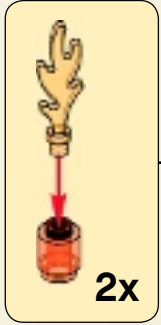

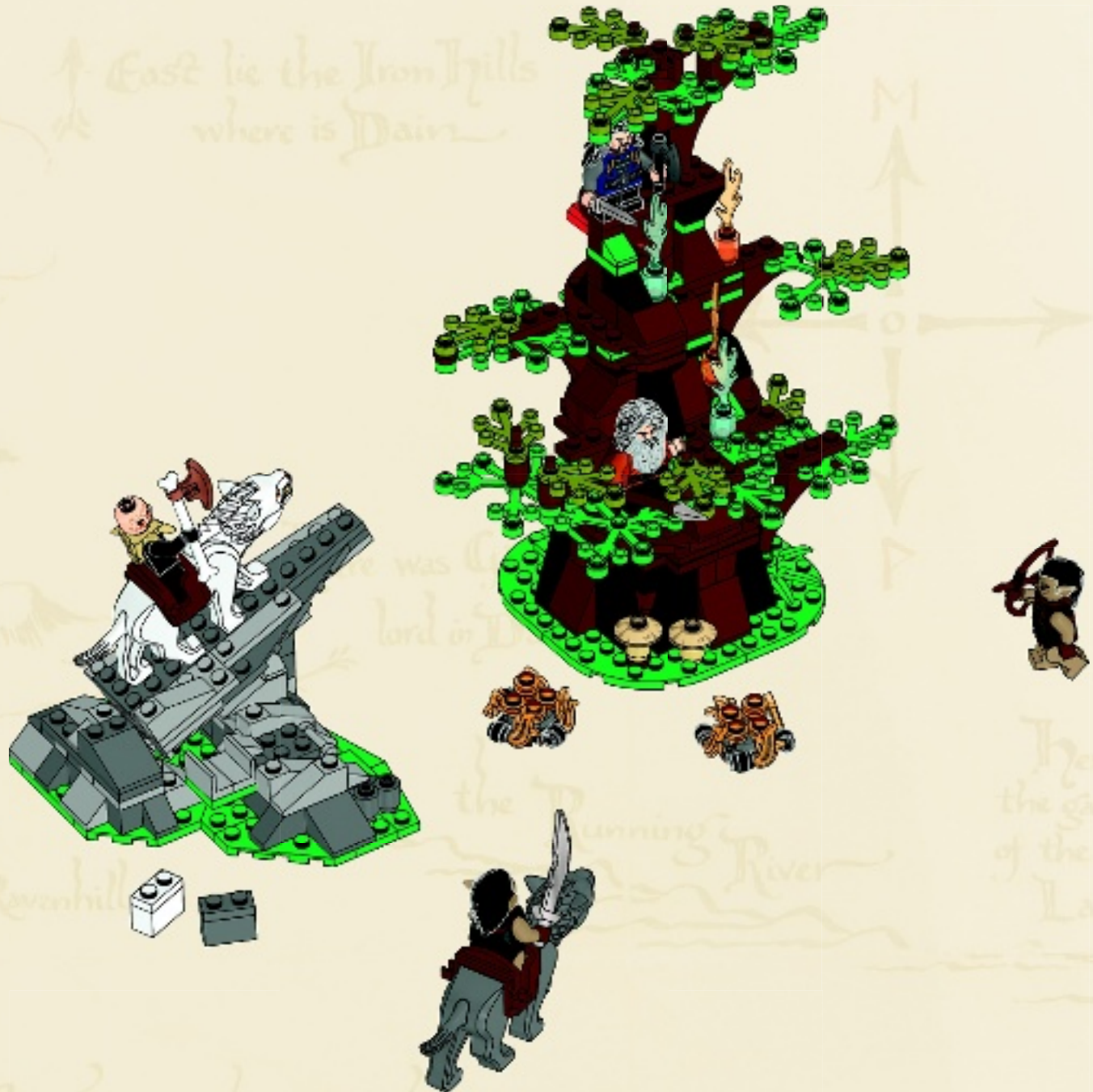



2x  
4558957



8x  
4632571



1x  
4653208



1x  
4596914



1x  
6025264



2x  
6034969



1x  
6023030



1x  
6021616



2x  
4517986



1x  
4109810



2x  
300126



2x  
4181144

70



1x  
4114348



8x  
4613823



11x  
302328



2x  
4107758



3x  
302028



2x  
4543259



3x  
4543262



1x  
241928



2x  
4651215



4x  
6021999



1x  
303428



1x  
4223986



3x  
4546705



5x  
4558593



5x  
4107762



2x  
4535738



2x  
4515369



2x  
4211515



1x  
4211376



1x  
4211387



2x  
4211364



9x  
4521921



1x  
4234535



5x  
4211410



7x  
4211488



1x  
4211732



2x  
4208988



2x  
4211397



1x  
4211353



2x  
4599498



2x  
6015347



1x  
4211395



1x  
4244627



3x  
4633032



1x  
4507139



1x  
4211160



2x  
4550331

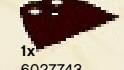

1x  
6027743



1x  
4648118



6x  
4211194

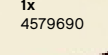

1x  
4579690

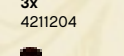

3x  
4211204



4x  
4216581



2x  
4211159

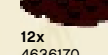

4x  
4283660



12x  
4636170



7x  
6012805

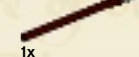

1x  
4655611



1x  
4610100



6x  
4211150



4x  
4565394



6x  
4211257



4x  
4211152



8x  
4211151



3x  
4211242



2x  
4211210



3x  
4211200



6x  
4211180



8x  
4211183



10x  
4211166



4x  
4211202



4x  
4211202



10x  
4211320



4x  
4211195



1x  
6022261



2x  
4183544



2x  
4155537



2x  
4153989



2x  
6022908



2x  
6024433



2x  
6004384



2x  
6031821



1x  
6022247



10x  
4222960



8x  
4649066



2x  
4261397



9x  
6006425



1x  
4529672



2x  
6010063



6x  
4519970



4x  
4654915



8x  
4518557



4x  
4518562



6x  
4624089



6x  
4648296



1x  
4623775



1x  
6005225



1x  
4210719



5x  
4211063



4x  
4211043



1x  
4211002



2x  
4211042



1x  
4586562



2x  
4529727



1x  
4528323



1x  
6024439



1x  
6025342



3x  
4211098



1x  
4211088



1x  
4211105



2x  
4210935



9x  
4211135



4x  
4211106



2x  
4211090



1x  
4567887



1x  
6030710



1x  
6024432



1x  
6025339



1x  
300401



1x  
302301



1x  
4651445



1x  
4600294



1x  
4600307



2x  
4529237



1x  
6028104



1x  
6000291



1x  
4611882



1x  
6025236



1x  
6020749



1x  
6020743



1x  
4516816



1x  
4594655



1x  
4613958



3x  
614321



2x  
654121



2x  
4513174

**Customer Service**

**Kundenservice**

**Service Consommateurs**

**Servicio Al Consumidor**

**LEGO.com/service or dial**



**: 00800 5346 5555**

**: 1-800-422-5346**



□ 79010  
Goblin Soldier  
Soldat gobelin  
Soldado Trasgo

□ 79010  
Goblin Soldier  
Soldat gobelin  
Soldado Trasgo



□ 79010  
Dori the Dwarf  
Le nain Dori  
Dori el Enano

□ 79010  
Nori the Dwarf  
Le nain Nori  
Nori el Enano



□ 79004  
Bilbo Baggins™



□ 79003  
Dwalin the Dwarf  
Le nain Dwalin  
Dwalin el Enano

□ 79002  
Hunter Orc  
Orque chasseur  
Orco Cazador



□ 79010  
The Goblin King  
Le roi des gobelins  
El Rey Trasgo



□ 79004  
Oin the Dwarf  
Le nain Óin  
Oin el Enano



□ 79004  
Mirkwood™ Elf Chief  
Le chef des elfes de Mirkwood™  
Jefe Elfo del Mirkwood™



□ 79003  
Balin the Dwarf  
Le nain Balin  
Balin el Enano



□ 79010  
Gandalf™ the Grey  
Gandalf™ le Gris  
Gandalf™ el Gris



□ 79001  
Kili the Dwarf  
Le nain Kili  
Kili el Enano



□ 79003  
Bilbo Baggins™





□ 79000  
Bilbo Baggins™

□ 79000  
Gollum™



□ 79003  
Bofur the Dwarf  
Le nain Bofur  
Bofur el Enano



□ 79004  
Mirkwood™ Elf Guard  
Garde elfe de Mirkwood™  
Guardia Elfo del Mirkwood™

□ 79004  
Gloin the Dwarf  
Le nain Glóin  
Gloin el Enano



□ 79001  
Legolas Greenleaf™



□ 79001  
Fili the Dwarf  
Le nain Fili  
Fili el Enano



□ 79002  
Thorin Oakenshield™



□ 79002  
Yazneg™



□ 79002  
Warg  
Ouargue  
Wargo

□ 79002  
Warg  
Ouargue  
Wargo



□ 79002  
Bifur the Dwarf  
Le nain Bifur  
Bifur el Enano

□ 79010  
Goblin Scribe  
Scribe goblin  
Escriba Trasgo



□ 79010  
Ori the Dwarf  
Le nain Ori  
Ori el Enano



□ 79003  
Bombur the Dwarf  
Le nain Bombur  
Bombur el Enano



□ 79003  
Gandalf™ the Grey  
Gandalf™ le Gris  
Gandalf™ el Gris



□ 79001  
Tauric™



□ 79002  
Hunter Orc  
Orque chasseur  
Orco Cazador

79010



79004



Special The Hobbit Trilogy  
Preview Set!

Ensemble spécial  
de prévisualisation  
Trilogie Le Hobbit!

Set especial:  
¡Adelántate al estreno  
de la trilogía de El Hobbit!

79003





# THE HOBBIT

AN UNEXPECTED JOURNEY

[LEGO.com/thehobbit](http://LEGO.com/thehobbit)



# THE HOBBIT™

AN UNEXPECTED JOURNEY



3920  
The Hobbit: An  
Unexpected Journey

7+ 2-4 15-25





# THE LORD OF THE RINGS



The Quest of the Fellowship  
Continues in 2013



La quête de la Communauté  
se poursuit en 2013



La Aventura de la Comunidad  
Continúa en 2013

[LEGO.com/thelordoftherings](http://LEGO.com/thelordoftherings)



# WIN!

Go to [www.LEGOsurvey.com/product](http://www.LEGOsurvey.com/product) to fill out a survey for a chance to win a cool LEGO® Product. No purchase necessary. Open to all residents where not prohibited.



## [www.LEGOsurvey.com/product](http://www.LEGOsurvey.com/product)

### GEWINNE! WIN!

Nimm an der Umfrage auf [www.LEGOsurvey.com/product](http://www.LEGOsurvey.com/product) teil und hab die Chance ein cooles LEGO® Produkt zu gewinnen!

Die Teilnahme am Gewinnspiel führt zu keinerlei Kaufverpflichtungen. Teilnahme in allen nicht ausgeschlossenen Ländern möglich.

Ga naar [www.LEGOsurvey.com/product](http://www.LEGOsurvey.com/product), vul een enquêteformulier in en maak kans op een cool LEGO® product.

Geen aankoopverplichting. Iedereen mag deelnemen, uitgezonderd ingezetenden van landen waar een enquêteverbod geldt.

### GAGNE! 当てよう!

Visite [www.LEGOsurvey.com/product](http://www.LEGOsurvey.com/product) pour répondre à un questionnaire et avoir une chance de gagner un produit LEGO® très cool!

Aucune obligation d'achat. Ouvert à tous les résidents des pays autorisés.

[www.LEGOsurvey.com/product](http://www.LEGOsurvey.com/product) にアクセスして、アンケートにご記入ください。当選者にはレゴ®製品を差し上げます。

お買い上げの必要はありません。

禁止されていない限り、すべての皆様にご利用いただけます。



LEGO and the LEGO logo are trademarks of the/son des marques de commerce de/son marcas registradas de LEGO Group. ©2012 The LEGO Group. 6044181

THE HOBBIT: AN UNEXPECTED JOURNEY: © NLP™ Middle-earth Ent. Lic. to New Line. (s12)

LE HOBBIT : UN VOYAGE INATTENDU : © NLP™ Middle-earth Ent. Lic. à New Line. (s12)

EL HOBBIT: UN VIAJE INESPERADO: © NLP™ Middle-earth Ent.; uso autorizado a New Line. (s12)